

3-TERMINAL POSITIVE VOLTAGE REGULATOR

■ GENERAL DESCRIPTION

The NJM7800 series of monolithic 3-Terminal Positive Voltage Regulators is constructed using the New JRC Planar epitaxial process. These regulators employ internal current-limiting, thermal-shutdown and safe-area compensation making them essentially indestructible. If adequate heat sinking is provided, they can deliver over 1A output current. They are intended as fixed voltage regulators in a wide range of applications including local (on card) regulation for elimination of distribution problems associated with single point regulation. In addition to use as fixed voltage regulators, these devices can be used with external components to obtain adjustable output voltages and currents.

■ FEATURES

- Operating Voltage
- Internal Short Circuit Current Limit
- Internal Thermal Overload Protection
- Excellent Ripple Rejection
- Guarantee'd 1.5A Output Current
- Package Outline TO-220F, TO-252
- Bipolar Technology

■ EQUIVALENT CIRCUIT

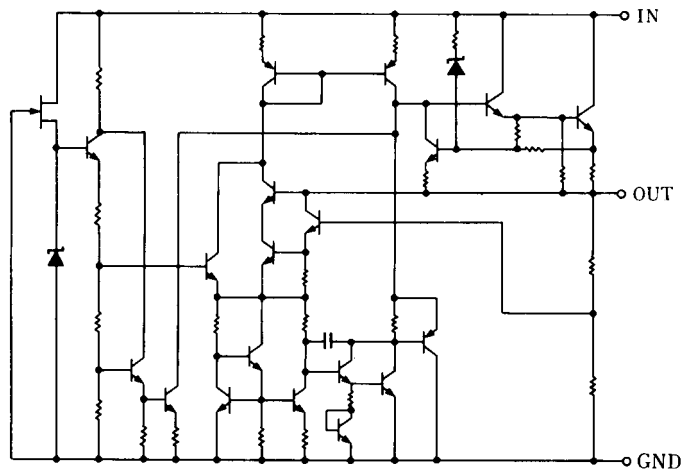

■ PACKAGE OUTLINE

(TO-220F)

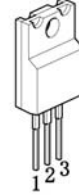

(TO-252)

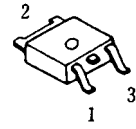

NJM7800FA

1. IN
2. GND
3. OUT

NJM7800DL1A

1. IN
2. GND
3. OUT

(note) The radiation fin is connected pin2.

NJM7800

■ ABSOLUTE MAXIMUM RATINGS

(Ta=25°C)

PARAMETER	SYMBOL	MAXIMUM RATINGS		UNIT
Input Voltage	V _{IN}	7805 to 7809 7812 to 7815 7818 to 7824	35 35 40	V
Storage Temperature Range	T _{stg}	-40 to +150		°C
Operating Temperature Range	Operating Junction Temperature	T _j	-40 to +150	°C
		T _{opr}	-40 to +85	
Power Dissipation	P _D	TO-220F TO-252	16(T _C ≤70°C) 10(T _C =25°C) 1(Ta≤25°C)	W

■ THERMAL CHARACTERISTICS

			TO220F	TO252		
Thermal Resistance	Junction-to-Ambient Temperature	θ _{ja}	60	125	°C/W	
	Junction-to-Case	θ _{jc}	5	12.5		

■ ELECTRICAL CHARACTERISTICS (C₁=0.33μF, C_O=0.1μF, T_J=25°C)

Measurement is to be conducted in pulse testing.

PARAMETER	SYMBOL	TEST CONDITIONS	FTYP.			DL TYP.			UNIT
			MIN.	TYP.	MAX.	MIN.	TYP.	MAX.	
NJM7805FA/DL1A									
Output Voltage	V _O	V _{IN} =10V, I _O =0.5A	4.8	5.0	5.2	4.8	5.0	5.2	V
Quiescent Current	I _Q	V _{IN} =10V, I _O =0mA	-	4.2	6.0	-	4.2	6.0	mA
Load Regulation	ΔV _O - I _O	V _{IN} =10V, I _O =0.005 to 1.5A	-	15	50	-	15	100	mV
Line Regulation	ΔV _O - V _{IN}	V _{IN} =7 to 25V, I _O =0.5A	-	3	50	-	3	100	mV
Ripple Rejection	RR	V _{IN} =10V, I _O =0.5A, e _{in} =2V _{P-P} , f=120Hz	68	78	-	68	78	-	dB
Output Noise Voltage	V _{NO}	V _{IN} =10V, BW=10Hz to 100kHz, I _O =0.5A	-	45	-	-	45	-	μV
Average Temperature Coefficient of Output Voltage	ΔV _O /ΔT	V _{IN} =10V, I _O =5mA	-	-0.5	-	-	-0.5	-	mV/°C

■ ELECTRICAL CHARACTERISTICS (C₁=0.33μF, C_O=0.1μF, T_J=25°C)

Measurement is to be conducted in pulse testing.

PARAMETER	SYMBOL	TEST CONDITIONS	FTYP.			DL TYP.			UNIT
			MIN.	TYP.	MAX.	MIN.	TYP.	MAX.	
NJM7806FA/DL1									
Output Voltage	V _O	V _{IN} =11V, I _O =0.5A	5.75	6.0	6.25	5.75	6.0	6.25	V
Quiescent Current	I _Q	V _{IN} =11V, I _O =0mA	-	4.3	6.0	-	4.3	6.0	mA
Load Regulation	ΔV _O - I _O	V _{IN} =11V, I _O =0.005 to 1.5A	-	15	60	-	15	120	mV
Line Regulation	ΔV _O - V _{IN}	V _{IN} =8 to 25V, I _O =0.5A	-	5	60	-	5	120	mV
Ripple Rejection	RR	V _{IN} =11V, I _O =0.5A, e _{in} =2V _{P-P} , f=120Hz	65	75	-	65	75	-	dB
Output Noise Voltage	V _{NO}	V _{IN} =11V, BW=10Hz to 100kHz, I _O =0.5A	-	45	-	-	45	-	μV
Average Temperature Coefficient of Output Voltage	ΔV _O /ΔT	V _{IN} =11V, I _O =5mA	-	-0.6	-	-	-0.6	-	mV/°C
NJM7808FA/DL1									
Output Voltage	V _O	V _{IN} =14V, I _O =0.5A	7.7	8.0	8.3	7.7	8.0	8.3	V
Quiescent Current	I _Q	V _{IN} =14V, I _O =0mA	-	4.3	6.0	-	4.3	6.0	mA
Load Regulation	ΔV _O - I _O	V _{IN} =14V, I _O =0.005 to 1.5A	-	15	80	-	15	160	mV
Line Regulation	ΔV _O - V _{IN}	V _{IN} =10.5 to 25V, I _O =0.5A	-	6	80	-	6	160	mV
Ripple Rejection	RR	V _{IN} =14V, I _O =0.5A, e _{in} =2V _{P-P} , f=120Hz	62	72	-	62	72	-	dB
Output Noise Voltage	V _{NO}	V _{IN} =14V, BW=10Hz to 100kHz, I _O =0.5A	-	55	-	-	55	-	μV
Average Temperature Coefficient of Output Voltage	ΔV _O /ΔT	V _{IN} =14V, I _O =5mA	-	-0.8	-	-	-0.8	-	mV/°C
NJM7809FA/DL1									
Output Voltage	V _O	V _{IN} =15V, I _O =0.5A	8.65	9.0	9.35	8.65	9.0	9.35	V
Quiescent Current	I _Q	V _{IN} =15V, I _O =0mA	-	4.3	6.0	-	4.3	6.0	mA
Load Regulation	ΔV _O - I _O	V _{IN} =15V, I _O =0.005 to 1.5A	-	15	90	-	15	180	mV
Line Regulation	ΔV _O - V _{IN}	V _{IN} =11.5 to 25V, I _O =0.5A	-	7	90	-	7	180	mV
Ripple Rejection	RR	V _{IN} =15V, I _O =0.5A, e _{in} =2V _{P-P} , f=120Hz	62	72	-	62	72	-	dB
Output Noise Voltage	V _{NO}	V _{IN} =15V, BW=10Hz to 100kHz, I _O =0.5A	-	60	-	-	60	-	μV
Average Temperature Coefficient of Output Voltage	ΔV _O /ΔT	V _{IN} =15V, I _O =5mA	-	-0.9	-	-	-0.9	-	mV/°C
NJM7812FA/DL1									
Output Voltage	V _O	V _{IN} =19V, I _O =0.5A	11.5	12.0	12.5	11.5	12.0	12.5	V
Quiescent Current	I _Q	V _{IN} =19V, I _O =0mA	-	4.3	6.0	-	4.3	6.0	mA
Load Regulation	ΔV _O - I _O	V _{IN} =19V, I _O =0.005 to 1.5A	-	25	120	-	25	240	mV
Line Regulation	ΔV _O - V _{IN}	V _{IN} =14.5 to 30V, I _O =0.5A	-	10	120	-	10	240	mV
Ripple Rejection	RR	V _{IN} =19V, I _O =0.5A, e _{in} =2V _{P-P} , f=120Hz	61	71	-	61	71	-	dB
Output Noise Voltage	V _{NO}	V _{IN} =19V, BW=10Hz to 100kHz, I _O =0.5A	-	75	-	-	75	-	μV
Average Temperature Coefficient of Output Voltage	ΔV _O /ΔT	V _{IN} =19V, I _O =5mA	-	-1.2	-	-	-1.2	-	mV/°C

NJM7800

■ ELECTRICAL CHARACTERISTICS (C₁=0.33μF, C_O=0.1μF, T_J=25°C)

Measurement is to be conducted in pulse testing.

PARAMETER	SYMBOL	TEST CONDITIONS	FTYP.			DL TYP.			UNIT
			MIN.	TYP.	MAX.	MIN.	TYP.	MAX.	
NJM7815FA/DL1									
Output Voltage	V _O	V _{IN} =23V, I _O =0.5A	14.4	15.0	15.6	14.4	15.0	15.6	V
Quiescent Current	I _Q	V _{IN} =23V, I _O =0mA	-	4.4	6.0	-	4.4	6.0	mA
Load Regulation	ΔV _O - I _O	V _{IN} =23V, I _O =0.005 to 1.5A	-	35	150	-	35	300	mV
Line Regulation	ΔV _O - V _{IN}	V _{IN} =17.5 to 30V, I _O =0.5A	-	11	150	-	11	300	mV
Ripple Rejection	RR	V _{IN} =23V, I _O =0.5A, e _{in} =2V _{P-P} , f=120Hz	60	70	-	60	70	-	dB
Output Noise Voltage	V _{NO}	V _{IN} =23V, BW=10Hz to 100kHz, I _O =0.5A	-	90	-	-	90	-	μV
Average Temperature Coefficient of Output Voltage	ΔV _O /ΔT	V _{IN} =23V, I _O =5mA	-	-1.5	-	-	-1.5	-	mV/°C
NJM7818FA/DL1									
Output Voltage	V _O	V _{IN} =27V, I _O =0.5A	17.3	18.0	18.7	17.3	18.0	18.7	V
Quiescent Current	I _Q	V _{IN} =27V, I _O =0mA	-	4.5	6.0	-	4.5	6.0	mA
Load Regulation	ΔV _O - I _O	V _{IN} =27V, I _O =0.005 to 1.5A	-	55	180	-	55	360	mV
Line Regulation	ΔV _O - V _{IN}	V _{IN} =21 to 33V, I _O =0.5A	-	15	180	-	15	360	mV
Ripple Rejection	RR	V _{IN} =27V, I _O =0.5A, e _{in} =2V _{P-P} , f=120Hz	59	69	-	59	69	-	dB
Output Noise Voltage	V _{NO}	V _{IN} =27V, BW=10Hz to 100kHz, I _O =0.5A	-	100	-	-	100	-	μV
Average Temperature Coefficient of Output Voltage	ΔV _O /ΔT	V _{IN} =27V, I _O =5mA	-	-1.8	-	-	-1.8	-	mV/°C
NJM7820FA/DL1									
Output Voltage	V _O	V _{IN} =29V, I _O =0.5A	19.2	20.0	20.8	19.2	20.0	20.8	V
Quiescent Current	I _Q	V _{IN} =29V, I _O =0mA	-	4.5	6.0	-	4.5	6.0	mA
Load Regulation	ΔV _O - I _O	V _{IN} =29V, I _O =0.005 to 1.5A	-	61	200	-	61	400	mV
Line Regulation	ΔV _O - V _{IN}	V _{IN} =23 to 35V, I _O =0.5A	-	16	200	-	16	400	mV
Ripple Rejection	RR	V _{IN} =29V, I _O =0.5A, e _{in} =2V _{P-P} , f=120Hz	58	68	-	58	68	-	dB
Output Noise Voltage	V _{NO}	V _{IN} =29V, BW=10Hz to 100kHz, I _O =0.5A	-	120	-	-	120	-	μV
Average Temperature Coefficient of Output Voltage	ΔV _O /ΔT	V _{IN} =29V, I _O =5mA	-	-2.0	-	-	-2.0	-	mV/°C
NJM7824FA/DL1									
Output Voltage	V _O	V _{IN} =33V, I _O =0.5A	23.0	24.0	25.0	23.0	24.0	25.0	V
Quiescent Current	I _Q	V _{IN} =33V, I _O =0mA	-	4.6	6.0	-	4.6	6.0	mA
Load Regulation	ΔV _O - I _O	V _{IN} =33V, I _O =0.005 to 1.5A	-	65	240	-	65	480	mV
Line Regulation	ΔV _O - V _{IN}	V _{IN} =27 to 38V, I _O =0.5A	-	18	240	-	18	480	mV
Ripple Rejection	RR	V _{IN} =33V, I _O =0.5A, e _{in} =2V _{P-P} , f=120Hz	56	66	-	56	66	-	dB
Output Noise Voltage	V _{NO}	V _{IN} =33V, BW=10Hz to 100kHz, I _O =0.5A	-	120	-	-	120	-	μV
Average Temperature Coefficient of Output Voltage	ΔV _O /ΔT	V _{IN} =33V, I _O =5mA	-	-2.4	-	-	-2.4	-	mV/°C

POWER DISSIPATION VS. AMBIENT TEMPERATURE

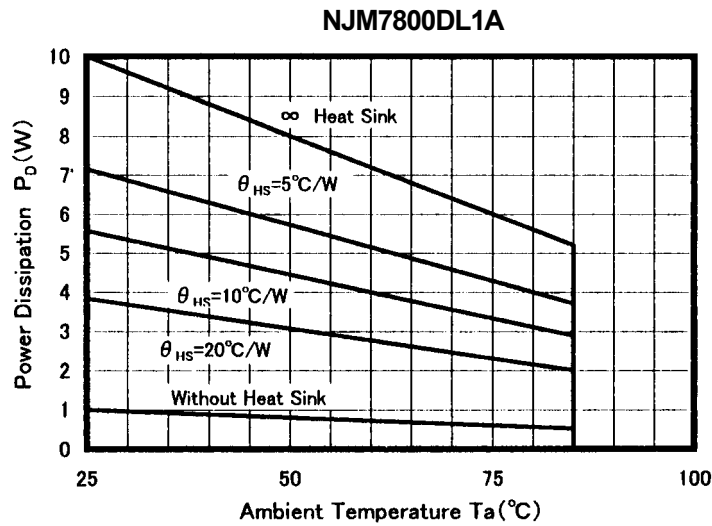
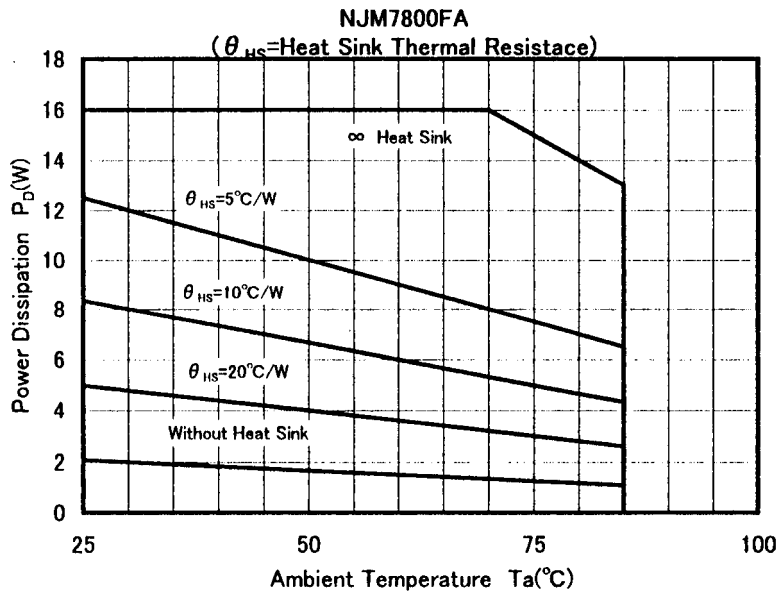

TEST CIRCUIT

- Output Voltage, Line Regulation, Load Regulation, Quiescent Current, Average Temperature Coefficient of Output Voltage, Output Noise Voltage
- Ripple Rejection

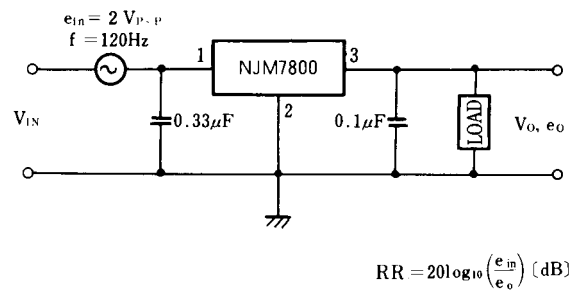
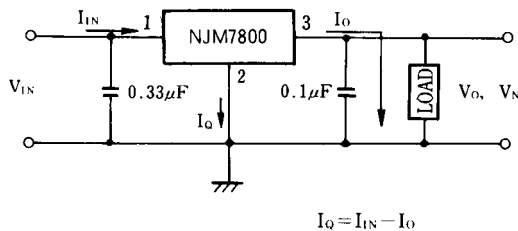

NJM7800

■ TYPICAL CHARACTERISTICS

NJM7805/15/24 Output Characteristics
($I_o=0.5A$, $T_j=25^\circ C$)

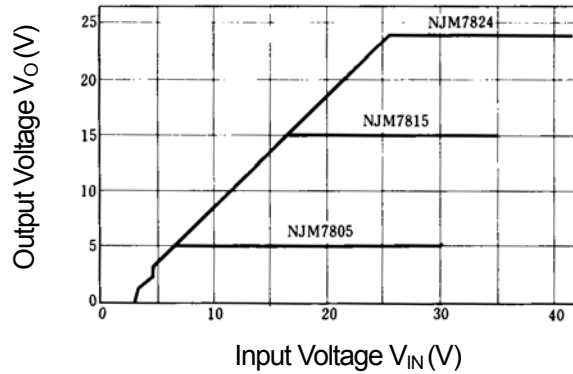

NJM7805 Dropout Characteristics
($T_j=25^\circ C$)

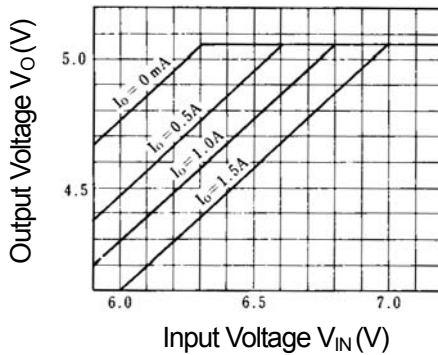

NJM7812 Dropout Characteristics
($T_j=25^\circ C$)

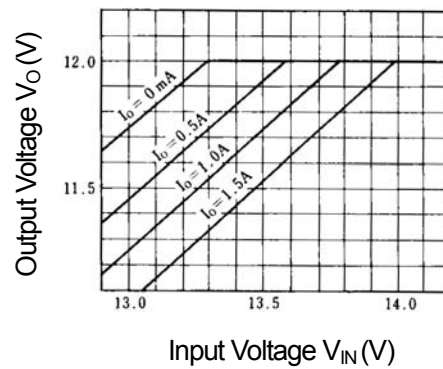

NJM7805/15/24 Load Characteristics
($T_j=25^\circ C$)

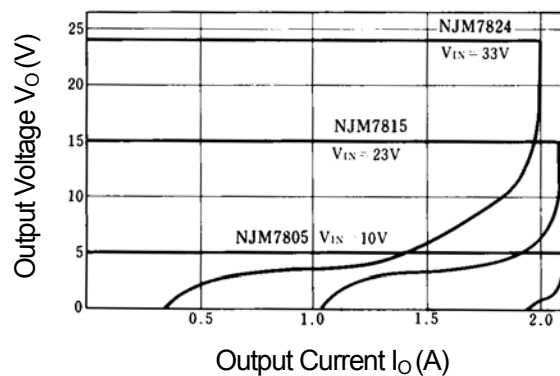

■ TYPICAL CHARACTERISTICS

NJM7800 Series Short Circuit Output Current

($T_j=25^\circ\text{C}$, ∞ Heat Sink)

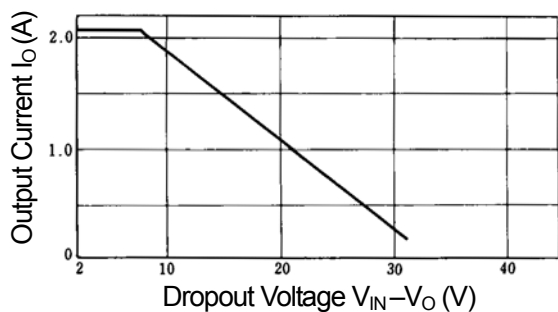

NJM7805/24 Quiescent Current vs. Input Voltage

($T_j=25^\circ\text{C}$.)

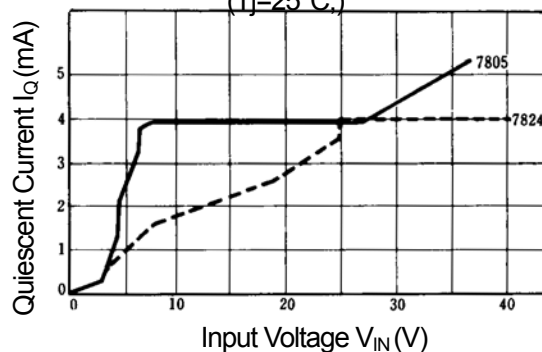

NJM7805/15/24 Output Voltage vs. Junction Temperature

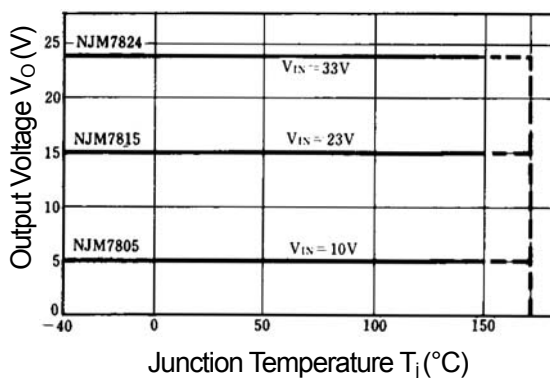

NJM7805/15/24 Ripple Rejection vs. Frequency

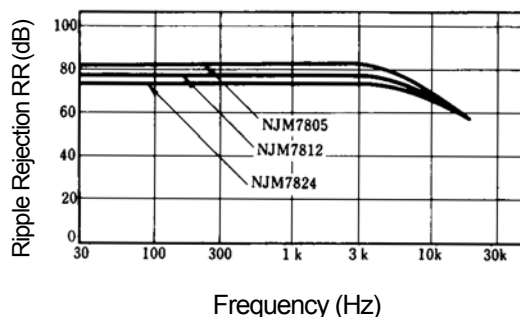

$V_{IN} = 10\text{V (05)}$ $e_{in} = 2V_{P-P}$
 19V (12)
 33V (24)
 $T_j = 25^\circ\text{C}$

■ TYPICAL CHARACTERISTICS

NJM7805 Output Voltage vs. Temperature

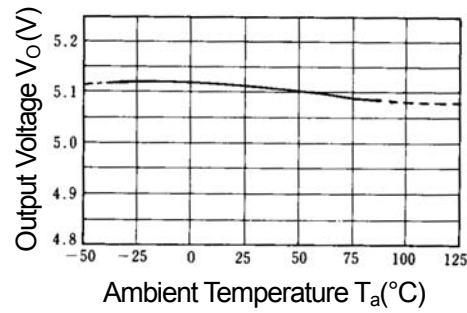

NJM7808 Output Voltage vs. Temperature

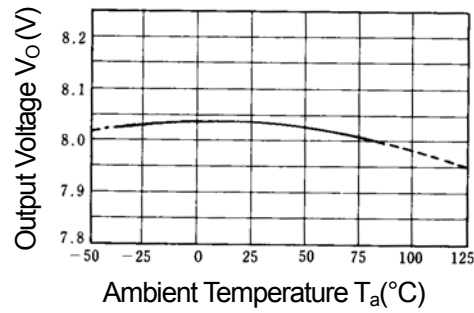

[CAUTION]

The specifications on this databook are only given for information, without any guarantee as regards either mistakes or omissions. The application circuits in this databook are described only to show representative usages of the product and not intended for the guarantee or permission of any right including the industrial rights.



Стандарт Электрон Связь

Мы молодая и активно развивающаяся компания в области поставок электронных компонентов. Мы поставляем электронные компоненты отечественного и импортного производства напрямую от производителей и с крупнейших складов мира.

Благодаря сотрудничеству с мировыми поставщиками мы осуществляем комплексные и плановые поставки широчайшего спектра электронных компонентов.

Собственная эффективная логистика и склад в обеспечивает надежную поставку продукции в точно указанные сроки по всей России.

Мы осуществляем техническую поддержку нашим клиентам и предпродажную проверку качества продукции. На все поставляемые продукты мы предоставляем гарантию .

Осуществляем поставки продукции под контролем ВП МО РФ на предприятия военно-промышленного комплекса России , а также работаем в рамках 275 ФЗ с открытием отдельных счетов в уполномоченном банке. Система менеджмента качества компании соответствует требованиям ГОСТ ISO 9001.

Минимальные сроки поставки, гибкие цены, неограниченный ассортимент и индивидуальный подход к клиентам являются основой для выстраивания долгосрочного и эффективного сотрудничества с предприятиями радиоэлектронной промышленности, предприятиями ВПК и научно-исследовательскими институтами России.

С нами вы становитесь еще успешнее!

Наши контакты:

Телефон: +7 812 627 14 35

Электронная почта: sales@st-electron.ru

Адрес: 198099, Санкт-Петербург,
Промышленная ул, дом № 19, литера Н,
помещение 100-Н Офис 331