



PMEG10020AELR

100 V, 2 A low leakage current Schottky barrier rectifier

7 May 2015

Product data sheet

1. General description

Planar Maximum Efficiency General Application (MEGA) Schottky barrier rectifier with an integrated guard ring for stress protection, encapsulated in a SOD123W small and flat lead Surface-Mounted Device (SMD) plastic package.

2. Features and benefits

- Average forward current: $I_{F(AV)} \leq 2$ A
- Reverse voltage: $V_R \leq 100$ V
- Low forward voltage: $V_F = 710$ mV
- High power capability due to clip-bonding technology
- Extremely low leakage current
- High temperature $T_j \leq 175$ °C
- Small and flat lead SMD plastic package
- AEC-Q101 qualified

3. Applications

- Low voltage rectification
- High efficiency DC-to-DC conversion
- Switch mode power supply
- Reverse polarity protection
- Low power consumption applications

4. Quick reference data



Table 1. Quick reference data

Symbol	Parameter	Conditions	Min	Typ	Max	Unit
$I_{F(AV)}$	average forward current	$\delta = 0.5$; $f = 20$ kHz; $T_{sp} \leq 160$ °C; square wave	-	-	2	A
V_R	reverse voltage	$T_j = 25$ °C	-	-	100	V
V_F	forward voltage	$I_F = 2$ A; $t_p \leq 300$ μ s; $\delta \leq 0.02$; $T_j = 25$ °C	-	710	770	mV
I_R	reverse current	$V_R = 100$ V; $t_p \leq 300$ μ s; $\delta \leq 0.02$; $T_j = 25$ °C	-	70	300	nA



5. Pinning information

Table 2. Pinning information

Pin	Symbol	Description	Simplified outline	Graphic symbol
1	K	cathode[1]	 <p>SOD123W</p>	
2	A	anode		<p><i>sym001</i></p>

[1] The marking bar indicates the cathode.

6. Ordering information

Table 3. Ordering information

Type number	Package		
	Name	Description	Version
PMEG10020AELR	SOD123W	plastic surface mounted package; 2 leads	SOD123W

7. Marking

Table 4. Marking codes

Type number	Marking code
PMEG10020AELR	K9

8. Limiting values

Table 5. Limiting values

In accordance with the Absolute Maximum Rating System (IEC 60134).

Symbol	Parameter	Conditions		Min	Max	Unit
V_R	reverse voltage	$T_j = 25\text{ °C}$		-	100	V
I_F	forward current	$T_{sp} = 155\text{ °C}; \delta = 1$		-	2.83	A
$I_{F(AV)}$	average forward current	$\delta = 0.5; f = 20\text{ kHz}; T_{amb} \leq 90\text{ °C};$ square wave	[1]	-	2	A
		$\delta = 0.5; f = 20\text{ kHz}; T_{sp} \leq 160\text{ °C};$ square wave		-	2	A
I_{FRM}	repetitive peak forward current	$t_p \leq 1\text{ ms}; \delta \leq 0.25$		-	30	A
I_{FSM}	non-repetitive peak forward current	$t_p = 8\text{ ms}; T_{j(init)} = 25\text{ °C};$ square wave		-	50	A
P_{tot}	total power dissipation	$T_{amb} \leq 25\text{ °C}$	[2]	-	680	mW
			[3]	-	1150	mW
			[1]	-	2140	mW
T_j	junction temperature			-	175	°C
T_{amb}	ambient temperature			-55	175	°C
T_{stg}	storage temperature			-65	175	°C

[1] Device mounted on a ceramic Printed-Circuit Board (PCB), Al_2O_3 , standard footprint.

[2] Device mounted on an FR4 PCB, single-sided copper, tin-plated and standard footprint.

[3] Device mounted on an FR4 PCB, single-sided copper, tin-plated, mounting pad for cathode 1 cm^2 .

9. Thermal characteristics

Table 6. Thermal characteristics

Symbol	Parameter	Conditions		Min	Typ	Max	Unit
$R_{th(j-a)}$	thermal resistance from junction to ambient	in free air	[1][2]	-	-	220	K/W
			[1][3]	-	-	130	K/W
			[1][4]	-	-	70	K/W
$R_{th(j-sp)}$	thermal resistance from junction to solder point		[5]	-	-	18	K/W

[1] For Schottky barrier diodes thermal runaway has to be considered, as in some applications the reverse power losses P_R are a significant part of the total power losses.

[2] Device mounted on an FR4 PCB, single-sided copper, tin-plated and standard footprint.

[3] Device mounted on an FR4 PCB, single-sided copper, tin-plated, mounting pad for cathode 1 cm^2 .

[4] Device mounted on a ceramic PCB, Al_2O_3 , standard footprint.

[5] Soldering point of cathode tab.

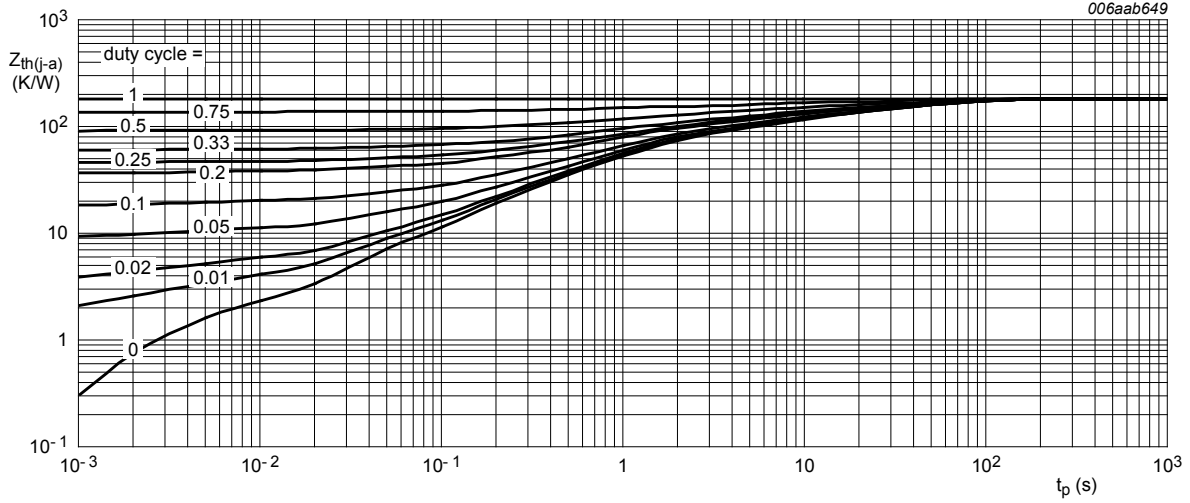

FR4 PCB, standard footprint

Fig. 1. Transient thermal impedance from junction to ambient as a function of pulse duration; typical values

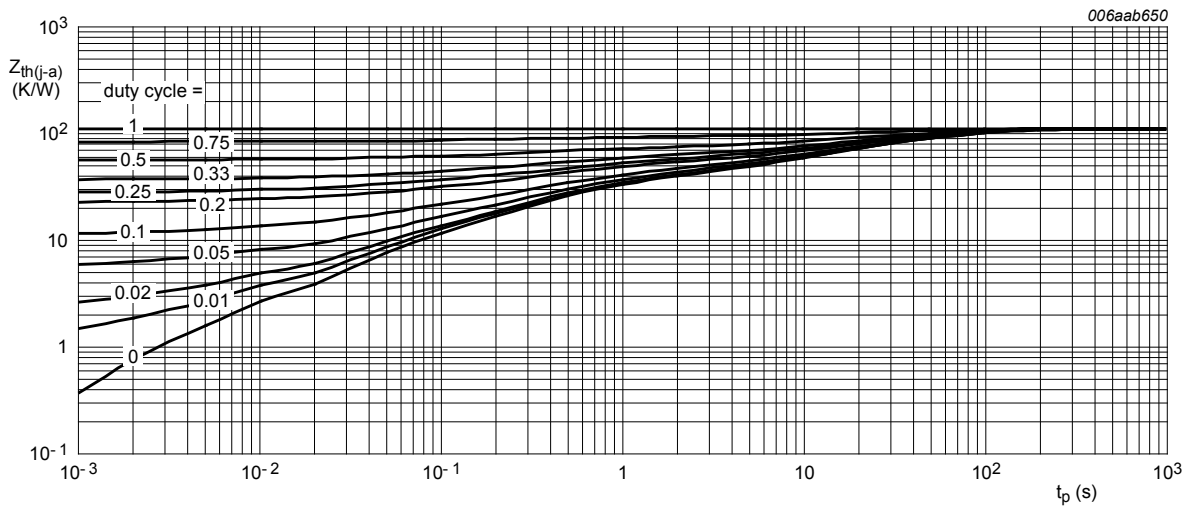

FR4 PCB, mounting pad for cathode 1 cm²

Fig. 2. Transient thermal impedance from junction to ambient as a function of pulse duration; typical values

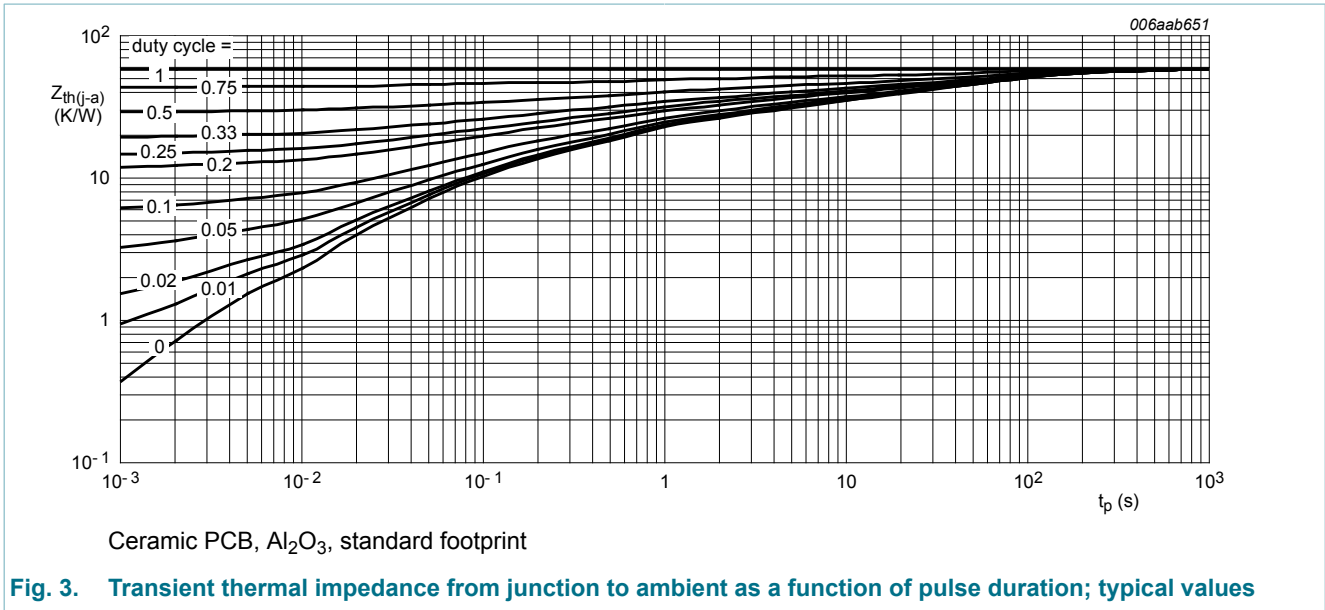

10. Characteristics

Table 7. Characteristics

Symbol	Parameter	Conditions	Min	Typ	Max	Unit
$V_{(BR)R}$	reverse breakdown voltage	$I_R = 1 \text{ mA}$; $T_j = 25 \text{ }^\circ\text{C}$; $t_p = 300 \text{ } \mu\text{s}$; $\delta = 0.02$	100	-	-	V
V_F	forward voltage	$I_F = 0.1 \text{ A}$; $t_p \leq 300 \text{ } \mu\text{s}$; $\delta \leq 0.02$; $T_j = 25 \text{ }^\circ\text{C}$	-	470	520	mV
		$I_F = 0.5 \text{ A}$; $t_p \leq 300 \text{ } \mu\text{s}$; $\delta \leq 0.02$; $T_j = 25 \text{ }^\circ\text{C}$	-	580	630	mV
		$I_F = 0.7 \text{ A}$; $t_p \leq 300 \text{ } \mu\text{s}$; $\delta \leq 0.02$; $T_j = 25 \text{ }^\circ\text{C}$	-	610	670	mV
		$I_F = 1 \text{ A}$; $t_p \leq 300 \text{ } \mu\text{s}$; $\delta \leq 0.02$; $T_j = 25 \text{ }^\circ\text{C}$	-	650	710	mV
		$I_F = 1.6 \text{ A}$; $t_p \leq 300 \text{ } \mu\text{s}$; $\delta \leq 0.02$; $T_j = 25 \text{ }^\circ\text{C}$	-	690	750	mV
		$I_F = 2 \text{ A}$; $t_p \leq 300 \text{ } \mu\text{s}$; $\delta \leq 0.02$; $T_j = 25 \text{ }^\circ\text{C}$	-	710	770	mV
		$I_F = 2 \text{ A}$; $t_p \leq 300 \text{ } \mu\text{s}$; $\delta \leq 0.02$; $T_j = 125 \text{ }^\circ\text{C}$	-	575	650	mV
I_R	reverse current	$V_R = 10 \text{ V}$; $t_p \leq 300 \text{ } \mu\text{s}$; $\delta \leq 0.02$; $T_j = 25 \text{ }^\circ\text{C}$	-	10	-	nA
		$V_R = 60 \text{ V}$; $t_p \leq 300 \text{ } \mu\text{s}$; $\delta \leq 0.02$; $T_j = 25 \text{ }^\circ\text{C}$	-	25	-	nA
		$V_R = 100 \text{ V}$; $t_p \leq 300 \text{ } \mu\text{s}$; $\delta \leq 0.02$; $T_j = 25 \text{ }^\circ\text{C}$	-	70	300	nA
		$V_R = 100 \text{ V}$; $t_p \leq 300 \text{ } \mu\text{s}$; $\delta \leq 0.02$; $T_j = 125 \text{ }^\circ\text{C}$	-	120	1000	μA
C_d	diode capacitance	$V_R = 1 \text{ V}$; $f = 1 \text{ MHz}$; $T_j = 25 \text{ }^\circ\text{C}$	-	135	-	pF
		$V_R = 4 \text{ V}$; $f = 1 \text{ MHz}$; $T_j = 25 \text{ }^\circ\text{C}$	-	80	-	pF
		$V_R = 10 \text{ V}$; $f = 1 \text{ MHz}$; $T_j = 25 \text{ }^\circ\text{C}$	-	50	-	pF
t_{rr}	reverse recovery time	$I_F = 0.5 \text{ A}$; $I_R = 0.5 \text{ A}$; $I_{R(\text{meas})} = 0.1 \text{ A}$; $T_j = 25 \text{ }^\circ\text{C}$	-	5	-	ns
V_{FRM}	peak forward recovery voltage	$I_F = 0.5 \text{ A}$; $T_j = 25 \text{ }^\circ\text{C}$; $dI_F/dt = 20 \text{ A}/\mu\text{s}$	-	630	-	mV

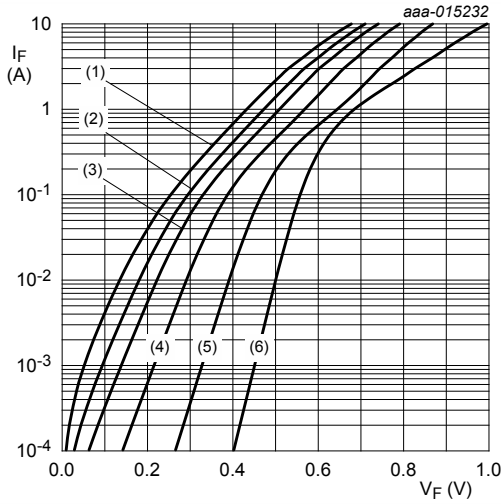

- (1) $T_j = 175\text{ }^\circ\text{C}$
- (2) $T_j = 150\text{ }^\circ\text{C}$
- (3) $T_j = 125\text{ }^\circ\text{C}$
- (4) $T_j = 85\text{ }^\circ\text{C}$
- (5) $T_j = 25\text{ }^\circ\text{C}$
- (6) $T_j = -40\text{ }^\circ\text{C}$

Fig. 4. Forward current as a function of forward voltage; typical values

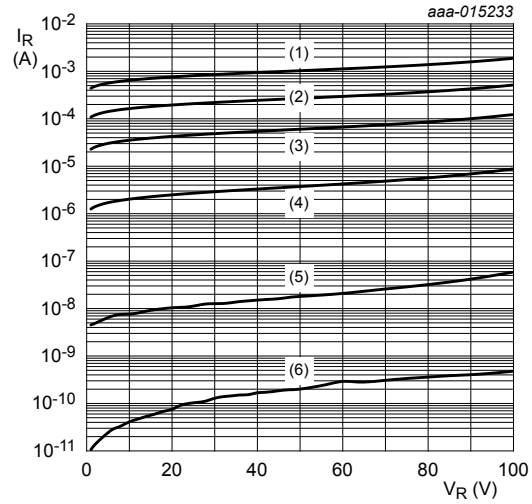

- (1) $T_j = 175\text{ }^\circ\text{C}$
- (2) $T_j = 150\text{ }^\circ\text{C}$
- (3) $T_j = 125\text{ }^\circ\text{C}$
- (4) $T_j = 85\text{ }^\circ\text{C}$
- (5) $T_j = 25\text{ }^\circ\text{C}$
- (6) $T_j = -40\text{ }^\circ\text{C}$

Fig. 5. Reverse current as a function of reverse voltage; typical values

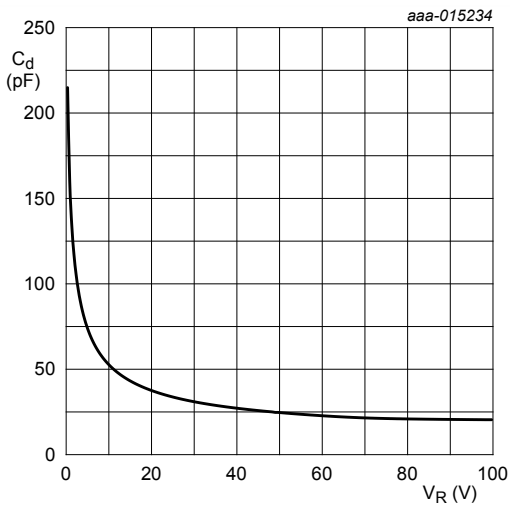

$f = 1\text{ MHz}; T_{amb} = 25\text{ }^\circ\text{C}$

Fig. 6. Diode capacitance as a function of reverse voltage; typical values

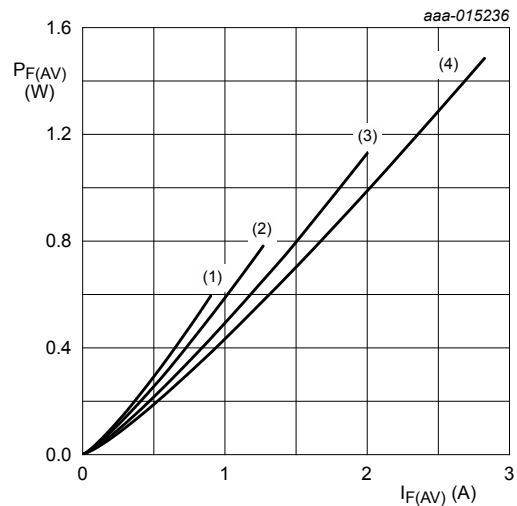

- $T_j = 175\text{ }^\circ\text{C}$
- (1) $\delta = 0.1$
- (2) $\delta = 0.2$
- (3) $\delta = 0.5$
- (4) $\delta = 1$

Fig. 7. Average forward power dissipation as a function of average forward current; typical values

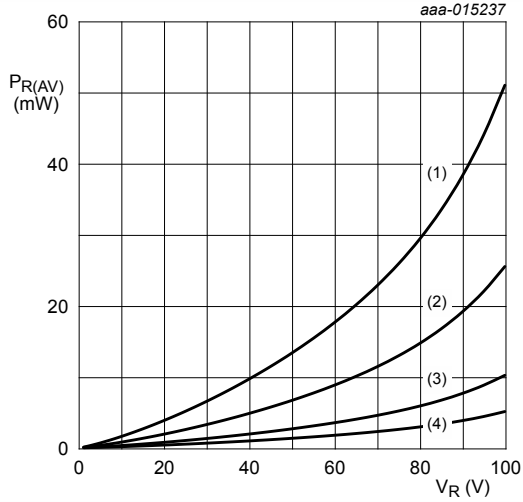

$T_j = 150\text{ }^\circ\text{C}$
 (1) $\delta = 1$ (DC)
 (2) $\delta = 0.5$; $f = 20\text{ kHz}$
 (3) $\delta = 0.2$; $f = 20\text{ kHz}$
 (4) $\delta = 0.1$; $f = 20\text{ kHz}$

Fig. 8. Average reverse power dissipation as a function of reverse voltage; typical values

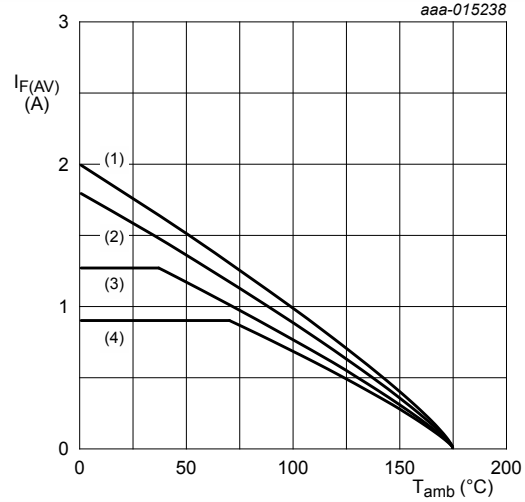

FR4 PCB, standard footprint
 $T_j = 175\text{ }^\circ\text{C}$
 (1) $\delta = 1$; DC
 (2) $\delta = 0.5$; $f = 20\text{ kHz}$
 (3) $\delta = 0.2$; $f = 20\text{ kHz}$
 (4) $\delta = 0.1$; $f = 20\text{ kHz}$

Fig. 9. Average forward current as a function of ambient temperature; typical values

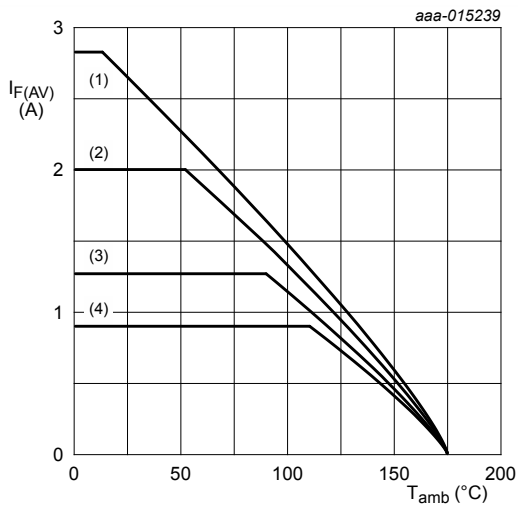

FR4 PCB, mounting pad for cathode 1 cm^2
 $T_j = 175\text{ }^\circ\text{C}$
 (1) $\delta = 1$; DC
 (2) $\delta = 0.5$; $f = 20\text{ kHz}$
 (3) $\delta = 0.2$; $f = 20\text{ kHz}$
 (4) $\delta = 0.1$; $f = 20\text{ kHz}$

Fig. 10. Average forward current as a function of ambient temperature; typical values

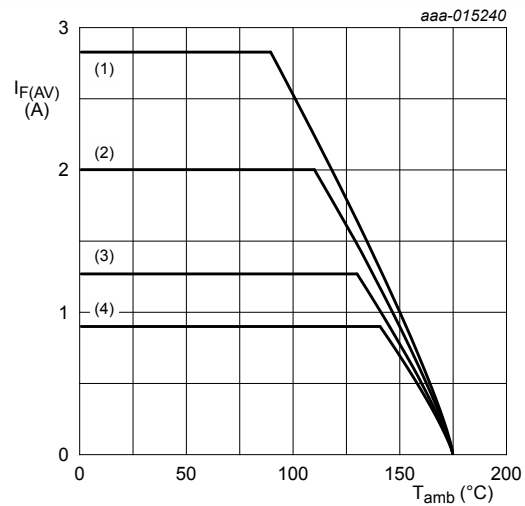

Ceramic PCB, Al_2O_3 , standard footprint
 $T_j = 175\text{ }^\circ\text{C}$
 (1) $\delta = 1$; DC
 (2) $\delta = 0.5$; $f = 20\text{ kHz}$
 (3) $\delta = 0.2$; $f = 20\text{ kHz}$
 (4) $\delta = 0.1$; $f = 20\text{ kHz}$

Fig. 11. Average forward current as a function of ambient temperature; typical values

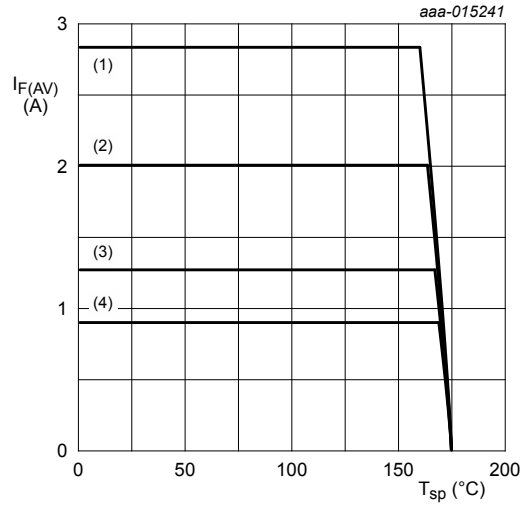

$T_j = 175 \text{ }^\circ\text{C}$

(1) $\delta = 1$; DC

(2) $\delta = 0.5$; $f = 20$ kHz

(3) $\delta = 0.2$; $f = 20$ kHz

(4) $\delta = 0.1$; $f = 20$ kHz

Fig. 12. Average forward current as a function of solder point temperature; typical values

11. Test information

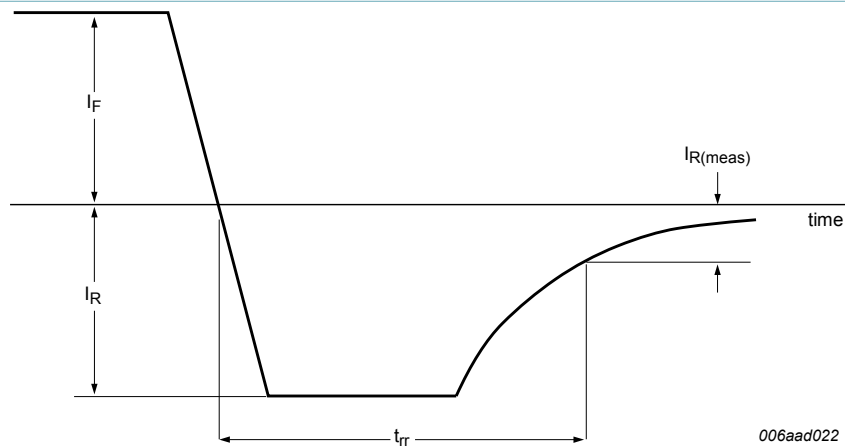

Fig. 13. Reverse recovery definition

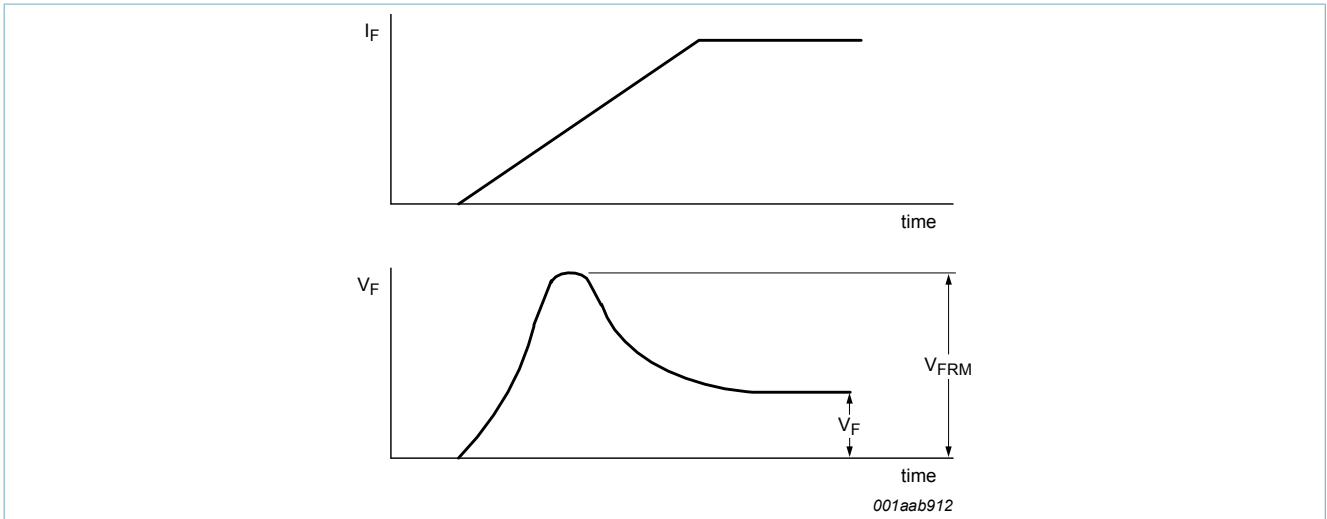

Fig. 14. Forward recovery definition

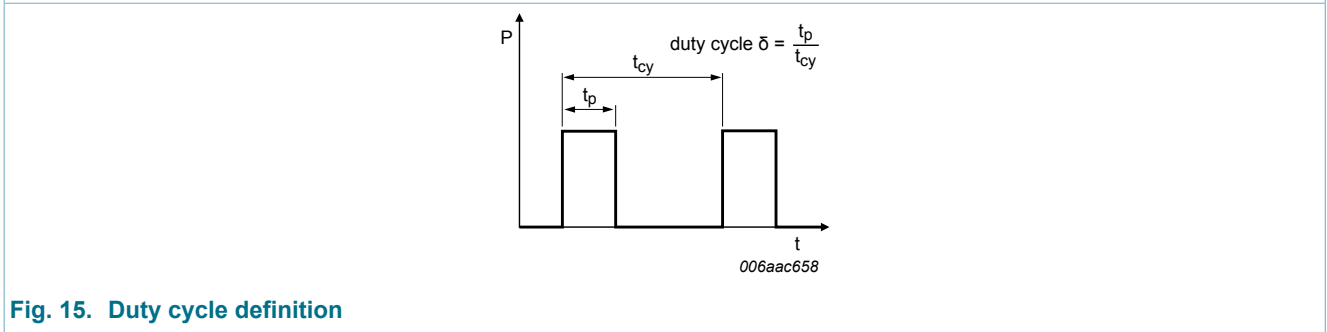

Fig. 15. Duty cycle definition

The current ratings for the typical waveforms are calculated according to the equations: $I_{F(AV)} = I_M \times \delta$ with I_M defined as peak current, $I_{RMS} = I_{F(AV)}$ at DC, and $I_{RMS} = I_M \times \sqrt{\delta}$ with I_{RMS} defined as RMS current.

11.1 Quality information

This product has been qualified in accordance with the Automotive Electronics Council (AEC) standard Q101 - Stress test qualification for discrete semiconductors, and is suitable for use in automotive applications.

12. Package outline

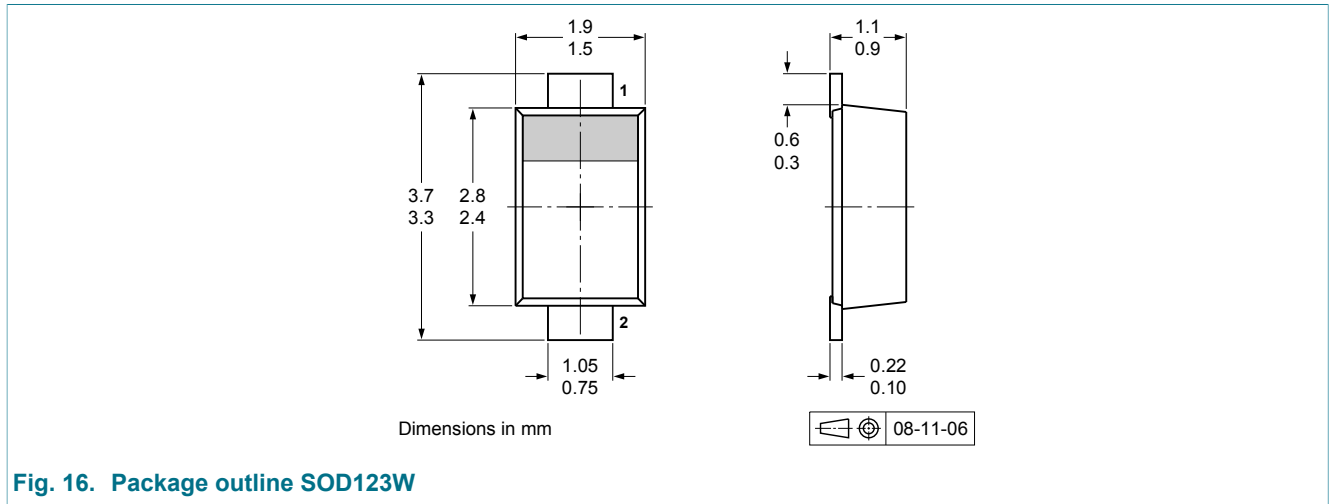

Fig. 16. Package outline SOD123W

13. Soldering

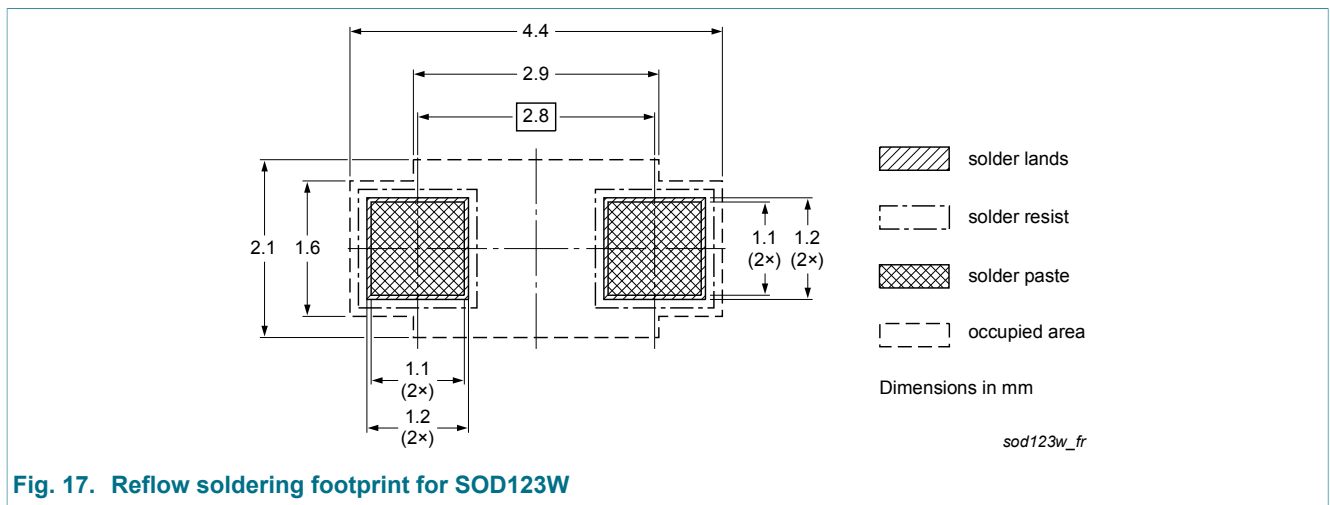

Fig. 17. Reflow soldering footprint for SOD123W

14. Revision history

Table 8. Revision history

Data sheet ID	Release date	Data sheet status	Change notice	Supersedes
PMEG10020AELR v.3	20150507	Product data sheet	-	PMEG10020AELR v.2
Modifications:	<ul style="list-style-type: none">Parameter added in table Characteristics			
PMEG10020AELR v.2	20150219	Product data sheet	-	PMEG10020AELR v.1
PMEG10020AELR v.1	20141119	Preliminary data sheet	-	-

15. Legal information

15.1 Data sheet status

Document status [1][2]	Product status [3]	Definition
Objective [short] data sheet	Development	This document contains data from the objective specification for product development.
Preliminary [short] data sheet	Qualification	This document contains data from the preliminary specification.
Product [short] data sheet	Production	This document contains the product specification.

- [1] Please consult the most recently issued document before initiating or completing a design.
- [2] The term 'short data sheet' is explained in section "Definitions".
- [3] The product status of device(s) described in this document may have changed since this document was published and may differ in case of multiple devices. The latest product status information is available on the Internet at URL <http://www.nxp.com>.

15.2 Definitions

Preview — The document is a preview version only. The document is still subject to formal approval, which may result in modifications or additions. NXP Semiconductors does not give any representations or warranties as to the accuracy or completeness of information included herein and shall have no liability for the consequences of use of such information.

Draft — The document is a draft version only. The content is still under internal review and subject to formal approval, which may result in modifications or additions. NXP Semiconductors does not give any representations or warranties as to the accuracy or completeness of information included herein and shall have no liability for the consequences of use of such information.

Short data sheet — A short data sheet is an extract from a full data sheet with the same product type number(s) and title. A short data sheet is intended for quick reference only and should not be relied upon to contain detailed and full information. For detailed and full information see the relevant full data sheet, which is available on request via the local NXP Semiconductors sales office. In case of any inconsistency or conflict with the short data sheet, the full data sheet shall prevail.

Product specification — The information and data provided in a Product data sheet shall define the specification of the product as agreed between NXP Semiconductors and its customer, unless NXP Semiconductors and customer have explicitly agreed otherwise in writing. In no event however, shall an agreement be valid in which the NXP Semiconductors product is deemed to offer functions and qualities beyond those described in the Product data sheet.

15.3 Disclaimers

Limited warranty and liability — Information in this document is believed to be accurate and reliable. However, NXP Semiconductors does not give any representations or warranties, expressed or implied, as to the accuracy or completeness of such information and shall have no liability for the consequences of use of such information. NXP Semiconductors takes no responsibility for the content in this document if provided by an information source outside of NXP Semiconductors.

In no event shall NXP Semiconductors be liable for any indirect, incidental, punitive, special or consequential damages (including - without limitation - lost profits, lost savings, business interruption, costs related to the removal or replacement of any products or rework charges) whether or not such damages are based on tort (including negligence), warranty, breach of contract or any other legal theory.

Notwithstanding any damages that customer might incur for any reason whatsoever, NXP Semiconductors' aggregate and cumulative liability towards customer for the products described herein shall be limited in accordance with the *Terms and conditions of commercial sale* of NXP Semiconductors.

Right to make changes — NXP Semiconductors reserves the right to make changes to information published in this document, including without limitation specifications and product descriptions, at any time and without notice. This document supersedes and replaces all information supplied prior to the publication hereof.

Suitability for use in automotive applications — This NXP Semiconductors product has been qualified for use in automotive applications. Unless otherwise agreed in writing, the product is not designed, authorized or warranted to be suitable for use in life support, life-critical or safety-critical systems or equipment, nor in applications where failure or malfunction of an NXP Semiconductors product can reasonably be expected to result in personal injury, death or severe property or environmental damage. NXP Semiconductors and its suppliers accept no liability for inclusion and/or use of NXP Semiconductors products in such equipment or applications and therefore such inclusion and/or use is at the customer's own risk.

Quick reference data — The Quick reference data is an extract of the product data given in the Limiting values and Characteristics sections of this document, and as such is not complete, exhaustive or legally binding.

Applications — Applications that are described herein for any of these products are for illustrative purposes only. NXP Semiconductors makes no representation or warranty that such applications will be suitable for the specified use without further testing or modification.

Customers are responsible for the design and operation of their applications and products using NXP Semiconductors products, and NXP Semiconductors accepts no liability for any assistance with applications or customer product design. It is customer's sole responsibility to determine whether the NXP Semiconductors product is suitable and fit for the customer's applications and products planned, as well as for the planned application and use of customer's third party customer(s). Customers should provide appropriate design and operating safeguards to minimize the risks associated with their applications and products.

NXP Semiconductors does not accept any liability related to any default, damage, costs or problem which is based on any weakness or default in the customer's applications or products, or the application or use by customer's third party customer(s). Customer is responsible for doing all necessary testing for the customer's applications and products using NXP Semiconductors products in order to avoid a default of the applications and the products or of the application or use by customer's third party customer(s). NXP does not accept any liability in this respect.

Limiting values — Stress above one or more limiting values (as defined in the Absolute Maximum Ratings System of IEC 60134) will cause permanent damage to the device. Limiting values are stress ratings only and (proper) operation of the device at these or any other conditions above those given in the Recommended operating conditions section (if present) or the Characteristics sections of this document is not warranted. Constant or repeated exposure to limiting values will permanently and irreversibly affect the quality and reliability of the device.

Terms and conditions of commercial sale — NXP Semiconductors products are sold subject to the general terms and conditions of commercial sale, as published at <http://www.nxp.com/profile/terms>, unless otherwise agreed in a valid written individual agreement. In case an individual agreement is concluded only the terms and conditions of the respective agreement shall apply. NXP Semiconductors hereby expressly objects to applying the customer's general terms and conditions with regard to the purchase of NXP Semiconductors products by customer.

No offer to sell or license — Nothing in this document may be interpreted or construed as an offer to sell products that is open for acceptance or the grant, conveyance or implication of any license under any copyrights, patents or other industrial or intellectual property rights.

Export control — This document as well as the item(s) described herein may be subject to export control regulations. Export might require a prior authorization from competent authorities.

Translations — A non-English (translated) version of a document is for reference only. The English version shall prevail in case of any discrepancy between the translated and English versions.

15.4 Trademarks

Notice: All referenced brands, product names, service names and trademarks are the property of their respective owners.

Bitsound, CoolFlux, CoReUse, DESFire, FabKey, GreenChip, HiPerSmart, HITAG, I²C-bus logo, ICODE, I-CODE, ITEC, MIFARE, MIFARE Plus, MIFARE Ultralight, SmartXA, STARplug, TOPFET, TrenchMOS, TriMedia and UCODE — are trademarks of NXP Semiconductors N.V.

HD Radio and **HD Radio** logo — are trademarks of iBiquity Digital Corporation.

16. Contents

1	General description	1
2	Features and benefits	1
3	Applications	1
4	Quick reference data	1
5	Pinning information	2
6	Ordering information	2
7	Marking	2
8	Limiting values	3
9	Thermal characteristics	3
10	Characteristics	6
11	Test information	9
11.1	Quality information	10
12	Package outline	11
13	Soldering	11
14	Revision history	12
15	Legal information	13
15.1	Data sheet status	13
15.2	Definitions	13
15.3	Disclaimers	13
15.4	Trademarks	14

© NXP Semiconductors N.V. 2015. All rights reserved

For more information, please visit: <http://www.nxp.com>

For sales office addresses, please send an email to: salesaddresses@nxp.com

Date of release: 7 May 2015



**Стандарт
Электрон
Связь**

Мы молодая и активно развивающаяся компания в области поставок электронных компонентов. Мы поставляем электронные компоненты отечественного и импортного производства напрямую от производителей и с крупнейших складов мира.

Благодаря сотрудничеству с мировыми поставщиками мы осуществляем комплексные и плановые поставки широчайшего спектра электронных компонентов.

Собственная эффективная логистика и склад в обеспечивает надежную поставку продукции в точно указанные сроки по всей России.

Мы осуществляем техническую поддержку нашим клиентам и предпродажную проверку качества продукции. На все поставляемые продукты мы предоставляем гарантию .

Осуществляем поставки продукции под контролем ВП МО РФ на предприятия военно-промышленного комплекса России , а также работаем в рамках 275 ФЗ с открытием отдельных счетов в уполномоченном банке. Система менеджмента качества компании соответствует требованиям ГОСТ ISO 9001.

Минимальные сроки поставки, гибкие цены, неограниченный ассортимент и индивидуальный подход к клиентам являются основой для выстраивания долгосрочного и эффективного сотрудничества с предприятиями радиоэлектронной промышленности, предприятиями ВПК и научно-исследовательскими институтами России.

С нами вы становитесь еще успешнее!

Наши контакты:

Телефон: +7 812 627 14 35

Электронная почта: sales@st-electron.ru

Адрес: 198099, Санкт-Петербург,
Промышленная ул, дом № 19, литера Н,
помещение 100-Н Офис 331