

Low Loss IGBT : IGBT in TRENCHSTOP™ and Fieldstop technology

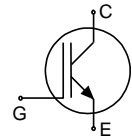

Features:

- Very low $V_{CE(sat)}$ 1.5V (typ.)
- Maximum Junction Temperature 175°C
- Short circuit withstand time 5 μ s
- Designed for frequency inverters for washing machines, fans, pumps and vacuum cleaners
- TRENCHSTOP™ technology for 600V applications offers :
 - very tight parameter distribution
 - high ruggedness, temperature stable behavior
 - very high switching speed
- Positive temperature coefficient in $V_{CE(sat)}$
- Low EMI
- Low Gate Charge
- Pb-free lead plating; RoHS compliant
- Qualified according to JEDEC¹ for target applications
- Complete product spectrum and PSpice Models : <http://www.infineon.com/igbt/>

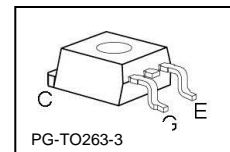

Type	V_{CE}	I_C	$V_{CE(sat), T_j=25^\circ C}$	$T_{j,max}$	Marking Code	Package
IGB15N60T	600V	15A	1.5V	175°C	G15T60	PG-TO263-3

Maximum Ratings

Parameter	Symbol	Value	Unit
Collector-emitter voltage, $T_j \geq 25^\circ C$	V_{CE}	600	V
DC collector current, limited by $T_{j,max}$	I_C	26	A
$T_C = 25^\circ C$, value limited by bondwire		23	
$T_C = 100^\circ C$		23	
Pulsed collector current, t_p limited by $T_{j,max}$	$I_{C,puls}$	45	
Turn off safe operating area, $V_{CE} = 600V$, $T_j = 175^\circ C$, $t_p = 1\mu s$	-	45	
Gate-emitter voltage	V_{GE}	± 20	V
Short circuit withstand time ²⁾	t_{SC}	5	μs
$V_{GE} = 15V$, $V_{CC} \leq 400V$, $T_j \leq 150^\circ C$			
Power dissipation $T_C = 25^\circ C$	P_{tot}	130	W
Operating junction temperature	T_j	-40...+175	°C
Storage temperature	T_{stg}	-55...+150	
Soldering temperature (reflow soldering, MSL1)		260	

¹ J-STD-020 and JESD-022

²⁾ Allowed number of short circuits: <1000; time between short circuits: >1s.

Thermal Resistance

Parameter	Symbol	Conditions	Max. Value	Unit
Characteristic				
IGBT thermal resistance, junction – case	R_{thJC}		1.15	K/W
Thermal resistance, junction – ambient	R_{thJA}	6cm ² Cu	40	

Electrical Characteristic, at $T_j = 25\text{ °C}$, unless otherwise specified

Parameter	Symbol	Conditions	Value			Unit
			min.	Typ.	max.	
Static Characteristic						
Collector-emitter breakdown voltage	$V_{(BR)CES}$	$V_{GE}=0V, I_C=0.2mA$	600	-	-	V
Collector-emitter saturation voltage	$V_{CE(sat)}$	$V_{GE} = 15V, I_C=15A$ $T_j=25\text{ °C}$ $T_j=175\text{ °C}$	-	1.5	2.05	
Gate-emitter threshold voltage	$V_{GE(th)}$	$I_C=210\mu A, V_{CE}=V_{GE}$	4.1	4.9	5.7	
Zero gate voltage collector current	I_{CES}	$V_{CE}=600V, V_{GE}=0V$ $T_j=25\text{ °C}$ $T_j=175\text{ °C}$	-	-	40	μA
			-	-	1000	
Gate-emitter leakage current	I_{GES}	$V_{CE}=0V, V_{GE}=20V$	-	-	100	nA
Transconductance	g_{fs}	$V_{CE}=20V, I_C=15A$	-	8.7	-	S
Integrated gate resistor	R_{Gint}			-		Ω

Dynamic Characteristic

Input capacitance	C_{iss}	$V_{CE}=25V,$ $V_{GE}=0V,$ $f=1MHz$	-	860	-	μF
Output capacitance	C_{oss}		-	55	-	
Reverse transfer capacitance	C_{rss}		-	24	-	
Gate charge	Q_{Gate}	$V_{CC}=480V, I_C=15A$ $V_{GE}=15V$	-	87	-	nC
Internal emitter inductance measured 5mm (0.197 in.) from case	L_E		-	7	-	nH
Short circuit collector current ¹⁾	$I_{C(SC)}$	$V_{GE}=15V, t_{SC}\leq 5\mu s$ $V_{CC} = 400V,$ $T_j = 150\text{ °C}$	-	137.5	-	A

¹⁾ Allowed number of short circuits: <1000; time between short circuits: >1s.

Switching Characteristic, Inductive Load, at $T_j=25\text{ °C}$

Parameter	Symbol	Conditions	Value			Unit
			min.	Typ.	max.	
IGBT Characteristic						
Turn-on delay time	$t_{d(on)}$	$T_j=25\text{ °C}$, $V_{CC}=400\text{V}$, $I_C=15\text{A}$, $V_{GE}=0/15\text{V}$, $r_G=15\Omega$, $L_\sigma=154\text{nH}$, $C_\sigma=39\text{pF}$	-	17	-	ns
Rise time	t_r		-	11	-	
Turn-off delay time	$t_{d(off)}$		-	188	-	
Fall time	t_f		-	50	-	
Turn-on energy	E_{on}	L_σ , C_σ from Fig. E Energy losses include "tail" and diode reverse recovery. Diode from IKW30N60T	-	0.22	-	mJ
Turn-off energy	E_{off}		-	0.35	-	
Total switching energy	E_{ts}		-	0.57	-	

Switching Characteristic, Inductive Load, at $T_j=175\text{ °C}$

Parameter	Symbol	Conditions	Value			Unit
			min.	Typ.	max.	
IGBT Characteristic						
Turn-on delay time	$t_{d(on)}$	$T_j=175\text{ °C}$, $V_{CC}=400\text{V}$, $I_C=15\text{A}$, $V_{GE}=0/15\text{V}$, $r_G=15\Omega$, $L_\sigma=154\text{nH}$, $C_\sigma=39\text{pF}$	-	17	-	ns
Rise time	t_r		-	15	-	
Turn-off delay time	$t_{d(off)}$		-	212	-	
Fall time	t_f		-	79	-	
Turn-on energy	E_{on}	L_σ , C_σ from Fig. E Energy losses include "tail" and diode reverse recovery. Diode from IKW30N60T	-	0.34	-	mJ
Turn-off energy	E_{off}		-	0.47	-	
Total switching energy	E_{ts}		-	0.81	-	

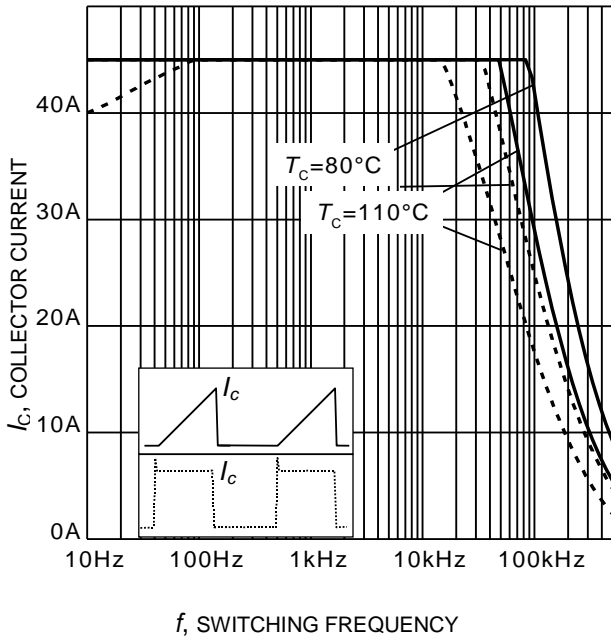

Figure 1. Collector current as a function of switching frequency
 ($T_j \leq 175^\circ\text{C}$, $D = 0.5$, $V_{CE} = 400\text{V}$, $V_{GE} = 0/15\text{V}$, $r_G = 15\Omega$)

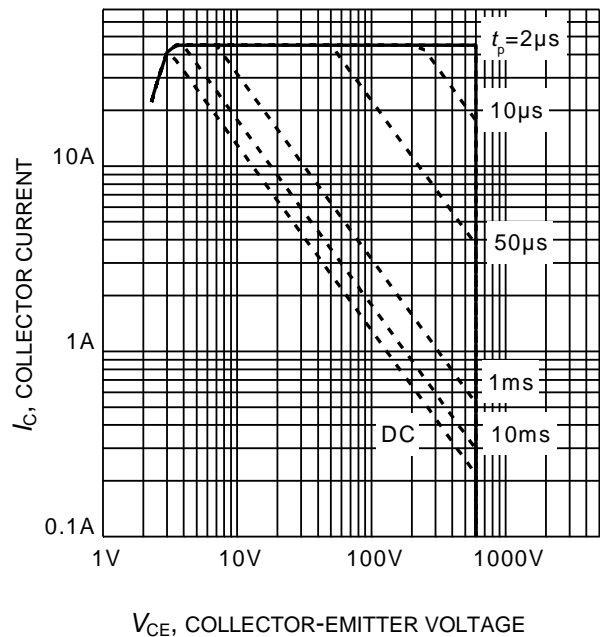

Figure 2. Safe operating area
 ($D = 0$, $T_C = 25^\circ\text{C}$, $T_j \leq 175^\circ\text{C}$; $V_{GE} = 0/15\text{V}$)



Figure 3. Power dissipation as a function of case temperature
 ($T_j \leq 175^\circ\text{C}$)

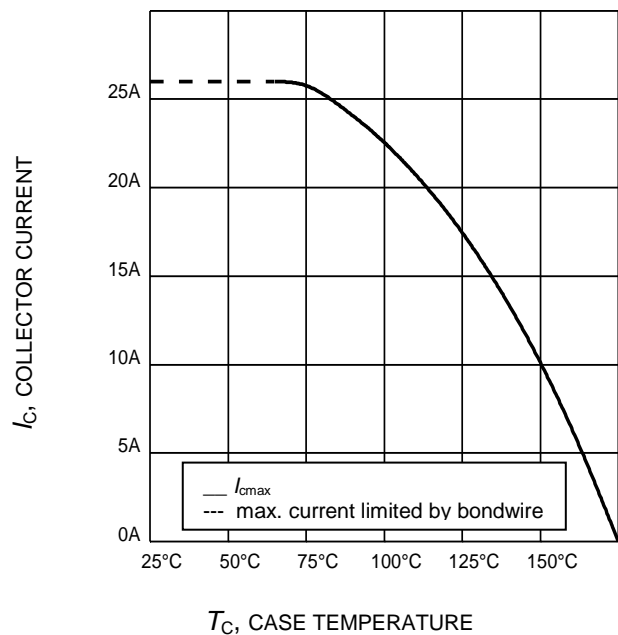

Figure 4. Collector current as a function of case temperature
 ($V_{GE} \geq 15\text{V}$, $T_j \leq 175^\circ\text{C}$)



Figure 5. Typical output characteristic
($T_j = 25^\circ\text{C}$)



Figure 6. Typical output characteristic
($T_j = 175^\circ\text{C}$)

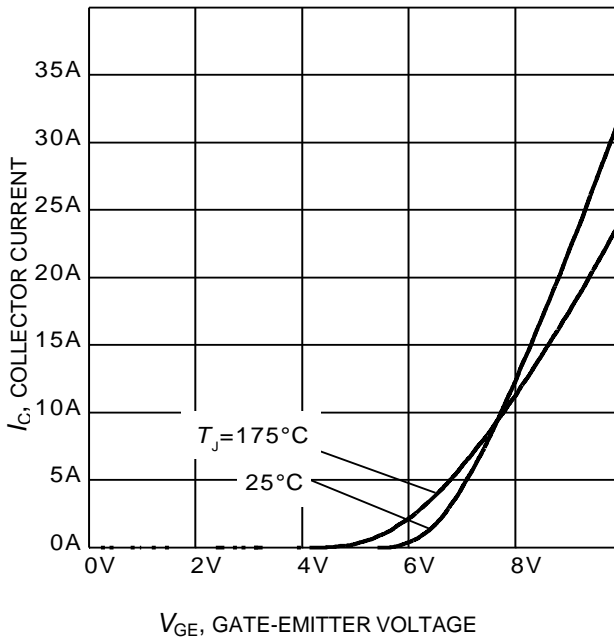
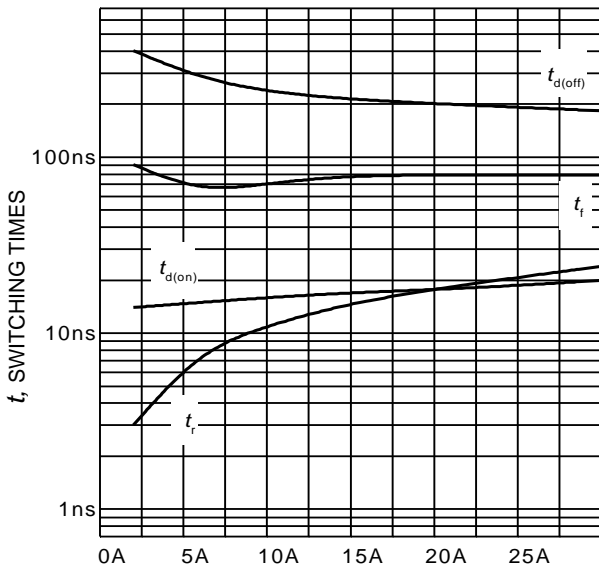

Figure 7. Typical transfer characteristic
($V_{CE} = 20\text{V}$)

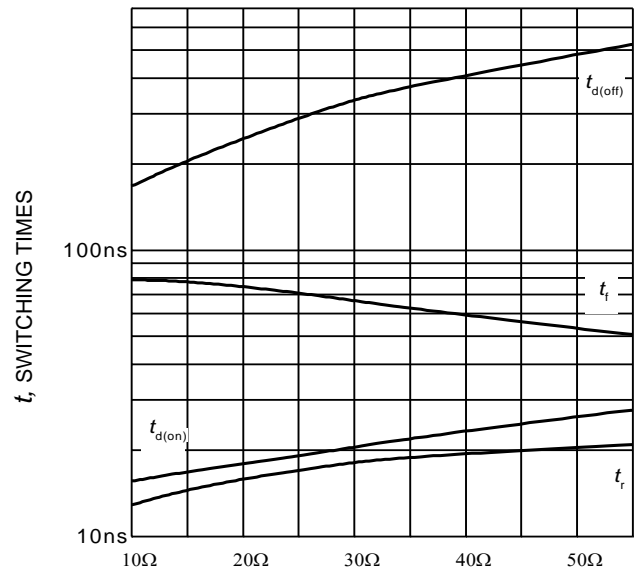

Figure 8. Typical collector-emitter saturation voltage as a function of junction temperature
($V_{GE} = 15\text{V}$)



I_C , COLLECTOR CURRENT

Figure 9. Typical switching times as a function of collector current
(inductive load, $T_J=175^\circ\text{C}$,
 $V_{CE} = 400\text{V}$, $V_{GE} = 0/15\text{V}$, $r_G = 15\Omega$,
Dynamic test circuit in Figure E)



R_G , GATE RESISTOR

Figure 10. Typical switching times as a function of gate resistor
(inductive load, $T_J = 175^\circ\text{C}$,
 $V_{CE} = 400\text{V}$, $V_{GE} = 0/15\text{V}$, $I_C = 15\text{A}$,
Dynamic test circuit in Figure E)

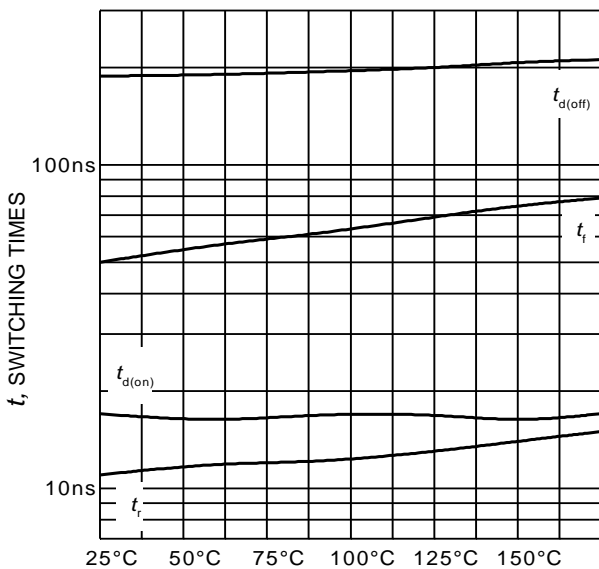

T_J , JUNCTION TEMPERATURE

Figure 11. Typical switching times as a function of junction temperature
(inductive load, $V_{CE} = 400\text{V}$,
 $V_{GE} = 0/15\text{V}$, $I_C = 15\text{A}$, $r_G=15\Omega$,
Dynamic test circuit in Figure E)

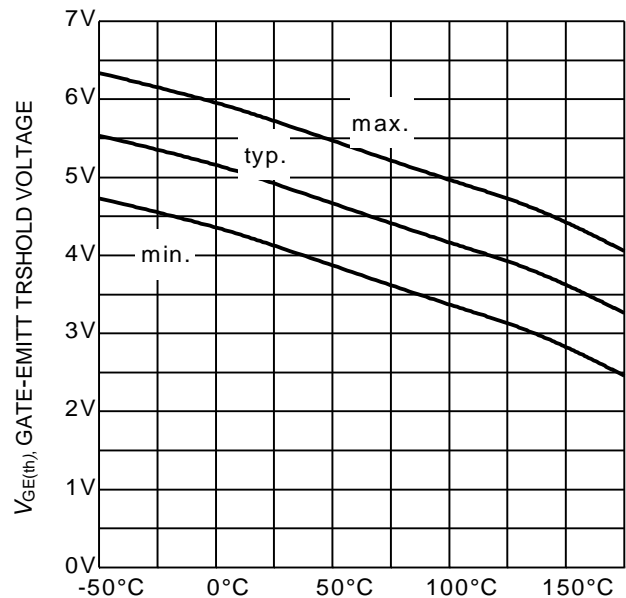

T_J , JUNCTION TEMPERATURE

Figure 12. Gate-emitter threshold voltage as a function of junction temperature
($I_C = 0.21\text{mA}$)

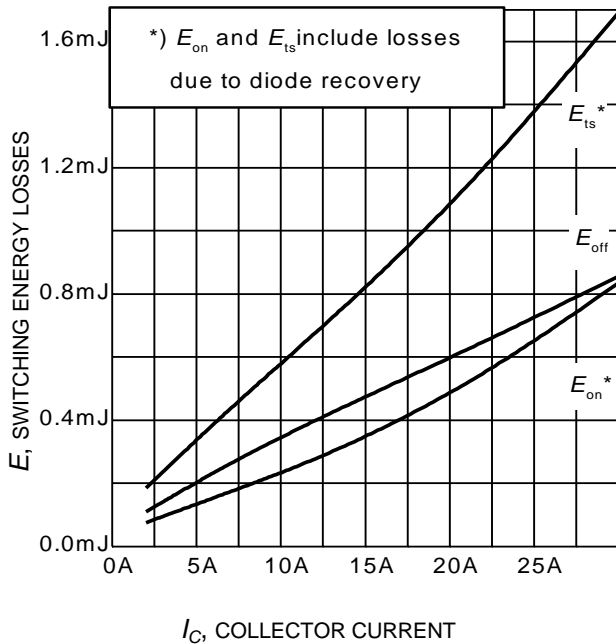

Figure 13. Typical switching energy losses as a function of collector current
(inductive load, $T_J = 175^\circ\text{C}$, $V_{CE} = 400\text{V}$, $V_{GE} = 0/15\text{V}$, $r_G = 15\Omega$, Dynamic test circuit in Figure E)

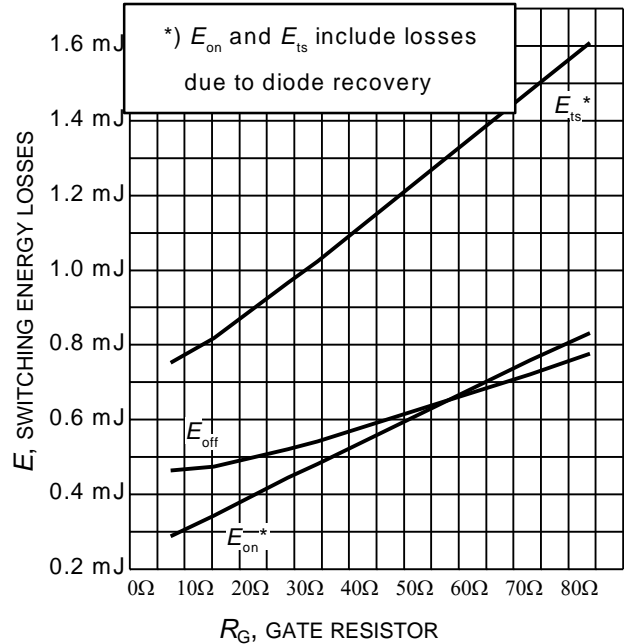

Figure 14. Typical switching energy losses as a function of gate resistor
(inductive load, $T_J = 175^\circ\text{C}$, $V_{CE} = 400\text{V}$, $V_{GE} = 0/15\text{V}$, $I_C = 15\text{A}$, Dynamic test circuit in Figure E)



Figure 15. Typical switching energy losses as a function of junction temperature
(inductive load, $V_{CE} = 400\text{V}$, $V_{GE} = 0/15\text{V}$, $I_C = 15\text{A}$, $r_G = 15\Omega$, Dynamic test circuit in Figure E)

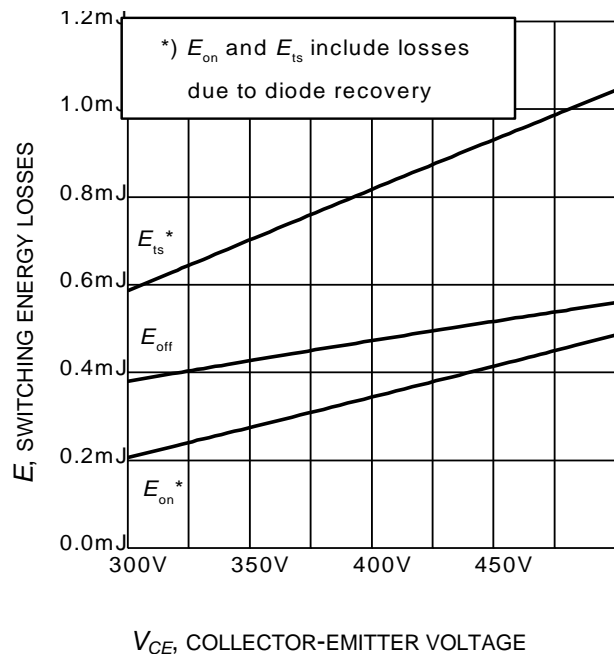

Figure 16. Typical switching energy losses as a function of collector emitter voltage
(inductive load, $T_J = 175^\circ\text{C}$, $V_{GE} = 0/15\text{V}$, $I_C = 15\text{A}$, $r_G = 15\Omega$, Dynamic test circuit in Figure E)

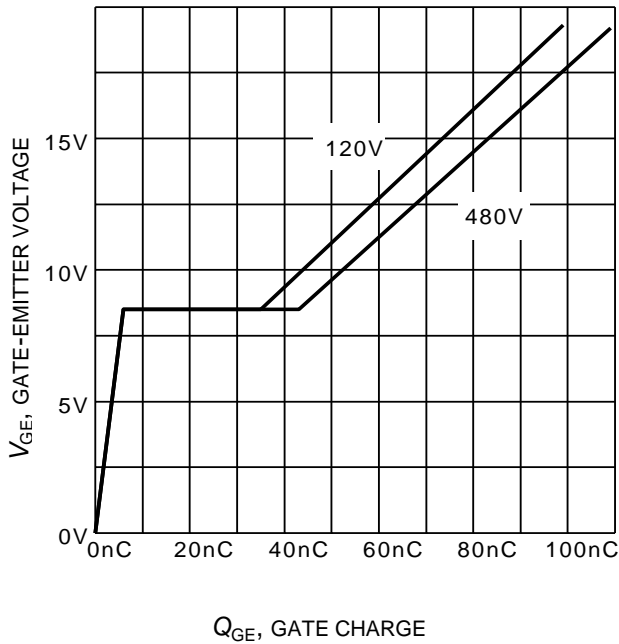

Figure 17. Typical gate charge
($I_C=15\text{ A}$)

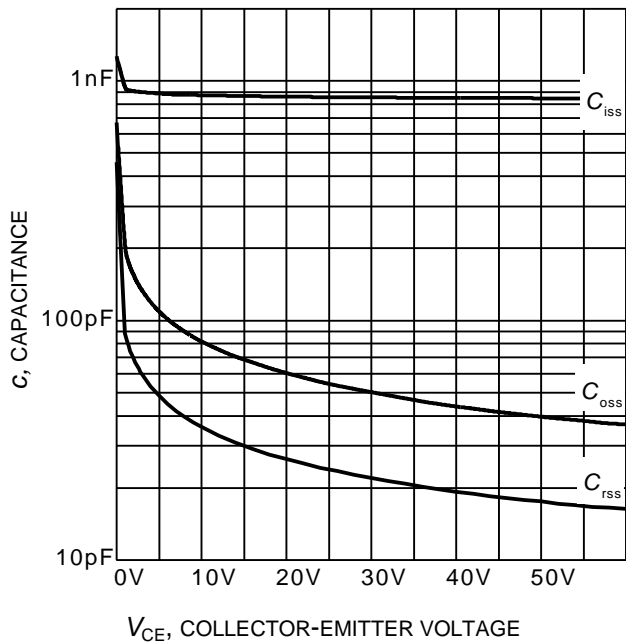

Figure 18. Typical capacitance as a function of collector-emitter voltage
($V_{GE}=0\text{V}$, $f = 1\text{ MHz}$)

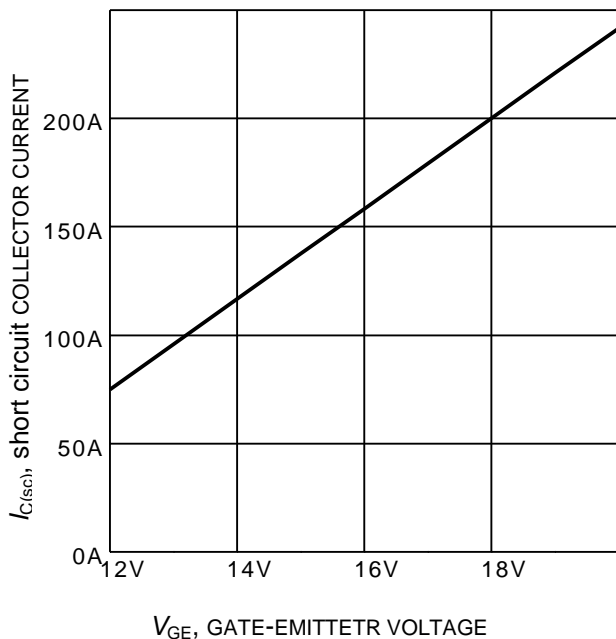

Figure 19. Typical short circuit collector current as a function of gate-emitter voltage
($V_{CE} \leq 400\text{V}$, $T_J \leq 150^\circ\text{C}$)



Figure 20. Short circuit withstand time as a function of gate-emitter voltage
($V_{CE}=400\text{V}$, start at $T_J=25^\circ\text{C}$, $T_{Jmax}<150^\circ\text{C}$)

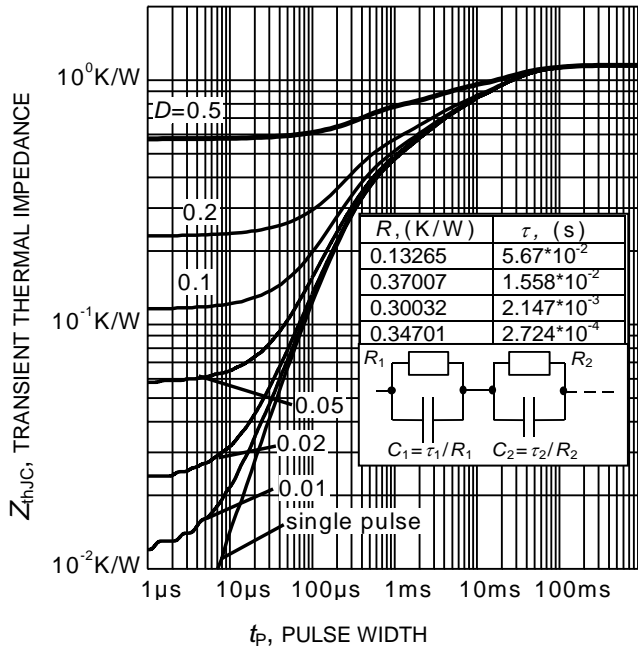
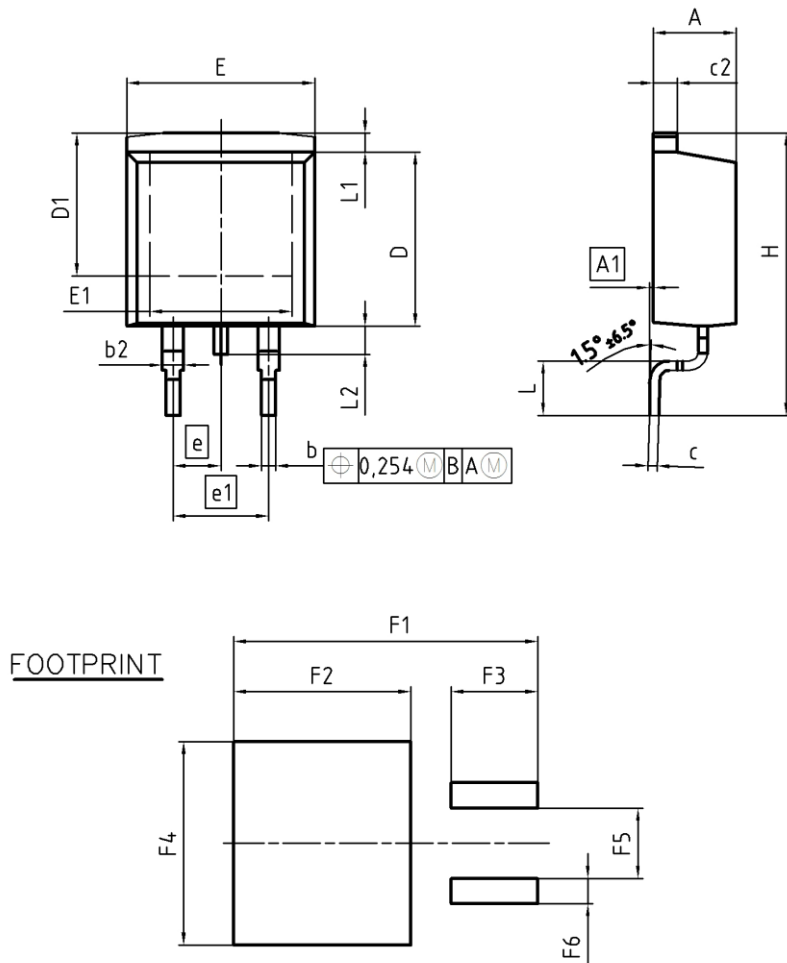

Figure 21. IGBT transient thermal impedance
 $(D = t_p / T)$

PG-TO263-3



DIM	MILLIMETERS		INCHES	
	MIN	MAX	MIN	MAX
A	4.30	4.57	0.169	0.180
A1	0.00	0.25	0.000	0.010
b	0.65	0.85	0.026	0.033
b2	0.95	1.15	0.037	0.045
c	0.33	0.65	0.013	0.026
c2	1.17	1.40	0.046	0.055
D	8.51	9.45	0.335	0.372
D1	7.10	7.90	0.280	0.311
E	9.80	10.31	0.386	0.406
E1	6.50	8.60	0.256	0.339
e	2.54		0.100	
e1	5.08		0.200	
N	2		2	
H	14.61	15.88	0.575	0.625
L	2.29	3.00	0.090	0.118
L1	0.70	1.60	0.028	0.063
L2	1.00	1.78	0.039	0.070
F1	16.05	16.25	0.632	0.640
F2	9.30	9.50	0.366	0.374
F3	4.50	4.70	0.177	0.185
F4	10.70	10.90	0.421	0.429
F5	3.65	3.85	0.144	0.152
F6	1.25	1.45	0.049	0.057

DOCUMENT NO. Z8B00003324
SCALE 0 5 5 7.5mm
EUROPEAN PROJECTION
ISSUE DATE 30-08-2007
REVISION 01



Figure A. Definition of switching times

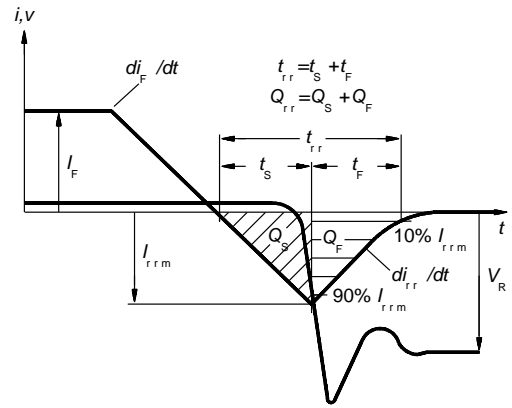

Figure C. Definition of diodes switching characteristics

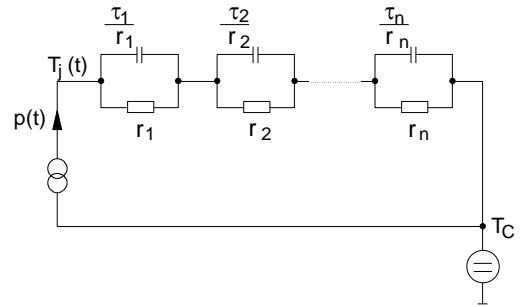

Figure D. Thermal equivalent circuit

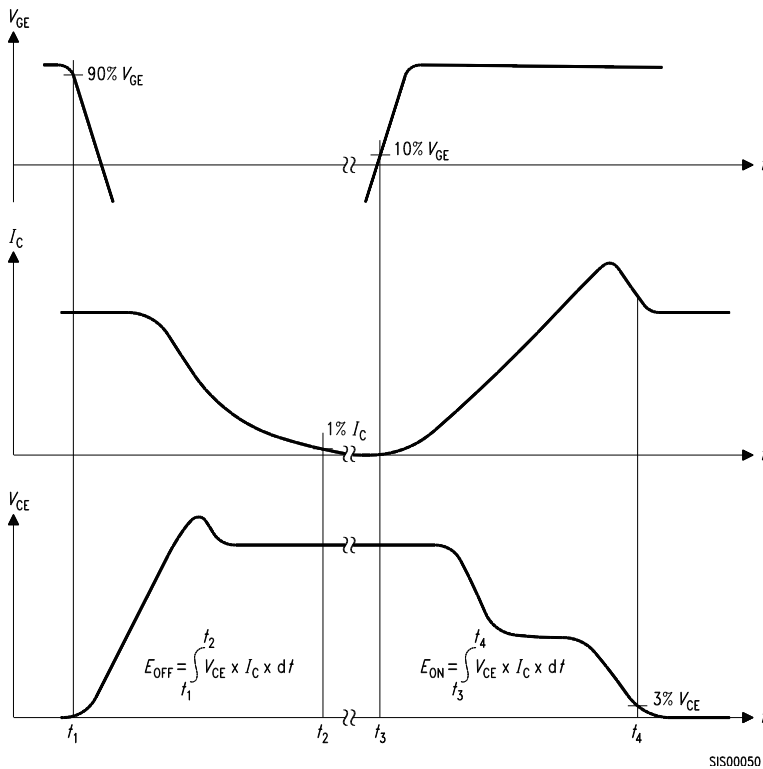

Figure B. Definition of switching losses

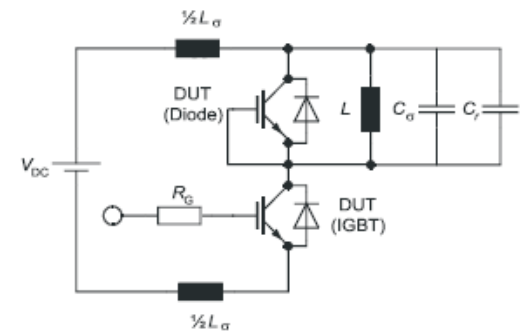

Figure E. Dynamic test circuit
Parasitic inductance L_σ ,
Parasitic capacitor C_σ ,
Relief capacitor C_r ,
(only for ZVT switching)

Published by
Infineon Technologies AG
81726 Munich, Germany
© 2015 Infineon Technologies AG
All Rights Reserved.

Legal Disclaimer

The information given in this document shall in no event be regarded as a guarantee of conditions or characteristics. With respect to any examples or hints given herein, any typical values stated herein and/or any information regarding the application of the device, Infineon Technologies hereby disclaims any and all warranties and liabilities of any kind, including without limitation, warranties of non-infringement of intellectual property rights of any third party.

Information

For further information on technology, delivery terms and conditions and prices, please contact the nearest Infineon Technologies Office (www.infineon.com).

Warnings

Due to technical requirements, components may contain dangerous substances. For information on the types in question, please contact the nearest Infineon Technologies Office.

The Infineon Technologies component described in this Data Sheet may be used in life-support devices or systems and/or automotive, aviation and aerospace applications or systems only with the express written approval of Infineon Technologies, if a failure of such components can reasonably be expected to cause the failure of that life-support, automotive, aviation and aerospace device or system or to affect the safety or effectiveness of that device or system. Life support devices or systems are intended to be implanted in the human body or to support and/or maintain and sustain and/or protect human life. If they fail, it is reasonable to assume that the health of the user or other persons may be endangered.



Стандарт Электрон Связь

Мы молодая и активно развивающаяся компания в области поставок электронных компонентов. Мы поставляем электронные компоненты отечественного и импортного производства напрямую от производителей и с крупнейших складов мира.

Благодаря сотрудничеству с мировыми поставщиками мы осуществляем комплексные и плановые поставки широчайшего спектра электронных компонентов.

Собственная эффективная логистика и склад в обеспечивает надежную поставку продукции в точно указанные сроки по всей России.

Мы осуществляем техническую поддержку нашим клиентам и предпродажную проверку качества продукции. На все поставляемые продукты мы предоставляем гарантию .

Осуществляем поставки продукции под контролем ВП МО РФ на предприятия военно-промышленного комплекса России , а также работаем в рамках 275 ФЗ с открытием отдельных счетов в уполномоченном банке. Система менеджмента качества компании соответствует требованиям ГОСТ ISO 9001.

Минимальные сроки поставки, гибкие цены, неограниченный ассортимент и индивидуальный подход к клиентам являются основой для выстраивания долгосрочного и эффективного сотрудничества с предприятиями радиоэлектронной промышленности, предприятиями ВПК и научно-исследовательскими институтами России.

С нами вы становитесь еще успешнее!

Наши контакты:

Телефон: +7 812 627 14 35

Электронная почта: sales@st-electron.ru

Адрес: 198099, Санкт-Петербург,
Промышленная ул, дом № 19, литера Н,
помещение 100-Н Офис 331