

IGBT

High speed IGBT in Trench and Fieldstop technology

IGW30N60H3

600V high speed switching series third generation

Datasheet

Industrial & Multimarket

High speed IGBT in Trench and Fieldstop technology

Features:

TRENCHSTOP™ technology offering

- very low V_{CEsat}
- low EMI
- Very soft, fast recovery anti-parallel diode
- maximum junction temperature 175°C
- qualified according to JEDEC for target applications
- Pb-free lead plating; RoHS compliant
- complete product spectrum and PSpice Models:
<http://www.infineon.com/igbt/>

Applications:

- uninterruptible power supplies
- welding converters
- converters with high switching frequency

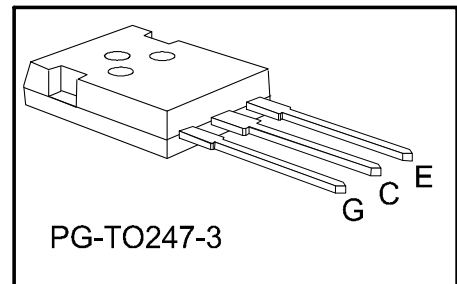
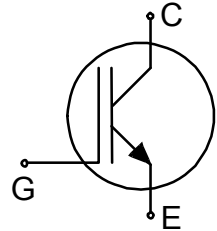

Key Performance and Package Parameters

Type	V_{CE}	I_C	$V_{CEsat}, T_{vj}=25^{\circ}C$	T_{vjmax}	Marking	Package
IGW30N60H3	600V	30A	1.95V	175°C	G30H603	PG-TO247-3



Table of Contents

Description 2

Table of Contents 3

Maximum ratings 4

Thermal Resistance 4

Electrical Characteristics 4

Electrical Characteristics diagrams 6

Package Drawing 12

Testing Conditions 13

Revision History 14

Disclaimer 14

Maximum ratings

Parameter	Symbol	Value	Unit
Collector-emitter voltage	V_{CE}	600	V
DC collector current, limited by T_{vjmax} $T_C = 25^\circ\text{C}$ $T_C = 100^\circ\text{C}$	I_C	60.0 30.0	A
Pulsed collector current, t_p limited by T_{vjmax}	I_{Cpuls}	120.0	A
Turn off safe operating area $V_{CE} \leq 600\text{V}$, $T_{vj} \leq 175^\circ\text{C}$	-	120.0	A
Gate-emitter voltage	V_{GE}	± 20	V
Short circuit withstand time $V_{GE} = 15.0\text{V}$, $V_{CC} \leq 400\text{V}$ Allowed number of short circuits < 1000 Time between short circuits: $\geq 1.0\text{s}$ $T_{vj} = 150^\circ\text{C}$	t_{SC}	5	μs
Power dissipation $T_C = 25^\circ\text{C}$ Power dissipation $T_C = 100^\circ\text{C}$	P_{tot}	187.0 94.0	W
Operating junction temperature	T_{vj}	-40...+175	$^\circ\text{C}$
Storage temperature	T_{stg}	-55...+150	$^\circ\text{C}$
Soldering temperature, wave soldering 1.6 mm (0.063 in.) from case for 10s		260	$^\circ\text{C}$
Mounting torque, M3 screw Maximum of mounting processes: 3	M	0.6	Nm

Thermal Resistance

Parameter	Symbol	Conditions	Max. Value	Unit
Characteristic				
IGBT thermal resistance, junction - case	$R_{th(j-c)}$		0.80	K/W
Thermal resistance junction - ambient	$R_{th(j-a)}$		40	K/W

Electrical Characteristic, at $T_{vj} = 25^\circ\text{C}$, unless otherwise specified

Parameter	Symbol	Conditions	Value			Unit
			min.	typ.	max.	
Static Characteristic						
Collector-emitter breakdown voltage	$V_{(BR)CES}$	$V_{GE} = 0\text{V}$, $I_C = 2.00\text{mA}$	600	-	-	V
Collector-emitter saturation voltage	V_{CEsat}	$V_{GE} = 15.0\text{V}$, $I_C = 30.0\text{A}$ $T_{vj} = 25^\circ\text{C}$ $T_{vj} = 125^\circ\text{C}$ $T_{vj} = 175^\circ\text{C}$	- - -	1.95 2.30 2.50	2.40 - -	V
Gate-emitter threshold voltage	$V_{GE(th)}$	$I_C = 0.43\text{mA}$, $V_{CE} = V_{GE}$	4.1	5.1	5.7	V
Zero gate voltage collector current	I_{CES}	$V_{CE} = 600\text{V}$, $V_{GE} = 0\text{V}$ $T_{vj} = 25^\circ\text{C}$ $T_{vj} = 175^\circ\text{C}$	- -	- -	40.0 1000.0	μA
Gate-emitter leakage current	I_{GES}	$V_{CE} = 0\text{V}$, $V_{GE} = 20\text{V}$	-	-	100	nA
Transconductance	g_{fs}	$V_{CE} = 20\text{V}$, $I_C = 30.0\text{A}$	-	16.0	-	S

Electrical Characteristic, at $T_{vj} = 25^{\circ}\text{C}$, unless otherwise specified

Parameter	Symbol	Conditions	Value			Unit
			min.	typ.	max.	
Dynamic Characteristic						
Input capacitance	C_{ies}	$V_{CE} = 25\text{V}, V_{GE} = 0\text{V}, f = 1\text{MHz}$	-	1630	-	pF
Output capacitance	C_{oes}		-	107	-	
Reverse transfer capacitance	C_{res}		-	50	-	
Gate charge	Q_G	$V_{CC} = 480\text{V}, I_C = 30.0\text{A}, V_{GE} = 15\text{V}$	-	165.0	-	nC
Internal emitter inductance measured 5mm (0.197 in.) from case	L_E		-	13.0	-	nH
Short circuit collector current Max. 1000 short circuits Time between short circuits: $\geq 1.0\text{s}$	$I_{C(SC)}$	$V_{GE} = 15.0\text{V}, V_{CC} \leq 400\text{V}, t_{SC} \leq 5\mu\text{s}, T_{vj} = 150^{\circ}\text{C}$	-	160	-	A

Switching Characteristic, Inductive Load, at $T_{vj} = 25^{\circ}\text{C}$

Parameter	Symbol	Conditions	Value			Unit
			min.	typ.	max.	
IGBT Characteristic						
Turn-on delay time	$t_{d(on)}$	$T_{vj} = 25^{\circ}\text{C}, V_{CC} = 400\text{V}, I_C = 30.0\text{A}, V_{GE} = 0.0/15.0\text{V}, r_G = 10.5\Omega, L_{\sigma} = 95\text{nH}, C_{\sigma} = 67\text{pF}, L_{\sigma}, C_{\sigma}$ from Fig. E Energy losses include "tail" and diode (IKW30N60H3) reverse recovery.	-	21	-	ns
Rise time	t_r		-	33	-	ns
Turn-off delay time	$t_{d(off)}$		-	207	-	ns
Fall time	t_f		-	22	-	ns
Turn-on energy	E_{on}		-	0.94	-	mJ
Turn-off energy	E_{off}		-	0.44	-	mJ
Total switching energy	E_{ts}		-	1.38	-	mJ

Switching Characteristic, Inductive Load, at $T_{vj} = 175^{\circ}\text{C}$

Parameter	Symbol	Conditions	Value			Unit
			min.	typ.	max.	
IGBT Characteristic						
Turn-on delay time	$t_{d(on)}$	$T_{vj} = 175^{\circ}\text{C}, V_{CC} = 400\text{V}, I_C = 30.0\text{A}, V_{GE} = 0.0/15.0\text{V}, r_G = 10.5\Omega, L_{\sigma} = 95\text{nH}, C_{\sigma} = 67\text{pF}, L_{\sigma}, C_{\sigma}$ from Fig. E Energy losses include "tail" and diode (IKW30N60H3) reverse recovery.	-	20	-	ns
Rise time	t_r		-	30	-	ns
Turn-off delay time	$t_{d(off)}$		-	239	-	ns
Fall time	t_f		-	23	-	ns
Turn-on energy	E_{on}		-	1.12	-	mJ
Turn-off energy	E_{off}		-	0.60	-	mJ
Total switching energy	E_{ts}		-	1.72	-	mJ

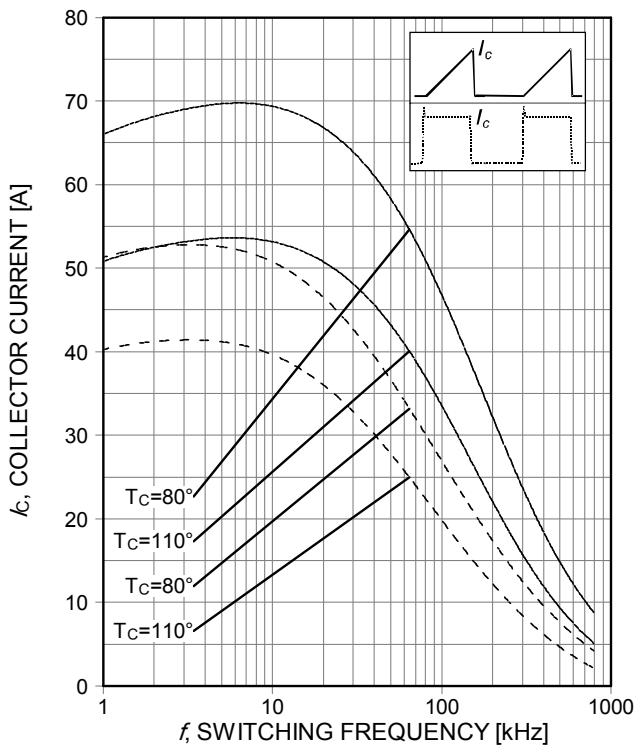

Figure 1. Collector current as a function of switching frequency
 ($T_j \leq 175^\circ\text{C}$, $D=0.5$, $V_{CE}=400\text{V}$, $V_{GE}=15/0\text{V}$, $R_G=10,5\Omega$)

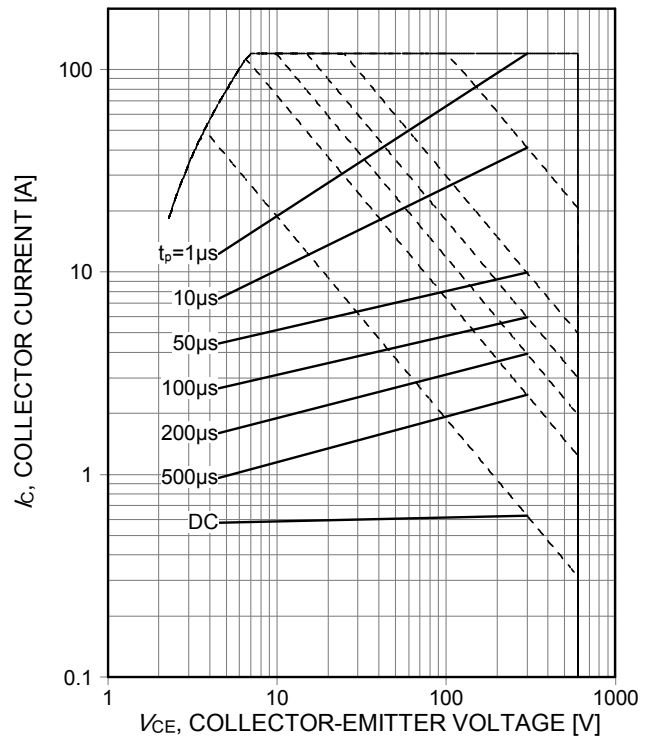

Figure 2. Forward bias safe operating area
 ($D=0$, $T_C=25^\circ\text{C}$, $T_j \leq 175^\circ\text{C}$; $V_{GE}=15\text{V}$)

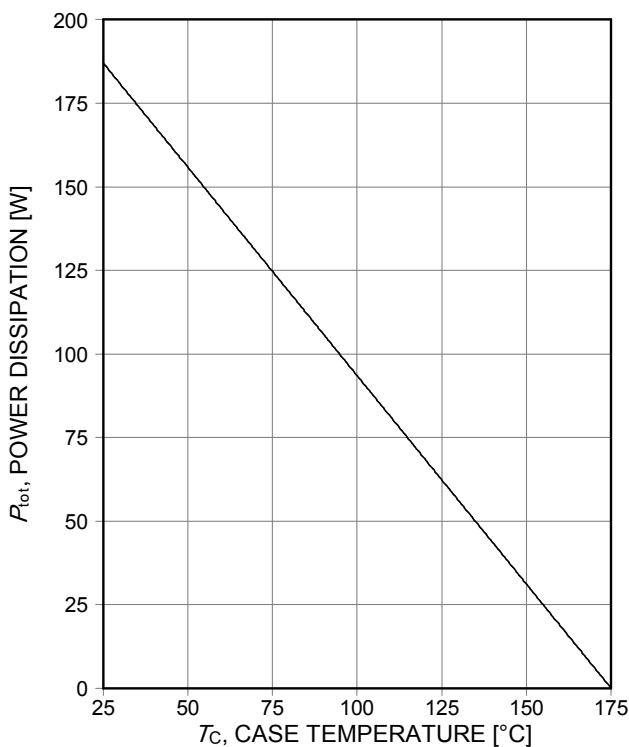

Figure 3. Power dissipation as a function of case temperature
 ($T_j \leq 175^\circ\text{C}$)

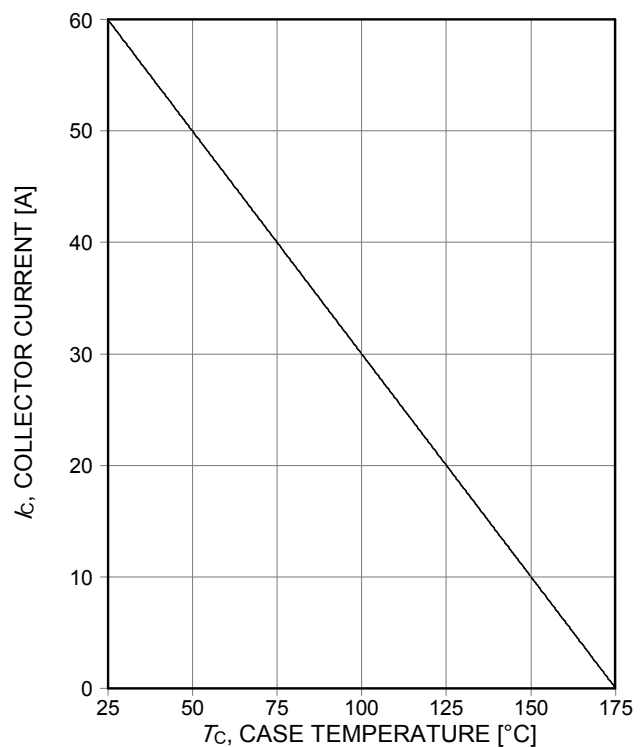

Figure 4. Collector current as a function of case temperature
 ($V_{GE} \geq 15\text{V}$, $T_j \leq 175^\circ\text{C}$)

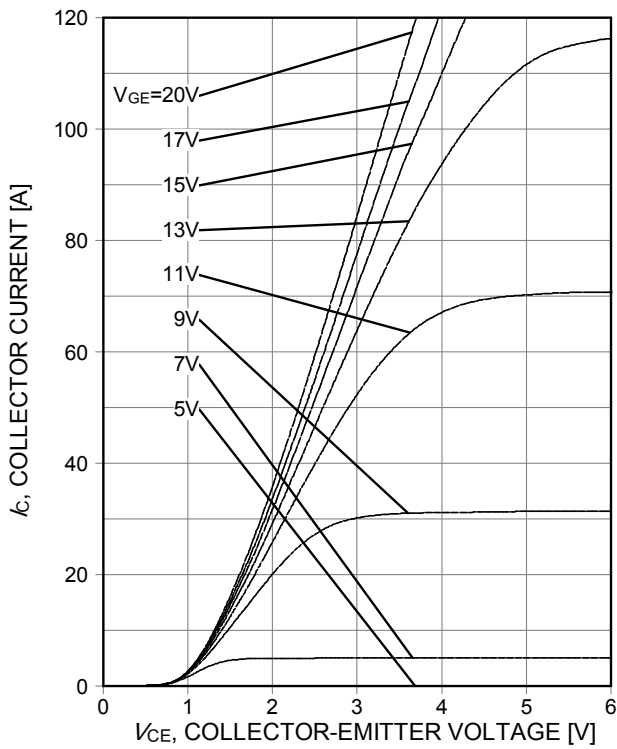

Figure 5. Typical output characteristic ($T_j=25^\circ\text{C}$)

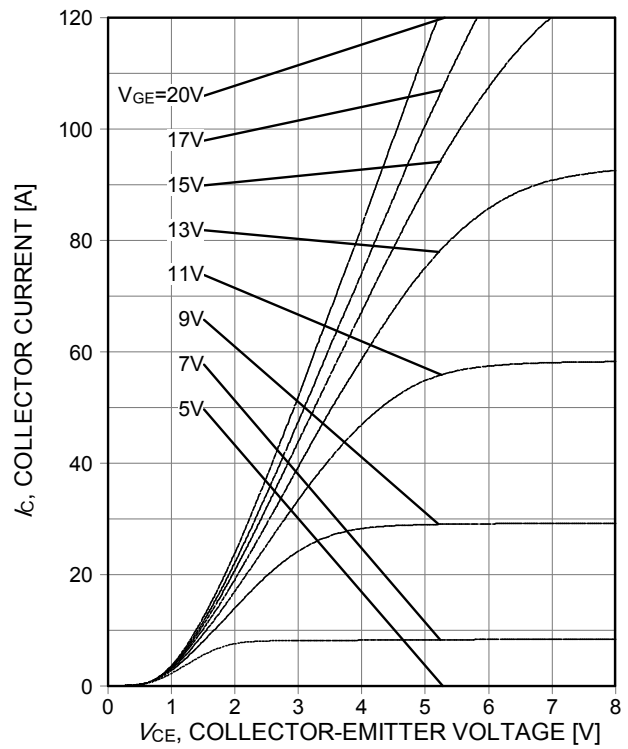

Figure 6. Typical output characteristic ($T_j=175^\circ\text{C}$)

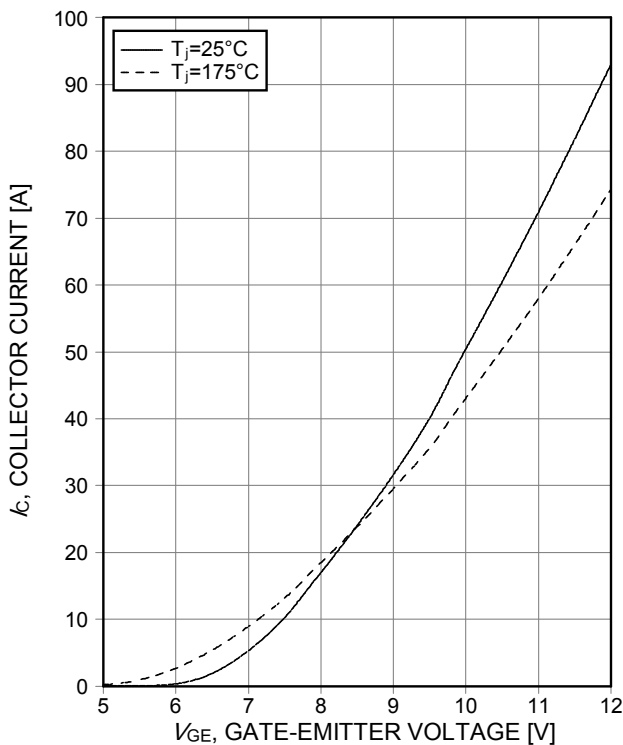

Figure 7. Typical transfer characteristic ($V_{CE}=20\text{V}$)

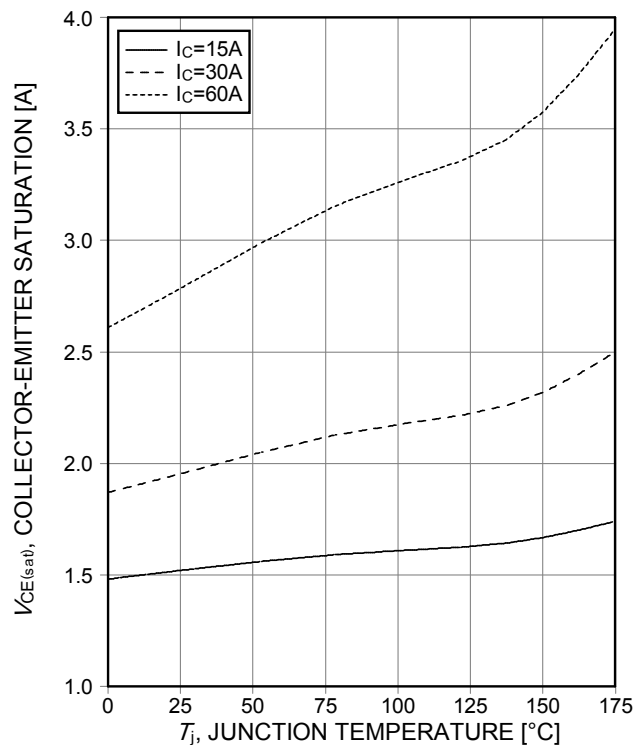

Figure 8. Typical collector-emitter saturation voltage as a function of junction temperature ($V_{GE}=15\text{V}$)

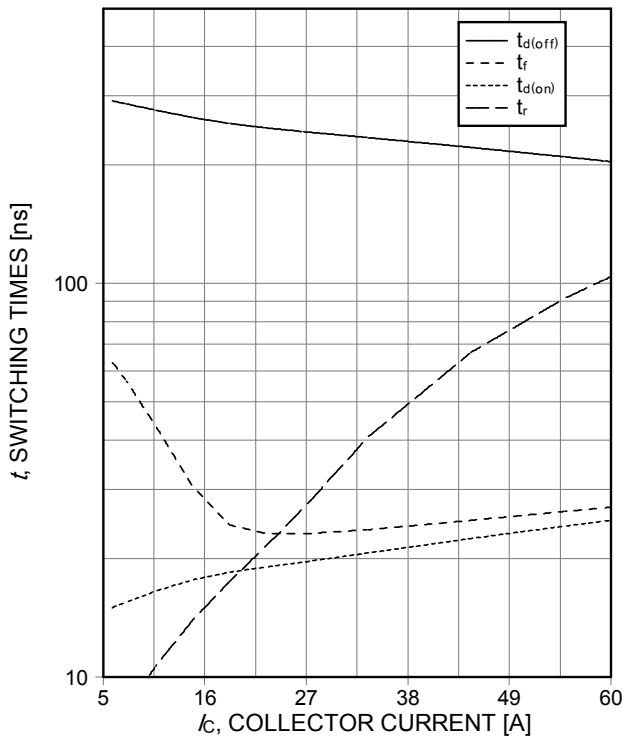

Figure 9. Typical switching times as a function of collector current
 (ind. load, $T_j=175^\circ\text{C}$, $V_{CE}=400\text{V}$, $V_{GE}=15/0\text{V}$, $R_G=10,5\Omega$, test circuit in Fig. E)

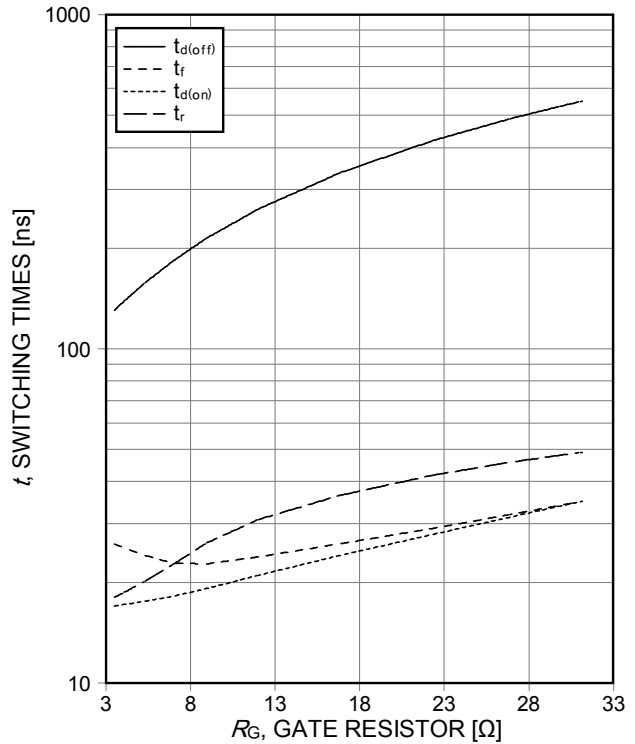

Figure 10. Typical switching times as a function of gate resistor
 (ind. load, $T_j=175^\circ\text{C}$, $V_{CE}=400\text{V}$, $V_{GE}=15/0\text{V}$, $I_C=30\text{A}$, test circuit in Fig. E)

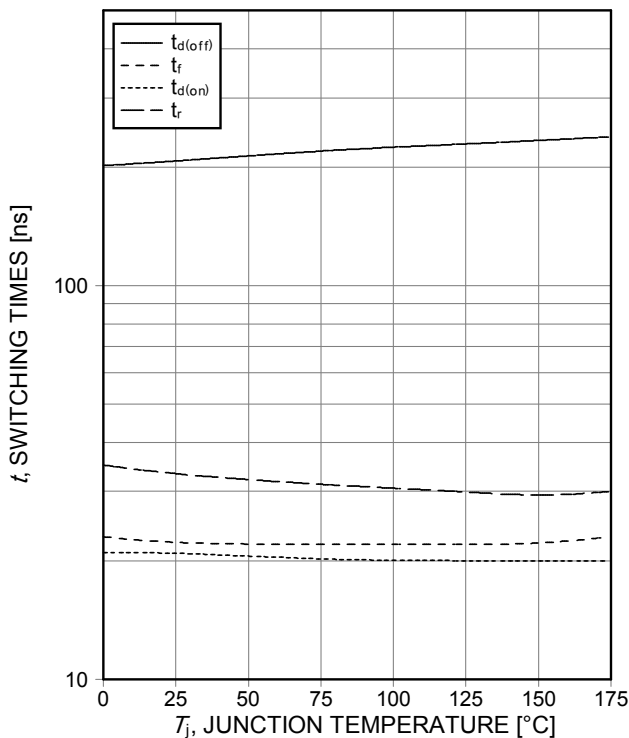

Figure 11. Typical switching times as a function of junction temperature
 (ind. load, $V_{CE}=400\text{V}$, $V_{GE}=15/0\text{V}$, $I_C=30\text{A}$, $R_G=10,5\Omega$, test circuit in Fig. E)

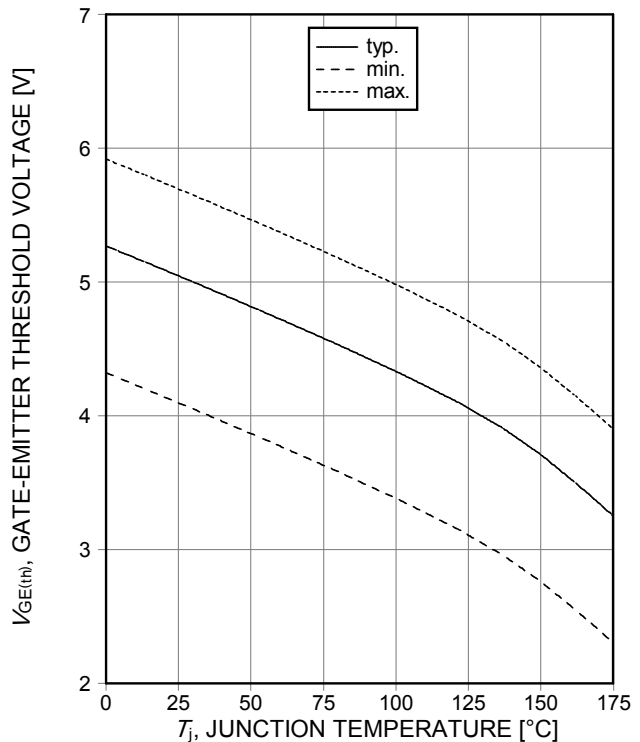

Figure 12. Gate-emitter threshold voltage as a function of junction temperature
 ($I_C=0.43\text{mA}$)

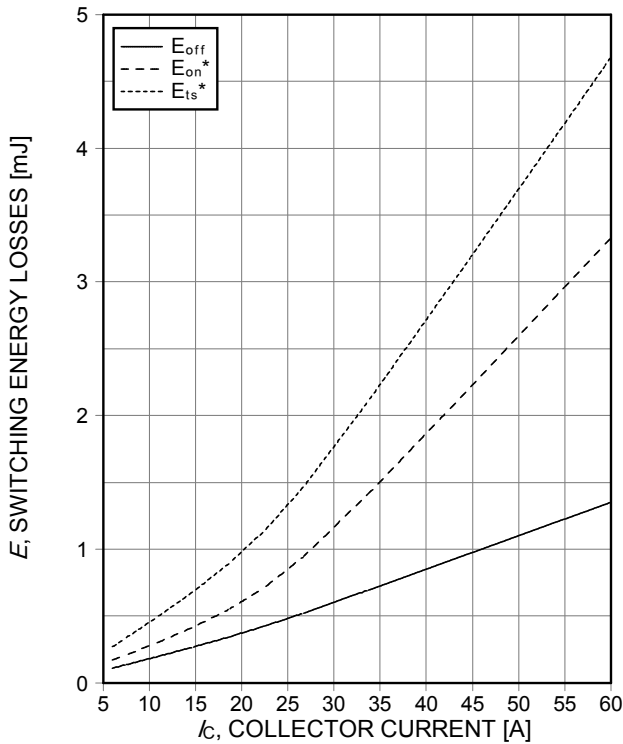

Figure 13. Typical switching energy losses as a function of collector current
 (ind. load, $T_j=175^\circ\text{C}$, $V_{CE}=400\text{V}$, $V_{GE}=15/0\text{V}$, $R_G=10,5\Omega$, test circuit in Fig. E)

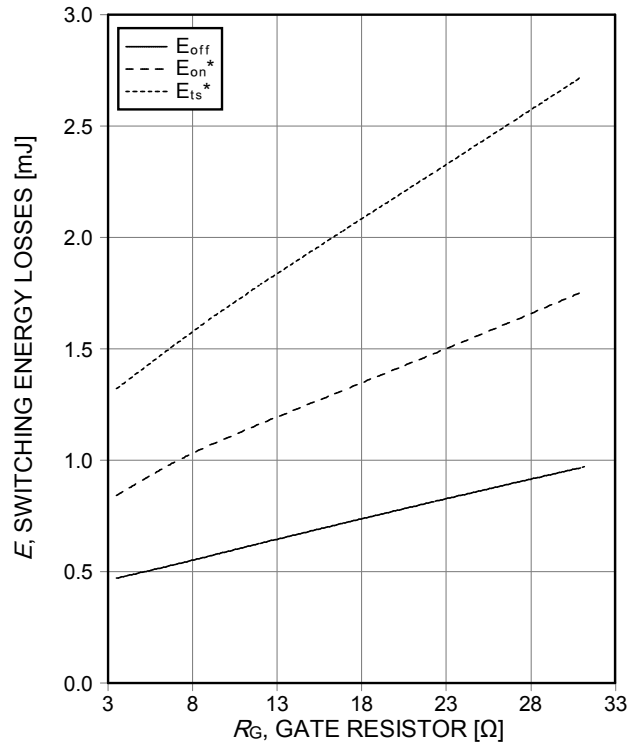

Figure 14. Typical switching energy losses as a function of gate resistor
 (ind. load, $T_j=175^\circ\text{C}$, $V_{CE}=400\text{V}$, $V_{GE}=15/0\text{V}$, $I_C=30\text{A}$, test circuit in Fig. E)

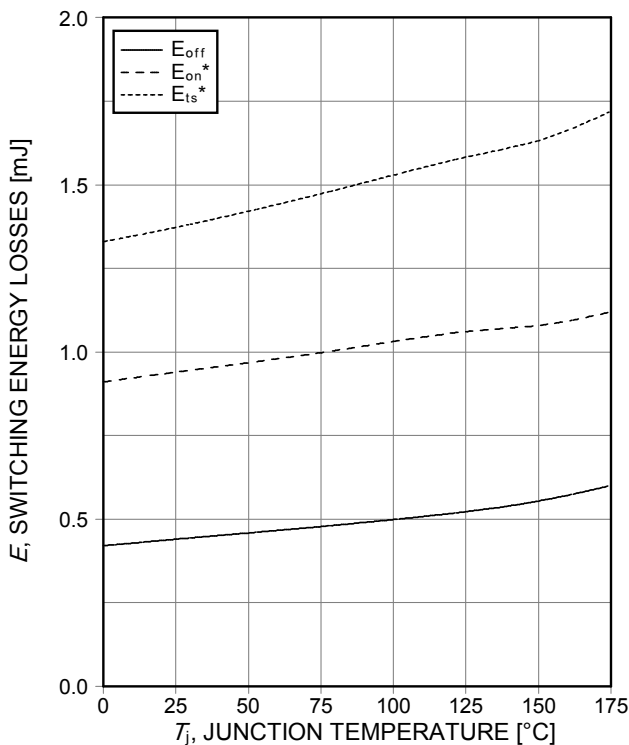

Figure 15. Typical switching energy losses as a function of junction temperature
 (ind load, $V_{CE}=400\text{V}$, $V_{GE}=15/0\text{V}$, $I_C=30\text{A}$, $R_G=10,5\Omega$, test circuit in Fig. E)

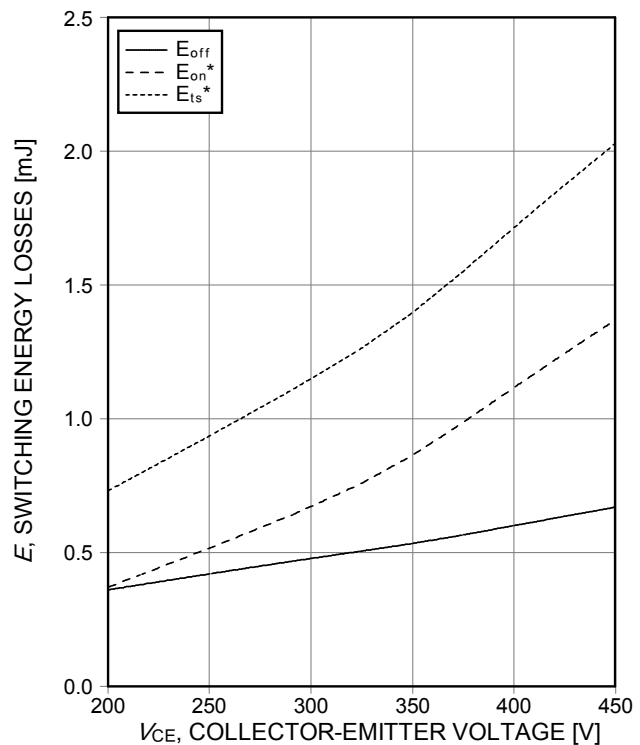

Figure 16. Typical switching energy losses as a function of collector emitter voltage
 (ind. load, $T_j=175^\circ\text{C}$, $V_{GE}=15/0\text{V}$, $I_C=30\text{A}$, $R_G=10,5\Omega$, test circuit in Fig. E)

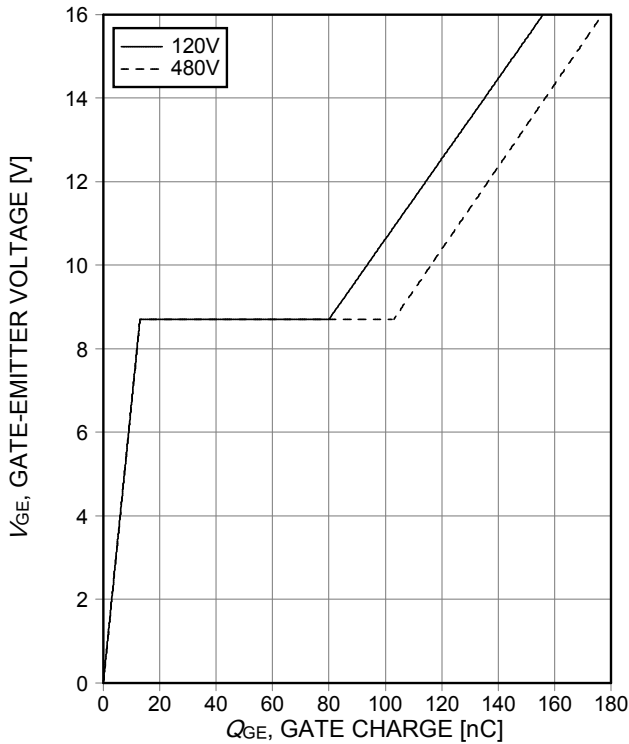

Figure 17. Typical gate charge
($I_C=30A$)

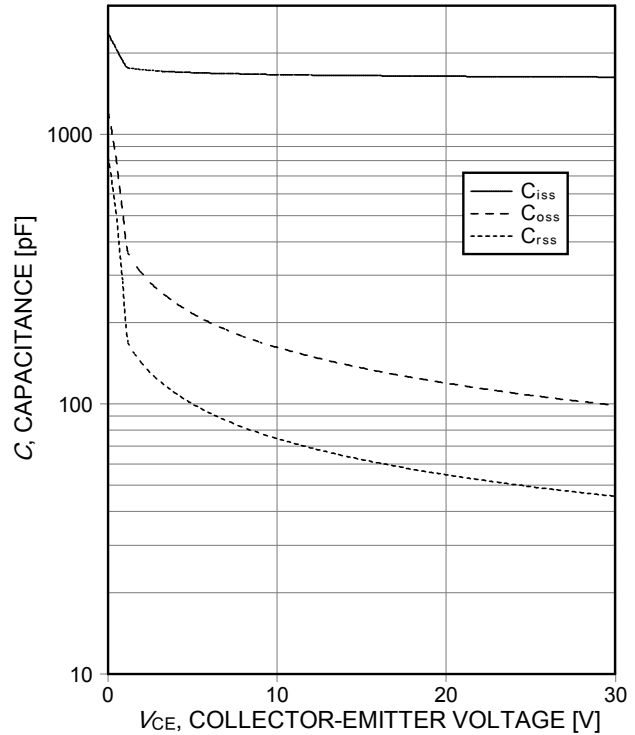

Figure 18. Typical capacitance as a function of collector-emitter voltage
($V_{GE}=0V$, $f=1MHz$)

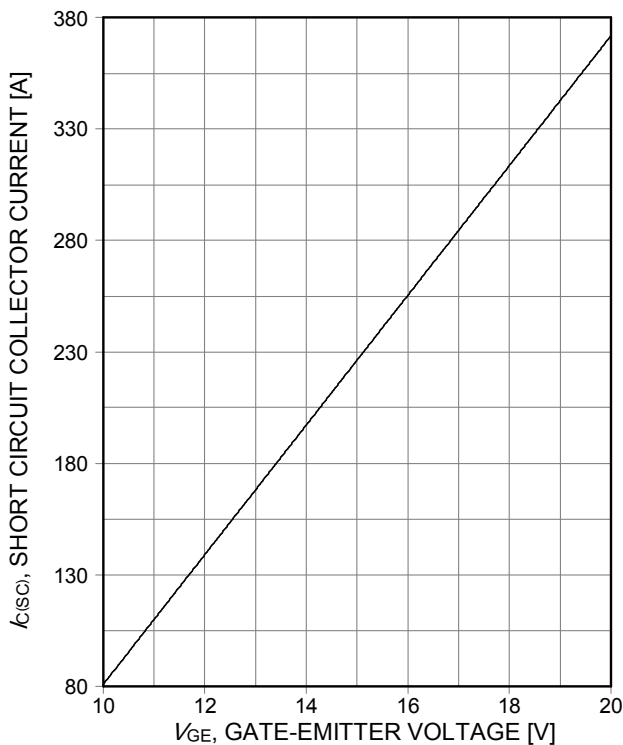

Figure 19. Typical short circuit collector current as a function of gate-emitter voltage
($V_{CE}\leq 400V$, start at $T_j=25^\circ C$)

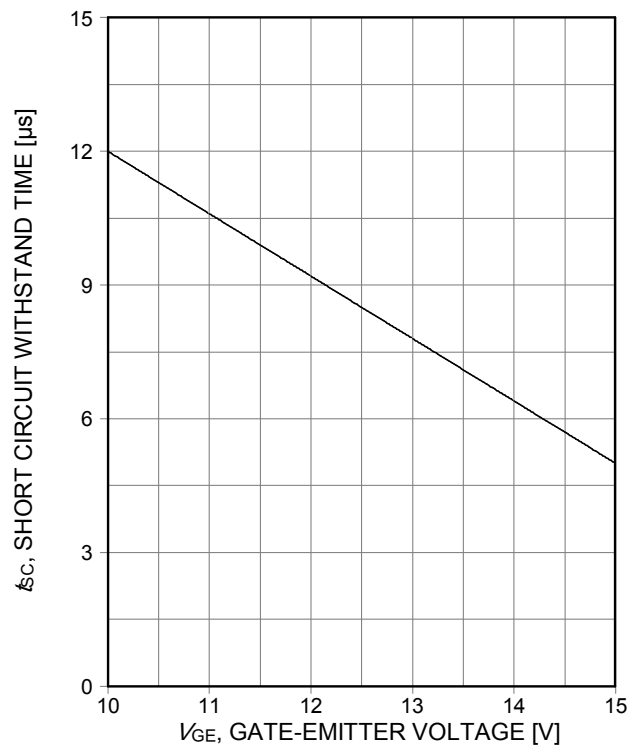

Figure 20. Short circuit withstand time as a function of gate-emitter voltage
($V_{CE}\leq 400V$, start at $T_j\leq 150^\circ C$)

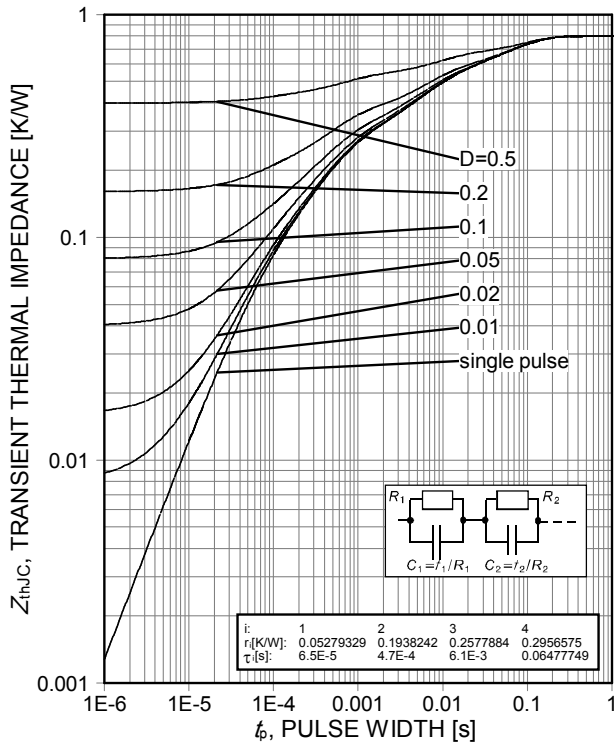
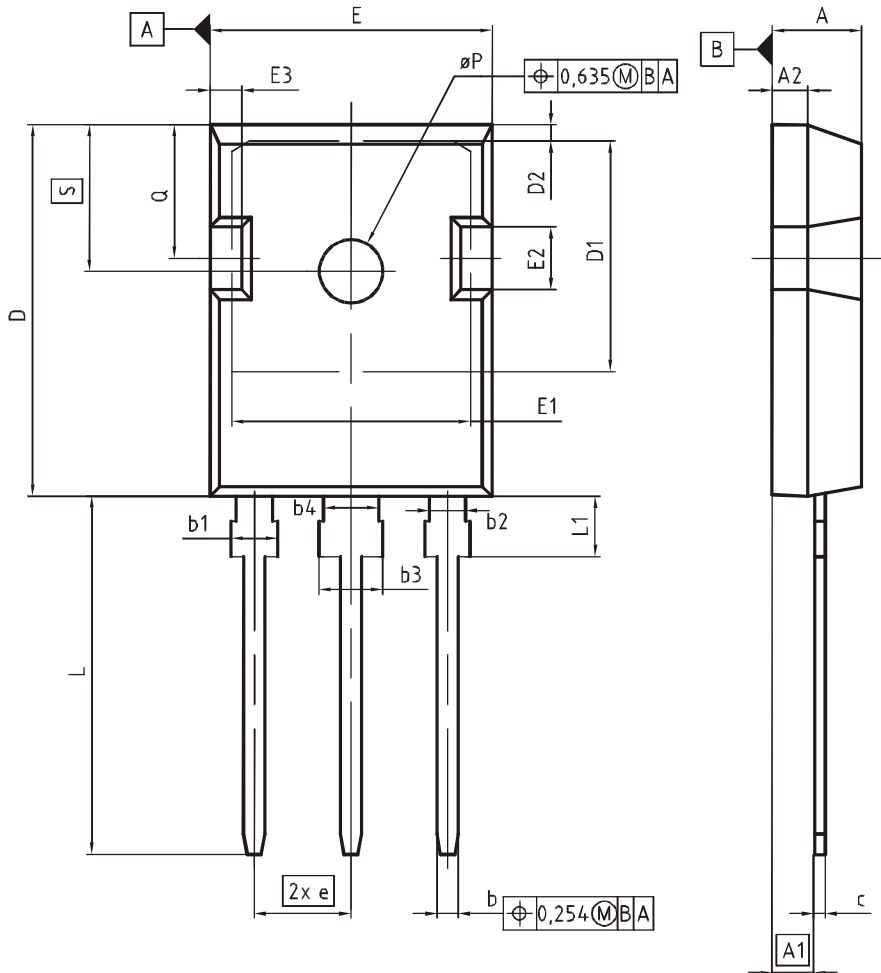

Figure 21. IGBT transient thermal impedance
($D = t_p/T$)

PG-TO247-3



DIM	MILLIMETERS		INCHES	
	MIN	MAX	MIN	MAX
A	4.83	5.21	0.190	0.205
A1	2.27	2.54	0.089	0.100
A2	1.85	2.16	0.073	0.085
b	1.07	1.33	0.042	0.052
b1	1.90	2.41	0.075	0.095
b2	1.90	2.16	0.075	0.085
b3	2.87	3.38	0.113	0.133
b4	2.87	3.13	0.113	0.123
c	0.55	0.68	0.022	0.027
D	20.80	21.10	0.819	0.831
D1	16.25	17.65	0.640	0.695
D2	0.95	1.35	0.037	0.053
E	15.70	16.13	0.618	0.635
E1	13.10	14.15	0.516	0.557
E2	3.68	5.10	0.145	0.201
E3	1.00	2.60	0.039	0.102
e	5.44 (BSC)		0.214 (BSC)	
N	3		3	
L	19.80	20.32	0.780	0.800
L1	4.10	4.47	0.161	0.176
ϕP	3.50	3.70	0.138	0.146
Q	5.49	6.00	0.216	0.236
S	6.04	6.30	0.238	0.248

DOCUMENT NO.
Z8B00003327

SCALE

EUROPEAN PROJECTION

ISSUE DATE
09-07-2010

REVISION
05

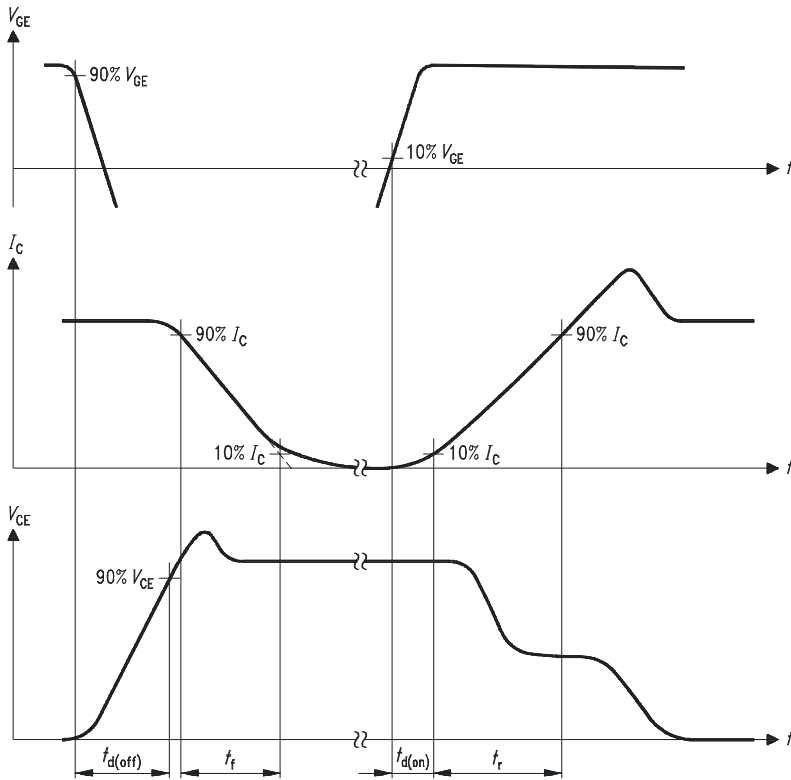

Figure A. Definition of switching times

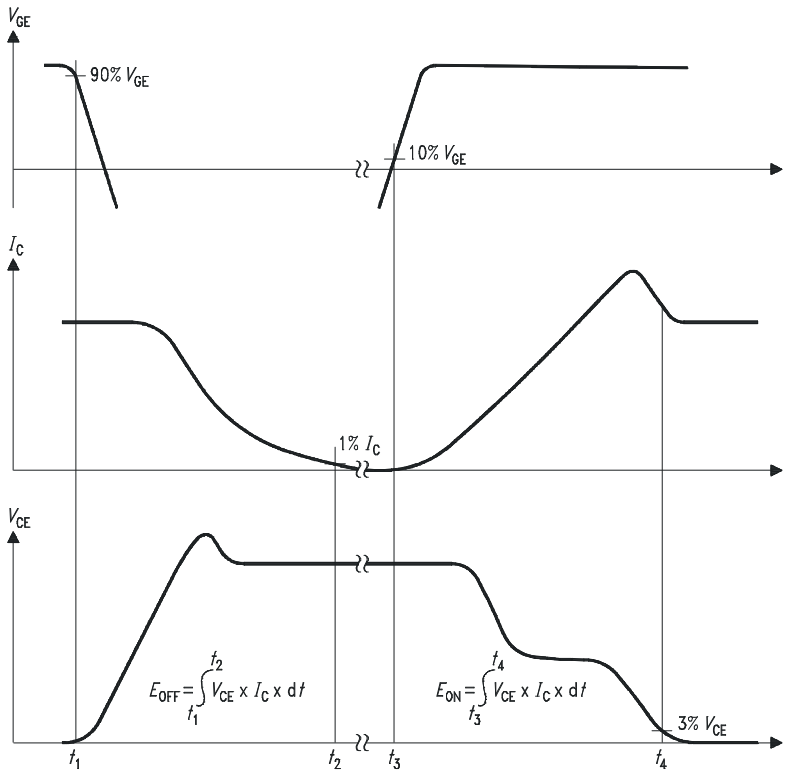

Figure B. Definition of switching losses

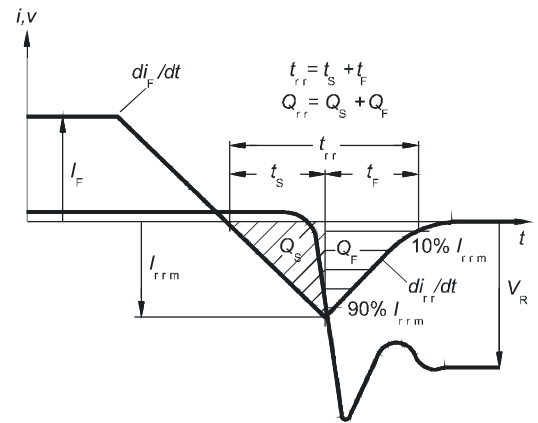

Figure C. Definition of diodes switching characteristics

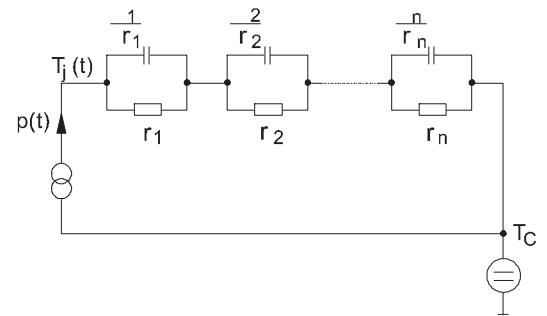

Figure D. Thermal equivalent circuit

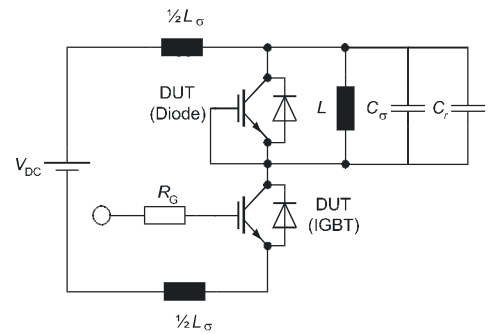

Figure E. Dynamic test circuit
Parasitic inductance L_{σ} ,
Parasitic capacitor C_{σ} ,
Relief capacitor C_r
(only for ZVT switching)

Revision History

IGW30N60H3

Revision: 2010-07-26, Rev. 1.1

Previous Revision

Revision	Date	Subjects (major changes since last revision)
1.1	-	Preliminary datasheet

We Listen to Your Comments

Any information within this document that you feel is wrong, unclear or missing at all ?

Your feedback will help us to continuously improve the quality of this document.

Please send your proposal (including a reference to this document) to: erratum@infineon.com

Published by**Infineon Technologies AG****81726 Munich, Germany****81726 München, Germany****© 2010 Infineon Technologies AG****All Rights Reserved.****Legal Disclaimer**

The information given in this document shall in no event be regarded as a guarantee of conditions or characteristics. With respect to any examples or hints given herein, any typical values stated herein and/or any information regarding the application of the device, Infineon Technologies hereby disclaims any and all warranties and liabilities of any kind, including without limitation, warranties of non-infringement of intellectual property rights of any third party.

Information

For further information on technology, delivery terms and conditions and prices, please contact the nearest Infineon Technologies Office (www.infineon.com).

Warnings

Due to technical requirements, components may contain dangerous substances. For information on the types in question, please contact the nearest Infineon Technologies Office. Infineon Technologies components may be used in life-support devices or systems only with the express written approval of Infineon Technologies, if a failure of such components can reasonably be expected to cause the failure of that life-support device or system or to affect the safety or effectiveness of that device or system. Life support devices or systems are intended to be implanted in the human body or to support and/or maintain and sustain and/or protect human life. If they fail, it is reasonable to assume that the health of the user or other persons may be endangered.



Стандарт Электрон Связь

Мы молодая и активно развивающаяся компания в области поставок электронных компонентов. Мы поставляем электронные компоненты отечественного и импортного производства напрямую от производителей и с крупнейших складов мира.

Благодаря сотрудничеству с мировыми поставщиками мы осуществляем комплексные и плановые поставки широчайшего спектра электронных компонентов.

Собственная эффективная логистика и склад в обеспечивает надежную поставку продукции в точно указанные сроки по всей России.

Мы осуществляем техническую поддержку нашим клиентам и предпродажную проверку качества продукции. На все поставляемые продукты мы предоставляем гарантию .

Осуществляем поставки продукции под контролем ВП МО РФ на предприятия военно-промышленного комплекса России , а также работаем в рамках 275 ФЗ с открытием отдельных счетов в уполномоченном банке. Система менеджмента качества компании соответствует требованиям ГОСТ ISO 9001.

Минимальные сроки поставки, гибкие цены, неограниченный ассортимент и индивидуальный подход к клиентам являются основой для выстраивания долгосрочного и эффективного сотрудничества с предприятиями радиоэлектронной промышленности, предприятиями ВПК и научно-исследовательскими институтами России.

С нами вы становитесь еще успешнее!

Наши контакты:

Телефон: +7 812 627 14 35

Электронная почта: sales@st-electron.ru

Адрес: 198099, Санкт-Петербург,
Промышленная ул, дом № 19, литера Н,
помещение 100-Н Офис 331