

PLEASE CHECK WWW.MOLEX.COM FOR LATEST PART INFORMATION

Part Number: [0757830152](#)
Status: **Active**
Overview: [ipass](#)
Description: 0.80mm (.031") Pitch, iPass™ I/O SMT Receptacle, Right Angle, Internal Application, 36 Circuit, 0.76µm (30µ") Gold (Au), Through Hole Shell, Universal Key

Documents:

[Drawing \(PDF\)](#) [RoHS Certificate of Compliance \(PDF\)](#)
[Product Specification PS-75783-001 \(PDF\)](#)

Agency Certification

CSA LR19980
 UL E29179

General

Product Family I/O Connectors
 Series [75783](#)
 Application Wire-to-Board
 Comments Positive or passive latching cable available
 Component Type Receptacle
 Overview [ipass](#)
 Product Name iPass™, PCI Express*, SAS, Serial ATA
 Type N/A

Physical

Boot Color N/A
 Circuits (Loaded) 36
 Circuits (maximum) 36
 Color - Resin Black
 Durability (mating cycles max) 25
 Flammability 94V-0
 Gender Receptacle
 Keying to Mating Part Yes
 Lock to Mating Part None
 Material - Metal Copper-Nickel-Zinc, High Performance Alloy (HPA)
 Material - Plating Mating Gold
 Material - Plating Termination Tin
 Material - Resin High Temperature Thermoplastic
 Number of Rows 2
 Orientation Right Angle
 PCB Locator Yes
 PCB Retention Yes
 PCB Thickness Recommended (in) 0.125 In
 PCB Thickness Recommended (mm) 3.18 mm
 Packaging Type Embossed Tape on Reel
 Panel Mount No
 Pitch - Mating Interface (in) 0.031 In
 Pitch - Mating Interface (mm) 0.80 mm
 Pitch - Term. Interface (in) 0.031 In
 Pitch - Term. Interface (mm) 0.80 mm
 Plating min: Mating (µin) 30.4
 Plating min: Mating (µm) 0.76
 Plating min: Termination (µin) 101.6
 Plating min: Termination (µm) 2.54
 Polarized to Mating Part Yes
 Polarized to PCB Yes

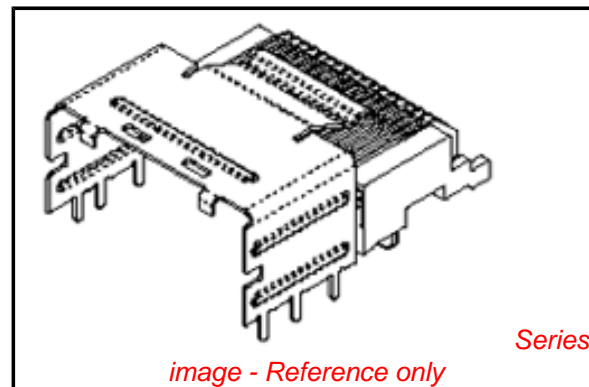

EU RoHS

**ELV and RoHS
 Compliant**
**REACH SVHC
 Contains SVHC: No**
**Halogen-Free
 Status**

China RoHS



**Need more information on product
 environmental compliance?**

Email productcompliance@molex.com
 For a multiple part number RoHS Certificate of Compliance, [click here](#)

Please visit the [Contact Us](#) section for any non-product compliance questions.

Search Parts in this Series

[75783Series](#)

Mates With

iPass™ Cable Assemblies, [79575](#) , [79576](#) , [74562](#) , [74563](#) , [79536](#) , [74573](#) , [74569](#) , [74586](#)

Ports	1
Surface Mount Compatible (SMC)	Yes
Temperature Range - Operating	-40°C to +80°C
Termination Interface: Style	Surface Mount
Waterproof / Dustproof	No
Wire Insulation Diameter	N/A
Wire Size AWG	N/A

Electrical

Current - Maximum per Contact	0.5A
Grounding to Panel	None
Shield Type	Full Shield
Shielded	Yes
Voltage - Maximum	30V AC (RMS)/DC

Material Info

Reference - Drawing Numbers

Application Specification	AS-75783-001
Packaging Specification	PK-75783-001
Product Specification	PS-75783-001
Sales Drawing	SD-75783-001

This document was generated on 05/28/2010

PLEASE CHECK WWW.MOLEX.COM FOR LATEST PART INFORMATION

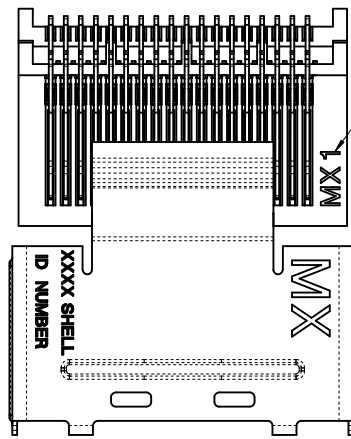

MOLD CAVITY ID
FOR REFERENCE ONLY

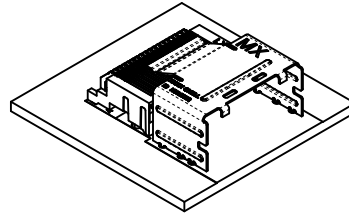

NOTES:

- MATERIAL:
CONNECTOR:
HOUSING - HIGH TEMPERATURE THERMOPLASTIC GLASS FILLED, UL 94V-0, BLACK
TERMINALS - COPPER ALLOY
SHELL
SILVER NICKEL, C770, THICKNESS: 0.250/0.254
- FINISH:
CONNECTOR
OPTION 1
CONTACT AREA - 0.38µm MIN GOLD OVER 2.54 µm NICKEL
SOLDER FOOT AREA - 2.54-5.09µm TIN OVER 1.27 µm NICKEL
OPTION 2
CONTACT AREA - 0.76µm MIN GOLD OVER 2.54 µm NICKEL
SOLDER FOOT AREA - 2.54-5.09µm TIN OVER 1.27 µm NICKEL
- TERMINAL SOLDER FEET TO BE COPLANAR WITHIN 0.10 MEASURED FROM FRONT HOUSING STAND OFF (DATUM C)
- DATE CODE: 4 DIGIT (3 DIGIT DAY, 1 DIGIT YEAR) CONNECTOR ONLY
- CIRCUIT IDENTIFIER: SEE APPROPRIATE INDUSTRY SPECIFICATION FOR LOCATION OF PIN 1.
- TO BE USED WITH THE FOLLOWING CABLE SERIES:
79575/74563/79576/74573/79536/74562/74569/74586
- PACKAGED PER PACKAGING SPECIFICATION: PK-75783-001
- CONFORMS TO PRODUCT SPECIFICATION: PS-75783-001
- PROCESS PER APPLICATION SPECIFICATION: AS-75783-001
- THIS PART CONFORMS TO CLASS C REQUIREMENTS OF COSMETIC SPEC PS-45499-002

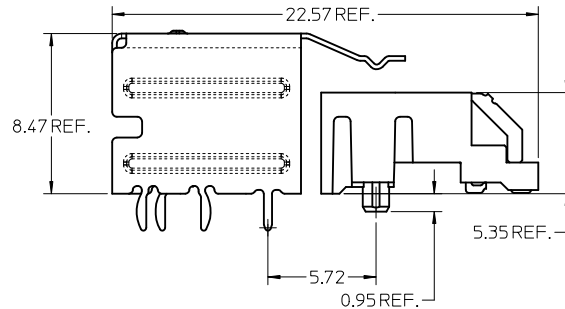
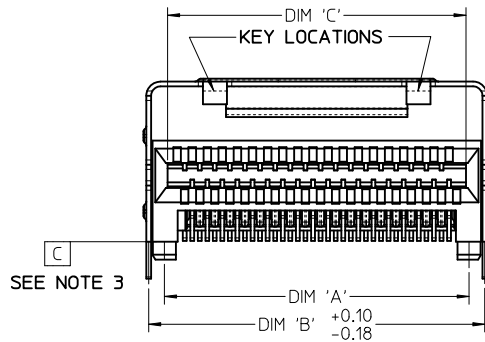

36 CIRCUIT
RETENTION FIT
SHELL OPTION SHOWN

CIRCUIT SIZE	DIM 'A'	DIM 'B'	DIM 'C'
26	12.00	13.80	11.80
36	16.00	17.80	15.80
50	21.60	23.40	21.40
68	28.80	30.60	28.60

GEOMETRY UPDATE EC NO: UCP2010-1913 DRW:KLANG 2010/02/03 CHKD:JSWENSON 2010/03/24 APPR:MBANAKIS 2010/03/25	REV1	DESCRIPTION
	D1	

QUALITY SYMBOLS	▽=0
	▽=0

GENERAL TOLERANCES (UNLESS SPECIFIED)	
	mm INCH
4 PLACES	± 0.13 ± 0.005
3 PLACES	± 0.25 ± 0.010
2 PLACES	± 0.38 ± 0.015
1 PLACE	± 0.51 ± 0.020
ANGULAR ±1/2°	
DRAFT WHERE APPLICABLE MUST REMAIN WITHIN DIMENSIONS	

DIMENSION STYLE MM ONLY	
DRAWN BY	DATE
KLANG	02/09/05
CHECKED BY	DATE
JSWENSON	02/09/05
APPROVED BY	DATE
MBANAKIS	02/02/05
MATERIAL NO.	DOCUMENT NO.
SEE CHART	SD-75783-001

SCALE 5:1	DESIGN UNITS METRIC	THIRD ANGLE PROJECTION
TITLE I-PASS R/A CONNECTOR INTERNAL ASSY W/SHELL 0.8MM PITCH I/O		
MOLEX INCORPORATED		
SHEET NO. 1 OF 12		

ASSEMBLY WITH PRE-POSITION DEVICE

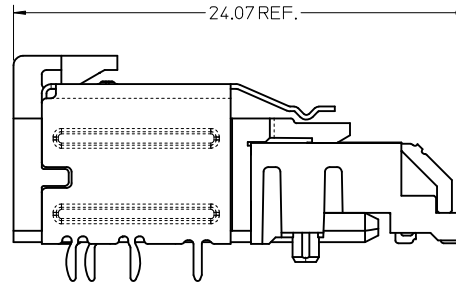
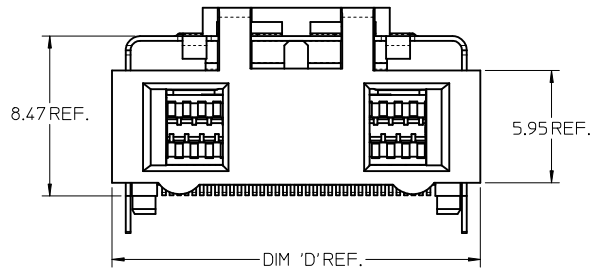
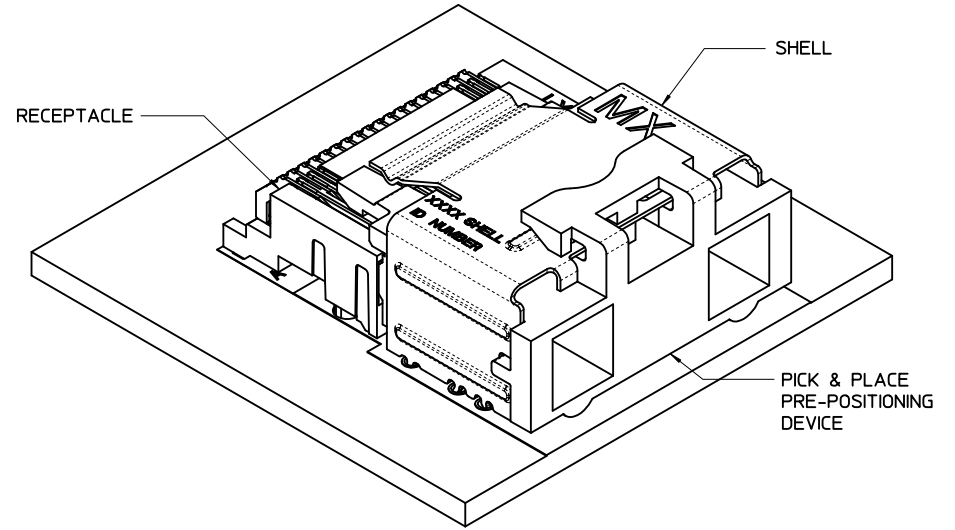
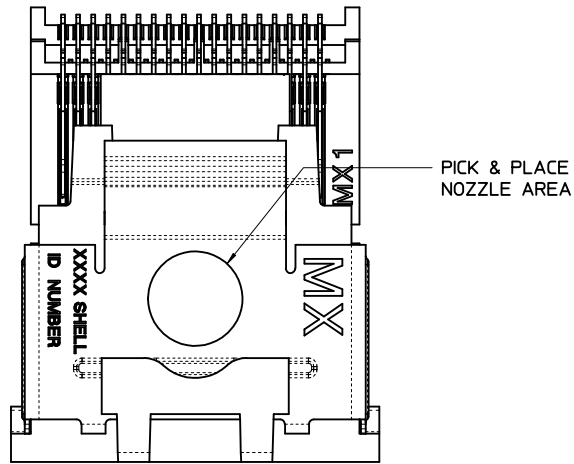

36 CIRCUIT RETENTION-FIT SHELL OPTION SHOWN

NOTES:

1. PICK AND PLACE AREA DEFINED IN APPLICATION SPECIFICATION, AS-75783-001
2. PACKAGING CONSISTS OF CONNECTOR AND SHELL WITH A PRE-POSITIONING PICK AND PLACE DEVICE THAT ARE PACKAGED IN "TAPE AND REEL" FOR ROBOTIC PICK AND PLACE.

iPass™ IS A TRADEMARK OF MOLEX

CIRCUIT SIZE	DIM 'D'
26	15.50
36	19.50
50	25.10
68	32.30

SEE SHEET 1 EC NO: UCP2010-1913 DRW:KLANG 2010/02/03 CHKD:JWENSON 2010/03/24 APPR:MBANAKIS 2010/03/25	QUALITY SYMBOLS ▽=0 ▽=0	GENERAL TOLERANCES (UNLESS SPECIFIED) <table border="1"> <thead> <tr> <th></th> <th>mm</th> <th>INCH</th> </tr> </thead> <tbody> <tr> <td>4 PLACES</td> <td>± .---</td> <td>± .---</td> </tr> <tr> <td>3 PLACES</td> <td>± .---</td> <td>± .---</td> </tr> <tr> <td>2 PLACES</td> <td>± 0.13</td> <td>± .---</td> </tr> <tr> <td>1 PLACE</td> <td>± 0.25</td> <td>± .---</td> </tr> </tbody> </table> ANGULAR ±1/2°		mm	INCH	4 PLACES	± .---	± .---	3 PLACES	± .---	± .---	2 PLACES	± 0.13	± .---	1 PLACE	± 0.25	± .---	DIMENSION STYLE MM ONLY	SCALE 5:1	DESIGN UNITS METRIC	THIRD ANGLE PROJECTION
		mm	INCH																		
	4 PLACES	± .---	± .---																		
	3 PLACES	± .---	± .---																		
2 PLACES	± 0.13	± .---																			
1 PLACE	± 0.25	± .---																			
DRAWN BY KLANG	DATE 02/09/05	CHECKED BY JWENSON	DATE 02/09/05	TITLE I-PASS R/A CONNECTOR INTERNAL ASSY W/SHELL 0.8MM PITCH I/O																	
APPROVED BY MBANAKIS	DATE 02/02/05	MATERIAL NO. SEE CHART			DOCUMENT NO. SD-75783-001	SHEET NO. 2 OF 12															
DRAFT WHERE APPLICABLE MUST REMAIN WITHIN DIMENSIONS						THIS DRAWING CONTAINS INFORMATION THAT IS PROPRIETARY TO MOLEX INCORPORATED AND SHOULD NOT BE USED WITHOUT WRITTEN PERMISSION															

SHELL PCB INTERFACE

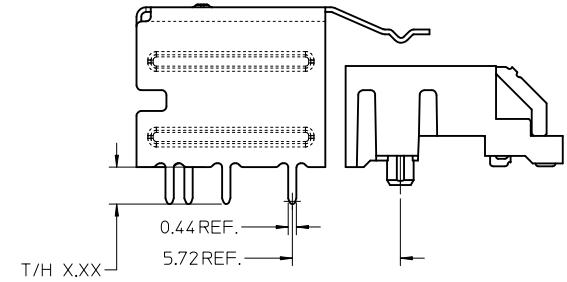
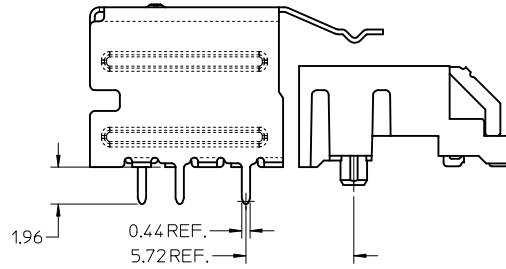
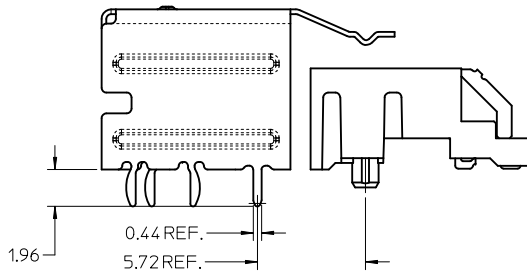
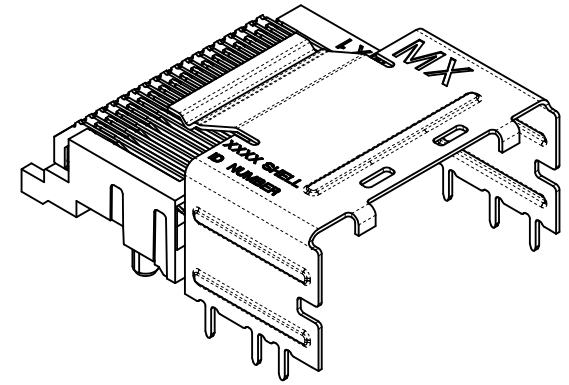
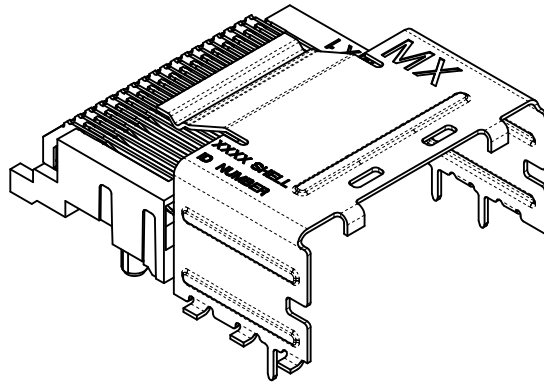
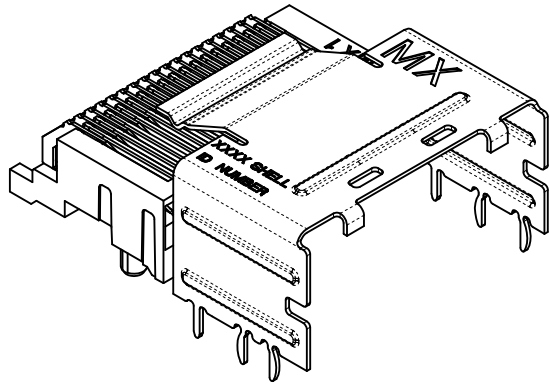

RETENTION-FIT SHELL OPTION

SMT SHELL OPTION

THRU-HOLE SHELL OPTION
SEE TABLE FOR LENGTH
(X.XX DENOTES TAIL LENGTH)

RECOMMENDED PCB THICKNESS
FOR SPECIFIED TAIL LENGTH

TAIL LENGTH	PCB THICKNESS
1.96	1.57 (.062)
2.79	2.36 (.093)
3.18	2.79 (.110)
3.56	3.18 (.125)

NOTE:
RETENTION FIT DENOTES TAILS THAT OFFER RETENTION TO PCB DURING REFLOW PROCESS
SMT DENOTES SURFACE MOUNT TERMINATION
T/H X.XX DENOTES THRU-HOLE TAIL OF LENGTH X.XX

iPass™ IS A TRADEMARK OF MOLEX

SEE SHEET 1 EC NO: UCP2010-1913 DRW:KLANG 2010/02/03 CHKD:JSWENSON 2010/03/24 APPR:MBANAKIS 2010/03/25	QUALITY SYMBOLS	GENERAL TOLERANCES (UNLESS SPECIFIED)	DIMENSION STYLE	SCALE	DESIGN UNITS	THIRD ANGLE PROJECTION
	▼=0 ▽=0		MM ONLY	5:1	METRIC	
	DESCRIPTION	4 PLACES ± --- ± --- 3 PLACES ± --- ± --- 2 PLACES ± 0.13 ± --- 1 PLACE ± 0.25 ± ---	mm INCH DRAWN BY DATE KLANG 02/09/05 CHECKED BY DATE JSWENSON 02/09/05 APPROVED BY DATE MBANAKIS 02/02/05	TITLE		I-PASS R/A CONNECTOR INTERNAL ASSY W/SHELL 0.8MM PITCH I/O
		ANGULAR ±1/2° DRAFT WHERE APPLICABLE MUST REMAIN WITHIN DIMENSIONS	MATERIAL NO. SEE CHART SIZE C	MOLEX INCORPORATED DOCUMENT NO. SD-75783-001	SHEET NO. 3 OF 12	

KEYING OPTIONS

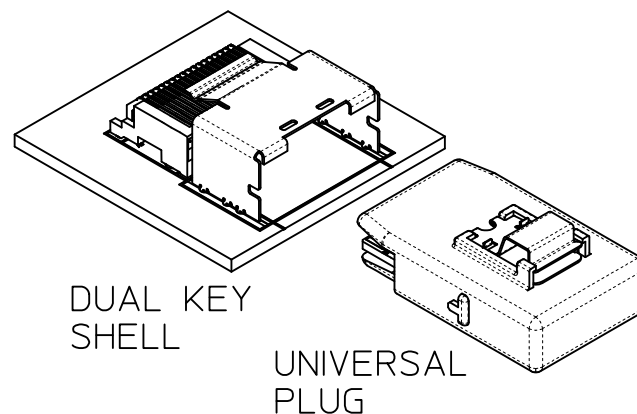
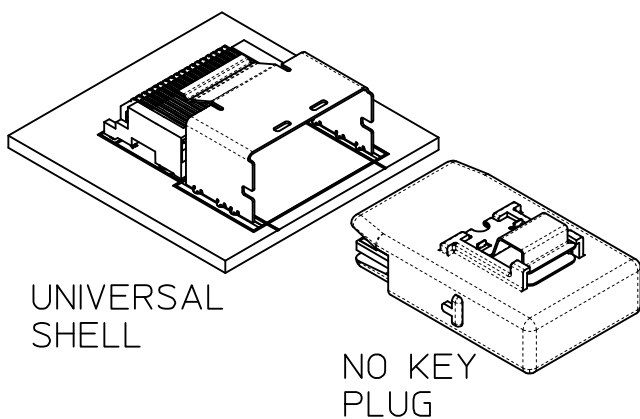
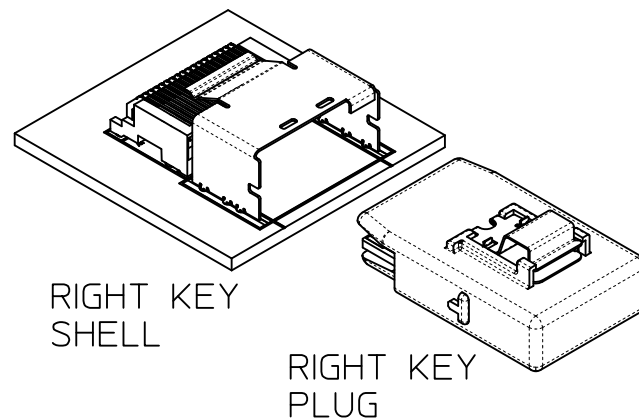
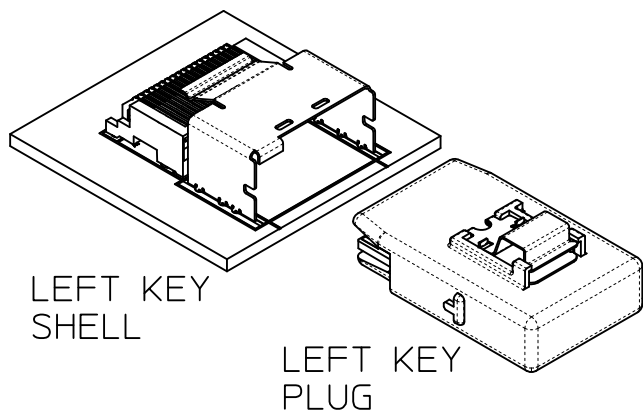

	UNIVERSAL SHELL	LEFT KEY SHELL	RIGHT KEY SHELL	DUAL KEY SHELL
NO KEY PLUG	YES	NO	NO	NO
LEFT KEY PLUG	YES	YES	NO	NO
RIGHT KEY PLUG	YES	NO	YES	NO
UNIVERSAL PLUG	YES	YES	YES	YES

SEE SHEET 1 EC NO: UCP2010-1913 DRW:KLANG 2010/02/03 CHKD:JWENSON 2010/03/24 APPR:MBANAKIS 2010/03/25	QUALITY SYMBOLS	▽=0
		▽=0
	DESCRIPTION	
	REV	D1

GENERAL TOLERANCES (UNLESS SPECIFIED)	mm	INCH
4 PLACES	± .---	± .---
3 PLACES	± .---	± .---
2 PLACES	± 0.13	± .---
1 PLACE	± 0.25	± .---
ANGULAR ±1/2°		
DRAFT WHERE APPLICABLE MUST REMAIN WITHIN DIMENSIONS		

DIMENSION STYLE MM ONLY	
DRAWN BY KLANG	DATE 02/09/05
CHECKED BY JWENSON	DATE 02/09/05
APPROVED BY MBANAKIS	DATE 02/02/05
MATERIAL NO. SEE CHART	
SIZE C	

SCALE 2:1	DESIGN UNITS METRIC	THIRD ANGLE PROJECTION
I-PASS R/A CONNECTOR INTERNAL ASSY W/SHELL 0.8MM PITCH I/O		
MOLEX INCORPORATED		
DOCUMENT NO. SD-75783-001	SHEET NO. 4 OF 12	
THIS DRAWING CONTAINS INFORMATION THAT IS PROPRIETARY TO MOLEX INCORPORATED AND SHOULD NOT BE USED WITHOUT WRITTEN PERMISSION		

iPass™ IS A TRADEMARK OF MOLEX

26 CIRCUIT ITEM NUMBERS

CIRCUIT SIZE	ITEM NUMBER	PLATING OPTION	SHELL PCB OPTION	SHELL KEY OPTION
26	75783-0007	OPTION 1	RETENTION	LEFT
26	75783-0008	OPTION 1	RETENTION	RIGHT
26	75783-0009	OPTION 1	RETENTION	DUAL
26	75783-0010	OPTION 1	SMT	LEFT
26	75783-0011	OPTION 1	SMT	RIGHT
26	75783-0012	OPTION 1	SMT	DUAL
26	75783-0019	OPTION 2	RETENTION	LEFT
26	75783-0020	OPTION 2	RETENTION	RIGHT
26	75783-0021	OPTION 2	RETENTION	DUAL
26	75783-0022	OPTION 2	SMT	LEFT
26	75783-0023	OPTION 2	SMT	RIGHT
26	75783-0024	OPTION 2	SMT	DUAL
26	75783-0025	OPTION 1	RETENTION	UNIVERSAL
26	75783-0026	OPTION 1	SMT	UNIVERSAL
26	75783-0027	OPTION 2	RETENTION	UNIVERSAL
26	75783-0028	OPTION 2	SMT	UNIVERSAL
26	75783-0029	OPTION 1	T/H 1.96	LEFT
26	75783-0030	OPTION 1	T/H 1.96	RIGHT
26	75783-0031	OPTION 1	T/H 1.96	DUAL
26	75783-0032	OPTION 1	T/H 1.96	UNIVERSAL
26	75783-0033	OPTION 2	T/H 1.96	LEFT
26	75783-0034	OPTION 2	T/H 1.96	RIGHT
26	75783-0035	OPTION 2	T/H 1.96	DUAL
26	75783-0036	OPTION 2	T/H 1.96	UNIVERSAL

CIRCUIT SIZE	ITEM NUMBER	PLATING OPTION	SHELL PCB OPTION	SHELL KEY OPTION
26	75783-0037	OPTION 1	T/H 2.79	LEFT
26	75783-0038	OPTION 1	T/H 2.79	RIGHT
26	75783-0039	OPTION 1	T/H 2.79	DUAL
26	75783-0040	OPTION 1	T/H 2.79	UNIVERSAL
26	75783-0041	OPTION 2	T/H 2.79	LEFT
26	75783-0042	OPTION 2	T/H 2.79	RIGHT
26	75783-0043	OPTION 2	T/H 2.79	DUAL
26	75783-0044	OPTION 2	T/H 2.79	UNIVERSAL
26	75783-0045	OPTION 1	T/H 3.18	LEFT
26	75783-0046	OPTION 1	T/H 3.18	RIGHT
26	75783-0047	OPTION 1	T/H 3.18	DUAL
26	75783-0048	OPTION 1	T/H 3.18	UNIVERSAL
26	75783-0049	OPTION 2	T/H 3.18	LEFT
26	75783-0050	OPTION 2	T/H 3.18	RIGHT
26	75783-0051	OPTION 2	T/H 3.18	DUAL
26	75783-0052	OPTION 2	T/H 3.18	UNIVERSAL

iPass™ IS A TRADEMARK OF MOLEX

SEE SHEET 1 EC NO: UCP2010-1913 DRW:KLANG 2010/02/03 CHKD:JSWENSON 2010/03/24 APPR:MBANAKIS 2010/03/25	DESCRIPTION REV: D1	QUALITY SYMBOLS ▽=0 ▽=0	GENERAL TOLERANCES (UNLESS SPECIFIED) <table border="1"> <tr> <th></th> <th>mm</th> <th>INCH</th> </tr> <tr> <td>4 PLACES</td> <td>± ---</td> <td>± ---</td> </tr> <tr> <td>3 PLACES</td> <td>± ---</td> <td>± ---</td> </tr> <tr> <td>2 PLACES</td> <td>± 0.13</td> <td>± ---</td> </tr> <tr> <td>1 PLACE</td> <td>± 0.25</td> <td>± ---</td> </tr> </table> ANGULAR ±1/2°		mm	INCH	4 PLACES	± ---	± ---	3 PLACES	± ---	± ---	2 PLACES	± 0.13	± ---	1 PLACE	± 0.25	± ---	DIMENSION STYLE MM ONLY DRAWN BY: KLANG DATE: 02/09/05 CHECKED BY: JSWENSON DATE: 02/09/05 APPROVED BY: MBANAKIS DATE: 02/02/05	SCALE: 2:1 DESIGN UNITS: METRIC THIRD ANGLE PROJECTION	TITLE: I-PASS R/A CONNECTOR INTERNAL ASSY W/SHELL 0.8MM PITCH I/O
			mm	INCH																	
		4 PLACES	± ---	± ---																	
		3 PLACES	± ---	± ---																	
2 PLACES	± 0.13	± ---																			
1 PLACE	± 0.25	± ---																			
DRAFT WHERE APPLICABLE MUST REMAIN WITHIN DIMENSIONS			MATERIAL NO. SEE CHART	DOCUMENT NO. SD-75783-001	SHEET NO. 5 OF 12																
THIS DRAWING CONTAINS INFORMATION THAT IS PROPRIETARY TO MOLEX INCORPORATED AND SHOULD NOT BE USED WITHOUT WRITTEN PERMISSION																					

36 CIRCUIT ITEM NUMBERS

CIRCUIT SIZE	ITEM NUMBER	PLATING OPTION	SHELL PCB OPTION	SHELL KEY OPTION
36	75783-0107	OPTION 1	RETENTION	LEFT
36	75783-0108	OPTION 1	RETENTION	RIGHT
36	75783-0109	OPTION 1	RETENTION	DUAL
36	75783-0110	OPTION 1	SMT	LEFT
36	75783-0111	OPTION 1	SMT	RIGHT
36	75783-0112	OPTION 1	SMT	DUAL
36	75783-0119	OPTION 2	RETENTION	LEFT
36	75783-0120	OPTION 2	RETENTION	RIGHT
36	75783-0121	OPTION 2	RETENTION	DUAL
36	75783-0122	OPTION 2	SMT	LEFT
36	75783-0123	OPTION 2	SMT	RIGHT
36	75783-0124	OPTION 2	SMT	DUAL
36	75783-0125	OPTION 1	RETENTION	UNIVERSAL
36	75783-0126	OPTION 1	SMT	UNIVERSAL
36	75783-0127	OPTION 2	RETENTION	UNIVERSAL
36	75783-0128	OPTION 2	SMT	UNIVERSAL
36	75783-0129	OPTION 1	T/H 1.96	LEFT
36	75783-0130	OPTION 1	T/H 1.96	RIGHT
36	75783-0131	OPTION 1	T/H 1.96	DUAL
36	75783-0132	OPTION 1	T/H 1.96	UNIVERSAL
36	75783-0133	OPTION 2	T/H 1.96	LEFT
36	75783-0134	OPTION 2	T/H 1.96	RIGHT
36	75783-0135	OPTION 2	T/H 1.96	DUAL
36	75783-0136	OPTION 2	T/H 1.96	UNIVERSAL

CIRCUIT SIZE	ITEM NUMBER	PLATING OPTION	SHELL PCB OPTION	SHELL KEY OPTION
36	75783-0137	OPTION 1	T/H 2.79	LEFT
36	75783-0138	OPTION 1	T/H 2.79	RIGHT
36	75783-0139	OPTION 1	T/H 2.79	DUAL
36	75783-0140	OPTION 1	T/H 2.79	UNIVERSAL
36	75783-0141	OPTION 2	T/H 2.79	LEFT
36	75783-0142	OPTION 2	T/H 2.79	RIGHT
36	75783-0143	OPTION 2	T/H 2.79	DUAL
36	75783-0144	OPTION 2	T/H 2.79	UNIVERSAL
36	75783-0145	OPTION 1	T/H 3.18	LEFT
36	75783-0146	OPTION 1	T/H 3.18	RIGHT
36	75783-0147	OPTION 1	T/H 3.18	DUAL
36	75783-0148	OPTION 1	T/H 3.18	UNIVERSAL
36	75783-0149	OPTION 2	T/H 3.18	LEFT
36	75783-0150	OPTION 2	T/H 3.18	RIGHT
36	75783-0151	OPTION 2	T/H 3.18	DUAL
36	75783-0152	OPTION 2	T/H 3.18	UNIVERSAL
36	75783-0153	OPTION 1	T/H 3.56	LEFT
36	75783-0154	OPTION 1	T/H 3.56	RIGHT
36	75783-0155	OPTION 1	T/H 3.56	DUAL
36	75783-0156	OPTION 1	T/H 3.56	UNIVERSAL
36	75783-0157	OPTION 2	T/H 3.56	LEFT
36	75783-0158	OPTION 2	T/H 3.56	RIGHT
36	75783-0159	OPTION 2	T/H 3.56	DUAL
36	75783-0160	OPTION 2	T/H 3.56	UNIVERSAL

iPass™ IS A TRADEMARK OF MOLEX

ENTER DESCRIPTION EC NO: UCP2010-1913 DRWN: KLANG 2010/02/03 CHKD: JSWENSON 2010/03/24 APPR: MBANAKIS 2010/03/25 REV: D1	QUALITY SYMBOLS ▽=0 ▽=0	GENERAL TOLERANCES (UNLESS SPECIFIED)		DIMENSION STYLE MM ONLY	SCALE 2:1	DESIGN UNITS METRIC	THIRD ANGLE PROJECTION		
		4 PLACES ± --- ± --- 3 PLACES ± --- ± --- 2 PLACES ± 0.13 ± --- 1 PLACE ± 0.25 ± ---	mm INCH	DRAWN BY DATE KLANG 02/09/05	CHECKED BY DATE JSWENSON 02/09/05	TITLE I-PASS R/A CONNECTOR INTERNAL ASSY W/SHELL 0.8MM PITCH I/O			
		ANGULAR ±1/2°		APPROVED BY DATE MBANAKIS 02/02/05	MOLEX MOLEX INCORPORATED				
		DRAFT WHERE APPLICABLE MUST REMAIN WITHIN DIMENSIONS		MATERIAL NO. SEE CHART	DOCUMENT NO. SD-75783-001	SHEET NO. 6 OF 12			

THIS DRAWING CONTAINS INFORMATION THAT IS PROPRIETARY TO MOLEX INCORPORATED AND SHOULD NOT BE USED WITHOUT WRITTEN PERMISSION

50 CIRCUIT ITEM NUMBERS

CIRCUIT SIZE	ITEM NUMBER	PLATING OPTION	SHELL PCB OPTION	SHELL KEY OPTION
50	75783-0207	OPTION 1	RETENTION	LEFT
50	75783-0208	OPTION 1	RETENTION	RIGHT
50	75783-0209	OPTION 1	RETENTION	DUAL
50	75783-0210	OPTION 1	SMT	LEFT
50	75783-0211	OPTION 1	SMT	RIGHT
50	75783-0212	OPTION 1	SMT	DUAL
50	75783-0219	OPTION 2	RETENTION	LEFT
50	75783-0220	OPTION 2	RETENTION	RIGHT
50	75783-0221	OPTION 2	RETENTION	DUAL
50	75783-0222	OPTION 2	SMT	LEFT
50	75783-0223	OPTION 2	SMT	RIGHT
50	75783-0224	OPTION 2	SMT	DUAL
50	75783-0225	OPTION 1	RETENTION	UNIVERSAL
50	75783-0226	OPTION 1	SMT	UNIVERSAL
50	75783-0227	OPTION 2	RETENTION	UNIVERSAL
50	75783-0228	OPTION 2	SMT	UNIVERSAL
50	75783-0229	OPTION 1	T/H 1.96	LEFT
50	75783-0230	OPTION 1	T/H 1.96	RIGHT
50	75783-0231	OPTION 1	T/H 1.96	DUAL
50	75783-0232	OPTION 1	T/H 1.96	UNIVERSAL
50	75783-0233	OPTION 2	T/H 1.96	LEFT
50	75783-0234	OPTION 2	T/H 1.96	RIGHT
50	75783-0235	OPTION 2	T/H 1.96	DUAL
50	75783-0236	OPTION 2	T/H 1.96	UNIVERSAL

CIRCUIT SIZE	ITEM NUMBER	PLATING OPTION	SHELL PCB OPTION	SHELL KEY OPTION
50	75783-0237	OPTION 1	T/H 2.79	LEFT
50	75783-0238	OPTION 1	T/H 2.79	RIGHT
50	75783-0239	OPTION 1	T/H 2.79	DUAL
50	75783-0240	OPTION 1	T/H 2.79	UNIVERSAL
50	75783-0241	OPTION 2	T/H 2.79	LEFT
50	75783-0242	OPTION 2	T/H 2.79	RIGHT
50	75783-0243	OPTION 2	T/H 2.79	DUAL
50	75783-0244	OPTION 2	T/H 2.79	UNIVERSAL
50	75783-0245	OPTION 1	T/H 3.18	LEFT
50	75783-0246	OPTION 1	T/H 3.18	RIGHT
50	75783-0247	OPTION 1	T/H 3.18	DUAL
50	75783-0248	OPTION 1	T/H 3.18	UNIVERSAL
50	75783-0249	OPTION 2	T/H 3.18	LEFT
50	75783-0250	OPTION 2	T/H 3.18	RIGHT
50	75783-0251	OPTION 2	T/H 3.18	DUAL
50	75783-0252	OPTION 2	T/H 3.18	UNIVERSAL

iPass™ IS A TRADEMARK OF MOLEX

SEE SHEET 1 EC NO: UCP2010-1913 DRW:KLANG 2010/02/03 CHKD:JWENSON 2010/03/24 APPR:MBANAKIS 2010/03/25	DESCRIPTION REV D1	QUALITY SYMBOLS ▽=0 ▽=0	GENERAL TOLERANCES (UNLESS SPECIFIED) <table border="1"> <tr><th></th><th>mm</th><th>INCH</th></tr> <tr><td>4 PLACES</td><td>± ---</td><td>± ---</td></tr> <tr><td>3 PLACES</td><td>± ---</td><td>± ---</td></tr> <tr><td>2 PLACES</td><td>± 0.13</td><td>± ---</td></tr> <tr><td>1 PLACE</td><td>± 0.25</td><td>± ---</td></tr> </table> ANGULAR ±1/2°		mm	INCH	4 PLACES	± ---	± ---	3 PLACES	± ---	± ---	2 PLACES	± 0.13	± ---	1 PLACE	± 0.25	± ---	DIMENSION STYLE MM ONLY DRAWN BY: KLANG DATE: 02/09/05 CHECKED BY: JSWENSON DATE: 02/09/05 APPROVED BY: MBANAKIS DATE: 02/02/05	SCALE: 2:1 DESIGN UNITS: METRIC THIRD ANGLE PROJECTION	TITLE I-PASS R/A CONNECTOR INTERNAL ASSY W/SHELL 0.8MM PITCH I/O
			mm	INCH																	
		4 PLACES	± ---	± ---																	
		3 PLACES	± ---	± ---																	
2 PLACES	± 0.13	± ---																			
1 PLACE	± 0.25	± ---																			
DRAFT WHERE APPLICABLE MUST REMAIN WITHIN DIMENSIONS		MATERIAL NO. SEE CHART	MOLEX INCORPORATED	DOCUMENT NO. SD-75783-001	SHEET NO. 7 OF 12																
THIS DRAWING CONTAINS INFORMATION THAT IS PROPRIETARY TO MOLEX INCORPORATED AND SHOULD NOT BE USED WITHOUT WRITTEN PERMISSION																					
SIZE C																					

68 CIRCUIT ITEM NUMBERS

CIRCUIT SIZE	ITEM NUMBER	PLATING OPTION	SHELL PCB OPTION	SHELL KEY OPTION
68	75783-0307	OPTION 1	RETENTION	LEFT
68	75783-0308	OPTION 1	RETENTION	RIGHT
68	75783-0309	OPTION 1	RETENTION	DUAL
68	75783-0310	OPTION 1	SMT	LEFT
68	75783-0311	OPTION 1	SMT	RIGHT
68	75783-0312	OPTION 1	SMT	DUAL
68	75783-0319	OPTION 2	RETENTION	LEFT
68	75783-0320	OPTION 2	RETENTION	RIGHT
68	75783-0321	OPTION 2	RETENTION	DUAL
68	75783-0322	OPTION 2	SMT	LEFT
68	75783-0323	OPTION 2	SMT	RIGHT
68	75783-0324	OPTION 2	SMT	DUAL
68	75783-0325	OPTION 1	RETENTION	UNIVERSAL
68	75783-0326	OPTION 1	SMT	UNIVERSAL
68	75783-0327	OPTION 2	RETENTION	UNIVERSAL
68	75783-0328	OPTION 2	SMT	UNIVERSAL
68	75783-0329	OPTION 1	T/H 1.96	LEFT
68	75783-0330	OPTION 1	T/H 1.96	RIGHT
68	75783-0331	OPTION 1	T/H 1.96	DUAL
68	75783-0332	OPTION 1	T/H 1.96	UNIVERSAL
68	75783-0333	OPTION 2	T/H 1.96	LEFT
68	75783-0334	OPTION 2	T/H 1.96	RIGHT
68	75783-0335	OPTION 2	T/H 1.96	DUAL
68	75783-0336	OPTION 2	T/H 1.96	UNIVERSAL

CIRCUIT SIZE	ITEM NUMBER	PLATING OPTION	SHELL PCB OPTION	SHELL KEY OPTION
68	75783-0337	OPTION 1	T/H 2.79	LEFT
68	75783-0338	OPTION 1	T/H 2.79	RIGHT
68	75783-0339	OPTION 1	T/H 2.79	DUAL
68	75783-0340	OPTION 1	T/H 2.79	UNIVERSAL
68	75783-0341	OPTION 2	T/H 2.79	LEFT
68	75783-0342	OPTION 2	T/H 2.79	RIGHT
68	75783-0343	OPTION 2	T/H 2.79	DUAL
68	75783-0344	OPTION 2	T/H 2.79	UNIVERSAL
68	75783-0345	OPTION 1	T/H 3.18	LEFT
68	75783-0346	OPTION 1	T/H 3.18	RIGHT
68	75783-0347	OPTION 1	T/H 3.18	DUAL
68	75783-0348	OPTION 1	T/H 3.18	UNIVERSAL
68	75783-0349	OPTION 2	T/H 3.18	LEFT
68	75783-0350	OPTION 2	T/H 3.18	RIGHT
68	75783-0351	OPTION 2	T/H 3.18	DUAL
68	75783-0352	OPTION 2	T/H 3.18	UNIVERSAL

iPass™ IS A TRADEMARK OF MOLEX

SEE SHEET 1 EC NO: UCP2010-1913 DRWN: KLANG 2010/02/03 CHKD: JSWENSON 2010/03/24 APPR: MBANAKIS 2010/03/25	DESCRIPTION REV: D1	QUALITY SYMBOLS ▽=0 ▽=0	GENERAL TOLERANCES (UNLESS SPECIFIED) <table border="1"> <tr> <th></th> <th>mm</th> <th>INCH</th> </tr> <tr> <td>4 PLACES</td> <td>± ---</td> <td>± ---</td> </tr> <tr> <td>3 PLACES</td> <td>± ---</td> <td>± ---</td> </tr> <tr> <td>2 PLACES</td> <td>± 0.13</td> <td>± ---</td> </tr> <tr> <td>1 PLACE</td> <td>± 0.25</td> <td>± ---</td> </tr> </table> ANGULAR ±1/2°		mm	INCH	4 PLACES	± ---	± ---	3 PLACES	± ---	± ---	2 PLACES	± 0.13	± ---	1 PLACE	± 0.25	± ---	DIMENSION STYLE MM ONLY DRAWN BY: KLANG DATE: 02/09/05 CHECKED BY: JSWENSON DATE: 02/09/05 APPROVED BY: MBANAKIS DATE: 02/02/05	SCALE: 2:1 DESIGN UNITS: METRIC THIRD ANGLE PROJECTION	TITLE: I-PASS R/A CONNECTOR INTERNAL ASSY W/SHELL 0.8MM PITCH I/O
			mm	INCH																	
		4 PLACES	± ---	± ---																	
		3 PLACES	± ---	± ---																	
2 PLACES	± 0.13	± ---																			
1 PLACE	± 0.25	± ---																			
DRAFT WHERE APPLICABLE MUST REMAIN WITHIN DIMENSIONS			MATERIAL NO.	DOCUMENT NO.	SHEET NO.																
SEE CHART			MOLEX INCORPORATED	SD-75783-001	8 OF 12																
THIS DRAWING CONTAINS INFORMATION THAT IS PROPRIETARY TO MOLEX INCORPORATED AND SHOULD NOT BE USED WITHOUT WRITTEN PERMISSION																					

RIGHT ANGLE CONNECTOR WITH RETENTION FIT & THRU-HOLE SHELL PCB FOOT PRINT

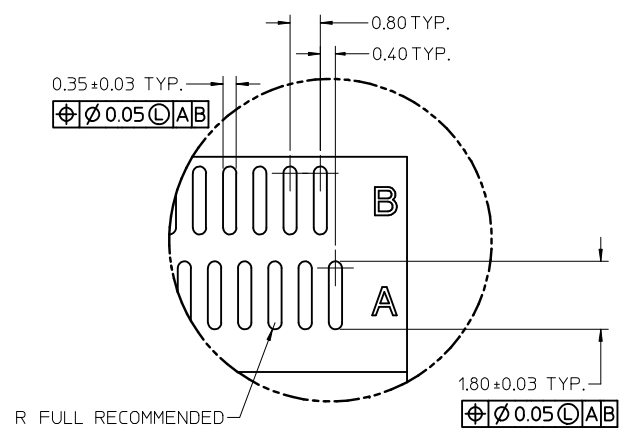
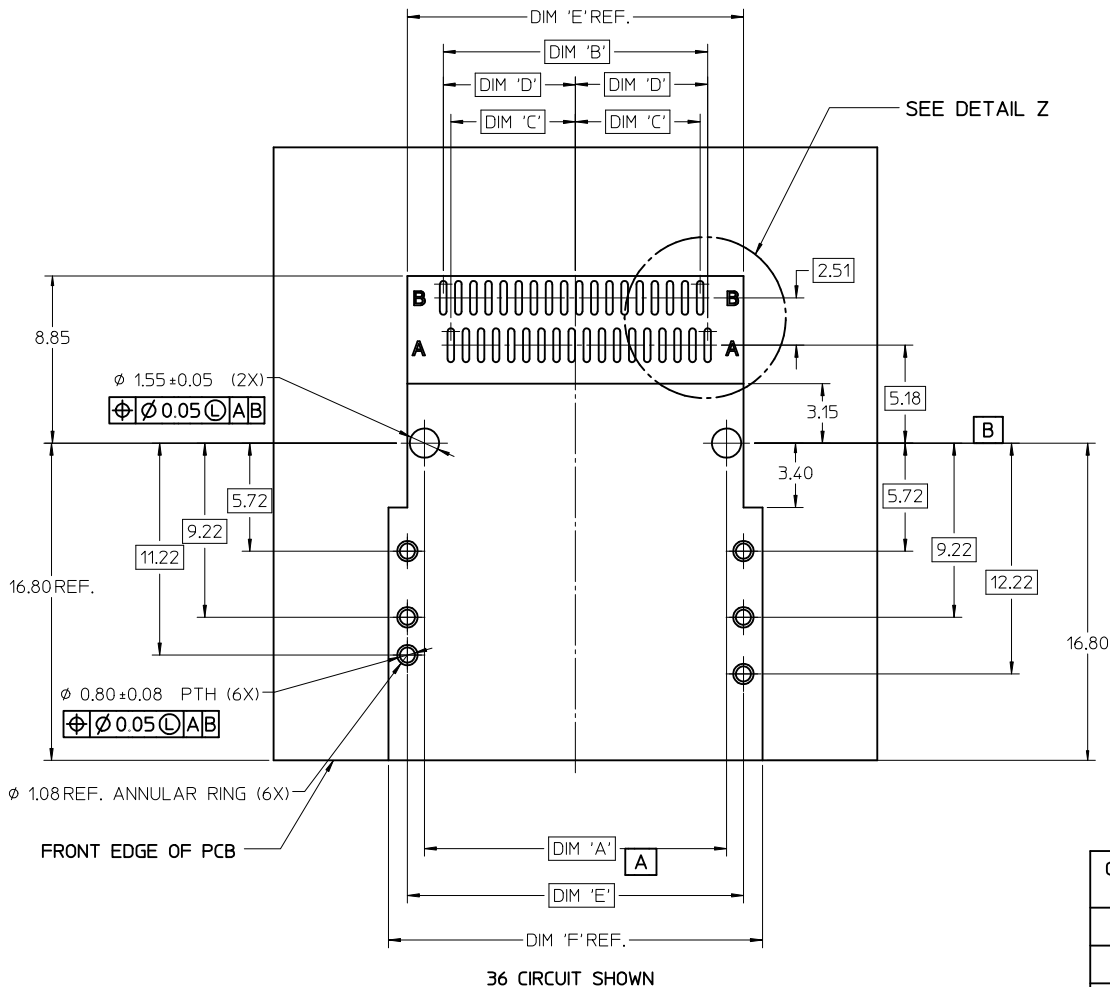

DETAIL Z
SCALE 10:1

CIRCUIT SIZE	DIMENSIONS					
	PEG TO PEG	FIRST PAD TO LAST PAD	CENTERLINE TO PAD	CENTERLINE TO PAD	CONNECTOR WIDTH SHELL PEG TO PEG	SHELL FOOTPRINT WIDTH
	DIM 'A'	DIM 'B'	DIM 'C'	DIM 'D'	DIM 'E'	DIM 'F'
26	12.00	10.00	4.60	5.00	13.80	15.80
36	16.00	14.00	6.60	7.00	17.80	19.80
50	21.60	19.60	9.40	9.80	23.40	25.40
68	28.80	26.80	13.00	13.40	30.60	32.60

iPass™ IS A TRADEMARK OF MOLEX

SEE SHEET 1 EC NO: UCP2010-1913 DRW: KLK 2010/02/03 CHKD: JSWENSON 2010/03/24 APPR: MBANAKIS 2010/03/25	QUALITY SYMBOLS ▽=0 ▽=0	GENERAL TOLERANCES (UNLESS SPECIFIED) mm INCH 4 PLACES ± --- ± --- 3 PLACES ± --- ± --- 2 PLACES ± 0.13 ± --- 1 PLACE ± 0.25 ± --- ANGULAR ± 1/2°	DIMENSION STYLE MM ONLY DRAWN BY DATE KLK 02/09/05 CHECKED BY DATE JSWENSON 02/09/05 APPROVED BY DATE MBANAKIS 02/02/05	SCALE 5:1 DESIGN UNITS METRIC THIRD ANGLE PROJECTION	I-PASS R/A CONNECTOR INTERNAL ASSY W/SHELL 0.8MM PITCH I/O MOLEX INCORPORATED	SHEET NO. 9 OF 12
	DRAFT WHERE APPLICABLE MUST REMAIN WITHIN DIMENSIONS			MATERIAL NO. SEE CHART DOCUMENT NO. SD-75783-001		
	THIS DRAWING CONTAINS INFORMATION THAT IS PROPRIETARY TO MOLEX INCORPORATED AND SHOULD NOT BE USED WITHOUT WRITTEN PERMISSION					
	D1					

RIGHT ANGLE CONNECTOR WITH SMT SHELL PCB FOOT PRINT

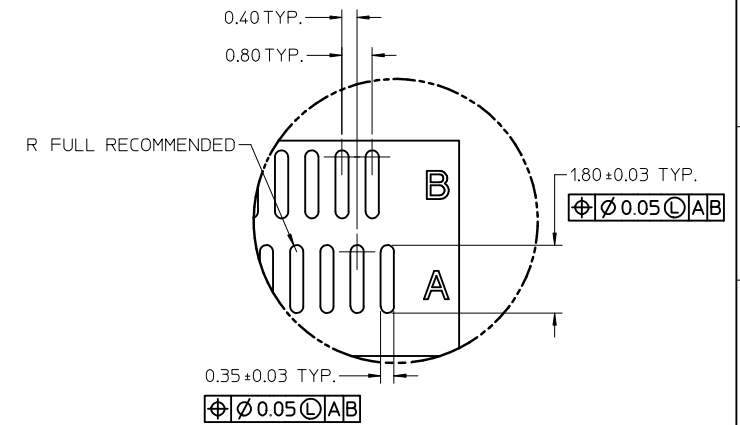
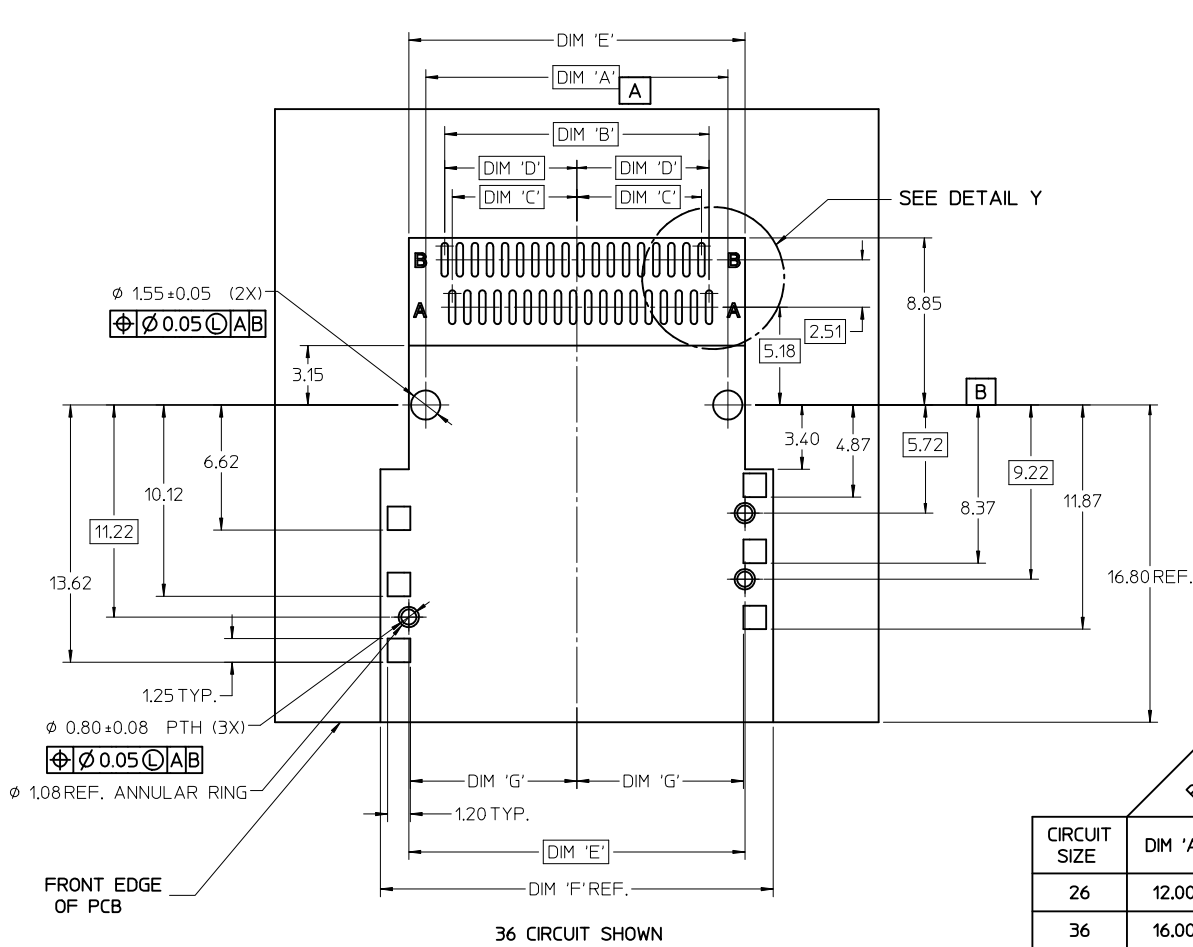

DETAIL Y
SCALE 10:1

	PEG TO PEG	FIRST PAD TO LAST PAD	CENTERLINE TO PAD	CENTERLINE TO PAD	CONNECTOR WIDTH SHELL PEG TO PEG	SHELL FOOTPRINT WIDTH	CENTERLINE TO PAD EDGE
CIRCUIT SIZE	DIM 'A'	DIM 'B'	DIM 'C'	DIM 'D'	DIM 'E'	DIM 'F'	DIM 'G'
26	12.00	10.00	4.60	5.00	13.80	16.80	6.825
36	16.00	14.00	6.60	7.00	17.80	20.80	8.825
50	21.60	19.60	9.40	9.80	23.40	26.40	11.625
68	28.80	26.80	13.00	13.40	30.60	33.60	15.225

iPass™ IS A TRADEMARK OF MOLEX

SEE SHEET 1 EC NO: UCP2010-1913 DRW: KLK CHKD: JSWENSON APPR: MBANAKI S 2010/02/03 2010/03/24 2010/03/25	QUALITY SYMBOLS ▽=0 ▽=0	GENERAL TOLERANCES (UNLESS SPECIFIED)		DIMENSION STYLE MM ONLY		SCALE 5:1	DESIGN UNITS METRIC	THIRD ANGLE PROJECTION	
				DRAWN BY KLK		DATE 02/09/05		I-PASS R/A CONNECTOR INTERNAL ASSY W/SHELL 0.8MM PITCH I/O MOLEX INCORPORATED	
				CHECKED BY JSWENSON		DATE 02/09/05			
				APPROVED BY MBANAKI S		DATE 02/02/05			
D1	REV	ANGULAR ±1/2°		MATERIAL NO. SEE CHART		DOCUMENT NO. SD-75783-001		SHEET NO. 10 OF 12	
DRAFT WHERE APPLICABLE MUST REMAIN WITHIN DIMENSIONS				SIZE C		THIS DRAWING CONTAINS INFORMATION THAT IS PROPRIETARY TO MOLEX INCORPORATED AND SHOULD NOT BE USED WITHOUT WRITTEN PERMISSION			

RIGHT ANGLE CONNECTOR WITH SHELL PCB FOOT PRINT DESCRIPTIONS

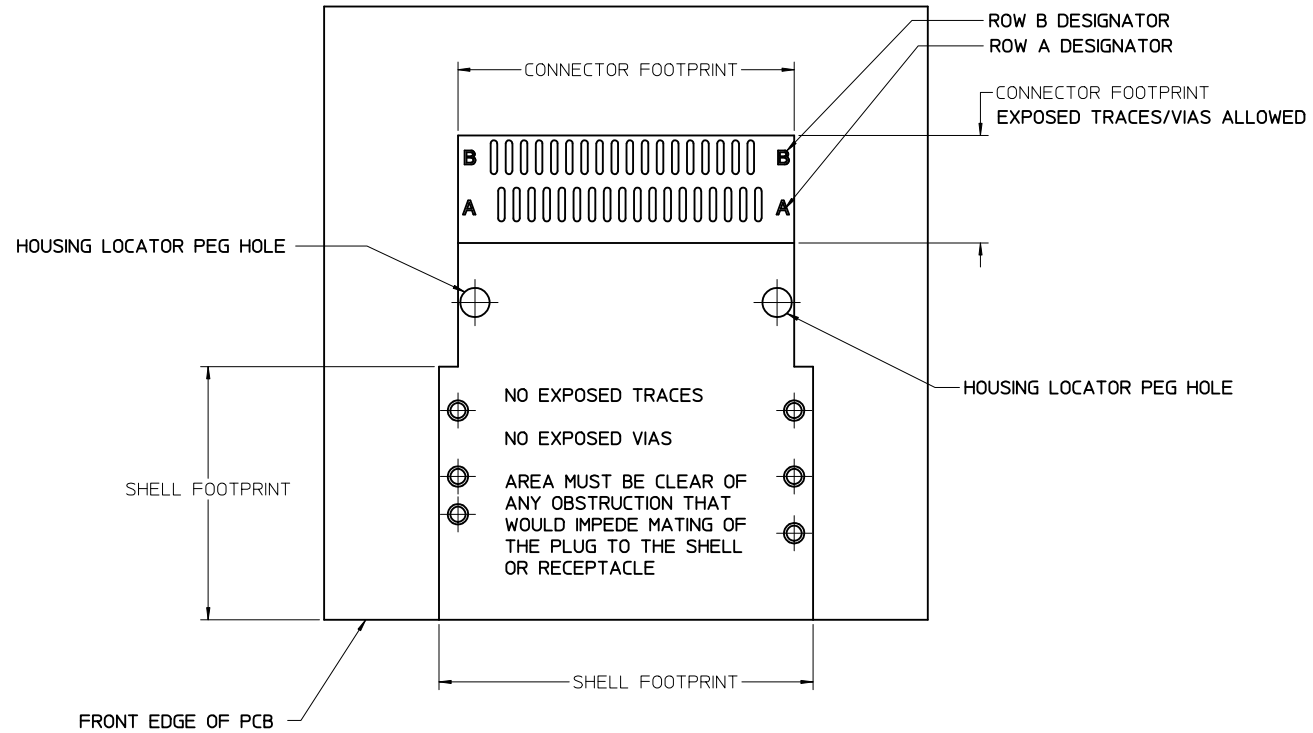

36 CIRCUIT SHOWN

NOTE: IF RECEPTACLE AND SHELL ARE NOT PLACED AT EDGE OF PCB AS SHOWN, ADDITIONAL CLEARANCE IS NEEDED FOR BODY OF PLUG AND CABLE

iPass™ IS A TRADEMARK OF MOLEX

SEE SHEET 1 EC NO: UCP2010-1913 DRW:KLANG 2010/02/03 CHKD:JSWENSON 2010/03/24 APPR:MBANAKIS 2010/03/25	QUALITY SYMBOLS ▽=0 ▽=0	GENERAL TOLERANCES (UNLESS SPECIFIED)		DIMENSION STYLE	SCALE	DESIGN UNITS	THIRD ANGLE PROJECTION		
				MM ONLY	5:1	METRIC			
				mm	INCH	DRAWN BY	DATE	I-PASS R/A CONNECTOR INTERNAL ASSY W/SHELL 0.8MM PITCH I/O	
						KLANG	02/09/05		
				CHECKED BY	DATE	MOLEX INCORPORATED			
				JSWENSON	02/09/05				
				APPROVED BY	DATE	DOCUMENT NO. SD-75783-001			
				MBANAKIS	02/02/05				
				MATERIAL NO.		SHEET NO. 11 OF 12			
				SEE CHART					
DRAFT WHERE APPLICABLE MUST REMAIN WITHIN DIMENSIONS				THIS DRAWING CONTAINS INFORMATION THAT IS PROPRIETARY TO MOLEX INCORPORATED AND SHOULD NOT BE USED WITHOUT WRITTEN PERMISSION					

MATING INTERFACE (FOR REFERENCE ONLY)

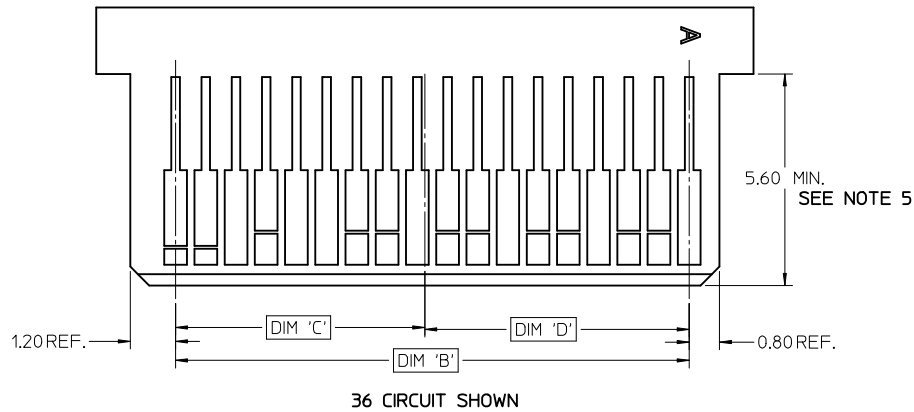
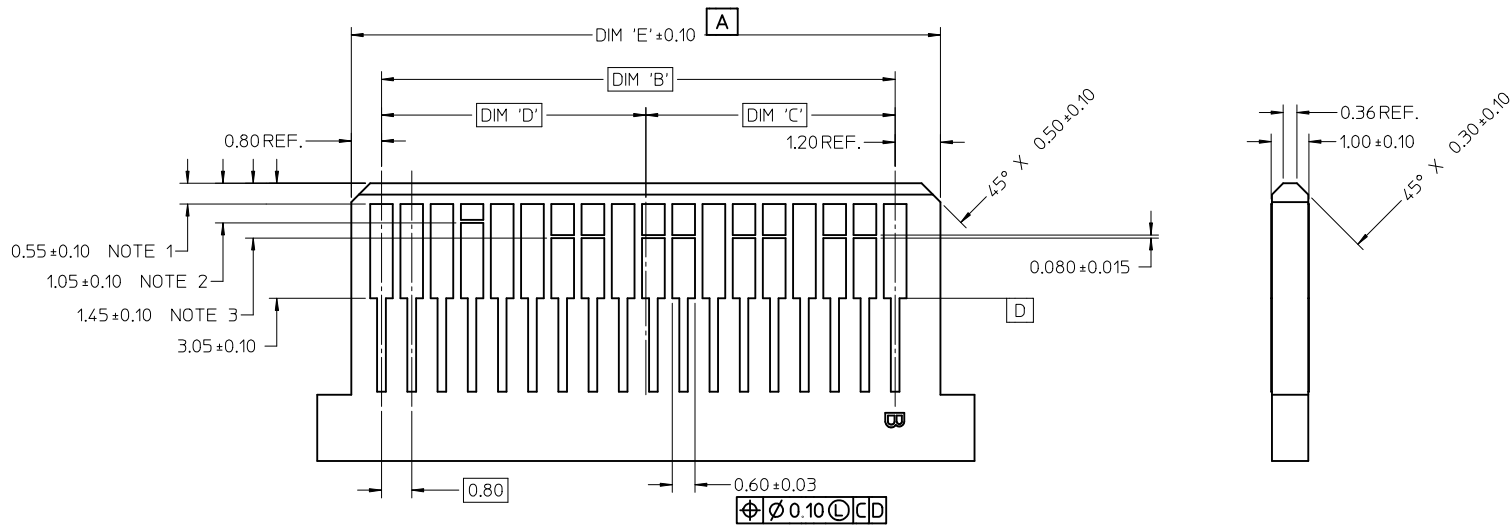

- NOTES:
- PAD CONFIGURATION FOR FIRST MATE.
 - PAD CONFIGURATION FOR SECOND MATE.
 - PAD CONFIGURATION FOR THIRD MATE. (HIGH SPEED SIGNALS)
 - FOR PIN ASSIGNMENTS AND MATING SEQUENCE (1ST, 2ND, 3RD), SEE APPLICABLE SPECIFICATION.
 - MINIMUM STEP REQUIRED IF PCB MADE WIDER THAN TOUNGE.

CIRCUIT SIZE	TERM/SIDE 'N'	DIM 'B'	DIM 'C'	DIM 'D'	DIM 'E'
26	13	9.60	4.60	5.00	11.60
36	18	13.60	6.60	7.00	15.60
50	25	19.20	9.40	9.80	21.20
68	34	26.40	13.00	13.40	28.40

iPass™ IS A TRADEMARK OF MOLEX

SEE SHEET 1 EC NO: UCP2010-1913 DRW:KLANG 2010/02/03 CHKD:JSWENSON 2010/03/24 APPR:MBANAKIS 2010/03/25 REV: D1	QUALITY SYMBOLS ▽=0 ▽=0	GENERAL TOLERANCES (UNLESS SPECIFIED)		DIMENSION STYLE MM ONLY	SCALE 10:1	DESIGN UNITS METRIC	THIRD ANGLE PROJECTION	
		4 PLACES ± --- ± ---	3 PLACES ± --- ± ---	DRAWN BY KLANG	DATE 02/09/05	TITLE I-PASS R/A CONNECTOR INTERNAL ASSY W/SHELL 0.8MM PITCH I/O		
		2 PLACES ± 0.13 ± ---	1 PLACE ± 0.25 ± ---	CHECKED BY JSWENSON	DATE 02/09/05			
		ANGULAR ± 1/2°		APPROVED BY MBANAKIS	DATE 02/02/05	MOLEX INCORPORATED DOCUMENT NO. SD-75783-001		SHEET NO. 12 OF 12

DRAFT WHERE APPLICABLE MUST REMAIN WITHIN DIMENSIONS

SIZE C THIS DRAWING CONTAINS INFORMATION THAT IS PROPRIETARY TO MOLEX INCORPORATED AND SHOULD NOT BE USED WITHOUT WRITTEN PERMISSION



Стандарт Электрон Связь

Мы молодая и активно развивающаяся компания в области поставок электронных компонентов. Мы поставляем электронные компоненты отечественного и импортного производства напрямую от производителей и с крупнейших складов мира.

Благодаря сотрудничеству с мировыми поставщиками мы осуществляем комплексные и плановые поставки широчайшего спектра электронных компонентов.

Собственная эффективная логистика и склад в обеспечивает надежную поставку продукции в точно указанные сроки по всей России.

Мы осуществляем техническую поддержку нашим клиентам и предпродажную проверку качества продукции. На все поставляемые продукты мы предоставляем гарантию .

Осуществляем поставки продукции под контролем ВП МО РФ на предприятия военно-промышленного комплекса России , а также работаем в рамках 275 ФЗ с открытием отдельных счетов в уполномоченном банке. Система менеджмента качества компании соответствует требованиям ГОСТ ISO 9001.

Минимальные сроки поставки, гибкие цены, неограниченный ассортимент и индивидуальный подход к клиентам являются основой для выстраивания долгосрочного и эффективного сотрудничества с предприятиями радиоэлектронной промышленности, предприятиями ВПК и научно-исследовательскими институтами России.

С нами вы становитесь еще успешнее!

Наши контакты:

Телефон: +7 812 627 14 35

Электронная почта: sales@st-electron.ru

Адрес: 198099, Санкт-Петербург,
Промышленная ул, дом № 19, литера Н,
помещение 100-Н Офис 331