

PNP Silicon AF Transistor

- For AF input stages and driver applications
- High current gain
- Low collector-emitter saturation voltage
- Low noise between 30 hz and 15 kHz
- Complementary types:
BC847...-BC850... (NPN)
- Pb-free (RoHS compliant) package
- Qualified according AEC Q101¹⁾



¹⁾BC857BL3 is not qualified according AEC Q101

Type	Marking	Pin Configuration						Package
		1=B	2=E	3=C	-	-	-	
BC857A	3Es	1=B	2=E	3=C	-	-	-	SOT23
BC857B	3Fs	1=B	2=E	3=C	-	-	-	SOT23
BC857BL3*	3F	1=B	2=E	3=C	-	-	-	TSLP-3-1
BC857BW	3Fs	1=B	2=E	3=C	-	-	-	SOT323
BC857C	3Gs	1=B	2=E	3=C	-	-	-	SOT23
BC857CW	3Gs	1=B	2=E	3=C	-	-	-	SOT323
BC858A	3Js	1=B	2=E	3=C	-	-	-	SOT23
BC858B	3Ks	1=B	2=E	3=C	-	-	-	SOT23
BC858BW	3Ks	1=B	2=E	3=C	-	-	-	SOT323
BC858C	3Ls	1=B	2=E	3=C	-	-	-	SOT23
BC858CW	3Ls	1=B	2=E	3=C	-	-	-	SOT323
BC859C	4Cs	1=B	2=E	3=C	-	-	-	SOT23
BC860B	4Fs	1=B	2=E	3=C	-	-	-	SOT23
BC860BW	4Fs	1=B	2=E	3=C	-	-	-	SOT323
BC860CW	4Gs	1=B	2=E	3=C	-	-	-	SOT323

* Not qualified according AEC Q101

Maximum Ratings

Parameter	Symbol	Value	Unit
Collector-emitter voltage BC857..., BC860... BC858..., BC859...	V_{CEO}	45 30	V
Collector-base voltage BC857..., BC860... BC858..., BC859...	V_{CBO}	50 30	
Emitter-base voltage	V_{EBO}	5	
Collector current	I_C	100	mA
Peak collector current, $t_p \leq 10$ ms	I_{CM}	200	
Total power dissipation $T_S \leq 71$ °C, BC857-BC860 $T_S \leq 135$ °C, BC857BL3 $T_S \leq 124$ °C, BC857W-BC860W	P_{tot}	330 250 250	mW
Junction temperature	T_j	150	°C
Storage temperature	T_{stg}	-65 ... 150	

Thermal Resistance

Parameter	Symbol	Value	Unit
Junction - soldering point ¹⁾ BC857-BC860 BC857BL3 BC857W-BC860W	R_{thJS}	≤ 240 ≤ 60 ≤ 105	K/W

¹For calculation of R_{thJA} please refer to Application Note AN077 (Thermal Resistance Calculation)

Electrical Characteristics at $T_A = 25^\circ\text{C}$, unless otherwise specified

Parameter	Symbol	Values			Unit
		min.	typ.	max.	
DC Characteristics					
Collector-emitter breakdown voltage $I_C = 10\text{ mA}$, $I_B = 0$, BC857..., BC860... $I_C = 10\text{ mA}$, $I_B = 0$, BC858..., BC859...	$V_{(BR)CEO}$	45 30	- -	- -	V
Collector-base breakdown voltage $I_C = 10\text{ }\mu\text{A}$, $I_E = 0$, BC857..., BC860... $I_C = 10\text{ }\mu\text{A}$, $I_E = 0$, BC858..., BC859...	$V_{(BR)CBO}$	50 30	- -	- -	
Emitter-base breakdown voltage $I_E = 1\text{ }\mu\text{A}$, $I_C = 0$	$V_{(BR)EBO}$	5	-	-	
Collector-base cutoff current $V_{CB} = 45\text{ V}$, $I_E = 0$ $V_{CB} = 30\text{ V}$, $I_E = 0$, $T_A = 150\text{ }^\circ\text{C}$	I_{CBO}	- -	- -	0.015 5	μA
DC current gain ¹⁾ $I_C = 10\text{ }\mu\text{A}$, $V_{CE} = 5\text{ V}$, $h_{FE}\text{-grp.A}$ $I_C = 10\text{ }\mu\text{A}$, $V_{CE} = 5\text{ V}$, $h_{FE}\text{-grp.B}$ $I_C = 10\text{ }\mu\text{A}$, $V_{CE} = 5\text{ V}$, $h_{FE}\text{-grp.C}$ $I_C = 2\text{ mA}$, $V_{CE} = 5\text{ V}$, $h_{FE}\text{-grp.A}$ $I_C = 2\text{ mA}$, $V_{CE} = 5\text{ V}$, $h_{FE}\text{-grp.B}$ $I_C = 2\text{ mA}$, $V_{CE} = 5\text{ V}$, $h_{FE}\text{-grp.C}$	h_{FE}	- - - 125 220 420	140 250 480 180 290 520	- - - 250 475 800	-
Collector-emitter saturation voltage ¹⁾ $I_C = 10\text{ mA}$, $I_B = 0.5\text{ mA}$ $I_C = 100\text{ mA}$, $I_B = 5\text{ mA}$	V_{CEsat}	- -	75 250	300 650	mV
Base emitter saturation voltage ¹⁾ $I_C = 10\text{ mA}$, $I_B = 0.5\text{ mA}$ $I_C = 100\text{ mA}$, $I_B = 5\text{ mA}$	V_{BEsat}	- -	700 850	- -	
Base-emitter voltage ¹⁾ $I_C = 2\text{ mA}$, $V_{CE} = 5\text{ V}$ $I_C = 10\text{ mA}$, $V_{CE} = 5\text{ V}$	$V_{BE(ON)}$	600 -	650 -	750 820	

¹⁾Pulse test: $t < 300\mu\text{s}$; $D < 2\%$

Electrical Characteristics at $T_A = 25^\circ\text{C}$, unless otherwise specified

Parameter	Symbol	Values			Unit	
		min.	typ.	max.		
AC Characteristics						
Transition frequency $I_C = 20\text{ mA}, V_{CE} = 5\text{ V}, f = 100\text{ MHz}$	f_T	-	250	-	MHz	
Collector-base capacitance $V_{CB} = 10\text{ V}, f = 1\text{ MHz}$	C_{cb}	-	1.5	-	pF	
Emitter-base capacitance $V_{EB} = 0.5\text{ V}, f = 1\text{ MHz}$	C_{eb}	-	8	-		
Short-circuit input impedance $I_C = 2\text{ mA}, V_{CE} = 5\text{ V}, f = 1\text{ kHz}, h_{FE}\text{-grp.A}$ $I_C = 2\text{ mA}, V_{CE} = 5\text{ V}, f = 1\text{ kHz}, h_{FE}\text{-grp.B}$ $I_C = 2\text{ mA}, V_{CE} = 5\text{ V}, f = 1\text{ kHz}, h_{FE}\text{-grp.C}$	h_{11e}	-	2.7 4.5 8.7	-	k Ω	
Open-circuit reverse voltage transf. ratio $I_C = 2\text{ mA}, V_{CE} = 5\text{ V}, f = 1\text{ kHz}, h_{FE}\text{-grp.A}$ $I_C = 2\text{ mA}, V_{CE} = 5\text{ V}, f = 1\text{ kHz}, h_{FE}\text{-grp.B}$ $I_C = 2\text{ mA}, V_{CE} = 5\text{ V}, f = 1\text{ kHz}, h_{FE}\text{-grp.C}$	h_{12e}	-	1.5 2 3	-		10 ⁻⁴
Short-circuit forward current transf. ratio $I_C = 2\text{ mA}, V_{CE} = 5\text{ V}, f = 1\text{ kHz}, h_{FE}\text{-grp.A}$ $I_C = 2\text{ mA}, V_{CE} = 5\text{ V}, f = 1\text{ kHz}, h_{FE}\text{-grp.B}$ $I_C = 2\text{ mA}, V_{CE} = 5\text{ V}, f = 1\text{ kHz}, h_{FE}\text{-grp.C}$	h_{21e}	-	200 330 600	-		
Open-circuit output admittance $I_C = 2\text{ mA}, V_{CE} = 5\text{ V}, f = 1\text{ kHz}, h_{FE}\text{-grp.A}$ $I_C = 2\text{ mA}, V_{CE} = 5\text{ V}, f = 1\text{ kHz}, h_{FE}\text{-grp.B}$ $I_C = 2\text{ mA}, V_{CE} = 5\text{ V}, f = 1\text{ kHz}, h_{FE}\text{-grp.C}$	h_{22e}	-	18 30 60	-	μS	
Noise figure $I_C = 0.2\text{ mA}, V_{CE} = 5\text{ V}, f = 1\text{ kHz},$ $\Delta f = 200\text{ Hz}, R_S = 2\text{ k}\Omega, \text{ BC859, BC850}$	F	-	1	4		dB
Equivalent noise voltage $I_C = 200\text{ mA}, V_{CE} = 5\text{ V}, R_S = 2\text{ k}\Omega,$ $f = 10\text{...}50\text{ Hz}, \text{ BC860}$	V_n	-	-	0.11		

DC current gain $h_{FE} = f(I_C)$

$V_{CE} = 1\text{ V}$

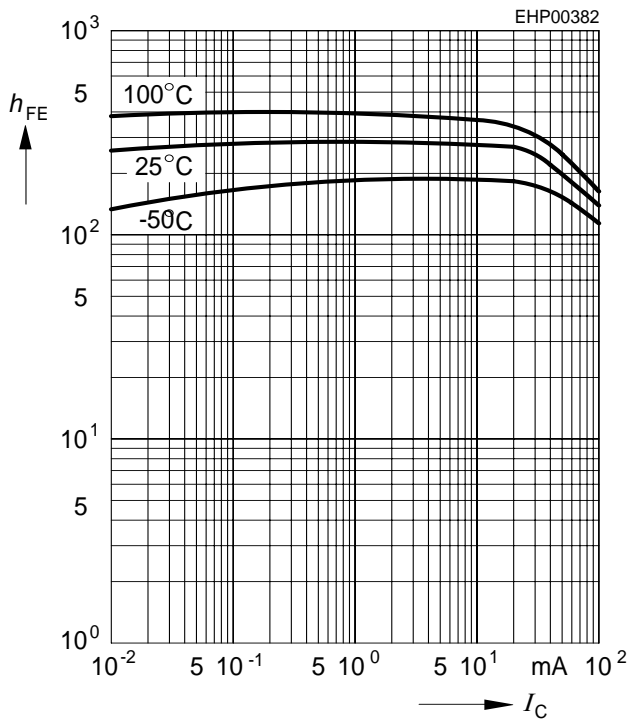

Collector-emitter saturation voltage

$I_C = f(V_{CEsat}), h_{FE} = 20$

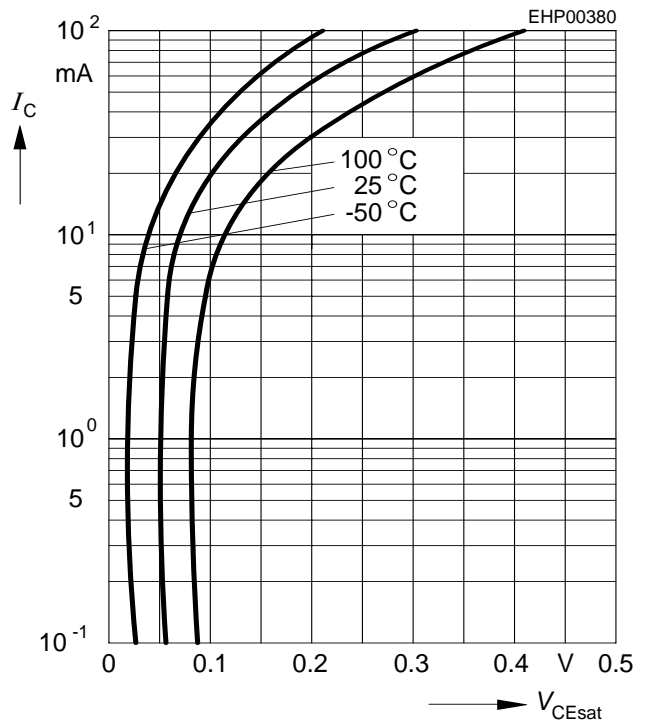

Base-emitter saturation voltage

$I_C = f(V_{BEsat}), h_{FE} = 20$

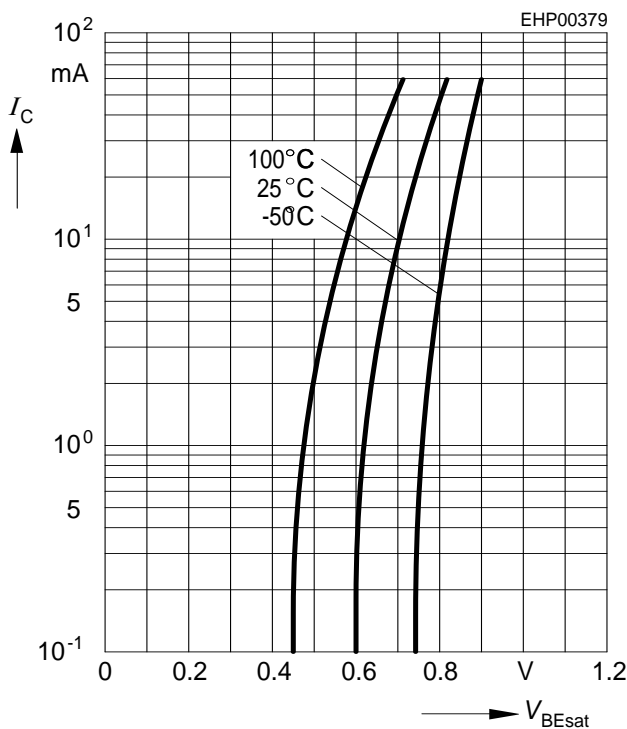

Collector cutoff current $I_{CBO} = f(T_A)$

$V_{CBO} = 30\text{ V}$

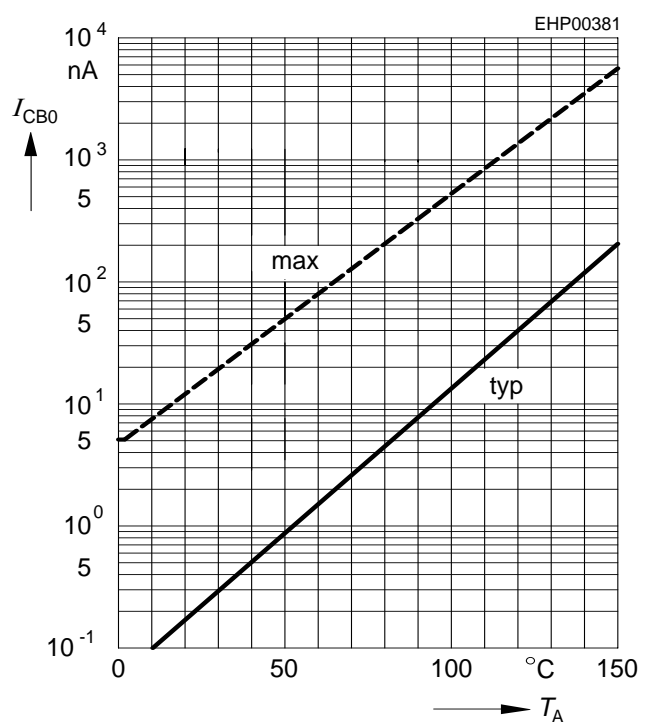

Transition frequency $f_T = f(I_C)$

$V_{CE} = 5\text{ V}$



Collector-base capacitance $C_{cb} = f(V_{CB})$

Emitter-base capacitance $C_{eb} = f(V_{EB})$



Total power dissipation $P_{tot} = f(T_S)$

BC856-BC860



Total power dissipation $P_{tot} = f(T_S)$

BC857BL3



Total power dissipation $P_{tot} = f(T_S)$

BC857W-BC860W



Permissible Pulse Load

$P_{totmax}/P_{totDC} = f(t_p)$

BC857/W-BC860/W



Permissible Puls Load $R_{thJS} = f(t_p)$

BC857BL3



Permissible Pulse Load

$P_{totmax}/P_{totDC} = f(t_p)$

BC857BL3



Package Outline



1) Lead width can be 0.6 max. in dambar area

Foot Print



Marking Layout (Example)



Standard Packing

Reel \varnothing 180 mm = 3.000 Pieces/Reel
 Reel \varnothing 330 mm = 10.000 Pieces/Reel



Package Outline



Foot Print



Marking Layout (Example)



Standard Packing

Reel \varnothing 180 mm = 3.000 Pieces/Reel
 Reel \varnothing 330 mm = 10.000 Pieces/Reel



Package Outline

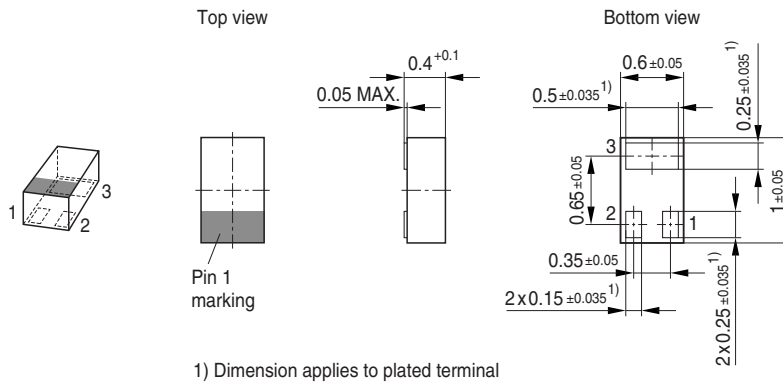

Foot Print

For board assembly information please refer to Infineon website "Packages"

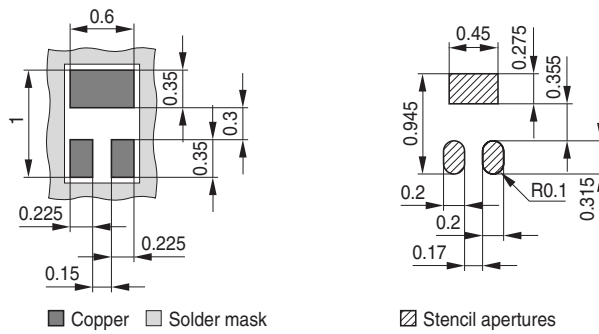

Marking Layout (Example)

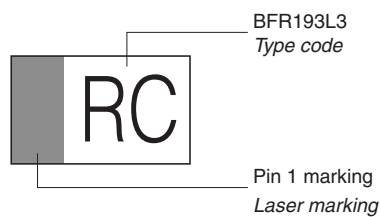

Standard Packing

Reel ø180 mm = 15.000 Pieces/Reel

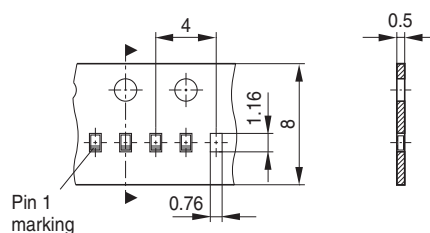

Edition 2009-11-16

**Published by
Infineon Technologies AG
81726 Munich, Germany**

**© 2009 Infineon Technologies AG
All Rights Reserved.**

Legal Disclaimer

The information given in this document shall in no event be regarded as a guarantee of conditions or characteristics. With respect to any examples or hints given herein, any typical values stated herein and/or any information regarding the application of the device, Infineon Technologies hereby disclaims any and all warranties and liabilities of any kind, including without limitation, warranties of non-infringement of intellectual property rights of any third party.

Information

For further information on technology, delivery terms and conditions and prices, please contact the nearest Infineon Technologies Office ([<www.infineon.com>](http://www.infineon.com)).

Warnings

Due to technical requirements, components may contain dangerous substances. For information on the types in question, please contact the nearest Infineon Technologies Office.

Infineon Technologies components may be used in life-support devices or systems only with the express written approval of Infineon Technologies, if a failure of such components can reasonably be expected to cause the failure of that life-support device or system or to affect the safety or effectiveness of that device or system. Life support devices or systems are intended to be implanted in the human body or to support and/or maintain and sustain and/or protect human life. If they fail, it is reasonable to assume that the health of the user or other persons may be endangered.



**Стандарт
Электрон
Связь**

Мы молодая и активно развивающаяся компания в области поставок электронных компонентов. Мы поставляем электронные компоненты отечественного и импортного производства напрямую от производителей и с крупнейших складов мира.

Благодаря сотрудничеству с мировыми поставщиками мы осуществляем комплексные и плановые поставки широчайшего спектра электронных компонентов.

Собственная эффективная логистика и склад в обеспечивает надежную поставку продукции в точно указанные сроки по всей России.

Мы осуществляем техническую поддержку нашим клиентам и предпродажную проверку качества продукции. На все поставляемые продукты мы предоставляем гарантию .

Осуществляем поставки продукции под контролем ВП МО РФ на предприятия военно-промышленного комплекса России , а также работаем в рамках 275 ФЗ с открытием отдельных счетов в уполномоченном банке. Система менеджмента качества компании соответствует требованиям ГОСТ ISO 9001.

Минимальные сроки поставки, гибкие цены, неограниченный ассортимент и индивидуальный подход к клиентам являются основой для выстраивания долгосрочного и эффективного сотрудничества с предприятиями радиоэлектронной промышленности, предприятиями ВПК и научно-исследовательскими институтами России.

С нами вы становитесь еще успешнее!

Наши контакты:

Телефон: +7 812 627 14 35

Электронная почта: sales@st-electron.ru

Адрес: 198099, Санкт-Петербург,
Промышленная ул, дом № 19, литера Н,
помещение 100-Н Офис 331