



6

## Index

### Series 61

	<b>Description</b>	<b>Page 109</b>
	<b>Product Assembly</b>	<b>Page 110</b>
	<b>Product Range</b>	
	- pushbuttons for standard mounting	<b>Page 111</b>
	- pushbuttons for flush mounting	<b>Page 117</b>
	- accessories / spare parts	<b>Page 123</b>
	<b>Technical Data</b>	<b>Page 137</b>
	<b>Technical Drawing / Dimension / Layouts</b>	<b>Page 140</b>
	<b>Circuit Drawing</b>	<b>Page 150</b>
	<b>Typical Applications</b>	<b>Page 151</b>
<b>Marking</b>	<b>Page 153</b>	

## General Notes

The indicators, illuminated pushbuttons, selector switches, keylock switches and emergency stop switches with spray-water protection at the front (IP 65) are modular and consist of an actuator and switching element. In addition to the standard switching elements (gold-plated silver contact with universal soldering or plug-in terminals), forced-opening, slow-make switching elements with gold or silver contacts and soldering or plug-in terminals are available. They can be supplied with screw terminals and silver contacts too. The front dimensions of the units in this series are 24 x 24 mm, 24 mm dia., 18 x 24 mm, 18 x 18 mm or 18 mm dia. For flush mounting the dimensions 25 mm dia., 24 x 30 mm and 24 x 24 mm can be supplied.

## Mounting

All switch actuators are mounted from the front by pushing them through the mounting hole in the front panel. They are then fixed from the back with a fixing nut and the mounting tool typ no. 01-907. Max. tightening torque 50 Ncm. For mounting dimensions and grid size see as of page 145.

The preassembled switching element with the connecting wires in a single plane can be clipped on afterwards. For block or series mounting aids are available.

For switching elements with 2.8 mm plug-in terminals, we offer plug-in bases, which when soldered to a PCB enable a plug-in connection to the button. All actuators are provided with an anti-rotation device.

## Lenses

The flat or concave lenses are available in various colours and a transparent or translucent version. The lens surface is non-reflecting (matt). Lenses 19.7 mm dia. can be supplied also in aluminium.

## Marking

For engraving, hot stamping and film inserts, see page 153 under "Marking".

## Illumination

The midget-grooved T 1 3/4 incandescent lamp (6-60 V, 1.2 W) ensures perfect illumination of the lenses, which are supplied in various colours.

Midget-grooved T 1 3/4 Multi-LED (6, 12, 24, 48 V) are also available in white, red, yellow and green.

For supply voltages above 60 V, it is necessary to use a voltage reduction element (external series resistor, capacitor or transformer). Do not solder the terminals directly, because of the high surface temperature.

## Position indication

When the switch with maintained action is actuated, the lens snaps into place mechanically. The position of contacts can always be determined by the position of the lens.

## Keylock switch

Standard lock (index D)

1 standard number 311. If the lock number is not specified, we will supply no. 311. An additional 134 special locks (index X) are available on request. Master keys for locks no. 311 - 445 may be ordered by quoting no. 31-989.300.

Two keys are supplied with each keylock switch.

Spare keys for DOM standard locks may be ordered by quoting no. 31-989 (please state the lock number).

## Emergency stop switch foolproof with key to unlock

Kaba safety lock. Standard lock number is 1001. Locks with other numbers are available on request.

Spare keys for KABA locks may be ordered under no. 14-987 (please state the lock number).

## Specimen order

### Indicator complete

- indicator complete, soldering terminal, 18 x 24 mm 61-0030.02

### Recommended accessories:

- lens plastic, 18 x 24 mm, clear 61-9331.7  
- LED, 6 chips, 6 VDC, yellow 10-5306.3254

## illuminated-/pushbutton



- 1 lens
- 2 actuator case
- 3 fixing nut
- 4 switching element

## illuminated-/pushbutton for flush mounting

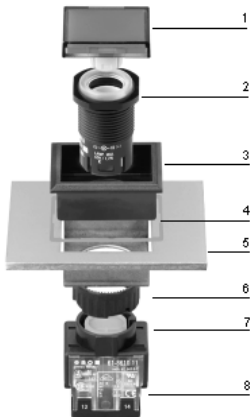

- 1 lens
- 2 actuator housing
- 3 front bezel
- 4 sealing
- 5 front panel
- 6 fixing bow
- 7 fixing nut
- 8 switching element

## indicator complete



### recommended accessories:

- lens plastic → 123
- front ring → 126
- incandescent lamp → 132; LED → 133

	connection method						circuit drawing	technical drawing	mounting dimension	
<b>indicator complete</b>	ST/PT	18 x 24 mm part no.	24 x 24 mm part no.	18 mm dia. part no.	18 x 18 mm part no.	24 mm dia. part no.	1	1	1	0,005

connection method: ST/PT = soldering-/plug-in terminal

Accessorie front ring only requested for Ø 24 mm.

marking see page 153

technical drawing as of page 140, mounting dimensions as of page 145, circuit drawing as of page 150

## indicator-/flasher-actuator



### recommended accessories:

- lens plastic → 123
- front ring → 126
- incandescent lamp → 132; LED → 133
- lamp element → 128; diode element → 128; flasher element → 131

						circuit drawing	technical drawing	mounting dimension	
<b>indicator-/flasher-actuator</b>	18 x 24 mm part no.	24 x 24 mm part no.	18 mm dia. part no.	18 x 18 mm part no.	24 mm dia. part no.	1	2	1	0,005

Accessorie front ring only requested for Ø 24 mm.

marking see page 153

technical drawing as of page 140, mounting dimensions as of page 145, circuit drawing as of page 150

## illuminated-/pushbutton actuator



### recommended accessories:

- lens plastic → 123; lens metal with window → 124; lens metal → 124
- front ring → 126
- incandescent lamp → 132; LED → 133
- switching element for illuminated-/pushbutton, keylock-/selector switch 2 positions → 129

	switching action	18 x 24 mm part no.	24 x 24 mm part no.	18 mm dia. part no.	18 x 18 mm part no.	24 mm dia. part no.	circuit drawing	technical drawing	mounting dimension	
<b>illuminated-/pushbutton actuator</b>	main	<b>61-1230.0</b>	<b>61-1250.0</b>	<b>61-1210.0</b>	<b>61-1220.0</b>	<b>61-1240.0</b>	2	3	1	0,005
	mom	<b>61-1130.0</b>	<b>61-1150.0</b>	<b>61-1110.0</b>	<b>61-1120.0</b>	<b>61-1140.0</b>	3	3	1	0,005
	mom/main	<b>61-1330.0</b>	<b>61-1350.0</b>	<b>61-1310.0</b>	<b>61-1320.0</b>		3	3	1	0,005

switching action: main = maintained action, mom = momentary action, mom/main = momentary-/maintained action

Accessory front ring only requested for Ø 24 mm.

marking see page 153

technical drawing as of page 140, mounting dimensions as of page 145, circuit drawing as of page 150

## emergency stop switch actuator foolproof

according to EN 418



### recommended accessories:

- label for emergency stop switch → 134
- switching element for emergency stop switch → 130
- protective shroud for emergency stop switch → 134

	switching action	unlocking	marking of mushroom-head cap	27 mm dia. part no.	circuit drawing	technical drawing	mounting dimension	
<b>emergency stop switch actuator foolproof</b>	main	twist to release	arrows	<b>61-3440.4/1</b>	4	4	2	0,003
			stop	<b>61-3440.4/2</b>	4	4	2	0,003
without label standard lock1001, other lock numbers on request	main	key to release	stop	<b>61-5441.4/K</b>	4	4	2	0,038

switching action: main = maintained action

description see page 109

technical drawing as of page 140, mounting dimensions as of page 145, circuit drawing as of page 150

## pushbutton actuator with mushroom-head cap



### recommended accessories:

- mushroom-head cap → 124
- front ring → 126
- switching element for illuminated-/pushbutton, keylock-/selector switch 2 positions → 129

	switching action	32 mm dia. part no.	circuit drawing	technical drawing	mounting dimension	
<b>pushbutton actuator with mushroom-head cap</b>	main	<b>61-1240.0</b>	2	5	2	0,006
	mom	<b>61-1140.0</b>	3	5	2	0,006

switching action: main = maintained action, mom = momentary action  
 technical drawing as of page 140, mounting dimensions as of page 145, circuit drawing as of page 150

## keylock switch actuator 2 positions

if installed with anti-twist device, the lug is on the left.



### recommended accessories:

- keylock front bezel → 124
- switching element for illuminated-/pushbutton, keylock-/selector switch 2 positions → 129
- anti-twisting ring → 135

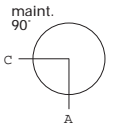
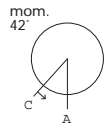
	switching action	key removable in	part no.	circuit drawing	technical drawing	mounting dimension	
  <p><b>keylock switch actuator 2 positions</b>                      pos. A: basic position                      pos. C: maintained action                      standard lock 311,                      other lock numbers on request</p>	main	A	<b>61-2201.0/D</b>	6	6	1	0,003
		C	<b>61-2203.0/D</b>	6	6	1	0,003
		C + A	<b>61-2205.0/D</b>	6	6	1	0,003
pos. A: basic position pos. C: momentary action standard lock 311, other lock numbers on request	mom	A	<b>61-2101.0/D</b>	5	6	1	0,003

switching action: main = maintained action, mom = momentary action  
 description see page 109  
 technical drawing as of page 140, mounting dimensions as of page 145, circuit drawing as of page 150

## keylock switch actuator 3 positions

if installed with anti-twist device, the lug is on the left.



### recommended accessories:

- keylock front bezel → 124
- switching element for keylock-/selector switch 3 positions → 130
- anti-twisting ring → 135

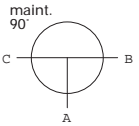
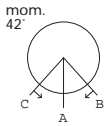
 	switching action	key removable in	part no.	circuit drawing	technical drawing	mounting dimension	kg
<b>keylock switch actuator 3 positions</b> pos. C: maintained action pos. A: basic position pos. B: maintained action standard lock 311 other lock numbers on request	main-0-main	A	<b>61-2601.0/D</b>	11	6	1	0,003
		A+B	<b>61-2604.0/D</b>	11	6	1	0,003
		B	<b>61-2602.0/D</b>	11	6	1	0,003
		C	<b>61-2603.0/D</b>	11	6	1	0,003
		C + A	<b>61-2605.0/D</b>	11	6	1	0,003
		C+A+B	<b>61-2607.0/D</b>	11	6	1	0,003
		C+B	<b>61-2606.0/D</b>	11	6	1	0,003
pos. C: maintained action pos. A: basic position pos. B: momentary action standard lock 311 other lock numbers on request	main-0-mom	A	<b>61-2701.0/D</b>	10	6	1	0,003
		C	<b>61-2703.0/D</b>	10	6	1	0,003
		C + A	<b>61-2705.0/D</b>	10	6	1	0,003
pos. C: momentary action pos. A: basic position pos. B: maintained action standard lock 311	mom-0-main	A	<b>61-2801.0/D</b>	9	6	1	0,003
		A+B	<b>61-2804.0/D</b>	9	6	1	0,003
		B	<b>61-2802.0/D</b>	7	6	1	0,003
pos. C: momentary action pos. A: basic position pos. B: momentary action standard lock 311	mom-0-mom	A	<b>61-2501.0/D</b>	8	6	1	0,003

switching action: mom = momentary action, main = maintained action, 0 = basic position

[description see page 109](#)

[technical drawing as of page 140, mounting dimensions as of page 145, circuit drawing as of page 150](#)



## selector switch actuator 2 positions

if installed with anti-twist device, the lug is on the left.



### recommended accessories:

-  lever → 125
-  incandescent lamp → 132; LED → 133
-  switching element for illuminated-/pushbutton, keylock-/selector switch 2 positions → 129
-  anti-twisting ring → 135



	switching action	18 mm dia. part no.	circuit drawing	technical drawing	mounting dimension	
<b>selector switch actuator 2 positions</b> pos. C: maintained action pos. A: basic position	main	<b>61-4210.0</b>	13	7	1	0,006
pos. C: momentary action pos. A: basic position	mom	<b>61-4110.0</b>	12	7	1	0,006

switching action: main = maintained action, mom = momentary action

technical drawing as of page 140, mounting dimensions as of page 145, circuit drawing as of page 150

## selector switch actuator 3 positions

if installed with anti-twist device, the lug is on the left.



### recommended accessories:

-  lever → 125
-  incandescent lamp → 132; LED → 133
-  switching element for keylock-/selector switch 3 positions → 130
-  anti-twisting ring → 135



	switching action	18 mm dia. part no.	circuit drawing	technical drawing	mounting dimension	
<b>selector switch actuator 3 positions</b> pos. C: maintained action pos. A: basic position pos. B: maintained action	main-0-main	<b>61-4610.0</b>	17	7	1	0,006
pos. C: maintained action pos. A: basic position pos. B: momentary action	main-0-mom	<b>61-4710.0</b>	16	7	1	0,006
pos. C: momentary action pos. A: basic position pos. B: maintained action	mom-0-main	<b>61-4810.0</b>	15	7	1	0,006
pos. C: momentary action pos. A: basic position pos. B: momentary action	mom-0-mom	<b>61-4510.0</b>	14	7	1	0,006

switching action: mom = momentary, main = maintaining, 0 = basic position

technical drawing as of page 140. mounting dimensions as of page 145. circuit drawing as of page 150

## indicator complete for flush mounting



### recommended accessories:

-  lens plastic for flush mounting → 124
-  front bezel-set for flush mounting → 126
-  incandescent lamp → 132; LED → 133

	connection method	part no.	circuit drawing	technical drawing	mounting dimension	
<b>indicator complete for flush mounting</b>	ST/PT	<b>61-0000.02</b>	1	8	3	0,006

connection method: ST/PT = soldering-/plug-in terminal





marking see page 153

technical drawing as of page 140, mounting dimensions as of page 145, circuit drawing as of page 150

## indicator-/flasher-actuator for flush mounting



### recommended accessories:

-  lens plastic for flush mounting → 124
-  front bezel-set for flush mounting → 126
-  incandescent lamp → 132; LED → 133
-  lamp element → 128; diode element → 128; flasher element → 131

	part no.	circuit drawing	technical drawing	mounting dimension	
<b>indicator-/flasher-actuator for flush mounting</b>	<b>61-0009.0</b>	1	9	3	0,005

marking see page 153

technical drawing as of page 140, mounting dimensions as of page 145, circuit drawing as of page 150

## illuminated-/pushbutton actuator for flush mounting



### recommended accessories:

- lens plastic for flush mounting → 124; lens metal with window → 124; lens metal → 124
- front bezel-set for flush mounting → 126
- incandescent lamp → 132; LED → 133
- switching element for illuminated-/pushbutton, keylock-/selector switch 2 positions → 129

	switching action	part no.	circuit drawing	technical drawing	mounting dimension	
<b>illuminated-/pushbutton actuator for flush mounting</b>	mom/main	<b>61-1300.0</b>	19	10	3	0,005
	mom	<b>61-1100.0</b>	19	10	3	0,005
	main	<b>61-1200.0</b>	18	10	3	0,005

switching action: main = maintained action, mom = momentary action, mom/main = momentary-/maintained action

[marking see page 153](#)

[technical drawing as of page 140. mounting dimensions as of page 145. circuit drawing as of page 150](#)

## mushroom pushbutton actuator for flush mounting



### recommended accessories:

- mushroom-head cap → 124
- front bezel-set round for flush mounting → 126
- switching element for illuminated-/pushbutton, keylock-/selector switch 2 positions → 129

	switching action	part no.	circuit drawing	technical drawing	mounting dimension	
<b>mushroom pushbutton actuator for flush mounting</b>	mom/main	<b>61-1300.0</b>	3	11	2	0,006
	mom	<b>61-1100.0</b>	3	11	2	0,006
	main	<b>61-1200.0</b>	2	11	2	0,006

switching action: main = maintained action, mom = momentary action, mom/main = momentary-/maintained action

[technical drawing as of page 140. mounting dimensions as of page 145. circuit drawing as of page 150](#)

## keylock switch actuator with 2 positions for flush mounting



### recommended accessories:

-  keylock front bezel → 124
-  front bezel-set for flush mounting → 126
-  switching element for illuminated-/pushbutton, keylock-/selector switch 2 positions → 129

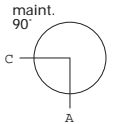
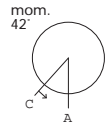
	switching action	key removable in	part no.	mounting dimension			
				circuit drawing	technical drawing		
  <p><b>keylock switch actuator with 2 positions for flush mounting</b>                      pos. A: basic position                      pos. C: maintained action                      standard lock 311,                      other lock numbers on request</p>	main	A	<b>61-2201.0/D</b>	6	12	3	0,003
		C	<b>61-2203.0/D</b>	6	12	3	0,003
		C + A	<b>61-2205.0/D</b>	6	12	3	0,003
pos. A: basic position pos. C: momentary action standard lock 311, other lock numbers on request	mom	A	<b>61-2101.0/D</b>	5	12	3	0,003

switching action: main = maintained action, mom = momentary action



[description see page 109](#)

[technical drawing as of page 140](#), [mounting dimensions as of page 145](#), [circuit drawing as of page 150](#)

## keylock switch actuator 3 positions for flush mounting



### recommended accessories:

-  keylock front bezel → 124
-  front bezel-set for flush mounting → 126
-  switching element for keylock-/selector switch 3 positions → 130



	switching action	key removable in	part no.	circuit drawing			technical drawing			mounting dimension	
<b>keylock switch actuator 3 positions for flush mounting</b> pos. C: maintained action pos. A: basic position Pos. B: momentary action standard lock 311, other lock numbers on request	main-0-mom	A	<b>61-2701.0/D</b>	10	12	3	0,003				
		C	<b>61-2703.0/D</b>	5	12	3	0,003				
		C + A	<b>61-2705.0/D</b>	10	12	3	0,003				
pos. C: maintained action pos. A: basic position pos. B: maintained action standard lock 311, other lock numbers on request	main-0-main	A	<b>61-2601.0/D</b>	11	12	3	0,003				
		A+B	<b>61-2604.0/D</b>	11	12	3	0,003				
		B	<b>61-2602.0/D</b>	11	12	3	0,003				
		C	<b>61-2603.0/D</b>	11	12	3	0,003				
		C + A	<b>61-2605.0/D</b>	11	12	3	0,003				
		C+A+B	<b>61-2607.0/D</b>	11	12	3	0,003				
		C+B	<b>61-2606.0/D</b>	11	12	3	0,003				
pos. C: momentary action pos. A: basic position pos. B: maintained action standard lock 311, other lock numbers on request	mom-0-main	A	<b>61-2801.0/D</b>	9	12	3	0,003				
		A+B	<b>61-2804.0/D</b>	9	12	3	0,003				
		B	<b>62-2802.0/D</b>	9	12	3	0,003				
pos. C: momentary action pos. A: basic position pos. B: momentary action standard lock 311, other lock numbers on request	mom-0-mom	A	<b>61-2501.0/D</b>	8	12	3	0,003				

switching action: mom = momentary action, main = maintained action, 0 = basic position

[description see page 109](#)

[technical drawing as of page 140. mounting dimensions as of page 145. circuit drawing as of page 150](#)

## selector switch actuator 2 positions for flush mounting



### recommended accessories:

-  lever for flush mounting → 125
-  front bezel-set for flush mounting → 126
-  incandescent lamp → 132; LED → 133
-  switching element for illuminated-/pushbutton, keylock-/selector switch 2 positions → 129



	switching action	part no.	circuit drawing	technical drawing	mounting dimension	
<b>selector switch actuator 2 positions for flush mounting</b> pos. C: maintained action pos. A: basic position	main	<b>61-4210.0</b>	13	13	3	0,006
pos. C: momentary action pos. A: basic position	mom	<b>61-4110.0</b>	12	13	3	0,006





switching action: main = maintained action, mom = momentary action

technical drawing as of page 140, mounting dimensions as of page 145, circuit drawing as of page 150

## selector switch actuator 3 positions for flush mounting



### recommended accessories:

-  lever for flush mounting → 125
-  front bezel-set for flush mounting → 126
-  incandescent lamp → 132; LED → 133
-  switching element for keylock-/selector switch 3 positions → 130

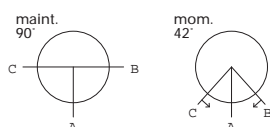

	switching action	part no.	circuit drawing	technical drawing	mounting dimension	
<b>selector switch actuator 3 positions for flush mounting</b> pos. C: maintained action pos. A: basic position pos. B: maintained action	main-0-main	<b>61-4610.0</b>	17	13	3	0,006
pos. C: maintained action pos. A: basic position pos. B: momentary action	main-0-mom	<b>61-4710.0</b>	16	13	3	0,006
pos. C: momentary action pos. A: basic position pos. B: maintained action	mom-0-main	<b>61-4810.0</b>	15	13	3	0,006
pos. C: momentary action pos. A: basic position pos. B: momentary action	mom-0-mom	<b>61-4510.0</b>	14	13	3	0,006

switching action: mom = momentary, main = maintaining, 0 = basic position

technical drawing as of page 140, mounting dimensions as of page 145, circuit drawing as of page 150





## at front

### lens plastic



	shape	lens/sup- port	colour	⌀ 18 x 24 mm part no.	⌀ 24 x 24 mm part no.	18 mm dia. part no.	⌀ 18 x 18 mm part no.	25 mm dia. part no.	kg		
<b>lens plastic matt</b>	con- cave	transpar- ent/trans- lucent	blue	<b>61-9336.6</b>			<b>61-9326.6</b>		0,001		
			colour- less, clear	<b>61-9336.7</b>			<b>61-9326.7</b>		0,001		
			green	<b>61-9336.5</b>			<b>61-9326.5</b>		0,001		
			orange	<b>61-9336.3</b>			<b>61-9326.3</b>		0,001		
			red	<b>61-9336.2</b>			<b>61-9326.2</b>		0,001		
			yellow	<b>61-9336.4</b>			<b>61-9326.4</b>		0,001		
	flat	transpar- ent/trans- lucent	blue				<b>61-9311.6</b>	<b>61-9321.6</b>		0,001	
					<b>61-9331.6</b>	<b>61-9351.6</b>			<b>61-9642.6</b>	0,002	
			colour- less, clear		<b>61-9331.7</b>		<b>61-9311.7</b>	<b>61-9321.7</b>			0,001
						<b>61-9351.7</b>			<b>61-9642.7</b>	0,002	
			green		<b>61-9331.5</b>	<b>61-9351.5</b>	<b>61-9311.5</b>	<b>61-9321.5</b>			0,001
									<b>61-9642.5</b>	0,002	
			orange					<b>61-9321.3</b>			0,001
					<b>61-9331.3</b>	<b>61-9351.3</b>	<b>61-9311.3</b>		<b>61-9642.3</b>	0,002	
			red					<b>61-9321.2</b>			0,001
					<b>61-9331.2</b>	<b>61-9351.2</b>	<b>61-9311.2</b>		<b>61-9642.2</b>	0,002	
			smoked		<b>61-9331.1</b>		<b>61-9311.1</b>				0,001
						<b>61-9351.1</b>		<b>61-9321.1</b>		<b>61-9642.1</b>	0,002
			yellow			<b>61-9351.1</b>		<b>61-9321.1</b>		<b>61-9642.4</b>	0,002
					<b>61-9331.4</b>	<b>61-9351.4</b>	<b>61-9311.4</b>	<b>61-9321.4</b>			0,001
matt (not for film in- sert and LED)	con- cave	translu- cent/ translu- cent	white	<b>61-9236.9</b>			<b>61-9226.9</b>		0,001		
	flat	translu- cent/ translu- cent	white	<b>61-9231.9</b>	<b>61-9251.9</b>	<b>61-9211.9</b>	<b>61-9221.9</b>		0,001		
matt (not for film in- sert and illumina- tion)	con- cave	opaque/ translu- cent	black	<b>61-9236.0</b>			<b>61-9226.0</b>		0,001		
			grey	<b>61-9236.8</b>			<b>61-9226.8</b>		0,001		
	flat	opaque/ translu- cent	black	<b>61-9231.0</b>	<b>61-9251.0</b>	<b>61-9211.0</b>	<b>61-9221.0</b>		0,001		
			grey	<b>61-9231.8</b>	<b>61-9251.8</b>	<b>61-9211.8</b>	<b>61-9221.8</b>		0,001		





## lens plastic for flush mounting

	shape	lens/support	colour	⌀ 24 x 30 mm part no.	⌀ 24 x 24 mm part no.	25 mm dia. part no.		
<b>lens plastic for flush mounting matt</b>	flat	transparent/translucent	blue	<b>61-9681.6</b>	<b>61-9671.6</b>	<b>61-9642.6</b>	0,001	
			colourless, clear	<b>61-9681.7</b>	<b>61-9671.7</b>	<b>61-9642.7</b>	0,001	
			green	<b>61-9681.5</b>	<b>61-9671.5</b>	<b>61-9642.5</b>	0,001	
			orange	<b>61-9681.3</b>	<b>61-9671.3</b>	<b>61-9642.3</b>	0,001	
			red	<b>61-9681.2</b>	<b>61-9671.2</b>	<b>61-9642.2</b>	0,001	
			smoked			<b>61-9642.1</b>	0,001	
yellow	<b>61-9681.4</b>	<b>61-9671.4</b>	<b>61-9642.4</b>	0,001				
matt (not for film insert and LED)	flat	translucent/translucent	white	<b>61-9781.9</b>	<b>61-9771.9</b>		0,001	
matt (not for film insert and illumination)	flat	opaque/translucent	black	<b>61-9781.0</b>	<b>61-9771.0</b>		0,001	
			grey	<b>61-9781.8</b>	<b>61-9771.8</b>		0,001	



## lens metal with window

	shape	lens	colour	25 mm dia. part no.		
<b>lens metal with window matt</b>	flat	aluminium anodized	natural	<b>61-9841.8A</b>	0,002	

## lens metal

	shape	lens	colour	25 mm dia. part no.		
<b>lens metal matt</b>	flat	aluminium anodized	black	<b>61-9841.0</b>	0,002	
			blue	<b>61-9841.6</b>	0,002	
			green	<b>61-9841.5</b>	0,002	
			natural	<b>61-9841.8</b>	0,002	
			red	<b>61-9841.2</b>	0,002	
			yellow	<b>61-9841.4</b>	0,002	

## mushroom-head cap

		colour	32 mm dia. part no.		
<b>mushroom-head cap plastic</b>	mushroom opaque	black	<b>61-9593.0</b>	0,004	
		green	<b>61-9593.5</b>	0,004	
		red	<b>61-9593.2</b>	0,004	
		yellow	<b>61-9593.4</b>	0,004	

## keylock front bezel

for keylock switch actuator

	⌀ 18 x 24 mm part no.	⌀ 24 x 24 mm part no.	18 mm dia. part no.	⌀ 18 x 18 mm part no.		
<b>keylock front bezel</b>	<b>61-9230.0</b>	<b>61-9250.0</b>	<b>61-9210.0</b>	<b>61-9220.0</b>	0,001	

61-9250.0 not for flush mounting

## lever



	colour	colour of bar	part no.		
<b>lever</b> with marking dot and transparent bar	black	black, opaque	<b>52-928.0</b>	0,001	
		blue	<b>52-928.60</b>	0,001	
		green	<b>52-928.50</b>	0,001	
		orange	<b>52-928.30</b>	0,001	
		red	<b>52-928.20</b>	0,001	
		white, opaque	<b>52-928.9</b>	0,001	
		yellow	<b>52-928.40</b>	0,001	
	grey	blue	<b>52-929.60</b>	0,001	
		green	<b>52-929.50</b>	0,001	
		grey, opaque	<b>52-929.8</b>	0,001	
		orange	<b>52-929.30</b>	0,001	
		red	<b>52-929.20</b>	0,001	
		white, opaque	<b>52-929.9</b>	0,001	
		yellow	<b>52-929.40</b>	0,001	

## lever for flush mounting

	colour	colour of bar	part no.		
<b>lever for flush mounting</b> with marking dot and transparent bar	black	black, opaque	<b>61-9028.0</b>	0,001	
		blue	<b>61-9028.60</b>	0,001	
		green	<b>61-9028.50</b>	0,001	
		orange	<b>61-9028.30</b>	0,001	
		red	<b>61-9028.20</b>	0,001	
		white, opaque	<b>61-9028.9</b>	0,001	
		yellow	<b>61-9028.40</b>	0,001	
	grey	blue	<b>61-9029.60</b>	0,001	
		green	<b>61-9029.50</b>	0,001	
		grey, opaque	<b>61-9029.8</b>	0,001	
		orange	<b>61-9029.30</b>	0,001	
		red	<b>61-9029.20</b>	0,001	
		white, opaque	<b>61-9029.9</b>	0,001	
		yellow	<b>61-9029.40</b>	0,001	



## marking plate

for lens round, 61-9642...



	front shape	marking plate	colour	part no.		
<b>marking plate</b> clear, of plastic, can be hot pressed	round	transparent	clear	<b>61-9707.7</b>	0,001	

## front bezel

for selector switch square front



	material	colour	$\varnothing$ 24 x 24 mm part no.	$\varnothing$ 26 x 26 mm part no.		
<b>front bezel</b>	plastic	black	<b>52-950.0</b>	<b>52-952.0</b>	0,001	

## front bezel-set for flush mounting

	use	material	colour	☐ 24 x 30 mm part no.	☐ 24 x 24 mm part no.	∅ 25 mm part no.			
<b>front bezel-set for flush mounting</b>	illuminated pushbutton/indicator	aluminium	natural			<b>61-9933.0</b>	0,006		
		anodized	black			<b>61-9933.1</b>	0,007		
		plastic	aluminium plated		<b>61-9931.4</b>	<b>61-9930.4</b>			0,007
			black		<b>61-9931.0</b>	<b>61-9930.0</b>	<b>61-9933.10</b>		0,006
	keylock switch	aluminium anodized	natural				<b>61-9932.0</b>		0,007
			black				<b>61-9932.1</b>		0,007
		plastic	aluminium plated		<b>61-9931.4</b>	<b>61-9930.4</b>			0,007
			black		<b>61-9931.0</b>	<b>61-9930.0</b>	<b>61-9932.10</b>		0,006
	selector switch	aluminium anodized	natural				<b>61-9932.0</b>		0,006
			black				<b>61-9932.1</b>		0,007
		plastic				<b>61-9936.0</b>	<b>61-9932.10</b>		0,007

## front ring

for actuator 24 mm dia.

	material	colour	part no.		
<b>front ring</b>	aluminium anodized	black	<b>61-9600.0</b>	0,003	
		natural	<b>61-9600.1</b>	0,003	

## protective front membrane cap

for actuator 24 mm dia.

	material	colour	part no.		
<b>protective front membrane cap</b>	silicone nature	transparent	<b>61-9926.7</b>	0,001	

## protective front membrane cap for flush mounting

	material	colour	part no.		
<b>protective front membrane cap for flush mounting</b> for front bezel-set for flush mounting	silicone nature	transparent	<b>84-9103.7</b>	0,001	

## protective cover





	☐ 18 x 24 mm part no.	☐ 18 x 18 mm part no.	☐ 24 x 24 mm part no.	technical drawing		
<b>protective cover</b> hinged, transparent, with means for sealing	<b>51-925</b>			15	0,005	
			<b>61-9920.0</b>	16	0,006	
		<b>51-920</b>		14	0,005	

technical drawing as of page 140

## protective cover for flush mounting

				
	24 x 30 mm part no.	24 x 24 mm part no.		
<b>protective cover for flush mounting</b> hinged, transparent, with means for sealing	<b>61-9922.0</b>	<b>61-9921.0</b>	0,006	

## blind plug projecting

	colour			18 mm dia. part no.		mounting dimension		
		18 x 24 mm part no.	24 x 24 mm part no.		18 x 18 mm part no.			
<b>blind plug projecting</b> for mounting hole 16 mm dia.	black	<b>51-947.0</b>	<b>61-9450.0</b>	<b>51-949.0</b>	<b>51-948.0</b>	1	0,003	



[mounting dimensions as of page 145](#)

## blind plug flat



	colour			28 mm dia. part no.	mounting dimension		
		24 x 30 mm part no.	24 x 24 mm part no.				
<b>blind plug flat</b> for mounting hole 21 x 21 mm	black		<b>61-9451.0</b>		3	0,006	
for mounting hole 21 x 27 mm	black	<b>61-9452.0</b>			3	0,006	
for mounting hole 22.5 mm dia.	black			<b>704.960.7</b>	3	0,006	

[mounting dimensions as of page 145](#)

## EMC key protection cap



	part no.		
<b>EMC key protection cap</b> plastic black, for lock type DOM	<b>31-985.0</b>		

## spare key

	part no.		
<b>spare key</b> for emergency stop switch with key to release, lock type KABA standard lock 1001, other lock numbers on request	<b>14-987.1001</b>	0,006	
for keylock switch, lock type DOM standard lock 311, other lock numbers on request	<b>31-989.311</b>	0,006	



[description see page 109](#)

## master key

	part no.		
<b>master key</b> for lock numbers 311-445	<b>31-989.300</b>	0,006	



## at back

### lamp element

	part no.	circuit drawing		
<b>lamp element</b> with screw terminal	<b>61-8006.01</b>	1	0,005	

[circuit drawing as of page 150](#)

### diode element

	number of diodes	part no.	circuit drawing	components layout		
<b>diode element</b> with soldering-/plug-in terminal	1	<b>61-8101.02</b>	20	1	0,007	
	2	<b>61-8102.02</b>	21	2	0,008	

[components layouts as of page 146, circuit drawing as of page 150](#)

## switching element for illuminated-/pushbutton, keylock-/selector switch 2 positions

	diode (1N 4007)	switching system	contacts	connection method	material of contacts	part no.	circuit drawing	components layout	
switching element for illuminated-/pushbutton, keylock-/selector switch 2 positions with lamp terminal, max. 250 VAC/6A	-	SA	1NC	ST/PT	gold/silver	<b>61-8440.22</b>	23	3	0,007
					silver	<b>61-8440.12</b>	23	3	0,007
			1NC + 1NO	ST/PT	gold/silver	<b>61-8470.22</b>	31	15	0,007
					silver	<b>61-8470.12</b>	31	15	0,007
			1NC + 2NO	ST/PT	gold/silver	<b>61-8490.22</b>	33	16	0,007
					silver	<b>61-8490.12</b>	33	16	0,007
			1NO	ST/PT	gold/silver	<b>61-8410.22</b>	28	12	0,007
					silver	<b>61-8410.12</b>	28	12	0,007
			2NC	ST/PT	gold/silver	<b>61-8450.22</b>	25	4	0,007
					silver	<b>61-8450.12</b>	25	4	0,007
			2NC + 1NO	ST/PT	gold/silver	<b>61-8480.22</b>	32	6	0,007
					silver	<b>61-8480.12</b>	32	6	0,007
			2NO	ST/PT	gold/silver	<b>61-8420.22</b>	35	13	0,007
					silver	<b>61-8420.12</b>	35	-	0,007
			3NC	ST/PT	gold/silver	<b>61-8460.22</b>	26	5	0,007
					silver	<b>61-8460.12</b>	26	5	0,007
			3NO	ST/PT	gold/silver	<b>61-8430.22</b>	36	14	0,007
					silver	<b>61-8430.12</b>	36	14	0,007
T	1NC	SCH	silver	<b>61-8640.11</b>	22	-	0,008		
			silver	<b>61-8610.11</b>	28	13	0,008		
2	SA	1NO + 2D	ST/PT	silver	<b>61-8212.12</b>	29	17	0,007	
				gold/silver	<b>61-8212.22</b>	29	17	0,007	
with lamp terminal, max. 42 VAC/DC/100 mA	-	T	1NC	ST/PT	gold	<b>61-8640.37</b>	23	10	0,008
					gold	<b>61-8670.37</b>	31	9	0,008
					gold	<b>61-8610.37</b>	28	7	0,008
					gold	<b>61-8650.37</b>	25	11	0,008
					gold	<b>61-8620.37</b>	35	8	0,008
with lamp terminal, max.250 VAC/5A	-	T	1NC	ST/PT	silver	<b>61-8640.17</b>	23	10	0,008
					silver	<b>61-8670.17</b>	31	9	0,008
					silver	<b>61-8610.17</b>	28	7	0,008
					silver	<b>61-8650.17</b>	25	11	0,008
					silver	<b>61-8620.17</b>	35	8	0,008
without lamp terminal, max. 250 VAC/6 A	-	T	1NC	SCH	silver	<b>61-8645.11</b>	22	-	0,008
					silver	<b>61-8675.11</b>	30	-	0,008
					silver	<b>61-8615.11</b>	27	-	0,008
					silver	<b>61-8655.11</b>	24	-	0,008
					silver	<b>61-8625.11</b>	34	-	0,008



switching system: SA = snap-action switching element, T = slow-make switching element  
 connection method: SCH = screw terminal, ST/PT = soldering-/plug-in terminal  
 contacts: NC = normally closed, NO = normally open  
 components layouts as of page 146, circuit drawing as of page 150

## switching element for emergency stop switch

	switching system	contacts	connection method	material of contacts	part no.	circuit drawing	components layout	
<b>switching element for emergency stop switch</b> max. 250 VAC/5A	T	1NC	ST/PT	silver	<b>61-8745.17</b>	37	19	0,008
		1NC + 1NO	ST/PT	silver	<b>61-8775.17</b>	39	18	0,008
		2NC	ST/PT	silver	<b>61-8755.17</b>	38	20	0,008
max. 250 VAC/6A	T	1NC	SCH	silver	<b>61-8745.11</b>	37	-	0,008
		1NC + 1NO	SCH	silver	<b>61-8775.11</b>	39	-	0,008
		2NC	SCH	silver	<b>61-8755.11</b>	38	-	0,008
max. 42 VAC/DC/100 mA	T	1NC	ST/PT	gold	<b>61-8745.37</b>	37	19	0,008
		1NC + 1NO	ST/PT	gold	<b>61-8775.37</b>	39	18	0,008
		2NC	ST/PT	gold	<b>61-8755.37</b>	38	20	0,008



switching system: T = slow-make switching element  
 connection method: SCH = screw terminal, ST/PT = soldering-/plug-in terminal  
 contacts: NC = normally closed, NO = normally open  
 components layouts as of page 146, circuit drawing as of page 150

## switching element for keylock-/selector switch 3 positions



	switching system	contacts	connection method	material of contacts	part no.	circuit drawing	components layout	
<b>switching element for keylock-/selector switch 3 positions</b> with lamp terminal, max. 250 VAC/6A	SA	1NC + 1NO	ST/PT	gold/silver	<b>61-8574.22</b>	31	23	0,008
				silver	<b>61-8574.12</b>	31	23	0,008
		2NC	ST/PT	gold/silver	<b>61-8550.22</b>	25	21	0,008
				silver	<b>61-8550.12</b>	25	21	0,008
with lamp terminal, max. 42 VAC/DC/100 mA	T	1NC + 1NO	ST/PT	gold	<b>61-8770.37</b>	31	24	0,008
				gold	<b>61-8750.37</b>	25	26	0,008
		2NO	ST/PT	gold	<b>61-8720.37</b>	35	25	0,008
with lamp terminal, max.250 VAC/5A	T	1NC + 1NO	ST/PT	silver	<b>61-8770.17</b>	31	24	0,008
				silver	<b>61-8750.17</b>	25	26	0,008
		2NO	ST/PT	silver	<b>61-8720.17</b>	35	25	0,008
without lamp terminal, max. 250 VAC/6 A	T	1NC + 1NO	SCH	silver	<b>61-8775.11</b>	31	-	0,008
				silver	<b>61-8755.11</b>	24	-	0,008
		2NO	SCH	silver	<b>61-8725.11</b>	35	-	0,008



switching system: SA = snap-action switching element, T = slow-make switching element  
 connection method: SCH = screw terminal, ST/PT = soldering-/plug-in terminal  
 contacts: NC = normally closed, NO = normally open  
 components layouts as of page 146, circuit drawing as of page 150



## flasher element

	operation voltage	connection method	part no.		
<b>flasher element</b>	12 VAC/DC - 28 VAC/DC	ST	<b>61-8000.05</b>		

connection method: ST = soldering terminal  
 typical applications see page 151  
 circuit drawing as of page 150



## PCB plug-in base

for plug-in terminal

	for	pin orientation	part no.	components layout		
<b>PCB plug-in base</b> 13.1 mm dia. x 12.8 mm	indicator complete	axial	<b>61-9820.1</b>	27	0,002	
15 mm x 23 mm x 9.4 mm	slow-make switching element	axial	<b>61-9823</b>	29	0,002	
17.7 mm x 23.6 mm x 10.9 mm	snap-action switching element	axial	<b>61-9821.1</b>	28	0,003	

components layouts as of page 146

## multi-plug housing

	part no.		
<b>multi-plug housing</b> for snap-action switching element, max. 6 connections possible	<b>61-9830</b>	0,002	

## cable shoe

	connection method	part no.		
<b>cable shoe</b>	plug in terminal 2,8 x 0,5 mm	<b>31-946</b>	0,001	
	plug-in terminal 2,8 x 0,5 mm for multi-plug housing	<b>51-943.1</b>	0,001	



## terminal cover



	use	part no.		
terminal cover	for indicator element	<b>61-9831.2</b>	0,001	
	for snap-action switching element	<b>61-9830.2</b>	0,002	

## for illumination



### incandescent lamp

	voltage/current	part no.		
incandescent lamp base MG T 1 3/4	6 AC/DC/125 mA	<b>10-1306.1349 (41-963.0)</b>	0,001	
	6.3 AC/DC/200 mA	<b>10-1307.1369 (31-963.0)</b>	0,001	
	12 AC/DC/75 mA	<b>10-1309.1309 (41-963.1)</b>	0,001	
	14 AC/DC/80 mA	<b>10-1310.1319 (31-963.1)</b>	0,001	
	18 AC/DC/40 mA	<b>10-1311.1249 (41-963.2)</b>	0,001	
	24 AC/DC/35 mA	<b>10-1312.1229 (41-963.3)</b>	0,001	
	28 AC/DC/30 mA	<b>10-1313.1209 (41-963.4)</b>	0,001	
	28 AC/DC/40 mA	<b>10-1313.1249 (31-963.2)</b>	0,001	
	36 AC/DC/20 mA	<b>10-1316.1179 (41-963.36)</b>	0,001	
	36 AC/DC/30 mA	<b>10-1316.1209 (31-963.5)</b>	0,001	
	48 AC/DC/20 mA	<b>10-1319.1179 (41-963.5)</b>	0,001	
	48 AC/DC/25 mA	<b>10-1319.1199 (31-963.3)</b>	0,001	
	60 AC/DC/20 mA	<b>10-1320.1179 (31-963.4)</b>	0,001	

LED						
	number of chips	voltage/current	colour	part no.		
<b>LED</b> base MG T1 3/4	6 chips	6 VDC/45 mA	green	<b>10-5306.3255 (31-968.05)</b>	0,001	
			red	<b>10-5306.3252 (31-968.02)</b>	0,001	
			yellow	<b>10-5306.3254 (31-968.04)</b>	0,001	
		12 VDC/30 mA	green	<b>10-5309.3205 (31-968.15)</b>	0,001	
			red	<b>10-5309.3202 (31-968.12)</b>	0,001	
			yellow	<b>10-5309.3204 (31-968.14)</b>	0,001	
		24 VAC/DC/12.5 mA	green	<b>10-5312.1115 (22-996.51)</b>	0,001	
			red	<b>10-5312.1112 (22-996.21)</b>	0,001	
			yellow	<b>10-5312.1114 (22-996.41)</b>	0,001	
		24 VDC/14 mA	green	<b>10-5312.3135 (31-968.25)</b>	0,001	
			red	<b>10-5312.3132 (31-968.22)</b>	0,001	
			yellow	<b>10-5312.3134 (31-968.24)</b>	0,001	
		28 VAC/DC/12.5 mA	green	<b>10-5313.1115 (22-997.51)</b>	0,001	
			red	<b>10-5313.1112 (22-997.21)</b>	0,001	
			yellow	<b>10-5313.1114 (22-997.41)</b>	0,001	
		28 VDC/14 mA	green	<b>10-5313.3135 (22-997.5)</b>	0,001	
			red	<b>10-5313.3132 (22-997.2)</b>	0,001	
			yellow	<b>10-5313.3134 (22-997.4)</b>	0,001	
	48 VDC/12 mA	green	<b>10-5319.3105 (31-968.45)</b>	0,001		
		red	<b>10-5319.3102 (31-968.42)</b>	0,001		
		yellow	<b>10-5319.3104 (31-968.44)</b>	0,001		
	8 chips	6 VDC/48 mA	green	<b>10-6306.3265 (61-994.5)</b>	0,001	
			red	<b>10-6306.3262 (61-994.2)</b>	0,001	
			yellow	<b>10-6306.3264 (61-994.4)</b>	0,001	
		12 VDC/24 mA	green	<b>10-6309.3185 (61-995.5)</b>	0,001	
			red	<b>10-6309.3182 (61-995.2)</b>	0,001	
			yellow	<b>10-6309.3184 (61-995.4)</b>	0,001	
		24 VDC/12 mA	green	<b>10-6312.3105 (61-996.5)</b>	0,001	
			red	<b>10-6312.3102 (61-996.2)</b>	0,001	
			yellow	<b>10-6312.3104 (61-996.4)</b>	0,001	
		28 VDC/12 mA	green	<b>10-6313.3105 (96-997.5)</b>	0,001	
			red	<b>10-6313.3102 (61-997.2)</b>	0,001	
			yellow	<b>10-6313.3104 (61-997.4)</b>	0,001	
	1 chip	24 VDC/14 mA	white	<b>10-2312.3139</b>	0,001	
		28 VDC/14 mA	white	<b>10-2313.3139</b>	0,001	

capacitor				
for lamp voltage reduction				
	value	part no.		
<b>capacitor</b> use with 60 VAC/20 mA, 50 Hz lamp voltage	230 VAC/0.27 µF	<b>02-917.0</b>	0,004	

Wire in accordance with local electrical safety regulations.

series resistor				
for lamp voltage reduction				
	value	part no.		
<b>series resistor</b> use with 60 VAC/20 mA lamp rating	110 V/2.7 kOhm	<b>02-904.0</b>	0,003	
	125 V/3.3 kOhm	<b>02-904.1</b>	0,003	
	145 V/4.7 kOhm	<b>02-904.3</b>	0,003	
	230-240 V/10 kOhm	<b>02-904.7</b>	0,003	



Wire in accordance with local electrical safety regulations.

## terminal plate empty

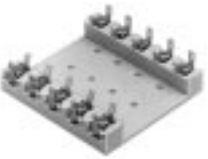

for fitting with series resistors and capacitors

	no. of spaces	part no.		
<b>terminal plate empty</b>	5 spaces	<b>02-912.1</b>	0,025	
	10 spaces	<b>02-912.2</b>	0,045	
	15 spaces	<b>02-912.3</b>	0,090	
	20 spaces	<b>02-912.4</b>	0,095	

## terminal plate with capacitor

	value	no. of components	part no.		
<b>terminal plate with capacitor</b> use with 60 VAC/20 mA lamp rating	0,27 µF/230 VAC/60 VAC	5 spaces	<b>02-914.10</b>	0,045	
		10 spaces	<b>02-914.20</b>	0,090	
		15 spaces	<b>02-914.30</b>	0,135	
		20 spaces	<b>02-914.40</b>	0,180	



## terminal plate with series resistor

	value	no. of components	part no.		
<b>terminal plate with series resistor</b> use with 60 VAC/20 mA lamp rating	2.7 kOhm/110/60 V	5 spaces	<b>02-913.10</b>	0,040	
		10 spaces	<b>02-913.20</b>	0,075	
		15 spaces	<b>02-913.30</b>	0,115	
		20 spaces	<b>02-913.40</b>	0,155	
	3.3 kOhm/125/60 V	5 spaces	<b>02-913.11</b>	0,040	
		10 spaces	<b>02-913.21</b>	0,075	
		15 spaces	<b>02-913.31</b>	0,115	
		20 spaces	<b>02-913.41</b>	0,155	
	10 kOhm/230-240/60 V	5 spaces	<b>02-913.17</b>	0,040	
		10 spaces	<b>02-913.27</b>	0,075	
		15 spaces	<b>02-913.37</b>	0,115	
		20 spaces	<b>02-913.47</b>	0,155	



Wire in accordance with local electrical safety regulations.

## for emergency stop switch

### label for emergency stop switch

	marking	43 mm dia. part no.		
<b>label for emergency stop switch</b> 43 mm dia., yellow	ARRET D'URGENCE	<b>61-9970.3</b>	0,002	
	Emergency Stop	<b>61-9970.2</b>	0,002	
	NOT-AUS	<b>61-9970.1</b>	0,002	
	without marking	<b>61-9970.0</b>	0,002	

### protective shroud for emergency stop switch

	part no.		
<b>protective shroud for emergency stop switch</b> aluminium anodized, yellow	<b>61-9965</b>		

## enclosure for emergency stop switch

	part no.	 kg	
<b>enclosure for emergency stop switch</b> with mounting hole size 16 mm dia. colour RAL 1004. dimensions: 65 mm long, 65 mm wide, 57 mm high front protection IP 65	<b>61-9480.4</b>	0,079	

## cable gland PG11

	part no.		
<b>cable gland PG11</b>	<b>61-9481.8</b>		

## assembling

### anti-twisting ring



	part no.	 kg	
<b>anti-twisting ring</b> for key- and selector switch	<b>51-910.0</b>	0,002	

### reducing ring

for 16 mm pushbuttons in mounting hole 22.5 mm dia.

	part no.	 kg	
<b>reducing ring</b> only for use of front dimension: 24 x 24 mm/24 mm dia.	<b>61-9960</b>	0,003	



## tool-set

	part no.	 kg	
<b>tool-set</b> consists of lens remover, lamp remover, mounting tool, dismantling tool	<b>K61-999.100</b>		

## lens remover



	use	part no.	 kg	
<b>lens remover</b>	for 24 x 24 mm, 25 mm dia. front and overhanging lenses	<b>61-9730.0</b>	0,011	
	for standard lenses	<b>02-905</b>	0,011	

## lamp/LED remover



	part no.	 kg	
lamp/LED remover	<b>61-9740.0</b>	0,003	

## dismantling tool for lens



for dismantling of lens and lensholder

	part no.	 kg	
dismantling tool for standard lens	<b>51-938</b>	0,027	
dismantling tool for lens for flush mounting	<b>61-9832</b>	0,024	



## dismantling tool for switching element

	part no.	 kg	
dismantling tool for switching element	<b>61-9711.0</b>	0,004	

## mounting tool

	part no.	 kg	
mounting tool for tightening (or loosening) fixing nuts	<b>01-907</b>	0,020	

## cable shoe remover

	part no.	 kg	
cable shoe remover for removing the connector from the multi-plug housing	<b>51-943.9</b>	0,001	

## actuator with snap-action switching element

### switching system

Self-cleaning, double-break, snap-action switching elements (contact gap 2 x 0.5 mm).

The elements can be supplied with the following choice of switching functions:

for illuminated pushbutton or switch actuator with 2 positions: max. 3 normally open contacts, max. 3 normally closed contacts or combined

switch actuator with 3 positions:

max. 2 normally open contacts, max. 2 normally closed contacts or combined

The switching element can be easily snapped to or dismantled from the actuator.

### material

#### actuator case

polyetherimide PEI, self-extinguishing

#### front bezel

polyetherimide PEI and chromium plated

#### front ring

of aluminium

#### lenses

polymethylmethacrylat PMMA, polycarbonate PC, aluminium (mushroom head cap: polyamide PA)

#### material of contacts

gold-plated silver or silver

#### switching element

diallyl phthalate DAP, self-extinguishing, polysulfone PSU

### mechanical characteristics

#### actuating force

measured at the lens of the illuminated pushbutton:  
2.7-10 N, depending on the number of switching elements

#### actuating torque

measured at the lever or key of the selector-or keylock switch:  
2.5 - 10 Ncm, depending on the number of switching elements

#### actuating travel

illuminated pushbutton :3 mm

switch actuator with 2 positions:

1 x ca. 42° deflection momentary action

1 x ca. 90° deflection maintained action

switch actuator with 3 positions:

2 x ca. 42° deflection momentary action

2 x ca. 90° deflection maintained action

#### ambient air temperature

-25°C to +55°C

for indicators and illuminated pushbuttons mounted as a block, make sure the heat can escape freely (as per DIN IEC 68-)

#### connection method

universal terminal (soldering-/plug-in terminal):

max. wire diameter: 2 of 1 mm

max. wire cross-section of stranded cable: 1 x 0.75 mm<sup>2</sup> soldering-/plug-in terminal: 2.8 x 0.5 mm

### degree of protection

indicator, illuminated pushbutton, emergency stop switch, selector- and keylock switch: front IP 65

switching element IP 40

soldering terminal IP 20

### mechanical life

as per IEC 512-5-6

momentary action 2 mio. cycles of operation

maintained action 1 mio. cycles of operation

keylock switch 50000 cycles of operation

selector switch 100000 cycles of operation

### rebound time

<= 5ms

### resistance to shock

(single impacts, semi-sinusoidal)

50 g, 11 ms as per IEC 512-4-3, IEC 68-2-27

### resistance to vibration

(sinusoidal)

10 g, at 10- 2000- 10 Hz, amplitude 0.75 mm as per IEC 512-4-4, IEC 68-2-6

### storage temperature

-40°C to + 85°C

(as per DIN IEC 68-)

### electrical characteristics

#### continuous thermal current I<sub>th2</sub>

5 A

The maximum current in continuous operation and at ambient temperature not exceeding the quoted maximum values.

#### electric strength

as per VDE 0630 (IEC 512-2-11)

2500 VAC, 50 Hz, 1 min between all terminals and earth

#### electrostatic breakdown value

>= 11 KV (keylock switch)

#### protection class

II

#### rated current

6 A

#### rated voltage

250 VAC/VDC

#### switch rating

gold-/silver contact:

min. 5 VAC/10 mA

max. 250 VAC/6 A

silver contact:

min. 20 VAC/500 mA

max. 250 VAC/6 A

switch rating AC, cos. φ 0,7:

rated service voltage	250 VAC	125 VAC	110 VAC
-----------------------	---------	---------	---------

rated service current	2 A	3 A	3 A
-----------------------	-----	-----	-----

switch rating DC, L:R=30 ms:

rated service voltage:	220	110	60	24 VDC
------------------------	-----	-----	----	--------

rated service current				
-----------------------	--	--	--	--

resistive:	0.5	0.7	2.0	6.0 A
------------	-----	-----	-----	-------

rated service current				
-----------------------	--	--	--	--

L:R=30ms:	0.15	0.3	0.7	2.0 A
-----------	------	-----	-----	-------

#### volume resistance

starting value (initial) for:

gold-/silver contact <= 50 mΩ as per IEC 512-2-test 4

silver contact <= 100 mΩ as per IEC 512-2-test 5

# Technical Data

## rules

IEC 1058 EN 61 058

## approvals

- SEV 250 VAC/6 A
- CSA 300 VAC
- UR 250 VAC/6 A
- VDE 250 VAC/6 A
- German Lloyd

## actuator with slow-make switching element

## switching system

Self-cleaning, double-break, snap-action switching elements (contact gap 2 x 1.5 mm).

The elements can be supplied with the following choice of switching functions:

for illuminated pushbutton or switch actuator with 2 positions:  
max. 2 normally open contacts, max. 2 normally closed contacts or combined

for switch actuator with 3 positions:  
max. 2 normally open contacts, max. 2 normally closed contacts or combined

The switching element can be easily snapped to or dismantled from the actuator.

## material

### actuator case

polyetherimide PEI, self-extinguishing

### front bezel

polyetherimide PEI and chromium plated

### front ring

of aluminium

### lenses

polymethylmethacrylat PMMA, polycarbonate PC, aluminium (mushroom head cap: polyamide PA)

### material of contacts

gold (low level), silver

### switching element

polyamide PA, polysulfone PSU

## mechanical characteristics

### actuating force

measured at the lens of the illuminated pushbutton:  
3.5-20 N, depending on the number of switching elements

measured at the mushroom head cap of the emergency stop switch:  
max. 65 N

### actuating torque

measured at the lever or key of the selector-or keylock switch:  
4-16 Ncm, depending on the number of switching elements  
emergency stop switch: 15 Ncm

## actuating travel

illuminated pushbutton :3 mm

emergency stop switch:10 mm

switch actuator with 2 positions:

1 x ca. 42° deflection momentary action

1 x ca. 90° deflection maintained action

switch actuator with 3 positions:

2 x ca. 42° deflection momentary action

2 x ca. 90° deflection maintained action

## ambient air temperature

-25°C to +55°C

for indicators and illuminated pushbuttons mounted as a block ,  
make sure the heat can escape freely  
(as per DIN IEC 68-)

## connection method

universal terminal (soldering-/plug-in terminal):

max. wire diameter: 2 of 1 mm

max. wire cross-section of stranded cable: 1 x 0.75 mm<sup>2</sup>

soldering-/plug-in terminal: 2.8 x 0.5 mm

screw terminal:

max. wire cross-section of stranded cable: 1 x 1 mm<sup>2</sup>

## degree of pollution

3

## degree of protection

indicator, illuminated pushbutton, emergency stop switch, selector-  
and keylock switch: front IP 65

switching element IP 40

screw terminal IP 20 as per VDE 0106 Teil 100

## mechanical life

as per IEC 512-5-6

momentary action 2 mio. cycles of operation

maintained action 1 mio. cycles of operation

keylock switch 50000 cycles of operation

selector switch 100000 cycles of operation

emergency stop switch 50000 cycles of operation

## rebound time

<= 2 ms

## resistance to shock

(single impacts, semi-sinusoidal)

50 g, 11 ms as per IEC 512-4-3, IEC 68-2-27

## resistance to vibration

(sinusoidal)

10 g, at 10- 2000- 10 Hz, amplitude 0.75 mm as per IEC 512-4-4,  
IEC 68-2-6

## storage temperature

-40°C to + 85°C

(as per DIN IEC 68-)

## electrical characteristics

### continuous thermal current Ith<sub>2</sub>

universal terminal 5 A

screw terminal 10 A

The maximum current in continuous operation and at ambient temperature not exceeding the quoted maximum values.

### electric strength

as per VDE 0630 (IEC 512-2-11)

4000 VAC, 50 Hz, 1 between all terminals and earth

### electrical life

switching element of emergency stop switch 6'050 cycles of operation



# Technical Data

## electrostatic breakdown value

>= 11 KV (keylock switch)

## max. permissible rated current

10 A gL

## over voltage category

III

## protection class

II

## rated current

6 A

## rated voltage

300 V

## switch rating

gold contact (universal terminal, Low Level):

min. 100  $\mu$ V/10  $\mu$ A

max. 42 VAC/100 mA;

silver contact (universal terminal):

min. 20 VAC/10 mA

max. 250 VAC/5 A

silver contact (screw terminal):

min. 20 VAC/10 mA

max. 250 VAC/6 A

switch rating AC:

rated service voltage	250	120	60	24 VAC
-----------------------	-----	-----	----	--------

rated service current AC 13	3 A	5 A	6 A	6 A
-----------------------------	-----	-----	-----	-----

rated service current AC 14*	2 A	3 A	4 A	5 A
------------------------------	-----	-----	-----	-----

rated service current AC 15**	2 A			
-------------------------------	-----	--	--	--

\*only for emergency stop switch with universal terminal

\*\*only for emergency stop switch with screw terminal

switch rating DC :

rated service voltage:	240	110	60	24 VDC
------------------------	-----	-----	----	--------

rated service current resistive:	0,5	0,7	2,0	6,0 A
----------------------------------	-----	-----	-----	-------

rated service current L:R=30 ms:	0.2	0.4	1.0	2.0 A
----------------------------------	-----	-----	-----	-------

## volume resistance

starting value (initial) for:

gold contact <= 50 m $\Omega$  as per IEC 512-2-test 4

silver contact <= 50 m $\Omega$  as per IEC 512-2-test 5

## electrical characteristics

### flashing frequency

1 Hz  $\pm$  0.25 Hz

### illumination

incandescent lamp: 14 V, 80 mA or 28 V, 40 mA

Multi-LED: 12 V, 25 mA or 24 V, 12.5 mA

### making cycle

1:1

### operating voltage

AC or DC

12 - 10% or 28 V + 10%

## rules

IEC 947-5-1 EN 60 947

## approvals

- SEV 250 VAC
- CSA
- UL
- VDE

## actuator with flasher element

## material

### actuator case

polyetherimide PEI, self-extinguishing

### lenses

polymethylmethacrylat PMMA, polycarbonate PC

## mechanical characteristics

### ambient air temperature

0°C to + 45°C

(as per DIN IEC 68-)

### connection method

soldering terminal 2.8 x 0.8 mm

## technical drawing

### 1 indicator complete

page 111

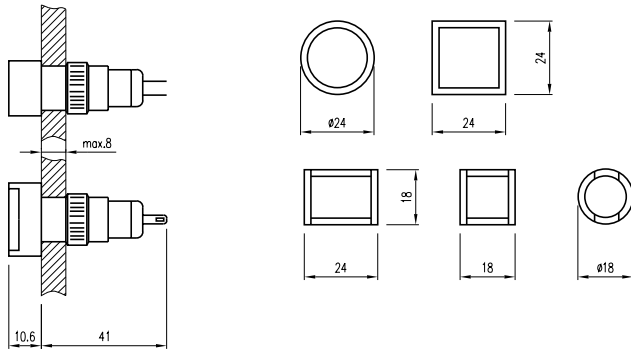

### 2 indicator-flasher-actuator

page 111

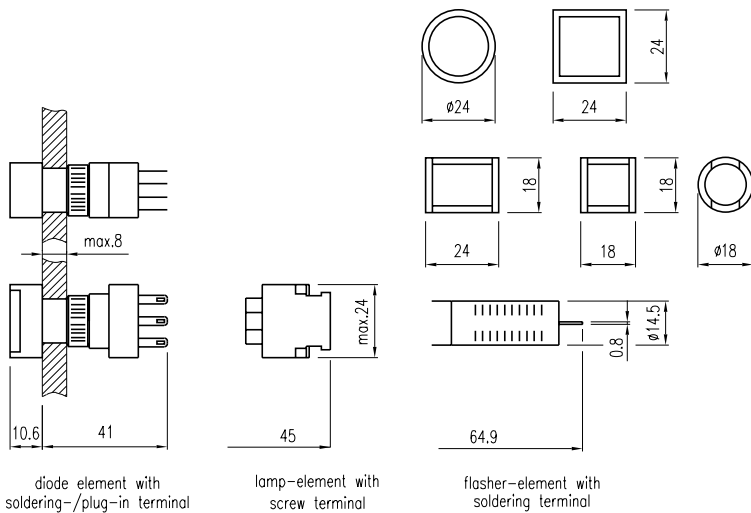

diode element with soldering-/plug-in terminal

lamp-element with screw terminal

flasher-element with soldering terminal

### 3 illuminated-/pushbutton actuator

page 112

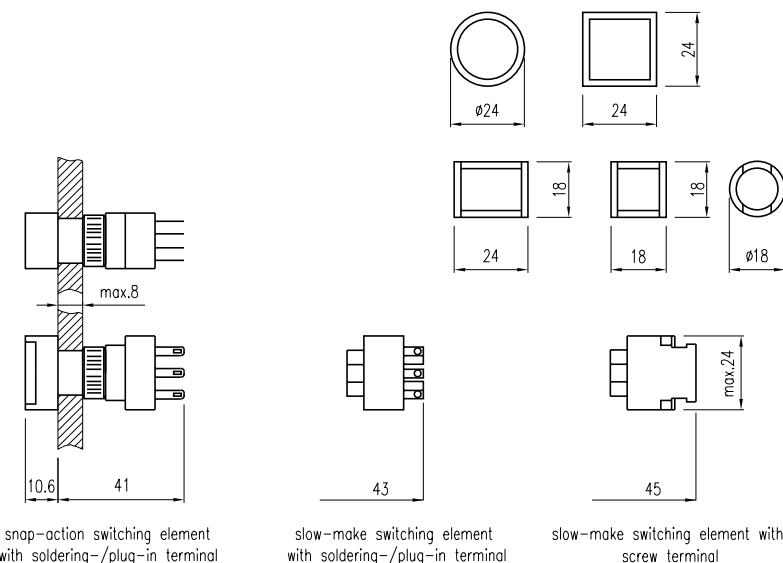

snap-action switching element with soldering-/plug-in terminal

slow-make switching element with soldering-/plug-in terminal

slow-make switching element with screw terminal

## 4 emergency stop switch actuator foolproof

page 112



## 5 pushbutton actuator with mushroom-head cap

page 113



## 6 keylock switch actuator 2 positions, keylock switch actuator 3 positions page 113, 114

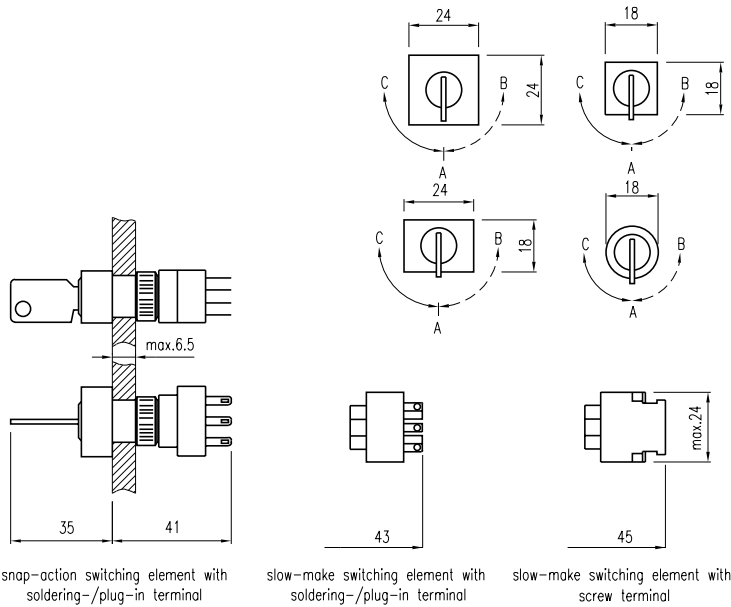

## 7 selector switch actuator 2 positions, selector switch actuator 3 positions page 115, 116



## 8 indicator complete for flush mounting page 117

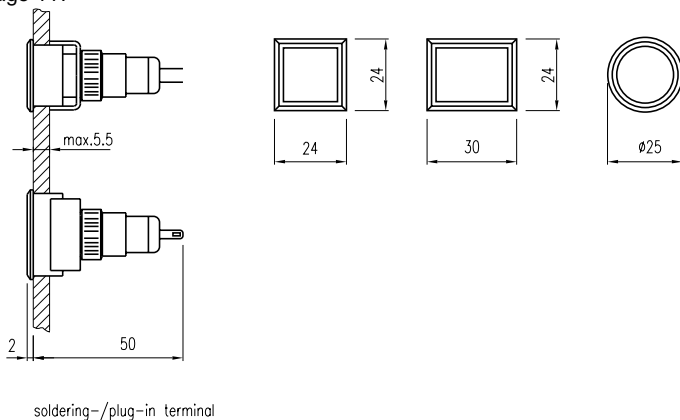

## 9 indicator/flasher-actuator for flush mounting

page 117

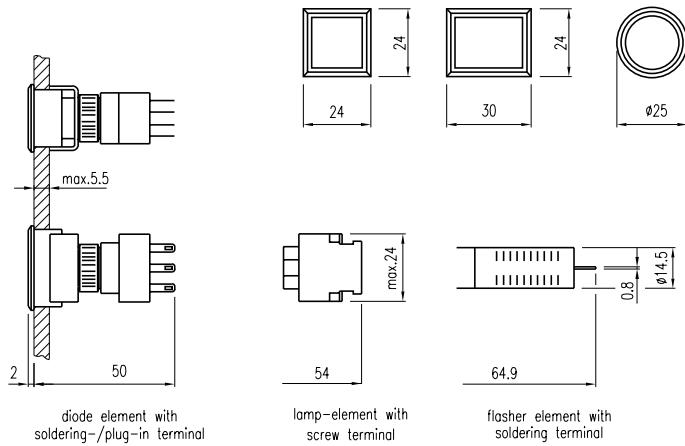

## 10 illuminated-/pushbutton actuator for flush mounting

page 118

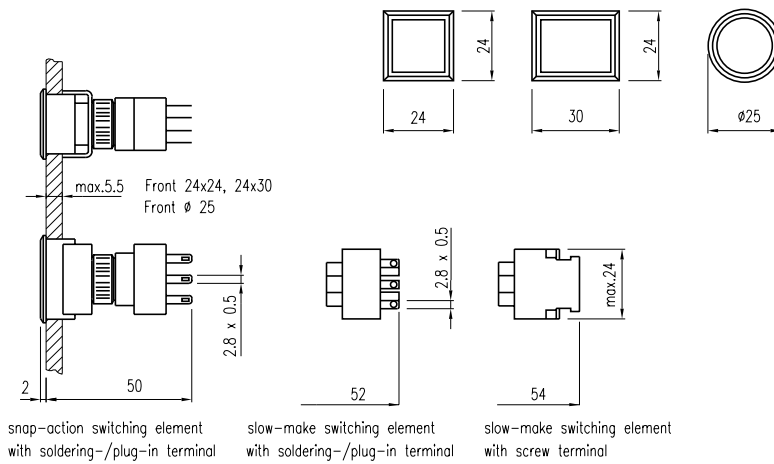

## 11 mushroom pushbutton actuator for flush mounting

page 118

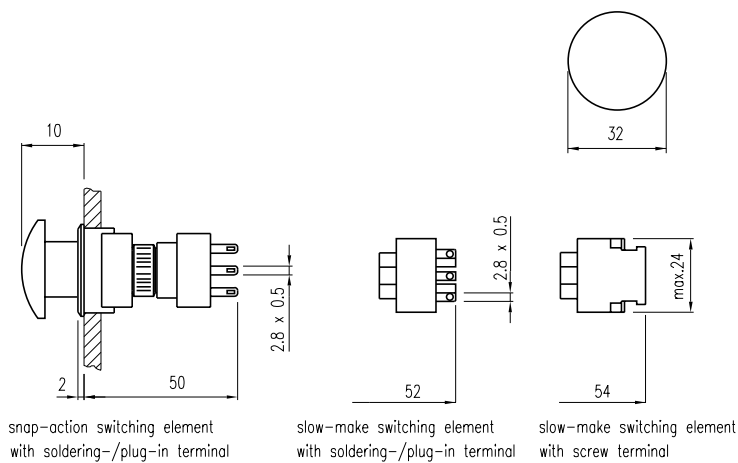

**12 keylock switch actuator with 2 positions for flush mounting, keylock switch actuator 3 positions for flush mounting**  
page 119, 120



**13 selector switch actuator 2 positions for flush mounting, selector switch actuator 3 positions for flush mounting**  
page 121, 122

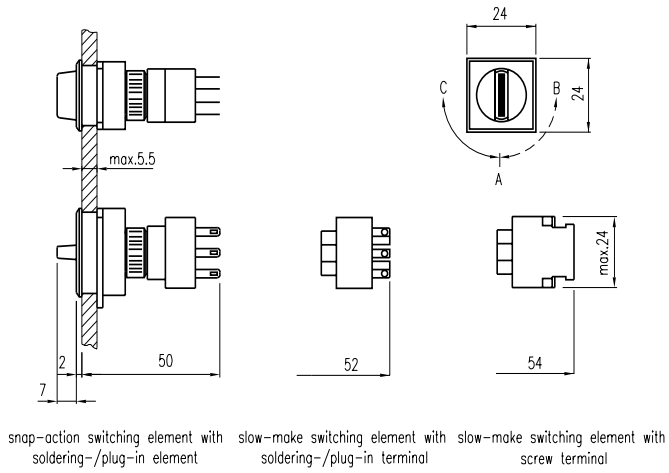

**14 protective cover**  
page 126

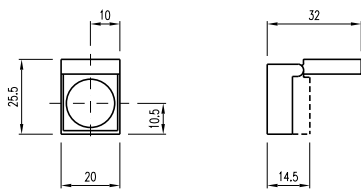

**15 protective cover**  
page 126

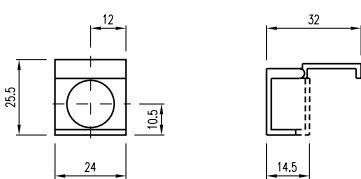

**16 protective cover**  
page 126

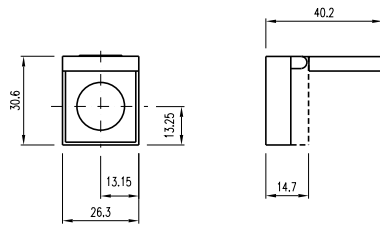

**mounting dimension**

**1 indicator complete, indicator-flasher-actuator, illuminated-/pushbutton actuator, keylock switch actuator 2 positions, keylock switch actuator 3 positions, selector switch actuator 2 positions, selector switch actuator 3 positions, blind plug projecting**  
page 111, 112, 113, 114, 115, 116, 127

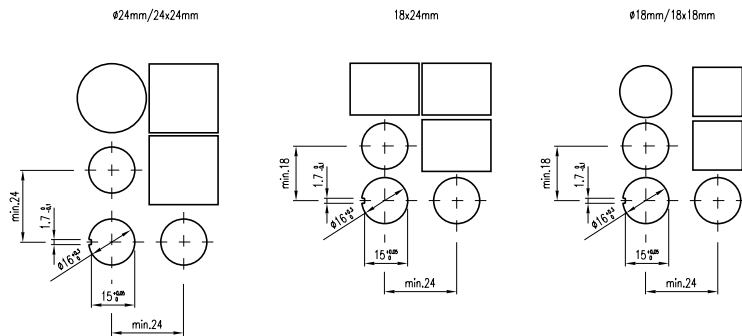

**2 emergency stop switch actuator foolproof, pushbutton actuator with mushroom-head cap, mushroom pushbutton actuator for flush mounting**  
page 112, 113

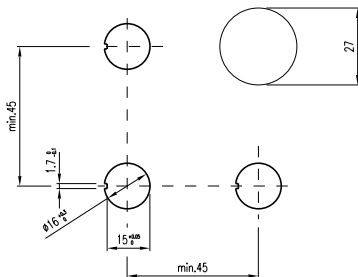

**3 indicator complete for flush mounting, indicator-flasher-actuator for flush mounting, illuminated-/pushbutton actuator for flush mounting, keylock switch actuator with 2 positions for flush mounting, keylock switch actuator 3 positions for flush mounting, selector switch actuator 2 positions for flush mounting, selector switch actuator 3 positions for flush mounting, blind plug flat**  
page 117,118,119,120, 121, 122, 127

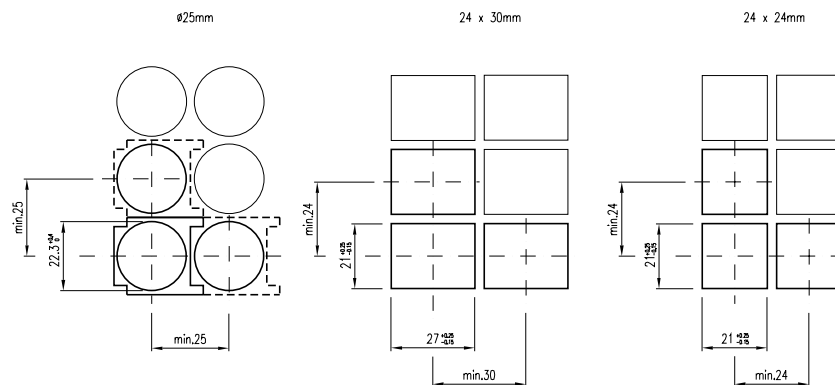

## components layouts

### 1 diode element

page 128



### 2 diode element

page 128



### 3 switching element for illuminated-/pushbutton, keylock-/selector switch 2 positions

page 129



### 4 switching element for illuminated-/pushbutton, keylock-/selector switch 2 positions

page 129

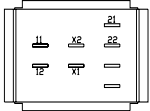

### 5 switching element for illuminated-/pushbutton, keylock-/selector switch 2 positions

page 129

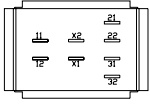

### 6 switching element for illuminated-/pushbutton, keylock-/selector switch 2 positions

page 129

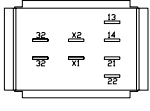

### 7 switching element for illuminated-/pushbutton, keylock-/selector switch 2 positions

page 129

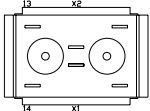

### 8 switching element for illuminated-/pushbutton, keylock-/selector switch 2 positions

page 129

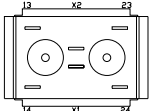

### 9 switching element for illuminated-/pushbutton, keylock-/selector switch 2 positions

page 129

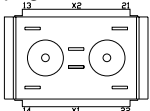



**10** switching element for illuminated-/pushbutton, keylock-/selector switch 2 positions  
page 129



**11** switching element for illuminated-/pushbutton, keylock-/selector switch 2 positions  
page 129



**12** switching element for illuminated-/pushbutton, keylock-/selector switch 2 positions  
page 129

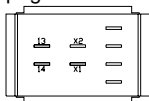

**13** switching element for illuminated-/pushbutton, keylock-/selector switch 2 positions  
page 129

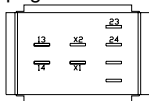

**14** switching element for illuminated-/pushbutton, keylock-/selector switch 2 positions  
page 129

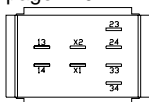

**15** switching element for illuminated-/pushbutton, keylock-/selector switch 2 positions  
page 129

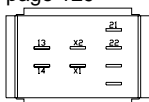

**16** switching element for illuminated-/pushbutton, keylock-/selector switch 2 positions  
page 129

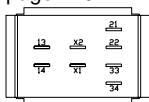

**17** switching element for illuminated-/pushbutton, keylock-/selector switch 2 positions  
page 129

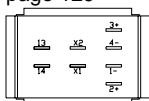

**18** switching element for emergency stop switch  
page 130

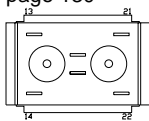

**19 switching element for emergency stop switch**  
page 130



**20 switching element for emergency stop switch**  
page 130



**21 switching element for keylock-/selector switch 3 positions**  
page 130



**22 switching element for keylock-/selector switch 3 positions**  
page 130



**23 switching element for keylock-/selector switch 3 positions**  
page 130



**24 switching element for keylock-/selector switch 3 positions**  
page 130

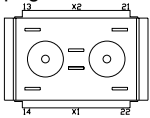

**25 switching element for keylock-/selector switch 3 positions**  
page 130

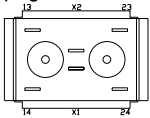

**26 switching element for keylock-/selector switch 3 positions**  
page 130

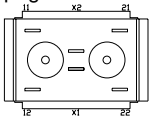

**27 PCB plug-in base**  
page 131

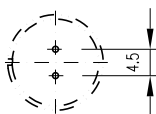

**28 PCB plug-in base**  
page 131

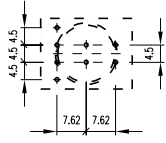

**29 PCB plug-in base**  
page 131

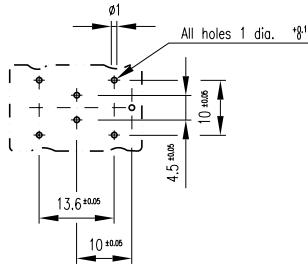

	circuit drawing		circuit drawing
1		21	
2		22	
3		23	
4		24	
5		25	
6		26	
7		27	
8		28	
9		29	
10		30	
11		31	
12		32	
13		33	
14		34	
15		35	
16		36	
17		37	
18		38	
19		39	
20			

With indicators and illuminated pushbuttons equipped with diodes, the user is able to perform a lamp check or wire an alarm circuit simply with a considerable saving of space.

lamp check



lamp check with blocking diodes



alarm circuit from fault  
annunciating system



lamp check and alarm circuit



lamp check and alarm circuit with  
only one diode and AC voltage



LC = lamp check

## Flasher element

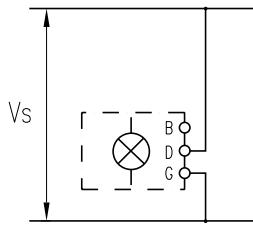

1. Continuous light

## 1. Engraving

### Typefaces

In addition to the most commonly used world languages (see DIN 1451) with close spacing, the following typefaces are available: Scandinavian, Slavian, Greek, Russian.

### Coloured filling of engraving

Specify whether engraving should be on the diffuser, or on the lens.  
Specify the infill colour, character height and the text or symbol orientation.

### Symbols

A list of the symbols available can be supplied on request.

## 2. Hot stamping

For large batches it is worth while to have the lettering produced by hot stamping.

### Typefaces

For letters and figures, typefaces with 2,5 mm, 3 mm and 4 mm are available.

### Symbols

A list of the symbols available can be supplied on request.



### Important!

Before engraving, check the position of the illuminated pushbutton or indicator

Height of letters mm	(switch) lens	(18 x 24) 15,3 x 21,5 mm						(Ø 18) Ø 15,8 mm			(18 x 18) 15,3 x 15,3 mm		
		Horizontal mounting			Vertical mounting			Number of lines	Number of letters per line	Number of letters per line	Number of lines	Number of letters per line	Number of letters per line
h	s	Number of lines	Number of letters per line	Number of letters per line	Number of lines	Number of letters per line	Number of letters per line						
2,5	0,4	4	11	12	5	7-8	8	3	6	6	4	7-8	8
3	0,4	3	9-10	10-11	4	6-7	7	2	5	6	3	6-7	7
4	0,5	2	7	7-8	3	4-5	5	2	3	4	2	4-5	5
5	0,5	2	5-6	6	2	3-4	4	1	2	3	2	3-4	4
6	0,6	1	4-5	5	2	3	3-4	1	2	2	1	3	3-4
8	0,6	1	3-4	3-4	1	2-3	2-3	1	2	2	1	2-3	2-3
<b>Film dimension</b>		□ max. 12,7 x 18,7 mm						Ø 12,8 mm			□ 12,7 x 12,7 mm		

### 3. Film inserts

Instead of using engraving, the lenses can be fitted with transparent film inserts.

For this purpose, though, it is advisable to use transparent lenses. When a smoked lens is used, the lettering does not become visible until the lamp lights.

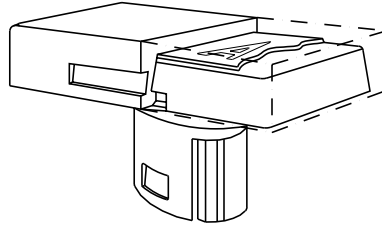

#### Film dimensions

16,9x16,9 mm  
11,9x11,9 mm  
max 11,9x18,0 mm

#### Film thickness

0.2 mm

#### Important!

Before engraving, check the position of the illuminated pushbutton or indicator.

Height of letters		Thickness of letters		Number of lines		Number of letters per line		Number of letters per line		Number of lines		Number of letters per line		Number of letters per line		Number of lines		Number of letters per line		Number of letters per line	
h	s	(caps)	(small)	(caps)	(small)	(caps)	(small)	(caps)	(small)	(caps)	(small)	(caps)	(small)	(caps)	(small)	(caps)	(small)	(caps)	(small)	(caps)	(small)
2,5	0,4	3	6	6	4	9	10	4	12	13	5	8-9	9	4	8-9	9					
3	0,4	2	5	6	3	7-8	9	3	10-11	11-12	4	7-8	8	3	7-8	8					
4	0,5	2	3	4	2	4-5	5	2	7	8	3	4-5	5	2	4-5	5					
5	0,5	1	2	3	2	4	4-5	2	5-6	6	2	4	4-5	2	4	4-5					
6	0,6	1	2	3	1	4	4	1	4-5	5	2	3	3-4	1	4	4					
8	0,6	1	2	2	1	2	2	1	3-4	3-4	1	2-3	2-3	1	2-3	2-3					
<b>Film dimension</b>						□ 16,9 x 16,9 mm				□ 15,1 x 21 mm				□ 15,1 x 15,1 mm							





## Стандарт Электрон Связь

Мы молодая и активно развивающаяся компания в области поставок электронных компонентов. Мы поставляем электронные компоненты отечественного и импортного производства напрямую от производителей и с крупнейших складов мира.

Благодаря сотрудничеству с мировыми поставщиками мы осуществляем комплексные и плановые поставки широчайшего спектра электронных компонентов.

Собственная эффективная логистика и склад в обеспечивает надежную поставку продукции в точно указанные сроки по всей России.

Мы осуществляем техническую поддержку нашим клиентам и предпродажную проверку качества продукции. На все поставляемые продукты мы предоставляем гарантию .

Осуществляем поставки продукции под контролем ВП МО РФ на предприятия военно-промышленного комплекса России , а также работаем в рамках 275 ФЗ с открытием отдельных счетов в уполномоченном банке. Система менеджмента качества компании соответствует требованиям ГОСТ ISO 9001.

Минимальные сроки поставки, гибкие цены, неограниченный ассортимент и индивидуальный подход к клиентам являются основой для выстраивания долгосрочного и эффективного сотрудничества с предприятиями радиоэлектронной промышленности, предприятиями ВПК и научно-исследовательскими институтами России.

С нами вы становитесь еще успешнее!

### Наши контакты:

**Телефон:** +7 812 627 14 35

**Электронная почта:** [sales@st-electron.ru](mailto:sales@st-electron.ru)

**Адрес:** 198099, Санкт-Петербург,  
Промышленная ул, дом № 19, литера Н,  
помещение 100-Н Офис 331