



6

Index

Series 61

	Description	Page 109
	Product Assembly	Page 110
	Product Range	
	- pushbuttons for standard mounting	Page 111
	- pushbuttons for flush mounting	Page 117
	- accessories / spare parts	Page 123
	Technical Data	Page 137
	Technical Drawing / Dimension / Layouts	Page 140
	Circuit Drawing	Page 150
	Typical Applications	Page 151
Marking	Page 153	

General Notes

The indicators, illuminated pushbuttons, selector switches, keylock switches and emergency stop switches with spray-water protection at the front (IP 65) are modular and consist of an actuator and switching element. In addition to the standard switching elements (gold-plated silver contact with universal soldering or plug-in terminals), forced-opening, slow-make switching elements with gold or silver contacts and soldering or plug-in terminals are available. They can be supplied with screw terminals and silver contacts too. The front dimensions of the units in this series are 24 x 24 mm, 24 mm dia., 18 x 24 mm, 18 x 18 mm or 18 mm dia. For flush mounting the dimensions 25 mm dia., 24 x 30 mm and 24 x 24 mm can be supplied.

Mounting

All switch actuators are mounted from the front by pushing them through the mounting hole in the front panel. They are then fixed from the back with a fixing nut and the mounting tool typ no. 01-907. Max. tightening torque 50 Ncm. For mounting dimensions and grid size see as of page 145.

The preassembled switching element with the connecting wires in a single plane can be clipped on afterwards. For block or series mounting aids are available.

For switching elements with 2.8 mm plug-in terminals, we offer plug-in bases, which when soldered to a PCB enable a plug-in connection to the button. All actuators are provided with an anti-rotation device.

Lenses

The flat or concave lenses are available in various colours and a transparent or translucent version. The lens surface is non-reflecting (matt). Lenses 19.7 mm dia. can be supplied also in aluminium.

Marking

For engraving, hot stamping and film inserts, see page 153 under "Marking".

Illumination

The midget-grooved T 1 3/4 incandescent lamp (6-60 V, 1.2 W) ensures perfect illumination of the lenses, which are supplied in various colours.

Midget-grooved T 1 3/4 Multi-LED (6, 12, 24, 48 V) are also available in white, red, yellow and green.

For supply voltages above 60 V, it is necessary to use a voltage reduction element (external series resistor, capacitor or transformer). Do not solder the terminals directly, because of the high surface temperature.

Position indication

When the switch with maintained action is actuated, the lens snaps into place mechanically. The position of contacts can always be determined by the position of the lens.

Keylock switch

Standard lock (index D)

1 standard number 311. If the lock number is not specified, we will supply no. 311. An additional 134 special locks (index X) are available on request. Master keys for locks no. 311 - 445 may be ordered by quoting no. 31-989.300.

Two keys are supplied with each keylock switch.

Spare keys for DOM standard locks may be ordered by quoting no. 31-989 (please state the lock number).

Emergency stop switch foolproof with key to unlock

Kaba safety lock. Standard lock number is 1001. Locks with other numbers are available on request.

Spare keys for KABA locks may be ordered under no. 14-987 (please state the lock number).

Specimen orderIndicator complete

- indicator complete, soldering terminal, 18 x 24 mm 61-0030.02

Recommended accessories:

- lens plastic, 18 x 24 mm, clear 61-9331.7
- LED, 6 chips, 6 VDC, yellow 10-5306.3254

illuminated-/pushbutton



- 1 lens
- 2 actuator case
- 3 fixing nut
- 4 switching element

illuminated-/pushbutton for flush mounting



- 1 lens
- 2 actuator housing
- 3 front bezel
- 4 sealing
- 5 front panel
- 6 fixing bow
- 7 fixing nut
- 8 switching element

indicator complete



recommended accessories:

-  lens plastic → 123
-  front ring → 126
-  incandescent lamp → 132; LED → 133

	connection method						circuit drawing	technical drawing	mounting dimension	
indicator complete	ST/PT	61-0030.02 18 x 24 mm part no.	61-0050.02 24 x 24 mm part no.	61-0010.02 18 mm dia. part no.	61-0020.02 18 x 18 mm part no.	61-0040.02 24 mm dia. part no.	1	1	1	0,005

connection method: ST/PT = soldering-/plug-in terminal

Accessorie front ring only requested for Ø 24 mm.





marking see page 153

technical drawing as of page 140, mounting dimensions as of page 145, circuit drawing as of page 150

indicator-/flasher-actuator



recommended accessories:

-  lens plastic → 123
-  front ring → 126
-  incandescent lamp → 132; LED → 133
-  lamp element → 128; diode element → 128; flasher element → 131

						circuit drawing	technical drawing	mounting dimension	
indicator-/flasher-actuator	61-0039.0 18 x 24 mm part no.	61-0059.0 24 x 24 mm part no.	61-0019.0 18 mm dia. part no.	61-0029.0 18 x 18 mm part no.	61-0049.0 24 mm dia. part no.	1	2	1	0,005

Accessorie front ring only requested for Ø 24 mm.

marking see page 153

technical drawing as of page 140, mounting dimensions as of page 145, circuit drawing as of page 150

illuminated-/pushbutton actuator



recommended accessories:

-  lens plastic → 123; lens metal with window → 124; lens metal → 124
-  front ring → 126
-  incandescent lamp → 132; LED → 133
-  switching element for illuminated-/pushbutton, keylock-/selector switch 2 positions → 129

	switching action	 18 x 24 mm part no.	 24 x 24 mm part no.	18 mm dia. part no.	 18 x 18 mm part no.	24 mm dia. part no.	circuit drawing	technical drawing	mounting dimension	
illuminated-/pushbutton actuator	main	61-1230.0	61-1250.0	61-1210.0	61-1220.0	61-1240.0	2	3	1	0,005
	mom	61-1130.0	61-1150.0	61-1110.0	61-1120.0	61-1140.0	3	3	1	0,005
	mom/main	61-1330.0	61-1350.0	61-1310.0	61-1320.0		3	3	1	0,005

switching action: main = maintained action, mom = momentary action, mom/main = momentary-/maintained action

Accessory front ring only requested for Ø 24 mm.

marking see page 153

technical drawing as of page 140, mounting dimensions as of page 145, circuit drawing as of page 150

emergency stop switch actuator foolproof

according to EN 418



recommended accessories:

-  label for emergency stop switch → 134
-  switching element for emergency stop switch → 130
-  protective shroud for emergency stop switch → 134

	switching action	unlocking	marking of mushroom-head cap	27 mm dia. part no.	circuit drawing	technical drawing	mounting dimension	
emergency stop switch actuator foolproof	main	twist to release	arrows	61-3440.4/1	4	4	2	0,003
			stop	61-3440.4/2	4	4	2	0,003
without label standard lock1001, other lock numbers on request	main	key to release	stop	61-5441.4/K	4	4	2	0,038

switching action: main = maintained action

description see page 109

technical drawing as of page 140, mounting dimensions as of page 145, circuit drawing as of page 150

pushbutton actuator with mushroom-head cap



recommended accessories:

-  mushroom-head cap → 124
-  front ring → 126
-  switching element for illuminated-/pushbutton, keylock-/selector switch 2 positions → 129

	switching action	32 mm dia. part no.	circuit drawing	technical drawing	mounting dimension	
pushbutton actuator with mushroom-head cap	main	61-1240.0	2	5	2	0,006
	mom	61-1140.0	3	5	2	0,006

switching action: main = maintained action, mom = momentary action

technical drawing as of page 140, mounting dimensions as of page 145, circuit drawing as of page 150

keylock switch actuator 2 positions

if installed with anti-twist device, the lug is on the left.



recommended accessories:

-  keylock front bezel → 124
-  switching element for illuminated-/pushbutton, keylock-/selector switch 2 positions → 129
-  anti-twisting ring → 135

	switching action	key removable in	part no.	circuit drawing	technical drawing	mounting dimension	
  <p>keylock switch actuator 2 positions pos. A: basic position pos. C: maintained action standard lock 311, other lock numbers on request</p>	main	A	61-2201.0/D	6	6	1	0,003
		C	61-2203.0/D	6	6	1	0,003
		C + A	61-2205.0/D	6	6	1	0,003
pos. A: basic position pos. C: momentary action standard lock 311, other lock numbers on request	mom	A	61-2101.0/D	5	6	1	0,003

switching action: main = maintained action, mom = momentary action

description see page 109

technical drawing as of page 140, mounting dimensions as of page 145, circuit drawing as of page 150

keylock switch actuator 3 positions

if installed with anti-twist device, the lug is on the left.



recommended accessories:

- keylock front bezel → 124
- switching element for keylock-/selector switch 3 positions → 130
- anti-twisting ring → 135

 	switching action	key removable in	part no.	circuit drawing	technical drawing	mounting dimension	kg
keylock switch actuator 3 positions pos. C: maintained action pos. A: basic position pos. B: maintained action standard lock 311 other lock numbers on request	main-0-main	A	61-2601.0/D	11	6	1	0,003
		A+B	61-2604.0/D	11	6	1	0,003
		B	61-2602.0/D	11	6	1	0,003
		C	61-2603.0/D	11	6	1	0,003
		C + A	61-2605.0/D	11	6	1	0,003
		C+A+B	61-2607.0/D	11	6	1	0,003
		C+B	61-2606.0/D	11	6	1	0,003
pos. C: maintained action pos. A: basic position pos. B: momentary action standard lock 311 other lock numbers on request	main-0-mom	A	61-2701.0/D	10	6	1	0,003
		C	61-2703.0/D	10	6	1	0,003
		C + A	61-2705.0/D	10	6	1	0,003
pos. C: momentary action pos. A: basic position pos. B: maintained action standard lock 311	mom-0-main	A	61-2801.0/D	9	6	1	0,003
		A+B	61-2804.0/D	9	6	1	0,003
		B	61-2802.0/D	7	6	1	0,003
pos. C: momentary action pos. A: basic position pos. B: momentary action standard lock 311	mom-0-mom	A	61-2501.0/D	8	6	1	0,003

switching action: mom = momentary action, main = maintained action, 0 = basic position

[description see page 109](#)

[technical drawing as of page 140, mounting dimensions as of page 145, circuit drawing as of page 150](#)

selector switch actuator 2 positions

if installed with anti-twist device, the lug is on the left.



recommended accessories:

-  lever → 125
-  incandescent lamp → 132; LED → 133
-  switching element for illuminated-/pushbutton, keylock-/selector switch 2 positions → 129
-  anti-twisting ring → 135



	switching action	18 mm dia. part no.	circuit drawing	technical drawing	mounting dimension	
selector switch actuator 2 positions pos. C: maintained action pos. A: basic position	main	61-4210.0	13	7	1	0,006
pos. C: momentary action pos. A: basic position	mom	61-4110.0	12	7	1	0,006

switching action: main = maintained action, mom = momentary action

technical drawing as of page 140, mounting dimensions as of page 145, circuit drawing as of page 150

selector switch actuator 3 positions

if installed with anti-twist device, the lug is on the left.



recommended accessories:

-  lever → 125
-  incandescent lamp → 132; LED → 133
-  switching element for keylock-/selector switch 3 positions → 130
-  anti-twisting ring → 135



	switching action	18 mm dia. part no.	circuit drawing	technical drawing	mounting dimension	
selector switch actuator 3 positions pos. C: maintained action pos. A: basic position pos. B: maintained action	main-0-main	61-4610.0	17	7	1	0,006
pos. C: maintained action pos. A: basic position pos. B: momentary action	main-0-mom	61-4710.0	16	7	1	0,006
pos. C: momentary action pos. A: basic position pos. B: maintained action	mom-0-main	61-4810.0	15	7	1	0,006
pos. C: momentary action pos. A: basic position pos. B: momentary action	mom-0-mom	61-4510.0	14	7	1	0,006

switching action: mom = momentary, main = maintaining, 0 = basic position

technical drawing as of page 140. mounting dimensions as of page 145. circuit drawing as of page 150

indicator complete for flush mounting



recommended accessories:

-  lens plastic for flush mounting → 124
-  front bezel-set for flush mounting → 126
-  incandescent lamp → 132; LED → 133

	connection method	part no.	circuit drawing	technical drawing	mounting dimension	
indicator complete for flush mounting	ST/PT	61-0000.02	1	8	3	0,006

connection method: ST/PT = soldering-/plug-in terminal

marking see page 153

technical drawing as of page 140, mounting dimensions as of page 145, circuit drawing as of page 150

indicator-/flasher-actuator for flush mounting



recommended accessories:

-  lens plastic for flush mounting → 124
-  front bezel-set for flush mounting → 126
-  incandescent lamp → 132; LED → 133
-  lamp element → 128; diode element → 128; flasher element → 131

	part no.	circuit drawing	technical drawing	mounting dimension	
indicator-/flasher-actuator for flush mounting	61-0009.0	1	9	3	0,005





marking see page 153

technical drawing as of page 140, mounting dimensions as of page 145, circuit drawing as of page 150

illuminated-/pushbutton actuator for flush mounting



recommended accessories:

-  lens plastic for flush mounting → 124; lens metal with window → 124; lens metal → 124
-  front bezel-set for flush mounting → 126
-  incandescent lamp → 132; LED → 133
-  switching element for illuminated-/pushbutton, keylock-/selector switch 2 positions → 129

	switching action	part no.	circuit drawing	technical drawing	mounting dimension	
illuminated-/pushbutton actuator for flush mounting	mom/main	61-1300.0	19	10	3	0,005
	mom	61-1100.0	19	10	3	0,005
	main	61-1200.0	18	10	3	0,005

switching action: main = maintained action, mom = momentary action, mom/main = momentary-/maintained action



[marking see page 153](#)

[technical drawing as of page 140](#). [mounting dimensions as of page 145](#). [circuit drawing as of page 150](#)

mushroom pushbutton actuator for flush mounting



recommended accessories:

-  mushroom-head cap → 124
-  front bezel-set round for flush mounting → 126
-  switching element for illuminated-/pushbutton, keylock-/selector switch 2 positions → 129

	switching action	part no.	circuit drawing	technical drawing	mounting dimension	
mushroom pushbutton actuator for flush mounting	mom/main	61-1300.0	3	11	2	0,006
	mom	61-1100.0	3	11	2	0,006
	main	61-1200.0	2	11	2	0,006



switching action: main = maintained action, mom = momentary action, mom/main = momentary-/maintained action

[technical drawing as of page 140](#). [mounting dimensions as of page 145](#). [circuit drawing as of page 150](#)

keylock switch actuator with 2 positions for flush mounting



recommended accessories:

-  keylock front bezel → 124
-  front bezel-set for flush mounting → 126
-  switching element for illuminated-/pushbutton, keylock-/selector switch 2 positions → 129

	switching action	key removable in	part no.	mounting dimension			
				circuit drawing	technical drawing		
  <p>keylock switch actuator with 2 positions for flush mounting pos. A: basic position pos. C: maintained action standard lock 311, other lock numbers on request</p>	main	A	61-2201.0/D	6	12	3	0,003
		C	61-2203.0/D	6	12	3	0,003
		C + A	61-2205.0/D	6	12	3	0,003
pos. A: basic position pos. C: momentary action standard lock 311, other lock numbers on request	mom	A	61-2101.0/D	5	12	3	0,003

switching action: main = maintained action, mom = momentary action

[description see page 109](#)

[technical drawing as of page 140](#), [mounting dimensions as of page 145](#), [circuit drawing as of page 150](#)

keylock switch actuator 3 positions for flush mounting



recommended accessories:

-  keylock front bezel → 124
-  front bezel-set for flush mounting → 126
-  switching element for keylock-/selector switch 3 positions → 130



	switching action	key removable in	part no.	circuit drawing			technical drawing			mounting dimension	
keylock switch actuator 3 positions for flush mounting pos. C: maintained action pos. A: basic position Pos. B: momentary action standard lock 311, other lock numbers on request	main-0-mom	A	61-2701.0/D	10	12	3	0,003				
		C	61-2703.0/D	5	12	3	0,003				
		C + A	61-2705.0/D	10	12	3	0,003				
pos. C: maintained action pos. A: basic position pos. B: maintained action standard lock 311, other lock numbers on request	main-0-main	A	61-2601.0/D	11	12	3	0,003				
		A+B	61-2604.0/D	11	12	3	0,003				
		B	61-2602.0/D	11	12	3	0,003				
		C	61-2603.0/D	11	12	3	0,003				
		C + A	61-2605.0/D	11	12	3	0,003				
		C+A+B	61-2607.0/D	11	12	3	0,003				
		C+B	61-2606.0/D	11	12	3	0,003				
pos. C: momentary action pos. A: basic position pos. B: maintained action standard lock 311, other lock numbers on request	mom-0-main	A	61-2801.0/D	9	12	3	0,003				
		A+B	61-2804.0/D	9	12	3	0,003				
		B	62-2802.0/D	9	12	3	0,003				
pos. C: momentary action pos. A: basic position pos. B: momentary action standard lock 311, other lock numbers on request	mom-0-mom	A	61-2501.0/D	8	12	3	0,003				

switching action: mom = momentary action, main = maintained action, 0 = basic position

[description see page 109](#)

[technical drawing as of page 140. mounting dimensions as of page 145. circuit drawing as of page 150](#)

selector switch actuator 2 positions for flush mounting



recommended accessories:

-  lever for flush mounting → 125
-  front bezel-set for flush mounting → 126
-  incandescent lamp → 132; LED → 133
-  switching element for illuminated-/pushbutton, keylock-/selector switch 2 positions → 129



	switching action	part no.	circuit drawing	technical drawing	mounting dimension	
selector switch actuator 2 positions for flush mounting pos. C: maintained action pos. A: basic position	main	61-4210.0	13	13	3	0,006
pos. C: momentary action pos. A: basic position	mom	61-4110.0	12	13	3	0,006

switching action: main = maintained action, mom = momentary action

technical drawing as of page 140, mounting dimensions as of page 145, circuit drawing as of page 150

selector switch actuator 3 positions for flush mounting



recommended accessories:

-  lever for flush mounting → 125
-  front bezel-set for flush mounting → 126
-  incandescent lamp → 132; LED → 133
-  switching element for keylock-/selector switch 3 positions → 130



	switching action	part no.	circuit drawing	technical drawing	mounting dimension	
selector switch actuator 3 positions for flush mounting pos. C: maintained action pos. A: basic position pos. B: maintained action	main-0-main	61-4610.0	17	13	3	0,006
pos. C: maintained action pos. A: basic position pos. B: momentary action	main-0-mom	61-4710.0	16	13	3	0,006
pos. C: momentary action pos. A: basic position pos. B: maintained action	mom-0-main	61-4810.0	15	13	3	0,006
pos. C: momentary action pos. A: basic position pos. B: momentary action	mom-0-mom	61-4510.0	14	13	3	0,006

switching action: mom = momentary, main = maintaining, 0 = basic position

technical drawing as of page 140, mounting dimensions as of page 145, circuit drawing as of page 150

at front

lens plastic

	shape	lens/sup- port	colour	⌀ 18 x 24 mm part no.	⌀ 24 x 24 mm part no.	18 mm dia. part no.	⌀ 18 x 18 mm part no.	25 mm dia. part no.	kg		
lens plastic matt	con- cave	transpar- ent/trans- lucent	blue	61-9336.6			61-9326.6		0,001		
			colour- less, clear	61-9336.7			61-9326.7		0,001		
			green	61-9336.5			61-9326.5		0,001		
			orange	61-9336.3			61-9326.3		0,001		
			red	61-9336.2			61-9326.2		0,001		
			yellow	61-9336.4			61-9326.4		0,001		
	flat	transpar- ent/trans- lucent	blue				61-9311.6	61-9321.6		0,001	
					61-9331.6	61-9351.6			61-9642.6	0,002	
			colour- less, clear		61-9331.7		61-9311.7	61-9321.7			0,001
						61-9351.7			61-9642.7	0,002	
			green		61-9331.5	61-9351.5	61-9311.5	61-9321.5			0,001
									61-9642.5	0,002	
			orange					61-9321.3			0,001
					61-9331.3	61-9351.3	61-9311.3		61-9642.3	0,002	
			red					61-9321.2			0,001
					61-9331.2	61-9351.2	61-9311.2		61-9642.2	0,002	
			smoked		61-9331.1		61-9311.1				0,001
						61-9351.1		61-9321.1		61-9642.1	0,002
			yellow			61-9351.1		61-9321.1		61-9642.4	0,002
					61-9331.4	61-9351.4	61-9311.4	61-9321.4			0,001
matt (not for film in- sert and LED)	con- cave	translu- cent/ translu- cent	white	61-9236.9			61-9226.9		0,001		
	flat	translu- cent/ translu- cent	white	61-9231.9	61-9251.9	61-9211.9	61-9221.9		0,001		
matt (not for film in- sert and illumina- tion)	con- cave	opaque/ translu- cent	black	61-9236.0			61-9226.0		0,001		
			grey	61-9236.8			61-9226.8		0,001		
	flat	opaque/ translu- cent	black	61-9231.0	61-9251.0	61-9211.0	61-9221.0		0,001		
			grey	61-9231.8	61-9251.8	61-9211.8	61-9221.8		0,001		



lens plastic for flush mounting

	shape	lens/support	colour	⌀ 24 x 30 mm part no.	⌀ 24 x 24 mm part no.	25 mm dia. part no.		
lens plastic for flush mounting matt	flat	transparent/translucent	blue	61-9681.6	61-9671.6	61-9642.6	0,001	
			colourless, clear	61-9681.7	61-9671.7	61-9642.7	0,001	
			green	61-9681.5	61-9671.5	61-9642.5	0,001	
			orange	61-9681.3	61-9671.3	61-9642.3	0,001	
			red	61-9681.2	61-9671.2	61-9642.2	0,001	
			smoked			61-9642.1	0,001	
yellow	61-9681.4	61-9671.4	61-9642.4	0,001				
matt (not for film insert and LED)	flat	translucent/translucent	white	61-9781.9	61-9771.9		0,001	
matt (not for film insert and illumination)	flat	opaque/translucent	black	61-9781.0	61-9771.0		0,001	
			grey	61-9781.8	61-9771.8		0,001	

lens metal with window

	shape	lens	colour	25 mm dia. part no.		
lens metal with window matt	flat	aluminium anodized	natural	61-9841.8A	0,002	

lens metal

	shape	lens	colour	25 mm dia. part no.		
lens metal matt	flat	aluminium anodized	black	61-9841.0	0,002	
			blue	61-9841.6	0,002	
			green	61-9841.5	0,002	
			natural	61-9841.8	0,002	
			red	61-9841.2	0,002	
			yellow	61-9841.4	0,002	

mushroom-head cap

		colour	32 mm dia. part no.		
mushroom-head cap plastic	mushroom opaque	black	61-9593.0	0,004	
		green	61-9593.5	0,004	
		red	61-9593.2	0,004	
		yellow	61-9593.4	0,004	

keylock front bezel

for keylock switch actuator

	⌀ 18 x 24 mm part no.	⌀ 24 x 24 mm part no.	18 mm dia. part no.	⌀ 18 x 18 mm part no.		
keylock front bezel	61-9230.0	61-9250.0	61-9210.0	61-9220.0	0,001	

61-9250.0 not for flush mounting

lever

	colour	colour of bar	part no.		
lever with marking dot and transparent bar	black	black, opaque	52-928.0	0,001	
		blue	52-928.60	0,001	
		green	52-928.50	0,001	
		orange	52-928.30	0,001	
		red	52-928.20	0,001	
		white, opaque	52-928.9	0,001	
		yellow	52-928.40	0,001	
	grey	blue	52-929.60	0,001	
		green	52-929.50	0,001	
		grey, opaque	52-929.8	0,001	
		orange	52-929.30	0,001	
		red	52-929.20	0,001	
		white, opaque	52-929.9	0,001	
		yellow	52-929.40	0,001	

lever for flush mounting

	colour	colour of bar	part no.		
lever for flush mounting with marking dot and transparent bar	black	black, opaque	61-9028.0	0,001	
		blue	61-9028.60	0,001	
		green	61-9028.50	0,001	
		orange	61-9028.30	0,001	
		red	61-9028.20	0,001	
		white, opaque	61-9028.9	0,001	
		yellow	61-9028.40	0,001	
	grey	blue	61-9029.60	0,001	
		green	61-9029.50	0,001	
		grey, opaque	61-9029.8	0,001	
		orange	61-9029.30	0,001	
		red	61-9029.20	0,001	
		white, opaque	61-9029.9	0,001	
		yellow	61-9029.40	0,001	

marking plate

for lens round, 61-9642...

	front shape	marking plate	colour	part no.		
marking plate clear, of plastic, can be hot pressed	round	transparent	clear	61-9707.7	0,001	

front bezel

for selector switch square front

	material	colour	\varnothing 24 x 24 mm part no.	\varnothing 26 x 26 mm part no.		
front bezel	plastic	black	52-950.0	52-952.0	0,001	

front bezel-set for flush mounting

	use	material	colour	□ 24 x 30 mm part no.	□ 24 x 24 mm part no.	∅ 25 mm part no.			
front bezel-set for flush mounting	illuminated pushbutton/indicator	aluminium	natural			61-9933.0	0,006		
		anodized	black			61-9933.1	0,007		
		plastic	aluminium plated		61-9931.4	61-9930.4			0,007
			black		61-9931.0	61-9930.0	61-9933.10		0,006
	keylock switch	aluminium anodized	natural				61-9932.0		0,007
			black				61-9932.1		0,007
		plastic	aluminium plated		61-9931.4	61-9930.4			0,007
			black		61-9931.0	61-9930.0	61-9932.10		0,006
	selector switch	aluminium anodized	natural				61-9932.0		0,006
			black				61-9932.1		0,007
		plastic				61-9936.0	61-9932.10		0,007

front ring

for actuator 24 mm dia.

	material	colour	part no.		
front ring	aluminium anodized	black	61-9600.0	0,003	
		natural	61-9600.1	0,003	

protective front membrane cap

for actuator 24 mm dia.

	material	colour	part no.		
protective front membrane cap	silicone nature	transparent	61-9926.7	0,001	

protective front membrane cap for flush mounting

	material	colour	part no.		
protective front membrane cap for flush mounting for front bezel-set for flush mounting	silicone nature	transparent	84-9103.7	0,001	

protective cover

	□ 18 x 24 mm part no.	□ 18 x 18 mm part no.	□ 24 x 24 mm part no.	technical drawing		
protective cover hinged, transparent, with means for sealing	51-925			15	0,005	
			61-9920.0	16	0,006	
		51-920		14	0,005	

technical drawing as of page 140

protective cover for flush mounting

				
	24 x 30 mm part no.	24 x 24 mm part no.		
protective cover for flush mounting hinged, transparent, with means for sealing	61-9922.0	61-9921.0	0,006	

blind plug projecting

	colour			18 mm dia. part no.		mounting dimension		
		18 x 24 mm part no.	24 x 24 mm part no.		18 x 18 mm part no.			
blind plug projecting for mounting hole 16 mm dia.	black	51-947.0	61-9450.0	51-949.0	51-948.0	1	0,003	

[mounting dimensions as of page 145](#)

blind plug flat

	colour			28 mm dia. part no.	mounting dimension		
		24 x 30 mm part no.	24 x 24 mm part no.				
blind plug flat for mounting hole 21 x 21 mm	black		61-9451.0		3	0,006	
for mounting hole 21 x 27 mm	black	61-9452.0			3	0,006	
for mounting hole 22.5 mm dia.	black			704.960.7	3	0,006	

[mounting dimensions as of page 145](#)

EMC key protection cap

	part no.		
EMC key protection cap plastic black, for lock type DOM	31-985.0		

spare key

	part no.		
spare key for emergency stop switch with key to release, lock type KABA standard lock 1001, other lock numbers on request	14-987.1001	0,006	
for keylock switch, lock type DOM standard lock 311, other lock numbers on request	31-989.311	0,006	

[description see page 109](#)

master key

	part no.		
master key for lock numbers 311-445	31-989.300	0,006	

at back

lamp element

	part no.	circuit drawing		
lamp element with screw terminal	61-8006.01	1	0,005	

[circuit drawing as of page 150](#)

diode element

	number of diodes	part no.	circuit drawing	components layout		
diode element with soldering-/plug-in terminal	1	61-8101.02	20	1	0,007	
	2	61-8102.02	21	2	0,008	

[components layouts as of page 146, circuit drawing as of page 150](#)

switching element for illuminated-/pushbutton, keylock-/selector switch 2 positions

	diode (1N 4007)	switching system	contacts	connection method	material of contacts	part no.	circuit drawing	components layout		
switching element for illuminated-/pushbutton, keylock-/ selector switch 2 positions with lamp terminal, max. 250 VAC/6A	-	SA	1NC	ST/PT	gold/silver	61-8440.22	23	3	0,007	
					silver	61-8440.12	23	3	0,007	
			1NC + 1NO	ST/PT	gold/silver	61-8470.22	31	15	0,007	
					silver	61-8470.12	31	15	0,007	
			1NC + 2NO	ST/PT	gold/silver	61-8490.22	33	16	0,007	
					silver	61-8490.12	33	16	0,007	
			1NO	ST/PT	gold/silver	61-8410.22	28	12	0,007	
					silver	61-8410.12	28	12	0,007	
			2NC	ST/PT	gold/silver	61-8450.22	25	4	0,007	
					silver	61-8450.12	25	4	0,007	
			2NC + 1NO	ST/PT	gold/silver	61-8480.22	32	6	0,007	
					silver	61-8480.12	32	6	0,007	
			2NO	ST/PT	gold/silver	61-8420.22	35	13	0,007	
					silver	61-8420.12	35	-	0,007	
			3NC	ST/PT	gold/silver	61-8460.22	26	5	0,007	
					silver	61-8460.12	26	5	0,007	
			3NO	ST/PT	gold/silver	61-8430.22	36	14	0,007	
					silver	61-8430.12	36	14	0,007	
T	1NC	SCH	silver	61-8640.11	22	-	0,008			
		1NO	SCH	silver	61-8610.11	28	13	0,008		
2	SA	1NO + 2D	ST/PT	silver	61-8212.12	29	17	0,007		
			ST/PT	gold/silver	61-8212.22	29	17	0,007		
with lamp terminal, max. 42 VAC/DC/100 mA	-	T	1NC	ST/PT	gold	61-8640.37	23	10	0,008	
				1NC + 1NO	ST/PT	gold	61-8670.37	31	9	0,008
				1NO	ST/PT	gold	61-8610.37	28	7	0,008
				2NC	ST/PT	gold	61-8650.37	25	11	0,008
				2NO	ST/PT	gold	61-8620.37	35	8	0,008
with lamp terminal, max.250 VAC/5A	-	T	1NC	ST/PT	silver	61-8640.17	23	10	0,008	
				1NC + 1NO	ST/PT	silver	61-8670.17	31	9	0,008
				1NO	ST/PT	silver	61-8610.17	28	7	0,008
				2NC	ST/PT	silver	61-8650.17	25	11	0,008
				2NO	ST/PT	silver	61-8620.17	35	8	0,008
without lamp terminal, max. 250 VAC/6 A	-	T	1NC	SCH	silver	61-8645.11	22	-	0,008	
				1NC + 1NO	SCH	silver	61-8675.11	30	-	0,008
				1NO	SCH	silver	61-8615.11	27	-	0,008
				2NC	SCH	silver	61-8655.11	24	-	0,008
				2NO	SCH	silver	61-8625.11	34	-	0,008



switching system: SA = snap-action switching element, T = slow-make switching element
 connection method: SCH = screw terminal, ST/PT = soldering-/plug-in terminal
 contacts: NC = normally closed, NO = normally open
 components layouts as of page 146, circuit drawing as of page 150

switching element for emergency stop switch

	switching system	contacts	connection method	material of contacts	part no.	circuit drawing	components layout		
switching element for emergency stop switch max. 250 VAC/5A	T	1NC	ST/PT	silver	61-8745.17	37	19	0,008	
		1NC + 1NO	ST/PT	silver	61-8775.17	39	18	0,008	
		2NC	ST/PT	silver	61-8755.17	38	20	0,008	
max. 250 VAC/6A	T	1NC	SCH	silver	61-8745.11	37	-	0,008	
		1NC + 1NO	SCH	silver	61-8775.11	39	-	0,008	
		2NC	SCH	silver	61-8755.11	38	-	0,008	
max. 42 VAC/DC/100 mA	T	1NC	ST/PT	gold	61-8745.37	37	19	0,008	
		1NC + 1NO	ST/PT	gold	61-8775.37	39	18	0,008	
		2NC	ST/PT	gold	61-8755.37	38	20	0,008	

switching system: T = slow-make switching element
 connection method: SCH = screw terminal, ST/PT = soldering-/plug-in terminal
 contacts: NC = normally closed, NO = normally open
 components layouts as of page 146, circuit drawing as of page 150

switching element for keylock-/selector switch 3 positions

	switching system	contacts	connection method	material of contacts	part no.	circuit drawing	components layout		
switching element for keylock-/selector switch 3 positions with lamp terminal, max. 250 VAC/6A	SA	1NC + 1NO	ST/PT	gold/silver	61-8574.22	31	23	0,008	
				silver	61-8574.12	31	23	0,008	
		2NC	ST/PT	gold/silver	61-8550.22	25	21	0,008	
				silver	61-8550.12	25	21	0,008	
with lamp terminal, max. 42 VAC/DC/100 mA	T	1NC + 1NO	ST/PT	gold	61-8770.37	31	24	0,008	
				gold	61-8750.37	25	26	0,008	
		2NO	ST/PT	gold	61-8720.37	35	25	0,008	
with lamp terminal, max. 250 VAC/5A	T	1NC + 1NO	ST/PT	silver	61-8770.17	31	24	0,008	
				silver	61-8750.17	25	26	0,008	
		2NO	ST/PT	silver	61-8720.17	35	25	0,008	
without lamp terminal, max. 250 VAC/6 A	T	1NC + 1NO	SCH	silver	61-8775.11	31	-	0,008	
				silver	61-8755.11	24	-	0,008	
		2NO	SCH	silver	61-8725.11	35	-	0,008	

switching system: SA = snap-action switching element, T = slow-make switching element
 connection method: SCH = screw terminal, ST/PT = soldering-/plug-in terminal
 contacts: NC = normally closed, NO = normally open
 components layouts as of page 146, circuit drawing as of page 150

flasher element

	operation voltage	connection method	part no.		
flasher element	12 VAC/DC - 28 VAC/DC	ST	61-8000.05		

connection method: ST = soldering terminal
 typical applications see page 151
 circuit drawing as of page 150

PCB plug-in base

for plug-in terminal

	for	pin orientation	part no.	components layout		
PCB plug-in base 13.1 mm dia. x 12.8 mm	indicator complete	axial	61-9820.1	27	0,002	
15 mm x 23 mm x 9.4 mm	slow-make switching element	axial	61-9823	29	0,002	
17.7 mm x 23.6 mm x 10.9 mm	snap-action switching element	axial	61-9821.1	28	0,003	

components layouts as of page 146



multi-plug housing

	part no.		
multi-plug housing for snap-action switching element, max. 6 connections possible	61-9830	0,002	

cable shoe



	connection method	part no.		
cable shoe	plug in terminal 2,8 x 0,5 mm	31-946	0,001	
	plug-in terminal 2,8 x 0,5 mm for multi-plug housing	51-943.1	0,001	

terminal cover

	use	part no.		
terminal cover	for indicator element	61-9831.2	0,001	
	for snap-action switching element	61-9830.2	0,002	

for illumination



incandescent lamp

	voltage/current	part no.		
incandescent lamp base MG T 1 3/4	6 AC/DC/125 mA	10-1306.1349 (41-963.0)	0,001	
	6.3 AC/DC/200 mA	10-1307.1369 (31-963.0)	0,001	
	12 AC/DC/75 mA	10-1309.1309 (41-963.1)	0,001	
	14 AC/DC/80 mA	10-1310.1319 (31-963.1)	0,001	
	18 AC/DC/40 mA	10-1311.1249 (41-963.2)	0,001	
	24 AC/DC/35 mA	10-1312.1229 (41-963.3)	0,001	
	28 AC/DC/30 mA	10-1313.1209 (41-963.4)	0,001	
	28 AC/DC/40 mA	10-1313.1249 (31-963.2)	0,001	
	36 AC/DC/20 mA	10-1316.1179 (41-963.36)	0,001	
	36 AC/DC/30 mA	10-1316.1209 (31-963.5)	0,001	
	48 AC/DC/20 mA	10-1319.1179 (41-963.5)	0,001	
	48 AC/DC/25 mA	10-1319.1199 (31-963.3)	0,001	
	60 AC/DC/20 mA	10-1320.1179 (31-963.4)	0,001	

LED						
	number of chips	voltage/current	colour	part no.		
LED base MG T1 3/4	6 chips	6 VDC/45 mA	green	10-5306.3255 (31-968.05)	0,001	
			red	10-5306.3252 (31-968.02)	0,001	
			yellow	10-5306.3254 (31-968.04)	0,001	
		12 VDC/30 mA	green	10-5309.3205 (31-968.15)	0,001	
			red	10-5309.3202 (31-968.12)	0,001	
			yellow	10-5309.3204 (31-968.14)	0,001	
		24 VAC/DC/12.5 mA	green	10-5312.1115 (22-996.51)	0,001	
			red	10-5312.1112 (22-996.21)	0,001	
			yellow	10-5312.1114 (22-996.41)	0,001	
		24 VDC/14 mA	green	10-5312.3135 (31-968.25)	0,001	
			red	10-5312.3132 (31-968.22)	0,001	
			yellow	10-5312.3134 (31-968.24)	0,001	
		28 VAC/DC/12.5 mA	green	10-5313.1115 (22-997.51)	0,001	
			red	10-5313.1112 (22-997.21)	0,001	
			yellow	10-5313.1114 (22-997.41)	0,001	
		28 VDC/14 mA	green	10-5313.3135 (22-997.5)	0,001	
			red	10-5313.3132 (22-997.2)	0,001	
			yellow	10-5313.3134 (22-997.4)	0,001	
	48 VDC/12 mA	green	10-5319.3105 (31-968.45)	0,001		
		red	10-5319.3102 (31-968.42)	0,001		
		yellow	10-5319.3104 (31-968.44)	0,001		
	8 chips	6 VDC/48 mA	green	10-6306.3265 (61-994.5)	0,001	
			red	10-6306.3262 (61-994.2)	0,001	
			yellow	10-6306.3264 (61-994.4)	0,001	
		12 VDC/24 mA	green	10-6309.3185 (61-995.5)	0,001	
			red	10-6309.3182 (61-995.2)	0,001	
			yellow	10-6309.3184 (61-995.4)	0,001	
		24 VDC/12 mA	green	10-6312.3105 (61-996.5)	0,001	
			red	10-6312.3102 (61-996.2)	0,001	
			yellow	10-6312.3104 (61-996.4)	0,001	
		28 VDC/12 mA	green	10-6313.3105 (96-997.5)	0,001	
			red	10-6313.3102 (61-997.2)	0,001	
			yellow	10-6313.3104 (61-997.4)	0,001	
	1 chip	24 VDC/14 mA	white	10-2312.3139	0,001	
		28 VDC/14 mA	white	10-2313.3139	0,001	

capacitor



for lamp voltage reduction

	value	part no.		
capacitor use with 60 VAC/20 mA, 50 Hz lamp voltage	230 VAC/0.27 µF	02-917.0	0,004	

Wire in accordance with local electrical safety regulations.

series resistor

for lamp voltage reduction

	value	part no.		
series resistor use with 60 VAC/20 mA lamp rating	110 V/2.7 kOhm	02-904.0	0,003	
	125 V/3.3 kOhm	02-904.1	0,003	
	145 V/4.7 kOhm	02-904.3	0,003	
	230-240 V/10 kOhm	02-904.7	0,003	

Wire in accordance with local electrical safety regulations.

terminal plate empty

for fitting with series resistors and capacitors

	no. of spaces	part no.		
terminal plate empty	5 spaces	02-912.1	0,025	
	10 spaces	02-912.2	0,045	
	15 spaces	02-912.3	0,090	
	20 spaces	02-912.4	0,095	

terminal plate with capacitor

	value	no. of components	part no.		
terminal plate with capacitor use with 60 VAC/20 mA lamp rating	0,27 µF/230 VAC/60 VAC	5 spaces	02-914.10	0,045	
		10 spaces	02-914.20	0,090	
		15 spaces	02-914.30	0,135	
		20 spaces	02-914.40	0,180	

terminal plate with series resistor

	value	no. of components	part no.		
terminal plate with series resistor use with 60 VAC/20 mA lamp rating	2.7 kOhm/110/60 V	5 spaces	02-913.10	0,040	
		10 spaces	02-913.20	0,075	
		15 spaces	02-913.30	0,115	
		20 spaces	02-913.40	0,155	
	3.3 kOhm/125/60 V	5 spaces	02-913.11	0,040	
		10 spaces	02-913.21	0,075	
		15 spaces	02-913.31	0,115	
		20 spaces	02-913.41	0,155	
	10 kOhm/230-240/60 V	5 spaces	02-913.17	0,040	
		10 spaces	02-913.27	0,075	
		15 spaces	02-913.37	0,115	
		20 spaces	02-913.47	0,155	

Wire in accordance with local electrical safety regulations.

for emergency stop switch

label for emergency stop switch

	marking	43 mm dia. part no.		
label for emergency stop switch 43 mm dia., yellow	ARRET D'URGENCE	61-9970.3	0,002	
	Emergency Stop	61-9970.2	0,002	
	NOT-AUS	61-9970.1	0,002	
	without marking	61-9970.0	0,002	

protective shroud for emergency stop switch

	part no.		
protective shroud for emergency stop switch aluminium anodized, yellow	61-9965		

enclosure for emergency stop switch

	part no.	 kg	
enclosure for emergency stop switch with mounting hole size 16 mm dia. colour RAL 1004. dimensions: 65 mm long, 65 mm wide, 57 mm high front protection IP 65	61-9480.4	0,079	

cable gland PG11

	part no.		
cable gland PG11	61-9481.8		

assembling

anti-twisting ring

	part no.	 kg	
anti-twisting ring for key- and selector switch	51-910.0	0,002	

reducing ring

for 16 mm pushbuttons in mounting hole 22.5 mm dia.

	part no.	 kg	
reducing ring only for use of front dimension: 24 x 24 mm/24 mm dia.	61-9960	0,003	

tool-set

	part no.	 kg	
tool-set consists of lens remover, lamp remover, mounting tool, dismantling tool	K61-999.100		

lens remover

	use	part no.	 kg	
lens remover	for 24 x 24 mm, 25 mm dia. front and overhanging lenses	61-9730.0	0,011	
	for standard lenses	02-905	0,011	

lamp/LED remover

	part no.	 kg	
lamp/LED remover	61-9740.0	0,003	

dismantling tool for lens

for dismantling of lens and lensholder

	part no.	 kg	
dismantling tool for standard lens	51-938	0,027	
dismantling tool for lens for flush mounting	61-9832	0,024	

dismantling tool for switching element

	part no.	 kg	
dismantling tool for switching element	61-9711.0	0,004	

mounting tool

	part no.	 kg	
mounting tool for tightening (or loosening) fixing nuts	01-907	0,020	

cable shoe remover

	part no.	 kg	
cable shoe remover for removing the connector from the multi-plug housing	51-943.9	0,001	

actuator with snap-action switching element

switching system

Self-cleaning, double-break, snap-action switching elements (contact gap 2 x 0.5 mm).

The elements can be supplied with the following choice of switching functions:

for illuminated pushbutton or switch actuator with 2 positions: max. 3 normally open contacts, max. 3 normally closed contacts or combined

switch actuator with 3 positions:

max. 2 normally open contacts, max. 2 normally closed contacts or combined

The switching element can be easily snapped to or dismantled from the actuator.

material

actuator case

polyetherimide PEI, self-extinguishing

front bezel

polyetherimide PEI and chromium plated

front ring

of aluminium

lenses

polymethylmethacrylat PMMA, polycarbonate PC, aluminium (mushroom head cap: polyamide PA)

material of contacts

gold-plated silver or silver

switching element

diallyl phthalate DAP, self-extinguishing, polysulfone PSU

mechanical characteristics

actuating force

measured at the lens of the illuminated pushbutton:
2.7-10 N, depending on the number of switching elements

actuating torque

measured at the lever or key of the selector-or keylock switch:
2.5 - 10 Ncm, depending on the number of switching elements

actuating travel

illuminated pushbutton :3 mm

switch actuator with 2 positions:

1 x ca. 42° deflection momentary action

1 x ca. 90° deflection maintained action

switch actuator with 3 positions:

2 x ca. 42° deflection momentary action

2 x ca. 90° deflection maintained action

ambient air temperature

-25°C to +55°C

for indicators and illuminated pushbuttons mounted as a block, make sure the heat can escape freely (as per DIN IEC 68-)

connection method

universal terminal (soldering-/plug-in terminal):

max. wire diameter: 2 of 1 mm

max. wire cross-section of stranded cable: 1 x 0.75 mm² soldering-/plug-in terminal: 2.8 x 0.5 mm

degree of protection

indicator, illuminated pushbutton, emergency stop switch, selector- and keylock switch: front IP 65

switching element IP 40

soldering terminal IP 20

mechanical life

as per IEC 512-5-6

momentary action 2 mio. cycles of operation

maintained action 1 mio. cycles of operation

keylock switch 50000 cycles of operation

selector switch 100000 cycles of operation

rebound time

<= 5ms

resistance to shock

(single impacts, semi-sinusoidal)

50 g, 11 ms as per IEC 512-4-3, IEC 68-2-27

resistance to vibration

(sinusoidal)

10 g, at 10- 2000- 10 Hz, amplitude 0.75 mm as per IEC 512-4-4, IEC 68-2-6

storage temperature

-40°C to + 85°C

(as per DIN IEC 68-)

electrical characteristics

continuous thermal current I_{th2}

5 A

The maximum current in continuous operation and at ambient temperature not exceeding the quoted maximum values.

electric strength

as per VDE 0630 (IEC 512-2-11)

2500 VAC, 50 Hz, 1 min between all terminals and earth

electrostatic breakdown value

>= 11 KV (keylock switch)

protection class

II

rated current

6 A

rated voltage

250 VAC/VDC

switch rating

gold-/silver contact:

min. 5 VAC/10 mA

max. 250 VAC/6 A

silver contact:

min. 20 VAC/500 mA

max. 250 VAC/6 A

switch rating AC, cos. φ 0,7:

rated service voltage	250 VAC	125 VAC	110 VAC
-----------------------	---------	---------	---------

rated service current	2 A	3 A	3 A
-----------------------	-----	-----	-----

switch rating DC, L:R=30 ms:

rated service voltage:	220	110	60	24 VDC
------------------------	-----	-----	----	--------

rated service current				
-----------------------	--	--	--	--

resistive:	0.5	0.7	2.0	6.0 A
------------	-----	-----	-----	-------

rated service current				
-----------------------	--	--	--	--

L:R=30ms:	0.15	0.3	0.7	2.0 A
-----------	------	-----	-----	-------

volume resistance

starting value (initial) for:

gold-/silver contact <= 50 mΩ as per IEC 512-2-test 4

silver contact <= 100 mΩ as per IEC 512-2-test 5

Technical Data

rules

IEC 1058 EN 61 058

approvals

- SEV 250 VAC/6 A
- CSA 300 VAC
- UR 250 VAC/6 A
- VDE 250 VAC/6 A
- German Lloyd

actuator with slow-make switching element

switching system

Self-cleaning, double-break, snap-action switching elements (contact gap 2 x 1.5 mm).

The elements can be supplied with the following choice of switching functions:

for illuminated pushbutton or switch actuator with 2 positions:
max. 2 normally open contacts, max. 2 normally closed contacts or combined

for switch actuator with 3 positions:
max. 2 normally open contacts, max. 2 normally closed contacts or combined

The switching element can be easily snapped to or dismantled from the actuator.

material

actuator case

polyetherimide PEI, self-extinguishing

front bezel

polyetherimide PEI and chromium plated

front ring

of aluminium

lenses

polymethylmethacrylat PMMA, polycarbonate PC, aluminium (mushroom head cap: polyamide PA)

material of contacts

gold (low level), silver

switching element

polyamide PA, polysulfone PSU

mechanical characteristics

actuating force

measured at the lens of the illuminated pushbutton:
3.5-20 N, depending on the number of switching elements

measured at the mushroom head cap of the emergency stop switch:
max. 65 N

actuating torque

measured at the lever or key of the selector-or keylock switch:
4-16 Ncm, depending on the number of switching elements
emergency stop switch: 15 Ncm

actuating travel

illuminated pushbutton :3 mm

emergency stop switch:10 mm

switch actuator with 2 positions:

1 x ca. 42° deflection momentary action

1 x ca. 90° deflection maintained action

switch actuator with 3 positions:

2 x ca. 42° deflection momentary action

2 x ca. 90° deflection maintained action

ambient air temperature

-25°C to +55°C

for indicators and illuminated pushbuttons mounted as a block ,
make sure the heat can escape freely
(as per DIN IEC 68-)

connection method

universal terminal (soldering-/plug-in terminal):

max. wire diameter: 2 of 1 mm

max. wire cross-section of stranded cable: 1 x 0.75 mm²

soldering-/plug-in terminal: 2.8 x 0.5 mm

screw terminal:

max. wire cross-section of stranded cable: 1 x 1 mm²

degree of pollution

3

degree of protection

indicator, illuminated pushbutton, emergency stop switch, selector-
and keylock switch: front IP 65

switching element IP 40

screw terminal IP 20 as per VDE 0106 Teil 100

mechanical life

as per IEC 512-5-6

momentary action 2 mio. cycles of operation

maintained action 1 mio. cycles of operation

keylock switch 50000 cycles of operation

selector switch 100000 cycles of operation

emergency stop switch 50000 cycles of operation

rebound time

<= 2 ms

resistance to shock

(single impacts, semi-sinusoidal)

50 g, 11 ms as per IEC 512-4-3, IEC 68-2-27

resistance to vibration

(sinusoidal)

10 g, at 10- 2000- 10 Hz, amplitude 0.75 mm as per IEC 512-4-4,
IEC 68-2-6

storage temperature

-40°C to + 85°C

(as per DIN IEC 68-)

electrical characteristics

continuous thermal current Ith2

universal terminal 5 A

screw terminal 10 A

The maximum current in continuous operation and at ambient temperature not exceeding the quoted maximum values.

electric strength

as per VDE 0630 (IEC 512-2-11)

4000 VAC, 50 Hz, 1 between all terminals and earth

electrical life

switching element of emergency stop switch 6'050 cycles of operation

Technical Data

electrostatic breakdown value

>= 11 KV (keylock switch)

max. permissible rated current

10 A gL

over voltage category

III

protection class

II

rated current

6 A

rated voltage

300 V

switch rating

gold contact (universal terminal, Low Level):

min. 100 μ V/10 μ A

max. 42 VAC/100 mA;

silver contact (universal terminal):

min. 20 VAC/10 mA

max. 250 VAC/5 A

silver contact (screw terminal):

min. 20 VAC/10 mA

max. 250 VAC/6 A

switch rating AC:

rated service voltage	250	120	60	24 VAC
-----------------------	-----	-----	----	--------

rated service current AC 13	3 A	5 A	6 A	6 A
-----------------------------	-----	-----	-----	-----

rated service current AC 14*	2 A	3 A	4 A	5 A
------------------------------	-----	-----	-----	-----

rated service current AC 15**	2 A			
-------------------------------	-----	--	--	--

*only for emergency stop switch with universal terminal

**only for emergency stop switch with screw terminal

switch rating DC :

rated service voltage:	240	110	60	24 VDC
------------------------	-----	-----	----	--------

rated service current resistive:	0,5	0,7	2,0	6,0 A
----------------------------------	-----	-----	-----	-------

rated service current L:R=30 ms:	0.2	0.4	1.0	2.0 A
----------------------------------	-----	-----	-----	-------

volume resistance

starting value (initial) for:

gold contact <= 50 m Ω as per IEC 512-2-test 4

silver contact <= 50 m Ω as per IEC 512-2-test 5

electrical characteristics

flashing frequency

1 Hz \pm 0.25 Hz

illumination

incandescent lamp: 14 V, 80 mA or 28 V, 40 mA

Multi-LED: 12 V, 25 mA or 24 V, 12.5 mA

making cycle

1:1

operating voltage

AC or DC

12 - 10% or 28 V + 10%

rules

IEC 947-5-1 EN 60 947

approvals

- SEV 250 VAC
- CSA
- UL
- VDE

actuator with flasher element

material

actuator case

polyetherimide PEI, self-extinguishing

lenses

polymethylmethacrylat PMMA, polycarbonate PC

mechanical characteristics

ambient air temperature

0°C to + 45°C

(as per DIN IEC 68-)

connection method

soldering terminal 2.8 x 0.8 mm

technical drawing

1 indicator complete

page 111



2 indicator-flasher-actuator

page 111



diode element with soldering-/plug-in terminal

lamp-element with screw terminal

flasher-element with soldering terminal

3 illuminated-/pushbutton actuator

page 112



snap-action switching element with soldering-/plug-in terminal

slow-make switching element with soldering-/plug-in terminal

slow-make switching element with screw terminal

4 emergency stop switch actuator foolproof

page 112



5 pushbutton actuator with mushroom-head cap

page 113



6 keylock switch actuator 2 positions, keylock switch actuator 3 positions page 113, 114



7 selector switch actuator 2 positions, selector switch actuator 3 positions page 115, 116



8 indicator complete for flush mounting page 117



9 indicator/flasher-actuator for flush mounting

page 117



10 illuminated-/pushbutton actuator for flush mounting

page 118



11 mushroom pushbutton actuator for flush mounting

page 118



12 keylock switch actuator with 2 positions for flush mounting, keylock switch actuator 3 positions for flush mounting
page 119, 120



13 selector switch actuator 2 positions for flush mounting, selector switch actuator 3 positions for flush mounting
page 121, 122



14 protective cover
page 126



15 protective cover
page 126



16 protective cover
page 126



mounting dimension

1 indicator complete, indicator-flasher-actuator, illuminated-/pushbutton actuator, keylock switch actuator 2 positions, keylock switch actuator 3 positions, selector switch actuator 2 positions, selector switch actuator 3 positions, blind plug projecting
page 111, 112, 113, 114, 115, 116, 127



2 emergency stop switch actuator foolproof, pushbutton actuator with mushroom-head cap, mushroom pushbutton actuator for flush mounting
page 112, 113



3 indicator complete for flush mounting, indicator-flasher-actuator for flush mounting, illuminated-/pushbutton actuator for flush mounting, keylock switch actuator with 2 positions for flush mounting, keylock switch actuator 3 positions for flush mounting, selector switch actuator 2 positions for flush mounting, selector switch actuator 3 positions for flush mounting, blind plug flat
page 117,118,119,120, 121, 122, 127

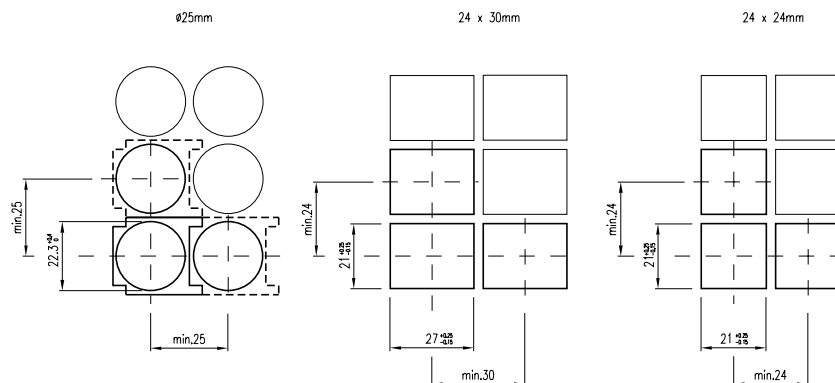

components layouts

1 diode element

page 128

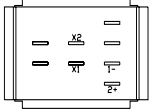

2 diode element

page 128

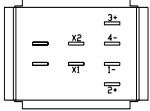

3 switching element for illuminated-/pushbutton, keylock-/selector switch 2 positions

page 129

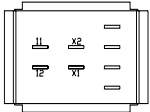

4 switching element for illuminated-/pushbutton, keylock-/selector switch 2 positions

page 129

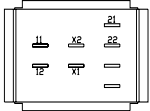

5 switching element for illuminated-/pushbutton, keylock-/selector switch 2 positions

page 129

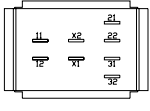

6 switching element for illuminated-/pushbutton, keylock-/selector switch 2 positions

page 129

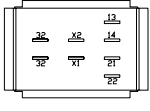

7 switching element for illuminated-/pushbutton, keylock-/selector switch 2 positions

page 129

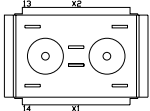

8 switching element for illuminated-/pushbutton, keylock-/selector switch 2 positions

page 129

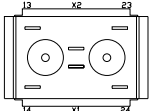

9 switching element for illuminated-/pushbutton, keylock-/selector switch 2 positions

page 129

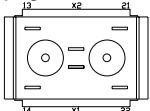

10 switching element for illuminated-/pushbutton, keylock-/selector switch 2 positions
page 129



11 switching element for illuminated-/pushbutton, keylock-/selector switch 2 positions
page 129



12 switching element for illuminated-/pushbutton, keylock-/selector switch 2 positions
page 129



13 switching element for illuminated-/pushbutton, keylock-/selector switch 2 positions
page 129



14 switching element for illuminated-/pushbutton, keylock-/selector switch 2 positions
page 129



15 switching element for illuminated-/pushbutton, keylock-/selector switch 2 positions
page 129



16 switching element for illuminated-/pushbutton, keylock-/selector switch 2 positions
page 129



17 switching element for illuminated-/pushbutton, keylock-/selector switch 2 positions
page 129



18 switching element for emergency stop switch
page 130



19 switching element for emergency stop switch
page 130



20 switching element for emergency stop switch
page 130



21 switching element for keylock-/selector switch 3 positions
page 130



22 switching element for keylock-/selector switch 3 positions
page 130



23 switching element for keylock-/selector switch 3 positions
page 130



24 switching element for keylock-/selector switch 3 positions
page 130



25 switching element for keylock-/selector switch 3 positions
page 130



26 switching element for keylock-/selector switch 3 positions
page 130



27 PCB plug-in base
page 131



28 PCB plug-in base
page 131



29 PCB plug-in base
page 131



	circuit drawing		circuit drawing
1		21	
2		22	
3		23	
4		24	
5		25	
6		26	
7		27	
8		28	
9		29	
10		30	
11		31	
12		32	
13		33	
14		34	
15		35	
16		36	
17		37	
18		38	
19		39	
20			

With indicators and illuminated pushbuttons equipped with diodes, the user is able to perform a lamp check or wire an alarm circuit simply with a considerable saving of space.

lamp check



lamp check with blocking diodes



alarm circuit from fault
annunciating system



lamp check and alarm circuit



lamp check and alarm circuit with
only one diode and AC voltage



LC = lamp check

Flasher element



1. Continuous light

1. Engraving

Typefaces

In addition to the most commonly used world languages (see DIN 1451) with close spacing, the following typefaces are available: Scandinavian, Slavian, Greek, Russian.

Coloured filling of engraving

Specify whether engraving should be on the diffuser, or on the lens.
Specify the infill colour, character height and the text or symbol orientation.

Symbols

A list of the symbols available can be supplied on request.

2. Hot stamping

For large batches it is worth while to have the lettering produced by hot stamping.

Typefaces

For letters and figures, typefaces with 2,5 mm, 3 mm and 4 mm are available.

Symbols

A list of the symbols available can be supplied on request.



Important!

Before engraving, check the position of the illuminated pushbutton or indicator

Height of letters mm	(switch) lens	(18 x 24) 15,3 x 21,5 mm						(Ø 18) Ø 15,8 mm			(18 x 18) 15,3 x 15,3 mm		
		Horizontal mounting			Vertical mounting			Number of lines	Number of letters per line	Number of letters per line	Number of lines	Number of letters per line	Number of letters per line
h	s	Number of lines	Number of letters per line	Number of letters per line	Number of lines	Number of letters per line	Number of letters per line						
2,5	0,4	4	11	12	5	7-8	8	3	6	6	4	7-8	8
3	0,4	3	9-10	10-11	4	6-7	7	2	5	6	3	6-7	7
4	0,5	2	7	7-8	3	4-5	5	2	3	4	2	4-5	5
5	0,5	2	5-6	6	2	3-4	4	1	2	3	2	3-4	4
6	0,6	1	4-5	5	2	3	3-4	1	2	2	1	3	3-4
8	0,6	1	3-4	3-4	1	2-3	2-3	1	2	2	1	2-3	2-3
Film dimension		□ max. 12,7 x 18,7 mm						Ø 12,8 mm			□ 12,7 x 12,7 mm		

3. Film inserts

Instead of using engraving, the lenses can be fitted with transparent film inserts. For this purpose, though, it is advisable to use transparent lenses. When a smoked lens is used, the lettering does not become visible until the lamp lights.



Film dimensions

16,9x16,9 mm
11,9x11,9 mm
max 11,9x18,0 mm

Film thickness

0.2 mm

Important!

Before engraving, check the position of the illuminated pushbutton or indicator.

Height of letters		Thickness of letters		Number of lines		Number of letters per line		Number of letters per line		Number of lines		Number of letters per line		Number of letters per line		Number of lines		Number of letters per line		Number of letters per line		
h	s	(caps)	(small)	(caps)	(small)	(caps)	(small)	(caps)	(small)	(caps)	(small)	(caps)	(small)	(caps)	(small)	(caps)	(small)	(caps)	(small)	(caps)	(small)	
2,5	0,4	3	6	6	4	9	10	4	12	13	5	8-9	9	4	8-9	9	4	8-9	9	4	8-9	9
3	0,4	2	5	6	3	7-8	9	3	10-11	11-12	4	7-8	8	3	7-8	8	3	7-8	8	3	7-8	8
4	0,5	2	3	4	2	4-5	5	2	7	8	3	4-5	5	2	4-5	5	2	4-5	5	2	4-5	5
5	0,5	1	2	3	2	4	4-5	2	5-6	6	2	4	4-5	2	4	4-5	2	4	4-5	2	4	4-5
6	0,6	1	2	3	1	4	4	1	4-5	5	2	3	3-4	1	4	4	1	4	4	1	4	4
8	0,6	1	2	2	1	2	2	1	3-4	3-4	1	2-3	2-3	1	2-3	2-3	1	2-3	2-3	1	2-3	2-3
Film dimension						□ 16,9 x 16,9 mm				□ 15,1 x 21 mm				□ 15,1 x 15,1 mm								



**Стандарт
Электрон
Связь**

Мы молодая и активно развивающаяся компания в области поставок электронных компонентов. Мы поставляем электронные компоненты отечественного и импортного производства напрямую от производителей и с крупнейших складов мира.

Благодаря сотрудничеству с мировыми поставщиками мы осуществляем комплексные и плановые поставки широчайшего спектра электронных компонентов.

Собственная эффективная логистика и склад в обеспечивает надежную поставку продукции в точно указанные сроки по всей России.

Мы осуществляем техническую поддержку нашим клиентам и предпродажную проверку качества продукции. На все поставляемые продукты мы предоставляем гарантию .

Осуществляем поставки продукции под контролем ВП МО РФ на предприятия военно-промышленного комплекса России , а также работаем в рамках 275 ФЗ с открытием отдельных счетов в уполномоченном банке. Система менеджмента качества компании соответствует требованиям ГОСТ ISO 9001.

Минимальные сроки поставки, гибкие цены, неограниченный ассортимент и индивидуальный подход к клиентам являются основой для выстраивания долгосрочного и эффективного сотрудничества с предприятиями радиоэлектронной промышленности, предприятиями ВПК и научно-исследовательскими институтами России.

С нами вы становитесь еще успешнее!

Наши контакты:

Телефон: +7 812 627 14 35

Электронная почта: sales@st-electron.ru

Адрес: 198099, Санкт-Петербург,
Промышленная ул, дом № 19, литера Н,
помещение 100-Н Офис 331