



# C2M1000170D

## Silicon Carbide Power MOSFET Z-FET™ MOSFET

N-Channel Enhancement Mode

### Features

- High Speed Switching with Low Capacitances
- High Blocking Voltage with Low  $R_{DS(on)}$
- Easy to Parallel and Simple to Drive
- Resistant to Latch-Up
- Halogen Free, RoHS Compliant

### Benefits

- Higher System Efficiency
- Increased System Switching Frequency
- Reduced Cooling Requirements
- Increased System Reliability

### Applications

- Auxiliary Power Supplies
- Switch Mode Power Supplies

$V_{DS}$  1700 V

$I_D @ 25^\circ C$  4.9 A

$R_{DS(on)}$  1.0  $\Omega$

### Package

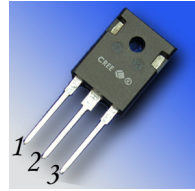

TO-247-3

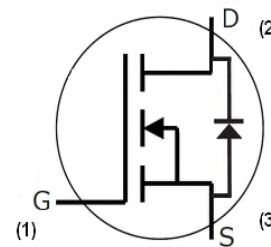

Part Number	Package
C2M1000170D	TO-247-3

### Maximum Ratings ( $T_C = 25^\circ C$ unless otherwise specified)

Symbol	Parameter	Value	Unit	Test Conditions	Note
$I_{DS(DC)}$	Continuous Drain Current	4.9	A	$V_{GS} = 20 V, T_C = 25^\circ C$	Fig. 14
		3.0		$V_{GS} = 20 V, T_C = 100^\circ C$	
$I_{DS(pulse)}$	Pulsed Drain Current	5.0	A	Pulse width $t_p$ limited by $T_{jmax}$ $T_C = 25^\circ C$	Fig. 16
$V_{GS}$	Gate Source Voltage	-10/+25	V		
$P_{tot}$	Power Dissipation	69	W	$T_C = 25^\circ C, T_J = 150^\circ C$	Fig. 13
$T_J, T_{stg}$	Operating Junction and Storage Temperature	-55 to +150	$^\circ C$		
$T_L$	Solder Temperature	260	$^\circ C$	1.6 mm (0.063") from case for 10s	
$M_d$	Mounting Torque	1	Nm lbf-in	M3 or 6-32 screw	
		8.8			



## Electrical Characteristics (T<sub>c</sub> = 25°C unless otherwise specified)

Symbol	Parameter	Min.	Typ.	Max.	Unit	Test Conditions	Note
V <sub>(BR)DSS</sub>	Drain-Source Breakdown Voltage	1700			V	V <sub>GS</sub> = 0 V, I <sub>D</sub> = 100 μA	
V <sub>GS(th)</sub>	Gate Threshold Voltage	2.0	2.4		V	V <sub>DS</sub> = V <sub>GS</sub> , I <sub>D</sub> = 100 μA	Fig. 9
		1.4	1.8		V	V <sub>DS</sub> = V <sub>GS</sub> , I <sub>D</sub> = 100 μA T <sub>J</sub> = 150 °C	
I <sub>DSS</sub>	Zero Gate Voltage Drain Current			30	nA	V <sub>DS</sub> = 1700 V, V <sub>GS</sub> = 0 V	
				100		V <sub>DS</sub> = 1700 V, V <sub>GS</sub> = 0 V T <sub>J</sub> = 150 °C	
I <sub>GSS</sub>	Gate-Source Leakage Current			20	nA	V <sub>GS</sub> = 20 V, V <sub>DS</sub> = 0 V	
R <sub>DS(on)</sub>	Drain-Source On-State Resistance		0.95	1.1	Ω	V <sub>GS</sub> = 20 V, I <sub>D</sub> = 2 A	Fig. 6, 7, 8
			2.1	2.9		V <sub>GS</sub> = 20 V, I <sub>D</sub> = 2 A, T <sub>J</sub> = 150 °C	
g <sub>fs</sub>	Transconductance		0.9		S	V <sub>DS</sub> = 20 V, I <sub>DS</sub> = 2 A	Fig. 5
			0.8			V <sub>DS</sub> = 20 V, I <sub>DS</sub> = 2 A, T <sub>J</sub> = 150 °C	
C <sub>iss</sub>	Input Capacitance		191		pF	V <sub>GS</sub> = 0 V V <sub>DS</sub> = 1000 V f = 1 MHz	Fig. 12
C <sub>oss</sub>	Output Capacitance		12				
C <sub>rss</sub>	Reverse Transfer Capacitance		1.3				
E <sub>oss</sub>	C <sub>oss</sub> Stored Energy		6.0		μJ	V <sub>AC</sub> = 25 mV	Fig. 10
t <sub>d(on)v</sub>	Turn-On Delay Time		9		ns	V <sub>DD</sub> = 1000 V, V <sub>GS</sub> = -5/20 V I <sub>D</sub> = 2 A R <sub>G(ext)</sub> = 0 Ω, R <sub>L</sub> = 40 Ω Timing relative to V <sub>DS</sub>	Fig. 7
t <sub>rv</sub>	Rise Time		46				
t <sub>d(off)v</sub>	Turn-Off Delay Time		15				
t <sub>fv</sub>	Fall Time		9				
R <sub>G</sub>	Internal Gate Resistance		24.8		Ω	f = 1 MHz, V <sub>AC</sub> = 25 mV, ESR of C <sub>ISS</sub>	

## Thermal Characteristics

Symbol	Parameter	Typ.	Max.	Unit	Test Conditions	Note
R <sub>θJC</sub>	Thermal Resistance from Junction to Case	1.7	1.8	°C/W		Fig. 15

## Gate Charge Characteristics

Symbol	Parameter	Typ.	Max.	Unit	Test Conditions	Note
Q <sub>gs</sub>	Gate to Source Charge	2.7		nC	V <sub>DS</sub> = 1000 V, V <sub>GS</sub> = -5/20 V I <sub>D</sub> = 1 A Per JEDEC24 pg 27	Fig. 18
Q <sub>gd</sub>	Gate to Drain Charge	5.4				
Q <sub>g</sub>	Gate Charge Total	13				

## Typical Performance

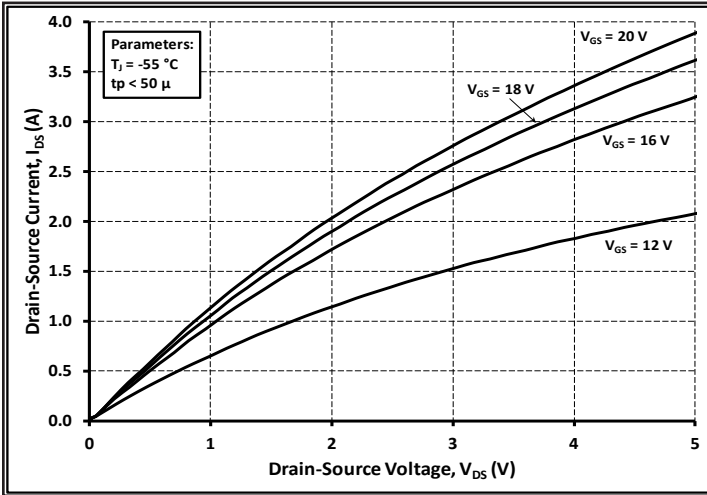

Figure 1. Typical Output Characteristics  $T_j = -55\text{ }^\circ\text{C}$

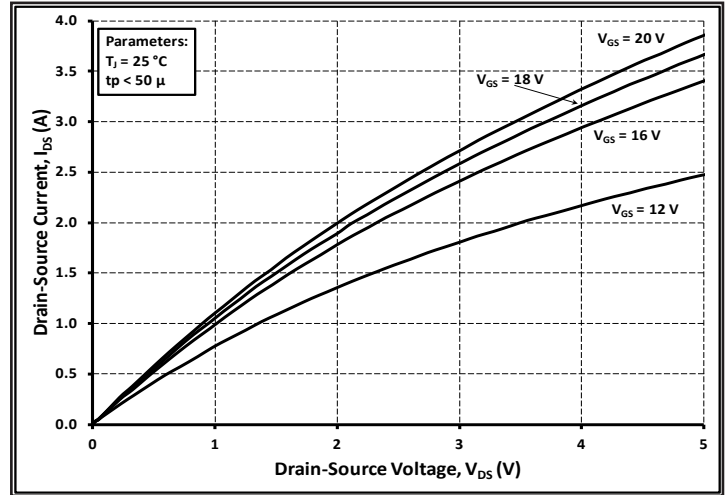

Figure 2. Typical Output Characteristics  $T_j = 25\text{ }^\circ\text{C}$

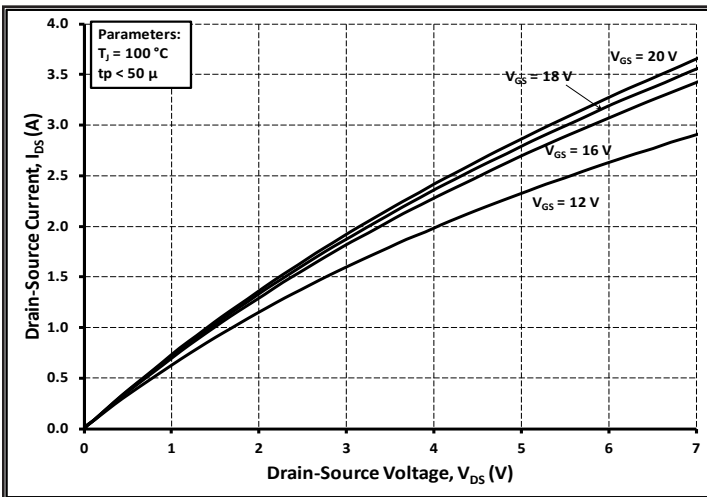

Figure 3. Typical Output Characteristics  $T_j = 100\text{ }^\circ\text{C}$

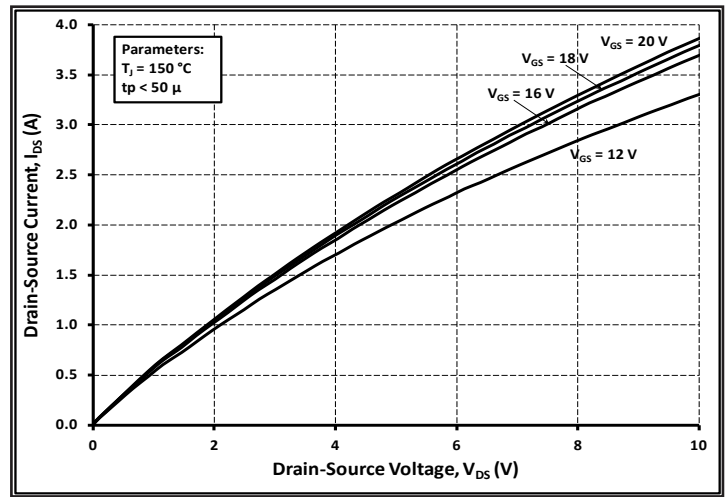

Figure 4. Typical Output Characteristics  $T_j = 150\text{ }^\circ\text{C}$

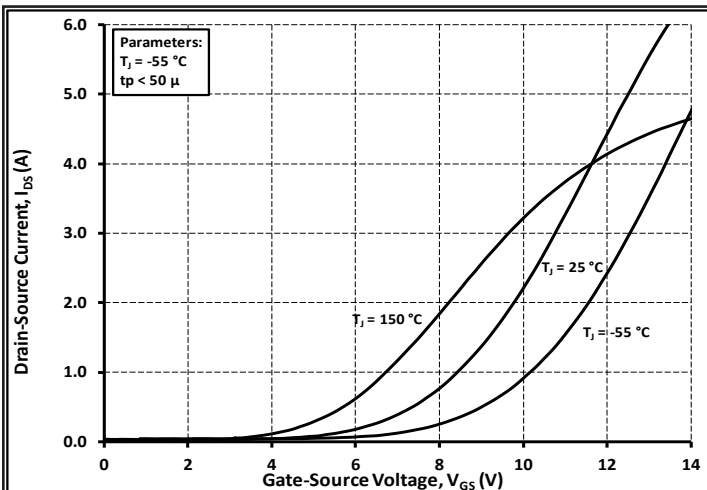

Figure 5. Typical Transfer Characteristics

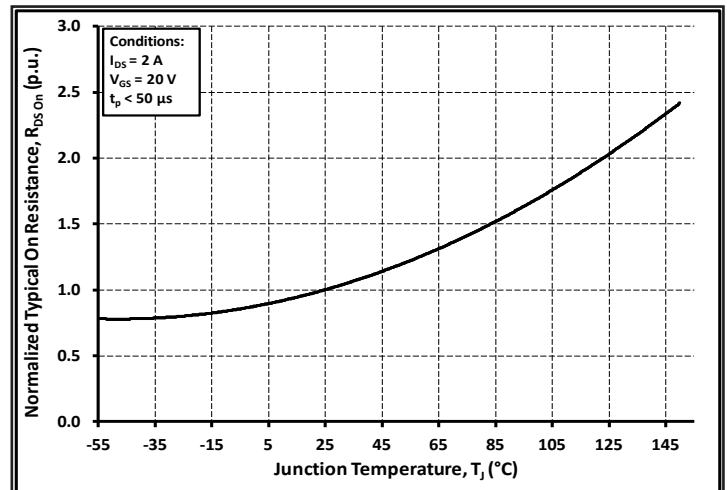

Figure 6. Normalized On-Resistance vs. Temperature

# Typical Performance

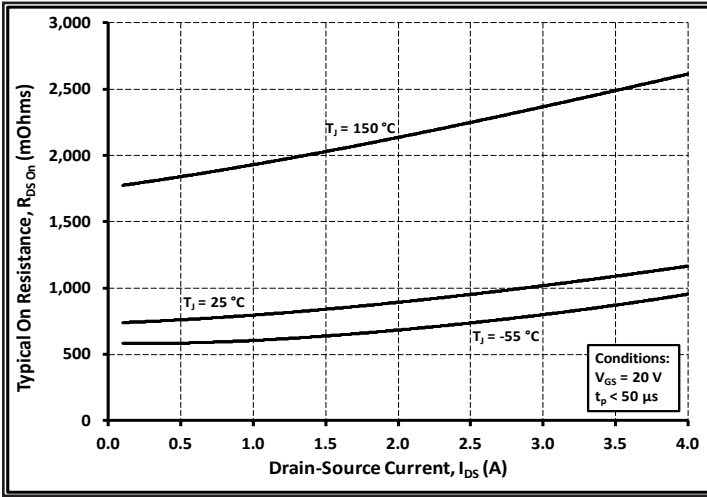

Figure 7. Typical On-Resistance vs. Drain Current

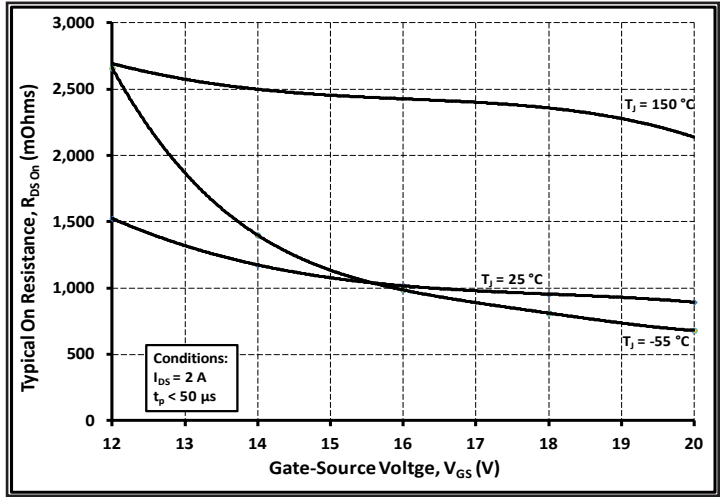

Figure 8. Typical On-Resistance vs. Gate Voltage

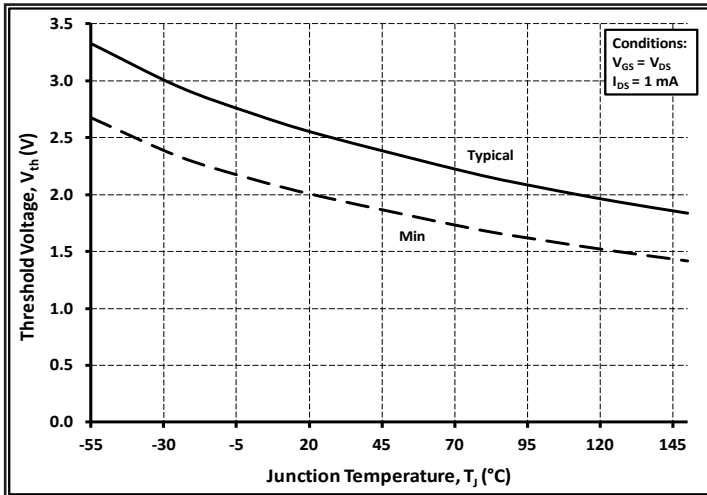

Figure 9. Typical Threshold Voltage vs. Temperature

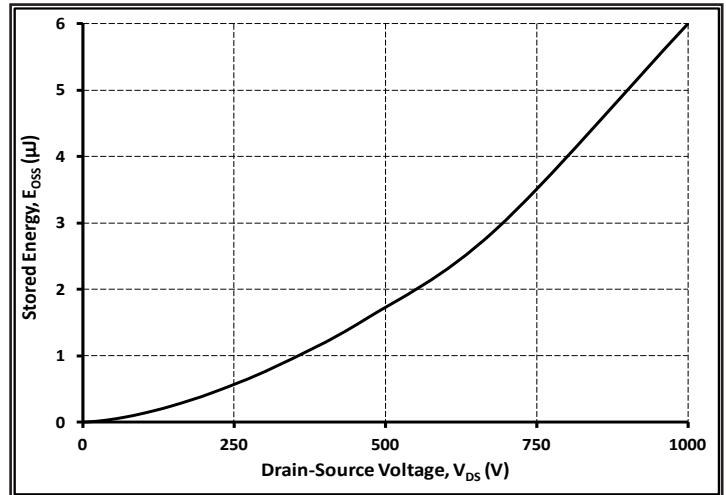

Figure 10. Typical transfer Characteristics

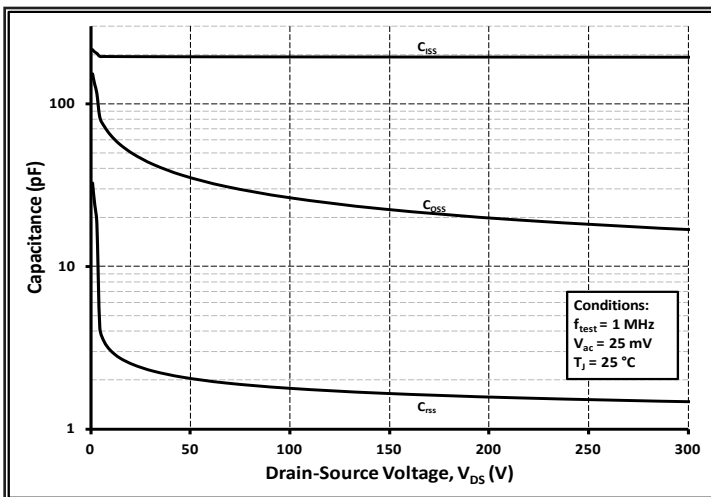

Figure 11. Typical Capacitances vs Drain Voltage (0-300 V)

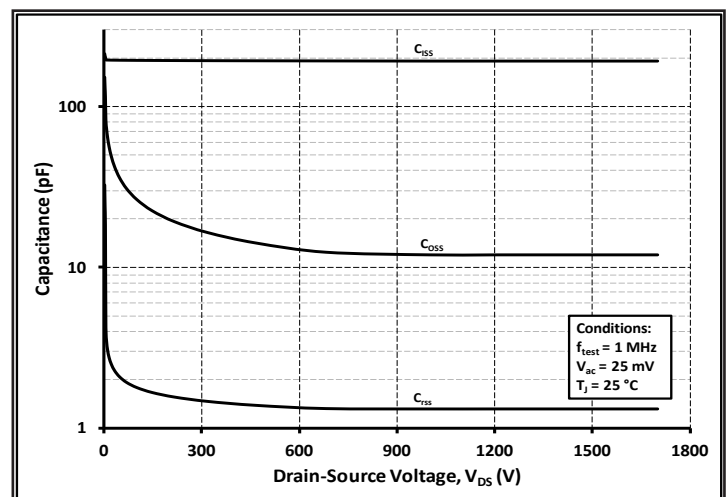

Figure 12. Typical Capacitances vs Drain Voltage (0-1200 V)

## Typical Performance

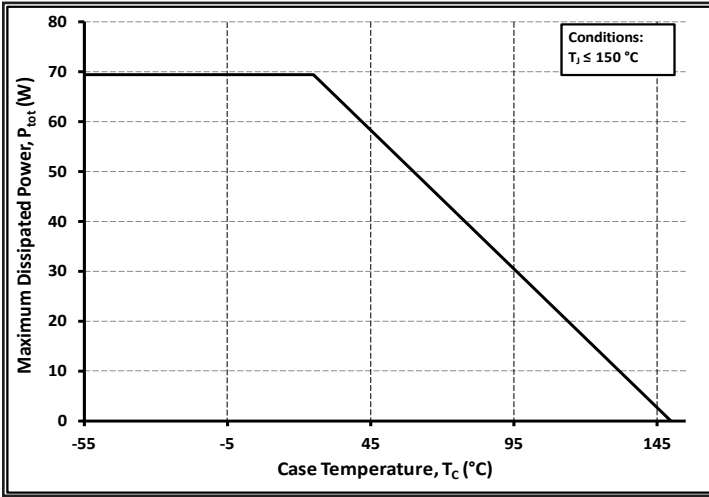

Figure 13. Power Dissipation Derating Curve

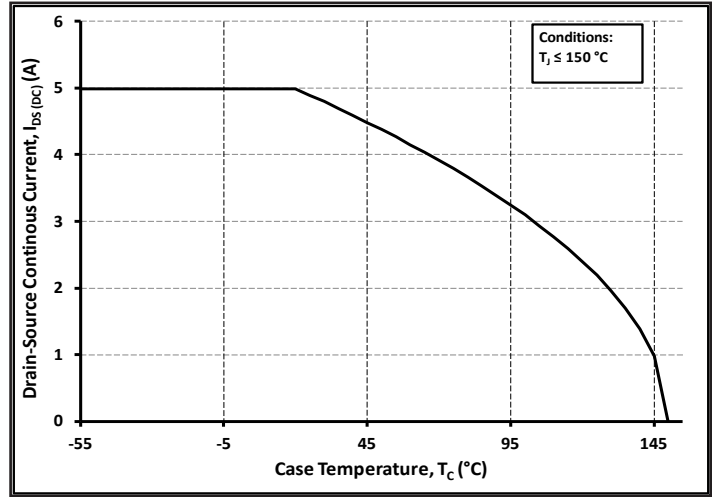

Figure 14. Continuous  $I_{DS}$  Current derating curve

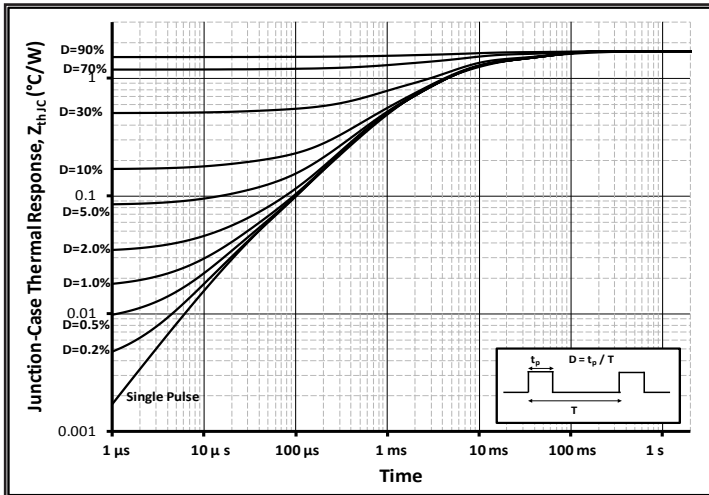

Figure 15. Typical Transient Thermal Impedance (Junction - Case) with Duty Cycle

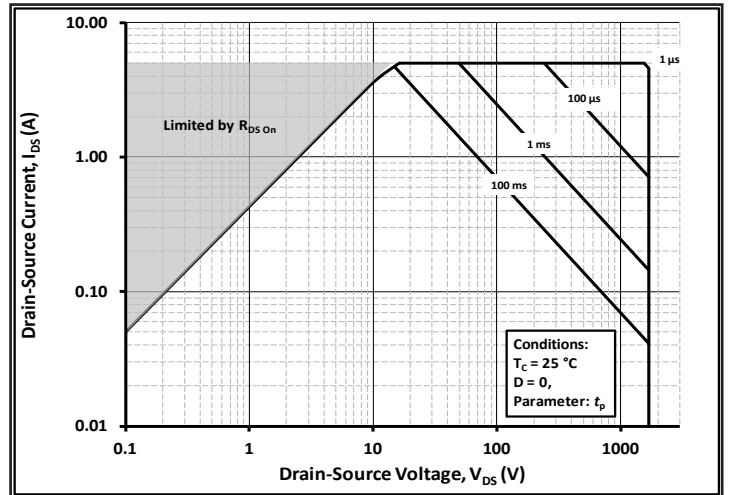

Figure 16. Safe Operating Area,  $T_j = 25\text{ °C}$

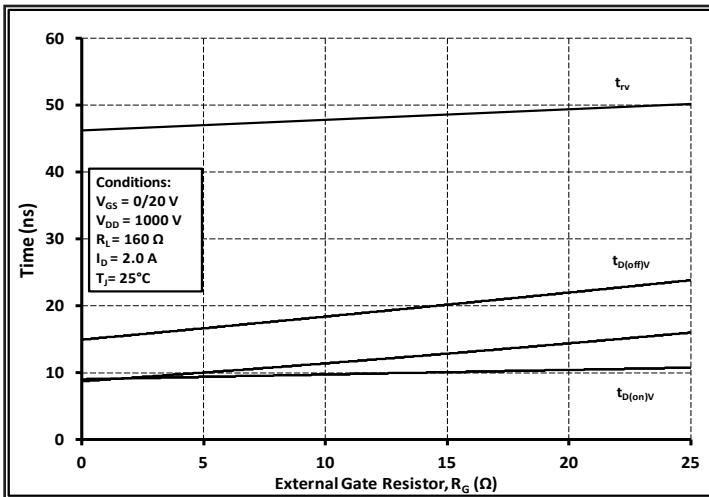

Figure 17. Resistive Switching Times vs.  $R_G$

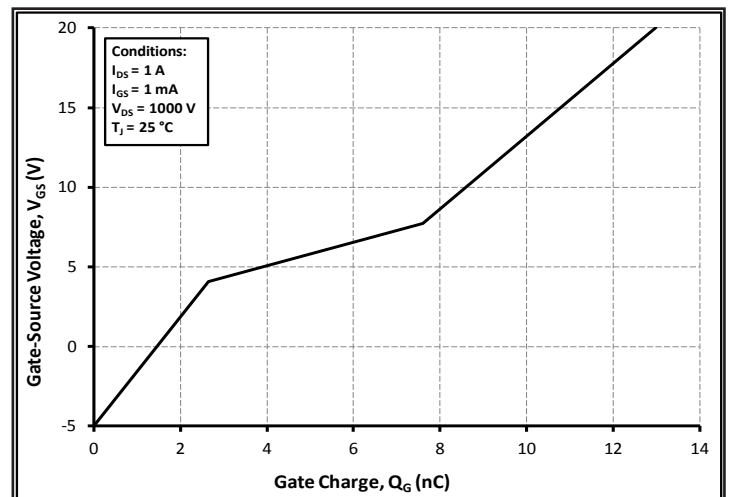

Figure 18. Typical Gate Charge

## Typical Performance

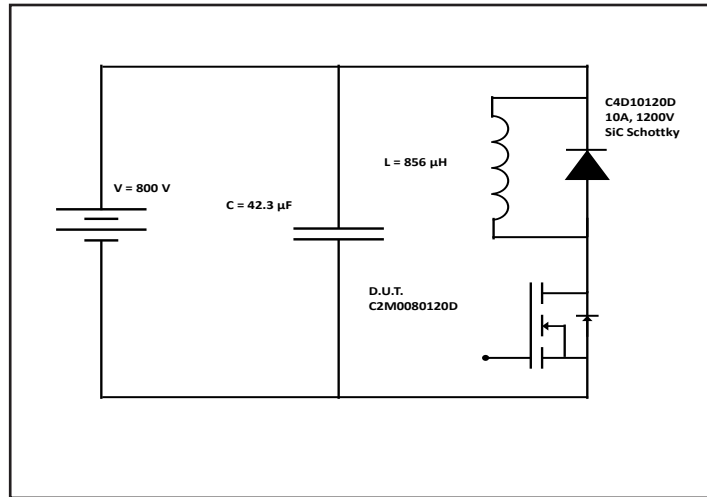

Figure 24. Clamped Inductive Switching Waveform Test Circuit

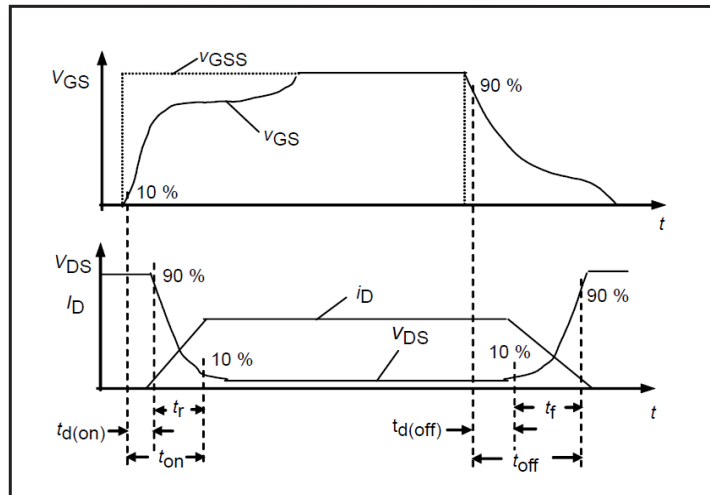

Figure 25. Switching Test Waveforms for Transition Times

## ESD Ratings

ESD Test	Total Devices Sampled	Resulting Classification
ESD-HBM	All Devices Passed 1000V	2 (>2000V)
ESD-MM	All Devices Passed 400V	C (>400V)
ESD-CDM	All Devices Passed 1000V	IV (>1000V)

## Package Dimensions

Package TO-247-3

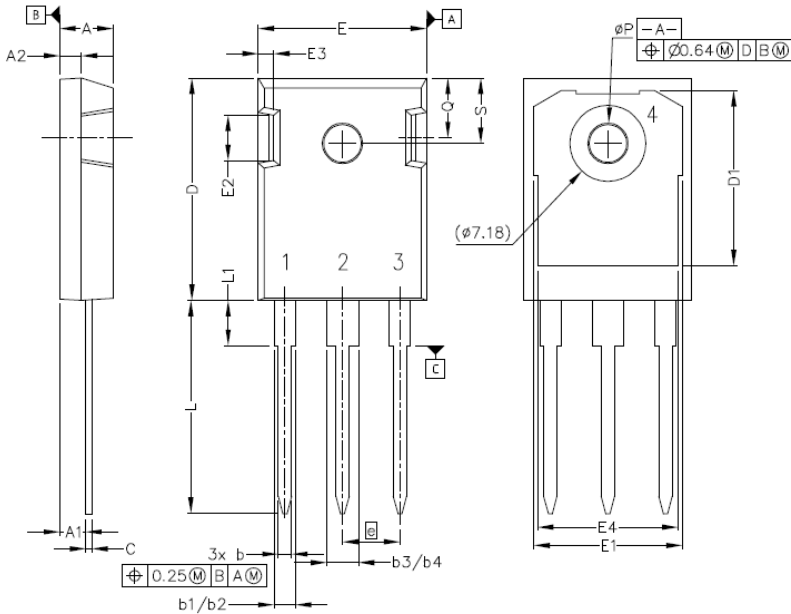

POS	Inches		Millimeters	
	Min	Max	Min	Max
A	.190	.205	4.83	5.21
A1	.090	.100	2.29	2.54
A2	.075	.085	1.91	2.16
b	.042	.052	1.07	1.33
b1	.075	.095	1.91	2.41
b2	.075	.085	1.91	2.16
b3	.113	.133	2.87	3.38
b4	.113	.123	2.87	3.13
c	.022	.027	0.55	0.68
D	.819	.831	20.80	21.10
D1	.640	.695	16.25	17.65
D2	.037	.049	0.95	1.25
E	.620	.635	15.75	16.13
E1	.516	.557	13.10	14.15
E2	.145	.201	3.68	5.10
E3	.039	.075	1.00	1.90
E4	.487	.529	12.38	13.43
e	.214 BSC		5.44 BSC	
N	3		3	
L	.780	.800	19.81	20.32
L1	.161	.173	4.10	4.40
ØP	.138	.144	3.51	3.65
Q	.216	.236	5.49	6.00
S	.238	.248	6.04	6.30

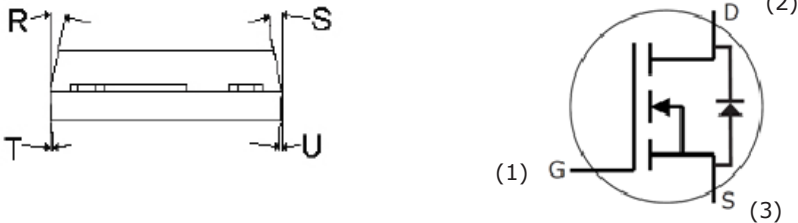

## Recommended Solder Pad Layout

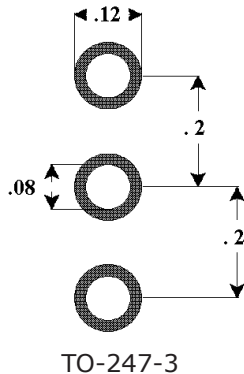

Part Number	Package	Marking
C2M1000170D	TO-247-3	C2M1000170D

This product has not been designed or tested for use in, and is not intended for use in, applications implanted into the human body nor in applications in which failure of the product could lead to death, personal injury or property damage, including but not limited to equipment used in the operation of nuclear facilities, life-support machines, cardiac defibrillators or similar emergency medical equipment, aircraft navigation or communication or control systems, air traffic control systems, or weapons systems.

Copyright © 2013 Cree, Inc. All rights reserved. The information in this document is subject to change without notice. Cree and the Cree logo are registered trademarks and Z-REC and Z-FET are trademarks of Cree, Inc.

Cree, Inc.  
4600 Silicon Drive  
Durham, NC 27703  
USA Tel: +1.919.313.5300  
Fax: +1.919.313.5451  
www.cree.com/power



## Стандарт Электрон Связь

Мы молодая и активно развивающаяся компания в области поставок электронных компонентов. Мы поставляем электронные компоненты отечественного и импортного производства напрямую от производителей и с крупнейших складов мира.

Благодаря сотрудничеству с мировыми поставщиками мы осуществляем комплексные и плановые поставки широчайшего спектра электронных компонентов.

Собственная эффективная логистика и склад в обеспечивает надежную поставку продукции в точно указанные сроки по всей России.

Мы осуществляем техническую поддержку нашим клиентам и предпродажную проверку качества продукции. На все поставляемые продукты мы предоставляем гарантию .

Осуществляем поставки продукции под контролем ВП МО РФ на предприятия военно-промышленного комплекса России , а также работаем в рамках 275 ФЗ с открытием отдельных счетов в уполномоченном банке. Система менеджмента качества компании соответствует требованиям ГОСТ ISO 9001.

Минимальные сроки поставки, гибкие цены, неограниченный ассортимент и индивидуальный подход к клиентам являются основой для выстраивания долгосрочного и эффективного сотрудничества с предприятиями радиоэлектронной промышленности, предприятиями ВПК и научно-исследовательскими институтами России.

С нами вы становитесь еще успешнее!

### Наши контакты:

**Телефон:** +7 812 627 14 35

**Электронная почта:** [sales@st-electron.ru](mailto:sales@st-electron.ru)

**Адрес:** 198099, Санкт-Петербург,  
Промышленная ул, дом № 19, литера Н,  
помещение 100-Н Офис 331