

FEATURES

Buffer memory board for capturing digital data
Used with high speed ADC evaluation boards
32 kB FIFO Depth at 133 MSPS (upgradeable to 256 kB)
Simplifies evaluation of high speed ADCs
Measures performance with ADC Analyzer™
 Real-time FFT and time domain analysis
 Analyze SNR, SINAD, SFDR, and harmonics
 Import raw text data for analysis
 Virtual ADC eval board support using ADIsimADC™
Simple USB port interface
Compatible with Windows® 98 (2nd Ed), Windows 2000, Windows Me, or Windows XP

EQUIPMENT NEEDED

3.3 V power supply
Analog signal source and anti-aliasing filter
Low jitter clock source
High speed ADC evaluation board and ADC data sheet
PC running Windows 98 (2nd Ed), Windows 2000, Windows Me, or Windows XP
USB 2.0 port recommended (USB 1.1 compatible)
Available ADIsimADC product model files

PRODUCT DESCRIPTION

The high speed ADC FIFO evaluation kit includes the latest version of ADC Analyzer and a memory board to capture blocks of digital data from Analog Devices' high speed analog-to-digital converter (ADC) evaluation boards. This FIFO board can be connected to a PC through a USB port and used with ADC Analyzer to evaluate the performance of high speed ADCs quickly. Users can view an FFT for a specific analog input and encode rate and analyze SNR, SINAD, SFDR, and harmonic information.

The evaluation kit is easy to set up. Additional equipment needed includes an Analog Devices' high speed ADC evaluation board, a power supply, a signal source, and a clock source. Once the kit is connected and powered, the evaluation is enabled instantly on the PC.

Two versions of the FIFO are available. The HSC-ADC-EVALA-DC is used with dual ADCs and converters with demultiplexed digital outputs. The HSC-ADC-EVALA-SC evaluation board is used with single-channel ADCs. See Table 1, to choose the FIFO appropriate for your high speed ADC evaluation board.

Rev. 0

Information furnished by Analog Devices is believed to be accurate and reliable. However, no responsibility is assumed by Analog Devices for its use, nor for any infringements of patents or other rights of third parties that may result from its use. Specifications subject to change without notice. No license is granted by implication or otherwise under any patent or patent rights of Analog Devices. Trademarks and registered trademarks are the property of their respective owners.

FUNCTIONAL BLOCK DIAGRAM

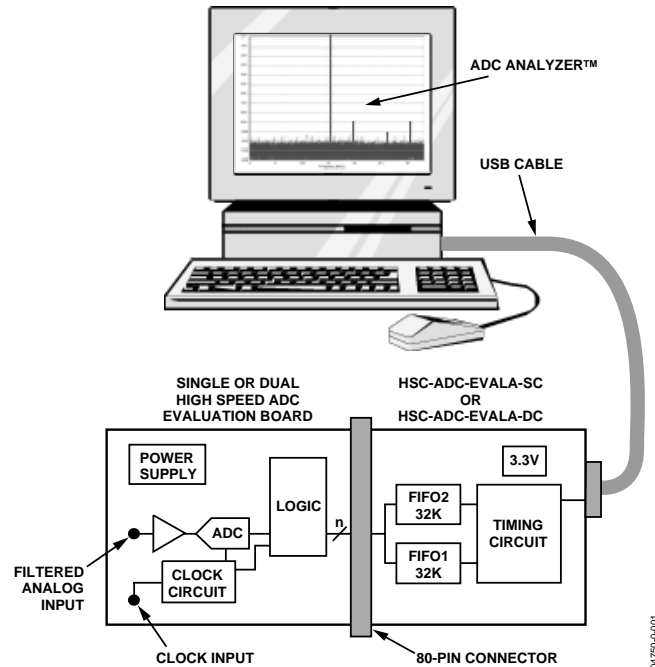

Figure 1. Functional Block Diagram (Simplified)

PRODUCT HIGHLIGHTS

1. **Easy to set up**—Connect the power supplies and signal sources to the two evaluation boards. Then connect to the PC and evaluate the performance instantly.
2. **ADIsimADC** – The software supports virtual ADC evaluation using ADI proprietary behavioral modeling technology. This allows rapid comparison between multiple ADCs, with or without hardware evaluation boards.
3. **USB Port Connection to PC**—PC interface is a USB 2.0 connection (1.1 compatible) to PC. A USB cable is provided in the kit.
4. **32 kB FIFO(s)**—This FIFO(s) stores data from the ADC(s) for processing. A pin compatible FIFO family is used for easy upgrading.
5. **Up to 133 MSPS encode rate on each channel**—Single-channel ADCs with encode rates up to 133 MSPS can be used with the FIFO board. Dual and demultiplexed output ADCs also can be used with the FIFO board (with clock rates up to 133 MSPS on each output channel).

TABLE OF CONTENTS

FIFO Evaluation Board Quick Start.....	4	Average FFT	17
Requirements	4	Continuous Average FFT	17
Quick Start Steps	4	Two Tone	18
Virtual Evaluation Board Quick Start With ADIsimADC.....	5	Continuous Two Tone	18
Requirements	5	Average Two Tone	18
Quick Start Steps	5	Stop.....	18
FIFO 4 Data Capture Board	6	Zooming and Exporting Data	18
FIFO 4 Supported ADC Evaluation Boards.....	6	Importing Data	19
Terminology	8	.csv and ASCII files	19
Single Tone FFT	8	Printing.....	20
Two-Tone FFT	9	Saving Files.....	21
Theory of Operation	10	Additional Functions (Virtual ADC only).....	21
Clocking Description	10	Amplitude Sweep (Virtual ADC only)	21
Clocking with Interleaved Data	10	Analog Frequency Sweep (Virtual ADC only).....	22
Installing ADC Analyzer.....	11	Troubleshooting.....	23
Installation.....	11	Flat Line Signal Displayed.....	23
Configuration File	11	Displayed Signal Unlike Analog Input	23
Configuring an Evaluation Board	11	FFT Noise Floor Higher Than Expected.....	24
Additional Configuration Options	14	Large Spur In FFT (Image Problem)	24
Windowing.....	14	MSBs Missing From Time Domain	25
Power Supply.....	14	Upgrading FIFO Memory	25
Y-Axis.....	14	Jumpers	26
Installing ADC Analyzer With ADIsimADC.....	15	Default Settings.....	26
Installation.....	15	FIFO Schematics and PCB Layout	28
Configuration File	15	FIFO Connector	28
Configuring a Model.....	15	PCB Schematic.....	29
ADC Analyzer Functions	17	Assembly—Primary Side.....	35
Time Domain	17	Assembly—Secondary Side.....	36
Continuous Time Domain	17	Layer 1— Primary Side.....	37
FFT	17	Layer 2—Ground Plane	38
Continuous FFT	17	Layer 3—Power Plane	39

HSC-ADC-EVALA-SC/HSC-ADC-EVALA-DC

Layer 4—Secondary Side.....	40	Windowing Functions.....	43
ESD Caution	40	FFT Calculations.....	43
Bill of Materials.....	41	Ordering Guide	44
Appendix: Sampling and FFT Fundamentals.....	43		
Coherent Sampling	43		

REVISION HISTORY

5/04—Revision 0: Initial Version

FIFO EVALUATION BOARD QUICK START

Install ADC Analyzer from the CD provided in the FIFO evaluation kit. See the Installing ADC Analyzer section for more details. For the latest updates to the software, check the Analog Devices website at www.analog.com/hsc-FIFO.

REQUIREMENTS

Requirements include

- FIFO evaluation board, ADC Analyzer, and USB cable
- High speed ADC evaluation board and ADC data sheet
- 3.3 V power supply for FIFO evaluation board
- Power supply for ADC evaluation board
- Analog signal source and appropriate filtering
- Low jitter clock source applicable for specific ADC evaluation, typically < 1 ps rms
- PC running Windows 98 (2nd Ed), Windows 2000, Windows Me, or Windows XP
- PC with a USB 2.0 port recommended (USB 1.1 compatible)

Quick Start Steps

1. Connect the FIFO evaluation board to the ADC evaluation board. If an adapter is required, insert the adapter between the ADC evaluation board and the FIFO board. If using the HSC-ADC-EVALA-SC model, connect the evaluation board to the bottom half of the 80-pin connector (closest to the installed IDT FIFO chip).
2. Connect the provided USB cable to the FIFO evaluation board and to an available USB port on the computer.
3. Refer to Table 4 for any jumper changes. Most evaluation boards can be used with the default settings.
4. After verification, connect the appropriate power supplies to the FIFO and ADC evaluation boards. The FIFO evaluation board requires a single 3.3 V power supply with 1 A current capability. Refer to the instructions included in the ADC data sheet for more information about the ADC evaluation board setup.
5. Once the cable is connected to both the computer and FIFO and power is supplied, the USB drivers start to install. To complete the total installation of the FIFO drivers, you need to complete the new hardware sequence two times. The first Found New Hardware Wizard opens with the text message **This wizard helps you install software for...Pre-FIFO 4**. Click the recommended install, and go to the next screen. A Hardware Installation warning window should then be displayed. Click **Continue Anyway**. The next window that opens should finish the Pre-FIFO 4 installation. Click **Finish** to complete. Your computer should go through a second Found New Hardware Wizard, and the text message, **This wizard helps you install software for...Analog Devices FIFO 4**, should be displayed. Continue as you did in the previous installation and click **Continue Anyway**, then click **Finish** on the next two windows. This should complete the installation.
6. (Optional) Verify in the device manager that "Analog Devices, FIFO4" is listed under the USB hardware.
7. Apply power to the evaluation board and check the voltage levels at the board level.
8. Connect the appropriate analog input (which should be filtered with a band-pass filter) and low jitter clock signal. Make sure the evaluation boards are powered before connecting the analog input and clock.
9. Start ADC Analyzer (see the Installation section for installing the software).
10. Choose a configuration file for the ADC evaluation board used or create one (see the Configuring an Evaluation Board section for more information).
11. Click **Time Domain** (left-most button under the pull-down menus). A reconstruction of the analog input is displayed. If the expected signal does not appear, or if there is only a flat red line, refer to the Troubleshooting section for more information.

VIRTUAL EVALUATION BOARD QUICK START WITH ADIsimADC

REQUIREMENTS

Requirements include

- Completed installation of ADC Analyzer version 4.5.0 or later.
- ADIsimADC product model files for the desired converter. Models are not installed with the software, but may be downloaded from the website at no charge. Go to www.analog.com/ADIsimADC or look under **Design Tools** for the product of interest.
- No hardware is required. However, if you wish to compare results of a real evaluation board and the model, you may switch easily between the two, as outlined below.

Quick Start Steps

1. To obtain ADC model files, go to www.analog.com/ADIsimADC or look under **Design Tools** for the product of interest. Download the files of interest to a local drive. The default location is c:\program files\adc_analyzer\models.
2. Start ADC Analyzer (see the Installation section for installing the software).
3. From the menu choose Config > Buffer and select **Model** from the drop down menu as the buffer memory. In effect, the model functions in place of the ADC and data capture hardware.
4. After selecting the Model, a small button, **Model**, is displayed next to the **Stop** button. Click **Model** to select and configure which converter will be modeled. This places a small form in the workspace where you can select and configure how the model will behave.
5. On the ADC Modeling form, select the **Device** tab and click the ... button, adjacent to the dialog box. This opens a file browser and displays all of the models found in the default directory: c:\program files\adc_analyzer\models. If no model files are found, follow the on-screen directions or see Step 1 to install available models. If you have saved the models somewhere other than the default location, use the browser to navigate to that location and select the file of interest.
6. From the menu choose Config > FFT. In the FFT Configuration form, ensure that the **Encode Frequency** is set for a valid rate for the simulated device under test. If set too low or too high, the model will not run.
7. Once a model has been selected, information about the model displays on the **Device** tab. After ensuring that you have selected the right model, select the **Input** tab. This lets you configure the input to the model. From the drop down menu, select either **Sine Wave** or **Two Tone** for the input signal.
8. Click **Time Domain** (left-most button under the pull-down menus). A reconstruction of the analog input is displayed. The model may now be used just as a standard evaluation board would be.
9. The model supports additional features not found when testing a standard evaluation board. When using the modeling capabilities, it is possible to sweep either the analog amplitude or the analog frequency. See the Installing ADC Analyzer With ADISIMADC section for additional features.

HSC-ADC-EVALA-SC/HSC-ADC-EVALA-DC

FIFO 4 DATA CAPTURE BOARD

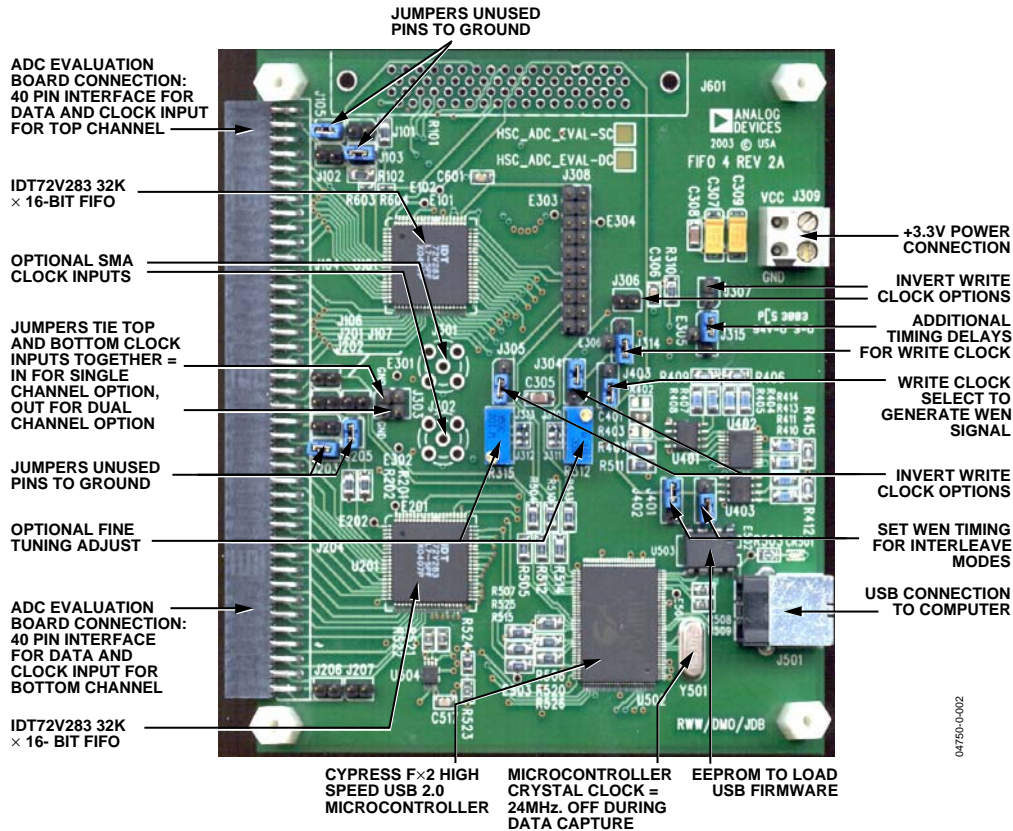

Figure 2. FIFO Components Description

FIFO 4 SUPPORTED ADC EVALUATION BOARDS

The evaluation boards in Table 1 can be used with the high speed ADC FIFO Evaluation Kit¹. Some evaluation boards require an adapter between the ADC evaluation board connector and the FIFO connector. If an adapter is needed, send an email to highspeed.converters@analog.com with the part number of the adapter and a mailing address.

Table 1 HSC-ADC-EVALA-DC: and HSC-ADC-EVALA-SC Compatible Evaluation Boards²

Evaluation Board Model	Description of ADC	FIFO Board Version	Comments
AD6640ST/PCB	12-Bit, 65 MSPS ADC	SC	Requires AD664xFFA ³
AD6644ST/PCB	14-Bit, 65 MSPS ADC	SC	Rev. C Requires AD664xFFA
AD6645/PCB	14-Bit, 80 MSPS ADC	SC	Rev. C Requires AD664xFFA
AD9051/PCB	10-Bit, 60 MSPS ADC	SC	Requires AD9051FFA
AD9057/PCB	8-Bit, 80 MSPS ADC	SC	Requires AD9283FFA
AD9059/PCB	Dual 8-Bit, 60 MSPS ADC	DC	Requires AD9059FFA
AD9071/PCB	10-Bit, 100 MSPS ADC	SC	Requires AD9071FFA
AD9200SSOP-EVAL	10-Bit, 20 MSPS ADC	SC	Requires AD922xFFA
AD9200TQFP-EVAL	10-Bit, 20 MSPS ADC	SC	Requires AD922xFFA
AD9201-EVAL	Dual 10-Bit, 20 MSPS ADC ⁴	SC	Requires AD922xFFA
AD9203-EB	10-Bit, 40 MSPS ADC	SC	Requires AD922xFFA
AD9214-65PCB	10-Bit, 65 MSPS ADC	SC	
AD9214-105PCB	10-Bit, 105 MSPS ADC	SC	
AD9215BCP-65EB	10-Bit, 65 MSPS ADC	SC	
AD9215BCP-80EB	10-Bit, 80 MSPS ADC	SC	
AD9215BCP-105EB	10-Bit, 105 MSPS ADC	SC	
AD9215BRU-65EB	10-Bit, 65 MSPS ADC	SC	
AD9215BRU-80EB	10-Bit, 80 MSPS ADC	SC	
AD9215BRU-105EB	10-Bit, 105 MSPS ADC	SC	

HSC-ADC-EVALA-SC/HSC-ADC-EVALA-DC

Evaluation Board Model	Description of ADC	FIFO Board Version	Comments
AD9218-65PCB	Dual 10-Bit, 65 MSPS ADC	DC	
AD9218-105PCB	Dual 10-Bit, 105 MSPS ADC	DC	
AD9220-EB	12-Bit, 10 MSPS ADC	SC	Requires AD922xFFA
AD9221-EB	12-Bit, 1.25 MSPS ADC	SC	Requires AD922xFFA
AD9223-EB	12-Bit, 3 MSPS ADC	SC	Requires AD922xFFA
AD9224-EB	12-Bit, 40 MSPS ADC	SC	Requires AD922xFFA
AD9225-EB	12-Bit, 25 MSPS ADC	SC	Requires AD922xFFA
AD9226-EB	12-Bit, 65 MSPS ADC	SC	Requires AD922xFFA
AD9226QFP-EB	12-Bit, 65 MSPS ADC	SC	Requires AD922xFFA
AD9235BRU-20EB	12-Bit, 20 MSPS ADC	SC	
AD9235BRU-40EB	12-Bit, 40 MSPS ADC	SC	
AD9235BRU-65EB	12-Bit, 65 MSPS ADC	SC	
AD9235BCP-20EB	12-Bit, 20 MSPS ADC	SC	
AD9235BCP-40EB	12-Bit, 40 MSPS ADC	SC	
AD9235BCP-65EB	12-Bit, 65 MSPS ADC	SC	
AD9235-20PCB	12-Bit, 20 MSPS ADC	SC	
AD9235-40PCB	12-Bit, 40 MSPS ADC	SC	
AD9235-65PCB	12-Bit, 65 MSPS ADC	SC	
AD9236BCP-80EB	12-Bit, 80 MSPS ADC	SC	
AD9236BRU-80EB	12-Bit, 80 MSPS ADC	SC	
AD9236BCP-80EB	12-Bit, 80 MSPS ADC	SC	
AD9238-20PCB	Dual 12-Bit, 20 MSPS ADC	DC	
AD9238-40PCB	Dual 12-Bit, 40 MSPS ADC	DC	
AD9238-65PCB	Dual 12-Bit, 65 MSPS ADC	DC	
AD9240-EB	14-Bit, 40 MSPS ADC	SC	Requires AD922xFFA
AD9241-EB	14-Bit, 1.25 MSPS ADC	SC	Requires AD922xFFA
AD9243-EB	14-Bit, 3 MSPS ADC	SC	Requires AD922xFFA
AD9244-40PCB	14-Bit, 40 MSPS ADC	SC	
AD9244-65PCB	14-Bit, 65 MSPS ADC	SC	
AD9245BCP-80EB	14-Bit, 80 MSPS ADC	SC	
AD9260-EB	16-Bit, 2.5 MSPS ADC	SC	Requires AD922xFFA
AD9280-EB	8-Bit, 32 MSPS ADC	SC	Requires AD922xFFA
AD9281-EB	Dual 8-Bit, 28 MSPS ADC	SC	Requires AD922xFFA
AD9283/PCB	8-Bit, 100 MSPS ADC	SC	Requires AD9283FFA
AD9289BBC-65EB	Quad 8-Bit, 65 MSPS ADC ⁵	DC	
AD9410/PCB	10-Bit, 210 MSPS ADC	DC	
AD9430-CMOS/PCB	12-Bit, 210 MSPS ADC	DC	
AD9432/PCB	12-Bit, 105 MSPS ADC	SC	Rev. 0 Requires AD9432FFA
AD9433/PCB	12-Bit, 125 MSPS ADC	SC	
AD9480BSU-250EB	8-Bit, 250 MSPS ADC	DC	
AD10200/PCB	Dual 12-Bit, 105 MSPS ADC	DC	Requires LG-0204A
AD10201/PCB	Dual 12-Bit, 105 MSPS ADC	DC	Requires LG-0204A
AD10226/PCB	Dual 12-Bit, 125 MSPS ADC	DC	Requires LG-0204A
AD10235/PCB	Dual 12-Bit, 215 MSPS ADC	DC	Requires LG-0204A
AD10265/PCB	Dual 12-Bit, 65 MSPS ADC	DC	Requires LG-0204A
AD10401/PCB	Dual 14-Bit, 105 MSPS ADC	DC	Requires LG-0204A
AD10465/PCB	Dual 14-Bit, 65 MSPS ADC	DC	Requires LG-0204A

¹ Send an email to highspeed.converters@analog.com for information on evaluating the AD9288 with the High Speed ADC FIFO Evaluation Kit.

² Connector pin numbers and/or labeling on some evaluation boards (AD9214, AD9410, AD9430, AD9433, AD9235, and AD9244) may not match the FIFO connector numbering; however, the physical connections are correct.

³ The AD6640 evaluation board has a 40-pin output connector that should be left (MSB) justified when connected to the 50-pin AD664x FIFO adapter.

⁴ The AD9281 and AD9201 have a single output bus

⁵ The High Speed ADC FIFO Evaluation Kit can be used to evaluate two channels of the AD9289 at a time.

TERMINOLOGY

SINGLE TONE FFT

Signal-to-Noise Ratio (SNR)

The ratio of the rms signal amplitude to the rms value of the sum of all other spectral components, excluding the first five harmonics and dc. It is reported in dBc.

Signal-to-Noise Ratio Full Scale (SNRFS)

The ratio of the rms signal amplitude related to full scale (0 dB) to the rms value of the sum of all other spectral components, excluding the first five harmonics and dc. It is reported in dBFS.

User Defined Signal-to-Noise Ratio (UDSNR)

The ratio of the rms signal amplitude to the rms value of the sum of all other spectral components within a specified band set by the user, excluding harmonics and dc. It is reported in dB.

Noise Figure (NF)

The noise figure is the ratio of the noise power at the output of a device to the noise power at the input to the device, where the input noise temperature is equal to the reference temperature (273 K). The noise figure is expressed in dB.¹

Signal-to-Noise-and-Distortion (SINAD)

The ratio of the rms signal amplitude to the rms value of the sum of all other spectral components, including harmonics but excluding dc. It is reported in dB.

Harmonic Distortion, Image

The ratio of the rms signal amplitude to the rms value of the nonharmonic component generated from the clocking phase difference of two ADCs, reported in dBc. Note: This measurement result is valid only when analyzing demultiplexed ADCs.

Harmonic Distortion, Second (2nd)–Sixth (6th)

The ratio of the rms signal amplitude to the rms value of the fundamental related harmonic component, reported in dBc.

Worst Other Spur (WoSpur)

The ratio of the rms signal amplitude to the rms value of the worst spurious component (excluding all harmonically related components) reported in dBc.

Total Harmonic Distortion (THD)

The rms value of the sum of all spectral harmonics specified by the user. It is reported in dBc.

Spurious-Free Dynamic Range (SFDR)

The ratio of the rms signal amplitude to the rms value of the peak spurious spectral component. The peak spurious component may or may not be a harmonic. It is reported in dBc.

Noise Floor

The rms value of the sum of all other spectral components, excluding the fundamental, its harmonics, and dc referenced to full-scale and reported in dBFS.

¹For Noise Figure for an ADC, the equation is

$$\text{Noise Figure} = 10 \times \log\left(\frac{V_{\text{rms}}^2/Z_{\text{in}}}{0.001}\right) - \text{SNRFS} - 10 \times \log\left(\frac{\text{Encode Frequency}}{2}\right) - 10 \times \log\left(\frac{k \times T \times B}{0.001}\right)$$

k= Boltzman's Constant = 1.38×10^{-23}
 T = Temperature in Kelvin = 273 K
 B = Bandwidth = 1 Hz
 Encode Frequency = ADC Clock Rate
 V_{rms} = RMS Fullscale Input Voltage
 Z_{in} = Input Impedance
 SNRFS = FullScale ADC SNR

TWO-TONE FFT

Two-Tone, Second Order Intermodulation Distortion Products (F1 + F2)

The resulting rms second order distortion value reported by the mixing of two analog input signals. The peak spurious component is considered an IMD product. It is reported in dBc.

Two-Tone, Second Order Intermodulation Distortion Products (F2–F1)

The resulting rms second order distortion value reported by the mixing of two analog input signals. The peak spurious component is considered an IMD product. It is reported in dBc.

Two-Tone, Third Order Intermodulation Distortion Products (2F1 ± F2)

The resulting rms third order distortion value reported by the mixing of two analog input signals. The peak spurious component is considered an IMD product. It is reported in dBc.

Two-Tone, Third Order Intermodulation Distortion Products (2F2 ± F1)

The resulting rms third order distortion value reported by the mixing of two analog input signals. The peak spurious component is considered an IMD product. It is reported in dBc.

Two-Tone, Worst Other Spur (WoSpur)

The resulting rms distortion value, reported by the mixing of two analog input signals that is not related to the second or third order distortion products. The peak spurious component is not considered an IMD product. It is reported in dBc.

Two-Tone, Second Order Input Intercept Point (IIP2)

The measure of full-scale input signal power of the converter minus half the IMD second order products. It is reported in dBm.

Two-Tone, Third Order Input Intercept Point (IIP3)

The measure of full-scale input signal power of the converter minus half the IMD third order products. It is reported in dBm.

Two-Tone, SFDR

The ratio of the rms value of either input tone to the rms value of the peak spurious component. The peak spurious component is not an IMD product. It is reported in dBc.

THEORY OF OPERATION

The FIFO evaluation board can be divided into several circuits, each of which plays an important part in acquiring digital data from the ADC and allows the PC to upload and process that data. The evaluation kit is based around the IDT72V283 FIFO chip from IDT. The system can acquire digital data at speeds up to 133 MSPS and data record lengths up to 32 kB using the HSC-ADC-EVALA-SC FIFO evaluation kit. The HSC-ADC-EVALA-DC, which has two FIFO chips, is available to evaluate dual ADCs or demultiplexed data from ADCs sampling faster than 133 MSPS. A USB 2.0 microcontroller communicating with ADC Analyzer allows for easy interfacing to newer computers using the USB 2.0 (USB 1.1 compatible) interface.

The process of filling the FIFO chip(s) and reading the data back requires several steps. First, ADC Analyzer initiates the FIFO chip(s) fill process. The FIFO chip(s) are reset using a master reset signal (MRS). The USB Microcontroller then is suspended, which turns off the USB oscillator, ensuring that it does not add noise to the ADC input. After the FIFO chip(s) completely fill, the full flags from the FIFO chip(s) send a signal to the USB microcontroller to wake up the microcontroller from suspend. ADC Analyzer waits for approximately 30 ms and begins the readback process.

During the readback process, the acquisition of data from FIFO 1 (U201) or FIFO 2 (U101) is controlled via the signals OEA and OEB. Because the data outputs of both FIFO chips drive the same 16-bit data bus, the USB microcontroller controls the OEA and OEB signals to read data from the correct FIFO chip. From an application standpoint, ADC Analyzer sends commands to the USB microcontroller to initiate a read from the correct FIFO chip, or both FIFO chips in dual or interleaved mode.

CLOCKING DESCRIPTION

Each channel of the buffer memory requires a clock signal to capture data. These clock signals are normally provided by the ADC evaluation board and are passed along with the data through Connector J104/204 (Pin 37 for both Channel 1 and Channel 2). If only a single clock is passed for both channels, they can be connected together by Jumper J303.

Jumpers J304 and J305 at the output of the LVDS receiver allow the output clock to be inverted by the LVDS receiver. By default, the clock outputs are inverted by the LVDS receiver.

The single-ended clock signal from each data channel is buffered and converted to a differential CMOS signal by two gates of a low voltage differential signal (LVDS) receiver, U301. This allows the clock source for each channel to be CMOS, TTL, or ECL. The clock signals are ac-coupled by 0.1 μ F capacitors. Potentiometers R312 and R315 allow for fine tuning the threshold of the LVDS gates. In applications where fine-tuning

the threshold is critical, these potentiometers may be replaced with a higher resistance value to increase the adjustment range. Resistors R303, R304, R307, R308, R311, R313, R314, and R316 set the static input to each of the differential gates to a dc voltage of approximately 1.5 V.

At assembly, solder Jumpers J310–J313 are set to bypass the potentiometer. For fine adjustment using the pot, the solder jumpers must be removed.

U302, an XOR gate array, is included in the design to let users add gate delays to the FIFO memory chips clock paths. They are not required under normal conditions and are bypassed at assembly by Jumpers J314 and J315. Jumpers J306 and J307 allow the clock signals to be inverted through an XOR gate. In the default setting, the clocks are not inverted by the XOR gate.

The clock paths described above determine the WRT_CLK1 and WRT_CLK2 signals at each FIFO memory chip (U101 and U201, Pin 80). The timing options above should let you choose a clock signal that meets the setup and hold time requirements to capture valid data.

A clock generator can be applied directly to S1 and/or S3. This clock generator should be the same unit that provides the clock for the ADC. These clock paths are ac-coupled, so that a sine wave generator can be used. DC bias can be adjusted by R301/R302 and R305/R306. Note that J301 and J302 (SMA connectors) and R301, R302, R305, and R306 are not installed at the factory and must be installed by the user.

The DS90LV048A differential line receiver is used to square the clock signal levels applied externally to the FIFO evaluation board. The output of this clock receiver can either directly drive the write clock of the IDT72V283 FIFO(s), or first pass through the XOR gate timing circuitry described above.

CLOCKING WITH INTERLEAVED DATA

ADCs with very high data rates may exceed the capability of a single buffer memory channel (~133 MSPS). These converters often demultiplex the data into two channels to reduce the rate required to capture the data. In these applications, ADC Analyzer must interleave the data from both channels to process it as a single channel. The user can configure the software to process the first sample from Channel 1, the second from Channel 2, and so on, or vice versa, (see the Troubleshooting section for more information). The synchronization circuit included in the buffer memory forces a small delay between the write enable signals (WENA and WENB) to the FIFO memory chips (Pin 1, U101 and U201), ensuring that the data is captured in one FIFO before the other. Jumpers J401 and J402 determine which FIFO receives WENA and which FIFO receives WENB

INSTALLING ADC ANALYZER

ADC Analyzer is designed to evaluate the performance of an Analog Devices analog-to-digital converter quickly and easily.

INSTALLATION

A copy of ADC Analyzer is included on the CD that comes with the FIFO Evaluation Kit. Check the Analog Devices website for updates to the software at www.analog.com/hsc-FIFO.

1. Copy the AnalyzerSetup.exe file to the hard drive.
2. Run the setup file and follow the instructions given in the installation wizard. Note that administrator privileges are required to install the software on Windows 2000/Windows Me/Windows XP machines.
3. Once the software is installed, run the executable file (the default location is in c:\program files\ADC_Analyzer\ADC_Analyzer.exe).

CONFIGURATION FILE

A configuration file can be created for each high speed ADC evaluation board used with ADC Analyzer. A configuration file provides the software with important information about the data sent from the ADC evaluation board to the FIFO evaluation board, such as the number of bits, speed of the clock, and format of the data bits (binary or twos complement). Configuration files for some of the evaluation boards are included with the ADC Analyzer files. Each time ADC Analyzer is launched, a window opens where a configuration file can be specified. Click **Yes** to specify a configuration file and choose the file corresponding to the ADC being used.

The default configuration files can be modified or a new configuration file can be created using the instructions in the Configuring An Evaluation Board section.

CONFIGURING AN EVALUATION BOARD

Follow Steps 1 through 5 to configure the software with the ADC evaluation board:

1. From the pull-down menus in the upper left hand corner, choose Config > DUT. The screen, DUT Configuration opens. Enter the name of the ADC being evaluated in the **Device** dialog box and the number of bits (resolution of the ADC) in the **Number of Bits** dialog box. (Note: This information is used for display purposes only.) To specify a directory different than the default to store the configuration file, enter a new location in the **Default Data Directory** dialog box, and click **OK**.

Step 1

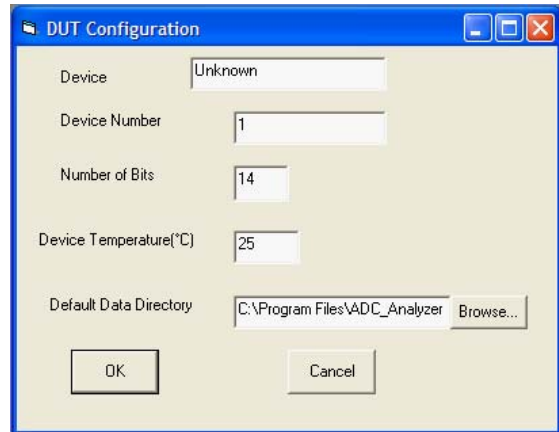

2. Choose Config > FFT from the pull-down menus or right-click any of the analysis buttons to open the FFT Configuration screen. Use this menu to configure the Fast Fourier Transform plot. If needed, modify the options under Channel A to select the appropriate channel.

Step 2

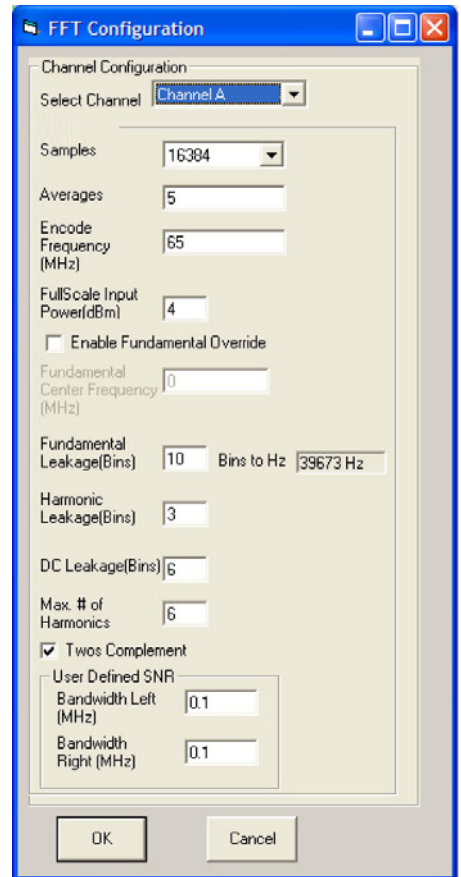

Note that Channel A in the software corresponds to Channel 1 on the FIFO schematics and the bottom FIFO on the evaluation

HSC-ADC-EVALA-SC/HSC-ADC-EVALA-DC

board. Channel B corresponds to Channel 2 on the FIFO schematics and the top FIFO on the evaluation board (closest to the Analog Devices logo). See the Jumpers section for more information.

Configuring FFT— Defining Available Options

Samples: Choose the number of samples taken to calculate an FFT. The default is 16 kB samples. Users can choose more or fewer samples, depending on the application. The maximum number of samples that can be selected in the software is 64 kB. However, the FIFO evaluation boards are configured with 32 kB FIFOs. For single ADCs evaluated with the HSC-ADC-EVALA-SC model, the maximum number of samples selected should match the FIFO memory on the evaluation board. For dual ADCs evaluated with the HSC-ADC-EVALA-DC model, the maximum number of samples should match the FIFO memory of each channel (a different number of samples can be selected for each channel). ADCs with demultiplexed outputs (such as the AD9430) can be used with a sample value of twice the FIFO memory. See the Upgrading FIFO Memory section.

Averages: Specify the number of averages taken for the average FFT functions. See the ADC Analyzer Functions section for more information.

Encode Frequency (MHz): Enter the speed of the sampling clock to the ADC. If evaluating a dual ADC, two different clock rates can be entered. Note: If the value is wrong, the analog fundamental frequency displayed will be wrong.

FullScale Input Power (dBm): This feature lets the user enter the amount of power (in dBm) needed on the input to determine the output fullscale. It applies only in noise figure and IIP2/IIP3 calculations.

Enable Fundamental Override: ADC Analyzer automatically defaults the highest spur as the fundamental frequency of interest. However, in some applications, the user may have a very small analog input signal that could be equal to or below another spurious harmonic. This option lets the user specify the small analog input signal needed for evaluation. If **Enable Fundamental Override** is checked, the **Fundamental Frequency (MHz)** box is enabled for the user to specify.

Fundamental Leakage: The number of bins that are neglected on either side of the fundamental signal when calculating the SNR and SINAD results. For example, if an encode rate is defined at 80 MSPS with 16384 samples, then $80M/21/(16384/21) = 4883 \text{ Hz/Bin}$ is specified. The type of windowing selected determines the default value of the fundamental leakage. See the Windowing section for more information. The default values are 25, 10, and 1 for Hanning, Blackman Harris, and no windowing, respectively.

Harmonic Leakage: The number of bins that are neglected on either side of each harmonic of the fundamental signal defined

in the Max # of Harmonics' box. Typically, this can be left at the default value of 3.

DC Leakage: The number of bins (at dc) that are not used in calculating SNR and SINAD. Typically, this can be left at the default value of 6.

Maximum Number of Harmonics: The number of harmonics displayed by ADC Analyzer. The default value is 6 and the maximum number of harmonics that can be displayed is 12.

Twos Complement: Check this box if the data from the ADC evaluation board is in twos complement format. Refer to the ADC data sheet to determine if the ADC outputs are configured for twos complement or offset binary. If the **Twos Complement** option is not checked, ADC Analyzer will expect the data outputs from the ADC to be in offset binary format.

User Defined SNR Left (MHz): This is the amount of frequency specified to the left of the fundamental by the user to analyze SNR. The resulting value is called UDSNR and will show up after an FFT plot is captured.

User Defined SNR Right (MHz): This is the amount of frequency specified to the right of the fundamental by the user to analyze SNR. The resulting value is called UDSNR and will show up after an FFT plot is captured.

After configuring the options for the Fast Fourier Transform plot in this window, click **OK**.

3. Choose Config > Buffer. HSC-ADC-EVAL(A), opening the Buffer Memory screen.

Step 3

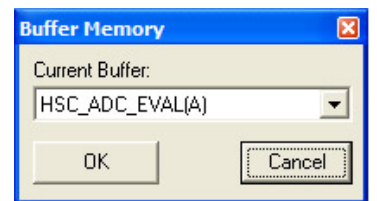

Click **OK**, and the Buffer Configuration window opens. ADC Analyzer automatically seeks a USB connection. If a USB connection is not found, it will assume that you want to use an older version FIFO board which has a parallel connection. If so, choose the appropriate parallel connection made to the computer and click **OK**.

Step 3a

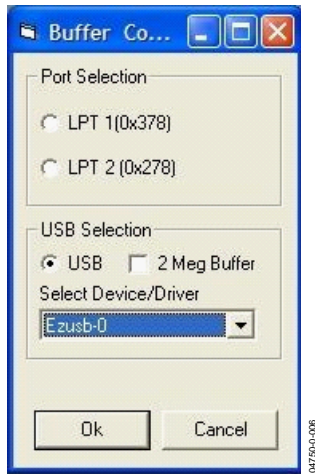

Step 4

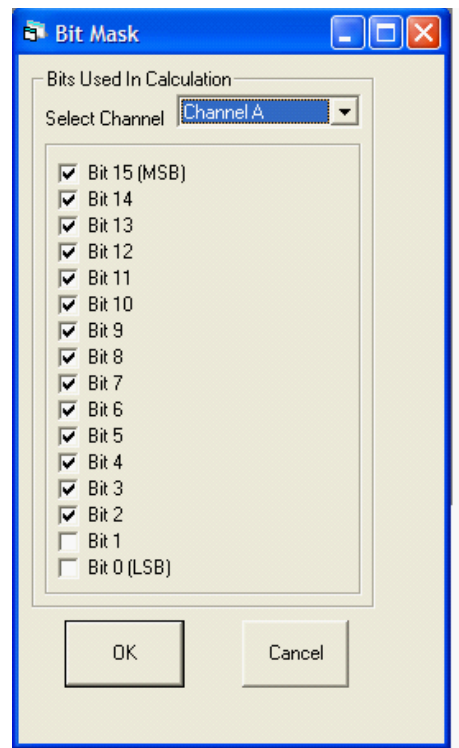

- Choose Config > Bits > Data Bits to open the Bit Mask screen. Configure the number and location of the data bits used to calculate the FFTs.

Make sure that the number of bits matches the resolution of the converter. All of the supported evaluation boards are MSB justified, so check the number of bits for the converter starting with Bit 15 (MSB). Exceptions to this are the AD9280, AD9281, AD9200, and AD9201. For these four ADCs, check the number of bits starting with Bit 13.

If a single ADC is being evaluated, check only Channel A and the appropriate bits under Channel A. If a dual ADC is being evaluated, check Channel A and Channel B on the Channel Select screen. (Config > Channel Select).

If evaluating a demultiplexed ADC, go to Config > Channel Select, opening the Channel Select pop-up menu, and check the **Interleaved Data** box. This automatically selects both Channel A and Channel B. When using a dual ADC, select only the appropriate channel that corresponds to the ADC that is being evaluated. Channel A is the default selected channel at startup.

Step 4a

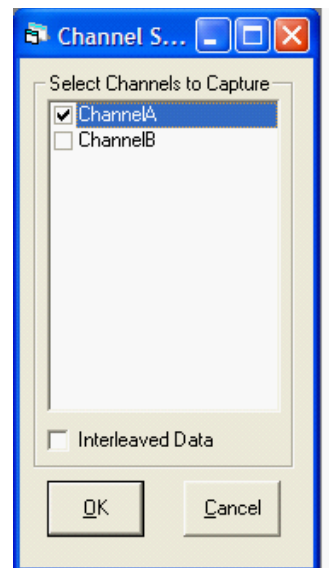

Note that Channel A in the software corresponds to Channel 1 on the FIFO schematics and the bottom FIFO (U201) on the

HSC-ADC-EVALA-SC/HSC-ADC-EVALA-DC

evaluation board. Channel B corresponds to Channel 2 on the FIFO schematics and the top FIFO (U101) on the evaluation board (closest to the Analog Devices logo). See the Jumpers section for more information. Click **OK**. (For more information about the channel selection process, see the Troubleshooting section.)

5. As a last step, choose File > Configuration File > Save Configuration from the pull-down menu to save the configuration for future use. Choose a file name and a location to save the file.

ADDITIONAL CONFIGURATION OPTIONS

Other options under the configuration pull-down menu include Windowing, Power Supply, and Y-Axis.

Windowing

Choose either the **Hanning** or **Blackman Harris** (default) windowing functions or turn windowing off. See the Windowing Functions section for a description of Hanning and Blackman Harris windowing. Click **OK**.

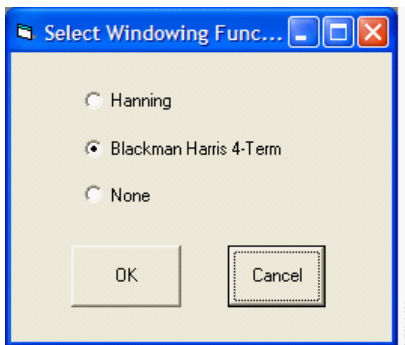

Figure 3. Select Windowing Function

If you choose **None**, the Coherent Sampling Calculator window opens (see Figure 4).

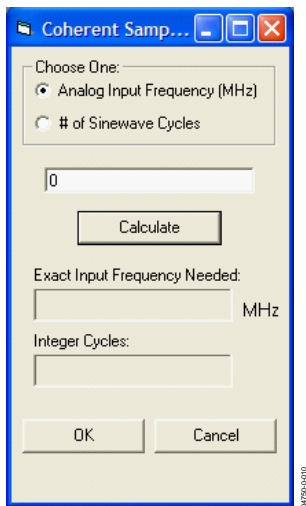

Figure 4. Coherent Sampling Calculator

For the calculator to work properly, the correct sampling frequency must be entered under Config > FFT. Select either the desired approximate **Analog Input Frequency** or the **# of Sine Wave Cycles**. Enter the value in the dialog box (not labeled) and click **Calculate** to view the Coherent Frequency. The Coherent Frequency and Number of Integer Cycles will display in the gray boxes. Click **OK** to exit the Coherent Sampling Calculator.

Power Supply

This option opens under Config > Power Supply, and users can enter the value of the ADC analog and digital voltage supplies (see Figure 5). Note this for user documentation only. No external control is provided. ADC Analyzer displays this information when data is captured. See the ADC Analyzer Functions section for more information.

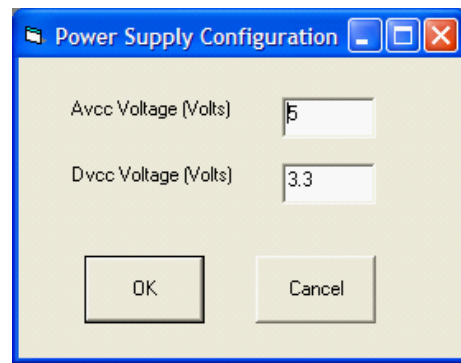

Figure 5. Power Supply Configuration

Y-Axis

Use the Y Axis screen to configure the display of the FFT Y-Axis. Go to Config > YAxis to change the default value of -130, which is a typical setting for the noise floor of a 14-bit ADC with 16,384 samples in the FFT calculation.

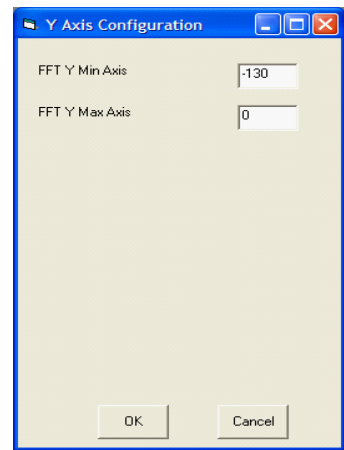

Figure 6. Y Axis Configuration

INSTALLING ADC ANALYZER WITH ADIsimADC

ADC Analyzer is useful also as an evaluation tool for simulated ADCs using ADIsimADC.

INSTALLATION

The simulation tools are installed as part of the regular installation of ADC Analyzer (for instructions, see the Installing ADC Analyzer section). Before using these features, the desired model files must be installed. Locate the available models on the Analog Devices website www.analog.com/ADIsimADC or by locating the desired converter product and going to the Design Tools area for that product.

1. Download the desired model file to the models directory. The default is c:\program files\adc_analyzer\models.
2. Although the software is provided with the evaluation board, no hardware is required to use the modeling software. Updates to the software are posted periodically to www.analog.com as well as new and updated models. Check the website frequently to ensure that you have the latest for both files.
3. Once the software and models are installed, run the executable file (the default location is in c:\program files\adc_analyzer\adc_analyzer.exe).

CONFIGURATION FILE

As with using an ADC evaluation board, a corresponding configuration file must be loaded before simulations can occur. This file provides the software with important information about the format in which the data is generated, and other information, such as the number of bits, speed of the clock, and format of the data bits (binary or twos complement). Configuration files for some of the evaluation boards are included with the ADC Analyzer files. Each time ADC Analyzer is launched, a window opens in which a configuration file can be specified. Click **Yes** to specify a configuration file and choose the file corresponding to the ADC evaluation board being used. For more details, see the Configuring an Evaluation Board section.

CONFIGURING A MODEL

To configure the software for use with ADIsimADC virtual evaluation board, follow Steps 1 through 8.

1. Choose Config > FFT from the pull-down menus or right-click on any of the analysis buttons to bring up the FFT Configuration menu. In this window, set the encode rate to the desired rate that the converter can support. If an encode rate is specified outside the operating range of the converter, the model will not function as expected and erroneous results will be obtained. Make any other adjustments necessary. If you have questions, see the Configuring an Evaluation Board. Click **OK** when finished.

2. From the menu, select Config > Buffer. From the drop down list, select **Model**. Then click **OK**. In effect, the model functions in place of the ADC and data capture hardware.

Step 2



3. After selecting the Model, a small button, Model, is displayed next to the Stop button. Click Model to open the model selection form.

Step 3

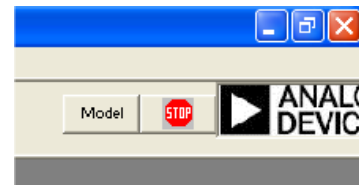

4. The ADC Modeling form lets you select the device to model and configure the analog input to the model.

Step 4

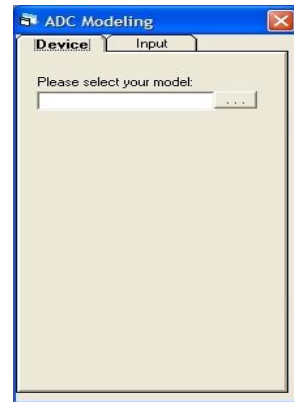

From the ADC Modeling form, select the **Device** tab and click the ... button, adjacent to the dialog box. This opens a file browser and displays all of the models found in the default directory. If you have not loaded models on your machine, see Step 1 under Installation.

HSC-ADC-EVALA-SC/HSC-ADC-EVALA-DC

5. From the file browser, select the model of interest.

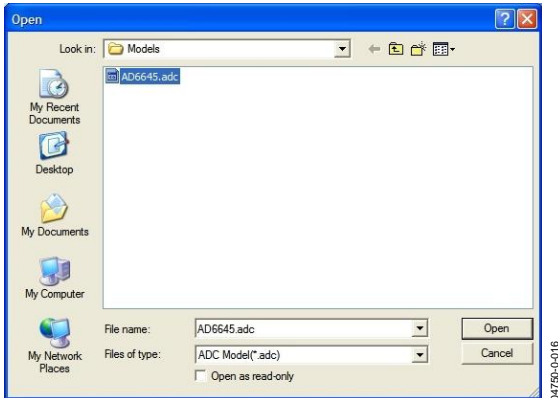

When the model is selected, information about that device is filled in on the **ADC Modeling** form. Note that the amount of jitter, assumed at the time of characterization, automatically inserts in the **External Jitter** box on the **Input** tab. The model also returns a default Output Mode which is defined either as **Offset Binary** or **Twos Complement**. This setting automatically sets through the Config > FFT menu. If using a real part along with a model, note the correct **Output Mode** setting. If the windowing function under the Config > Windowing menu is set to **None**, a **Coherent Sampling** window opens. If you are in modeling mode and use this function, the calculated frequency inserts in the **Analog In** box on the **Input** tab

Step 5a:

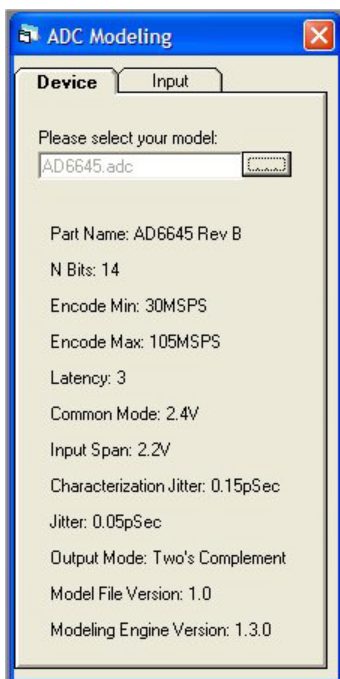

6. Select the **Input** tab. From this tab, you may select the input stimulus of either a single or dual sine wave, the input signal level relative to the converter range, the input frequency, the signal offset, the signal range, external clock jitter and external analog dither. If two tone is selected, you also may specify the second tone. For the most accurate results, both signals should be in the same Nyquist zone.

Step 6

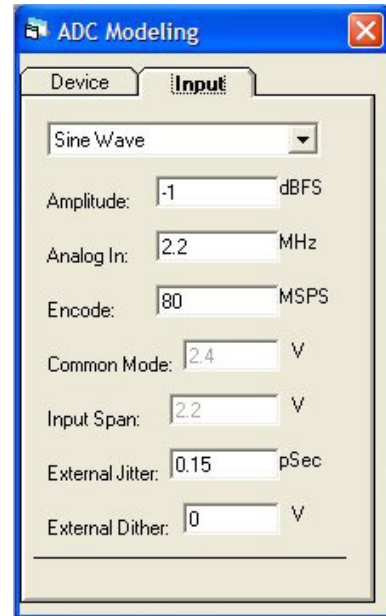

7. The Model is now fully configured and evaluations may begin. Any of the documented features of ADC Analyzer may be used for testing the virtual evaluation board as if a real evaluation board were connected. In addition, the virtual evaluation board supports sweeping of the analog input level and frequency.
8. To switch back to evaluate a real product, it is only required to specify the buffer memory by selecting Config > Buffer and select HSC_ADC_EVAL from the drop down list.

ADC ANALYZER FUNCTIONS

A number of functions can be performed on the data collected by the FIFO evaluation board. These functions are represented by the row of buttons under the pull-down menus. The same functions also can be accessed under the Analyze pull-down menu. A description of each button is listed below.

TIME DOMAIN



This function displays a reconstruction of the captured data in the time domain. Several values are listed to the left of the signal, including

AVCC: Analog voltage level, set under Config > Power Supply (for display purposes only)

DVCC: Digital voltage level, set under Config > Power Supply (for display purposes only)

Encode: ADC clock rate (MSPS), set under Config > FFT

Analog: Calculated analog input frequency (MHz)

Min: Minimum output code produced by the analog input

Max: Maximum output code produced by the analog input

Range: The range of the codes produced by the analog input

Average: Average value of the codes; may be interpreted as the common mode

F/S: Full-scale code range, equal to 2^n , where n is the number of bits

Samples: Number of samples taken, determined by FFT Configuration (Config > FFT)

CONTINUOUS TIME DOMAIN



This function displays a continuous reconstruction of the captured data and is also useful for troubleshooting. Click the **STOP** button to end the continuous display.

FFT



This function displays a reconstruction of the captured data in the frequency domain to analyze single-tone analog inputs. Several values are listed to the left of the signal, including

AVCC: Analog voltage level, set under Config > Power Supply (for display purposes only)

DVCC: Digital voltage level, set under Config > Power Supply (for display purposes only)

Encode: ADC clock rate (MSPS), set under Config > FFT.

Analog: Calculated analog input frequency (MHz). In IF sampling applications, the analog input is calculated back to the first Nyquist zone. Note that the encode rate must be set properly in the Config > FFT menu.

SNR: Signal-to-noise ratio (dB)

SNRFS: Signal-to-noise ratio full scale (dBFS)

UDSNR: User defined signal-to-noise ratio (dB)

NF: Noise figure (dB)

SINAD: Signal-to-noise and distortion (dB)

Fund: Level of the fundamental (highest) tone (dBFS)

Image: Level of image (nonharmonic) spur (dBc). Note that Image is valid only when using demultiplexed ADCs

Second: Level of the second harmonic (dBc) of the fundamental

Third: Level of the third harmonic (dBc) of the fundamental

Fourth: Level of the fourth harmonic (dBc) of the fundamental

Fifth: Level of the fifth harmonic (dBc) of the fundamental

Sixth: Level of the sixth harmonic (dBc) of the fundamental

WoSpur: Level of the worst nonharmonic spur

THD: Total harmonic distortion (dBc)

SFDR: Spurious-free dynamic range (dBc)

Noise Floor: Level of the noise floor (dBFS)

Samples: Number of samples taken, determined by FFT configuration, set under Config > FFT

CONTINUOUS FFT



This function displays a continuous FFT.

AVERAGE FFT



This function displays an average of a user-specified number of FFTs. Configure the number of FFTs under Config > FFT. The default value is 5.

CONTINUOUS AVERAGE FFT



This function displays a continuous average of a user-specified number of FFTs. Configure the number of FFTs under Config > FFT. The default value is 5.

HSC-ADC-EVALA-SC/HSC-ADC-EVALA-DC

TWO TONE



This function displays a reconstruction of the captured data in the frequency domain to analyze dual-tone analog inputs. Several values are listed to the left of the signal, including

AVCC: Analog voltage level, set under Config > Power Supply (for display purposes only)

DVCC: Digital voltage level, set under Config > Power Supply (for display purposes only)

Encode: ADC clock rate (MSPS), set under Config > FFT

Analog 1: First analog input frequency (MHz)

Analog 2: Second analog input frequency (MHz)

Fundamental 1: First fundamental tone (dBFS)

Fundamental 2: Second fundamental tone (dBFS)

F1 + F2: Sum of the fundamental tones (dBFS)

F2 – F1: Difference of the fundamental tones (dBFS)

2F1 – F2: $2 \times$ Fundamental 1 – Fundamental 2 (dBFS)

2F1 + F2: $2 \times$ Fundamental 1 + Fundamental 2 (dBFS)

2F2 – F1: $2 \times$ Fundamental 2 – Fundamental 1 (dBFS)

2F2 + F1: $2 \times$ Fundamental 2 + Fundamental 1 (dBFS)

WoIMD: Worst intermodulation distortion (dBc)

IIP2: Measure of the input intercept point in relation to the second order intermodulation distortion powers (dBm)

IIP3: Measure of the input intercept point in relation to the third order intermodulation distortion powers (dBm)

SFDR: Spurious-free dynamic range (dBc)

Noise Floor: Level of the noise floor (dBFS)

Samples: Number of samples taken, determined by FFT configuration, set under Config > FFT

CONTINUOUS TWO TONE



This function displays a continuous dual-tone FFT.

AVERAGE TWO TONE



This function displays an average of a user-specified number of dual-tone FFTs. Configure the number of FFTs under Config > FFT. The default value is 5.

STOP



Click this button to end any of the continuous display functions.

ZOOMING AND EXPORTING DATA

To zoom in on any portion of a displayed analog signal or FFT, select the portion of the signal by holding down the left mouse button and dragging across the area of interest. Bring up a hidden menu by clicking the right mouse button in the active window. The hidden menus are slightly different for the time-domain and FFT plots. These hidden menus have several options, including zooming and the capability to export time-domain data. Select from the menus using the left mouse button (see Figure 7 and Figure 8)

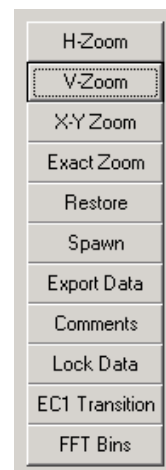

Figure 7. Time-Domain Plot Hidden Menu

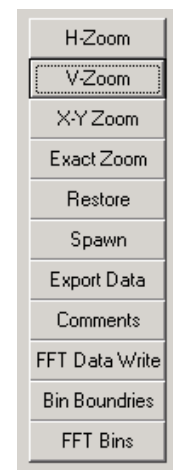

Figure 8. FFT Plot Hidden Menu

H-Zoom: Scales the selected section horizontally

V-Zoom: Scales the selected section vertically

X-Y Zoom: Scales horizontally and vertically (two dimensions)

Exact Zoom: Enter specific coordinates to view

Restore: Restores the graph to its original view

Spawn: Produces an exact working copy of the active window that can be analyzed separately

Export Data: Writes all of the data points as well as the calculated information to a file. The information is saved as a .csv file that can be viewed in Microsoft Excel

Comments: Lets the user enter comments about the graph. If the FFT is printed, the comments are included in the printout

Lock Data (Time-Domain Plot Only): Once a time-domain sample of the data is taken, the user can “lock” this data and then perform an FFT. The FFT will be calculated based on this data instead of a new sample of data

ECI Transition: Not applicable

FFT Data Write (FFT Plot Only): Writes the calculated FFT data to a file

Bin Boundaries (FFT Plot Only): Highlights the bins used to calculate the fundamental and harmonic energy. Configure the Fundamental Leakage and Harmonic Leakage under Config > FFT. See the Configuring an Evaluation Board section for more information

FFT Bins: Changes the X-axis of the graph from frequency to bins

IMPORTING DATA

Data can be imported to ADC Analyzer to perform an FFT calculation. Two types of data can be imported: raw time domain text data in decimal format (from a logic analyzer, for example) and data exported from ADC Analyzer.

Note that when importing data, double-check to make sure that the number of bits, sample size, and digital format (Twos Complement vs. Offset Binary) are selected appropriately under the Config menu.

To import data previously exported from ADC Analyzer:

1. Choose File > Import Data.
2. Enter the file path in the dialog box shown in Figure 9, or click the **Browse...** button to search for the file. Click **OK**.
3. The time-domain data is graphed in a new window. Right click the graph to open the hidden menu. Choose **Lock Data** from the menu. See Figure 7 in the Zooming and Exporting Data section.
4. To perform an FFT on this data, click the **FFT** button.

To import raw time domain text data in decimal format:

1. Choose File > Import Data.
2. Click the **ASCII File** button shown in Figure 9.
3. The window in Figure 10 opens. This window is used to give ADC Analyzer information about how to interpret the text data file. If any of these input parameters are not correct, both the time and FFT data will not be correct.

Data Bits: Select the resolution of the ADC.

Samples: Select the number of samples in the file.

Data Format: Select the format of the ADC output data.

Justification: Normally, the data exported from ADC Analyzer is MSB_Justified. When importing data, be sure to select the proper justification.

Encode Frequency (MHz): Enter the sampling clock rate used.

ASCII Text File to Import: Click the **Browse...** button to search for the file.

4. Click **OK**. The time-domain data is graphed in a new window. Right click the graph to open the hidden menu. Select **Lock Data** from the menu. (See Figure 7.)
5. To perform an FFT on this data, click the **FFT** button.

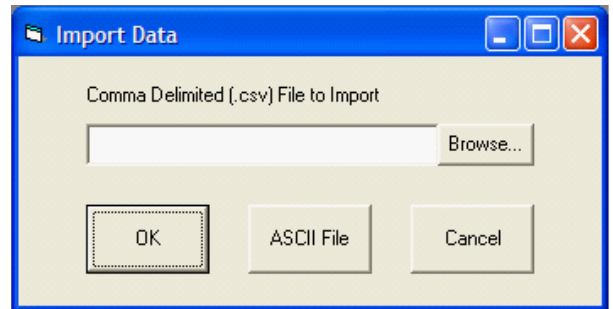

Figure 9. Import Data Dialog Box

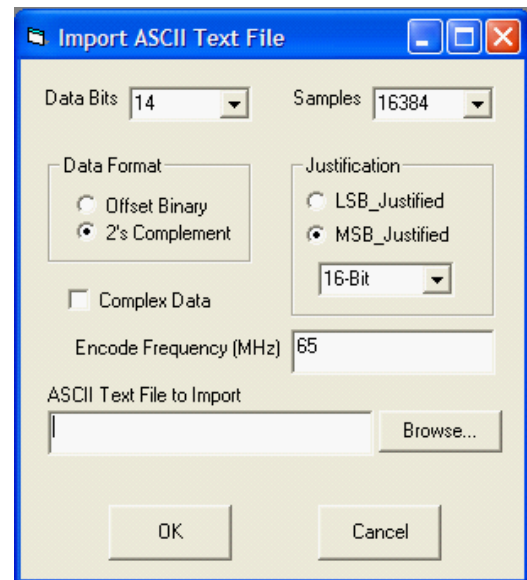

Figure 10. Import ASCII Text File Dialog Box

.csv and ASCII files

The Comma Separated Value or Comma Delimited file format (.csv) is displayed in Figure 11 using Microsoft Excel. The .csv file includes extra parameters, including the raw time domain data.

HSC-ADC-EVALA-SC/HSC-ADC-EVALA-DC

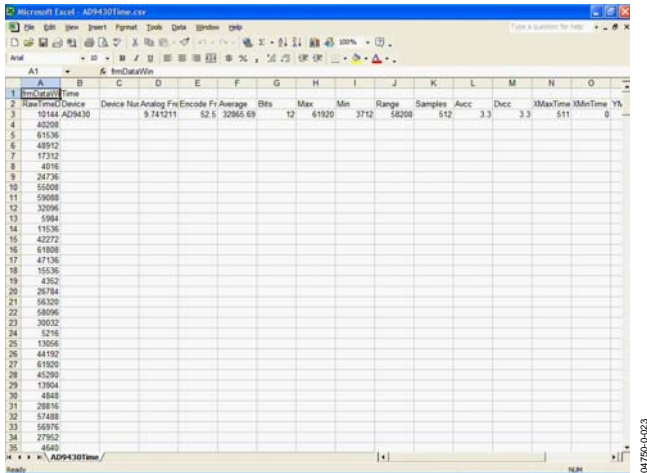

Figure 11. Import .csv file using MS Excel

Parameters, such as Device, Device Number, Analog Frequency, Encode Frequency, Average (value), (number of) Bits, Max (value), Min (value), Range (of values), (amount of) Samples, AVCC, DVCC, XMaxTime, XMinTime, YMaxTime, YMinTime, Date, Time, Device Temperature, and Comments are included at the top of the file.

If constructing a .csv file to import to ADC_Analyzer, the format of the sample .csv file must be followed. It is recommended that you use Microsoft Excel to paste the desired data and parameters over the example data and parameters. For example, the user has 16384 samples (16 kB samples). Paste the amount of samples (16384) into the cell directly below the cell labeled “Samples.” Then paste the desired 16384 raw data samples under the cell labeled “RawTimeData.” Other parameters can be changed just like “Samples” and “RawTimeData” if desired, but are not necessary for the import to work properly.

The above procedure works most easily with Microsoft Excel. A .csv file can be constructed with a text editor such as Notepad, but Notepad does not provide the column alignment that Microsoft Excel provides, as shown in Figure 12.

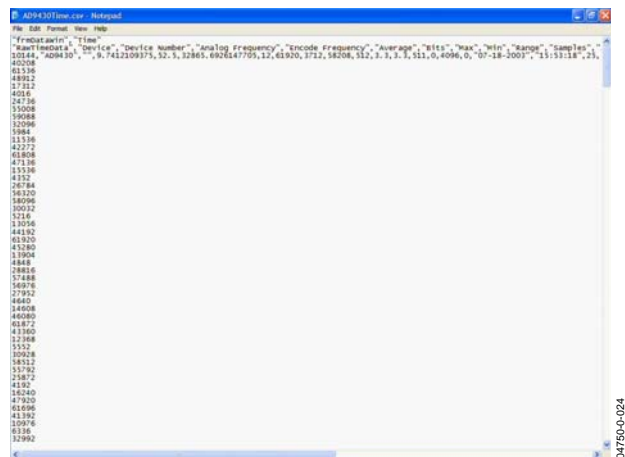

Figure 12. Import ASCII Text File using Notepad

Only raw time domain data is used in an ASCII file format that is imported to ADC Analyzer. No specifications, words, extraneous characters, spaces, commas, or tabs can be placed in the ASCII file.

Example portion of an ASCII file: (note that the entire ASCII file consists of time domain samples such as this.)

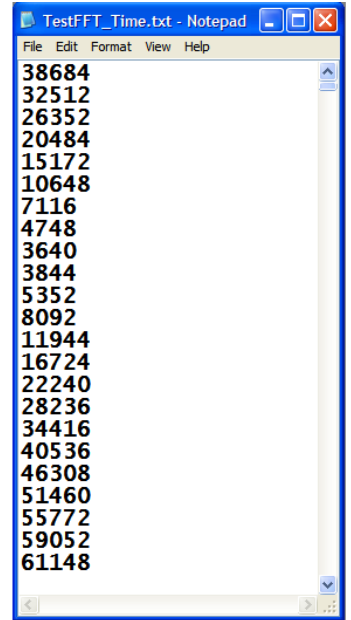

Figure 13. ASCII File Sample

PRINTING

There are several printing options available in ADC Analyzer. To print the active window, choose File > Print > Print Active. To print more than one open window, choose File > Print > Print List. A dialogue box is displayed where the user can choose which windows to print. Choose multiple windows by clicking on each window while pressing the **CTRL** key or print all open windows with the **Print All** button. To print the entire screen, choose File > Print > Print Screen.

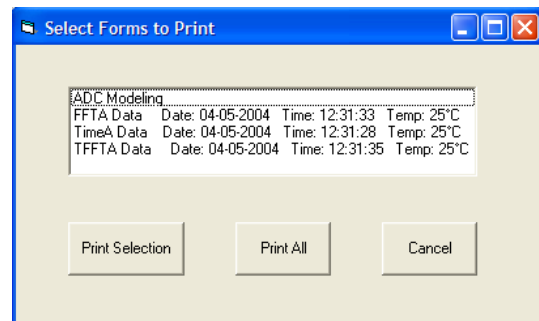

Figure 14. Printing Options

SAVING FILES

There are three ways to save an image in ADC Analyzer. Choose File > Save As > Save Active to save the active window in bitmap or jpeg format. Choose File > Save As > Save List to save each open window as a separate bitmap file. To save the entire screen as a bitmap file, choose File > Save As > Save Screen.

ADDITIONAL FUNCTIONS (VIRTUAL ADC ONLY)

The following function is available only while using the virtual evaluation board feature. This feature is disabled when operating in any of the normal buffer memory configurations.

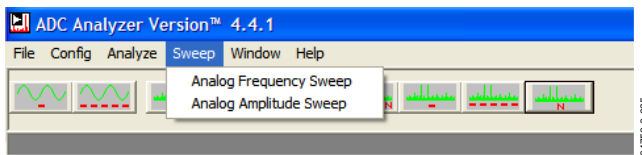

Figure 15. Sweep Mode Options

From the main menu, select **Sweep**. There are two choices: **Analog Frequency Sweep** and **Analog Amplitude Sweep**. Selecting either one of these opens the appropriate configuration window.

AMPLITUDE SWEEP (VIRTUAL ADC ONLY)

When this option is chosen, the form shown in Figure 16 is displayed. Use this form to select the options for an amplitude sweep. The frequency for the amplitude sweep is set on the **ADC Modeling** form under the **Input** tab, and must be set prior to selecting this option.

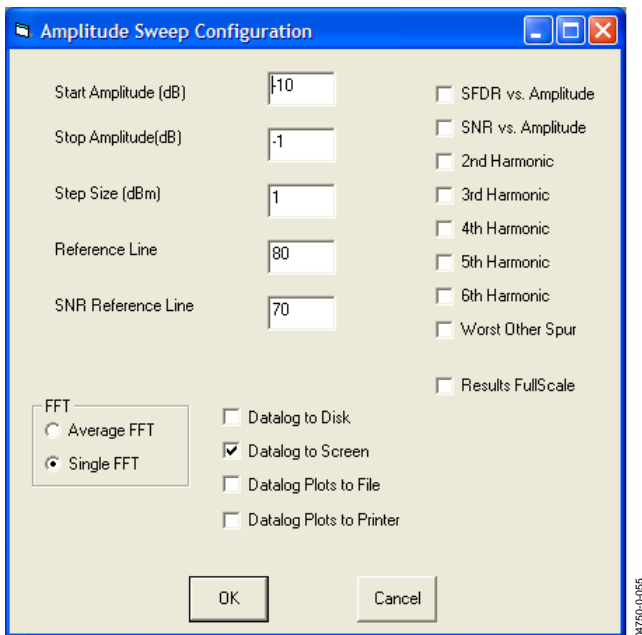

Figure 16. Amplitude Sweep Mode Options

Start Amplitude (dB): This sets the starting level of the amplitude sweep. This is relative to the dc fullscale of the converter. This number should always be lower than the stop amplitude.

Stop Amplitude (dB): This sets the stopping level of the amplitude sweep. This is relative to the dc fullscale of the converter. This number should always be larger than the start amplitude.

Step Size (dB): This is the step size used for each amplitude step. This number should always be positive. There is no limit to the size of the step. However, the smaller the step, the longer the sweep will require to complete. Likewise, the larger the step, the lower the resolution of the sweep.

Reference Line: This draws a reference line used for comparison of the SFDR of the unit.

SNR Reference Line: This draws a reference line used for comparison of the SNR of the unit.

FFT: The FFT selection determines if single or average FFTs are used during the sweep.

SFDR vs. Amplitude: Selecting this check box enables SFDR versus amplitude results.

SNR vs. Amplitude: Selecting this check box enables SNR versus amplitude results.

2nd Harmonic: Selecting this check box enables 2nd harmonics versus amplitude results.

3rd Harmonic: Selecting this check box enables 3rd harmonics versus amplitude results.

4th Harmonic: Selecting this check box enables 4th harmonics versus amplitude results.

5th Harmonic: Selecting this check box enables 5th harmonics versus amplitude results.

6th Harmonic: Selecting this check box enables 6th harmonics versus amplitude results.

Worst Other Spur: Selecting this check box enables worst other spur versus amplitude results.

Results Fullscale: Selecting this check box refers all measurements to fullscale (dBFS). When this is not selected, the measurements are relative to the signal (dBc).

Datalog to Disk: Selecting this check box writes all data to a file in the default data directory. The data format is an ASCII readable CSV file.

HSC-ADC-EVALA-SC/HSC-ADC-EVALA-DC

Datalog to Screen: Selecting this check box causes graphs of each of the selected plots to be displayed on the screen after completion of the sweep.

Datalog Plots to File: Selection of this check box causes each bitmap plot to be written to the default data directory.

Datalog Plots to Printer: Selection of this check box causes each bitmap plot to be sent to the printer.

ANALOG FREQUENCY SWEEP (VIRTUAL ADC ONLY)

When this option is chosen, the form shown in Figure 17 is displayed. This form is used to select the options for a frequency sweep. The amplitude for the frequency sweep is set on the **ADC Modeling** form under the **Input** tab, and must be set prior to selecting this option.

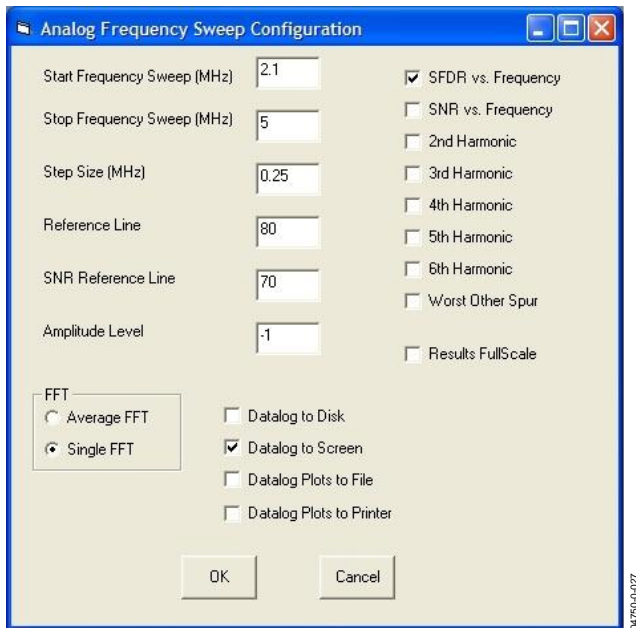

Figure 17. Frequency Sweep Mode Options

Start Frequency (MHz): This sets the starting frequency of the frequency sweep. This number should always be lower than the stop amplitude.

Stop Frequency (MHz): This sets the stopping frequency of the frequency sweep. This number should always be larger than the start amplitude.

Step Size (MHz): This is the step size used for each frequency step. This number should always be positive. There is no limit to the size of the step. However, the smaller the step, the longer the

sweep will require to complete. Likewise, the larger the step, the lower the resolution of the sweep.

Reference Line: This draws a reference line used for comparison of the SFDR of the unit.

SNR Reference Line: This draws a reference line used for comparison of the SNR of the unit.

FFT: The selection in this box determines if single or average FFTs are used during the sweep.

SFDR vs. Frequency: Selecting this check box enables SFDR versus frequency results.

SNR vs. Frequency: Selecting this check box enables SNR versus frequency results.

2nd Harmonic: Selecting this check box enables 2nd harmonics versus frequency results.

3rd Harmonic: Selecting this check box enables 3rd harmonics versus frequency results.

4th Harmonic: Selecting this check box enables 4th harmonics versus frequency results.

5th Harmonic: Selecting this check box enables 5th harmonics versus frequency results.

6th Harmonic: Selecting this check box enables 6th harmonics versus frequency results.

Worst Other Spur: Selecting this check box enables worst other spur versus frequency results.

Results Fullscale: Selecting this check box refers all measurements to fullscale (dBFS). When this is not selected, the measurement is relative to the signal (dBc).

Datalog to Disk: Selecting this check box writes all data to a file in the default data directory. The data format is an ASCII readable CSV file.

Datalog to Screen: Selecting this check box causes graphs of each of the selected plots to be displayed on the screen after completion of the sweep.

Datalog Plots to File: Selection of this check box causes each bitmap plot to be written to the default data directory.

Datalog Plots to Printer: Selection of this check box causes each bitmap plot to be sent to the printer.

TROUBLESHOOTING

FLAT LINE SIGNAL DISPLAYED

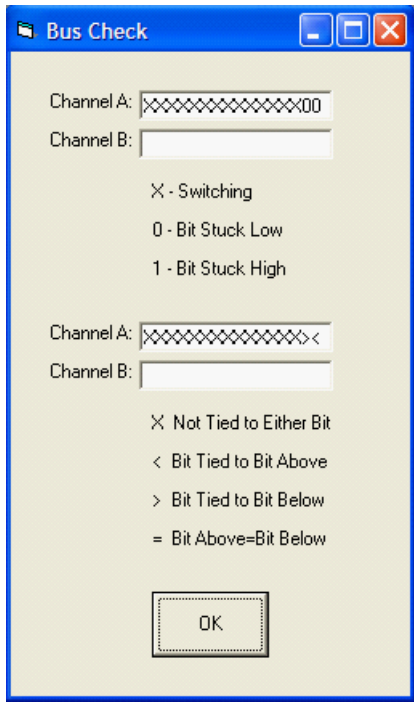

Figure 18. Bus Check for a 12-Bit ADC

Scenario: After clicking the time domain button, the signal displayed in the window is a flat line.

1. Check the power connections.
2. Verify that the USB cable does not exceed 5 feet in length or the parallel printer cable is IEEE-1284 compatible.
3. Check the cable connection between the PC and the FIFO board. If applicable, ensure the correct parallel port is selected (LPT1 or LPT2) under Config > Buffer.
4. If using a parallel port, make sure the Printer Port in the computer BIOS is set to **Standard Bidirectional**.
5. Make sure Channel A, Channel B, or both channels are selected under Config > FFT.
6. Check the signal connections and make sure that the clock is present at the output of the ADC evaluation board.
7. Verify that data bits are switching at the connection point between the FIFO and the ADC evaluation board.
8. Use the Analyze > Bus Check option to ensure all data bits are switching. See Figure 19 for an example of the AD6645, 14-bit single channel ADC. Note: The left-most bit is the MSB.

9. Use the ADC data sheet to ensure all jumper connections are set appropriately on the ADC evaluation board. Ensure the ADC power-down option is not active.
10. Refer to Table 2, to ensure that all jumpers are set appropriately.

DISPLAYED SIGNAL UNLIKE ANALOG INPUT

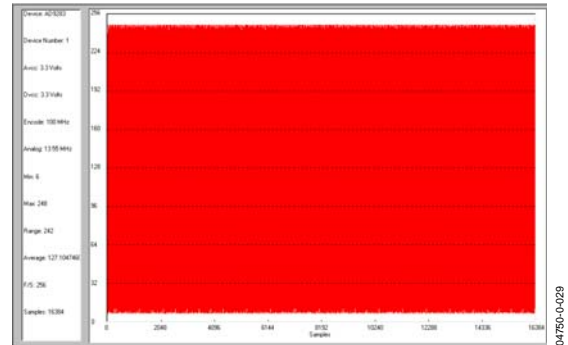

Figure 19. Typical Time Domain Plot

Scenario: After clicking **Time Domain**, the signal displayed does not look like the analog input signal.

1. A fast sinusoidal signal may look like a solid red block in the time-domain window (due to the number of sine waves shown). Right click the window to open a hidden menu where you can zoom in to a closer view of the signal.
2. Check the cable connection between the PC and the FIFO board. If applicable, ensure the correct parallel port is selected (LPT1 or LPT2) under Config > Buffer.
3. Check the signal connections.
4. Use the Analyze > Bus Check option to ensure all of the data bits are switching.
5. Ensure that the **Twos Complement** button is set correctly under Config > FFT. If the Twos Complement box is checked and the ADC outputs are not in Twos Complement format, a time-domain plot may look like Figure 20.
6. Adjust the timing to ensure that the data is captured correctly. Refer to the Clocking Description section in the Theory of Operation, and Table 2 for more information.
7. Try using a very low frequency analog input (for example, 0.1 MHz to 1 MHz) to debug timing issues. For an exact number of cycles, such as 10, try $(10 \times f_s) / M$, where f_s = encode frequency and M = sample size (2^N).
8. Check for problems with the common-mode level at the analog input by looking at the time data with no analog input signal.

HSC-ADC-EVALA-SC/HSC-ADC-EVALA-DC

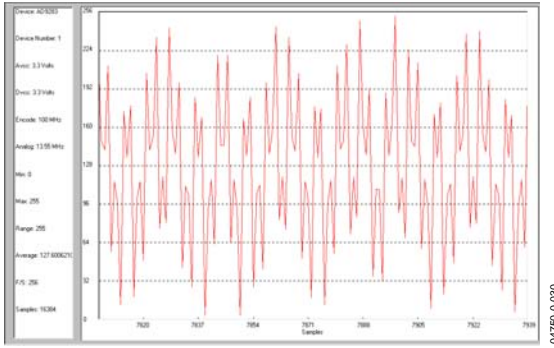

Figure 20. Incorrect Setting for Twos Complement

LARGE SPUR IN FFT (IMAGE PROBLEM)

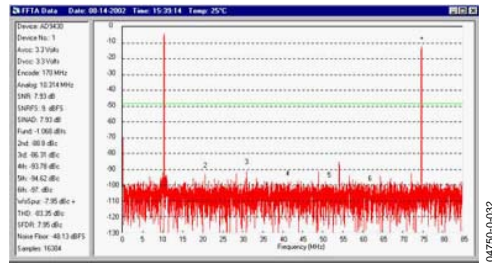

Figure 22. AD9430 Timing Issue

FFT NOISE FLOOR HIGHER THAN EXPECTED

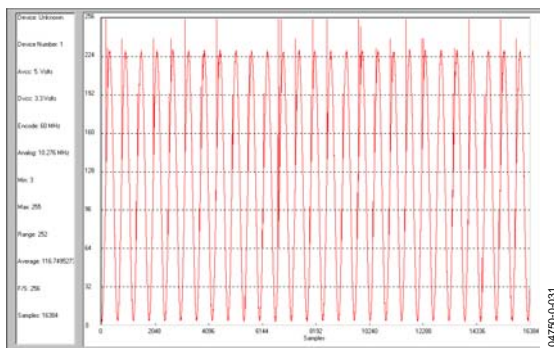

Figure 21. Example of How Timing Issues Affect the Noise Floor

Scenario: The noise floor of the FFT is higher than expected. Note that a higher than expected noise floor on the FFT can often be traced back to timing issues in the clock path.

- 1 Put a very slow sine wave signal into the ADC (such as 0.1 MHz to 1 MHz) and initiate a time-domain plot. If the plot looks similar to Figure 21, there are timing issues.
- 2 Switch Jumpers J304 and/or J305 to their alternate positions to invert the clock.
- 3 The four XOR gates of U302 can be used to insert delay into the high speed clock path or to invert the clock to optimize timing. Try moving jumpers J314 and J315 to their alternate position. This should allow enough flexibility for you to adjust timing under any conditions.
- 4 To gain even finer adjustments, use the installed trim pot, R312 and R315. To undo the default bypass, the solder jumpers J310-J313 must be removed first.

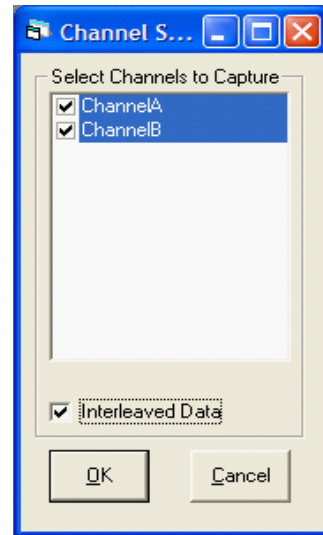

Figure 23. Channel Selection

Scenario: There is a large spur in the FFT (image of the fundamental) when evaluating the demultiplexed outputs (such as the AD9430).

1. Click Config > Channel Select, opening the window shown in Figure 23. Double-check and make sure the Interleaved Data box is selected. Click **OK**. Note that Channel A in the software corresponds to Channel 1 on the FIFO schematics and the bottom FIFO on the evaluation board. Channel B corresponds to Channel 2 on the FIFO schematics and the top FIFO on the evaluation board (closest to the Analog Devices logo). See the Jumpers section for more information.
2. The interleaved priority menu shows either Channel A or Channel B checked.

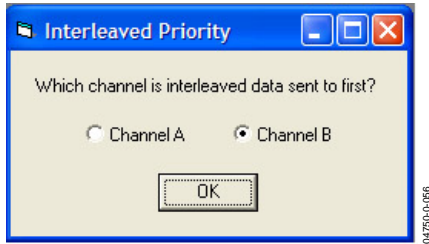

Figure 24. Interleaved Priority

3. Perform another FFT. The spur should disappear.

MSBs MISSING FROM TIME DOMAIN

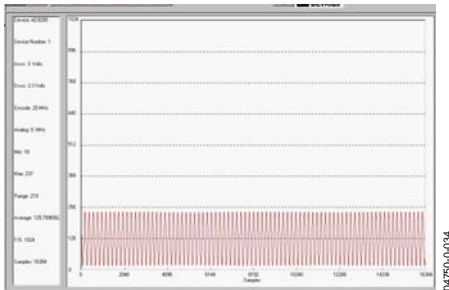

Figure 25. Incorrect Bit Mask Setting

Scenario: The two MSBs are missing from the time domain plot.

1. If evaluating the AD9200, AD9201, AD9280, or AD9281, make sure the appropriate bits are selected under Config > Bits > Data Bits. Bits 13 to 4 should be selected for the AD9200 and AD9201. Bits 13 to 6 should be selected for the AD9280 and AD9281. Default configuration files for these ADCs are installed with ADC Analyzer.
2. Make sure the bits are switching at the FIFO connector.

UPGRADING FIFO MEMORY

The FIFO evaluation board includes one or two 32 kB FIFOs, depending on the model. Pin compatible FIFO upgrades (64 kB to 256 kB) are available from Integrated Device Technology, Inc. (IDT). The IDT part numbers are:

- IDT72V283: 32 kB (included)
- IDT72V293: 64 kB
- IDT72V2103: 132 kB
- IDT72V2113: 256 kB

For more information, visit www.idt.com

HSC-ADC-EVALA-SC/HSC-ADC-EVALA-DC

JUMPERS

Use the legends below to configure the jumpers. On the FIFO evaluation board, Channel 1 is associated with the bottom IDT FIFO chip, and Channel 2 is associated with the top IDT FIFO chip (closest to the Analog Devices logo).

Table 2. Jumper Legend

Position	Description
In	Jumper in place (2-pin header)
Out	Jumper removed (2-pin header)
Position 1 or Position 3	Denotes the position of a 3-pin header. Position 1 is marked on the board.

Table 3 Solder Bridge Legend

Position	Description
In	Solder pads should be connected
Out	Solder pads should not be connected

DEFAULT SETTINGS

Table 4 lists the default settings for each model of the FIFO Evaluation Kit. The single channel (SC) model is configured to work with a single channel ADC using the bottom FIFO, U201. The dual channel (DC) model is configured to work with demultiplexed ADCs (such as the AD9430). Dual channel ADC settings are shown in a separate column, as are settings for the opposite (top) FIFO, U101 for a single channel ADC. To align the timing properly, some evaluation boards may require modifications to these settings. Refer to the Clocking Description section in the Theory of Operation section for more information.

Another useful way to configure the jumper settings easily for various configurations is to consult ADC Analyzer under the Help > About HSC_ADC_EVALA, and click **Setup Default Jumper Wizard**. Then click the configuration setting that applies to the application of interest. A picture of the FIFO board is displayed for that application with a visual of the correct jumper settings already in place.

Table 4. Jumper Configurations

Jumper No.	Single Channel Settings, Default (Bottom)	Demultiplexed Settings	Dual Channel Settings	Single Channel Settings ¹ (Top)	Description
J101	Out	Out	Out	Out	Not Used
J102	Out	Out	Out	Out	Not Used
J103	In	In	In	In	Ground Unused Pins from Input Header
J105	In	In	In	In	Ground Unused Pins from Input Header
J106	Out	Out	Out	Out	Not Used
J107	Out	Out	Out	Out	Not Used
J201	Out	Out	Out	Out	Not Used
J202	Out	Out	Out	Out	Not Used
J203	In	In	In	In	Takes the FF Signal on FIFO1 out of the Circuit
J205	In	In	In	In	Takes the EF Signal on FIFO1 out of the Circuit
J206	Out	Out	Out	Out	Not Used
J207	Out	Out	Out	Out	Not Used
J303	In	Out	Out	In	OUT for Interleave and Dual/Ties Write Clocks Together
J304	Position 3	Position 3	Position 3	Position 3	POS3: Invert Clock out of DS90
J305	Position 3	Position 3	Position 3	Position 3	POS3: Invert Clock out of DS90
J306	Out	Out	Out	Out	NO Invert from XOR (U302)
J307	Out	Out	Out	Out	NO Invert from XOR (U302)
J310-13	In	In	In	In	All Solder Jumpers are Shorted
J314	Position 3	Position 3	Position 3	Position 3	No Timing Delay
J315	Position 1	Position 1	Position 1	Position 1	No Timing Delay
J401	Position 1	Position 1	Position 1	Position 1	WEN Select

HSC-ADC-EVALA-SC/HSC-ADC-EVALA-DC

Jumper No.	Single Channel Settings, Default (Bottom)	Demultiplexed Settings	Dual Channel Settings	Single Channel Settings ¹ (Top)	Description
J402	Position 3	Position 3	Position 3	Position 3	WEN Select
J403	Position 1	Position 1	Position 1	Position 1	J303 OUT: POS 1 bottom channel, POS 3 Top channel

¹ Can only be used with a dual channel FIFO board. This is essentially a single channel, but using the opposite channel (top FIFO) rather than the standard default (bottom FIFO).

HSC-ADC-EVALA-SC/HSC-ADC-EVALA-DC

FIFO SCHEMATICS AND PCB LAYOUT

FIFO CONNECTOR

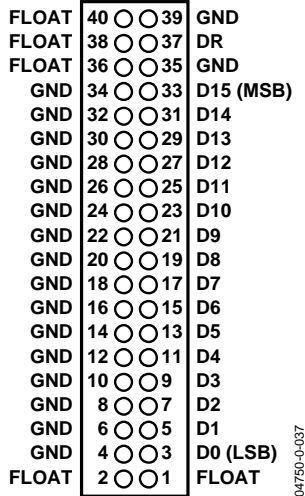

Figure 26. Single-Channel Connector Pin Diagram—
Top View (HSC-ADC-EVAL-SC)

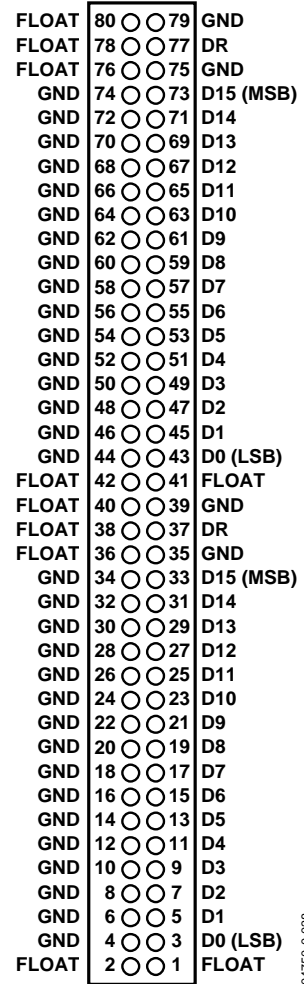

Figure 27. Dual-Channel Connector Pin Diagram—
Top View (HSC-ADC-EVAL-DC)

HSC-ADC-EVALA-SC/HSC-ADC-EVALA-DC

PCB SCHEMATIC (Continued)

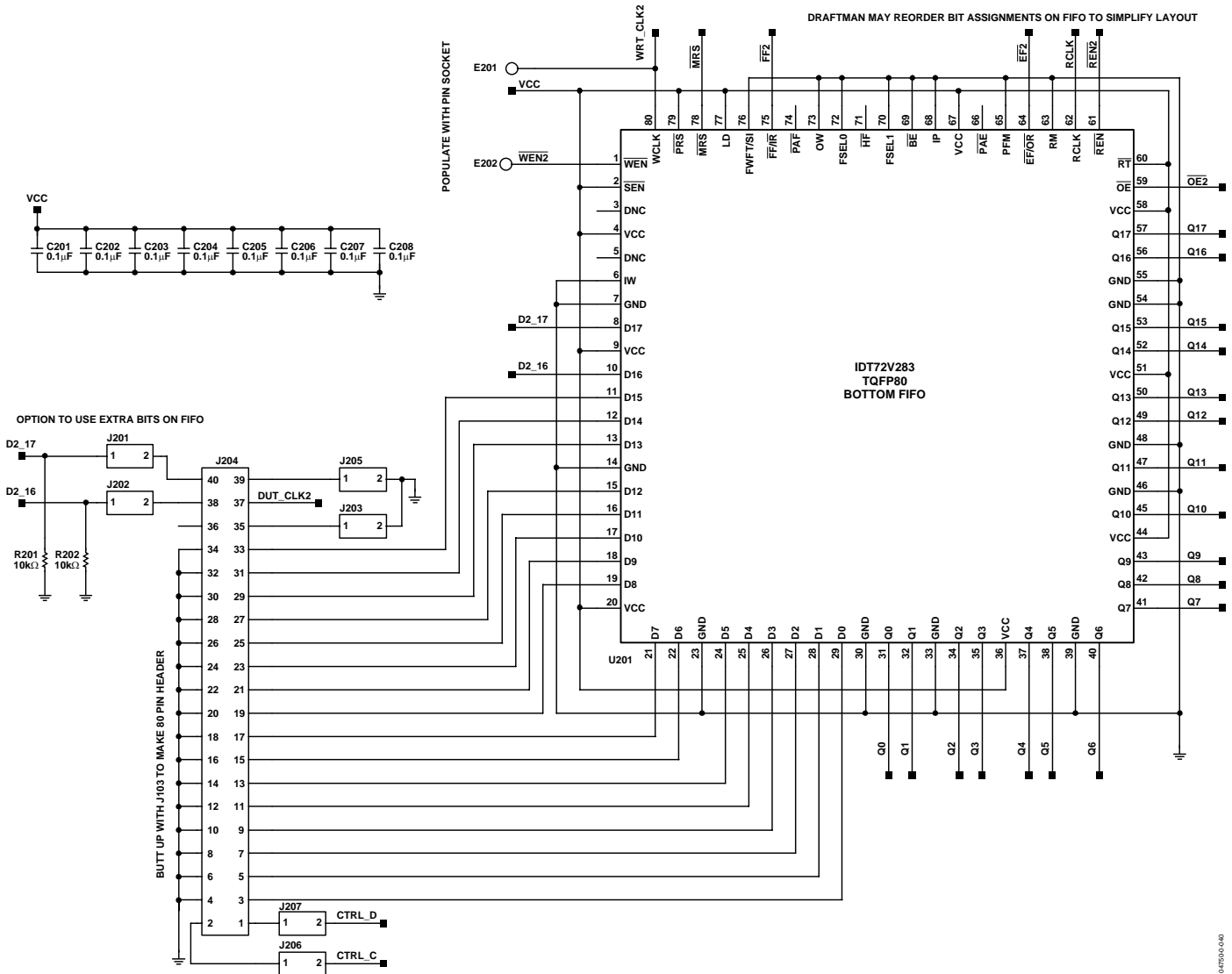

Figure 29. PCB Schematic (Continued)

047500-0-00

HSC-ADC-EVALA-SC/HSC-ADC-EVALA-DC

PCB SCHEMATIC (Continued)

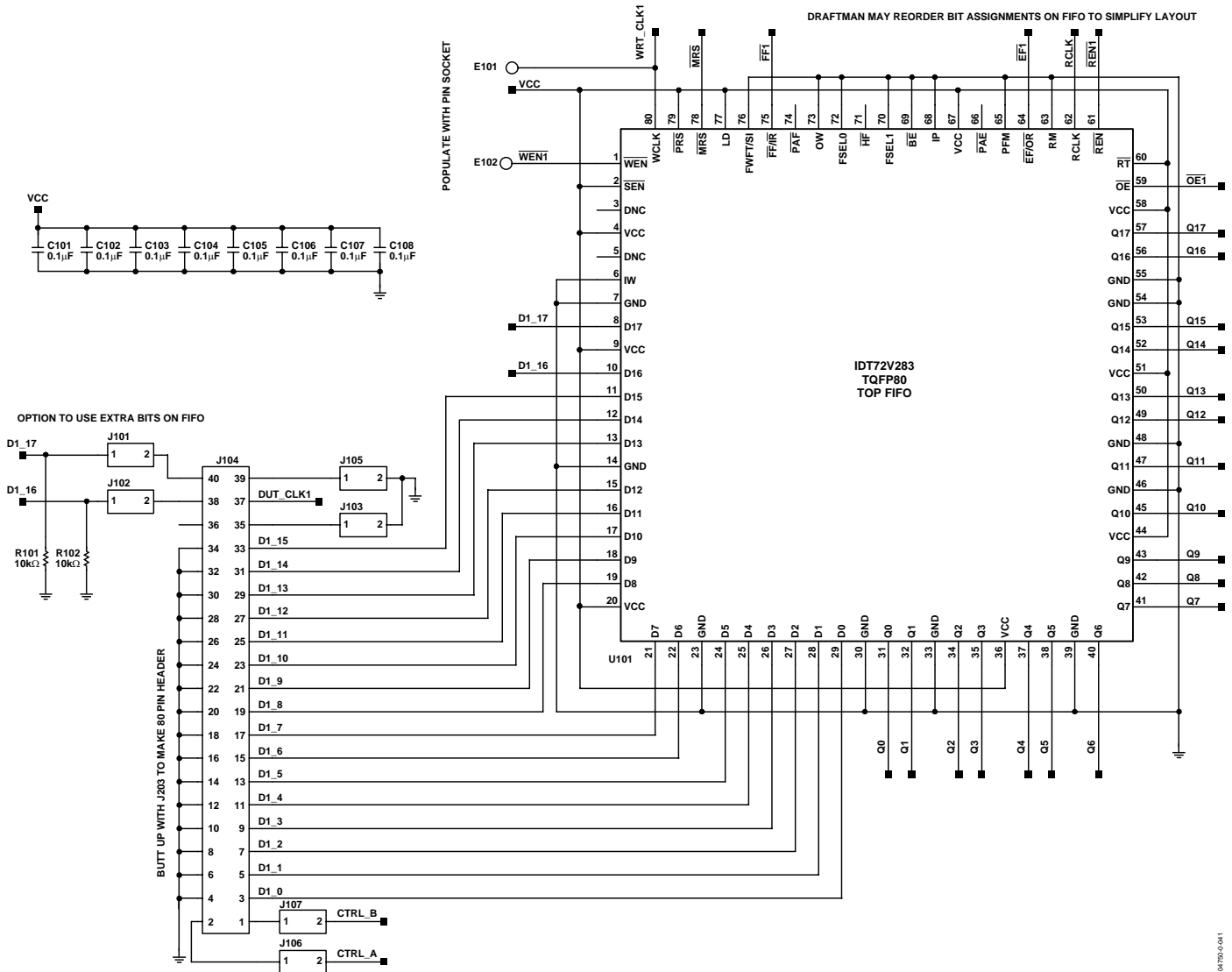

Figure 30. PCB Schematic (Continued)

01750-0-041

HSC-ADC-EVALA-SC/HSC-ADC-EVALA-DC

PCB SCHEMATIC (Continued)

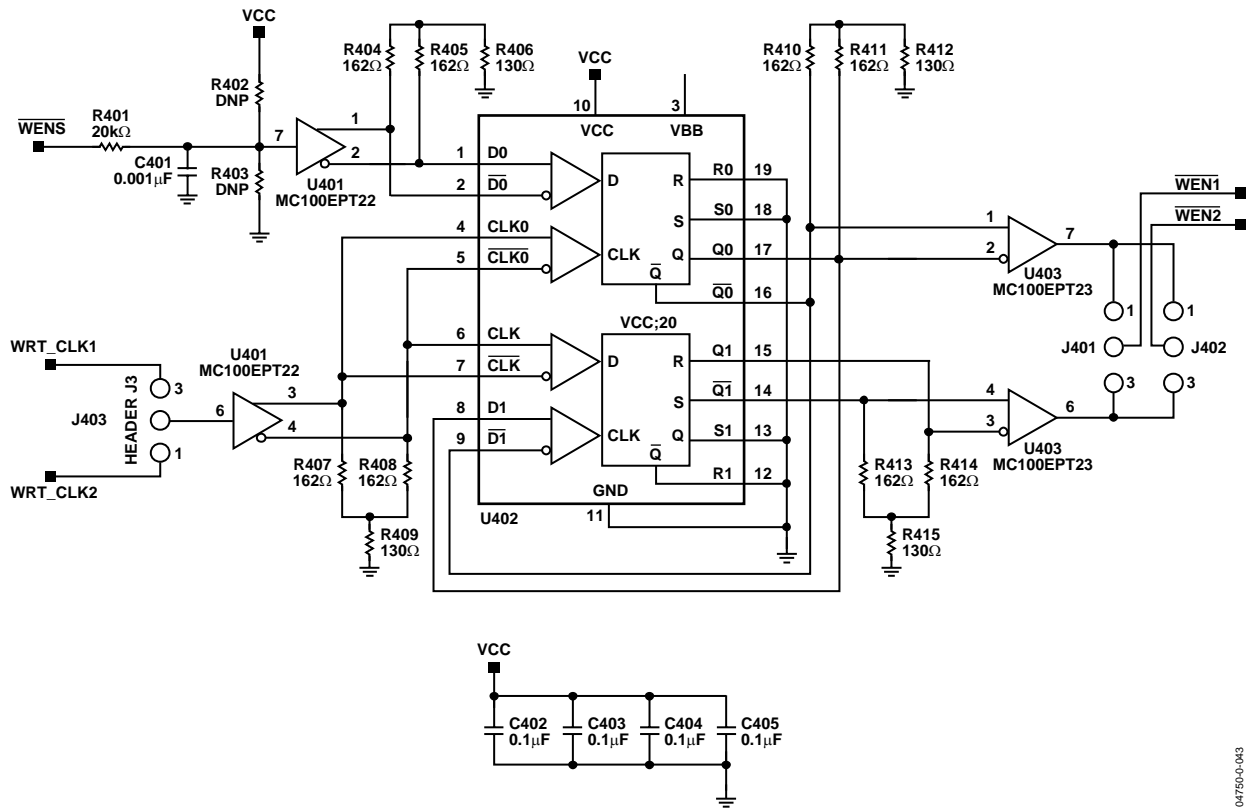

Figure 32. PCB Schematic (Continued)

047550-0-043

HSC-ADC-EVALA-SC/HSC-ADC-EVALA-DC

PCB SCHEMATIC (Continued)

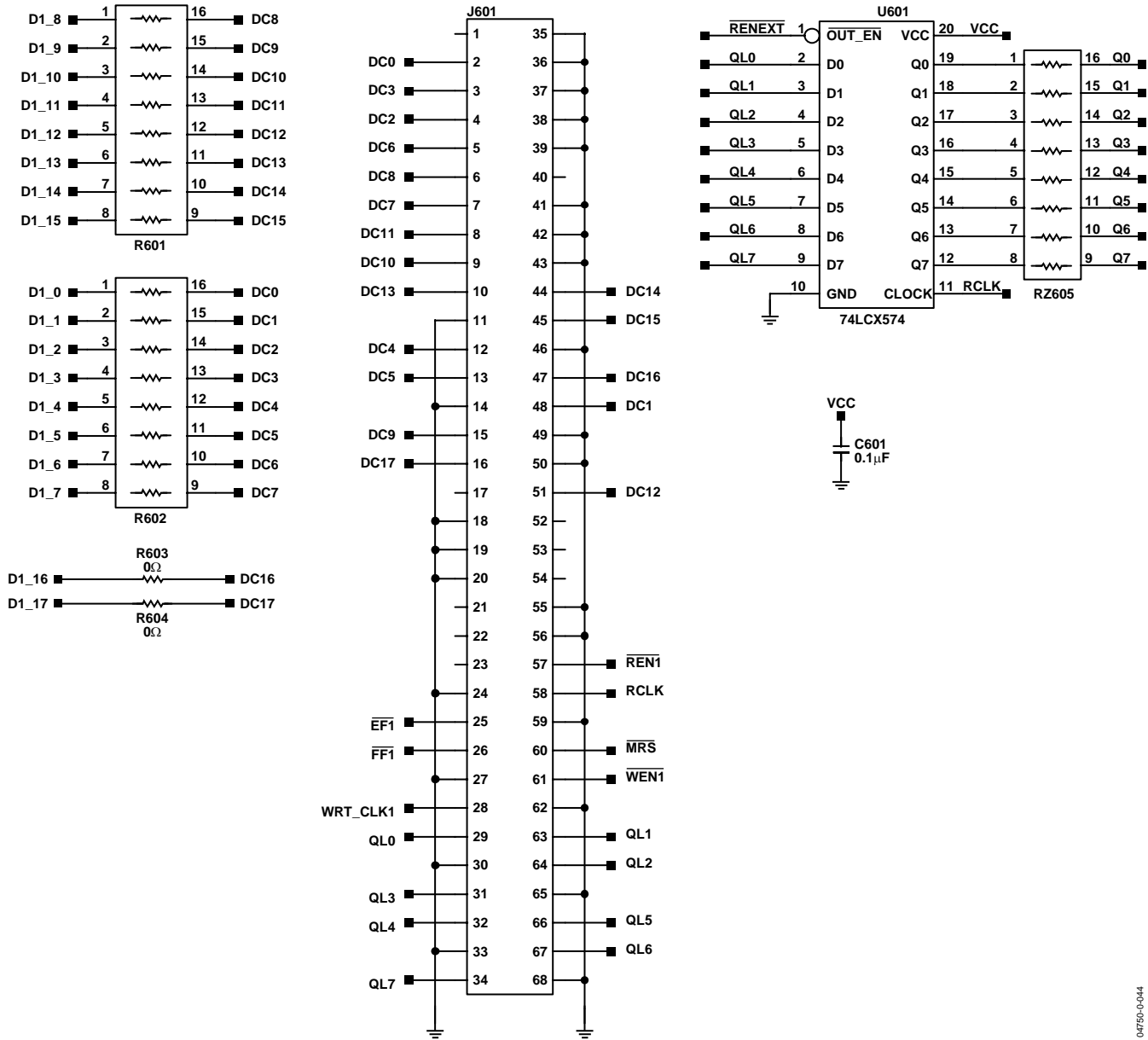

Figure 33. PCB Schematic (Continued)

04750-0-044

HSC-ADC-EVALA-SC/HSC-ADC-EVALA-DC

ASSEMBLY—PRIMARY SIDE

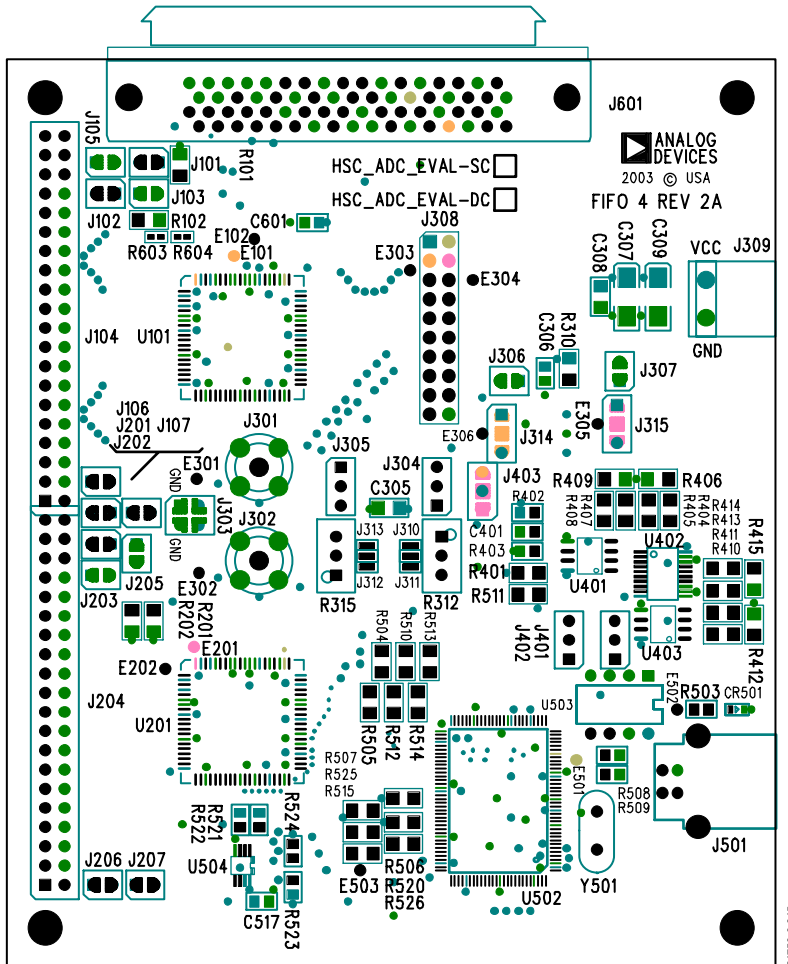

Figure 34. Assembly—Primary Side

HSC-ADC-EVALA-SC/HSC-ADC-EVALA-DC

ASSEMBLY—SECONDARY SIDE

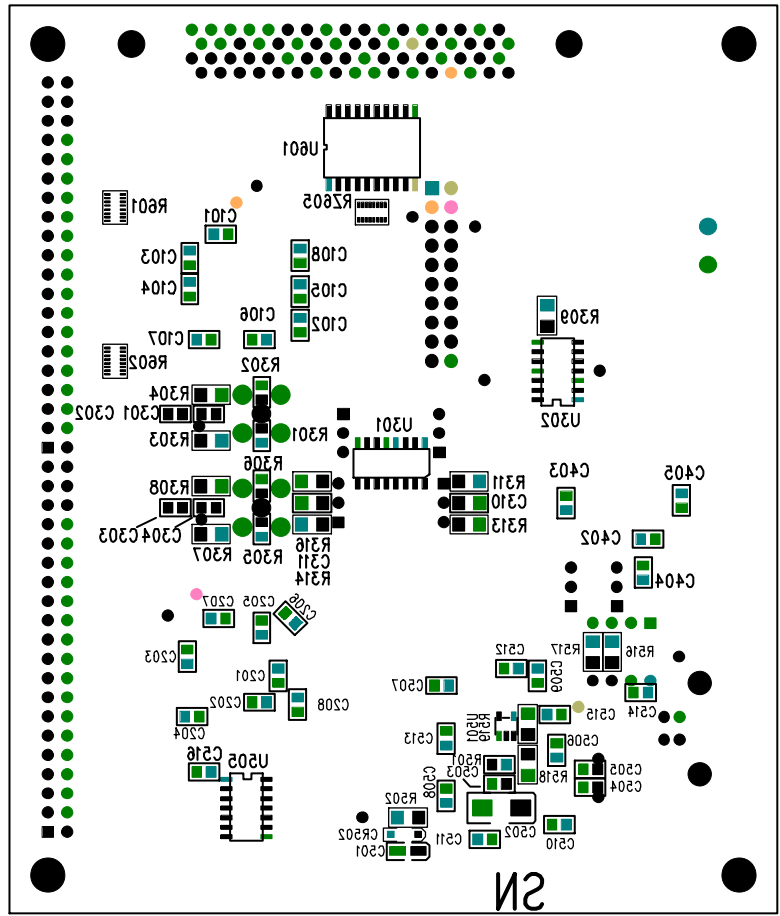

Figure 35. Assembly—Secondary Side

LAYER 1—PRIMARY SIDE

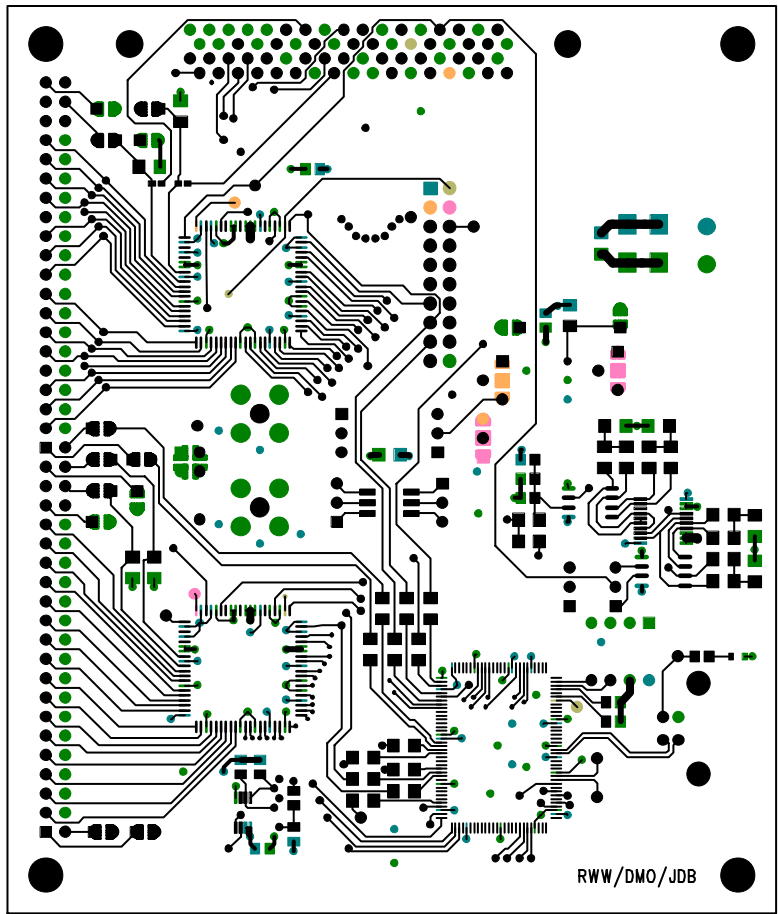
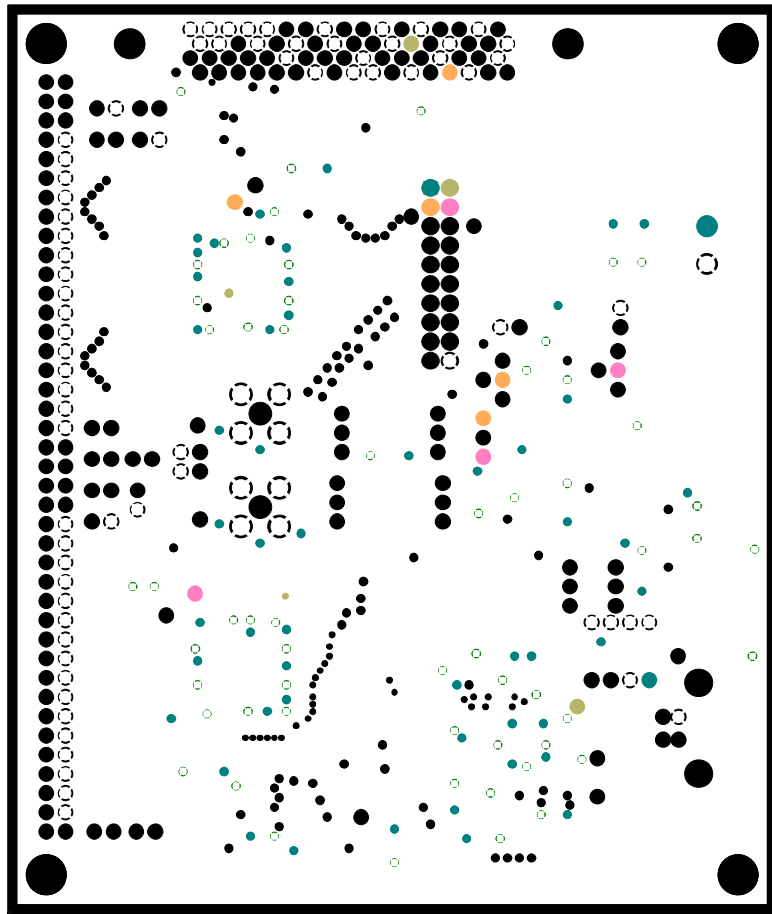

Figure 36. Layer 1—Primary Side

HSC-ADC-EVALA-SC/HSC-ADC-EVALA-DC

LAYER 2—GROUND PLANE



04750-0-048

Figure 37. Layer 2—Ground Plane

LAYER 3—POWER PLANE

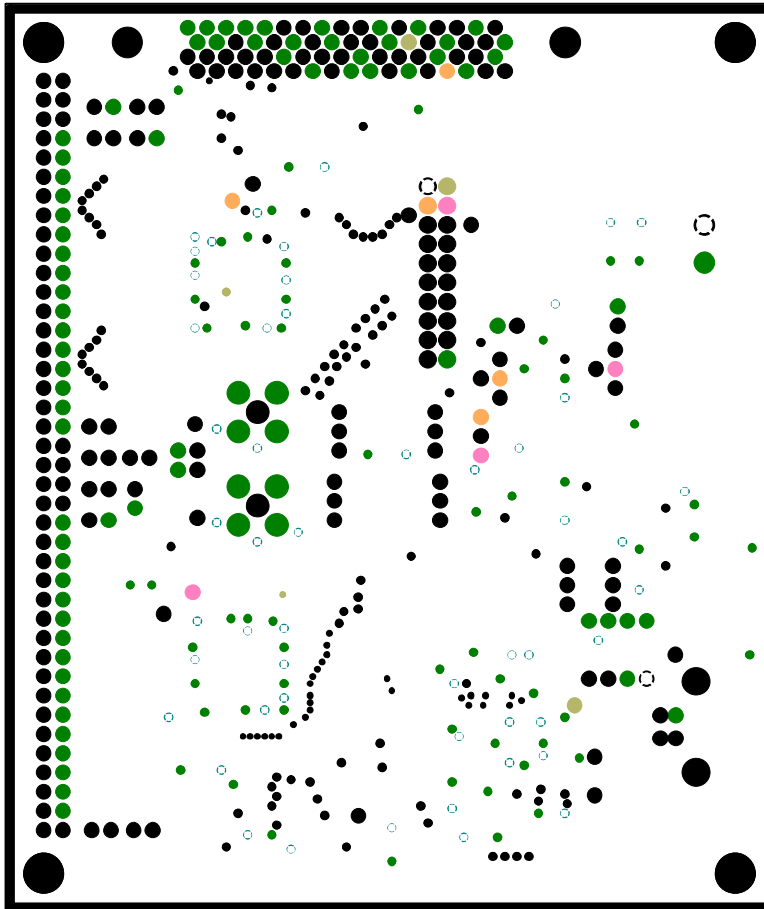

04750-0-048

Figure 38. Layer 3—Power Plane

HSC-ADC-EVALA-SC/HSC-ADC-EVALA-DC

LAYER 4—SECONDARY SIDE

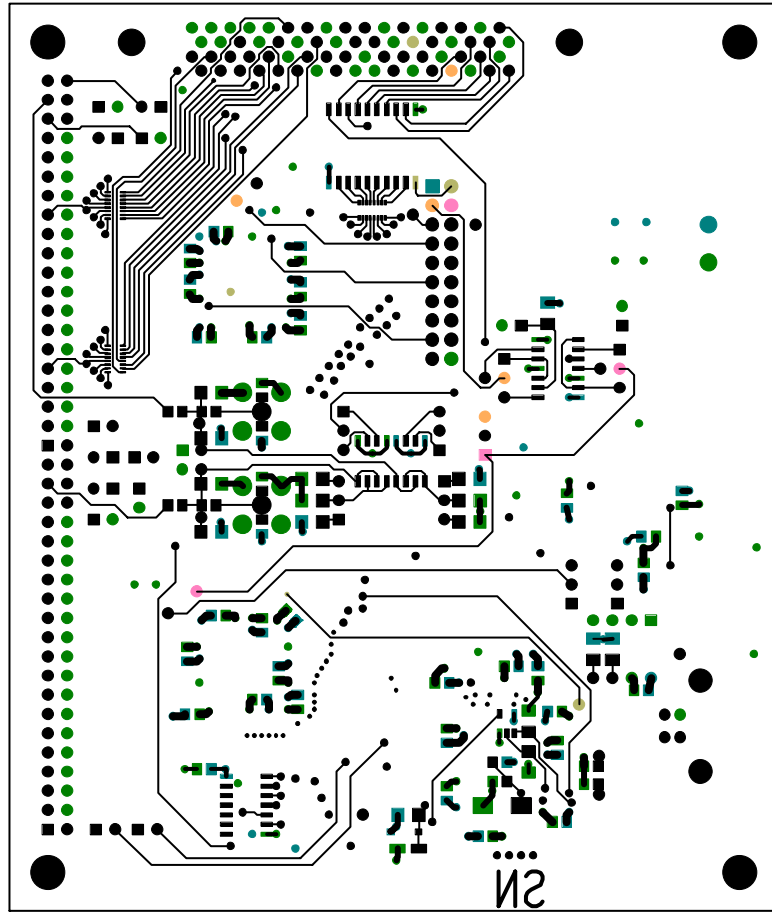

Figure 39. Layer 4—Secondary Side

ESD CAUTION

ESD (electrostatic discharge) sensitive device. Electrostatic charges as high as 4000 V readily accumulate on the human body and test equipment and can discharge without detection. Although this product features proprietary ESD protection circuitry, permanent damage may occur on devices subjected to high energy electrostatic discharges. Therefore, proper ESD precautions are recommended to avoid performance degradation or loss of functionality.



HSC-ADC-EVALA-SC/HSC-ADC-EVALA-DC

BILL OF MATERIALS

Table 5. HSC-ADC-EVAL-SC/HSC-ADC-EVAL-DC Bill of Materials

Item	Quantity		Reference Designation	Description	Package	Value	Manufacture
	SC	DC					
1	39	39	C101–108, C201–208, C301–304, C306, C402–405, C503, C506–517, C601	Capacitor	0805	0.1 μ F	
2	4	4	C305, C308, C310–311	Capacitor, 50 V, 20%	1206	0.1 μ F	
3	2	2	C307 ,C309	Capacitor, 16 V, 10%	6032	10 μ F	
4	1	1	C401	Capacitor, 50 V, 20%	0805	0.001 μ F	
5	1	1	C501	Capacitor, 16 V, 20%	3216	1 μ F	
6	1	1	C502	Capacitor, 20%	6032	2.2 μ F	
7	2	2	C504–505	Capacitor	0805	22 pF	
8	1	1	CR501	LED	0603	Green	
9	1	1	CR502	Diode, 100 V	SOD-123	1N4148W-7	
10	14	14	J101–103, J105–107, J201–203, J205–207, J306–307	2-Pin Jumper Header			
11	1	1	J104/J204	80-Pin Connector Header, Right Angle	Female	SSW-140-03-S-D-RA	
12	1	1	J303	4-Pin Connector, Straight	Male	TSW-1-10-08-GD	
13	7	7	J304–305, J314–315, J401–403	3-Pin Connector, Straight	Male	TWS-103-08-G-S	
14	1	1	J309	2-Pin Terminal Strip, Straight	Male	Z5.530.0225.0	
15	4	4	J310–313	Solder Bridge (No Component)	0508		
16	1	1	J501	4-Pin USB Connector, Right Angle	Female	787780-1	
17	2	2	J301–302	SMA Connector (Not Populated)	Male	142-0701-201	
18	1	1	J308	20-Pin Connector Header, Straight (Not Populated)	Male	TSW-110-08-T-D	
19	1	1	J601	68-Pin Connector, Right Angle (Not Populated)	Male	787082-7	
20	6	6	R101–102, R201–202, R518–519	Resistor, 1/8 W, 1%	1206	10 k Ω	
21	8	8	R303–304, R307–308, R311, R313–314, R316	Resistor, 1/8 W, 1%	1206	331 Ω	
22	2	2	R309–310	Resistor, 1/8 W, 1%	1206	1 k Ω	
23	1	1	R401	Resistor, 1/8 W, 1%	1206	20 k Ω	
24	8	8	R404–405, R407–408, R410–411, R413–414	Resistor, 1/8 W, 1%	1206	49.9 Ω	
25	4	4	R406, R409, R412, R415	Resistor, 1/8 W, 1%	1206	40.2 Ω	
26	2	2	R501, R524	Resistor, 1/10 W, 1%	0805	0 Ω	
27	1	1	R502	Resistor, 1/8 W, 1%	1206	100 k Ω	
28	1	1	R503	Resistor, 1/10 W, 1%	0805	499 Ω	

HSC-ADC-EVALA-SC/HSC-ADC-EVALA-DC

Item	Quantity		Reference Designation	Description	Package	Value	Manufacture
	SC	DC					
29	13	13	R504-507, R510-515, R520, R525-526	Resistor, 1/8 W, 1%	1206	24.9 Ω	
30	2	2	R508-509	Resistor, 1/10 W, 1%	0805	10 kΩ	
31	2	2	R516-517	Resistor, 1/8 W, 1%	1206	2 kΩ	
32	2	2	R521-522	Resistor, 1/10 W, 1%	0805	0 Ω	
33	1	1	R523	Resistor, 1/10 W, 1%	0805	2k Ω	
34	2	2	R603-604	Resistor, 1/16 W, 5%	0402	0 Ω	
35	2	2	R312, R315	Potentiometer, 10%		1 kΩ	
36	6	6	R301-302, R305-306, R402-403	Resistor (Not Populated)			
37	2	2	R601-602	Resistor (Not Populated)			
38	1	1	RZ605	Resistor Array, 8 pcs, 1/4 W, 5%	0402	0 kΩ	
39	1	2	U101, U201	IC	TQFP80	IDT72V283L7-5PF	IDT
40	1	1	U301	IC	SOIC16	DS90LV048ATM	National Semi
41	1	1	U302	IC	SOIC14	74VCX86M	Fairchild
42	1	1	U401	IC	SO8M1	MC100EPT22D	OnSemi
43	1	1	U402	IC	TSSOP20	MC100EP29DT	OnSemi
44	1	1	U403	IC	SO8M1	MC100EPT23D	OnSemi
45	1	1	U501	IC	SOT23L5	NC7SZ32M5	Fairchild
46	1	1	U502	IC	TQFP128	CY7C68013-128AC	Cypress
47	1	1	U503	IC	PDIP8	24LC00P	MicroChip
48	1	1	U504	IC	SSOP8	SN74LVC2G74DCTR	TI
49	1	1	U505	IC	SOIC14	74LVQ04SC	Fairchild
50	1	1	U601	IC		74LCX574WM	Fairchild
51	1	1	Y501	Crystal Oscillator, 24 MHz	2-Pin Can	ECS-240-20-4	ECS

APPENDIX: SAMPLING AND FFT FUNDAMENTALS

COHERENT SAMPLING

In a coherent system, the analog and clock sources must be synchronized, and the analog and clock input frequencies must be selected such that given 2^N (N is an integer number) samples, there is an integer number of whole sine wave cycles. The number of cycles should ideally be a prime number. Selecting a prime number ensures that the same converter codes are not repeated over and over, therefore exercising as many converter codes as possible. Although a crystal oscillator can be used as an clock source in this technique, two synchronized signal synthesizers are generally preferred because special hardware may be required to ensure the crystal oscillator is synchronized with the analog source. The following equation can be used to mathematically calculate the correct analog and clock frequencies for a coherent system:

$$\frac{f_{in}}{f_s} = \frac{M}{Mc}$$

where:

f_{in} = Analog Input Frequency

f_s = Sampling Clock (encode) Frequency

M = Sample Size (2^N)

Mc = Number of Cycles of Sine Wave

If the requirements of the coherent system defined above are not met, the discrete time samples will appear discontinuous at the end of the captured samples and the results will be invalid.

WINDOWING FUNCTIONS

It is sometimes desirable to use a windowing function instead of coherent sampling to reduce the restrictions on the analog and encode sources. Two popular windowing functions are the Blackman Harris 4-Term and the Hanning window. With windowing, the time-domain samples are multiplied by the appropriate weighting function that weights the time-domain data such that the discontinuities at the end of the captured samples have less significance. The weighting function for a Blackman Harris 4-Term window is:

$$W_n = a_0 - a_1 \times \cos\left(\frac{2\pi \times n}{M}\right) + a_2 \times \cos\left(\frac{2\pi \times 2n}{M}\right) - a_3 \times \cos\left(\frac{2\pi \times 3n}{M}\right)$$

where:

$$a_0 = 0.35875$$

$$a_1 = 0.48829$$

$$a_2 = 0.14128$$

$$a_3 = 0.01168$$

M = Sample Size (2^N)

n = Indexed Sample Number

The weighting function for a Hanning window is:

$$W_n = 0.5 - 0.5 \times \cos\left(\frac{2\pi \times n}{M}\right)$$

where:

M = Sample Size (2^N)

n = Indexed Sample Number

FFT CALCULATIONS

Whether a system is coherent or a windowing function has been applied, the resulting data will be processed via a discrete fourier analysis that translates the discrete time-domain samples into the frequency domain. Because in practice processing the data quickly is desired, a Fast Fourier Transform (FFT) is used, which is simply an algorithm that reduces the required mathematical calculations. There are many FFT algorithms available but the most popular is the radix 2 algorithm. Regardless of the algorithm, for each time-domain sample a complex conjugate pair ($r \pm jx$) will be generated from the FFT. For example, if the time-domain sample size is 16,384, the resulting FFT array will contain 16,384 complex samples. To generate a frequency domain plot from this data, the magnitude of each complex sample must be calculated. The magnitude can be computed using the following equation:

$$Magnitude = \sqrt{Re^2 + Im^2}$$

If the input data to the FFT is complex, the FFT will contain 16,384 magnitudes representing frequencies between plus and minus $f_s/2$. Although complex ADCs are not available, it is very common to use two ADCs to synchronously sample the I and Q data streams from a quadrature demodulator. If the data input to the FFT is real, representing the data from a single ADC, the last 8192 samples represent a mirror image of the first 8192 samples. Because this is an exact mirror image, the last 8192 samples can be ignored.

With the data set processed, there are two ways to evaluate the ADC performance, graphically and computationally. To plot the data in a meaningful way, the magnitude data must be converted to decibels (dB). This can be done with the formula:

$$dB = 10 \times \log_{10}\left(\frac{Magnitude}{FullScale}\right)$$

where *Magnitude* is the individual array elements computed above, and *FullScale* is the FullScale magnitude. It is important to note that the computation for dB assumes the square root

HSC-ADC-EVALA-SC/HSC-ADC-EVALA-DC

was not actually taken in the equation above, leaving the magnitude expressed as the sum of two squares. Therefore $10 \times \log$ is used instead of $20 \times \log$, eliminating the time required to compute the square root.

Based on Nyquist Theory, the encode rate must be at least twice the signal bandwidth to faithfully represent the signal when sampled. Therefore, if the encode rate is 80 MHz, an ADC can only represent 40 MHz of continuous bandwidth. Knowing the encode rate and the number of time-domain samples, the frequency representation per bin can be established. In this example, the encode rate is 80 MHz and there are 16,384 time-domain samples; therefore, 4880 Hz/bin is represented. If the encode rate is doubled or the number of time-domain samples is doubled, a 3 dB improvement in the noise floor is observed. This does not represent an improvement in ADC performance, but simply represents an increased resolution per bin.

From the computations above, it is now possible to define and calculate SNR, SINAD, harmonics, SFDR, ENOB, and noise figure. The signal-to-noise ratio can be expressed as the ratio of the rms signal amplitude to the rms value of the sum of all other spectral components, excluding the first six harmonics and dc, or by the equation:

$$SNR = 20 \times \log_{10} \left(\frac{Fundamental_Energy}{Noise_Energy} \right) dB$$

Noise_Energy represents the summation of all the noise energy in the spectrum, and *Fundamental_Energy* represents the summation of the fundamental energy. The fundamental energy resides in a single bin if a coherent system is used; however, in the case of a windowing function, it may be spread over 10 to 25 bins, depending on the windowing technique.

Harmonics can be defined as the ratio of the rms signal amplitude to the rms value of the harmonic component, reported in dBc. Harmonics represent the nonlinearities within the ADC and are integer multiples of the fundamental. If the harmonic exceeds $fs/2$, it will be aliased back into the first Nyquist zone. A concept closely related to harmonics is SFDR. For an ADC, SFDR is defined as the ratio between the rms amplitude of a single tone and the rms amplitude of the worst spur as the tone is swept through the entire ADC input range. It is very common for the worst spur to be harmonically related.

Whereas SNR excludes the first five harmonics, SINAD includes these harmonics as part of the *Noise_Energy* summation, otherwise known as THD or Total Harmonic Distortion. If the harmonic performance of the ADC is excellent, there is very little difference between the SNR value and the SINAD value.

ORDERING GUIDE

Model	Description
HSC-ADC-EVALA-SC	Single FIFO Version of USB Evaluation Kit
HSC-ADC-EVALA-DC	Dual FIFO Version of USB Evaluation Kit
AD922XFFA ¹	Adapter for AD922x Family (Not included in Evaluation Kit)
AD664XFFA ^{1,2}	Adapter for AD664x Family (Not included in Evaluation Kit)
AD9432FFA ¹	Adapter for the AD9432 (Not included in Evaluation Kit)
AD9283FFA ¹	Adapter for the AD9283 and AD9057 (Not included in Evaluation Kit)
AD9071FFA ¹	Adapter for the AD9071 (Not included in Evaluation Kit)
AD9059FFA ¹	Adapter for the AD9059 (Not included in Evaluation Kit)
AD9051FFA ¹	Adapter for the AD9051 (Not included in Evaluation Kit)
LG-0204A ¹	Adapter for the AD10xxx and AD13xxx Families (Not included in Evaluation Kit)

¹ If an adapter is needed, send an email to highspeed.converters@analog.com with the part number of the adapter and a mailing address.

² Required for Revision C of AD6644 and AD6645 evaluation boards. Revision D and greater are directly compatible with e HSC-ADC-EVALA-SC evaluation board



Стандарт Электрон Связь

Мы молодая и активно развивающаяся компания в области поставок электронных компонентов. Мы поставляем электронные компоненты отечественного и импортного производства напрямую от производителей и с крупнейших складов мира.

Благодаря сотрудничеству с мировыми поставщиками мы осуществляем комплексные и плановые поставки широчайшего спектра электронных компонентов.

Собственная эффективная логистика и склад в обеспечивает надежную поставку продукции в точно указанные сроки по всей России.

Мы осуществляем техническую поддержку нашим клиентам и предпродажную проверку качества продукции. На все поставляемые продукты мы предоставляем гарантию .

Осуществляем поставки продукции под контролем ВП МО РФ на предприятия военно-промышленного комплекса России , а также работаем в рамках 275 ФЗ с открытием отдельных счетов в уполномоченном банке. Система менеджмента качества компании соответствует требованиям ГОСТ ISO 9001.

Минимальные сроки поставки, гибкие цены, неограниченный ассортимент и индивидуальный подход к клиентам являются основой для выстраивания долгосрочного и эффективного сотрудничества с предприятиями радиоэлектронной промышленности, предприятиями ВПК и научно-исследовательскими институтами России.

С нами вы становитесь еще успешнее!

Наши контакты:

Телефон: +7 812 627 14 35

Электронная почта: sales@st-electron.ru

Адрес: 198099, Санкт-Петербург,
Промышленная ул, дом № 19, литера Н,
помещение 100-Н Офис 331