6A High-Speed Power MOSFET Drivers

Features

- High Peak Output Current: 6.0A (typical)
- Low Shoot-Through/Cross-Conduction Current in Output Stage
- Wide Input Supply Voltage Operating Range:
 - 4.5V to 18V
- High Capacitive Load Drive Capability:
 - 2500 pF in 20 ns
 - 6800 pF in 40 ns
- Short Delay Times: 40 ns (typical)
- Matched Rise/Fall Times
- Low Supply Current:
 - With Logic '1' Input – 130 μ A (typical)
 - With Logic '0' Input – 35 μ A (typical)
- Latch-Up Protected: Will Withstand 1.5A Reverse Current
- Logic Input Will Withstand Negative Swing Up to 5V
- Pin compatible with the TC4420/TC4429 devices
- Space-saving 8-Pin SOIC, PDIP and 8-Pin 6x5 DFN Packages

Applications

- Switch Mode Power Supplies
- Pulse Transformer Drive
- Line Drivers
- Motor and Solenoid Drive

General Description

The MCP1406/07 devices are a family of buffers/MOSFET drivers that feature a single-output with 6A peak drive current capability, low shoot-through current, matched rise/fall times and propagation delay times. These devices are pin-compatible and are improved versions of the TC4420/TC4429 MOSFET drivers.

The MCP1406/07 MOSFET drivers can easily charge and discharge 2500 pF gate capacitance in under 20 ns, provide low enough impedances (in both the on and off states) to ensure that intended state of the MOSFETs will not be affected, even by large transients. The input to the MCP1406/07 may be driven directly from either TTL or CMOS (3V to 18V).

These devices are highly latch-up resistant under any conditions that within their power and voltage ratings. They are not subject to damage when up to 5V of noise spiking (of either polarity) occurs on the ground pin.

The MCP1406/07 single-output 6A MOSFET driver family is offered in both surface-mount and pin-through-hole packages with a -40°C to +125°C temperature rating, making it useful in any wide-temperature-range application.

MCP1406/07

Package Types

8-Pin PDIP/SOIC

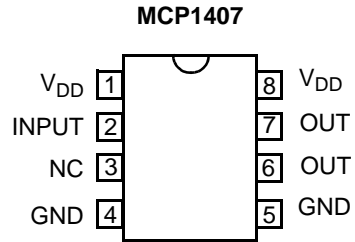
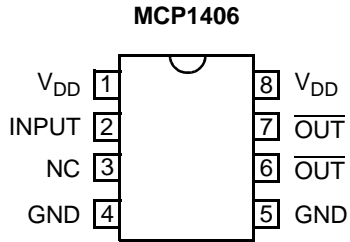

8-Pin 6x5 DFN

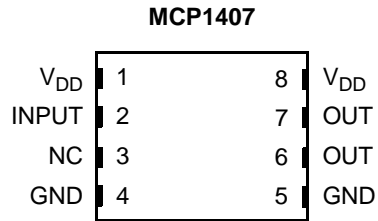
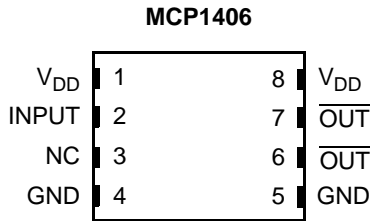

5-Pin TO-220

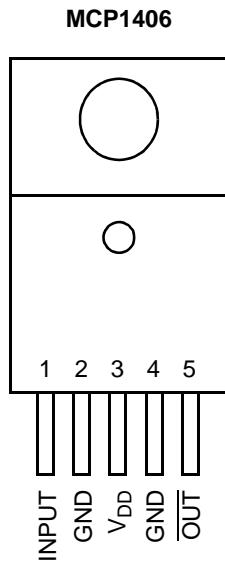

Tab is common to V_{DD}

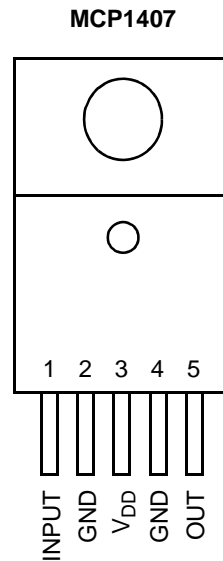

Note 1: Duplicate pins must both be connected for proper operation.

2: Exposed pad of the DFN package is electrically isolated.

Functional Block Diagram⁽¹⁾

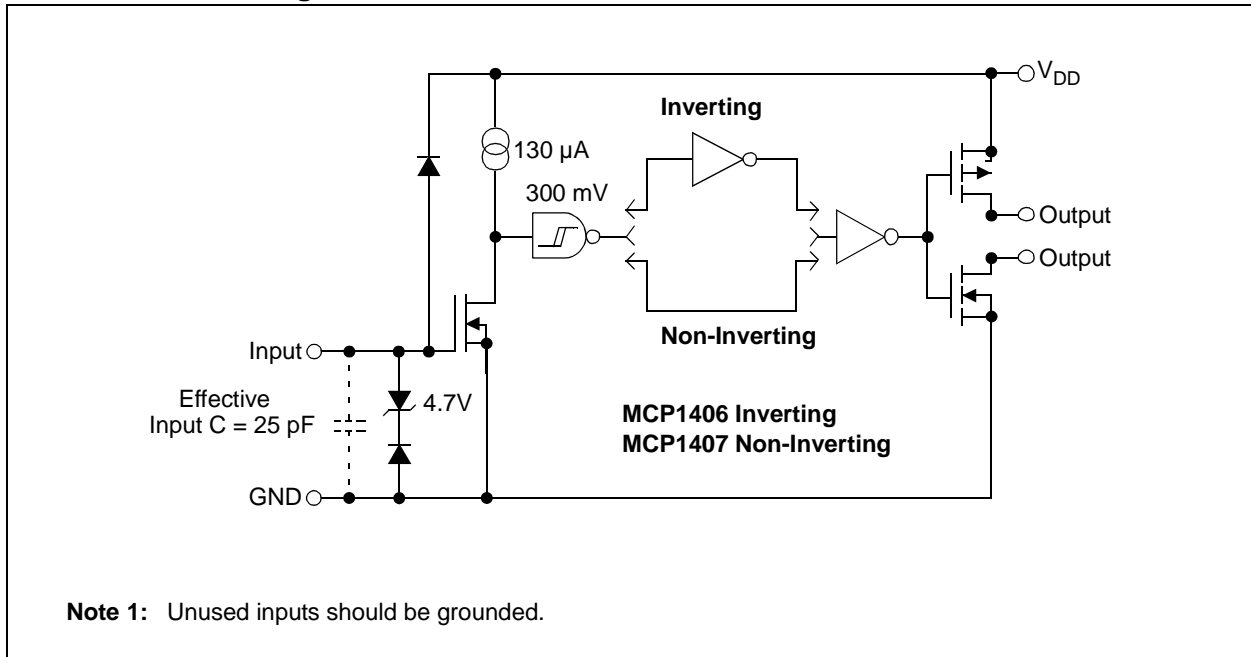

MCP1406/07

1.0 ELECTRICAL CHARACTERISTICS

Absolute Maximum Ratings †

Supply Voltage	+20V
Input Voltage	($V_{DD} + 0.3V$) to (GND – 5V)
Input Current ($V_{IN} > V_{DD}$)	50 mA

† **Notice:** Stresses above those listed under “Maximum Ratings” may cause permanent damage to the device. This is a stress rating only and functional operation of the device at those or any other conditions above those indicated in the operational sections of this specification is not intended. Exposure to maximum rating conditions for extended periods may affect device reliability.

DC CHARACTERISTICS

Electrical Specifications: Unless otherwise indicated, $T_A = +25^\circ\text{C}$, with $4.5V \leq V_{DD} \leq 18V$.						
Parameters	Sym	Min	Typ	Max	Units	Conditions
Input						
Logic '1', High Input Voltage	V_{IH}	2.4	1.8	—	V	
Logic '0', Low Input Voltage	V_{IL}	—	1.3	0.8	V	
Input Current	I_{IN}	-10	—	10	μA	$0V \leq V_{IN} \leq V_{DD}$
Input Voltage	V_{IN}	-5	—	$V_{DD}+0.3$	V	
Output						
High Output Voltage	V_{OH}	$V_{DD} - 0.025$	—	—	V	DC Test
Low Output Voltage	V_{OL}	—	—	0.025	V	DC Test
Output Resistance, High	R_{OH}	—	2.1	2.8	Ω	$I_{OUT} = 10 \text{ mA}$, $V_{DD} = 18V$
Output Resistance, Low	R_{OL}	—	1.5	2.5	Ω	$I_{OUT} = 10 \text{ mA}$, $V_{DD} = 18V$
Peak Output Current	I_{PK}	—	6	—	A	$V_{DD} = 18V$ (Note 2)
Continuous Output Current	I_{DC}	1.3	—	—	A	Note 2, Note 3
Latch-Up Protection Withstand Reverse Current	I_{REV}	—	1.5	—	A	Duty cycle $\leq 2\%$, $t \leq 300 \mu\text{sec}$.
Switching Time (Note 1)						
Rise Time	t_R	—	20	30	ns	Figure 4-1, Figure 4-2 $C_L = 2500 \text{ pF}$
Fall Time	t_F	—	20	30	ns	Figure 4-1, Figure 4-2 $C_L = 2500 \text{ pF}$
Delay Time	t_{D1}	—	40	55	ns	Figure 4-1, Figure 4-2
Delay Time	t_{D2}	—	40	55	ns	Figure 4-1, Figure 4-2
Power Supply						
Supply Voltage	V_{DD}	4.5	—	18.0	V	
Power Supply Current	I_S	—	130	250	μA	$V_{IN} = 3V$
	I_S	—	35	100	μA	$V_{IN} = 0V$

- Note 1:** Switching times ensured by design.
2: Tested during characterization, not production tested.
3: Valid for AT and MF packages only. $T_A = +25^\circ\text{C}$

DC CHARACTERISTICS (OVER OPERATING TEMPERATURE RANGE)

Electrical Specifications: Unless otherwise indicated, operating temperature range with $4.5V \leq V_{DD} \leq 18V$.						
Parameters	Sym	Min	Typ	Max	Units	Conditions
Input						
Logic '1', High Input Voltage	V_{IH}	2.4	—	—	V	
Logic '0', Low Input Voltage	V_{IL}	—	—	0.8	V	
Input Current	I_{IN}	-10	—	+10	μA	$0V \leq V_{IN} \leq V_{DD}$
Input Voltage	V_{IN}	-5	—	$V_{DD}+0.3$	V	
Output						
High Output Voltage	V_{OH}	$V_{DD} - 0.025$	—	—	V	DC TEST
Low Output Voltage	V_{OL}	—	—	0.025	V	DC TEST
Output Resistance, High	R_{OH}	—	3.0	5.0	Ω	$I_{OUT} = 10 \text{ mA}, V_{DD} = 18V$
Output Resistance, Low	R_{OL}	—	2.3	5.0	Ω	$I_{OUT} = 10 \text{ mA}, V_{DD} = 18V$
Switching Time (Note 1)						
Rise Time	t_R	—	25	40	ns	Figure 4-1, Figure 4-2 $C_L = 2500 \text{ pF}$
Fall Time	t_F	—	25	40	ns	Figure 4-1, Figure 4-2 $C_L = 2500 \text{ pF}$
Delay Time	t_{D1}	—	50	65	ns	Figure 4-1, Figure 4-2
Delay Time	t_{D2}	—	50	65	ns	Figure 4-1, Figure 4-2
Power Supply						
Supply Voltage	V_{DD}	4.5	—	18.0	V	
Power Supply Current	I_S	—	200	500	μA	$V_{IN} = 3V$
		—	50	150		$V_{IN} = 0V$

Note 1: Switching times ensured by design.

TEMPERATURE CHARACTERISTICS

Electrical Specifications: Unless otherwise noted, all parameters apply with $4.5V \leq V_{DD} \leq 18V$.						
Parameters	Sym	Min	Typ	Max	Units	Conditions
Temperature Ranges						
Specified Temperature Range	T_A	-40	—	+125	$^{\circ}C$	
Maximum Junction Temperature	T_J	—	—	+150	$^{\circ}C$	
Storage Temperature Range	T_A	-65	—	+150	$^{\circ}C$	
Package Thermal Resistances						
Thermal Resistance, 8L-6x5 DFN	θ_{JA}	—	33.2	—	$^{\circ}C/W$	Typical four-layer board with vias to ground plane
Thermal Resistance, 8L-PDIP	θ_{JA}	—	125	—	$^{\circ}C/W$	
Thermal Resistance, 8L-SOIC	θ_{JA}	—	155	—	$^{\circ}C/W$	
Thermal Resistance, 5L-TO-220	θ_{JA}	—	71	—	$^{\circ}C/W$	

MCP1406/07

2.0 TYPICAL PERFORMANCE CURVES

Note: The graphs and tables provided following this note are a statistical summary based on a limited number of samples and are provided for informational purposes only. The performance characteristics listed herein are not tested or guaranteed. In some graphs or tables, the data presented may be outside the specified operating range (e.g., outside specified power supply range) and therefore outside the warranted range.

Note: Unless otherwise indicated, $T_A = +25^\circ\text{C}$ with $4.5\text{V} \leq V_{DD} \leq 18\text{V}$.

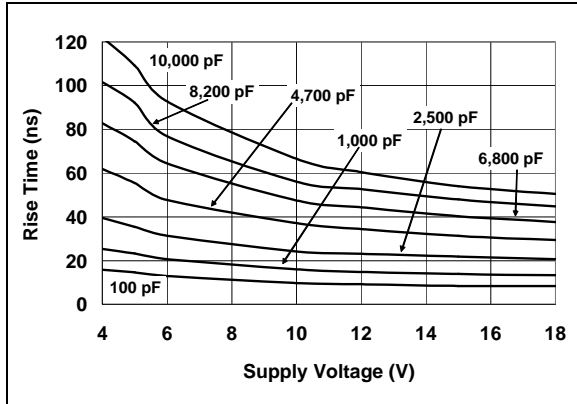

FIGURE 2-1: Rise Time vs. Supply Voltage.

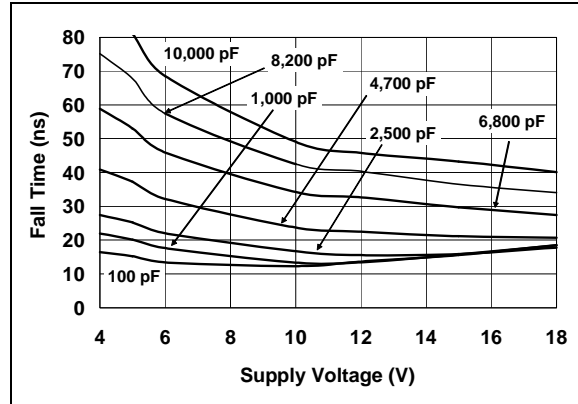

FIGURE 2-4: Fall Time vs. Supply Voltage.

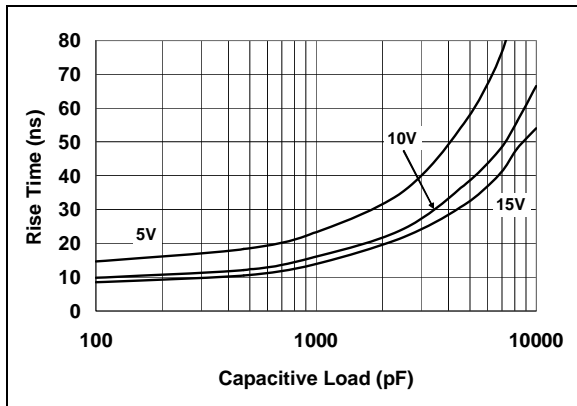

FIGURE 2-2: Rise Time vs. Capacitive Load.

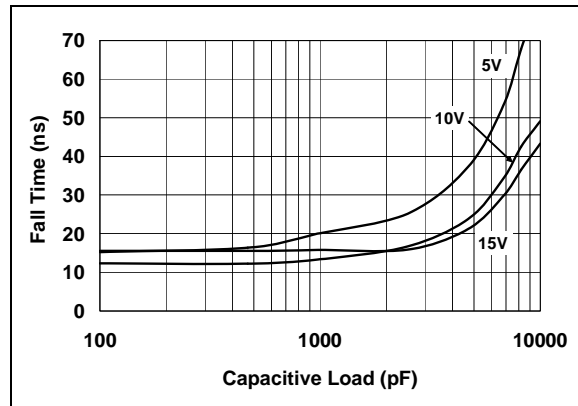

FIGURE 2-5: Fall Time vs. Capacitive Load.

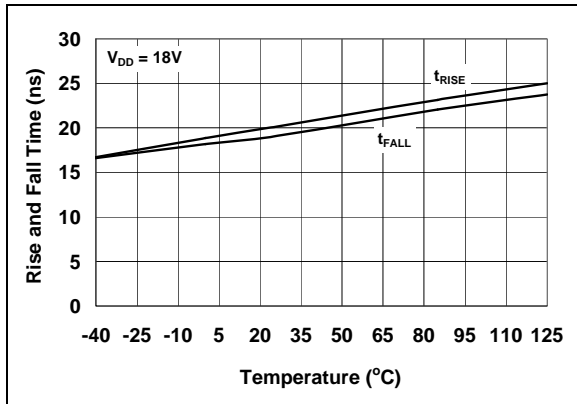

FIGURE 2-3: Rise and Fall Times vs. Temperature.

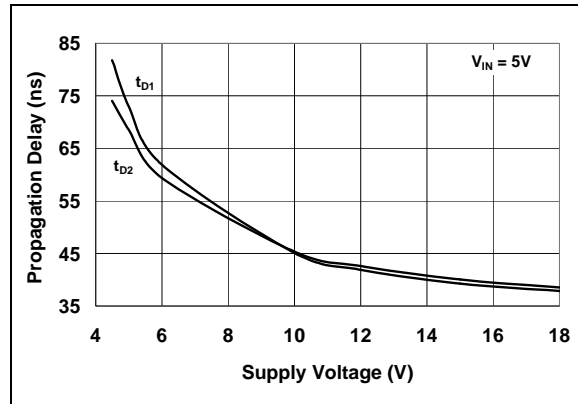

FIGURE 2-6: Propagation Delay vs. Supply Voltage.

Note: Unless otherwise indicated, $T_A = +25^\circ\text{C}$ with $4.5\text{V} \leq V_{DD} \leq 18\text{V}$.

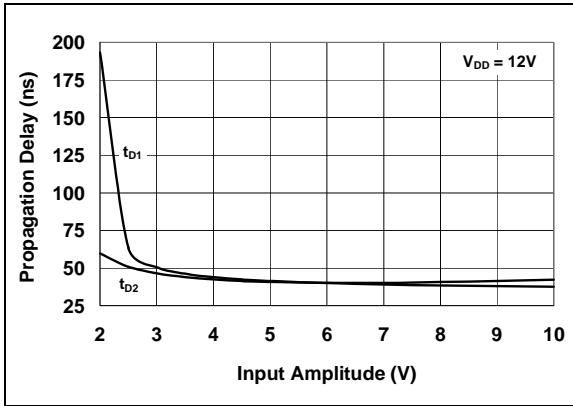

FIGURE 2-7: Propagation Delay Time vs. Input Amplitude.

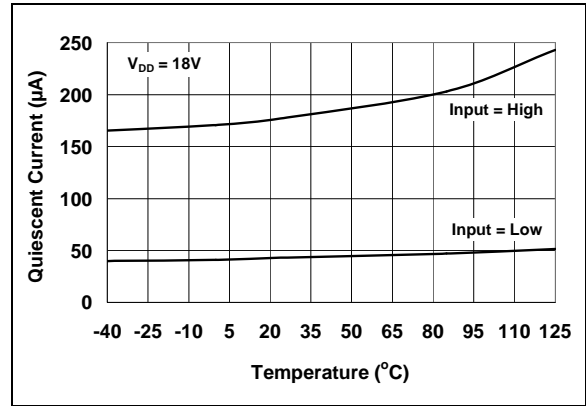

FIGURE 2-10: Quiescent Current vs. Temperature.

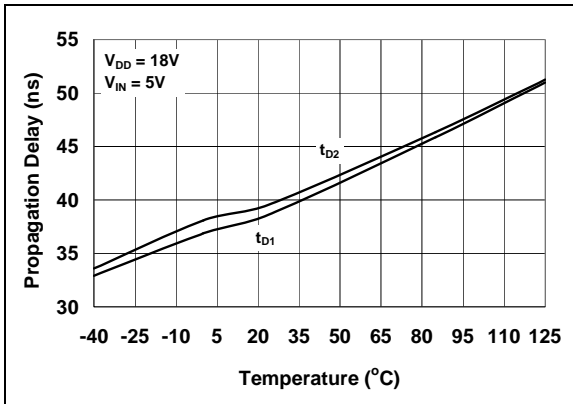

FIGURE 2-8: Propagation Delay Time vs. Temperature.

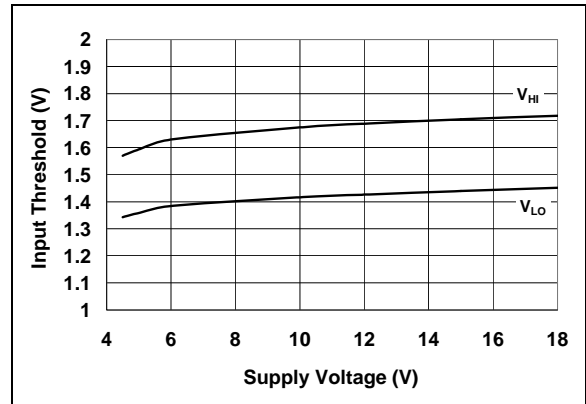

FIGURE 2-11: Input Threshold vs. Supply Voltage.

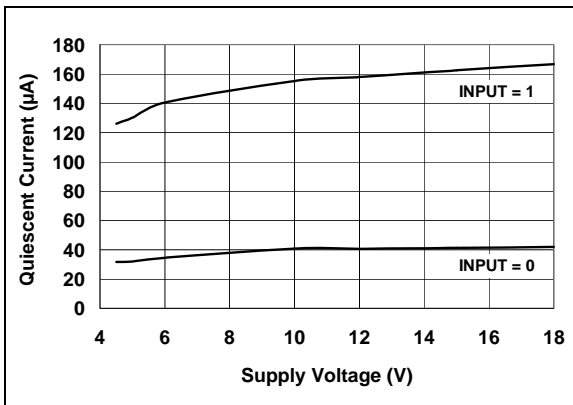

FIGURE 2-9: Quiescent Current vs. Supply Voltage.

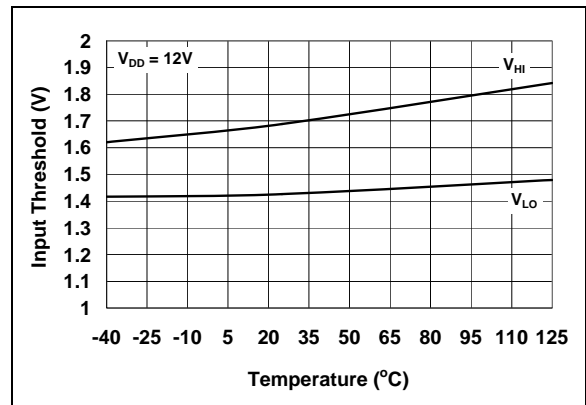

FIGURE 2-12: Input Threshold vs. Temperature.

MCP1406/07

Note: Unless otherwise indicated, $T_A = +25^\circ\text{C}$ with $4.5\text{V} \leq V_{DD} \leq 18\text{V}$.

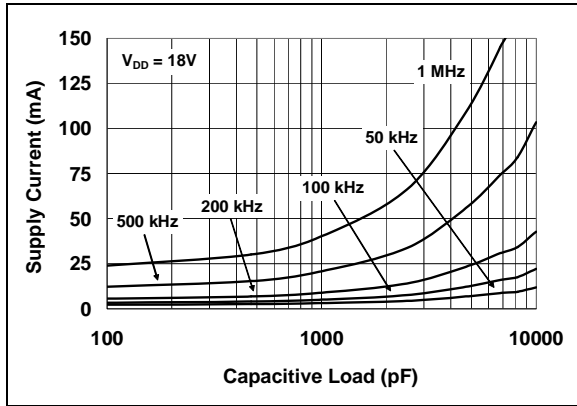

FIGURE 2-13: Supply Current vs. Capacitive Load.

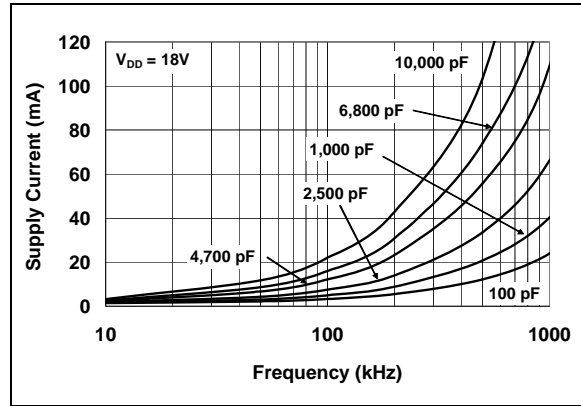

FIGURE 2-16: Supply Current vs. Frequency.

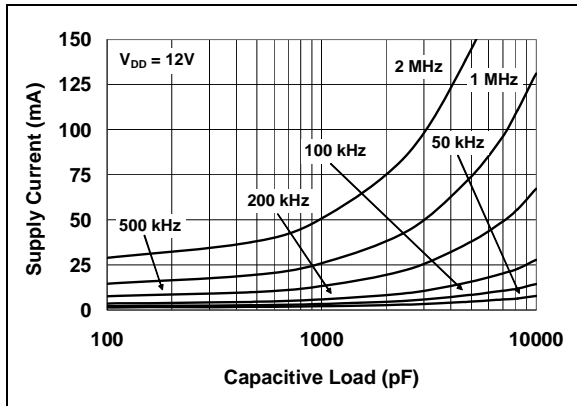

FIGURE 2-14: Supply Current vs. Capacitive Load.

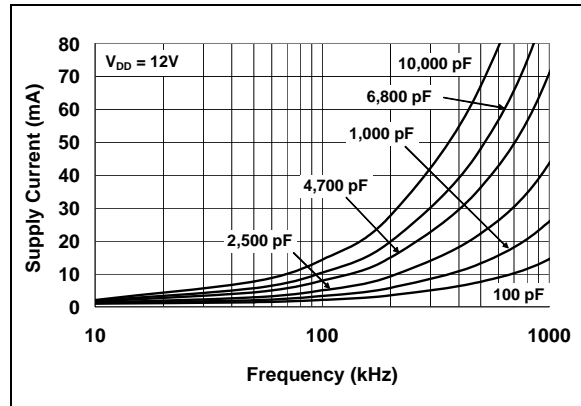

FIGURE 2-17: Supply Current vs. Frequency.

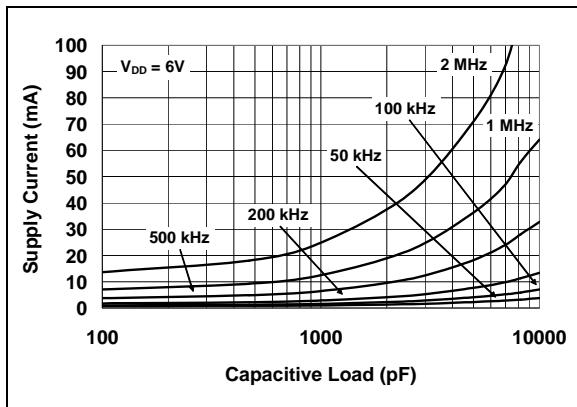

FIGURE 2-15: Supply Current vs. Capacitive Load.

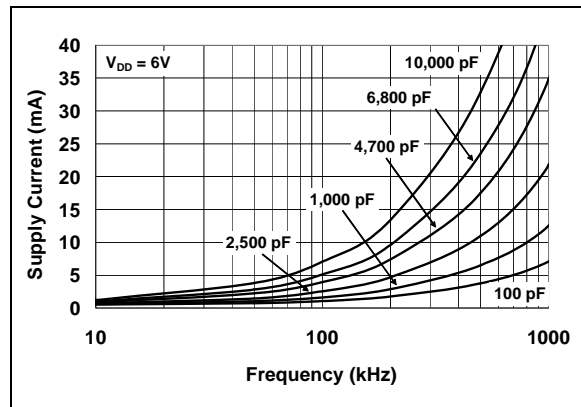

FIGURE 2-18: Supply Current vs. Frequency.

Note: Unless otherwise indicated, $T_A = +25^\circ\text{C}$ with $4.5\text{V} \leq V_{DD} \leq 18\text{V}$.

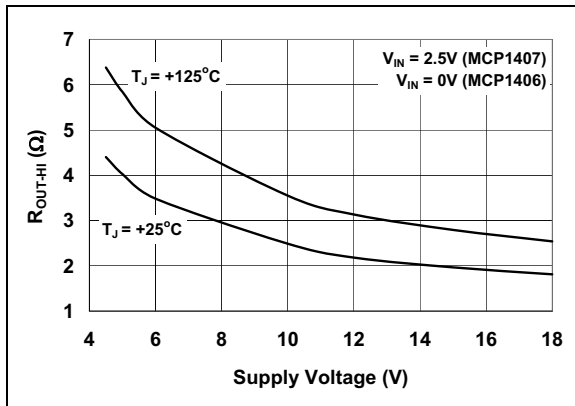

FIGURE 2-19: Output Resistance (Output High) vs. Supply Voltage.

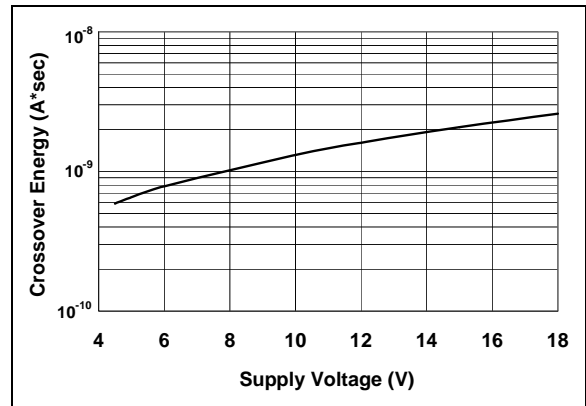

FIGURE 2-21: Crossover Energy vs. Supply Voltage.

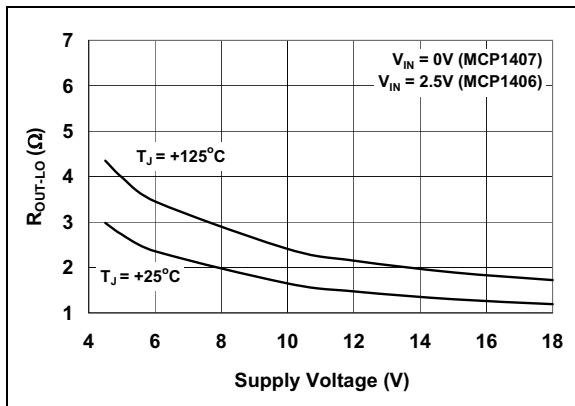

FIGURE 2-20: Output Resistance (Output Low) vs. Supply Voltage.

MCP1406/07

3.0 PIN DESCRIPTIONS

The descriptions of the pins are listed in [Table 3-1](#).

TABLE 3-1: PIN FUNCTION TABLE⁽¹⁾

8-Pin PDIP, SOIC	8-Pin DFN	5-Pin TO-220	Symbol	Description
1	1	—	V _{DD}	Supply Input
2	2	1	INPUT	Control Input
3	3	—	NC	No Connection
4	4	2	GND	Ground
5	5	4	GND	Ground
6	6	5	OUTPUT	CMOS Push-Pull Output
7	7	—	OUTPUT	CMOS Push-Pull Output
8	8	3	V _{DD}	Supply Input
—	PAD	—	NC	Exposed Metal Pad
—	—	TAB	V _{DD}	Metal Tab at V _{DD} Potential

Note 1: Duplicate pins must be connected for proper operation.

3.1 Supply Input (V_{DD})

V_{DD} is the bias supply input for the MOSFET driver and has a voltage range of 4.5V to 18V. This input must be decoupled to ground with local capacitors. The bypass capacitors provide a localized low-impedance path for the peak currents that are to be provided to the load.

3.2 Control Input (INPUT)

The MOSFET driver input is a high-impedance, TTL/CMOS-compatible input. The input also has hysteresis between the high and low input levels, allowing them to be driven from slow rising and falling signals, and to provide noise immunity.

3.3 Ground (GND)

Ground is the device return pin. The ground pin should have a low impedance connection to the bias supply source return. High peak currents will flow out the ground pin when the capacitive load is being discharged.

3.4 CMOS Push-Pull Output (OUTPUT)

The output is a CMOS push-pull output that is capable of sourcing peak currents of 6A (V_{DD} = 18V). The low output impedance ensures the gate of the external MOSFET will stay in the intended state even during large transients. The output pins also have reverse current latch-up ratings of 1.5A.

3.5 Exposed Metal Pad

The exposed metal pad of the DFN package is not internally connected to any potential. Therefore, this pad can be connected to a ground plane or other copper plane on a printed circuit board to aid in heat removal from the package.

3.6 TO-220 Metal Tab

The metal tab on the TO-220 package is at V_{DD} potential. This metal tab is not intended to be the V_{DD} connection to MCP1406/07. V_{DD} should be supplied using the Supply Input pin of the TO-220.

4.0 APPLICATION INFORMATION

4.1 General Information

MOSFET drivers are high-speed, high current devices which are intended to provide high peak currents to charge the gate capacitance of external MOSFETs or IGBTs. In high frequency switching power supplies, the PWM controller may not have the drive capability to directly drive the power MOSFET. A MOSFET driver like the MCP1406/07 family can be used to provide additional drive current capability.

4.2 MOSFET Driver Timing

The ability of a MOSFET driver to transition from a fully-off state to a fully-on state are characterized by the drivers' rise time (t_R), fall time (t_F), and propagation delays (t_{D1} and t_{D2}). The MCP1406/07 family of devices is able to make this transition very quickly. Figure 4-1 and Figure 4-2 show the test circuits and timing waveforms used to verify the MCP1406/07 timing.

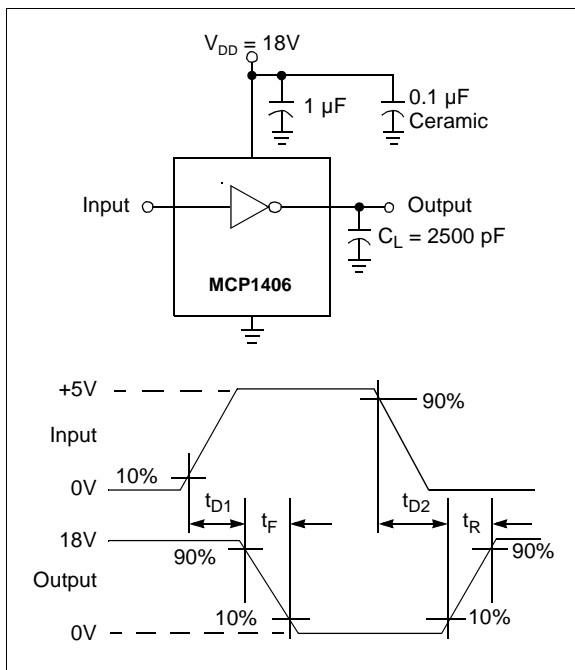

FIGURE 4-1: Inverting Driver Timing Waveform.

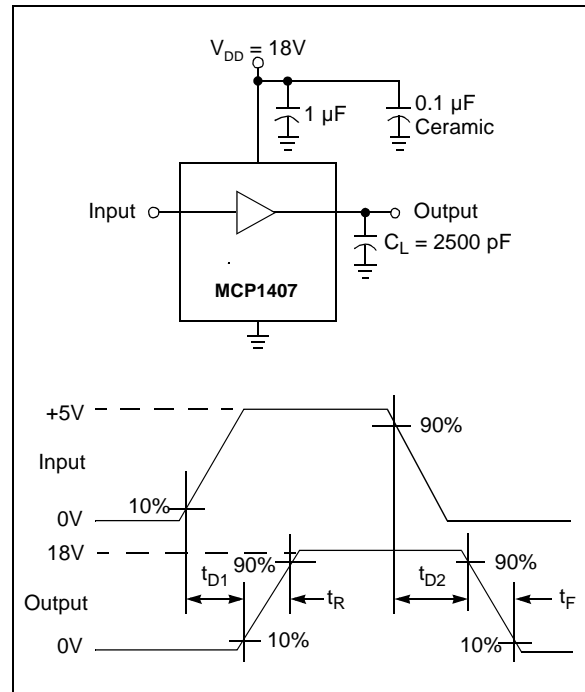

FIGURE 4-2: Non-Inverting Driver Timing Waveform.

4.3 Decoupling Capacitors

Careful layout and decoupling capacitors are highly recommended when using MOSFET drivers. Large currents are required to charge and discharge capacitive loads quickly. For example, 2.25A are needed to charge a 2500 pF load with 18V in 20 ns.

To operate the MOSFET driver over a wide frequency range with low supply impedance, a ceramic and a low ESR film capacitor are recommended to be placed in parallel between the driver V_{DD} and GND. A 1.0 μ F low ESR film capacitor and a 0.1 μ F ceramic capacitor placed between pins 1, 8 and 4, 5 should be used. These capacitors should be placed close to the driver to minimize circuit board parasitics and provide a local source for the required current.

MCP1406/07

4.4 PCB Layout Considerations

Proper PCB layout is important in a high current, fast switching circuit to provide proper device operation and robustness of design. PCB trace loop area and inductance should be minimized by the use of a ground plane or ground trace located under the MOSFET gate drive signals, separate analog and power grounds, and local driver decoupling.

The MCP1406/07 devices have two pins each for V_{DD} , OUTPUT, and GND. Both pins must be used for proper operation. This also lowers path inductance which will, along with proper decoupling, help minimize ringing in the circuit.

Placing a ground plane beneath the MCP1406/07 will help as a radiated noise shield as well as providing some heat sinking for power dissipated within the device.

4.5 Power Dissipation

The total internal power dissipation in a MOSFET driver is the summation of three separate power dissipation elements.

$$P_T = P_L + P_Q + P_{CC}$$

Where:

P_T = Total power dissipation

P_L = Load power dissipation

P_Q = Quiescent power dissipation

P_{CC} = Operating power dissipation

4.5.1 CAPACITIVE LOAD DISSIPATION

The power dissipation caused by a capacitive load is a direct function of frequency, total capacitive load, and supply voltage. The power lost in the MOSFET driver for a complete charging and discharging cycle of a MOSFET is:

$$P_L = f \times C_T \times V_{DD}^2$$

Where:

f = Switching frequency

C_T = Total load capacitance

V_{DD} = MOSFET driver supply voltage

4.5.2 QUIESCENT POWER DISSIPATION

The power dissipation associated with the quiescent current draw depends upon the state of the input pin. The MCP1406/07 devices have a quiescent current draw when the input is high of 0.13 mA (typ) and 0.035 mA (typ) when the input is low. The quiescent power dissipation is:

$$P_Q = (I_{QH} \times D + I_{QL} \times (1 - D)) \times V_{DD}$$

Where:

I_{QH} = Quiescent current in the high state

D = Duty cycle

I_{QL} = Quiescent current in the low state

V_{DD} = MOSFET driver supply voltage

4.5.3 OPERATING POWER DISSIPATION

The operating power dissipation occurs each time the MOSFET driver output transitions; because, for a very short period of time both MOSFETs in the output stage are on simultaneously. This cross-conduction current leads to a power dissipation, as described by the following equation:

$$P_{CC} = CC \times f \times V_{DD}$$

Where:

CC = Cross-conduction constant (A*sec)

f = Switching frequency

V_{DD} = MOSFET driver supply voltage

5.0 PACKAGING INFORMATION

5.1 Package Marking Information (Not to Scale)

5-Lead TO-220

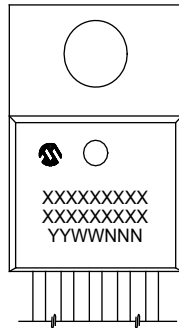

Example

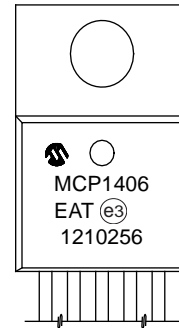

8-Lead DFN-S (6x5x0.9 mm)



Example

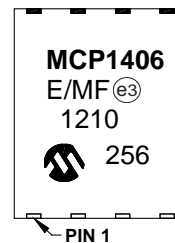

8-Lead PDIP (300 mil)

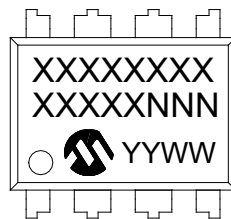

Example

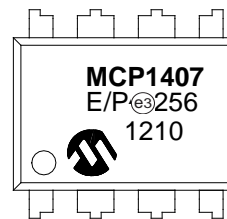

Legend:	XX...X	Customer-specific information
	Y	Year code (last digit of calendar year)
	YY	Year code (last 2 digits of calendar year)
	WW	Week code (week of January 1 is week '01')
	NNN	Alphanumeric traceability code
	(e3)	Pb-free JEDEC designator for Matte Tin (Sn)
	*	This package is Pb-free. The Pb-free JEDEC designator (e3) can be found on the outer packaging for this package.

Note: In the event the full Microchip part number cannot be marked on one line, it will be carried over to the next line, thus limiting the number of available characters for customer-specific information.

MCP1406/07

5.1 Package Marking Information (Continued)

8-Lead SOIC (3.90 mm)

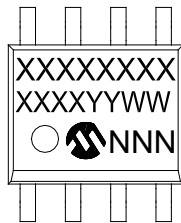

Example

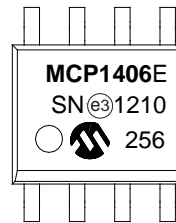

Legend:	XX...X	Customer-specific information
	Y	Year code (last digit of calendar year)
	YY	Year code (last 2 digits of calendar year)
	WW	Week code (week of January 1 is week '01')
	NNN	Alphanumeric traceability code
	^(e3)	Pb-free JEDEC designator for Matte Tin (Sn)
	*	This package is Pb-free. The Pb-free JEDEC designator ^(e3) can be found on the outer packaging for this package.

Note: In the event the full Microchip part number cannot be marked on one line, it will be carried over to the next line, thus limiting the number of available characters for customer-specific information.

5-Lead Plastic Transistor Outline (AT) [TO-220]

Note: For the most current package drawings, please see the Microchip Packaging Specification located at <http://www.microchip.com/packaging>

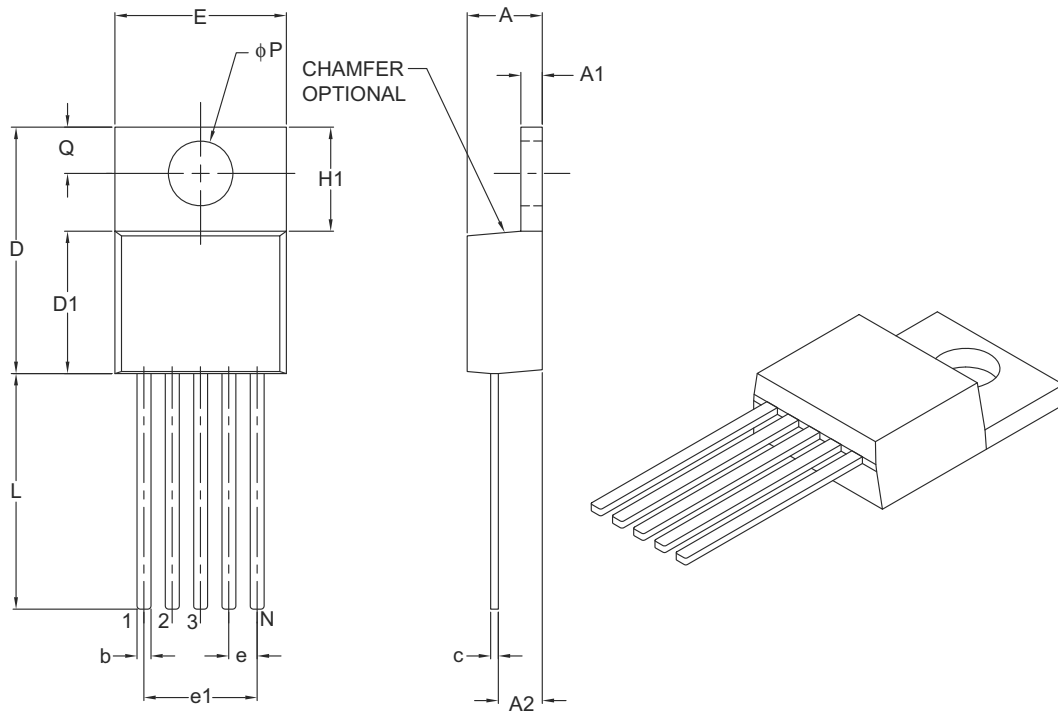

Dimension Limits	Units	INCHES		
		MIN	NOM	MAX
Number of Pins	N	5		
Pitch	e	.067 BSC		
Overall Pin Pitch	e1	.268 BSC		
Overall Height	A	.140	–	.190
Overall Width	E	.380	–	.420
Overall Length	D	.560	–	.650
Molded Package Length	D1	.330	–	.355
Tab Length	H1	.204	–	.293
Tab Thickness	A1	.020	–	.055
Mounting Hole Center	Q	.100	–	.120
Mounting Hole Diameter	φP	.139	–	.156
Lead Length	L	.482	–	.590
Base to Bottom of Lead	A2	.080	–	.115
Lead Thickness	c	.012	–	.025
Lead Width	b	.015	.027	.040

Notes:

- Dimensions D and E do not include mold flash or protrusions. Mold flash or protrusions shall not exceed .005" per side.
- Dimensioning and tolerancing per ASME Y14.5M.

BSC: Basic Dimension. Theoretically exact value shown without tolerances.

Microchip Technology Drawing C04-036B

MCP1406/07

8-Lead Plastic Dual Flat, No Lead Package (MF) – 6x5 mm Body [DFN-S]

Note: For the most current package drawings, please see the Microchip Packaging Specification located at <http://www.microchip.com/packaging>

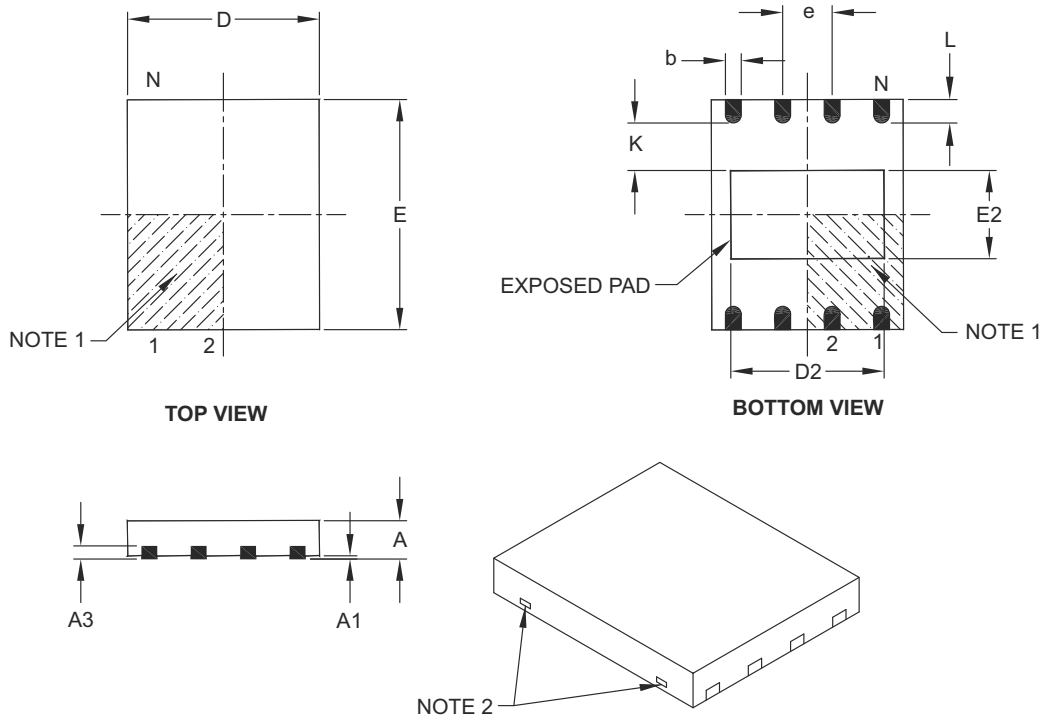

Dimension Limits	Units	MILLIMETERS		
		MIN	NOM	MAX
Number of Pins	N	8		
Pitch	e	1.27 BSC		
Overall Height	A	0.80	0.85	1.00
Standoff	A1	0.00	0.01	0.05
Contact Thickness	A3	0.20 REF		
Overall Length	D	5.00 BSC		
Overall Width	E	6.00 BSC		
Exposed Pad Length	D2	3.90	4.00	4.10
Exposed Pad Width	E2	2.20	2.30	2.40
Contact Width	b	0.35	0.40	0.48
Contact Length	L	0.50	0.60	0.75
Contact-to-Exposed Pad	K	0.20	-	-

Notes:

- Pin 1 visual index feature may vary, but must be located within the hatched area.
- Package may have one or more exposed tie bars at ends.
- Package is saw singulated.
- Dimensioning and tolerancing per ASME Y14.5M.

BSC: Basic Dimension. Theoretically exact value shown without tolerances.

REF: Reference Dimension, usually without tolerance, for information purposes only.

Microchip Technology Drawing C04-122B

8-Lead Plastic Dual Flat, No Lead Package (MF) - 6x5 mm Body [DFN-S]

Note: For the most current package drawings, please see the Microchip Packaging Specification located at <http://www.microchip.com/packaging>

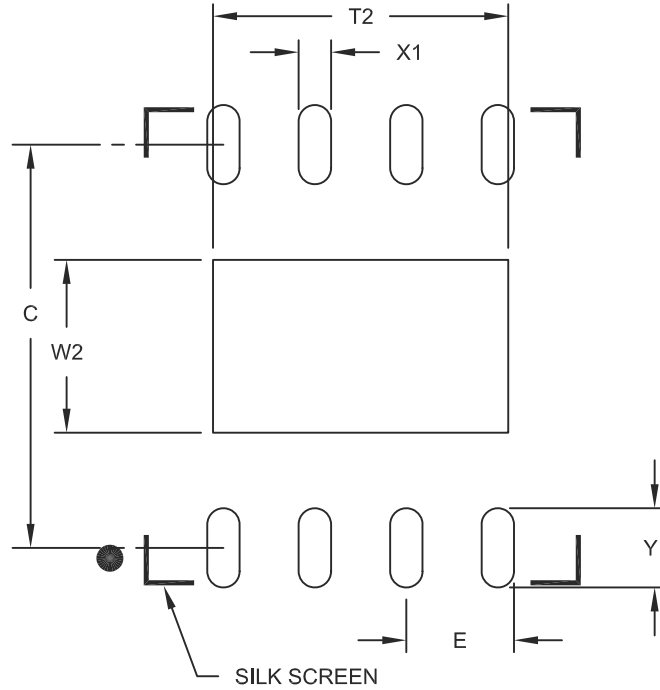

RECOMMENDED LAND PATTERN

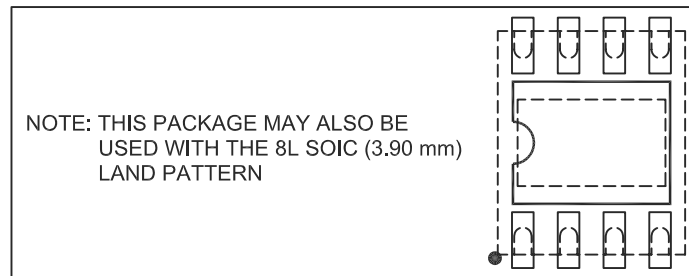

Dimension Limits	Units	MILLIMETERS		
		MIN	NOM	MAX
Contact Pitch	E	1.27 BSC		
Optional Center Pad Width	W2			2.40
Optional Center Pad Length	T2			4.10
Contact Pad Spacing	C		5.60	
Contact Pad Width (X8)	X1			0.45
Contact Pad Length (X8)	Y1			1.10

Notes:

1. Dimensioning and tolerancing per ASME Y14.5M

BSC: Basic Dimension. Theoretically exact value shown without tolerances.

Microchip Technology Drawing No. C04-2122A

MCP1406/07

8-Lead Plastic Dual In-Line (PA) – 300 mil Body [PDIP]

Note: For the most current package drawings, please see the Microchip Packaging Specification located at <http://www.microchip.com/packaging>

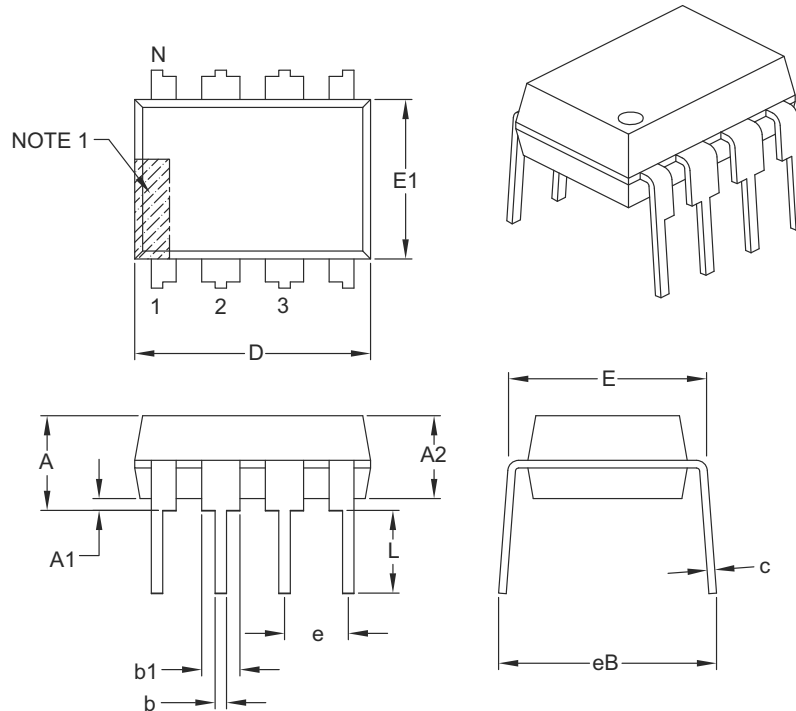

Dimension Limits	Units	INCHES		
		MIN	NOM	MAX
Number of Pins	N	8		
Pitch	e	.100 BSC		
Top to Seating Plane	A	–	–	.210
Molded Package Thickness	A2	.115	.130	.195
Base to Seating Plane	A1	.015	–	–
Shoulder to Shoulder Width	E	.290	.310	.325
Molded Package Width	E1	.240	.250	.280
Overall Length	D	.348	.365	.400
Tip to Seating Plane	L	.115	.130	.150
Lead Thickness	c	.008	.010	.015
Upper Lead Width	b1	.040	.060	.070
Lower Lead Width	b	.014	.018	.022
Overall Row Spacing §	eB	–	–	.430

Notes:

- Pin 1 visual index feature may vary, but must be located with the hatched area.
- § Significant Characteristic.
- Dimensions D and E1 do not include mold flash or protrusions. Mold flash or protrusions shall not exceed .010" per side.
- Dimensioning and tolerancing per ASME Y14.5M.

BSC: Basic Dimension. Theoretically exact value shown without tolerances.

Microchip Technology Drawing C04-018B

8-Lead Plastic Small Outline (SN) - Narrow, 3.90 mm Body [SOIC]

Note: For the most current package drawings, please see the Microchip Packaging Specification located at <http://www.microchip.com/packaging>

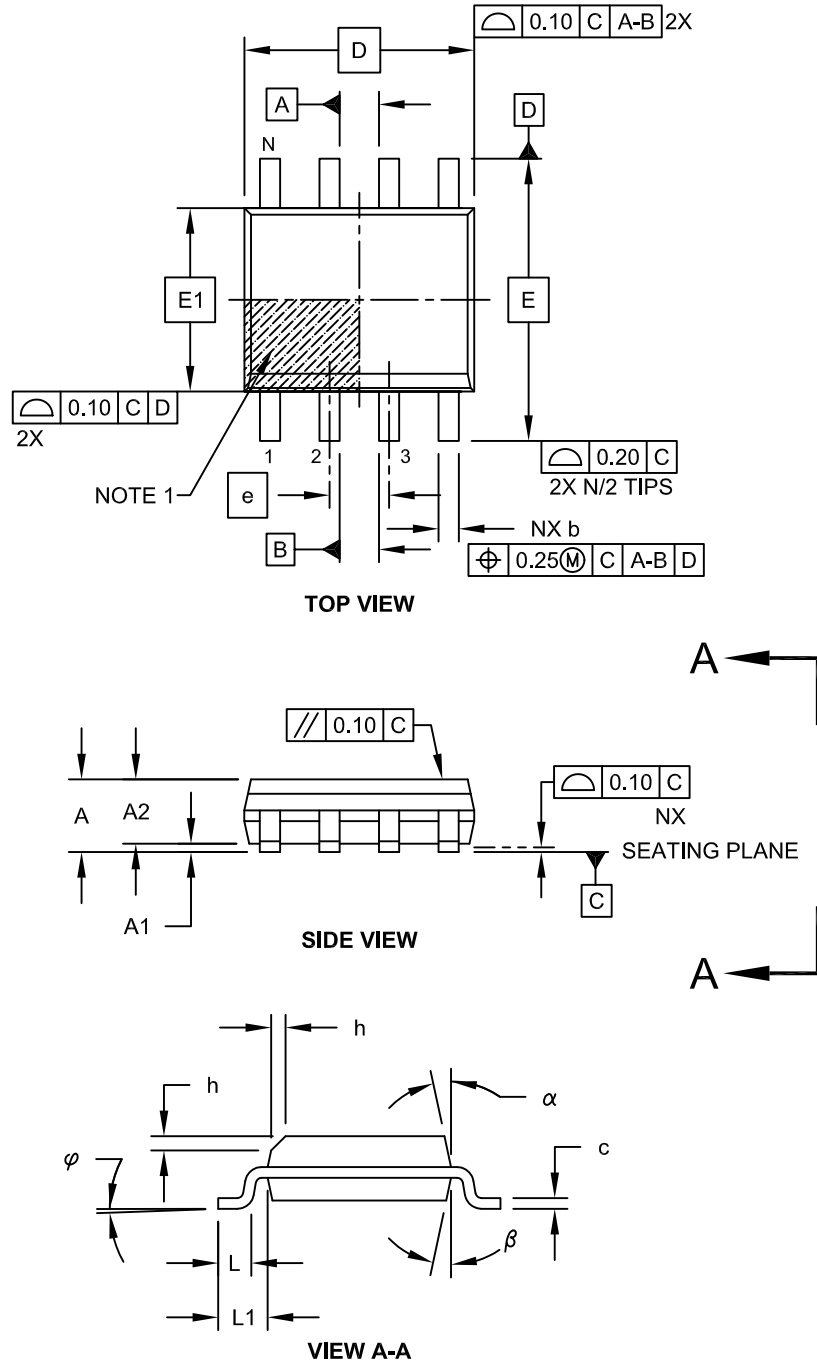

Microchip Technology Drawing No. C04-057C Sheet 1 of 2

MCP1406/07

8-Lead Plastic Small Outline (SN) - Narrow, 3.90 mm Body [SOIC]

Note: For the most current package drawings, please see the Microchip Packaging Specification located at <http://www.microchip.com/packaging>

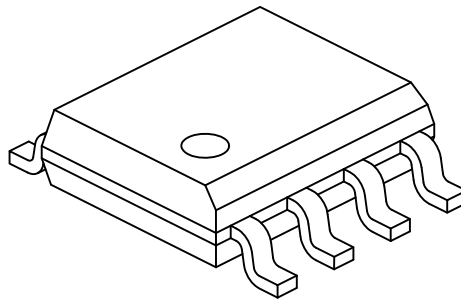

Dimension Limits	Units	MILLIMETERS		
		MIN	NOM	MAX
Number of Pins	N	8		
Pitch	e	1.27 BSC		
Overall Height	A	-	-	1.75
Molded Package Thickness	A2	1.25	-	-
Standoff §	A1	0.10	-	0.25
Overall Width	E	6.00 BSC		
Molded Package Width	E1	3.90 BSC		
Overall Length	D	4.90 BSC		
Chamfer (Optional)	h	0.25	-	0.50
Foot Length	L	0.40	-	1.27
Footprint	L1	1.04 REF		
Foot Angle	φ	0°	-	8°
Lead Thickness	c	0.17	-	0.25
Lead Width	b	0.31	-	0.51
Mold Draft Angle Top	α	5°	-	15°
Mold Draft Angle Bottom	β	5°	-	15°

Notes:

1. Pin 1 visual index feature may vary, but must be located within the hatched area.
2. § Significant Characteristic
3. Dimensions D and E1 do not include mold flash or protrusions. Mold flash or protrusions shall not exceed 0.15mm per side.
4. Dimensioning and tolerancing per ASME Y14.5M

BSC: Basic Dimension. Theoretically exact value shown without tolerances.

REF: Reference Dimension, usually without tolerance, for information purposes only.

Microchip Technology Drawing No. C04-057C Sheet 2 of 2

8-Lead Plastic Small Outline (SN) – Narrow, 3.90 mm Body [SOIC]

Note: For the most current package drawings, please see the Microchip Packaging Specification located at <http://www.microchip.com/packaging>

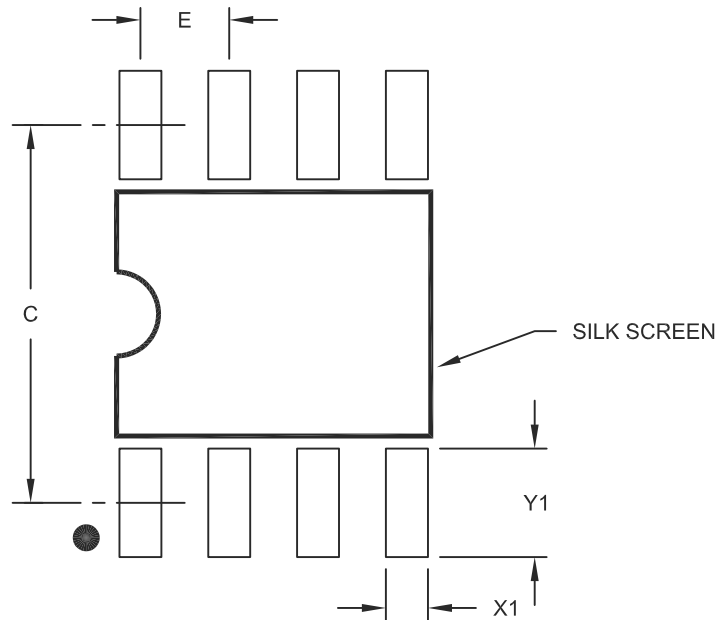

RECOMMENDED LAND PATTERN

Dimension Limits	Units	MILLIMETERS		
		MIN	NOM	MAX
Contact Pitch	E	1.27 BSC		
Contact Pad Spacing	C		5.40	
Contact Pad Width (X8)	X1			0.60
Contact Pad Length (X8)	Y1			1.55

Notes:

1. Dimensioning and tolerancing per ASME Y14.5M

BSC: Basic Dimension. Theoretically exact value shown without tolerances.

Microchip Technology Drawing No. C04-2057A

MCP1406/07

NOTES:

APPENDIX A: REVISION HISTORY

Revision B (May 2012)

The following is the list of modifications:

Removed the information referring to the Electrostatic Discharge from the General Description section.

Revision A (December 2006)

Original release of this document.

MCP1406/07

NOTES:

PRODUCT IDENTIFICATION SYSTEM

To order or obtain information, e.g., on pricing or delivery, refer to the factory or the listed sales office.

<u>PART NO.</u>	<u>X</u>	<u>XX</u>	<u>XXX</u>
Device	Temperature Range	Package	Tape & Reel
Device:	MCP1406:	6A High-Speed MOSFET Driver, Inverting	
	MCP1406T:	6A High-Speed MOSFET Driver, Inverting (Tape and Reel)	
	MCP1407:	6A High-Speed MOSFET Driver, Non-Inverting	
	MCP1407T:	6A High-Speed MOSFET Driver, Non-Inverting (Tape and Reel)	
Temperature Range:	E	=	-40°C to +125°C
Package: *	AT	=	TO-220, 5-Lead
	MF	=	Dual, Flat, No-Lead (6x5 mm Body), 8-lead
	PA	=	Plastic DIP, (300 mil body), 8-lead
	SN	=	Plastic SOIC (150 mil Body), 8-Lead
	* All package offerings are Pb Free (Lead Free)		

Examples:	
a)	MCP1406-E/MF: 6A High-Speed MOSFET Driver, Inverting 8LD DFN package.
b)	MCP1406-E/AT: 6A High-Speed MOSFET Driver, Inverting 5LD TO-220 package.
c)	MCP1406-E/SN: 6A High-Speed MOSFET Driver, Inverting 8LD SOIC package.
d)	MCP1406-E/P: 6A High-Speed MOSFET Driver, Inverting 8LD PDIP package.
e)	MCP1406T-E/MF: Tape and Reel, 6A High-Speed MOSFET Driver, Inverting, 8LD DFN pkg.
f)	MCP1406T-E/SN: Tape and Reel, 6A High-Speed MOSFET Driver, Inverting, 8LD SOIC pkg.
a)	MCP1407-E/MF: 6A High-Speed MOSFET Driver, Non-Inverting 8LD DFN package.
b)	MCP1407-E/AT: 6A High-Speed MOSFET Driver, Non-Inverting 5LD TO-220 package.
c)	MCP1407-E/SN: 6A High-Speed MOSFET Driver, Non-Inverting 8LD SOIC package.
d)	MCP1407-E/P: 6A High-Speed MOSFET Driver, Non-Inverting 8LD PDIP package.
e)	MCP1407T-E/MF: Tape and Reel, 6A High-Speed MOSFET Driver, Non-Inverting, 8LD DFN pkg.
f)	MCP1407T-E/SN: Tape and Reel, 6A High-Speed MOSFET Driver, Non-Inverting, 8LD SOIC pkg.

MCP1406/07

NOTES:

Note the following details of the code protection feature on Microchip devices:

- Microchip products meet the specification contained in their particular Microchip Data Sheet.
- Microchip believes that its family of products is one of the most secure families of its kind on the market today, when used in the intended manner and under normal conditions.
- There are dishonest and possibly illegal methods used to breach the code protection feature. All of these methods, to our knowledge, require using the Microchip products in a manner outside the operating specifications contained in Microchip's Data Sheets. Most likely, the person doing so is engaged in theft of intellectual property.
- Microchip is willing to work with the customer who is concerned about the integrity of their code.
- Neither Microchip nor any other semiconductor manufacturer can guarantee the security of their code. Code protection does not mean that we are guaranteeing the product as “unbreakable.”

Code protection is constantly evolving. We at Microchip are committed to continuously improving the code protection features of our products. Attempts to break Microchip's code protection feature may be a violation of the Digital Millennium Copyright Act. If such acts allow unauthorized access to your software or other copyrighted work, you may have a right to sue for relief under that Act.

Information contained in this publication regarding device applications and the like is provided only for your convenience and may be superseded by updates. It is your responsibility to ensure that your application meets with your specifications. MICROCHIP MAKES NO REPRESENTATIONS OR WARRANTIES OF ANY KIND WHETHER EXPRESS OR IMPLIED, WRITTEN OR ORAL, STATUTORY OR OTHERWISE, RELATED TO THE INFORMATION, INCLUDING BUT NOT LIMITED TO ITS CONDITION, QUALITY, PERFORMANCE, MERCHANTABILITY OR FITNESS FOR PURPOSE. Microchip disclaims all liability arising from this information and its use. Use of Microchip devices in life support and/or safety applications is entirely at the buyer's risk, and the buyer agrees to defend, indemnify and hold harmless Microchip from any and all damages, claims, suits, or expenses resulting from such use. No licenses are conveyed, implicitly or otherwise, under any Microchip intellectual property rights.

Trademarks

The Microchip name and logo, the Microchip logo, dsPIC, KEELOQ, KEELOQ logo, MPLAB, PIC, PICmicro, PICSTART, PIC³² logo, rfPIC and UNI/O are registered trademarks of Microchip Technology Incorporated in the U.S.A. and other countries.

FilterLab, Hampshire, HI-TECH C, Linear Active Thermistor, MXDEV, MXLAB, SEEVAL and The Embedded Control Solutions Company are registered trademarks of Microchip Technology Incorporated in the U.S.A.

Analog-for-the-Digital Age, Application Maestro, chipKIT, chipKIT logo, CodeGuard, dsPICDEM, dsPICDEM.net, dsPICworks, dsSPEAK, ECAN, ECONOMONITOR, FanSense, HI-TIDE, In-Circuit Serial Programming, ICSP, Mindi, MiWi, MPASM, MPLAB Certified logo, MPLIB, MPLINK, mTouch, Omniscient Code Generation, PICC, PICC-18, PICDEM, PICDEM.net, PICKit, PICtail, REAL ICE, rfLAB, Select Mode, Total Endurance, TSHARC, UniWinDriver, WiperLock and ZENA are trademarks of Microchip Technology Incorporated in the U.S.A. and other countries.

SQTP is a service mark of Microchip Technology Incorporated in the U.S.A.

All other trademarks mentioned herein are property of their respective companies.

© 2006-2012, Microchip Technology Incorporated, Printed in the U.S.A., All Rights Reserved.

 Printed on recycled paper.

ISBN: 978-1-62076-103-8

Microchip received ISO/TS-16949:2009 certification for its worldwide headquarters, design and wafer fabrication facilities in Chandler and Tempe, Arizona; Gresham, Oregon and design centers in California and India. The Company's quality system processes and procedures are for its PIC[®] MCUs and dsPIC[®] DSCs, KEELOQ[®] code hopping devices, Serial EEPROMs, microperipherals, nonvolatile memory and analog products. In addition, Microchip's quality system for the design and manufacture of development systems is ISO 9001:2000 certified.

**QUALITY MANAGEMENT SYSTEM
CERTIFIED BY DNV
= ISO/TS 16949 =**



MICROCHIP

Worldwide Sales and Service

AMERICAS

Corporate Office
2355 West Chandler Blvd.
Chandler, AZ 85224-6199
Tel: 480-792-7200
Fax: 480-792-7277
Technical Support:
<http://www.microchip.com/support>
Web Address:
www.microchip.com

Atlanta
Duluth, GA
Tel: 678-957-9614
Fax: 678-957-1455

Boston
Westborough, MA
Tel: 774-760-0087
Fax: 774-760-0088

Chicago
Itasca, IL
Tel: 630-285-0071
Fax: 630-285-0075

Cleveland
Independence, OH
Tel: 216-447-0464
Fax: 216-447-0643

Dallas
Addison, TX
Tel: 972-818-7423
Fax: 972-818-2924

Detroit
Farmington Hills, MI
Tel: 248-538-2250
Fax: 248-538-2260

Indianapolis
Noblesville, IN
Tel: 317-773-8323
Fax: 317-773-5453

Los Angeles
Mission Viejo, CA
Tel: 949-462-9523
Fax: 949-462-9608

Santa Clara
Santa Clara, CA
Tel: 408-961-6444
Fax: 408-961-6445

Toronto
Mississauga, Ontario,
Canada
Tel: 905-673-0699
Fax: 905-673-6509

ASIA/PACIFIC

Asia Pacific Office
Suites 3707-14, 37th Floor
Tower 6, The Gateway
Harbour City, Kowloon
Hong Kong
Tel: 852-2401-1200
Fax: 852-2401-3431

Australia - Sydney
Tel: 61-2-9868-6733
Fax: 61-2-9868-6755

China - Beijing
Tel: 86-10-8569-7000
Fax: 86-10-8528-2104

China - Chengdu
Tel: 86-28-8665-5511
Fax: 86-28-8665-7889

China - Chongqing
Tel: 86-23-8980-9588
Fax: 86-23-8980-9500

China - Hangzhou
Tel: 86-571-2819-3187
Fax: 86-571-2819-3189

China - Hong Kong SAR
Tel: 852-2401-1200
Fax: 852-2401-3431

China - Nanjing
Tel: 86-25-8473-2460
Fax: 86-25-8473-2470

China - Qingdao
Tel: 86-532-8502-7355
Fax: 86-532-8502-7205

China - Shanghai
Tel: 86-21-5407-5533
Fax: 86-21-5407-5066

China - Shenyang
Tel: 86-24-2334-2829
Fax: 86-24-2334-2393

China - Shenzhen
Tel: 86-755-8203-2660
Fax: 86-755-8203-1760

China - Wuhan
Tel: 86-27-5980-5300
Fax: 86-27-5980-5118

China - Xian
Tel: 86-29-8833-7252
Fax: 86-29-8833-7256

China - Xiamen
Tel: 86-592-2388138
Fax: 86-592-2388130

China - Zhuhai
Tel: 86-756-3210040
Fax: 86-756-3210049

ASIA/PACIFIC

India - Bangalore
Tel: 91-80-3090-4444
Fax: 91-80-3090-4123

India - New Delhi
Tel: 91-11-4160-8631
Fax: 91-11-4160-8632

India - Pune
Tel: 91-20-2566-1512
Fax: 91-20-2566-1513

Japan - Osaka
Tel: 81-66-152-7160
Fax: 81-66-152-9310

Japan - Yokohama
Tel: 81-45-471-6166
Fax: 81-45-471-6122

Korea - Daegu
Tel: 82-53-744-4301
Fax: 82-53-744-4302

Korea - Seoul
Tel: 82-2-554-7200
Fax: 82-2-558-5932 or
82-2-558-5934

Malaysia - Kuala Lumpur
Tel: 60-3-6201-9857
Fax: 60-3-6201-9859

Malaysia - Penang
Tel: 60-4-227-8870
Fax: 60-4-227-4068

Philippines - Manila
Tel: 63-2-634-9065
Fax: 63-2-634-9069

Singapore
Tel: 65-6334-8870
Fax: 65-6334-8850

Taiwan - Hsin Chu
Tel: 886-3-5778-366
Fax: 886-3-5770-955

Taiwan - Kaohsiung
Tel: 886-7-536-4818
Fax: 886-7-330-9305

Taiwan - Taipei
Tel: 886-2-2500-6610
Fax: 886-2-2508-0102

Thailand - Bangkok
Tel: 66-2-694-1351
Fax: 66-2-694-1350

EUROPE

Austria - Wels
Tel: 43-7242-2244-39
Fax: 43-7242-2244-393

Denmark - Copenhagen
Tel: 45-4450-2828
Fax: 45-4485-2829

France - Paris
Tel: 33-1-69-53-63-20
Fax: 33-1-69-30-90-79

Germany - Munich
Tel: 49-89-627-144-0
Fax: 49-89-627-144-44

Italy - Milan
Tel: 39-0331-742611
Fax: 39-0331-466781

Netherlands - Drunen
Tel: 31-416-690399
Fax: 31-416-690340

Spain - Madrid
Tel: 34-91-708-08-90
Fax: 34-91-708-08-91

UK - Wokingham
Tel: 44-118-921-5869
Fax: 44-118-921-5820

11/29/11



Стандарт Электрон Связь

Мы молодая и активно развивающаяся компания в области поставок электронных компонентов. Мы поставляем электронные компоненты отечественного и импортного производства напрямую от производителей и с крупнейших складов мира.

Благодаря сотрудничеству с мировыми поставщиками мы осуществляем комплексные и плановые поставки широчайшего спектра электронных компонентов.

Собственная эффективная логистика и склад в обеспечивает надежную поставку продукции в точно указанные сроки по всей России.

Мы осуществляем техническую поддержку нашим клиентам и предпродажную проверку качества продукции. На все поставляемые продукты мы предоставляем гарантию .

Осуществляем поставки продукции под контролем ВП МО РФ на предприятия военно-промышленного комплекса России , а также работаем в рамках 275 ФЗ с открытием отдельных счетов в уполномоченном банке. Система менеджмента качества компании соответствует требованиям ГОСТ ISO 9001.

Минимальные сроки поставки, гибкие цены, неограниченный ассортимент и индивидуальный подход к клиентам являются основой для выстраивания долгосрочного и эффективного сотрудничества с предприятиями радиоэлектронной промышленности, предприятиями ВПК и научно-исследовательскими институтами России.

С нами вы становитесь еще успешнее!

Наши контакты:

Телефон: +7 812 627 14 35

Электронная почта: sales@st-electron.ru

Адрес: 198099, Санкт-Петербург,
Промышленная ул, дом № 19, литера Н,
помещение 100-Н Офис 331