

MC74AC00, MC74ACT00

Quad 2-Input NAND Gate

High-Performance Silicon-Gate CMOS

Features

- Output Drive Capability: ± 24 mA
- Operating Voltage Range: 2 to 6 V AC00; 4.5 to 5.5 ACT00
- Low Input Current: 1.0 μ A
- High Noise Immunity Characteristic of CMOS Devices
- In Compliance With the JEDEC Standard No. 7A Requirements
- Chip Complexity: 32 FETs
- Pb-Free Packages are Available

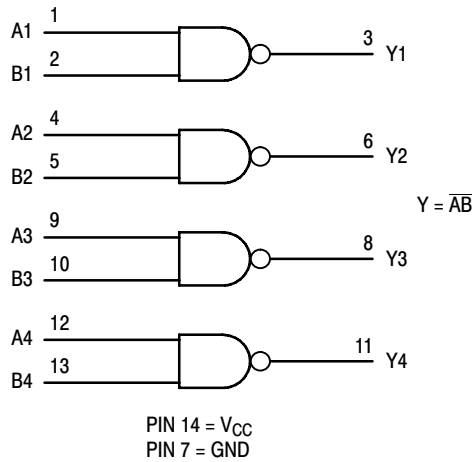

Figure 1. Logic Diagram

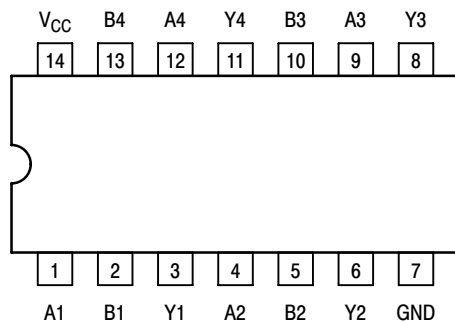

Figure 2. Pinout: 14-Lead Packages (Top View)



ON Semiconductor®

<http://onsemi.com>

MARKING DIAGRAMS

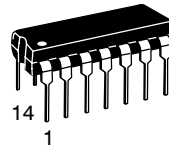

PDIP-14
N SUFFIX
CASE 646

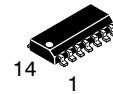
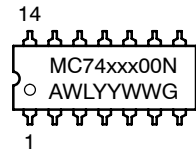

SOIC-14
D SUFFIX
CASE 751A

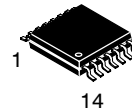
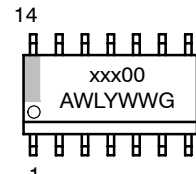

TSSOP-14
DT SUFFIX
CASE 948G

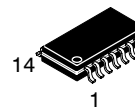
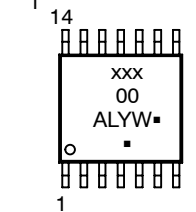

SOEIAJ-14
M SUFFIX
CASE 965

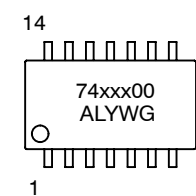

xxx = AC or ACT
A = Assembly Location
WL or L = Wafer Lot
YY or Y = Year
WW or W = Work Week
G = Pb-Free Package

FUNCTION TABLE

Inputs		Output
A	B	Y
L	L	H
L	H	H
H	L	H
H	H	L

ORDERING INFORMATION

See detailed ordering and shipping information in the package dimensions section on page 6 of this data sheet.

MC74AC00, MC74ACT00

MAXIMUM RATINGS

Symbol	Parameter	Value	Unit
V _{CC}	DC Supply Voltage	-0.5 to +7.0	V
V _I	DC Input Voltage	-0.5 ≤ V _I ≤ V _{CC} + 0.5	V
V _O	DC Output Voltage (Note 1)	-0.5 ≤ V _O ≤ V _{CC} + 0.5	V
I _{IK}	DC Input Diode Current	±20	mA
I _{OK}	DC Output Diode Current	±50	mA
I _O	DC Output Sink/Source Current	±50	mA
I _{CC}	DC Supply Current per Output Pin	±50	mA
I _{GND}	DC Ground Current per Output Pin	±50	mA
T _{STG}	Storage Temperature Range	-65 to +150	°C
T _L	Lead temperature, 1 mm from Case for 10 Seconds	260	°C
T _J	Junction temperature under Bias	+150	°C
θ _{JA}	Thermal resistance PDIP SOIC TSSOP	78 125 170	°C/W
P _D	Power Dissipation in Still Air at 85°C PDIP SOIC TSSOP	78 125 170	mW
MSL	Moisture Sensitivity	Level 1	
F _R	Flammability Rating Oxygen Index: 30% – 35%	UL 94 V-0 @ 0.125 in	
V _{ESD}	ESD Withstand Voltage Human Body Model (Note 2) Machine Model (Note 3) Charged Device Model (Note 4)	> 2000 > 200 > 1000	V
I _{Latch-Up}	Latch-Up Performance Above V _{CC} and Below GND at 85°C (Note 5)	±100	mA

Stresses exceeding Maximum Ratings may damage the device. Maximum Ratings are stress ratings only. Functional operation above the Recommended Operating Conditions is not implied. Extended exposure to stresses above the Recommended Operating Conditions may affect device reliability.

1. I_O absolute maximum rating must be observed.
2. Tested to EIA/JESD22-A114-A.
3. Tested to EIA/JESD22-A115-A.
4. Tested to JESD22-C101-A.
5. Tested to EIA/JESD78.

RECOMMENDED OPERATING CONDITIONS

Symbol	Parameter	Min	Typ	Max	Unit
V _{CC}	Supply Voltage MC74AC00 MC74ACT00	2.0 4.5	5.0 5.0	6.0 5.5	V
V _{in} , V _{out}	DC Input Voltage, Output Voltage (Ref. to GND)	0	-	V _{CC}	V
t _r , t _f	Input Rise and Fall Time (Note 6) MC74AC00	V _{CC} @ 3.0 V V _{CC} @ 4.5 V V _{CC} @ 5.5 V	- 150 40 25	- - -	ns/V
t _r , t _f	Input Rise and Fall Time (Note 7) MC74ACT00	V _{CC} @ 4.5 V V _{CC} @ 5.5 V	- 10 8.0	- -	ns/V
T _J	Junction Temperature	-	-	150	°C
T _A	Operating Ambient Temperature Range	-55	25	125	°C
I _{OH}	Output Current – High	-	-	-24	mA
I _{OL}	Output Current – Low	-	-	24	mA

6. V_{in} from 30% to 70% V_{CC}.
7. V_{in} from 0.8 V to 2.0 V.

MC74AC00, MC74ACT00

DC CHARACTERISTICS

Symbol	Parameter	V _{CC} (V)	MC74AC00						Unit	Conditions
			T _A = +25°C		T _A = -40°C to +85°C		T _A = -55°C to +125°C			
			Typ	Guaranteed Limits						
V _{IH}	Minimum High Level Input Voltage	3.0	1.5	2.1	2.1		2.1		V	V _{OUT} = 0.1 V or V _{CC} - 0.1 V
		4.5	2.25	3.15	3.15		3.15			
		5.5	2.75	3.85	3.85		3.85			
V _{IL}	Maximum Low Level Input Voltage	3.0	1.5	0.9	0.9		0.9		V	V _{OUT} = 0.1 V or V _{CC} - 0.1 V
		4.5	2.25	1.35	1.35		1.35			
		5.5	2.75	1.65	1.65		1.65			
V _{OH}	Minimum High Level Output Voltage	3.0	2.99	2.9	2.9		2.9		V	I _{OUT} = -50 μA
		4.5	4.49	4.4	4.4		4.4			
		5.5	5.49	5.4	5.4		5.4			
		3.0	-	2.56	2.46		2.4		V	*V _{IN} = V _{IL} or V _{IH} -12 mA I _{OH} -24 mA -24 mA
		4.5	-	3.86	3.76		3.7			
		5.5	-	4.86	4.76		4.7			
V _{OL}	Maximum Low Level Output Voltage	3.0	0.002	0.1	0.1		0.1		V	I _{OUT} = 50 μA
		4.5	0.001	0.1	0.1		0.1			
		5.5	0.001	0.1	0.1		0.1			
		3.0	-	0.36	0.44		0.5		V	*V _{IN} = V _{IL} or V _{IH} 12 mA I _{OL} 24 mA 24 mA
		4.5	-	0.36	0.44		0.5			
		5.5	-	0.36	0.44		0.5			
I _{IN}	Maximum Input Leakage Current	5.5	-	±0.1	±1.0		±1.0		μA	V _I = V _{CC} , GND
I _{OLD}	†Minimum Dynamic Output Current	5.5	-	-	75		50		mA	V _{OLD} = 1.65 V Max
I _{OHD}		5.5	-	-	-75		-50		mA	V _{OHD} = 3.85 V Min
I _{CC}	Maximum Quiescent Supply Current	5.5	-	4.0	40		40		μA	V _{IN} = V _{CC} or GND

*All outputs loaded; thresholds on input associated with output under test.

†Maximum test duration 2.0 ms, one output loaded at a time.

NOTE: I_{IN} and I_{CC} @ 3.0 V are guaranteed to be less than or equal to the respective limit @ 5.5 V V_{CC}.

AC CHARACTERISTICS (t_r = t_f = 3.0 nS; C_L = 50 pF; see Figures 3 and 4 for Waveforms)

Symbol	Parameter	V _{CC} * (V)	MC74AC00								Unit
			T _A = +25°C			T _A = -40°C to +85°C		T _A = -55°C to +125°C			
			Min	Typ	Max	Min	Max	Min	Max		
t _{PLH}	Propagation Delay	3.3	2.0	7.0	9.5	2.0	10.0	1.0	11.0	ns	
		5.0	1.5	6.0	8.0	1.5	8.5	1.0	8.5		
t _{PHL}	Propagation Delay	3.3	1.5	5.5	8.0	1.0	8.5	1.0	9.0	ns	
		5.0	1.5	4.5	6.5	1.0	7.0	1.0	7.0		

*Voltage Range 3.3 V is 3.3 V ± 0.3 V.

Voltage Range 5.0 V is 5.0 V ± 0.5 V.

MC74AC00, MC74ACT00

DC CHARACTERISTICS

Symbol	Parameter	V _{CC} (V)	MC74ACT00				Unit	Conditions
			T _A = +25°C		T _A = -40°C to +85°C	T _A = -55°C to +125°C		
			Typ	Guaranteed Limits				
V _{IH}	Minimum High Level Input Voltage	4.5	1.5	2.0	2.0	2.0	V	V _{OUT} = 0.1 V or V _{CC} - 0.1 V
		5.5	1.5	2.0	2.0	2.0		
V _{IL}	Maximum Low Level Input Voltage	4.5	1.5	0.8	0.8	0.8	V	V _{OUT} = 0.1 V or V _{CC} - 0.1 V
		5.5	1.5	0.8	0.8	0.8		
V _{OH}	Minimum High Level Output Voltage	4.5	4.49	4.4	4.4	4.4	V	I _{OUT} = -50 μA
		5.5	5.49	5.4	5.4	5.4		
		4.5	-	3.86	3.76	3.7	V	
		5.5	-	4.86	4.76	4.7		
V _{OL}	Maximum Low Level Output Voltage	4.5	0.001	0.1	0.1	0.1	V	I _{OUT} = 50 μA
		5.5	0.001	0.1	0.1	0.1		
		4.5	-	0.36	0.44	0.5	V	
		5.5	-	0.36	0.44	0.5		
I _{IN}	Maximum Input Leakage Current	5.5	-	±0.1	±1.0	±1.0	μA	V _I = V _{CC} , GND
ΔI _{CC} T	Additional Max. I _{CC} /Input	5.5	0.6	-	1.5	1.6	mA	V _I = V _{CC} - 2.1 V
I _{OLD}	†Minimum Dynamic Output Current	5.5	-	-	75	50	mA	V _{OLD} = 1.65 V Max
I _{OHD}		5.5	-	-	-75	-50	mA	V _{OHD} = 3.85 V Min
I _{CC}	Maximum Quiescent Supply Current	5.5	-	4.0	40	40	μA	V _{IN} = V _{CC} or GND

*All outputs loaded; thresholds on input associated with output under test.

†Maximum test duration 2.0 ms, one output loaded at a time.

AC CHARACTERISTICS (t_r = t_f = 3.0 nS; C_L = 50 pF; see Figures 3 and 4 for Waveforms)

Symbol	Parameter	V _{CC} * (V)	MC74ACT00						Unit	
			T _A = +25°C			T _A = -40°C to +85°C		T _A = -55°C to +125°C		
			Min	Typ	Max	Min	Max	Min		Max
t _{PLH}	Propagation Delay	5.0	1.5	5.5	9.0	1.0	9.5	1.0	9.5	ns
t _{PHL}	Propagation Delay	5.0	1.5	4.0	7.0	1.0	8.0	1.0	8.0	ns

*Voltage Range 5.0 V is 5.0 V ± 0.5 V.

CAPACITANCE

Symbol	Parameter	Value Typ	Test Conditions	Unit
C _{IN}	Input Capacitance	4.5	V _{CC} = 5.0 V	pF
C _{PD}	Power Dissipation Capacitance	30	V _{CC} = 5.0 V	pF

MC74AC00, MC74ACT00

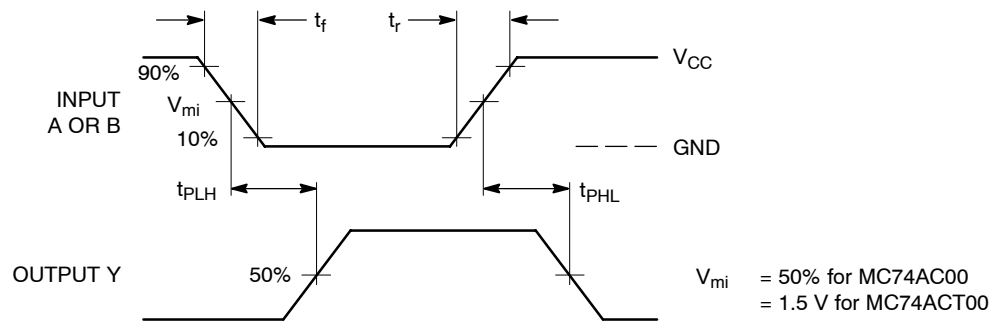
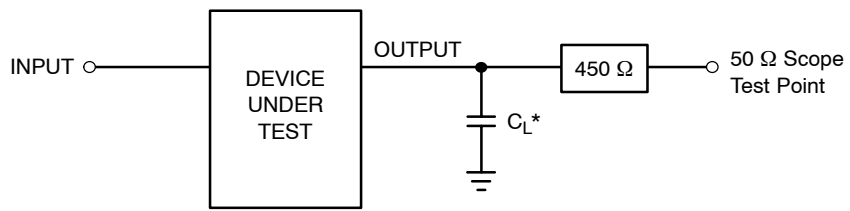

Figure 3. Switching Waveforms



*Includes all probe and jig capacitance

Figure 4. Test Circuit

MC74AC00, MC74ACT00

ORDER INFORMATION

Device	Package	Shipping†
MC74AC00D	SOIC-14	55 Units / Rail
MC74AC00DG	SOIC-14 (Pb-Free)	
MC74AC00N	PDIP-14	25 Units / Rail
MC74AC00NG	PDIP-14 (Pb-Free)	
MC74AC00DR2	SOIC-14	2500 / Tape and Reel
MC74AC00DR2G	SOIC-14 (Pb-Free)	
MC74AC00DTR2	TSSOP-14*	
MC74AC00DTR2G	TSSOP-14*	
MC74AC00MEL	SOEIAJ-14	2000 / Tape and Reel
MC74AC00MELG	SOEIAJ-14 (Pb-Free)	
MC74ACT00N	PDIP-14	25 Units / Rail
MC74ACT00NG	PDIP-14 (Pb-Free)	
MC74ACT00D	SOIC-14	55 Units / Rail
MC74ACT00DG	SOIC-14 (Pb-Free)	
MC74ACT00DR2	SOIC-14	2500 / Tape and Reel
MC74ACT00DR2G	SOIC-14 (Pb-Free)	
MC74ACT00DTR2	TSSOP-14*	
MC74ACT00DTR2G	TSSOP-14*	
MC74ACT00MEL	SOEIAJ-14	2000 / Tape and Reel
MC74ACT00MELG	SOEIAJ-14 (Pb-Free)	

†For information on tape and reel specifications, including part orientation and tape sizes, please refer to our Tape and Reel Packaging Specifications Brochure, BRD8011/D.

*This package is inherently Pb-Free.

MC74AC00, MC74ACT00

PACKAGE DIMENSIONS

SOIC-14
CASE 751A-03
ISSUE H



NOTES:

1. DIMENSIONING AND TOLERANCING PER ANSI Y14.5M, 1982.
2. CONTROLLING DIMENSION: MILLIMETER.
3. DIMENSIONS A AND B DO NOT INCLUDE MOLD PROTRUSION.
4. MAXIMUM MOLD PROTRUSION 0.15 (0.006) PER SIDE.
5. DIMENSION D DOES NOT INCLUDE DAMBAR PROTRUSION. ALLOWABLE DAMBAR PROTRUSION SHALL BE 0.127 (0.005) TOTAL IN EXCESS OF THE D DIMENSION AT MAXIMUM MATERIAL CONDITION.

DIM	MILLIMETERS		INCHES	
	MIN	MAX	MIN	MAX
A	8.55	8.75	0.337	0.344
B	3.80	4.00	0.150	0.157
C	1.35	1.75	0.054	0.068
D	0.35	0.49	0.014	0.019
F	0.40	1.25	0.016	0.049
G	1.27 BSC		0.050 BSC	
J	0.19	0.25	0.008	0.009
K	0.10	0.25	0.004	0.009
M	0°	7°	0°	7°
P	5.80	6.20	0.228	0.244
R	0.25	0.50	0.010	0.019

SOLDERING FOOTPRINT*

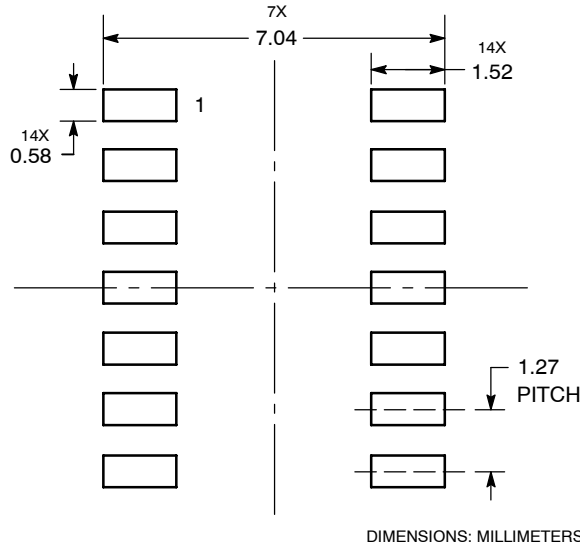

*For additional information on our Pb-Free strategy and soldering details, please download the ON Semiconductor Soldering and Mounting Techniques Reference Manual, SOLDERRM/D.

MC74AC00, MC74ACT00

PDIP-14
CASE 646-06
ISSUE P

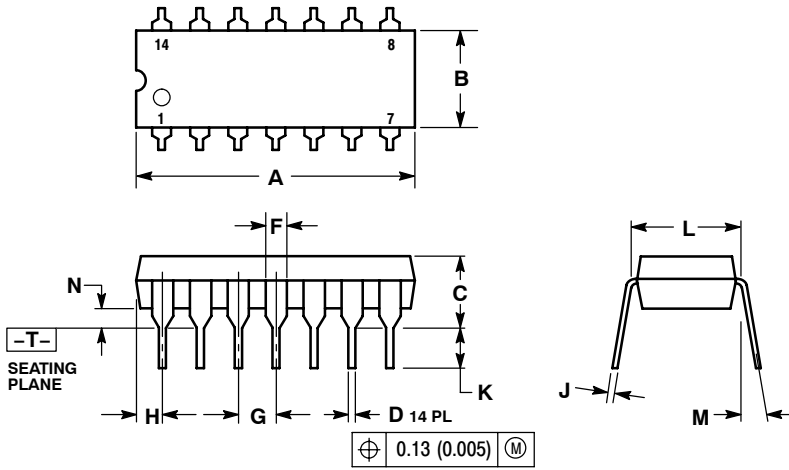

NOTES:

1. DIMENSIONING AND TOLERANCING PER ANSI Y14.5M, 1982.
2. CONTROLLING DIMENSION: INCH.
3. DIMENSION L TO CENTER OF LEADS WHEN FORMED PARALLEL.
4. DIMENSION B DOES NOT INCLUDE MOLD FLASH.
5. ROUNDED CORNERS OPTIONAL.

DIM	INCHES		MILLIMETERS	
	MIN	MAX	MIN	MAX
A	0.715	0.770	18.16	19.56
B	0.240	0.260	6.10	6.60
C	0.145	0.185	3.69	4.69
D	0.015	0.021	0.38	0.53
F	0.040	0.070	1.02	1.78
G	0.100 BSC		2.54 BSC	
H	0.052	0.095	1.32	2.41
J	0.008	0.015	0.20	0.38
K	0.115	0.135	2.92	3.43
L	0.290	0.310	7.37	7.87
M	---	10°	---	10°
N	0.015	0.039	0.38	1.01

MC74AC00, MC74ACT00

PACKAGE DIMENSIONS

TSSOP-14
CASE 948G-01
ISSUE B



- NOTES:
1. DIMENSIONING AND TOLERANCING PER ANSI Y14.5M, 1982.
 2. CONTROLLING DIMENSION: MILLIMETER.
 3. DIMENSION A DOES NOT INCLUDE MOLD FLASH, PROTRUSIONS OR GATE BURRS. MOLD FLASH OR GATE BURRS SHALL NOT EXCEED 0.15 (0.006) PER SIDE.
 4. DIMENSION B DOES NOT INCLUDE INTERLEAD FLASH OR PROTRUSION. INTERLEAD FLASH OR PROTRUSION SHALL NOT EXCEED 0.25 (0.010) PER SIDE.
 5. DIMENSION K DOES NOT INCLUDE DAMBAR PROTRUSION. ALLOWABLE DAMBAR PROTRUSION SHALL BE 0.08 (0.003) TOTAL IN EXCESS OF THE K DIMENSION AT MAXIMUM MATERIAL CONDITION.
 6. TERMINAL NUMBERS ARE SHOWN FOR REFERENCE ONLY.
 7. DIMENSION A AND B ARE TO BE DETERMINED AT DATUM PLANE -W-

DIM	MILLIMETERS		INCHES	
	MIN	MAX	MIN	MAX
A	4.90	5.10	0.193	0.200
B	4.30	4.50	0.169	0.177
C	---	1.20	---	0.047
D	0.05	0.15	0.002	0.006
F	0.50	0.75	0.020	0.030
G	0.65 BSC		0.026 BSC	
H	0.50	0.60	0.020	0.024
J	0.09	0.20	0.004	0.008
J1	0.09	0.16	0.004	0.006
K	0.19	0.30	0.007	0.012
K1	0.19	0.25	0.007	0.010
L	6.40 BSC		0.252 BSC	
M	0° 8°		0° 8°	

SOLDERING FOOTPRINT*

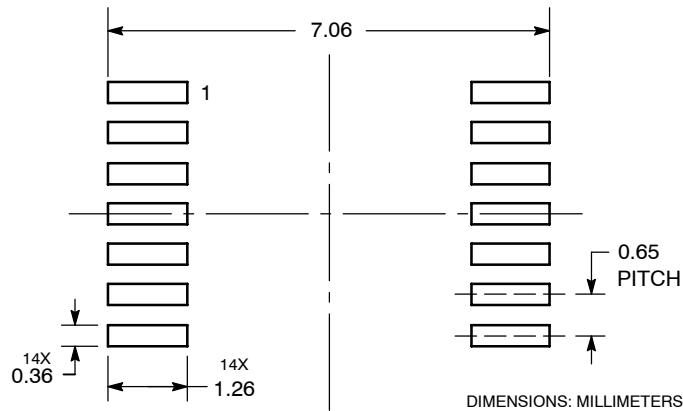

*For additional information on our Pb-Free strategy and soldering details, please download the ON Semiconductor Soldering and Mounting Techniques Reference Manual, SOLDERRM/D.

MC74AC00, MC74ACT00

PACKAGE DIMENSIONS

SOEIAJ-14
CASE 965-01
ISSUE A



NOTES:

1. DIMENSIONING AND TOLERANCING PER ANSI Y14.5M, 1982.
2. CONTROLLING DIMENSION: MILLIMETER.
3. DIMENSIONS D AND E DO NOT INCLUDE MOLD FLASH OR PROTRUSIONS AND ARE MEASURED AT THE PARTING LINE. MOLD FLASH OR PROTRUSIONS SHALL NOT EXCEED 0.15 (0.006) PER SIDE.
4. TERMINAL NUMBERS ARE SHOWN FOR REFERENCE ONLY.
5. THE LEAD WIDTH DIMENSION (b) DOES NOT INCLUDE DAMBAR PROTRUSION. ALLOWABLE DAMBAR PROTRUSION SHALL BE 0.08 (0.003) TOTAL IN EXCESS OF THE LEAD WIDTH DIMENSION AT MAXIMUM MATERIAL CONDITION. DAMBAR CANNOT BE LOCATED ON THE LOWER RADIUS OR THE FOOT. MINIMUM SPACE BETWEEN PROTRUSIONS AND ADJACENT LEAD TO BE 0.46 (0.018).

DIM	MILLIMETERS		INCHES	
	MIN	MAX	MIN	MAX
A	---	2.05	---	0.081
A ₁	0.05	0.20	0.002	0.008
b	0.35	0.50	0.014	0.020
c	0.10	0.20	0.004	0.008
D	9.90	10.50	0.390	0.413
E	5.10	5.45	0.201	0.215
e	1.27 BSC		0.050 BSC	
H _E	7.40	8.20	0.291	0.323
0.50	0.50	0.85	0.020	0.033
L _E	1.10	1.50	0.043	0.059
M	0°	10°	0°	10°
Q ₁	0.70	0.90	0.028	0.035
Z	---	1.42	---	0.056

ON Semiconductor and are registered trademarks of Semiconductor Components Industries, LLC (SCILLC). SCILLC reserves the right to make changes without further notice to any products herein. SCILLC makes no warranty, representation or guarantee regarding the suitability of its products for any particular purpose, nor does SCILLC assume any liability arising out of the application or use of any product or circuit, and specifically disclaims any and all liability, including without limitation special, consequential or incidental damages. "Typical" parameters which may be provided in SCILLC data sheets and/or specifications can and do vary in different applications and actual performance may vary over time. All operating parameters, including "Typicals" must be validated for each customer application by customer's technical experts. SCILLC does not convey any license under its patent rights nor the rights of others. SCILLC products are not designed, intended, or authorized for use as components in systems intended for surgical implant into the body, or other applications intended to support or sustain life, or for any other application in which the failure of the SCILLC product could create a situation where personal injury or death may occur. Should Buyer purchase or use SCILLC products for any such unintended or unauthorized application, Buyer shall indemnify and hold SCILLC and its officers, employees, subsidiaries, affiliates, and distributors harmless against all claims, costs, damages, and expenses, and reasonable attorney fees arising out of, directly or indirectly, any claim of personal injury or death associated with such unintended or unauthorized use, even if such claim alleges that SCILLC was negligent regarding the design or manufacture of the part. SCILLC is an Equal Opportunity/Affirmative Action Employer. This literature is subject to all applicable copyright laws and is not for resale in any manner.

PUBLICATION ORDERING INFORMATION

LITERATURE FULFILLMENT:
Literature Distribution Center for ON Semiconductor
P.O. Box 5163, Denver, Colorado 80217 USA
Phone: 303-675-2175 or 800-344-3860 Toll Free USA/Canada
Fax: 303-675-2176 or 800-344-3867 Toll Free USA/Canada
Email: orderlit@onsemi.com

N. American Technical Support: 800-282-9855 Toll Free USA/Canada
Europe, Middle East and Africa Technical Support:
Phone: 421 33 790 2910
Japan Customer Focus Center
Phone: 81-3-5773-3850

ON Semiconductor Website: www.onsemi.com
Order Literature: <http://www.onsemi.com/orderlit>

For additional information, please contact your local Sales Representative



Стандарт Электрон Связь

Мы молодая и активно развивающаяся компания в области поставок электронных компонентов. Мы поставляем электронные компоненты отечественного и импортного производства напрямую от производителей и с крупнейших складов мира.

Благодаря сотрудничеству с мировыми поставщиками мы осуществляем комплексные и плановые поставки широчайшего спектра электронных компонентов.

Собственная эффективная логистика и склад в обеспечивает надежную поставку продукции в точно указанные сроки по всей России.

Мы осуществляем техническую поддержку нашим клиентам и предпродажную проверку качества продукции. На все поставляемые продукты мы предоставляем гарантию .

Осуществляем поставки продукции под контролем ВП МО РФ на предприятия военно-промышленного комплекса России , а также работаем в рамках 275 ФЗ с открытием отдельных счетов в уполномоченном банке. Система менеджмента качества компании соответствует требованиям ГОСТ ISO 9001.

Минимальные сроки поставки, гибкие цены, неограниченный ассортимент и индивидуальный подход к клиентам являются основой для выстраивания долгосрочного и эффективного сотрудничества с предприятиями радиоэлектронной промышленности, предприятиями ВПК и научно-исследовательскими институтами России.

С нами вы становитесь еще успешнее!

Наши контакты:

Телефон: +7 812 627 14 35

Электронная почта: sales@st-electron.ru

Адрес: 198099, Санкт-Петербург,
Промышленная ул, дом № 19, литера Н,
помещение 100-Н Офис 331