

AVX BestCap® Ultra-low ESR High Power Pulse Supercapacitors

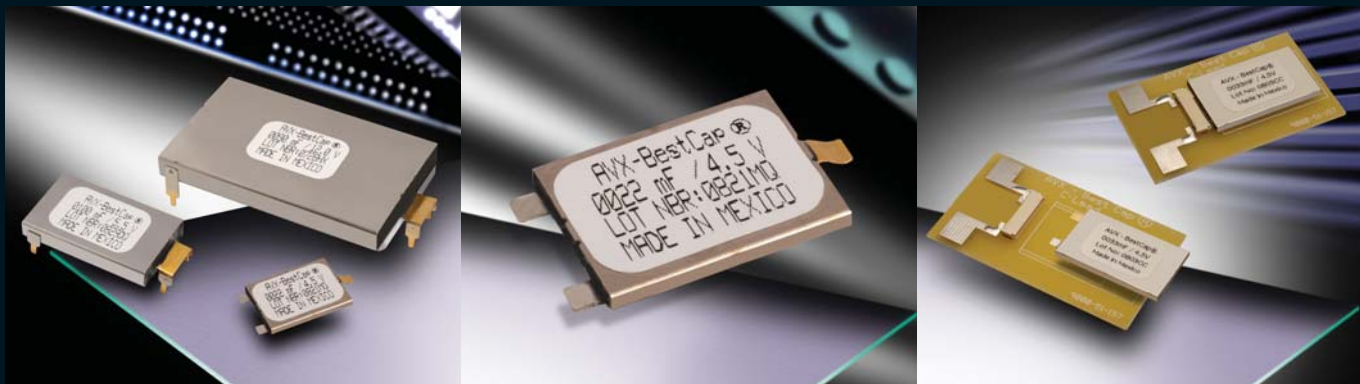

Version 10.3

BestCap® Ultra-low ESR High Power Pulse Supercapacitors



Table of Contents

| | |
|--|-----------|
| An Introduction to BestCap® | 2 |
| BestCap® General Information | 3 |
| SECTION 1: Electrical Ratings (A-B Series) | 4 |
| Electrical Ratings (BZ01/02/05/09)..... | 5 |
| SECTION 2: Mechanical Specifications (A-Lead) | 7 |
| Mechanical Specifications (C-Lead) | 8 |
| Mechanical Specifications (H-Lead) | 9 |
| Mechanical Specifications (L-Lead)..... | 10 |
| Mechanical Specifications (N-Lead) | 11 |
| Mechanical Specifications (S-Lead)..... | 12 |
| Packaging Specifications (BZ01/02/05/09)..... | 13 |
| Packaging Quantities | 13 |
| Cleaning/Handling/Storage Conditions/Part Marking/Termination Finish.... | 14 |
| Product Safety Materials Handling/Materials and Weight..... | 15 |
| Typical Weight Data | 15 |
| SECTION 3: Electrical Characteristics – Schematic, Typical Characteristics..... | 16 |
| Mounting Procedure on a PCB for BestCap® | 17 |
| Qualification Test Summary | 18 |
| SECTION 4: Application Notes | 19 |
| BestCap® Construction/Voltage Drop..... | 19 |
| Enhancing the Power Capability of Primary Batteries..... | 21 |
| BestCap® for GSM/GPRS PCMCIA Modems..... | 22 |
| SECTION 5: Extended Temperature Range | 23 |

NOTICE: Specifications are subject to change without notice. Contact your nearest AVX Sales Office for the latest specifications. All statements, information and data given herein are believed to be accurate and reliable, but are presented without guarantee, warranty, or responsibility of any kind, expressed or implied. Statements or suggestions concerning possible use of our products are made without representation or warranty that any such use is free of patent infringement and are not recommendations to infringe any patent. The user should not assume that all safety measures are indicated or that other measures may not be required. Specifications are typical and may not apply to all applications.



BestCap[®] Ultra-low ESR High Power Pulse Supercapacitors



INTRODUCING BESTCAP[®]: A NEW GENERATION OF PULSE SUPERCAPACITORS

Supercapacitors, (also referred to as Electrochemical Capacitors or Double Layer Capacitors) have rapidly become recognized, not only as an excellent compromise between “electronic” or “dielectric” capacitors such as ceramic, tantalum, film and aluminum electrolytic, and batteries (Figure 1), but also as a valuable technology for providing a unique combination of characteristics, particularly very high energy, power and capacitance densities.

There are however, two limitations associated with conventional supercapacitors, namely: high ESR in the tens of Ohms range, and high capacitance loss when required to supply very short duration current pulses. BestCap[®] successfully addresses both of these limitations.

The capacitance loss in the millisecond region is caused by the charge transfer (i.e. establishment of capacitance) being carried out primarily by relatively slow moving ions in double layer capacitors.

Figure 1. Specific Energy of Capacitor Types

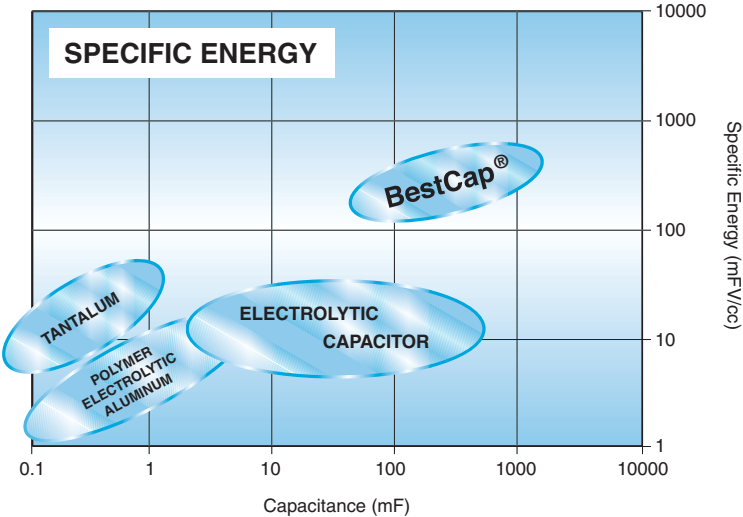

In the above-mentioned “electronic” capacitors, the charge transfer is performed by fast electrons, thereby creating virtually instant rated capacitance value. In the BestCap[®], a unique proton polymer membrane is used – charge transfer by protons is close to the transfer rate for electrons and orders of magnitude greater than organic molecules. Figure 2 below illustrates the severe capacitance loss experienced

by several varieties of supercapacitors, under short pulse width conditions. It can also be seen from Figure 2, how well BestCap[®] retains its capacitance with reducing pulse widths.

For comparison purposes, the characteristic of an equivalent capacitance value aluminum electrolytic capacitor is shown in Figure 2. The electrolytic capacitor is many times the volume of the BestCap[®].

Figure 2. Actual Capacitance vs. Pulse Width

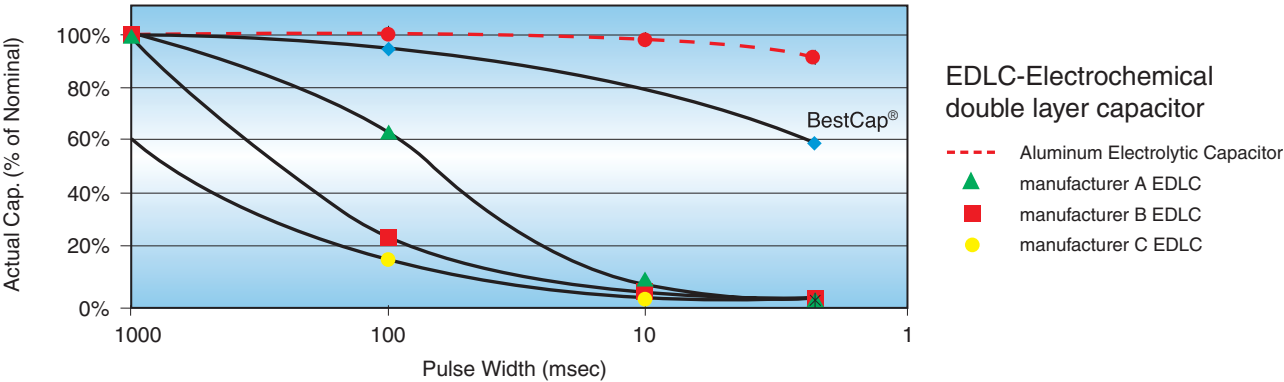

BestCap® Ultra-low ESR High Power Pulse Supercapacitors



BESTCAP® – A SERIES – MAXIMUM CAPACITANCE, LOW ESR B SERIES – LOW PROFILE, LOW ESR

The BestCap® is a low profile device available in four case sizes. Capacitance range is from 6.8 to 1000mF and includes 7 voltage ratings from 3.6v to 15v.

BESTCAP® – AVAILABLE LEAD CONFIGURATIONS

STANDARD:



N-Style: Two Terminal Planar Mount
(Available in BZ01, BZ05, BZ09 case only)

S-Style: Three Terminal Planar Mount
(Available in BZ01, BZ05, BZ09 case only)

L-Style: Four Terminal Planar Mount
(Available in BZ01 and BZ02 case only)

A Style: Through-Hole Mount
(Available in BZ01, BZ02 case only)

H-Style: Extended Stand-Off Through Hole Mount
(Available in BZ01, BZ02 case only)

C-Style: Connector Mount
(Available in BZ01, BZ05 case only)

| Case Size | BODY DIMENSIONS | | |
|-------------|------------------------------|-------------------------------|---------------------------|
| | L±0.5 (0.020) mm (inches) | W ±0.2 (0.008) mm (inches) | H nom mm (inches) |
| BZ01 | 28 (1.102) | 17 (0.669) | 2.3 (0.091) – 6.5 (0.256) |
| BZ02 | 48 (1.890) | 30 (1.181) | 2.9 (0.114) – 6.8 (0.268) |
| BZ05 | 20 (0.787) | 15 (0.590) | 2.3 (0.091) – 6.5 (0.256) |
| BZ09 | 17 (0.669) | 15 (0.590) | 2.3 (0.091) |

ELECTRICAL SPECIFICATIONS

Full dimensional specifications shown in section (2)

| | | | | | | | | |
|------------------------|--|------|------|-------|-------|-------|-------|--|
| Capacitance range: | 6.8mF – 1000mF | | | | | | | |
| Capacitance tolerance: | -20% / +80% | | | | | | | |
| Voltage ratings (max): | 3.6V | 4.5V | 5.5V | 9V | 12V | 15V | 16V | |
| Test voltages: | 3.5V | 4.2V | 5.0V | 8.4V | 10.0V | 11.0V | 13.0V | |
| Surge test voltage: | 4.5V | 5.6V | 6.9V | 11.3V | 15.0V | 18.8V | 20.0V | |
| Temperature range: | -20°C to 70°C, consult factory for -40°C and +75°C options | | | | | | | |

HOW TO ORDER

(See Detailed Electrical Specifications for valid combinations)

| | | | | | | | | | |
|-----------|------------------------------|--|---|--|-------------------------------|-----------------------|----------------------|-----------|--|
| BZ | 0 | 1 | 5 | A | 503 | Z | A | B | XX |
| BestCap® | Standard | Case Size | Rated Voltage | Series | Capacitance Code (Farad Code) | Capacitance Tolerance | Lead Format | Packaging | Not Used For Standard Product (Consult Factory For Special Requirements) |
| | 0 = Standard 1 = High Cap | 1 = 28mmx17mm 2 = 48mmx30mm 5 = 20mmx15mm 9 = 17mmx15mm | 3 = 3.6V 4 = 4.5V 5 = 5.5V 7 = 7.0V 9 = 9.0V C = 12.0V F = 15.0V G = 16.0V | A = Maximum Capacitance B = Low Profile | | Z = (-20/+80)% | A, C, H, L N or S | B = Bulk | |



BestCap® Ultra-low ESR High Power Pulse Supercapacitors



SECTION 1: ELECTRICAL RATINGS

CAPACITANCE / VOLTAGE / CASE SIZE MATRIX

| A-SERIES – MAXIMUM CAPACITANCE | | | | | | | | | | | |
|--------------------------------|------|--------------------------|---------------|-----------|---------------|-----------|-------------|-----------|-------------|-----------|-------------|
| Capacitance | | Rated Voltage DC at 25°C | | | | | | | | | |
| mF | Code | 3.6V | | 5.5V | | 9.0V | | 12.0V | | 16.0V | |
| | | Case Size | Lead Styles | Case Size | Lead Styles | Case Size | Lead Styles | Case Size | Lead Styles | Case Size | Lead Styles |
| 10 | 103 | | | | | | | BZ05 | C, N, S | | |
| 22 | 223 | | | | | | | BZ01 | A, C, H, S | | |
| 33 | 333 | | | BZ05 | C, N, S | BZ01 | A, C, H, S | | | | |
| 47 | 473 | | | | | | | BZ11 | S | | |
| 50 | 503 | | | BZ01 | A, C, H, S, L | | | | | | |
| 68 | 683 | | | BZ05 | S | | | | | | |
| 70 | 703 | BZ01 | A, C, H, S, L | | | | | | | | |
| 90 | 903 | | | | | | | BZ02 | A, H, L | | |
| 100 | 104 | | | BZ01 | A, H, S, L | | | | | | |
| 120 | 124 | | | | | BZ02 | A, H, L | | | BZ12 | A, L, N |
| 140 | 144 | BZ01 | A, H, S, L | | | | | | | | |
| 150 | 154 | | | BZ15 | S | | | | | | |
| 200 | 204 | | | BZ02 | A, H, L | | | | | | |
| 280 | 284 | BZ02 | A, H, L | | | | | | | | |
| 400 | 404 | | | BZ02 | A, H, L | | | | | | |
| 470 | 474 | | | BZ12 | A | | | | | | |
| 560 | 564 | BZ02 | A, H, L | | | | | | | | |
| 1000 | 105 | | | BZ12 | A, H, L | | | | | | |

| B-SERIES – LOW PROFILE | | | | | | | | | | | | | |
|------------------------|------|--------------------------|-------------|-----------|-------------|-----------|-------------|-----------|-------------|-----------|-------------|-----------|-------------|
| Capacitance | | Rated Voltage DC at 25°C | | | | | | | | | | | |
| mF | Code | 3.6V | | 4.5V | | 5.5V | | 9.0V | | 12.0V | | 15.0V | |
| | | Case Size | Lead Styles | Case Size | Lead Styles | Case Size | Lead Styles | Case Size | Lead Styles | Case Size | Lead Styles | Case Size | Lead Styles |
| 6.8 | 682 | | | | | | | | | | | BZ05 | C, N, S |
| 15 | 153 | | | BZ09 | N, S | BZ05 | C, N, S | | | BZ01 | A, H, S | | |
| 22 | 223 | | | BZ05 | N, S | | | BZ01 | A, H, S | | | | |
| 30 | 303 | | | | | BZ01 | C, S, N | | | | | | |
| 33 | 333 | | | BZ01 | C, S, N | BZ05 | S, N | | | | | | |
| 47 | 473 | | | BZ15 | N, S | BZ11 | S | | | | | | |
| 50 | 503 | BZ01 | C, S, N | | | | | | | | | | |
| 60 | 603 | | | | | BZ01 | A, H, S, L | | | | | | |
| 100 | 104 | BZ11 | C, S, N | | | | | | | | | | |

BestCap® Ultra-low ESR High Power Pulse Supercapacitors



SECTION 1: ELECTRICAL RATINGS

ELECTRICAL RATINGS - SEE SECTION 2 FOR DIMENSIONAL REFERENCES

| BZ 01 CASE SIZE | | | | | | | | | | |
|-----------------|-----------------------|---|----------------------|---------|--------------------------|-----------------------------|-----------------------------|-----------------------------|-----------------------------|-----------------------------------|
| Part Number | Rated Voltage (Volts) | Capacitance (mF) Nominal +80%, -20% | ESR (mOhms at 1 kHz) | | Leakage Current (µA max) | Height A-Lead (mm) H max | Height C-Lead (mm) H max | Height H-Lead (mm) H max | Height S-Lead (mm) H max | Height S-Lead (AJ)* (mm) H max |
| | | | Typical | Maximum | | | | | | |
| 3.6V | | | | | | | | | | |
| BZ013B503Z_B | 3.6V | 50 | 100 | 120 | 5 | NA | 2.1 | NA | 3.2 | 2.1 |
| BZ013A703Z_B | | 70 | 140 | 168 | 5 | 3.5 | 2.9 | 6.4 | 4.0 | 2.9 |
| BZ113B104Z_B | | 100 | 100 | 120 | 10 | NA | 2.1 | NA | 3.2 | 2.1 |
| BZ013A144Z_B | | 140 | 70 | 84 | 5 | 5.3 | NA | 8.2 | 5.8 | NA |
| 4.5V | | | | | | | | | | |
| BZ014B333Z_B | 4.5V | 33 | 150 | 180 | 5 | NA | 2.4 | NA | 3.5 | 2.4 |
| 5.5V | | | | | | | | | | |
| BZ015B303Z_B | 5.5V | 30 | 160 | 192 | 5 | NA | 2.7 | NA | 3.8 | 2.7 |
| BZ015A503Z_B | | 50 | 160 | 192 | 5 | 4.1 | 3.5 | 7.0 | 4.6 | 3.5 |
| BZ015B603Z_B | | 60 | 80 | 96 | 10 | 5.4 | NA | 8.3 | 5.9 | NA |
| BZ015A104Z_B | | 100 | 80 | 96 | 10 | 6.7 | NA | 9.6 | 7.2 | NA |
| 9.0V | | | | | | | | | | |
| BZ019B223Z_B | 9.0V | 22 | 250 | 300 | 5 | 4.7 | NA | 7.6 | 5.2 | 4.1 |
| BZ019A333Z_B | | 33 | 250 | 300 | 5 | 5.5 | 4.9 | 8.4 | 6.0 | 4.9 |
| 12.0V | | | | | | | | | | |
| BZ01CB153Z_B | 12.0V | 15 | 350 | 420 | 5 | 5.9 | NA | 8.8 | 6.4 | 5.3 |
| BZ01CA223Z_B | | 22 | 350 | 420 | 5 | 7.1 | 6.5 | 10.0 | 7.6 | 6.5 |

* Select S-Lead BZ01 BestCap® are available with insulation on the bottom of the part and zero clearance from the PCB. See section 2.6 for dimensions. To order, please add special requirement AJ to the end of the part number. Example: BZ013B503ZSBAJ

| BZ 02 CASE SIZE | | | | | | | | |
|-----------------|-----------------------|---|----------------------|---------|--------------------------|-----------------------------|-----------------------------|-----------------------------|
| Part Number | Rated Voltage (Volts) | Capacitance (mF) Nominal +80%, -20% | ESR (mOhms at 1 kHz) | | Leakage Current (µA max) | Height A-Lead (mm) H max | Height H-Lead (mm) H max | Height L-Lead (mm) H max |
| | | | Typical | Maximum | | | | |
| 3.6V | | | | | | | | |
| BZ023A284Z_B | 3.6V | 280 | 45 | 54 | 20 | 3.5 | 6.4 | 3.7 |
| BZ023A564Z_B | | 560 | 25 | 30 | 40 | 5.3 | 8.2 | 5.5 |
| 5.5V | | | | | | | | |
| BZ025A204Z_B | 5.5V | 200 | 60 | 72 | 20 | 4.1 | 7.0 | 4.3 |
| BZ025A404Z_B | | 400 | 35 | 42 | 40 | 6.7 | 9.6 | 6.9 |
| BZ125A105Z_B | | 1000 | 35 | 42 | 120 | 6.7 | 9.6 | 6.9 |
| 9.0V | | | | | | | | |
| BZ029A124Z_B | 9.0V | 120 | 70 | 84 | 20 | 5.8 | 8.7 | 6.0 |
| 12.0V | | | | | | | | |
| BZ02CA903Z_B | 12.0V | 90 | 90 | 108 | 20 | 7.4 | 10.3 | 7.6 |
| 16.0V | | | | | | | | |
| BZ12GA124Z_B | 16.0V | 120 | 160 | 192 | 60 | 9.1 | | 9.1 |

All capacitance, ESR, and leakage current values listed in these tables are at room temperature only.

BestCap® Ultra-low ESR High Power Pulse Supercapacitors



| BZ 05 CASE SIZE | | | | | | | | |
|-----------------|-----------------------|---|----------------------|---------|--------------------------|--------------------|--------------------|--------------------|
| Part Number | Rated Voltage (Volts) | Capacitance (mF) Nominal +80%, -20% | ESR (mOhms at 1 kHz) | | Leakage Current (µA max) | Height C-Lead (mm) | Height N-Lead (mm) | Height S-Lead (mm) |
| | | | Typical | Maximum | | | | |
| 4.5V | | | | | | | | |
| BZ054B223Z_B | 4.5V | 22 | 170 | 204 | 5 | NA | 2.3 | 2.3 |
| BZ154B473Z_B | | 47 | 170 | 204 | 10 | NA | 2.3 | 2.3 |
| 5.5V | | | | | | | | |
| BZ055B153Z_B | 5.5V | 15 | 250 | 300 | 5 | 2.7 | 2.7 | 2.7 |
| BZ055A333Z_B | | 33 | 250 | 300 | 5 | 3.5 | 3.5 | 3.5 |
| BZ055B333Z_B | | 33 | 125 | 150 | 10 | NA | NA | 4.8 |
| BZ055A683Z_B | | 68 | 125 | 150 | 10 | NA | NA | 6.1 |
| 12.0V | | | | | | | | |
| BZ05CA103Z_B | 12.0V | 10 | 500 | 600 | 5 | 6.5 | 6.5 | 6.5 |
| 15.0V | | | | | | | | |
| BZ05FB682Z_B | 15.0V | 6.8 | 500 | 600 | 10 | 4.8 | 5.8 | 5.8 |

| BZ 09 CASE SIZE | | | | | | | |
|-----------------|-----------------------|---|----------------------|---------|--------------------------|--------------------|--------------------|
| Part Number | Rated Voltage (Volts) | Capacitance (mF) Nominal +80%, -20% | ESR (mOhms at 1 kHz) | | Leakage Current (µA max) | Height N-Lead (mm) | Height S-Lead (mm) |
| | | | Typical | Maximum | | | |
| 4.5V | | | | | | | |
| BZ094B153Z_BAI | 4.5V | 15 | 250 | 300 | 5 | 2.4* | 2.3* |

* The 4.5V BZ09 BestCap® are available only in a special low profile version.

All capacitance, ESR, and leakage current values listed in these tables are at room temperature only.

BestCap® Ultra-low ESR High Power Pulse Supercapacitors



SECTION 2: MECHANICAL SPECIFICATIONS

2.1 Case Dimensions & Recommended PCB Layout

2.1.1: A-Style Configuration (Pin Through Hole)

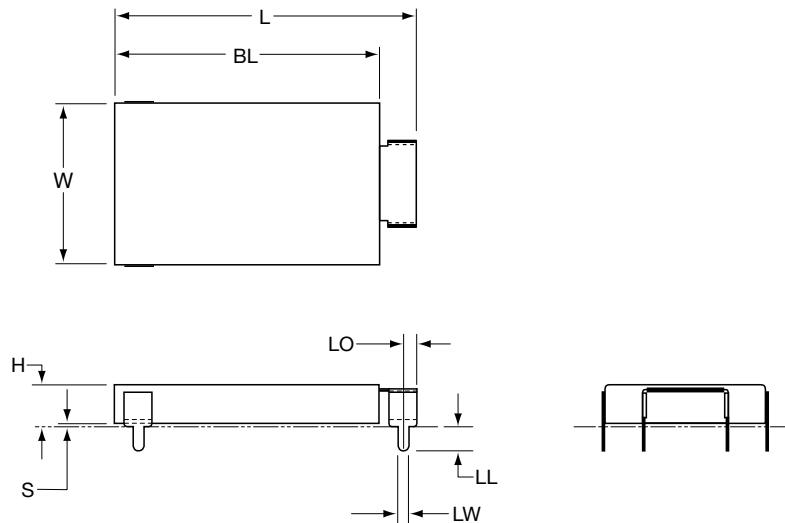

TABLE 2.1.1: A-STYLE DIMENSIONS

| Case Size | Case Dimensions: mm (inches) | | | | | | | |
|-----------|------------------------------|----------------------|----------------|-------------------|-------------------|--------------------|--------------------|--------------------|
| | BL +1.0 (0.040)/-0 | W +1.0 (0.040)/-0 | H (Maximum) | L ±1.0 (0.040) | S ±0.1 (0.004) | LO ±0.2 (0.008) | LW ±0.2 (0.008) | LL ±0.2 (0.008) |
| BZ01 | 28 (1.102) | 17 (0.669) | See Section 1 | 32 | 0.45 (0.018) | 1.5 (0.059) | 1.27 (0.050) | 2.5 (0.098) |
| BZ02 | 48 (1.890) | 30 (1.181) | See Section 1 | 52 | 0.45 (0.018) | 1.5 (0.059) | 1.27 (0.050) | 2.5 (0.098) |

2.1.2: A-Lead Configuration (Through Hole)

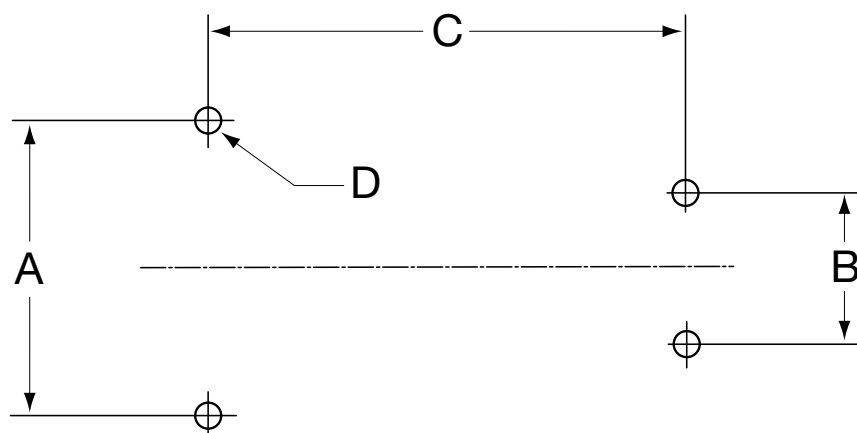

TABLE 2.1.2: A-LEAD LAYOUT DIMENSIONS

| Case Size | Recommended PCB Dimensions: mm (inches) | | | |
|-----------|---|--------------------|--------------------|-------------------|
| | A ±0.05 (0.002) | B ±0.05 (0.002) | C ±0.05 (0.002) | D ±0.1 (0.004) |
| BZ01 | 17.25 (0.679) | 8.90 (0.350) | 28 (1.102) | Ø1.4 (0.055) |
| BZ02 | 30.25 (1.191) | 8.90 (0.350) | 48 (1.890) | Ø1.4 (0.055) |



BestCap[®] Ultra-low ESR High Power Pulse Supercapacitors



SECTION 2: MECHANICAL SPECIFICATIONS (cont'd)

2.2.1: C-Style Case Dimensions

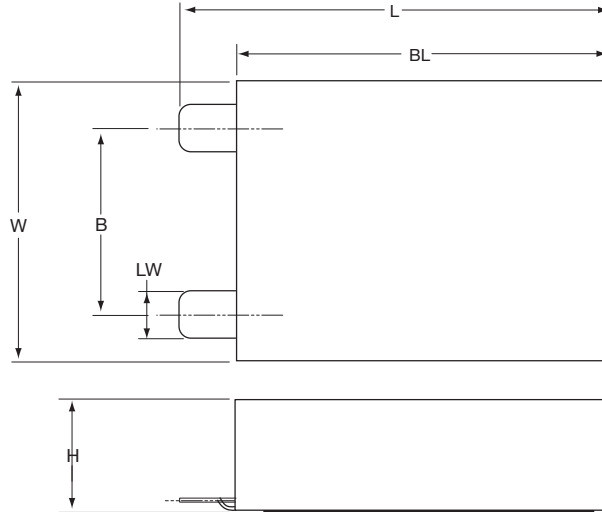
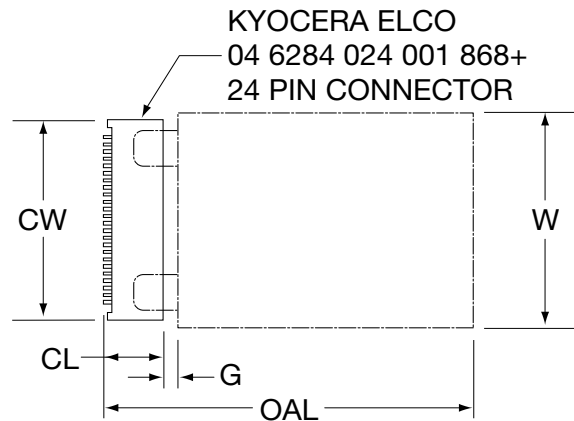

TABLE 2.2.1: C-STYLE CASE DIMENSIONS

| Case Size | Case Dimensions: mm (inches) | | | | | |
|-----------|------------------------------|----------------------|----------------|-----------------------|--------------------|-------------------|
| | L ±0.5 (0.020) | W +1.0 (0.040)/-0 | H (Maximum) | BL +1.0 (0.040)/-0 | LW ±0.2 (0.008) | B ±0.5 (0.020) |
| BZ01 | 31 (1.220) | 17 (0.669) | See Section 1 | 28 (1.102) | 2.5 (0.098) | 10 (0.394) |
| BZ05 | 23 (0.906) | 15 (0.591) | See Section 1 | 20 (0.787) | 2.5 (0.098) | 10 (0.394) |

2.2.2: C-Lead Configuration



| Pinouts: | |
|----------|---------------|
| 1-5 | Common* |
| 6-18 | Not Connected |
| 19-24 | Positive* |

* Devices are non polar but it is usual to maintain case at ground potential.

Connector must be ordered separately.

TABLE 2.2.2: C-LEAD LAYOUT DIMENSIONS

| Case Size | PCB Dimensions: mm (inches) | | | | |
|-----------|-----------------------------|----------------------|--------------|--------------|-------------------|
| | OAL ±0.5 (0.020) | W +1.0 (0.040)/-0 | CW* | CL* | G ±0.5 (0.020) |
| BZ01 | 33.05 (1.301) | 17 (0.669) | 4.05 (0.159) | 13.9 (0.547) | 1.0 (0.039) |
| BZ05 | 25.05 (0.986) | 15 (0.591) | 4.05 (0.159) | 13.9 (0.547) | 1.0 (0.039) |

* See Connector data sheet.



BestCap[®] Ultra-low ESR High Power Pulse Supercapacitors



SECTION 2: MECHANICAL SPECIFICATIONS (cont'd)

2.3.1: H-Style Case Dimensions (Through Hole Extended Height)

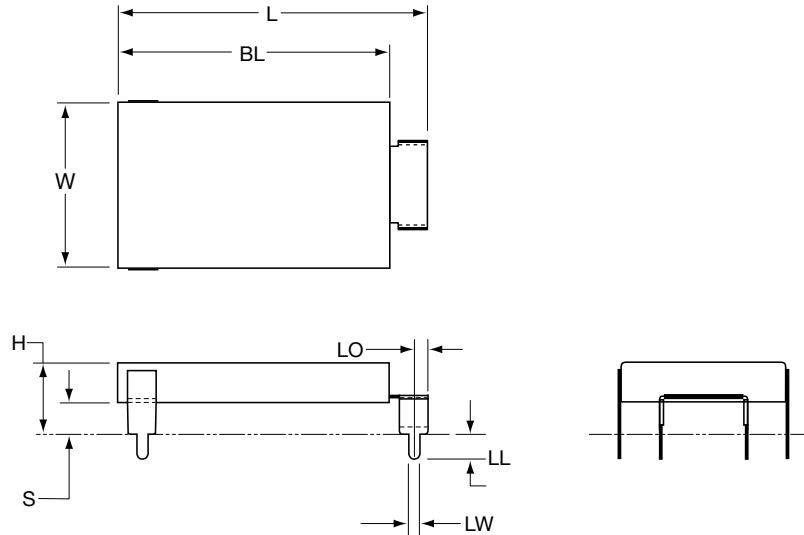

TABLE 2.3.1: H-STYLE CASE DIMENSIONS

| Case Size | Case Dimensions: mm (inches) | | | | | | | |
|-----------|------------------------------|----------------------|----------------|-------------------|------------------------------------|--------------------|--------------------|--------------------|
| | BL +1.0 (0.040)/-0 | W +1.0 (0.040)/-0 | H (Maximum) | L ±1.0 (0.040) | S +0.5 (0.020)/ -0.4 (0.016) | LO ±0.2 (0.008) | LW ±0.2 (0.008) | LL ±0.2 (0.008) |
| BZ01 | 28 (1.102) | 17 (0.669) | See Section 1 | 32 | 3.0 | 1.5 (0.059) | 1.27 (0.050) | 2.5 (0.098) |
| BZ02 | 48 (1.890) | 30 (1.181) | See Section 1 | 52 | 3.0 | 1.5 (0.059) | 1.27 (0.050) | 2.5 (0.098) |

2.3.2: H-Lead Configuration (Through Hole Extended Height)

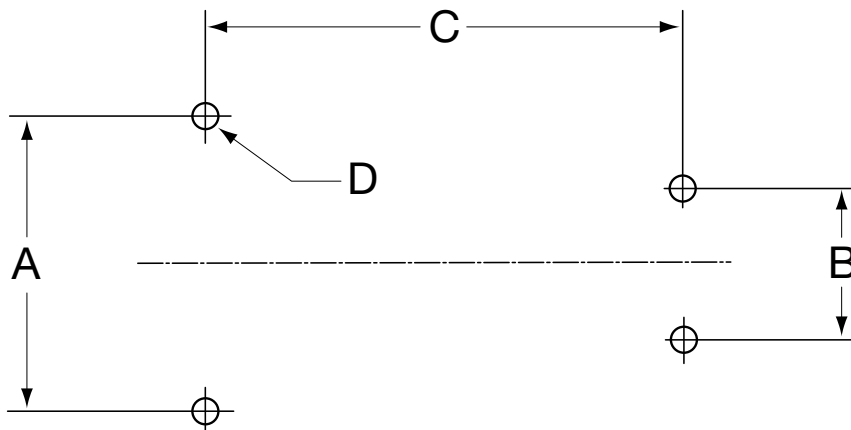

TABLE 2.3.2: H-LEAD LAYOUT DIMENSIONS

| Case Size | PCB Dimensions: mm (inches) | | | |
|-----------|-----------------------------|--------------------|--------------------|-------------------|
| | A ±0.05 (0.002) | B ±0.05 (0.002) | C ±0.05 (0.002) | D ±0.1 (0.004) |
| BZ01 | 17.25 (0.679) | 8.90 (0.350) | 28 (1.102) | Ø1.4 (0.055) |
| BZ02 | 30.25 (1.191) | 8.90 (0.350) | 48 (1.890) | Ø1.4 (0.055) |



BestCap® Ultra-low ESR High Power Pulse Supercapacitors



SECTION 2: MECHANICAL SPECIFICATIONS (cont'd)

2.4.1: L-Lead Configuration (Planar Mount)

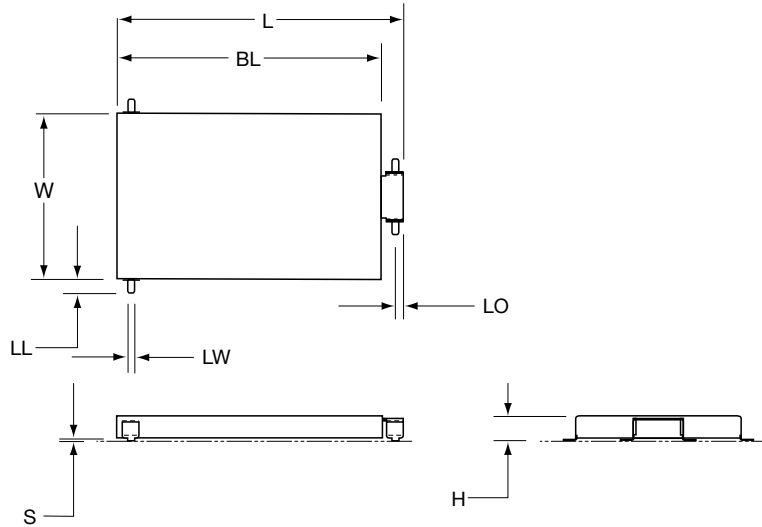

TABLE 2.4.1: L-STYLE CASE DIMENSIONS

| Case Size | Case Dimensions: mm (inches) | | | | | | | |
|-----------|------------------------------|----------------------|----------------|-------------------|-------------------|--------------------|--------------------|--------------------|
| | BL +1.0 (0.040)/-0 | W +1.0 (0.040)/-0 | H (Maximum) | L ±1.0 (0.040) | S ±0.2 (0.008) | LO ±0.2 (0.008) | LW ±0.2 (0.008) | LL ±0.5 (0.020) |
| BZ01 | 28 (1.102) | 17 (0.6691) | See Section 1 | 33 | 0.55 (0.022) | 1.5 (0.059) | 1.27 (0.050) | 2.4 (0.098) |
| BZ02 | 48 (1.890) | 30 (1.181) | See Section 1 | 52 | 0.55 (0.022) | 1.5 (0.059) | 1.27 (0.050) | 2.4 (0.098) |

2.4.2: L-Lead Configuration (Planar Mount)

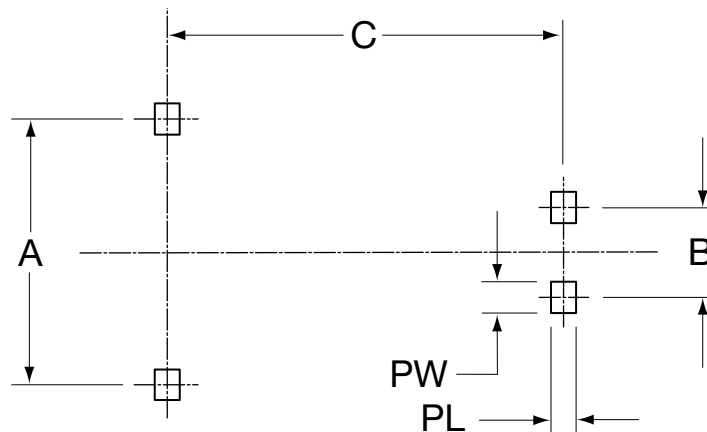

TABLE 2.4.2: L-STYLE LEAD LAYOUT

| Case Size | PCB Dimensions: mm (inches) | | | | |
|-----------|-----------------------------|-------------------|-------------------|--------------------|--------------------|
| | A ±0.1 (0.004) | B ±0.1 (0.004) | C ±0.1 (0.004) | PL ±0.2 (0.008) | PW ±0.2 (0.008) |
| BZ01 | 19.2 (0.776) | 10.8 (0.425) | 28 (1.102) | 3.0 (0.118) | 3.7 (0.146) |
| BZ02 | 32.2 (1.268) | 10.8 (0.425) | 48 (1.890) | 3.2 (0.126) | 3.7 (0.146) |



BestCap[®] Ultra-low ESR High Power Pulse Supercapacitors



SECTION 2: MECHANICAL SPECIFICATIONS (cont'd)

2.5.1: N-Lead Configuration

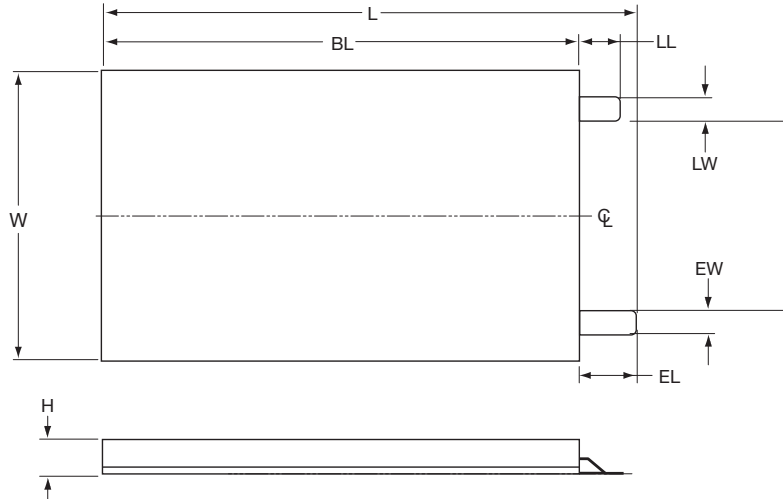

TABLE 2.5.1: N-STYLE CASE DIMENSIONS

| Case Size | Case Dimensions: mm (inches) | | | | | | | |
|-----------|------------------------------|----------------------|----------------|-------------------|--------------------|--------------------|--------------------|--------------------|
| | L ±0.5 (0.020) | W +1.0 (0.040)/-0 | H (Maximum) | B ±0.5 (0.020) | LL ±0.2 (0.008) | LW ±0.2 (0.008) | EL ±0.5 (0.020) | EW ±0.5 (0.020) |
| BZ01 | 30.5 (1.201) | 17 (0.669) | See Section 1 | 11.2 (0.441) | 2.5 (0.098) | 1.4 (0.055) | 2.5 (0.098) | 1.4 (0.055) |
| BZ05 | 23.5 (0.925) | 15 (0.591) | See Section 1 | 7.5 (0.295) | 2.5 (0.098) | 2.5 (0.098) | 3.5 (0.138) | 2.5 (0.098) |
| BZ09 | 20.5 (0.807) | 15 (0.591) | See Section 1 | 7.5 (0.295) | 2.5 (0.098) | 2.5 (0.098) | 3.5 (0.138) | 2.5 (0.098) |

2.5.2: N-Lead Configuration (Planar Mount)

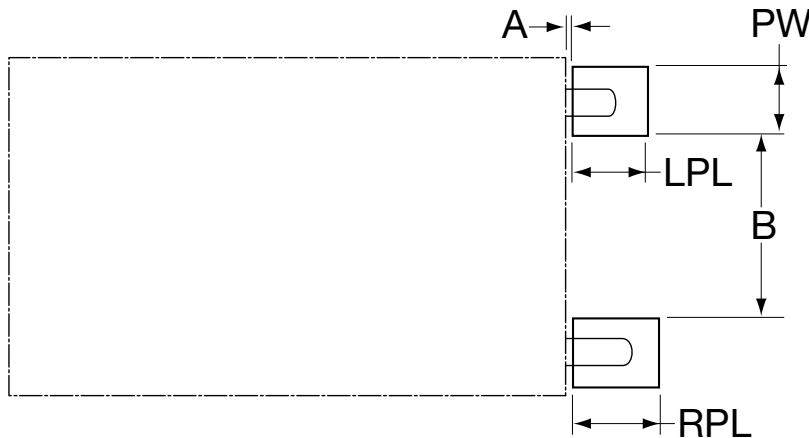

TABLE 2.5.2: N-STYLE LEAD LAYOUT

| Case Size | PCB Dimensions: mm (inches) | | | | |
|-----------|-----------------------------|-------------------|--------------------|---------------------|---------------------|
| | A ±0.5 (0.020) | B ±0.1 (0.004) | PW ±0.1 (0.004) | LPL ±0.1 (0.004) | RPL ±0.1 (0.004) |
| BZ01 | 0.5 (0.020) | 9.5 (0.374) | 3.2 (0.126) | 3.5 (0.138) | 3.5 (0.138) |
| BZ05 | 1.0 (0.039) | 5.9 (0.232) | 4.1 (0.161) | 2.5 (0.098) | 3.5 (0.138) |
| BZ09 | 1.0 (0.039) | 5.9 (0.232) | 4.1 (0.161) | 2.5 (0.098) | 3.5 (0.138) |



BestCap[®] Ultra-low ESR High Power Pulse Supercapacitors



SECTION 2: MECHANICAL SPECIFICATIONS (cont'd)

2.6.1: S-Lead Configuration (Planar Mount)

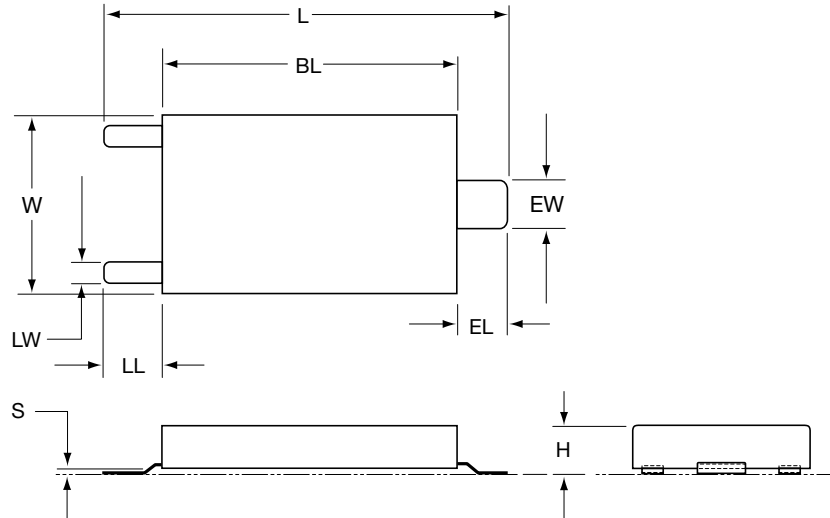
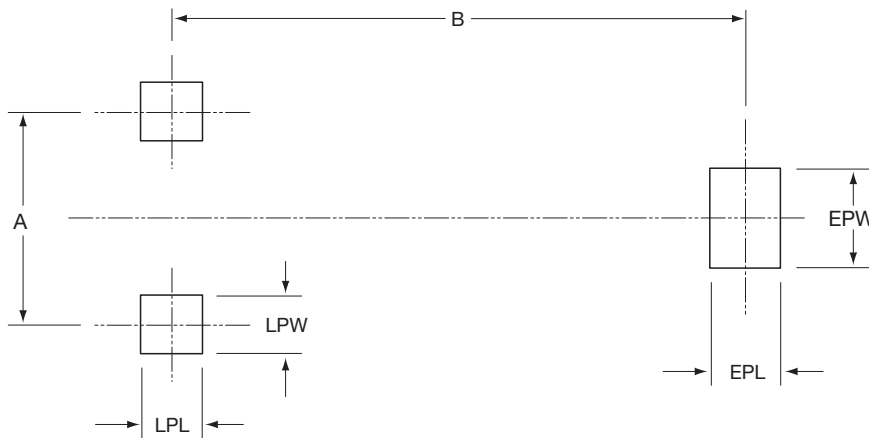

TABLE 2.6.1: S-STYLE CASE DIMENSIONS

| Case Size | Case Dimensions: mm (inches) | | | | | | | |
|-----------|------------------------------|----------------------|----------------|-------------------|--------------------|--------------------|--------------------|--------------------|
| | BL +1.0 (0.040)/-0 | W +1.0 (0.040)/-0 | H (Maximum) | L ±1.0 (0.040) | EL ±0.5 (0.020) | EW ±0.2 (0.008) | LL ±0.5 (0.020) | LW ±0.2 (0.008) |
| BZ01 | 28 (1.102) | 17 (0.669) | See Section 1 | 38.7 (1.524) | 5.0 (0.197) | 4.5 (0.177) | 5.7 (0.224) | 2.0 (0.079) |
| BZ05 | 20 (0.787) | 15 (0.591) | See Section 1 | 26 (1.024) | 3.5 (0.138) | 2.5 (0.098) | 2.5 (0.098) | 2.5 (0.098) |
| BZ09 | 17 (0.669) | 15 (0.591) | See Section 1 | 23 (0.906) | 3.5 (0.138) | 2.5 (0.098) | 2.5 (0.098) | 2.5 (0.098) |

2.6.2: S-Lead Layout (Planar Mount)



Planar Mount "S"

Available in
BZ01, BZ05
& BZ09
Case Size Only

TABLE 2.6.2: S-STYLE PAD LAYOUT DIMENSIONS

| Case Size | PCB Dimensions: mm (inches) | | | | | |
|-----------|-----------------------------|-------------------|---------------------|---------------------|---------------------|---------------------|
| | A ±0.1 (0.004) | B ±0.1 (0.004) | EPL ±0.1 (0.004) | EPW ±0.1 (0.004) | LPL ±0.1 (0.004) | LPW ±0.1 (0.004) |
| BZ01 | 13.0 (0.512) | 35.1 (1.382) | 4.5 (0.177) | 6.0 (0.236) | 5.8 (0.228) | 3.5 (0.138) |
| BZ05 | 10.0 (0.394) | 25.0 (0.984) | 3.0 (0.118) | 4.5 (0.177) | 2.9 (0.114) | 4.5 (0.177) |
| BZ09 | 10.0 (0.394) | 22.0 (0.886) | 3.0 (0.118) | 4.5 (0.177) | 2.9 (0.114) | 4.5 (0.177) |

BestCap® Ultra-low ESR High Power Pulse Supercapacitors



SECTION 2: MECHANICAL SPECIFICATIONS (cont'd)

2.7: Packaging Specifications

BZ01 Case:

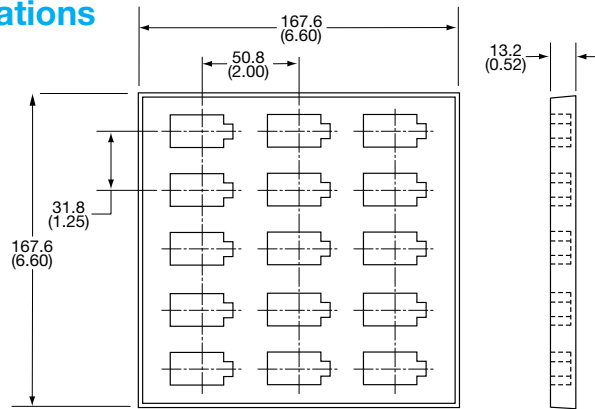

BZ02 Case:

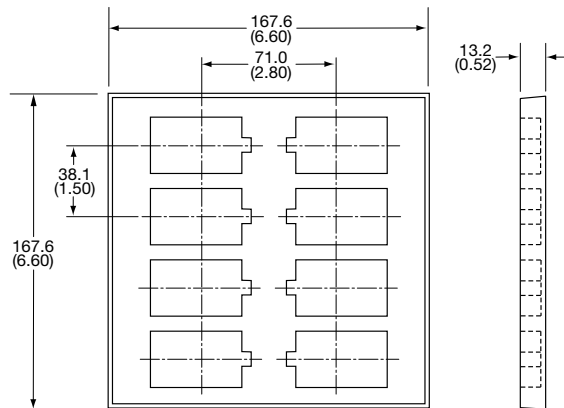

BZ05, BZ09 Case:

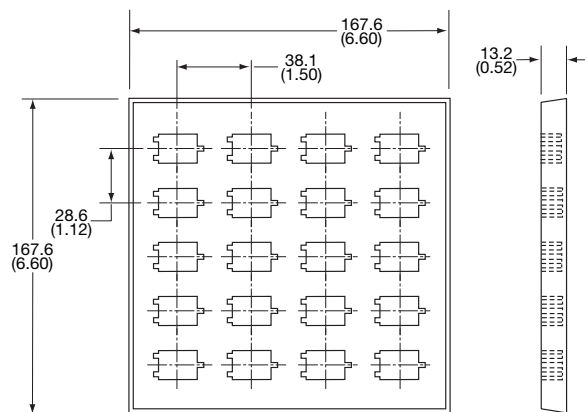

This specification applies when our electrochemical supercapacitors are packed using a 165mm by 165mm container. The parts are held in place by a 166mm by 166mm lid.

PACKAGING QUANTITIES:

| Size | No. of Rows | No. of Columns | Pieces/Tray |
|------|-------------|----------------|-------------|
| BZ01 | 5 | 3 | 15 |
| BZ02 | 4 | 2 | 8 |
| BZ05 | 5 | 4 | 20 |
| BZ09 | 5 | 4 | 20 |



BestCap® Ultra-low ESR High Power Pulse Supercapacitors



SECTION 2: MECHANICAL SPECIFICATIONS

2.8 CLEANING

The BestCap® supercapacitor is cleaned prior to shipment. Should cleaning be required prior to insertion into the application, it is recommended to use a small amount of propanol taking care not to remove the label. The cell should not be immersed due to possible deterioration of the epoxy encapsulation. Care must also be taken not to bend the leads.

2.9 HANDLING

Care should be taken not to allow grease or oil into the part as it may lead to soldering problems. Handling should be minimized to reduce possible bending of the electrodes leads.

2.10 STORAGE CONDITIONS

AVX BestCap® supercapacitor are unaffected by the following storage conditions.

- Temperature: 15°C ~ 35°C
- Humidity: 45% RH ~ 75% RH

This temperature and humidity range are specified for consideration of terminal solderability. BestCap® are able to withstand shelf life at 70°C for 1000 hours.

2.11 PART MARKING

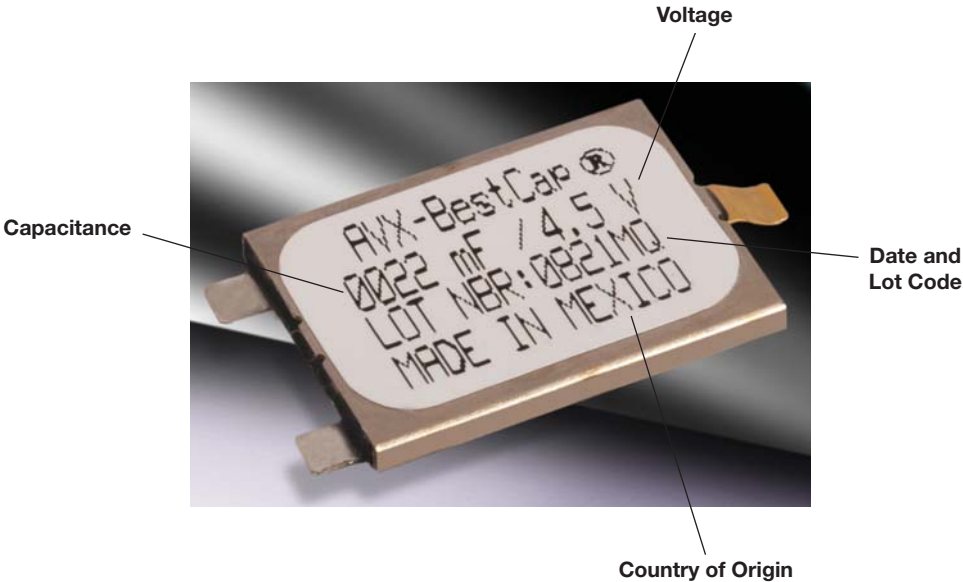

2.12 TERMINATION FINISH

Gold over nickel, tin over nickel.



BestCap® Ultra-low ESR High Power Pulse Supercapacitors



2.13 PRODUCT SAFETY MATERIALS HANDLING

Precautions

- Do not disassemble the capacitor.
- Do not incinerate the capacitor and do not use incineration for disposal.
- The capacitor contains polymeric electrolyte and carbon electrodes. However, since the polymer is composed of acid based chemical ingredients, if punctured or dismantled and the skin is contacted with the capacitor internal components, it is recommended to wash the skin with excess of running water.
- If any internal material contacts the eyes, rinse thoroughly with running water.
- Be aware not to apply over-voltage. Combination of charging at voltage greater than the nominal, plus high temperature, plus prolonged time-may result in capacitor bulging or rupturing.

2.14 BESTCAP® MATERIALS AND WEIGHT

| Materials | Constituent | RoHS Compliant? | BZ01 | BZ02 | BZ05 | BZ09 |
|-------------------------------|------------------------------|-----------------|----------|----------|----------|----------|
| | | | Weight % | Weight % | Weight % | Weight % |
| Case | Stainless Steel | YES | 56.7% | 44.5% | 64.8% | 64.8% |
| Leads (A, H, and L lead only) | Stainless Steel | YES | 4.2% | 0.7% | | |
| Electrode | Stainless Steel | YES | 13.6% | 8.0% | 13.6% | 13.6% |
| Electrode Insulation | Laminating Adhesive | YES | 2.3% | 1.0% | 2.4% | 2.4% |
| Core | Metallized Current Collector | YES | 5.2% | 8.0% | 1.6% | 1.6% |
| | Current Collector | YES | 2.5% | 14.3% | 1.0% | 1.0% |
| | Active Electrode | YES | 1.0% | 5.7% | 0.4% | 0.4% |
| | Core Sealant | YES | 0.9% | 5.2% | 0.3% | 0.3% |
| Encapsulant | Epoxy | YES | 10.3% | 11.4% | 11.8% | 11.8% |
| Bottom Insulation | Laminating Adhesive | YES | 2.3% | 1.0% | 2.4% | 2.4% |
| Label | Label | YES | 1.0% | 0.2% | 1.8% | 1.8% |
| TOTAL | | | 100% | 100% | 100% | 100% |

BestCap® is RoHS compliant

May be assembled with Pb-Free solder.



BESTCAP® – TYPICAL WEIGHT DATA

| Rated Voltage (V) | Capacitance (mF) | Part Number | Weight (g) |
|-------------------|------------------|----------------|------------|
| 3.6V | 50 | BZ013B503Z_B | 2.9 |
| | 70 | BZ013A703Z_B | 4.2 |
| | 100 | BZ113B104Z_B | 2.9 |
| | 140 | BZ013A144Z_B | 5.3 |
| | 280 | BZ023A284Z_B | 12.2 |
| | 560 | BZ023A564Z_B | 15.9 |
| 4.5V | 15 | BZ094B153Z_B | 1.5 |
| | 22 | BZ054B223Z_BBQ | 1.8 |
| | 33 | BZ014B333Z_B | 3.2 |
| | 47 | BZ154B473Z_BBQ | 1.8 |
| 5.5V | 15 | BZ055B153Z_B | 1.9 |
| | 30 | BZ015B303Z_B | 3.4 |
| | 33 | BZ055A333Z_B | 2.3 |
| | 33 | BZ055B333Z_B | 2.1 |
| | 50 | BZ015A503Z_B | 4.6 |
| | 60 | BZ015B603Z_B | 5.5 |
| | 68 | BZ055A683Z_B | 3.4 |
| | 100 | BZ015A104Z_B | 6.1 |
| | 200 | BZ025A204Z_B | 13.3 |
| | 400 | BZ025A404Z_B | 18.4 |
| | 1000 | BZ125A105Z_B | 18.4 |
| 9.0V | 22 | BZ019B223Z_B | 4.4 |
| | 33 | BZ019A333Z_B | 5.0 |
| | 120 | BZ029A124Z_B | 15.6 |
| 12.0V | 10 | BZ05CA103Z_B | 3.5 |
| | 15 | BZ01CB153Z_B | 5.0 |
| | 22 | BZ01CA223Z_B | 6.2 |
| | 90 | BZ02CA903Z_B | 19.3 |
| 15.0V | 6.8 | BZ05FB682Z_B | 2.8 |
| 16.0V | 124 | BZ12GA124Z_B | 25 |



BestCap® Ultra-low ESR High Power Pulse Supercapacitors



SECTION 3: ELECTRICAL CHARACTERISTICS – SCHEMATIC

3.1 Terminal Connections: 3.1.1: S-Lead

3.1.2: A-, H- & L-Lead

3.1.3: C- & N-Lead

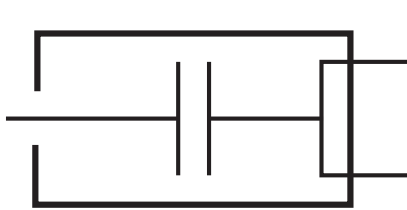

Common terminals connected to case

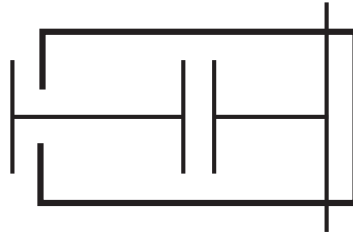

Common terminals connected to case

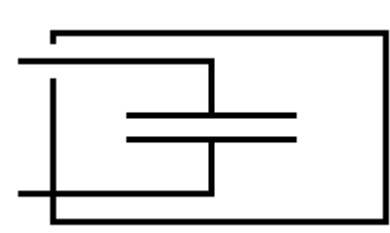

Devices are non polar but it is usual to maintain case at ground potential

SECTION 3.2: TYPICAL CHARACTERISTICS

Capacitance vs. Temperature

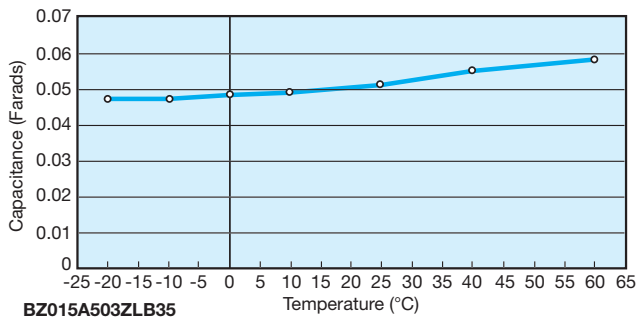

ESR vs. Temperature

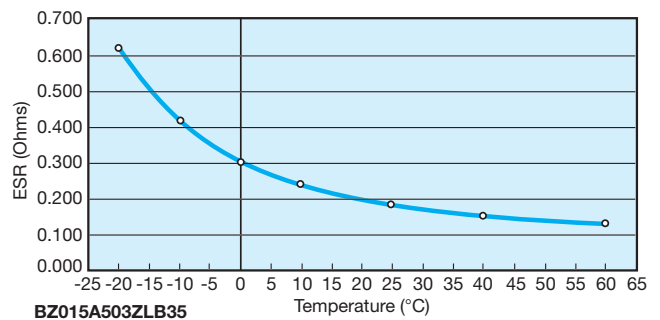

ESR vs. Frequency

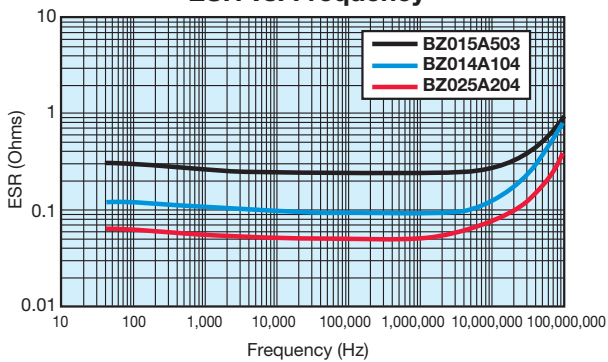

ESR Comparison

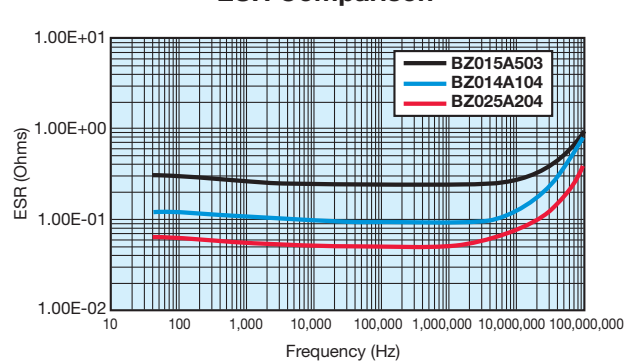

Impedance vs. Frequency

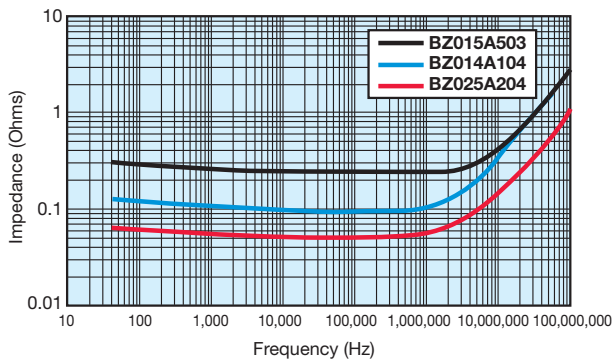

Impedance Comparison

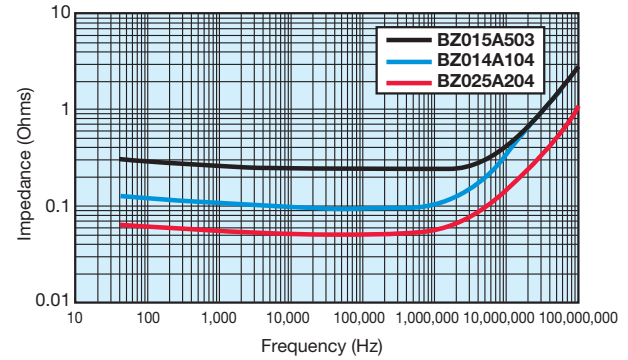

BestCap® Ultra-low ESR High Power Pulse Supercapacitors



SECTION 3.3: MOUNTING PROCEDURE ON A PCB FOR BESTCAP®

BestCap® products can be mounted on PCBs by either selectively heating only the capacitor terminals by using a pulsed reflow soldering station or by using hand soldering. IR Reflow or wave soldering may not be used. The main body of the device should be less than 60°C at all times.

PULSED REFLOW SOLDERING

Application data for the 'Unitek' pulsed-reflow soldering station.

Equipment:

| | |
|-----------------------|-----------------------------------|
| Controller | Uniflow 'Pulsed Thermode Control' |
| Head | Thin-line Reflow Solder Head |
| Solder paste type | No Clean Flux |
| Solder composition | 63% Sn, 37% Pb |
| Percent solids | 88% |
| Solder thickness | 6 mils |
| Solder-weld tip size | 0.075" |
| Solder-weld tip force | 6 lbs. |

Temperature profile:

| | Temperature | Time |
|----------|-------------|--------|
| Pre-heat | 130°C | 0 sec. |
| Rise | 440°C (±10) | 2 sec. |
| Reflow | 440°C (±10) | 2 sec. |
| Cool | 165°C | |

HAND SOLDERING STATION

| | |
|--------------|--|
| Equipment: | Temperature controlled, 50W general purpose iron |
| Solder type: | 63Sn/37Pb, rosin core wire |
| Temperature: | 400°C (+20°C - 100°C) |
| Time: | 2 to 5 seconds maximum, smaller time (2 sec.) at 420°C and 5 sec. at 300°C, overall it being a time-temperature relationship. Shorter time, higher temperature is preferred. |
| Solder Type: | Lead Free, 95Sn/5Ag |
| Temperature: | 430°C (+20°C - 100°C) |
| Time: | 2 to 5 seconds maximum, smaller time (2 sec.) at 450°C and 5 sec. at 330°C, overall it being a time-temperature relationship. Shorter time, higher temperature is preferred. |

In both cases, the main body of the BestCap® part should be less than 60°C at all times.

BestCap[®] Ultra-low ESR High Power Pulse Supercapacitors



SECTION 3.4: QUALIFICATION TEST SUMMARY

| Test | Test Method | | Parameter | Limits | |
|---------------------------------|---|---|------------------------------------|---|-------------|
| Initial Capacitance Measurement | Charge to test voltage at room temperature. Disconnect parts from voltage to remove charging effects. Discharge cells with a constant current (4 mA) noting voltage and time 1 and 2 seconds after beginning discharge. $C = I * dt/dv$ | | Capacitance (Cap) | +80% / -20% of rated Cap | |
| Initial DCL Measurement | Charge to test voltage at room temperature. Disconnect parts from voltage to remove charging effects. Note voltage and time 5 minutes and 25 minutes after disconnecting. $I = C * dv/dt$ | | Leakage Current (DCL) | Within Limit | |
| Initial ESR Measurement | Measurement frequency @ 1kHz; Measurement voltage @ 10 mV at room temperature | | Equivalent Series Resistance (ESR) | +20% / -50% of typical value | |
| Load Life | Apply test voltage at 70°C for 1000 hours. Allow to cool to room temperature and measure Cap, DCL and ESR | | DCL Cap ESR | < 2.0x rated max. > 0.7x rated < 3.0x rated | |
| Shelf Life | Maintain at 70°C for 1000 hours with no voltage applied. Allow to cool to room temperature and measure Cap, DCL and ESR. | | DCL Cap ESR | < 1.5x rated max. > 0.7x rated < 2.0x rated | |
| Humidity Life | Maintain at 40°C / 95% RH for 1000 hours. Allow to cool to room temperature and measure Cap, DCL and ESR. | | DCL Cap ESR | < 1.5x rated max. > 0.7x rated < 1.5x rated | |
| Leg pull strength | Apply an increasing force in shear mode until leg pulls away | | Yield Force (A and L leads only) | Not less than 25 pounds shear | |
| Surge Voltage | Step | | | | |
| | 1 | Apply 125% of the rated voltage for 10 seconds | DCL | < 1.5x rated max. | |
| | 2 | Short the cell for 10 minutes | Cap | > 0.7x rated | |
| | 3 | Repeat 1 and 2 for 1000 cycles | ESR | < 1.5x rated | |
| Temperature Cycling | Step | | | | |
| | 1 | Ramp oven down to -20°C and then hold for 15 min. | DCL | < 1.5x rated max. | |
| | 2 | Ramp oven up to 70°C and then hold for 15 min. | Cap | > 0.7x rated | |
| | 3 | Repeat 1 and 2 for 100 cycles | ESR | < 1.5x rated | |
| Temperature Characteristics | Step | Temp | Soak Time (prior to test) | | |
| | 1 | -40°C | 4 hours | DCL | |
| | | Measure Cap, ESR, DCL (-40°C rated parts only) | | 70°C | < 10x rated |
| | 2 | -20°C | 4 hours | | |
| | | Measure Cap, ESR, DCL | | | |
| | 3 | -10°C | 4 hours | | |
| | | Measure Cap, ESR, DCL | | Cap | |
| | 4 | 0°C | 4 hours | 25°C | > 80% rated |
| | | Measure Cap, ESR, DCL | | | |
| | 5 | 25°C | 4 hours | ESR | |
| | | Measure Cap, ESR, DCL | | -40°C | < 20x rated |
| | 6 | 40°C | 4 hours | -20°C | < 5x rated |
| | | Measure Cap, ESR, DCL | | -10°C | < 4x rated |
| 7 | 60°C | 4 hours | 70°C | < 1.3x rated | |
| | Measure Cap, ESR, DCL | | | < 1.3x rated | |
| 8 | 70°C | 4 hours | | | |
| | Measure Cap, ESR, DCL | | | | |
| Thermal Shock | Step | | | | |
| | 1 | Place cells into an oven at -20°C for 30 minutes | DCL | < 2.0x rated max. | |
| | 2 | In less than 15 seconds, move cells into a 70°C oven for 30 minutes | Cap | > 0.7x rated | |
| | 3 | Repeat 1 and 2 for 100 cycles | ESR | < 2.0x rated max. | |
| Vibration | Step | | | | |
| | 1 | Apply a harmonic motion that is deflected 0.03 inches | DCL | < 2.0x rated max. | |
| | 2 | Vary frequency from 10 cycles per second to 55 cycles at a ramp rate of 1 Hz per minute | Cap | > 0.7x rated | |
| | 3 | Vibrate the cells in the X-Y direction for three hours | ESR | < 2.0x rated max. | |
| | 4 | Vibrate the cells in the Z direction for three hours | | | |
| 5 | Measure Cap, ESR and DCL | | | | |

BestCap® Ultra-low ESR High Power Pulse Supercapacitors



SECTION 4: APPLICATION NOTES

4.1: ELECTROCHEMICAL EDLC VS. ELECTRONIC TECHNOLOGY - BESTCAP® CONSTRUCTION

To understand the benefits offered by the BestCap®, it is necessary to examine how an electrochemical capacitor works. The most significant difference between an electronic capacitor and an electrochemical capacitor is that the charge transfer is carried out by the electrons in the former and by electrons and ions in the latter. The anions and cations involved in double layer supercapacitors are contained in the electrolyte which maybe liquid, (normally an aqueous or organic solution) or solid. The solid electrolyte is almost universally a conductive polymer.

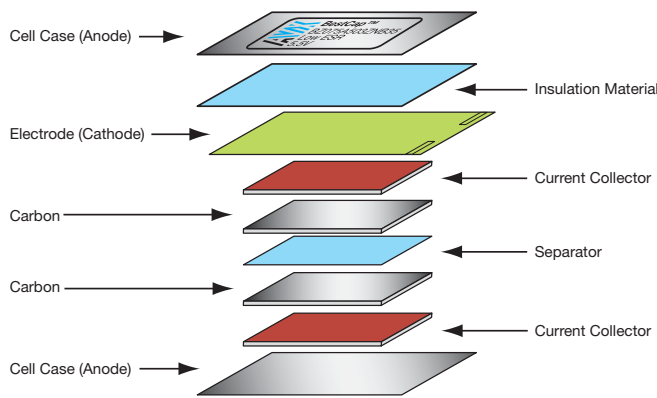

Electrons are relatively fast moving and therefore transfer charge “instantly”. However, ions have to move relatively slowly from anode to cathode, and hence a finite time is needed to establish the full nominal capacitance of the device. This nominal capacitance is normally measured at 1 second.

The differences between EDLC (Electrochemical Double Layer Capacitors) and electronic capacitors are summarized in the table below:

| |
|---|
| <ul style="list-style-type: none"> • A capacitor basically consists of two conductive plates (electrodes), separated by a layer of dielectric material. |
| <ul style="list-style-type: none"> • These dielectric materials may be ceramic, plastic film, paper, aluminum oxide, etc. |
| <ul style="list-style-type: none"> • EDLCs do not use a discrete dielectric interphase separating the electrodes. |
| <ul style="list-style-type: none"> • EDLCs utilize the charge separation, which is formed across the electrode – electrolyte interface. |
| <ul style="list-style-type: none"> • The EDLC constitutes of two types of charge carriers: IONIC species on the ELECTROLYTE side and ELECTRONIC species on the ELECTRODE side. |

4.2: VOLTAGE DROP

Two factors are critical in determining the voltage drop when a capacitor delivers a short current pulse; these are ESR and “available” capacitance as shown in Figure 4.

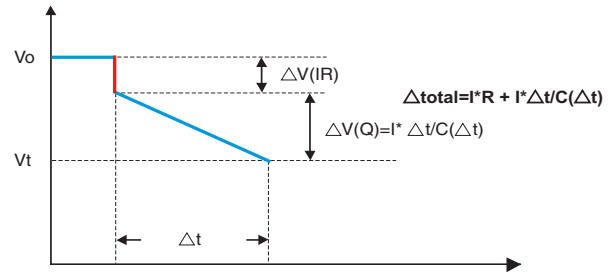

Figure 4. Voltage-time relation of capacitor unit

The instant voltage drop ΔV_{ESR} is caused by and is directly proportional to the capacitor’s ESR. The continuing voltage drop with time ΔV_C , is a function of the available charge, i.e. capacitance. From Figures 3 and 4, it is apparent that, for very short current pulses, e.g. in the millisecond region, the combination of voltage drops in a conventional supercapacitor caused by a) the high ESR and b) the lack of available capacitance, causes a total voltage drop, unacceptable for most applications. Now compare the BestCap® performance under such pulse conditions. The ultra-low ESR, (in milliOhms), minimizes the instantaneous voltage drop, while the very high retained capacitance drastically reduces the severity of the charge related drop. This is explained further in a later section.

EFFICIENCY/TALKTIME BENEFITS OF BESTCAP®

Because BestCap®, when used in parallel with a battery, provides a current pulse with a substantially higher voltage than that available just from the battery as shown in Figure 5, the efficiency of the RF power amplifier is improved.

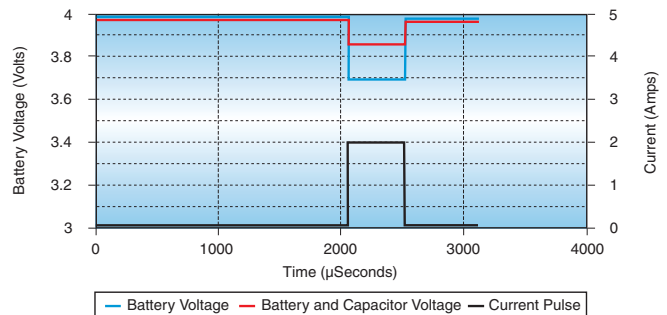

Figure 5. GSM Pulse

Additionally, the higher-than battery voltage supplied by the BestCap® keeps the voltage pulse above the “cut off voltage” limit for a significantly longer time than is the case for the battery alone. This increase in “talk time” is demonstrated in Figures 6(a) (Li-Ion at +25°C), and 6(b) (Li-Ion at 0°C).

BestCap® Ultra-low ESR High Power Pulse Supercapacitors

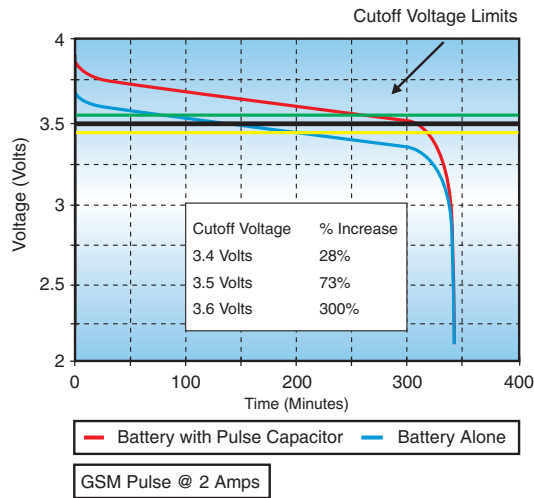

Figure 6a. Li-ION Battery at +25°C

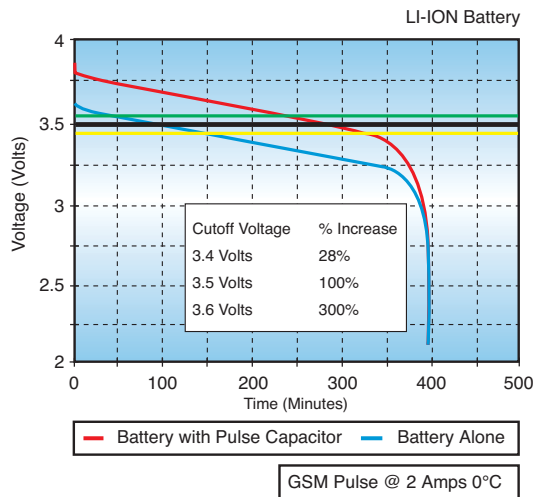

Figure 6b. Li-ION Battery at +0°C

PULSE CAPACITOR APPLICATIONS

As mentioned earlier, the voltage drop in a circuit is critical as the circuit will not operate below a certain cut-off voltage. There are two sources of voltage drop (ΔV) which occur, the first ΔV_{ESR} is because of the equivalent series resistance (ESR) and the second, called the capacitive drop, is ΔV_C . From Ohm's law,

$$\text{voltage} = \text{current} \times \text{resistance} \text{ or } V = IR$$

Let us say that the instantaneous starting voltage is V_0 , or voltage for the circuit from where the voltage drops. If the capacitor has an ESR of 100 milliOhms and the current is 1 amp,

$$\Delta V_{ESR} = 1 \text{ amp} \times (0.100) \text{ ohms} = 0.1 \text{ volts or } 100 \text{ milli-volts.}$$

On demand, during the discharge mode, the voltage $V = V_0 - \Delta V_{ESR} = (V_0 - 0.1) \text{ volts}$

The second voltage drop is because of the capacitance. This is shown in the equation as a linear function because of simplicity. Simply put,

$$Q \text{ (charge)} = C \text{ (capacitance)} \times V \text{ (voltage)}$$

The derivative, $dQ/dt = I$ (current, in amps) = $C \times dV/dt$

Hence, ΔV_C (dV , the voltage drop because of capacitance) = $I \times dt/C$. This formula states that the larger the capacitance value the lower the voltage drop. Compared to a Ta capacitor this ΔV_C is reduced by a factor of about 10 to 100. So, BestCap® has an advantage where higher capacitance is needed. If the current pulse itself is 1 amp, the current pulse width is 1 second, and the capacitance is 10 millifarads, the $\Delta V_C = 1A \times 1\text{Sec}/0.01F$, or a 100 volts; such an application is out of the range of BestCap®. However, if the pulse width becomes narrower, say 10 milli-seconds, and the capacitance is 100 millifarads, the $\Delta V_C = 1 \times (10/1000)/(100/1000) = 0.1 \text{ volt or } 100 \text{ milli-volts}$. This shows the advantage of the large capacitance and hence the term "pulse" capacitor. The specific power – specific energy graphs are used in the battery industry to compare competitive products. As the dt becomes smaller i.e. 100 milliseconds, 10 milliseconds and then 1 millisecond, our estimates show that the specific power for the BestCap® is the highest as compared to our competitors because of our choice of internal materials chemistry.

Conclusion: we now clearly show that BestCap® has an advantage over competitors for short current pulse whose widths are smaller than a few hundred milliseconds.

BestCap® Ultra-low ESR High Power Pulse Supercapacitors



4.3 ENHANCING THE POWER CAPABILITY OF PRIMARY BATTERIES

When electronic equipment is powered by a primary (non rechargeable) battery, one of the limitations is the power capability of the battery.

In order to increase the available current from the battery, while maintaining a constant voltage drop across the battery terminals, the designer must connect additional cells in parallel leading to increased size and cost of both the battery and the finished product.

When high power is only required for short periods more sophisticated approaches can be considered. The traditional approach involves using a high power rechargeable battery, charged by a low power primary cell.

A far superior solution, however, is the use of a BestCap® Supercapacitor, which is a device specifically designed to deliver high power.

Traditional design:

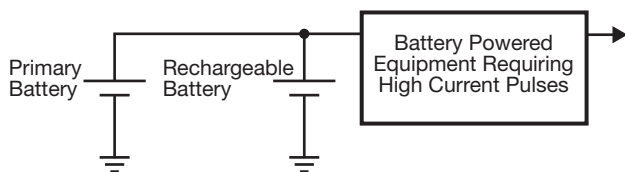

Design using BestCap®:

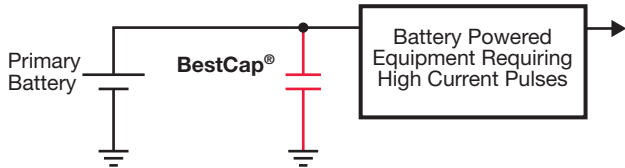

BestCap® Supercapacitor benefits to the designer are:

- Substantially lower voltage drop for pulse durations of up to 100msec.
- Substantially lower voltage drop at cold temperatures (-20°C).
- Discharge current limited only by the ESR of the capacitor

The following analysis compares a primary battery connected in parallel to a Lithium Tionil Chloride, to the same primary battery connected to a BestCap® Supercapacitor. Various current pulses (amplitude and duration) are applied in each case.

BestCap® 5.5V 100mF

| Pulse | Voltage Drop (mV) BestCap® Supercapacitors | Voltage Drop (mV) rechargeable battery |
|--------------------------|---|---|
| 250mA / 1msec | 25 | 150 |
| 500mA / 1msec | 50 | 220 |
| 750mA / 1msec | 75 | 150 |
| 200mA / 100msec at -20°C | 232 | 470 |

BestCap® 3.5V 560mF

| Pulse | Voltage Drop (mV) BestCap® Supercapacitors | Voltage Drop (mV) rechargeable battery |
|--------------------------|---|---|
| 250mA / 100msec | 50 | 190 |
| 500mA / 100msec | 100 | 350 |
| 750mA / 100msec | 152 | 190 |
| 1500mA / 1msec | 43 | 220 |
| 1500mA / 100msec | 305 | 350 |
| 750mA / 100msec at -20°C | 172 | 470 |

| Additional Characteristics | BestCap® | Rechargeable Battery |
|--|-------------|--------------------------------------|
| Maximum discharge current (single pulse) | Not limited | 5A Maximum |
| Number of Cycles | Not limited | 40K to 400K (to retain 80% capacity) |

BestCap® Ultra-low ESR High Power Pulse Supercapacitors



4.4 BESTCAP FOR GSM/GPRS PCMCIA MODEMS

There is an increasing usage of PCMCIA modem cards for wireless LAN and WAN (Wide Area Network) applications.

The PCMCIA card is used as an accessory to Laptops and PDA's, and enables wide area mobile Internet access, including all associated applications like Email and file transfer.

With the wide spread use of GSM networks, a PCMCIA GSM modem is a commonly used solution. To achieve higher speed data rates, GSM networks are now being upgraded to support the GPRS standard.

The design challenge:

GSM/GPRS transmission requires a current of approximately 2A for the pulse duration. The PCMCIA bus cannot supply this amount of pulsed current. Therefore, there is a need for a relatively large capacitance to bridge the gap.

The capacitor supplies the pulse current to the transmitter, and is charged by a low current during the interval between pulses.

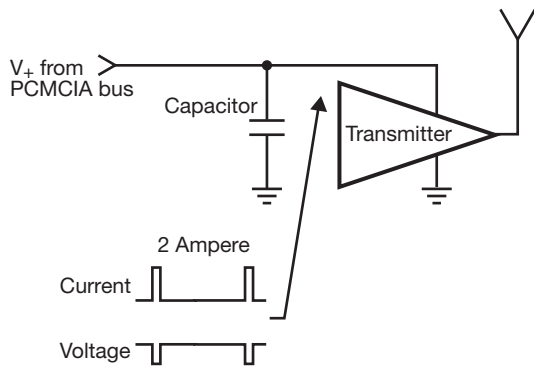

THE SOLUTION:

| | SOLUTION A | SOLUTION B |
|---|---------------|-----------------------|
| | Chip Tantalum | BestCap® BZ154B473ZSB |
| Rated Capacitance (milli Farad) | 2.2 | 47 |
| Capacitance @ 0.5msec Pulse (milli Farad) | 2.2 | 30 |
| Operating Voltage (V) | 3.7 | 3.7 |
| ESR (milli ohm) | 50 | 160 |
| Size (mm) | .4 x 7 x 2 | 20 x 15 x 2.1 |
| Voltage Drop* (V) GPRS Pulse (25% duty cycle) | 0.804V | 0.268V |
| Voltage After Pulse (V) | 2.896 | 3.432 |
| Cutoff Voltage (V) | 3.1 | 3.1 |
| | Pass/FAIL | FAIL |
| | FAIL | PASS |

$$* V = V_1 + V_2 = 1.5A * ESR + (1.5A * 1.154msec) / C$$

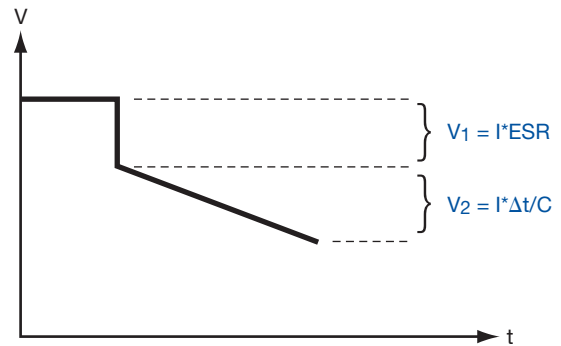

It is assumed that during the pulse, 0.5A is delivered by the battery, and 1.5A by the capacitor.

Conclusion: High capacitance is needed to minimize voltage drop. A high value capacitance, even with a higher ESR, results in a lower voltage drop. Low voltage drop minimizes the conductive and emitted electro magnetic interference, and increases transmitter output power and efficiency.

BestCap® Ultra-low ESR High Power Pulse Supercapacitors



SECTION 5: EXTENDED TEMPERATURE RANGE

AVX continues to expand the BestCap® product offerings for additional applications. For applications demanding other temperature ratings, AVX offers special construction techniques for high and low temperature performance upon request.

AVX offers temperature range extensions as follows: -40°C to 70°C, -20°C to 75°C and -40°C to 75°C.

AVX has extensive experience in manufacturing these alternate temperature rating parts. Contact AVX for your special temperature requirements.



PASSIVES

Capacitors

Multilayer Ceramic
Film
Glass
Niobium Oxide* - OxiCap®
Pulse Supercapacitors
Tantalum

Circuit Protection

Thermistors
Fuses - Thin Film
Transient Voltage Suppressors
Varistors - Zinc Oxide

Directional Couplers

Thin-Film

Filters

Ceramic
EMI
Noise
SAW
Low Pass - Thin Film

Inductors

Thin-Film

Integrated Passive Components

PMC - Thin-Film Networks
Capacitor Arrays
Feedthru Arrays
Low Inductance Decoupling Arrays

Piezo Acoustic Generators

Ceramic

Resistors

Arrays
Miniature Axials

Timing Devices

Clock Oscillators
MHz Quartz Crystal
Resonators
VCO
TCXO

CONNECTORS

Automotive

Standard, Custom

Board to Board

SMD (0.4, 0.5, 1.0mm), BGA, Thru-Hole

Card Edge

DIN41612

Standard, Inverse, High Temperature

FFC/FPC

0.3, 0.5, 1.0mm

Hand Held, Cellular

Battery, I/O, SIMcard, RF shield clips

2mm Hard Metric

Standard, Reduced Cross-Talk

IDC Wire to Board

Headers, Plugs, Assemblies

Memory

PCMCIA, Compact Flash, Secure Digital, MMC,
Smartcard, SODIMM

Military

H Government, DIN41612

Polytect™

Soft Molding

Rack and Panel

Varicon™

**For more information please visit
our website at
<http://www.avx.com>**

NOTICE: Specifications are subject to change without notice. Contact your nearest AVX Sales Office for the latest specifications. All statements, information and data given herein are believed to be accurate and reliable, but are presented without guarantee, warranty, or responsibility of any kind, expressed or implied. Statements or suggestions concerning possible use of our products are made without representation or warranty that any such use is free of patent infringement and are not recommendations to infringe any patent. The user should not assume that all safety measures are indicated or that other measures may not be required. Specifications are typical and may not apply to all applications.

© AVX Corporation

Niobium Oxide Capacitors are manufactured and sold under patent license from Cabot Corporation, Boyertown, Pennsylvania U.S.A.

AMERICAS

AVX Myrtle Beach, SC
Tel: 843-448-9411

AVX Northwest, WA
Tel: 360-699-8746

AVX Midwest, IN
Tel: 317-861-9184

AVX Mid/Pacific, CA
Tel: 408-988-4900

AVX Northeast, MA
Tel: 617-479-0345

AVX Southwest, CA
Tel: 949-859-9509

AVX Canada
Tel: 905-238-3151

AVX South America
Tel: +55-11-4688-1960

EUROPE

AVX Limited, England
Tel: +44-1252-770000

AVX S.A.S., France
Tel: +33-1-69-18-46-00

AVX GmbH, Germany
Tel: +49-8131-9004-0

AVX SRL, Italy
Tel: +39-02-614-571

AVX Czech Republic
Tel: +420-57-57-57-521

AVX/ELCO UK
Tel: +44-1638-675000

ELCO Europe GmbH
Tel: +49-2741-299-0

AVX S.A., Spain
Tel: +34-91-63-97-197

AVX Benelux
Tel: +31-187-489-337

ASIA-PACIFIC

**AVX/Kyocera (S) Pte Ltd.,
Singapore**
Tel: +65-6286-7555

**AVX/Kyocera, Asia, Ltd.,
Hong Kong**
Tel: +852-2363-3303

**AVX/Kyocera Yuhan Hoesa,
South Korea**
Tel: +82-2785-6504

**AVX/Kyocera HK Ltd.,
Taiwan**
Tel: +886-2-2656-0258

**AVX/Kyocera (M) Sdn Bhd,
Malaysia**
Tel: +60-4228-1190

**AVX/Kyocera International
Trading Co. Ltd.,
Shanghai**
Tel: +86-21-6215-5588

**AVX/Kyocera Asia Ltd.,
Shenzen**
Tel: +86-755-3336-0615

**AVX/Kyocera International
Trading Co. Ltd.,
Beijing**
Tel: +86-10-6588-3528

**AVX/Kyocera India
Liaison Office**
Tel: +91-80-6450-0715

ASIA-KED

(KYOCERA Electronic Devices)

KED Hong Kong Ltd.
Tel: +852-2305-1080/1223

**KED Hong Kong Ltd.
Shenzen**
Tel: +86-755-3398-9600

**KED Company Ltd.
Shanghai**
Tel: +86-21-6217-1201

**KED Hong Kong Ltd.
Beijing**
Tel: +86-10-5869-4655

KED Taiwan Ltd.
Tel: +886-2-2950-0268

**KED Korea Yuhan Hoesa,
South Korea**
Tel: +82-2-783-3604/6126

**KED (S) Pte Ltd.
Singapore**
Tel: +65-6509-0328

**Kyocera Corporation
Japan**
Tel: +81-75-604-3449

Contact:





Стандарт Электрон Связь

Мы молодая и активно развивающаяся компания в области поставок электронных компонентов. Мы поставляем электронные компоненты отечественного и импортного производства напрямую от производителей и с крупнейших складов мира.

Благодаря сотрудничеству с мировыми поставщиками мы осуществляем комплексные и плановые поставки широчайшего спектра электронных компонентов.

Собственная эффективная логистика и склад в обеспечивает надежную поставку продукции в точно указанные сроки по всей России.

Мы осуществляем техническую поддержку нашим клиентам и предпродажную проверку качества продукции. На все поставляемые продукты мы предоставляем гарантию .

Осуществляем поставки продукции под контролем ВП МО РФ на предприятия военно-промышленного комплекса России , а также работаем в рамках 275 ФЗ с открытием отдельных счетов в уполномоченном банке. Система менеджмента качества компании соответствует требованиям ГОСТ ISO 9001.

Минимальные сроки поставки, гибкие цены, неограниченный ассортимент и индивидуальный подход к клиентам являются основой для выстраивания долгосрочного и эффективного сотрудничества с предприятиями радиоэлектронной промышленности, предприятиями ВПК и научно-исследовательскими институтами России.

С нами вы становитесь еще успешнее!

Наши контакты:

Телефон: +7 812 627 14 35

Электронная почта: sales@st-electron.ru

Адрес: 198099, Санкт-Петербург,
Промышленная ул, дом № 19, литера Н,
помещение 100-Н Офис 331