

HIGH FREQUENCY HALF-BRIDGE GATE DRIVER WITH PROGRAMMABLE DEADTIME

Description

The DGD05463 is a high-frequency half-bridge gate driver capable of driving N-channel MOSFETs in a half-bridge configuration. The floating high-side driver is rated up to 50V.

The DGD05463 logic inputs are compatible with standard TTL and CMOS levels (down to 3.3V) to interface easily with MCUs. UVLO for high-side and low-side will protect a MOSFET with loss of supply. To protect MOSFETs, cross conduction prevention logic prevents the HO and LO outputs being on at the same time.

Fast and well-matched propagation delays allow a higher switching frequency, enabling a smaller, more compact power switching design using smaller associated components. The DGD05463 is offered in the W-DFN3030-10 (Type TH) and MSOP-10 packages and operates over an extended -40°C to +125°C temperature range.

Applications

- DC-DC Converters
- Motor Controls
- Battery Powered Hand Tools
- eCig Devices
- Class D Power Amplifiers

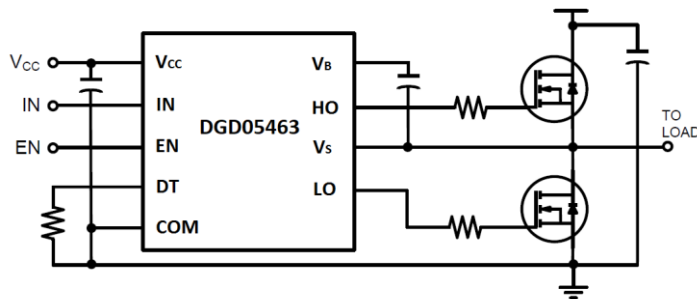

Typical Configuration

W-DFN3030-10 (Type TH)



Top View

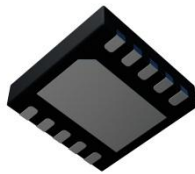

Bottom View

MSOP-10



Top View

Features

- 50V Floating High-Side Driver
- Drives Two N-Channel MOSFETs in a Half-Bridge Configuration
- 1.5A Source / 2.5A Sink Output Current Capability
- Internal Bootstrap Diode Included
- Undervoltage Lockout for High-Side and Low-Side Drivers
- Programmable Deadtime to Protect MOSFETs
- Logic Input (IN and EN) 3.3V Capability
- Ultra Low Standby Currents (<1µA)
- Extended Temperature Range: -40°C to +125°C
- **Totally Lead-Free & Fully RoHS Compliant (Notes 1 & 2)**
- **Halogen and Antimony Free. "Green" Device (Note 3)**

Mechanical Data

- Case: W-DFN3030-10 (Type TH)
- Case Material: Molded Plastic. "Green" Molding Compound. UL Flammability Classification Rating 94V-0
- Moisture Sensitivity: Level 3 per J-STD-020
- Terminals: Finish – Matte Tin Finish. Solderable per MIL-STD-202, Method 208 [Ⓔ]
- Weight: 0.017 grams (Approximate)

Mechanical Data

- Case: MSOP-10
- Case Material: Molded Plastic. "Green" Molding Compound. UL Flammability Classification Rating 94V-0
- Moisture Sensitivity: Level 3 per J-STD-020
- Terminals: Finish – Matte Tin Plated Leads. Solderable per MIL-STD-202, Method 208 [Ⓔ]
- Weight: 0.0286 grams (Approximate)

- Notes:
1. No purposely added lead. Fully EU Directive 2002/95/EC (RoHS), 2011/65/EU (RoHS 2) & 2015/863/EU (RoHS 3) compliant.
 2. See <https://www.diodes.com/quality/lead-free/> for more information about Diodes Incorporated's definitions of Halogen- and Antimony-free, "Green" and Lead-free.
 3. Halogen- and Antimony-free "Green" products are defined as those which contain <900ppm bromine, <900ppm chlorine (<1500ppm total Br + Cl) and <1000ppm antimony compounds.

Ordering Information (Note 4)

Part Number	Package	Marking	Reel Size (inches)	Tape Width (mm)	Quantity per Reel
DGD05463FN-7	W-DFN3030-10 (Type TH)	DGD05463	7	8	3000
DGD05463M10-13	MSOP-10	DGD05463	13	12	2500

Note: 4. For packaging details, go to our website at <https://www.diodes.com/design/support/packaging/diodes-packaging/>.

Marking Information



DGD05463 = Product Type Marking Code
 YY = Year (ex: 18 = 2018)
 WW = Week (01 to 53)

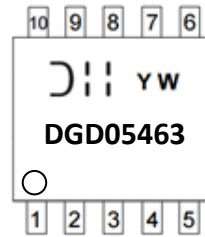

⌋⌋⌋ = Manufacturer's Code Marking
 DGD05463 = Product Type Marking Code
 Y = Year: 0 ~ 9
 W = Week: A ~ Z : 1 ~ 26 week
 a ~ z : 27 ~ 52 week

Pin Diagrams

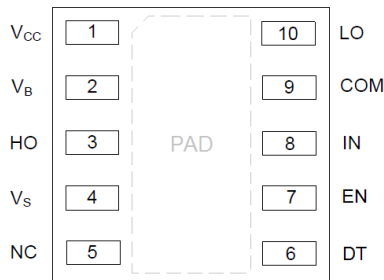

Top View: W-DFN3030-10 (Type TH)

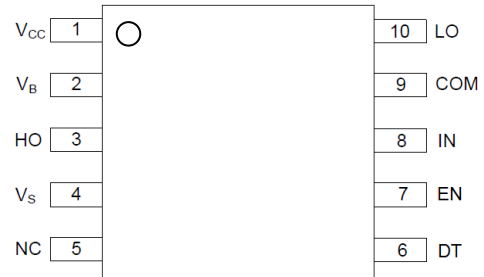

Top View: MSOP-10

Pin Descriptions

Pin Number	Pin Name	Function
1	V _{CC}	Low-Side and Logic Supply
2	V _B	High-Side Floating Supply
3	HO	High-Side Gate Drive Output
4	V _S	High-Side Floating Supply Return
5	NC	No Connection (No Internal Connection)
6	DT	Deadtime Control
7	EN	Logic Input Enable, a Logic Low Turns Off Gate Driver
8	IN	Logic Input for High-Side and Low-Side Gate Driver Outputs (HO and LO), in Phase with HO
9	COM	Low-Side and Logic Return
10	LO	Low-Side Gate Drive Output
PAD	Substrate	Connect to COM on PCB (For W-DFN3030-10 (Type TH) Only)

Functional Block Diagram

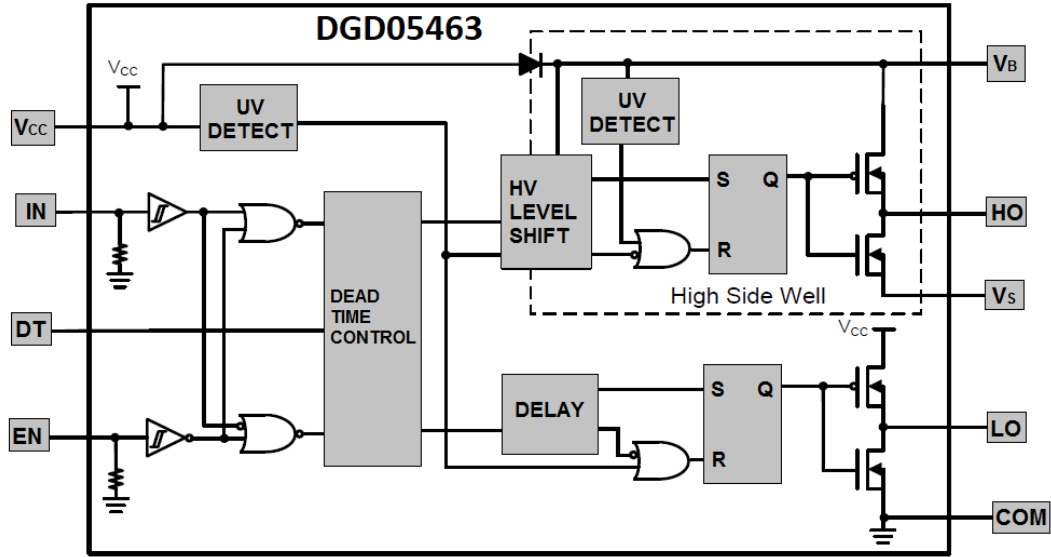

Absolute Maximum Ratings (@T_A = +25°C, unless otherwise specified.)

Characteristic	Symbol	Value	Unit
High-Side Floating Positive Supply Voltage	V _B	-0.3 to +60	V
High-Side Floating Negative Supply Voltage	V _S	V _B -14 to V _B +0.3	V
High-Side Floating Output Voltage	V _{HO}	V _S -0.3 to V _B +0.3	V
Offset Supply Voltage Transient	dV _S / dt	50	V/ns
Logic and Low-Side Fixed Supply Voltage	V _{CC}	-0.3 to +14	V
Low-Side Output Voltage	V _{LO}	-0.3 to V _{CC} +0.3	V
Logic Input Voltage (IN and EN)	V _{IN}	-0.3 to V _{CC} +0.3	V

Thermal Characteristics – W-DFN3030-10 (Type TH) (@T_A = +25°C, unless otherwise specified.)

Characteristic	Symbol	Value	Unit
Power Dissipation Linear Derating Factor (Note 5)	P _D	0.4	W
Thermal Resistance, Junction to Ambient (Note 5)	R _{θJA}	64	°C/W
Thermal Resistance, Junction to Case (Note 5)	R _{θJC}	42	°C/W
Operating Temperature	T _J	+150	°C
Lead Temperature (Soldering, 10s)	T _L	+300	
Storage Temperature Range	T _{STG}	-55 to +150	

Note: 5. When mounted on a standard JEDEC 2-layer FR-4 board.

Thermal Characteristics – MSOP-10 (@T_A = +25°C, unless otherwise specified.)

Characteristic	Symbol	Value	Unit
Power Dissipation Linear Derating Factor (Note 6)	P _D	0.75	W
Thermal Resistance, Junction to Ambient (Note 6)	R _{θJA}	166	°C/W
Thermal Resistance, Junction to Case (Note 6)	R _{θJC}	32	°C/W
Operating Temperature	T _J	+150	°C
Lead Temperature (Soldering, 10s)	T _L	+300	
Storage Temperature Range	T _{STG}	-55 to +150	

Note: 6. When mounted on a standard JEDEC 2-layer FR-4 board with minimum recommended pad layout.

Recommended Operating Conditions

Parameter	Symbol	Min	Max	Unit
High-Side Floating Supply	V _B	V _S + 4.2	V _S + 14	V
High-Side Floating Supply Offset Voltage	V _S	(Note 7)	50 (Note 8)	V
High-Side Floating Output Voltage	V _{HO}	V _S	V _B	V
Logic and Low Side Fixed Supply Voltage	V _{CC}	4.5 (Note 9)	14	V
Low-Side Output Voltage	V _{LO}	0	V _{CC}	V
Logic Input Voltage (IN and EN)	V _{IN}	0	5	V
Ambient Temperature	T _A	-40	+125	°C

Notes: 7. Logic operation for V_S of -5V to +50V.

8. Provided V_B doesn't exceed absolute maximum rating of 60V.

9. For operation of V_{CC} = 4.5V to 4.9V, an external bootstrap Schottky diode (0.3V V_{FD}, 1A) is necessary, see Figure 3. For operation V_{CC} ≥ 4.9V, the external Schottky diode is not required.

DC Electrical Characteristics ($V_{CC} = V_{BS} = 12V$, $COM = V_S = 0V$, @ $T_A = +25^\circ C$, unless otherwise specified.) (Note 10)

Parameter	Symbol	Min	Typ	Max	Unit	Condition
Logic "1" Input Voltage	V_{IH}	2.4	—	—	V	—
Logic "0" Input Voltage	V_{IL}	—	—	0.8	V	—
Enable Logic "1" Input Voltage	V_{ENIH}	1.5	—	—	V	—
Enable Logic "0" Input Voltage	V_{ENIL}	—	—	0.7	V	—
Input Voltage Hysteresis	V_{INHYS}	—	0.6	—	V	—
High Level Output Voltage, $V_{BIAS} - V_O$	V_{OH}	—	0.45	0.6	V	$I_{O+} = 100mA$
Low Level Output Voltage, V_O	V_{OL}	—	0.15	0.22	V	$I_{O-} = 100mA$
Offset Supply Leakage Current	I_{LK}	—	10	50	μA	$V_B = V_S = 60V$
V_{CC} Shutdown Supply Current	I_{CCSD}	—	0	1	μA	$V_{IN} = 0V$ or $5V$, $V_{EN} = 0V$
V_{CC} Quiescent Supply Current	I_{CCQ}	—	0.28	0.5	mA	$V_{IN} = 0V$ or $5V$, $R_{DT} = 100k\Omega$
V_{CC} Operating Supply Current	I_{CCOP}	—	7.6	—	mA	$f_s = 500kHz$, $C_L = 1000pF$
V_{BS} Quiescent Supply Current	I_{BSQ}	—	32	100	μA	$V_{IN} = 0V$ or $5V$
V_{BS} Operating Supply Current	I_{BSOP}	—	7.6	—	mA	$f_s = 500kHz$, $C_L = 1000pF$
Logic "1" Input Bias Current	I_{IN+}	—	25	60	μA	$V_{IN} = 5V$
Logic "0" Input Bias Current	I_{IN-}	—	0	1	μA	$V_{IN} = 0V$
V_{BS} Supply Undervoltage Positive Going Threshold	V_{BSUV+}	3.3	3.8	4.2	V	—
V_{BS} Supply Undervoltage Negative Going Threshold	V_{BSUV-}	2.9	3.3	3.9	V	—
V_{CC} Supply Undervoltage Positive Going Threshold	V_{CCUV+}	3.3	3.8	4.2	V	—
V_{CC} Supply Undervoltage Negative Going Threshold	V_{CCUV-}	2.9	3.3	3.9	V	—
Output High Short-Circuit Pulsed Current	I_{O+}	1.0	1.5	—	A	$V_O = 0V$, $PW \leq 10\mu s$
Output Low Short-Circuit Pulsed Current	I_{O-}	1.9	2.5	—	A	$V_O = 15V$, $PW \leq 10\mu s$
Forward Voltage of Bootstrap Diode	V_{F1}	—	0.67	—	V	$I_F = 100\mu A$
Forward Voltage of Bootstrap Diode	V_{F2}	—	1.7	—	V	$I_F = 100mA$

Note: 10. The V_{IN} and I_{IN} parameters are applicable to the two logic pins: IN and EN. The V_O and I_O parameters are applicable to the respective output pins: HO and LO.

AC Electrical Characteristics ($V_{CC} = V_{BS} = 12V$, $COM = V_S = 0V$, $C_L = 1000pF$, @ $T_A = +25^\circ C$, unless otherwise specified.)

Parameter	Symbol	Min	Typ	Max	Unit	Condition
Turn-on Propagation Delay, HO & LO	t_{ON}	65	96	125	ns	$R_{DT} = 10k\Omega$
		350	463	580	ns	$R_{DT} = 100k\Omega$
Turn-off Propagation Delay, HO & LO	t_{OFF}	—	22	56	ns	—
Turn-on Rise Time	t_R	—	17	35	ns	—
Turn-off Fall Time	t_F	—	12	25	ns	—
Delay Matching	t_{DM}	—	—	50	ns	—
Deadtime: $t_{DT LO-HO}$ & $t_{DT HO-LO}$	t_{DT}	40	70	100	ns	$R_{DT} = 10k\Omega$
		300	430	560	ns	$R_{DT} = 100k\Omega$
Deadtime Matching	t_{MDT}	—	—	50	ns	$R_{DT} = 100k\Omega$

Timing Waveforms

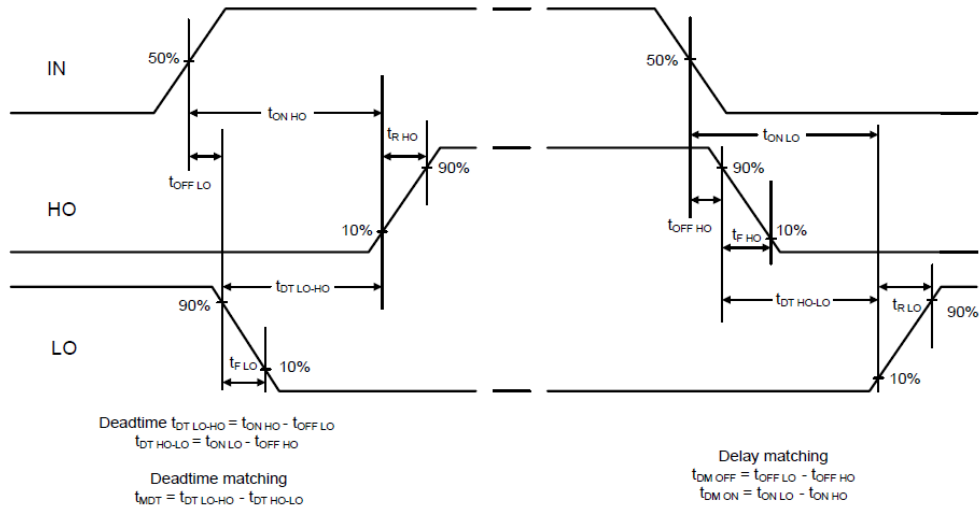

Figure 1. Switching Time Waveform Definitions

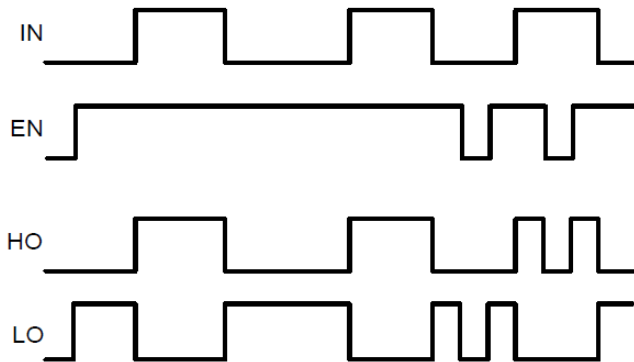

Figure 2. Input / Output Timing Diagram

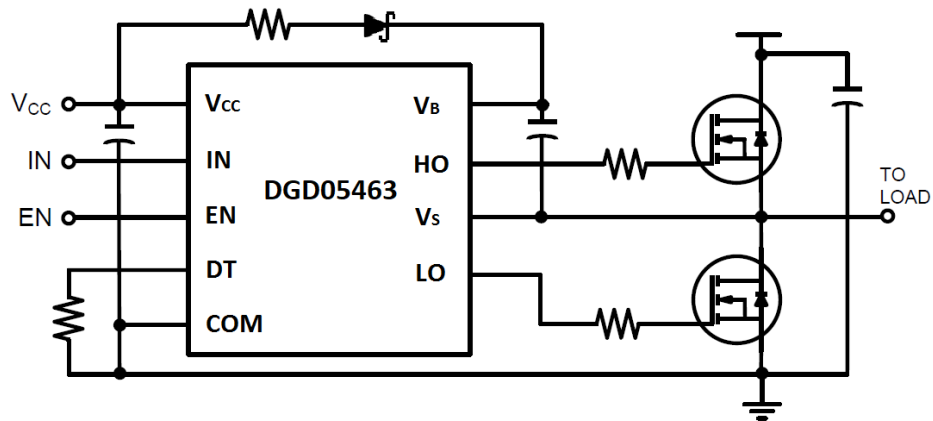

Figure 3. Typical application necessary for $V_{CC} = 4.5V$ to $4.9V$ operation. For $V_{CC} \geq 4.9V$, the bootstrap Schottky diode (0.3V Voltage drop, 1A) and resistor are not required.

Typical Performance Characteristics (@T_A = +25°C, unless otherwise specified.)

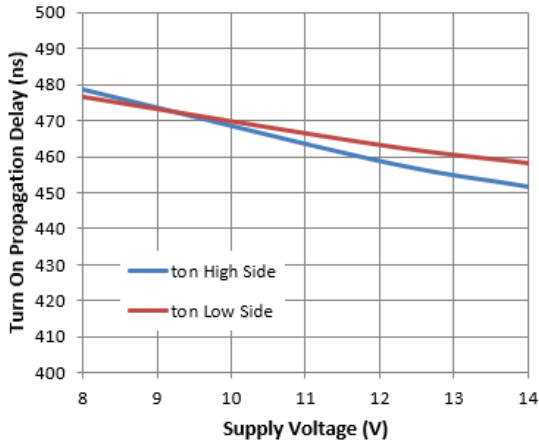

Figure 4. Turn-on Propagation Delay vs. Supply Voltage

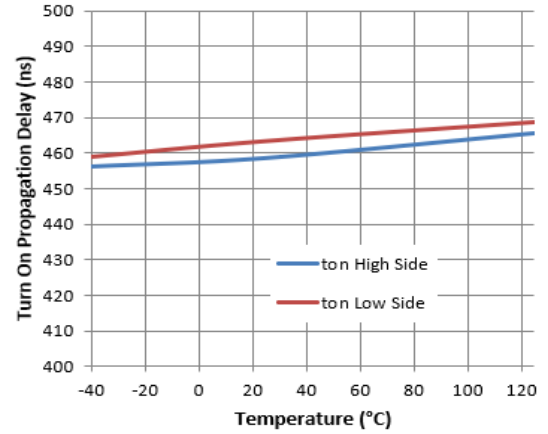

Figure 5. Turn-on Propagation Delay vs. Temperature

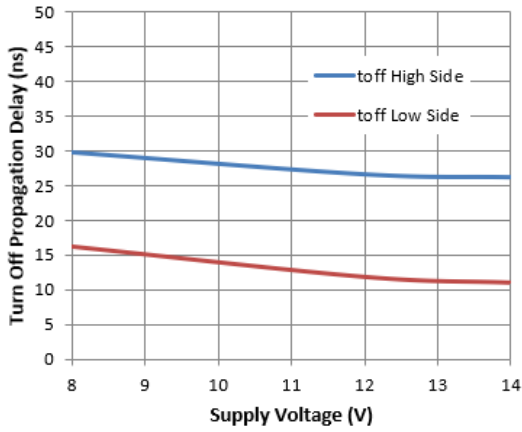

Figure 6. Turn-off Propagation Delay vs. Supply Voltage

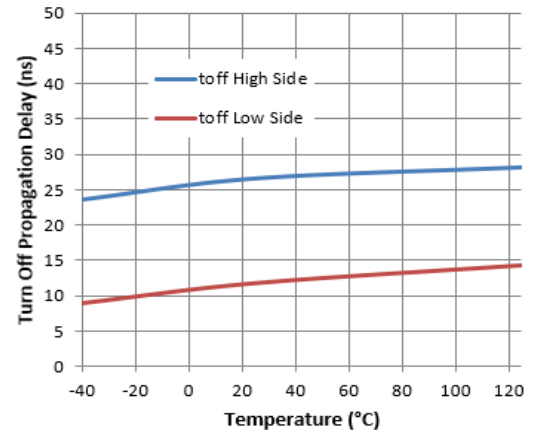

Figure 7. Turn-off Propagation Delay vs. Temperature

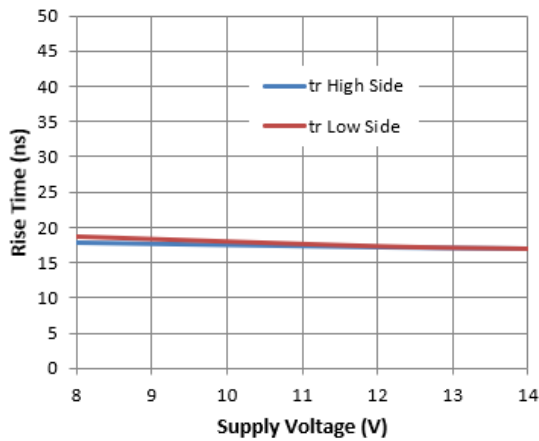

Figure 8. Rise Time vs. Supply Voltage

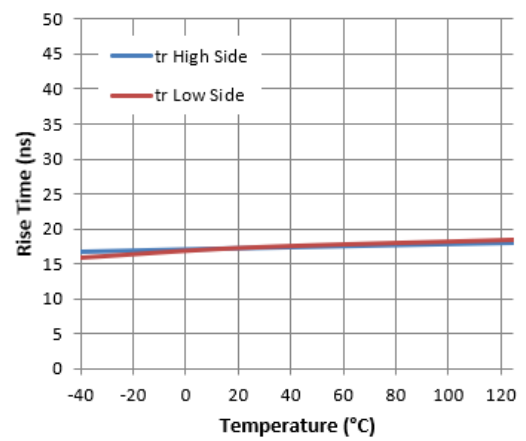

Figure 9. Rise Time vs. Temperature

Typical Performance Characteristics (Cont.)

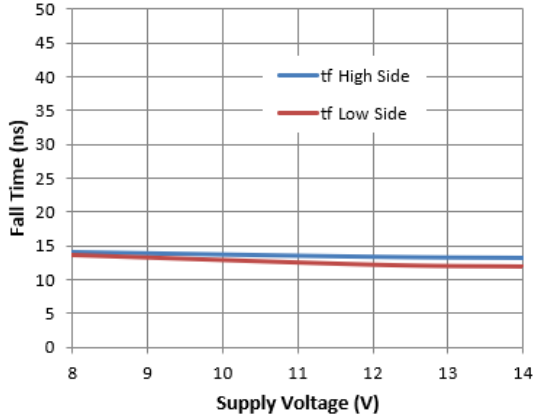

Figure 10. Fall Time vs. Supply Voltage

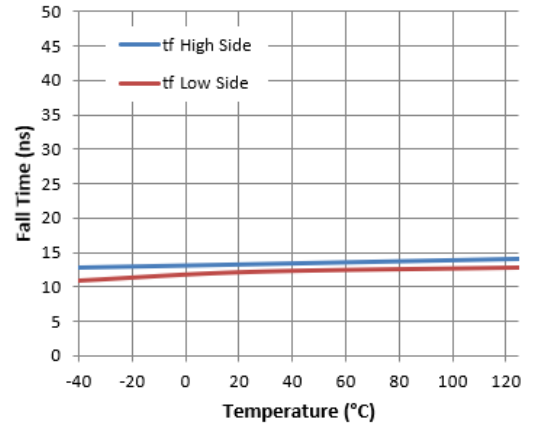

Figure 11. Fall Time vs. Temperature

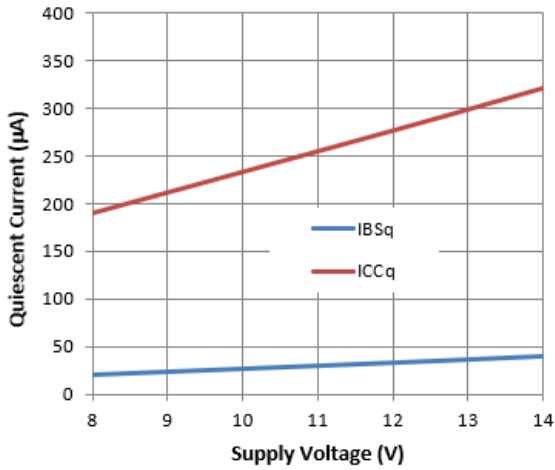

Figure 12. Quiescent Current vs. Supply Voltage

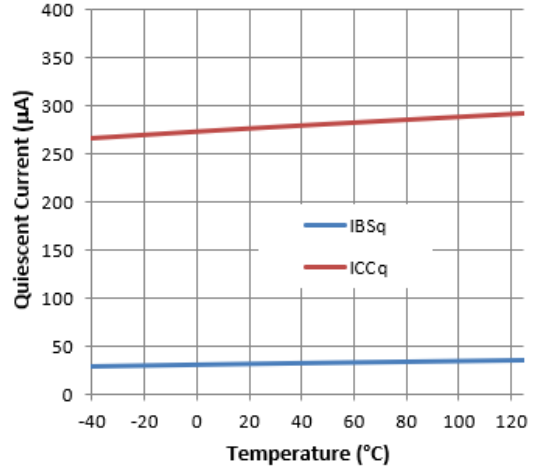

Figure 13. Quiescent Current vs. Temperature

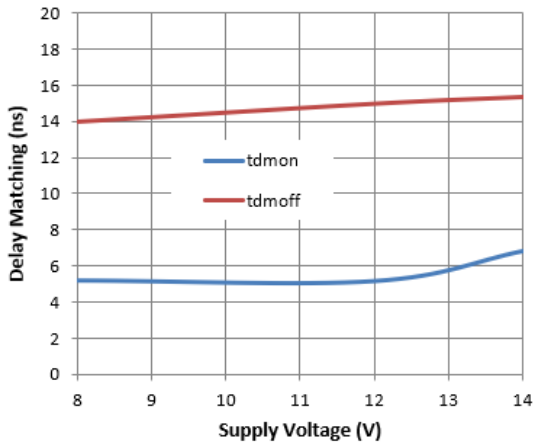

Figure 14. Delay Matching vs. Supply Voltage

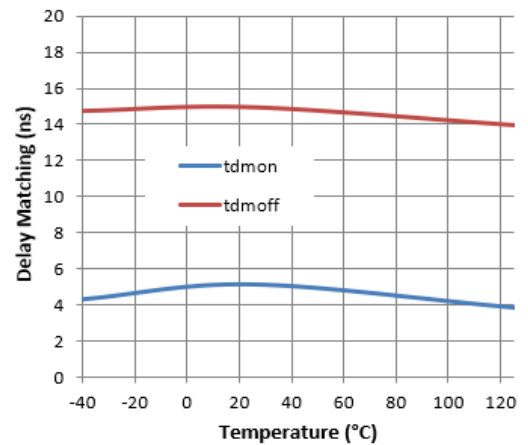

Figure 15. Delay Matching vs. Temperature

Typical Performance Characteristics (Cont.)

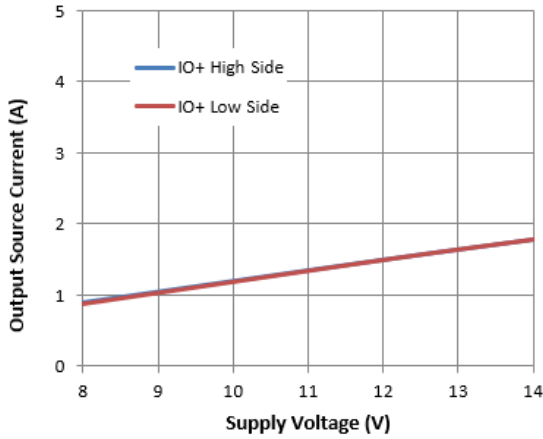

Figure 16. Output Source Current vs. Supply Voltage

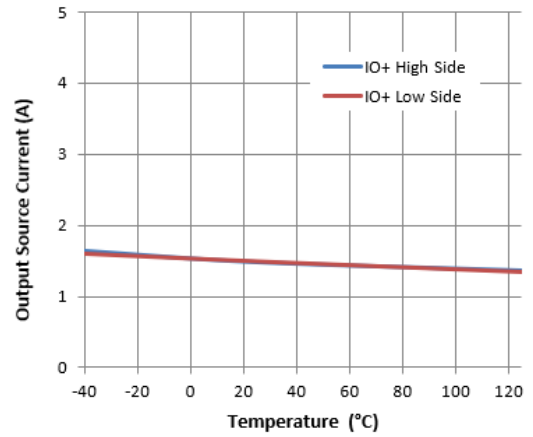

Figure 17. Output Source Current vs. Temperature

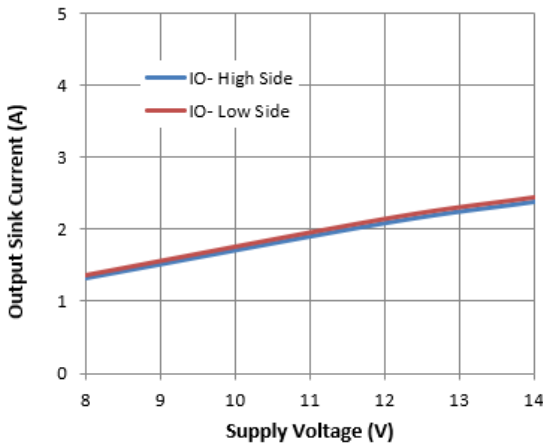

Figure 18. Output Sink Current vs. Supply Voltage

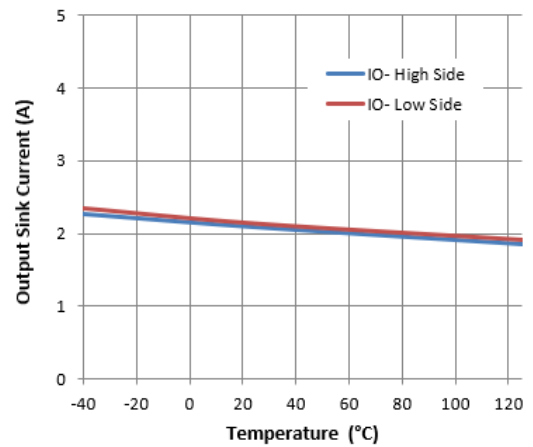

Figure 19. Output Sink Current vs. Temperature

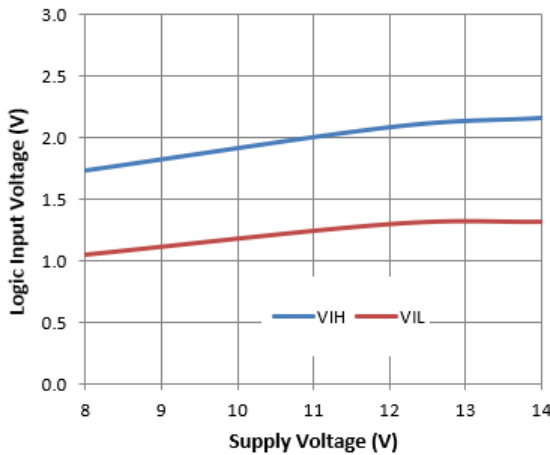

Fig 20. Logic Input Voltage vs. Supply Voltage

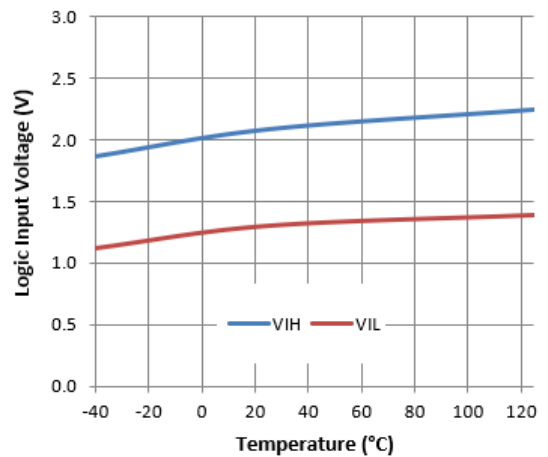

Fig 21. Logic Input Voltage vs. Temperature

Typical Performance Characteristics (Cont.)

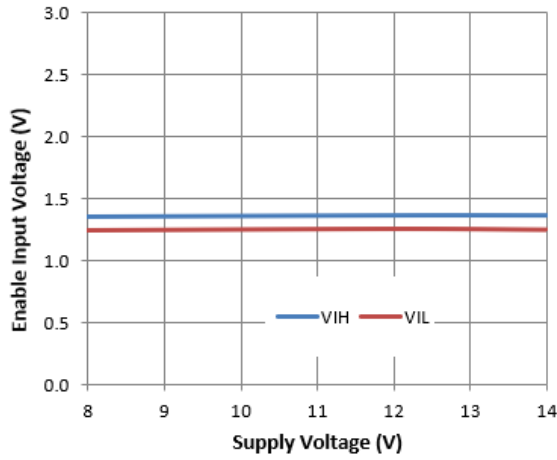

Fig 22. Enable Input Voltage vs. Supply Voltage

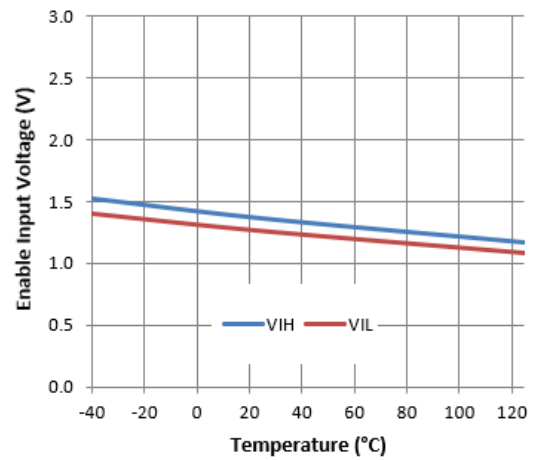

Fig 23. Enable Input Voltage vs. Temperature

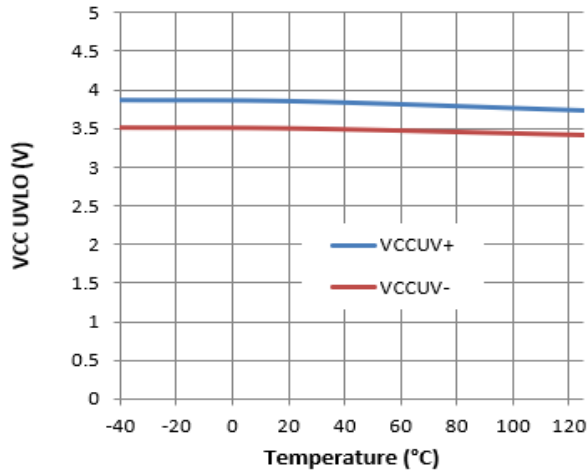

Figure 24. VCC UVLO vs. Temperature

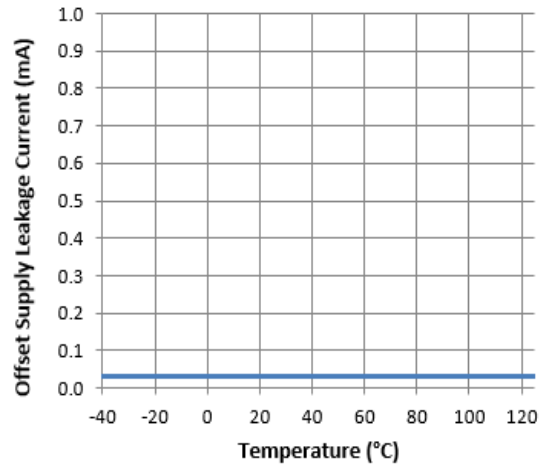
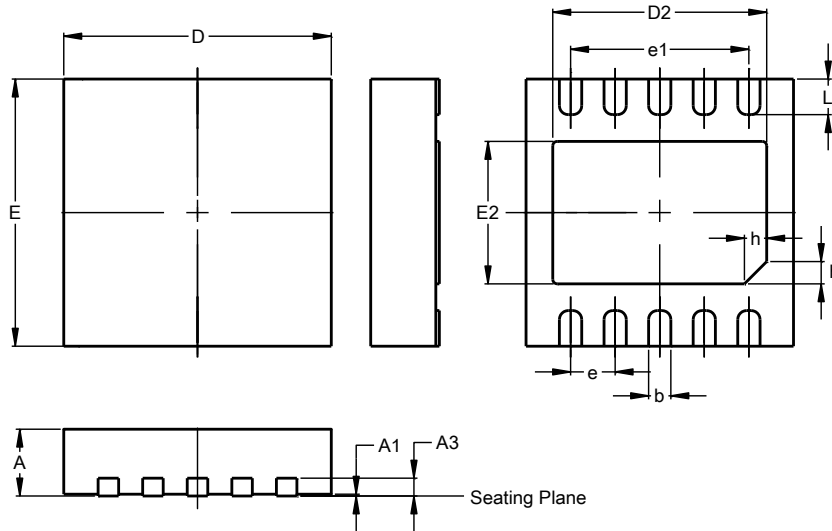

Figure 25. Offset Supply Leakage Current vs. Temperature

Package Outline Dimensions

Please see <http://www.diodes.com/package-outlines.html> for the latest version.

W-DFN3030-10 (Type TH)



W-DFN3030-10 (Type TH)			
Dim	Min	Max	Typ
A	0.70	0.80	0.75
A1	--	0.05	0.02
A3	0.18	0.25	0.20
b	0.18	0.30	0.25
D	2.90	3.10	3.00
D2	2.40	2.60	2.50
e	0.50BSC		
e1	2.00BSC		
E	2.90	3.10	3.00
E2	1.45	1.65	1.55
h	0.20	0.30	0.25
L	0.30	0.50	0.40
All Dimensions in mm			

Suggested Pad Layout

Please see <http://www.diodes.com/package-outlines.html> for the latest version.

W-DFN3030-10 (Type TH)

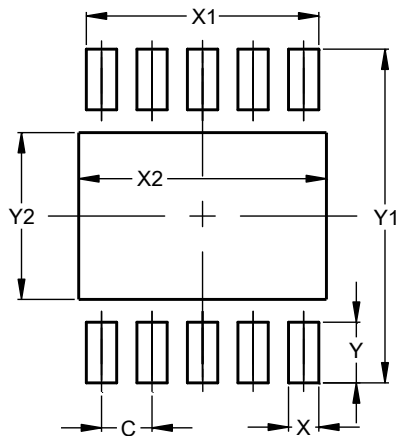

Dimensions	Value (in mm)
C	0.500
X	0.300
X1	2.300
X2	2.600
Y	0.600
Y1	3.300
Y2	1.650

Note: For high voltage applications, the appropriate industry sector guidelines should be considered with regards to creepage and clearance distances between device Terminals and PCB tracking.

Package Outline Dimensions

Please see <http://www.diodes.com/package-outlines.html> for the latest version.

MSOP-10

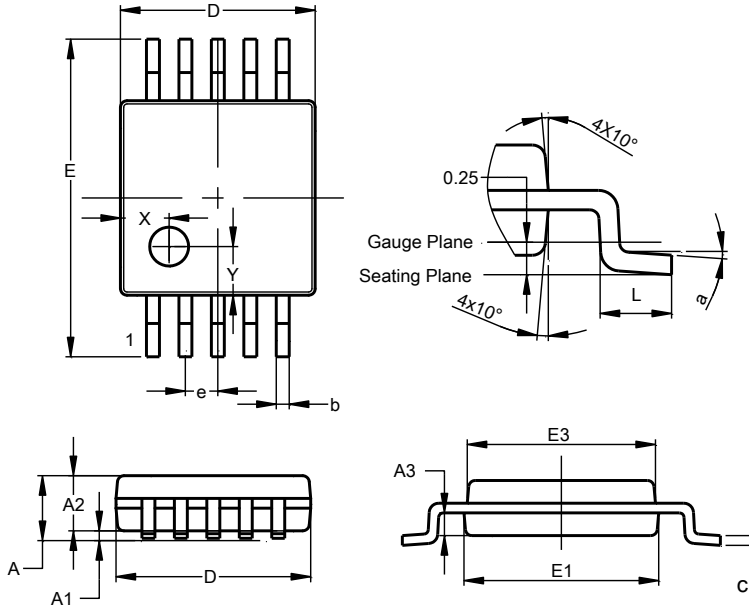

MSOP-10			
Dim	Min	Max	Typ
A	-	1.10	-
A1	0.05	0.15	0.10
A2	0.75	0.95	0.86
A3	0.29	0.49	0.39
b	0.17	0.27	0.20
c	0.08	0.23	0.15
D	2.95	3.05	3.00
e	-	-	0.50
E	4.80	5.00	4.90
E1	2.95	3.05	3.00
E3	2.85	3.05	2.95
L	0.40	0.80	0.60
X	--	--	0.750
Y	--	--	0.750
a	0°	8°	4°
All Dimensions in mm			

Suggested Pad Layout

Please see <http://www.diodes.com/package-outlines.html> for the latest version.

MSOP-10

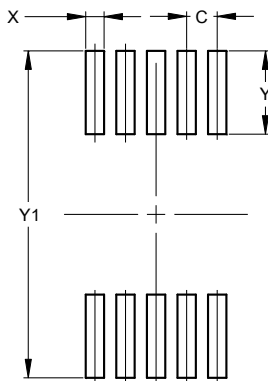

Dimensions	Value (in mm)
C	0.50
X	0.30
Y	1.35
Y1	5.30

Note: For high-voltage applications, the appropriate industry sector guidelines should be considered with regards to creepage and clearance distances between device Terminals and PCB tracking.

IMPORTANT NOTICE

DIODES INCORPORATED MAKES NO WARRANTY OF ANY KIND, EXPRESS OR IMPLIED, WITH REGARDS TO THIS DOCUMENT, INCLUDING, BUT NOT LIMITED TO, THE IMPLIED WARRANTIES OF MERCHANTABILITY AND FITNESS FOR A PARTICULAR PURPOSE (AND THEIR EQUIVALENTS UNDER THE LAWS OF ANY JURISDICTION).

Diodes Incorporated and its subsidiaries reserve the right to make modifications, enhancements, improvements, corrections or other changes without further notice to this document and any product described herein. Diodes Incorporated does not assume any liability arising out of the application or use of this document or any product described herein; neither does Diodes Incorporated convey any license under its patent or trademark rights, nor the rights of others. Any Customer or user of this document or products described herein in such applications shall assume all risks of such use and will agree to hold Diodes Incorporated and all the companies whose products are represented on Diodes Incorporated website, harmless against all damages.

Diodes Incorporated does not warrant or accept any liability whatsoever in respect of any products purchased through unauthorized sales channel. Should Customers purchase or use Diodes Incorporated products for any unintended or unauthorized application, Customers shall indemnify and hold Diodes Incorporated and its representatives harmless against all claims, damages, expenses, and attorney fees arising out of, directly or indirectly, any claim of personal injury or death associated with such unintended or unauthorized application.

Products described herein may be covered by one or more United States, international or foreign patents pending. Product names and markings noted herein may also be covered by one or more United States, international or foreign trademarks.

This document is written in English but may be translated into multiple languages for reference. Only the English version of this document is the final and determinative format released by Diodes Incorporated.

LIFE SUPPORT

Diodes Incorporated products are specifically not authorized for use as critical components in life support devices or systems without the express written approval of the Chief Executive Officer of Diodes Incorporated. As used herein:

A. Life support devices or systems are devices or systems which:

1. are intended to implant into the body, or
2. support or sustain life and whose failure to perform when properly used in accordance with instructions for use provided in the labeling can be reasonably expected to result in significant injury to the user.

B. A critical component is any component in a life support device or system whose failure to perform can be reasonably expected to cause the failure of the life support device or to affect its safety or effectiveness.

Customers represent that they have all necessary expertise in the safety and regulatory ramifications of their life support devices or systems, and acknowledge and agree that they are solely responsible for all legal, regulatory and safety-related requirements concerning their products and any use of Diodes Incorporated products in such safety-critical, life support devices or systems, notwithstanding any devices- or systems-related information or support that may be provided by Diodes Incorporated. Further, Customers must fully indemnify Diodes Incorporated and its representatives against any damages arising out of the use of Diodes Incorporated products in such safety-critical, life support devices or systems.

Copyright © 2018, Diodes Incorporated

www.diodes.com



Стандарт Электрон Связь

Мы молодая и активно развивающаяся компания в области поставок электронных компонентов. Мы поставляем электронные компоненты отечественного и импортного производства напрямую от производителей и с крупнейших складов мира.

Благодаря сотрудничеству с мировыми поставщиками мы осуществляем комплексные и плановые поставки широчайшего спектра электронных компонентов.

Собственная эффективная логистика и склад в обеспечивает надежную поставку продукции в точно указанные сроки по всей России.

Мы осуществляем техническую поддержку нашим клиентам и предпродажную проверку качества продукции. На все поставляемые продукты мы предоставляем гарантию .

Осуществляем поставки продукции под контролем ВП МО РФ на предприятия военно-промышленного комплекса России , а также работаем в рамках 275 ФЗ с открытием отдельных счетов в уполномоченном банке. Система менеджмента качества компании соответствует требованиям ГОСТ ISO 9001.

Минимальные сроки поставки, гибкие цены, неограниченный ассортимент и индивидуальный подход к клиентам являются основой для выстраивания долгосрочного и эффективного сотрудничества с предприятиями радиоэлектронной промышленности, предприятиями ВПК и научно-исследовательскими институтами России.

С нами вы становитесь еще успешнее!

Наши контакты:

Телефон: +7 812 627 14 35

Электронная почта: sales@st-electron.ru

Адрес: 198099, Санкт-Петербург,
Промышленная ул, дом № 19, литера Н,
помещение 100-Н Офис 331