

1 Form A Solid-State Relay

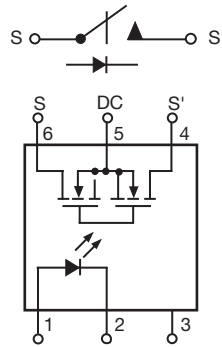
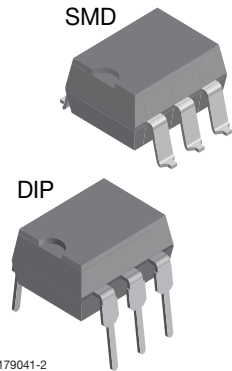

FEATURES

- Isolation test voltage 5300 V_{RMS}
- Current limit protection built in
- High reliability monolithic output die
- Low power consumption
- Clean bounce free switching
- High surge capability
- Surface mountable
- Compliant to RoHS Directive 2002/95/EC and in accordance to WEEE 2002/96/EC

 RoHS
COMPLIANT

APPLICATIONS

- General telecom switching
- Instrumentation
- Industrial controls

AGENCY APPROVALS

- UL1577: file no. E52744 system code H, double protection
 CSA: certification no. 093751
 BSI: certification no. 7979/7980
 DIN EN: 60747-5-2 (VDE 0884)/60747-5-5 (pending), available with option 1
 FIMKO: 25419

DESCRIPTION

The LH1510 is an SPST normally open switch (1 form A) that can replace electromechanical relays in many applications. The relay is constructed using a GaAlAs LED for actuation control and an integrated monolithic die for the switch output. The die, fabricated in a high-voltage dielectrically isolated technology, is comprised of a photodiode array, switch control circuitry, and MOSFET switches. In addition, the relay employs current-limiting circuitry enabling it to pass lightning surge testing as per ANSI/TIA-968-B and other regulatory voltage surge requirements when overvoltage protection is provided. The LH1510 is the only relay in the family that provides current limiting for unidirectional DC applications.

ORDERING INFORMATION

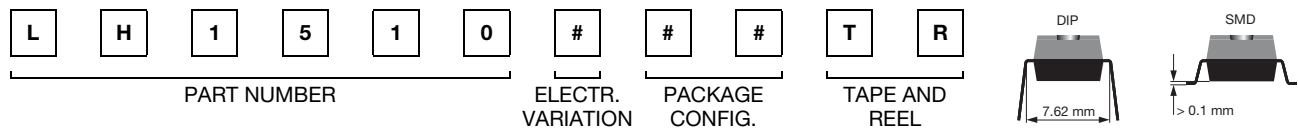

| PACKAGE | UL, CSA, BSI, FIMKO |
|----------------------|---------------------|
| SMD-6, tubes | LH1510AAB |
| SMD-6, tape and reel | LH1510AABTR |
| DIP-6, tubes | LH1510AT |

ABSOLUTE MAXIMUM RATINGS (T_{amb} = 25 °C, unless otherwise specified)

| PARAMETER | TEST CONDITION | SYMBOL | VALUE | UNIT |
|---|------------------------|----------------|-------|------|
| INPUT | | | | |
| LED continuous forward current | | I _F | 50 | mA |
| LED reverse voltage | I _R ≤ 10 μA | V _R | 8 | V |
| OUTPUT | | | | |
| DC or peak AC load voltage | I _L ≤ 50 μA | V _L | 200 | V |
| Continuous DC load current - bidirectional operation | | I _L | 200 | mA |
| Continuous DC load current - unidirectional operation | | I _L | 350 | mA |
| Peak load current (single shot) | t = 100 ms | I _P | (1) | |



| ABSOLUTE MAXIMUM RATINGS ($T_{amb} = 25\text{ }^{\circ}\text{C}$, unless otherwise specified) | | | | |
|---|------------------------|------------|---------------|--------------------|
| PARAMETER | TEST CONDITION | SYMBOL | VALUE | UNIT |
| SSR | | | | |
| Ambient temperature range | | T_{amb} | - 40 to + 85 | $^{\circ}\text{C}$ |
| Storage temperature range | | T_{stg} | - 40 to + 150 | $^{\circ}\text{C}$ |
| Pin soldering temperature ⁽²⁾ | $t = 10\text{ s max.}$ | T_{sld} | 260 | $^{\circ}\text{C}$ |
| Input to output isolation voltage | | V_{ISO} | 5300 | V_{RMS} |
| Output power dissipation (continuous) | | P_{diss} | 550 | mW |

Notes

- Stresses in excess of the absolute maximum ratings can cause permanent damage to the device. Functional operation of the device is not implied at these or any other conditions in excess of those given in the operational sections of this document. Exposure to absolute maximum ratings for extended periods of the time can adversely affect reliability.
- (1) Refer to current limit performance application note 58 for a discussion on relay operation during transient currents.
- (2) Refer to reflow profile for soldering conditions for surface mounted devices (SMD). Refer to wave profile for soldering conditions for through hole devices (DIP).

| ELECTRICAL CHARACTERISTICS ($T_{amb} = 25\text{ }^{\circ}\text{C}$, unless otherwise specified) | | | | | | |
|---|--|------------|------|-------|------|---------------|
| PARAMETER | TEST CONDITION | SYMBOL | MIN. | TYP. | MAX. | UNIT |
| INPUT | | | | | | |
| LED forward current, switch turn-on | $I_L = 100\text{ mA}$, $t = 10\text{ ms}$ | I_{Fon} | | 0.95 | 2 | mA |
| LED forward current, switch turn-off | $V_L = \pm 150\text{ V}$ | I_{Foff} | 0.2 | 0.85 | | mA |
| LED forward voltage | $I_F = 10\text{ mA}$ | V_F | 1.15 | 1.27 | 1.45 | V |
| OUTPUT | | | | | | |
| ON-resistance AC/DC: pin 4 (\pm) to 6 (\pm) | $I_F = 5\text{ mA}$, $I_L = 50\text{ mA}$ | R_{ON} | 6 | 11.27 | 15 | Ω |
| ON-resistance DC: pin 4, 6 (+) to 5 (\pm) | $I_F = 5\text{ mA}$, $I_L = 100\text{ mA}$ | R_{ON} | 1.5 | 3.15 | 3.75 | Ω |
| Off-resistance | $I_F = 0\text{ mA}$, $V_L = \pm 100\text{ V}$ | R_{OFF} | 0.5 | 80 | | $G\Omega$ |
| Current limit AC/DC: pin 4 (\pm) to 6 (\pm) | $I_F = 5\text{ mA}$, $V_L = \pm 5\text{ V}$, $t = 5\text{ ms}$ | I_{LMT} | 300 | 368 | 450 | mA |
| Current limit DC: pin 4, 6 (+) to 5 (\pm) | $I_F = 5\text{ mA}$, $V_L = \pm 4\text{ V}$, $t = 5\text{ ms}$ | I_{LMT} | 600 | 736 | 920 | mA |
| Off-state leakage current | $I_F = 0\text{ mA}$, $V_L = \pm 100\text{ V}$ | I_O | | 2.36 | 200 | nA |
| | $I_F = 0\text{ mA}$, $V_L = \pm 200\text{ V}$ | I_O | | 79.2 | 1 | μA |
| Output capacitance pin 4 to 6 | $I_F = 0\text{ mA}$, $V_L = 1\text{ V}$ | C_O | | 27.75 | | pF |
| | $I_F = 0\text{ mA}$, $V_L = 50\text{ V}$ | C_O | | 10.82 | | pF |
| Switch offset | $I_F = 5\text{ mA}$ | V_{OS} | | 0.17 | | μV |
| TRANSFER | | | | | | |
| Capacitance (input to output) | $V_{ISO} = 1\text{ V}$ | C_{IO} | | 0.72 | | pF |

Note

- Minimum and maximum values are testing requirements. Typical values are characteristics of the device and are the result of engineering evaluations. Typical values are for information only and are not part of the testing requirements.

| SWITCHING CHARACTERISTICS ($T_{amb} = 25\text{ }^{\circ}\text{C}$, unless otherwise specified) | | | | | | |
|--|--|-----------|------|------|------|------|
| PARAMETER | TEST CONDITION | SYMBOL | MIN. | TYP. | MAX. | UNIT |
| Turn-on time | $I_F = 5\text{ mA}$, $I_L = 50\text{ mA}$ | t_{on} | | 0.5 | 2 | ms |
| Turn-off time | $I_F = 5\text{ mA}$, $I_L = 50\text{ mA}$ | t_{off} | | 0.7 | 2 | ms |



| SAFETY AND INSULATION RATINGS | | | | |
|---|--|------------|----------------|------------|
| PARAMETER | TEST CONDITION | SYMBOL | VALUE | UNIT |
| Climatic classification | IEC 68 part 1 | | 40/85/21 | |
| Pollution degree | DIN VDE 0109 | | 2 | |
| Tracking resistance (comparative tracking index) | Insulation group IIIa | CTI | 175 | |
| Highest allowable overvoltage | Transient overvoltage | V_{IOTM} | 8000 | V_{peak} |
| Max. working insulation voltage | Recurring peak voltage | V_{IORM} | 890 | V_{peak} |
| Insulation resistance at 25 °C | $V_{IO} = 500 V$ | R_{IS} | $\geq 10^{12}$ | Ω |
| Insulation resistance at T_S | | R_{IS} | $\geq 10^9$ | Ω |
| Insulation resistance at 100 °C | | R_{IS} | $\geq 10^{11}$ | Ω |
| Partial discharge test voltage | Method e a, $V_{pd} = V_{IORM} \times 1.875$ | V_{pd} | 1669 | V_{peak} |
| Safety limiting values - maximum values allowed in the event of a failure | Case temperature | T_{SI} | 175 | °C |
| | Input current | I_{SI} | 300 | mA |
| | Output power | P_{SO} | 700 | mW |
| Minimum external air gap (clearance) | Measured from input terminals to output terminals, shortest distance through air | | ≥ 7 | mm |
| Minimum external tracking (creepage) | Measured from input terminals to output terminals, shortest distance path along body | | ≥ 7 | mm |

TYPICAL CHARACTERISTICS ($T_{amb} = 25\text{ °C}$, unless otherwise specified)

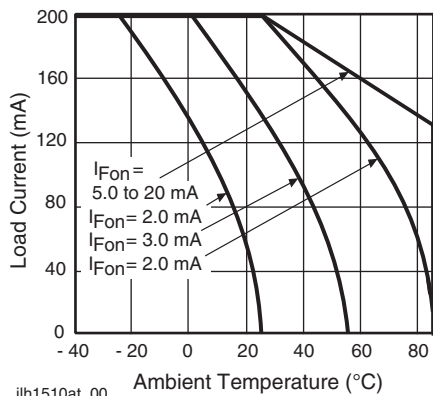

ilh1510at_00

Fig. 1 - Recommended Operating Conditions

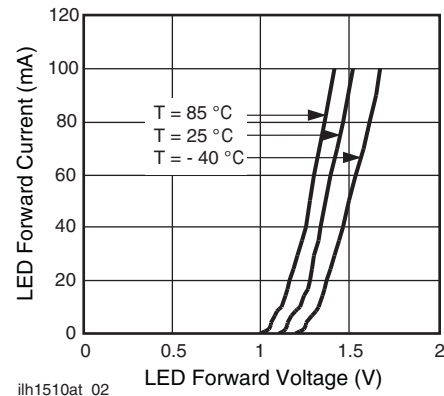

ilh1510at_02

Fig. 3 - LED Forward Current vs. LED Forward Voltage

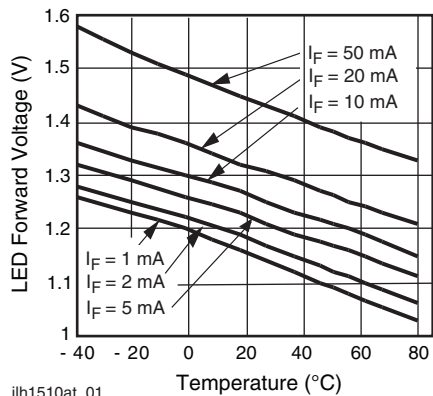

ilh1510at_01

Fig. 2 - LED Voltage vs. Temperature

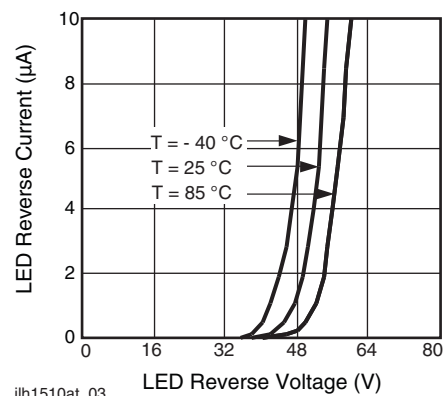

ilh1510at_03

Fig. 4 - LED Reverse Current vs. LED Reverse Voltage

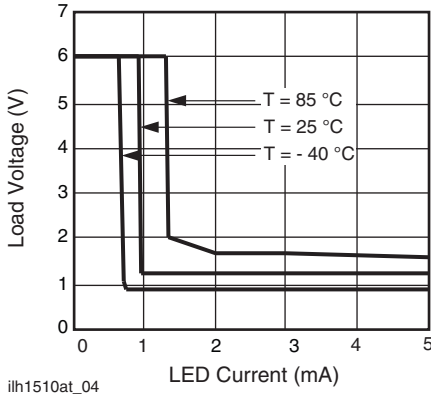

Fig. 5 - LED Current vs. Load Voltage

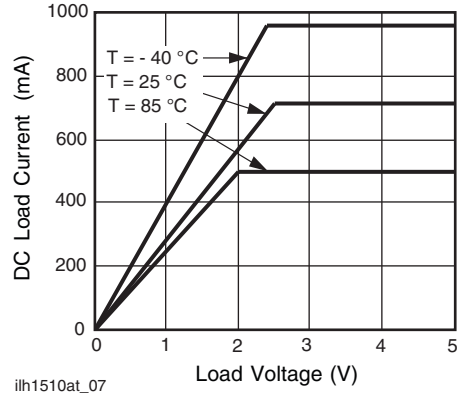

Fig. 8 - DC Load Current vs. Load Voltage

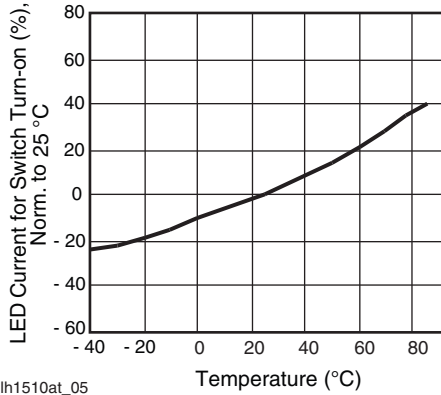

Fig. 6 - LED Current for Switch Turn-on vs. Temperature

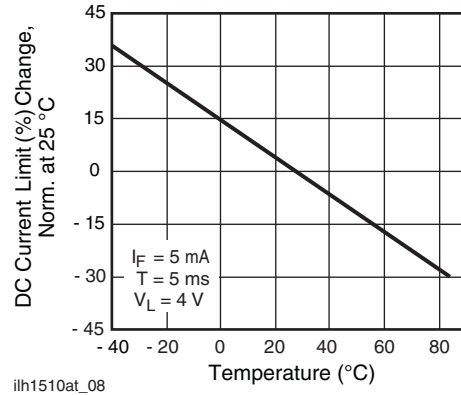

Fig. 9 - DC Current Limit vs. Temperature

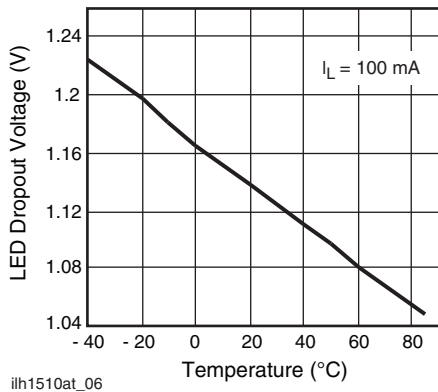

Fig. 7 - LED Dropout Voltage vs. Temperature

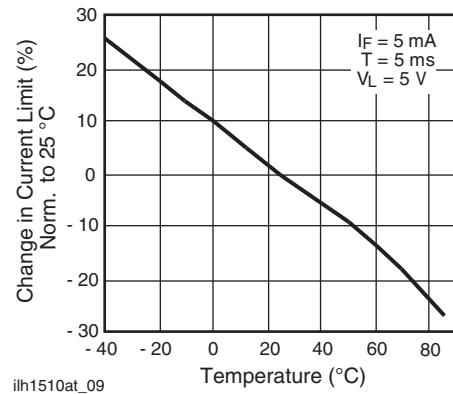
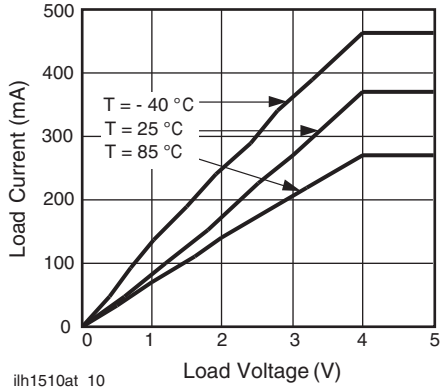
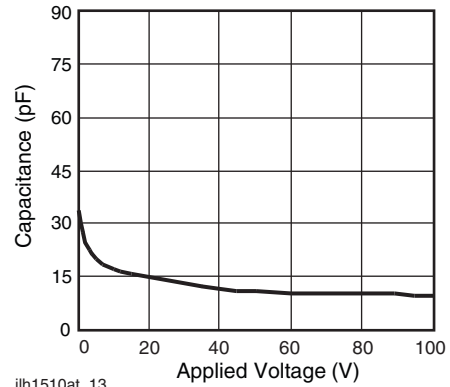

Fig. 10 - Current Limit vs. Temperature



ilh1510at_10

Fig. 11 - Load Current vs. Load Voltage



ilh1510at_13

Fig. 14 - Switch Terminal Capacitance vs. Applied Voltage

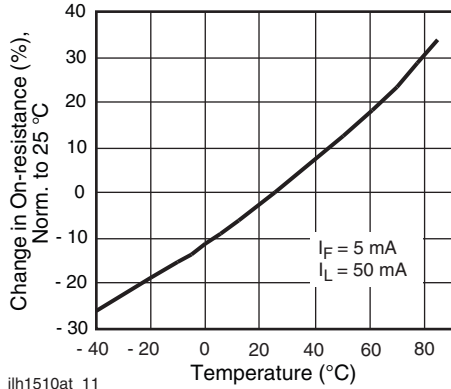

ilh1510at_11

Fig. 12 - On-Resistance vs. Temperature

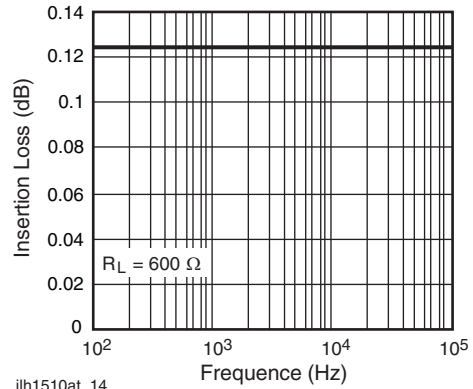

ilh1510at_14

Fig. 15 - Insertion Loss vs. Frequency

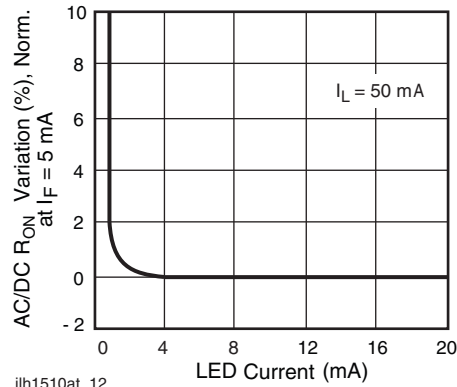

ilh1510at_12

Fig. 13 - Variation in On-Resistance vs. LED Current

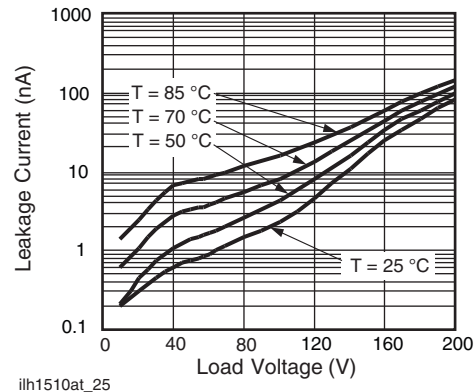

ilh1510at_25

Fig. 16 - Leakage Current vs. Applied Voltage

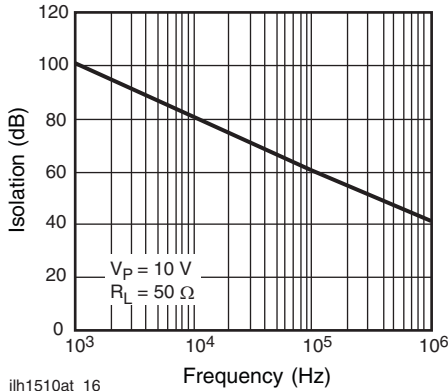

Fig. 17 - Output Isolation

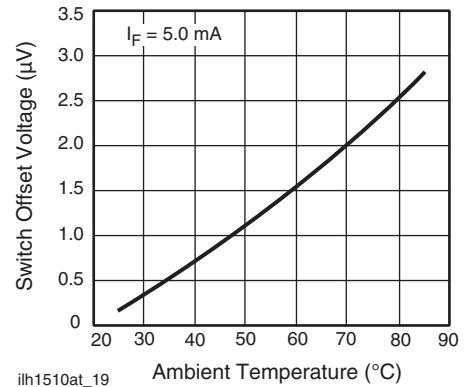

Fig. 20 - Switch Offset Voltage vs. Temperature

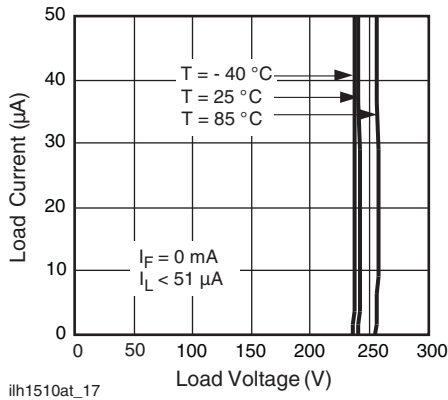

Fig. 18 - Switch Breakdown Voltage vs. Load Current

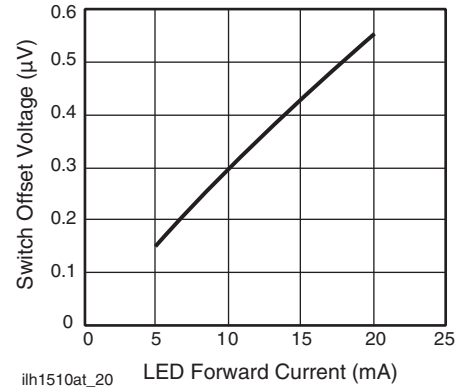

Fig. 21 - Switch Offset Voltage vs. LED Current

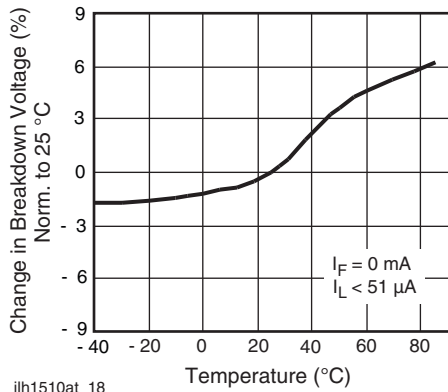

Fig. 19 - Switch Breakdown Voltage vs. Temperature

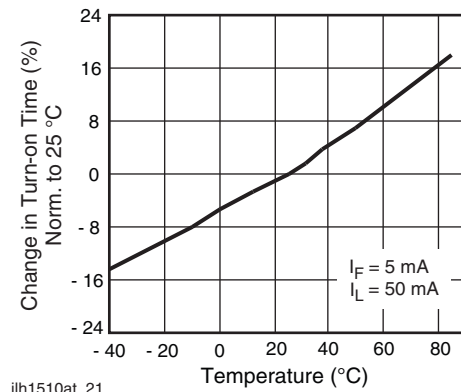
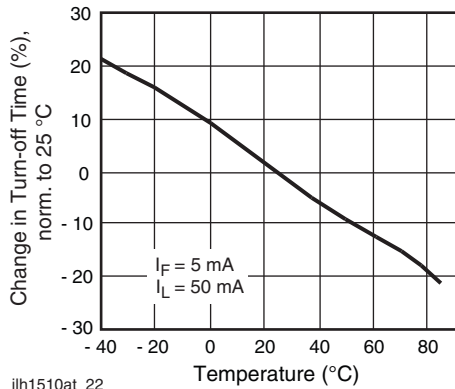
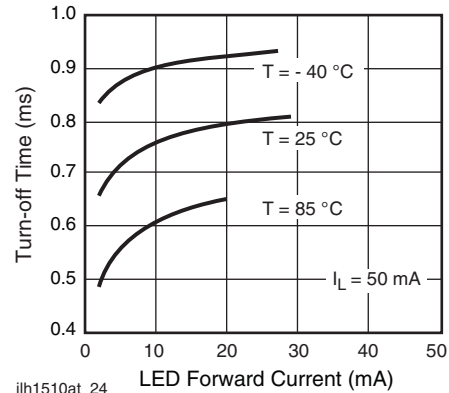

Fig. 22 - Turn-on Time vs. Temperature



ih1510at_22

Fig. 23 - Turn-off Time vs. Temperature



ih1510at_24

Fig. 25 - Turn-off Time vs. LED Current

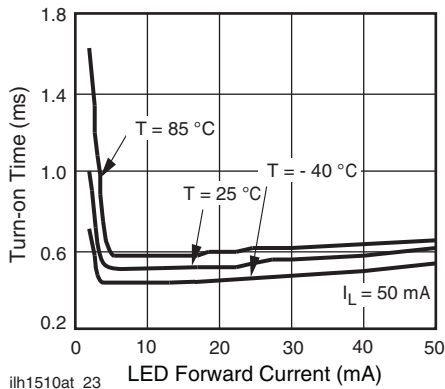

ih1510at_23

Fig. 24 - Turn-on Time vs. LED Current

PACKAGE DIMENSIONS in millimeters

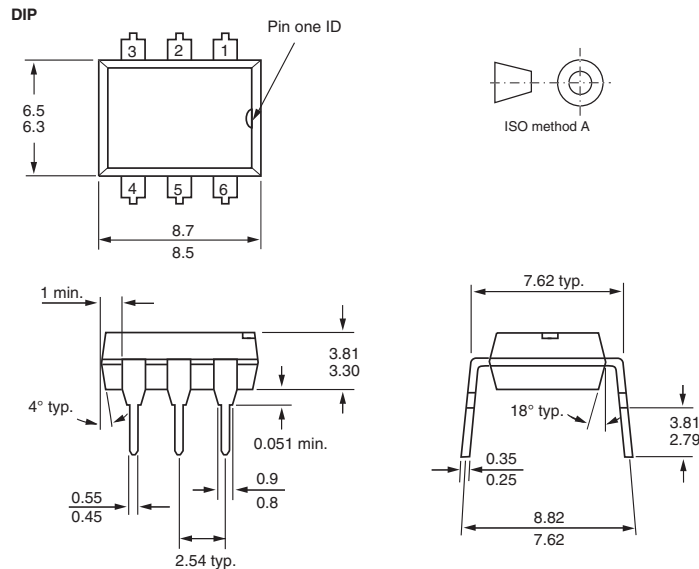

i178001

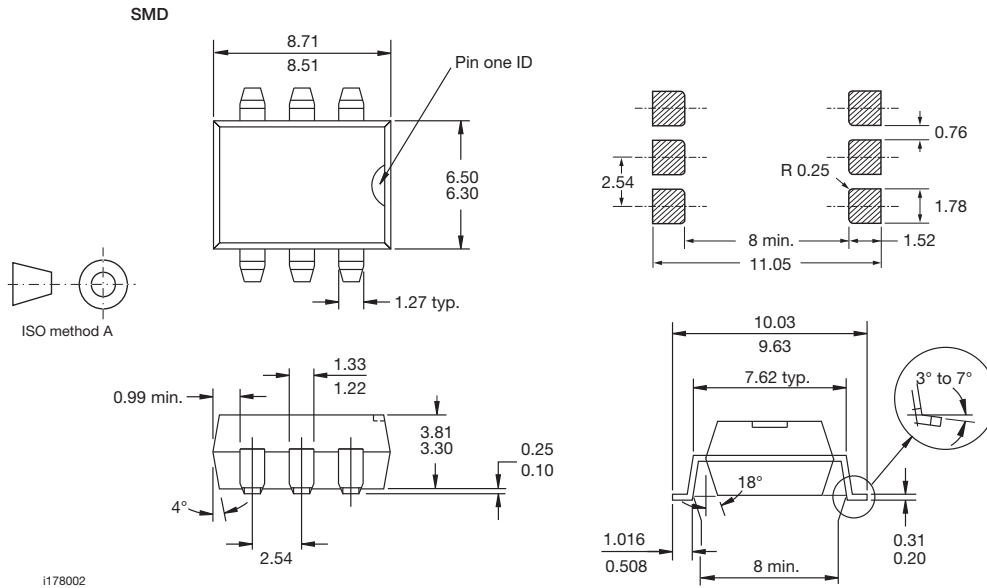

PACKAGE MARKING

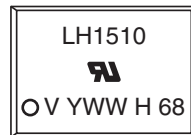

Note

- Tape and reel suffix (TR) is not part of the package marking.



Disclaimer

ALL PRODUCT, PRODUCT SPECIFICATIONS AND DATA ARE SUBJECT TO CHANGE WITHOUT NOTICE TO IMPROVE RELIABILITY, FUNCTION OR DESIGN OR OTHERWISE.

Vishay Intertechnology, Inc., its affiliates, agents, and employees, and all persons acting on its or their behalf (collectively, "Vishay"), disclaim any and all liability for any errors, inaccuracies or incompleteness contained in any datasheet or in any other disclosure relating to any product.

Vishay makes no warranty, representation or guarantee regarding the suitability of the products for any particular purpose or the continuing production of any product. To the maximum extent permitted by applicable law, Vishay disclaims (i) any and all liability arising out of the application or use of any product, (ii) any and all liability, including without limitation special, consequential or incidental damages, and (iii) any and all implied warranties, including warranties of fitness for particular purpose, non-infringement and merchantability.

Statements regarding the suitability of products for certain types of applications are based on Vishay's knowledge of typical requirements that are often placed on Vishay products in generic applications. Such statements are not binding statements about the suitability of products for a particular application. It is the customer's responsibility to validate that a particular product with the properties described in the product specification is suitable for use in a particular application. Parameters provided in datasheets and/or specifications may vary in different applications and performance may vary over time. All operating parameters, including typical parameters, must be validated for each customer application by the customer's technical experts. Product specifications do not expand or otherwise modify Vishay's terms and conditions of purchase, including but not limited to the warranty expressed therein.

Except as expressly indicated in writing, Vishay products are not designed for use in medical, life-saving, or life-sustaining applications or for any other application in which the failure of the Vishay product could result in personal injury or death. Customers using or selling Vishay products not expressly indicated for use in such applications do so at their own risk and agree to fully indemnify and hold Vishay and its distributors harmless from and against any and all claims, liabilities, expenses and damages arising or resulting in connection with such use or sale, including attorneys fees, even if such claim alleges that Vishay or its distributor was negligent regarding the design or manufacture of the part. Please contact authorized Vishay personnel to obtain written terms and conditions regarding products designed for such applications.

No license, express or implied, by estoppel or otherwise, to any intellectual property rights is granted by this document or by any conduct of Vishay. Product names and markings noted herein may be trademarks of their respective owners.



Стандарт Электрон Связь

Мы молодая и активно развивающаяся компания в области поставок электронных компонентов. Мы поставляем электронные компоненты отечественного и импортного производства напрямую от производителей и с крупнейших складов мира.

Благодаря сотрудничеству с мировыми поставщиками мы осуществляем комплексные и плановые поставки широчайшего спектра электронных компонентов.

Собственная эффективная логистика и склад в обеспечивает надежную поставку продукции в точно указанные сроки по всей России.

Мы осуществляем техническую поддержку нашим клиентам и предпродажную проверку качества продукции. На все поставляемые продукты мы предоставляем гарантию .

Осуществляем поставки продукции под контролем ВП МО РФ на предприятия военно-промышленного комплекса России , а также работаем в рамках 275 ФЗ с открытием отдельных счетов в уполномоченном банке. Система менеджмента качества компании соответствует требованиям ГОСТ ISO 9001.

Минимальные сроки поставки, гибкие цены, неограниченный ассортимент и индивидуальный подход к клиентам являются основой для выстраивания долгосрочного и эффективного сотрудничества с предприятиями радиоэлектронной промышленности, предприятиями ВПК и научно-исследовательскими институтами России.

С нами вы становитесь еще успешнее!

Наши контакты:

Телефон: +7 812 627 14 35

Электронная почта: sales@st-electron.ru

Адрес: 198099, Санкт-Петербург,
Промышленная ул, дом № 19, литера Н,
помещение 100-Н Офис 331