

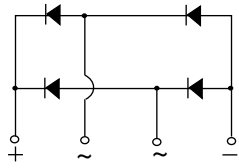

## Single-Phase Single In-Line Bridge Rectifiers

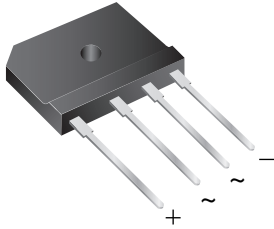

Case Style GSIB-5S

### FEATURES

- UL recognition file number E54214
- Thin single in-line package
- Glass passivated chip junction
- High surge current capability
- High case dielectric strength of 2500 V<sub>RMS</sub>
- Solder dip 275 °C max. 10 s, per JESD 22-B106
- Material categorization: For definitions of compliance please see [www.vishay.com/doc?99912](http://www.vishay.com/doc?99912)



**RoHS**  
COMPLIANT  
HALOGEN  
**FREE**

### TYPICAL APPLICATIONS

General purpose use in AC/DC bridge full wave rectification for switching power supply, home appliances, office equipment, industrial automation applications.

### MECHANICAL DATA

**Case:** GSIB-5S

Molding compound meets UL 94 V-0 flammability rating  
Base P/N-M3 - halogen-free, RoHS-compliant, and commercial grade

**Terminals:** Matte tin plated leads, solderable per J-STD-002 and JESD 22-B102

M3 suffix meets JESD 201 class 1A whisker test

**Polarity:** As marked on body

**Mounting Torque:** 10 cm-kg (8.8 in-lbs) maximum

**Recommended Torque:** 5.7 cm-kg (5 in-lbs)

PRIMARY CHARACTERISTICS	
Package	GSIB-5S
I <sub>F(AV)</sub>	15 A
V <sub>RRM</sub>	200 V, 400 V, 600 V, 800 V
I <sub>FSM</sub>	200 A
I <sub>R</sub>	10 μA
V <sub>F</sub> at I <sub>F</sub> = 7.5 A	1.0 V
T <sub>J</sub> max.	150 °C
Diode variations	In-Line

MAXIMUM RATINGS (T <sub>A</sub> = 25 °C unless otherwise noted)						
PARAMETER	SYMBOL	GSIB15A20N	GSIB15A40N	GSIB15A60N	GSIB15A80N	UNIT
Maximum repetitive peak reverse voltage	V <sub>RRM</sub>	200	400	600	800	V
Maximum RMS voltage	V <sub>RMS</sub>	140	280	420	560	V
Maximum DC blocking voltage	V <sub>DC</sub>	200	400	600	800	V
Maximum average forward rectified output current at	T <sub>C</sub> = 107 °C	I <sub>F(AV)</sub> <sup>(1)</sup>				A
	T <sub>A</sub> = 25 °C	I <sub>F(AV)</sub> <sup>(2)</sup>				
Peak forward surge current single sine-wave superimposed on rated load	I <sub>FSM</sub>	200				A
Rating for fusing (t < 8.3 ms)	I <sup>2</sup> t	166				A <sup>2</sup> s
Operating junction and storage temperature range	T <sub>J</sub> , T <sub>STG</sub>	- 55 to + 150				°C

### Notes

- (1) Unit case mounted on aluminum plate heatsink
- (2) Units mounted on PCB without heatsink



<b>ELECTRICAL CHARACTERISTICS</b> ( $T_A = 25\text{ }^\circ\text{C}$ unless otherwise noted)							
PARAMETER	TEST CONDITIONS	SYMBOL	GSIB15A20N	GSIB15A40N	GSIB15A60N	GSIB15A80N	UNIT
Maximum instantaneous forward voltage drop per diode	$I_F = 7.5\text{ A}$	$V_F$	1.0				V
Maximum DC reverse current at rated DC blocking voltage per diode	$T_A = 25\text{ }^\circ\text{C}$	$I_R$	10				$\mu\text{A}$
	$T_A = 125\text{ }^\circ\text{C}$		250				

<b>THERMAL CHARACTERISTICS</b> ( $T_A = 25\text{ }^\circ\text{C}$ unless otherwise noted)							
PARAMETER	SYMBOL	GSIB15A20N	GSIB15A40N	GSIB15A60N	GSIB15A80N	UNIT	
Maximum thermal resistance	$R_{\theta JA}$ (2)	22				$^\circ\text{C/W}$	
	$R_{\theta JC}$ (1)	1.5					

**Notes**

- (1) Unit case mounted on aluminum plate heatsink
- (2) Units mounted on PCB without heatsink
- (3) Recommended mounting position is to bolt down on heatsink with silicone thermal compound for maximum heat transfer with #6 screw

<b>ORDERING INFORMATION</b> (Example)				
PREFERRED P/N	UNIT WEIGHT (g)	PREFERRED PACKAGE CODE	BASE QUANTITY	DELIVERY MODE
GSIB15A60N-M3/45	7.0	45	20	Tube

**RATINGS AND CHARACTERISTICS CURVES** ( $T_A = 25\text{ }^\circ\text{C}$  unless otherwise noted)

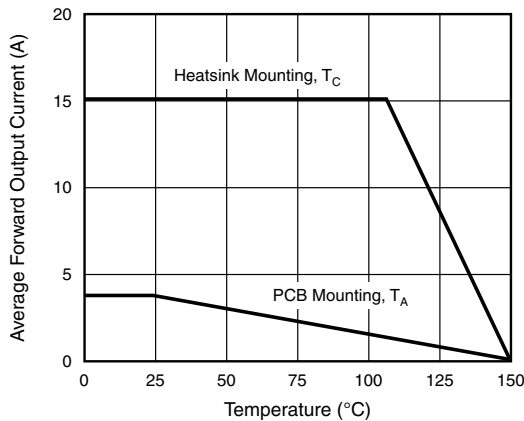

Fig. 1 - Derating Curve Output Rectified Current

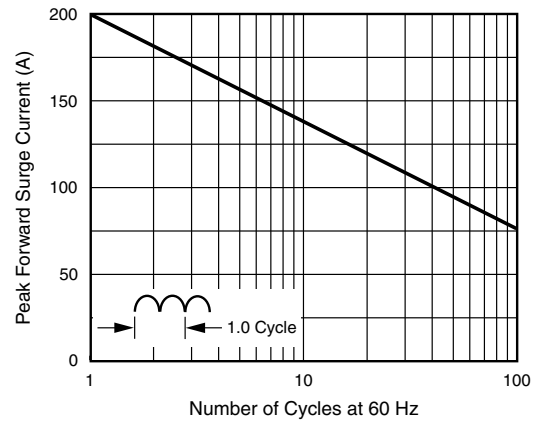

Fig. 2 - Maximum Non-Repetitive Peak Forward Surge Current Per Diode

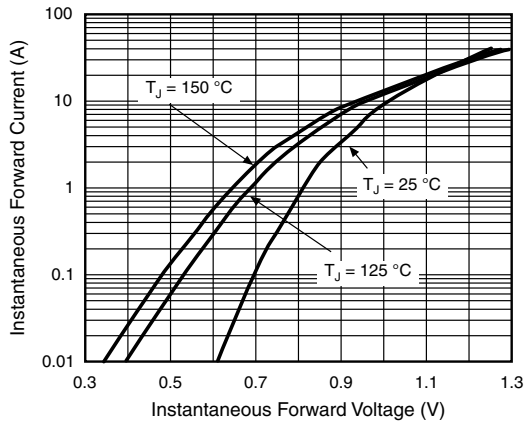

Fig. 3 - Typical Forward Characteristics Per Diode

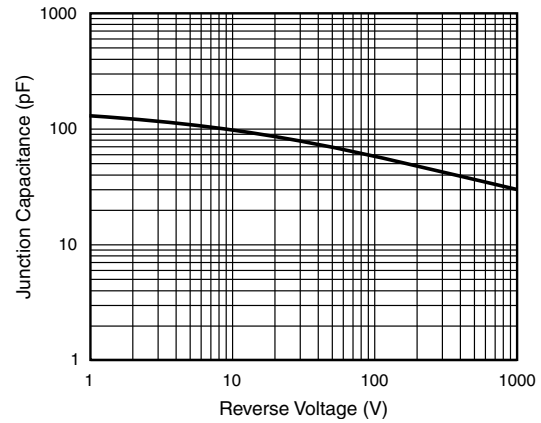

Fig. 5 - Typical Junction Capacitance Per Diode

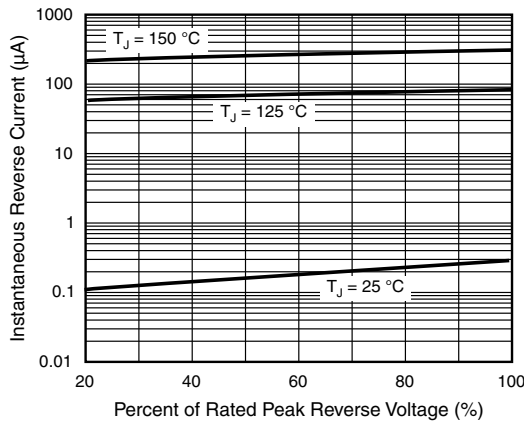

Fig. 4 - Typical Reverse Characteristics Per Diode

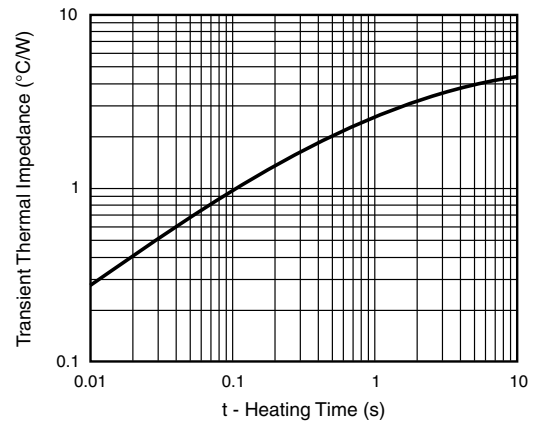
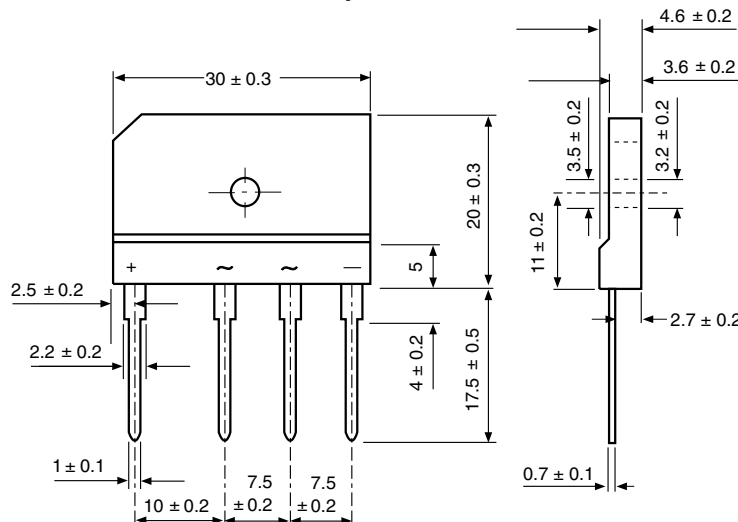

Fig. 6 - Typical Transient Thermal Impedance

## PACKAGE OUTLINE DIMENSIONS in inches (millimeters)

### Case Style GSIB-5S





## Disclaimer

ALL PRODUCT, PRODUCT SPECIFICATIONS AND DATA ARE SUBJECT TO CHANGE WITHOUT NOTICE TO IMPROVE RELIABILITY, FUNCTION OR DESIGN OR OTHERWISE.

Vishay Intertechnology, Inc., its affiliates, agents, and employees, and all persons acting on its or their behalf (collectively, "Vishay"), disclaim any and all liability for any errors, inaccuracies or incompleteness contained in any datasheet or in any other disclosure relating to any product.

Vishay makes no warranty, representation or guarantee regarding the suitability of the products for any particular purpose or the continuing production of any product. To the maximum extent permitted by applicable law, Vishay disclaims (i) any and all liability arising out of the application or use of any product, (ii) any and all liability, including without limitation special, consequential or incidental damages, and (iii) any and all implied warranties, including warranties of fitness for particular purpose, non-infringement and merchantability.

Statements regarding the suitability of products for certain types of applications are based on Vishay's knowledge of typical requirements that are often placed on Vishay products in generic applications. Such statements are not binding statements about the suitability of products for a particular application. It is the customer's responsibility to validate that a particular product with the properties described in the product specification is suitable for use in a particular application. Parameters provided in datasheets and/or specifications may vary in different applications and performance may vary over time. All operating parameters, including typical parameters, must be validated for each customer application by the customer's technical experts. Product specifications do not expand or otherwise modify Vishay's terms and conditions of purchase, including but not limited to the warranty expressed therein.

Except as expressly indicated in writing, Vishay products are not designed for use in medical, life-saving, or life-sustaining applications or for any other application in which the failure of the Vishay product could result in personal injury or death. Customers using or selling Vishay products not expressly indicated for use in such applications do so at their own risk. Please contact authorized Vishay personnel to obtain written terms and conditions regarding products designed for such applications.

No license, express or implied, by estoppel or otherwise, to any intellectual property rights is granted by this document or by any conduct of Vishay. Product names and markings noted herein may be trademarks of their respective owners.

## Material Category Policy

**Vishay Intertechnology, Inc. hereby certifies that all its products that are identified as RoHS-Compliant fulfill the definitions and restrictions defined under Directive 2011/65/EU of The European Parliament and of the Council of June 8, 2011 on the restriction of the use of certain hazardous substances in electrical and electronic equipment (EEE) - recast, unless otherwise specified as non-compliant.**

**Please note that some Vishay documentation may still make reference to RoHS Directive 2002/95/EC. We confirm that all the products identified as being compliant to Directive 2002/95/EC conform to Directive 2011/65/EU.**

**Vishay Intertechnology, Inc. hereby certifies that all its products that are identified as Halogen-Free follow Halogen-Free requirements as per JEDEC JS709A standards. Please note that some Vishay documentation may still make reference to the IEC 61249-2-21 definition. We confirm that all the products identified as being compliant to IEC 61249-2-21 conform to JEDEC JS709A standards.**



## Стандарт Электрон Связь

Мы молодая и активно развивающаяся компания в области поставок электронных компонентов. Мы поставляем электронные компоненты отечественного и импортного производства напрямую от производителей и с крупнейших складов мира.

Благодаря сотрудничеству с мировыми поставщиками мы осуществляем комплексные и плановые поставки широчайшего спектра электронных компонентов.

Собственная эффективная логистика и склад в обеспечивает надежную поставку продукции в точно указанные сроки по всей России.

Мы осуществляем техническую поддержку нашим клиентам и предпродажную проверку качества продукции. На все поставляемые продукты мы предоставляем гарантию .

Осуществляем поставки продукции под контролем ВП МО РФ на предприятия военно-промышленного комплекса России , а также работаем в рамках 275 ФЗ с открытием отдельных счетов в уполномоченном банке. Система менеджмента качества компании соответствует требованиям ГОСТ ISO 9001.

Минимальные сроки поставки, гибкие цены, неограниченный ассортимент и индивидуальный подход к клиентам являются основой для выстраивания долгосрочного и эффективного сотрудничества с предприятиями радиоэлектронной промышленности, предприятиями ВПК и научно-исследовательскими институтами России.

С нами вы становитесь еще успешнее!

### Наши контакты:

**Телефон:** +7 812 627 14 35

**Электронная почта:** [sales@st-electron.ru](mailto:sales@st-electron.ru)

**Адрес:** 198099, Санкт-Петербург,  
Промышленная ул, дом № 19, литера Н,  
помещение 100-Н Офис 331