



S26KL512S/S26KS512S
S26KL256S/S26KS256S
S26KL128S/S26KS128S

**512 Mb (64 MB)/256 Mb (32 MB)/
128 Mb (16 MB), 1.8V/3.0V
HyperFlash™ Family**

Features

- 3.0V I/O, 11 bus signals
 - Single ended clock
- 1.8V I/O, 12 bus signals
 - Differential clock (CK, CK#)
- Chip Select (CS#)
- 8-bit data bus (DQ[7:0])
- Read-Write Data Strobe (RWDS)
 - HyperFlash™ memories use RWDS only as a Read Data Strobe
- Up to 333 MBps sustained read throughput
- Double-Data Rate (DDR) – two data transfers per clock
- 166-MHz clock rate (333 MBps) at 1.8V V_{CC}
- 100-MHz clock rate (200 MBps) at 3.0V V_{CC}
- 96-ns initial random read access time
 - Initial random access read latency: five to 16 clock cycles
- Sequential burst transactions
- Configurable Burst Characteristics
 - Wrapped burst lengths:
 - 16 bytes (8 clocks)
 - 32 bytes (16 clocks)
 - 64 bytes (32 clocks)
 - Linear burst
 - Hybrid option: one wrapped burst followed by linear burst
 - Wrapped or linear burst type selected in each transaction
 - Configurable output drive strength
- Low Power Modes
 - Active Clock Stop During Read: 12 mA, no wake-up required
 - Standby: 25 μ A (typical), no wake-up required
 - Deep Power-Down: 8 μ A (typical)
 - 300 μ s wake-up required
- INT# output to generate external interrupt
 - Busy to Ready Transition
 - ECC detection
- RSTO# output to generate system level power-on reset
 - User configurable RSTO# Low period
- 512-byte Program Buffer
- Sector Erase
 - Uniform 256-KB sectors
 - Optional Eight 4-KB Parameter Sectors (32 KB total)
- Advanced Sector Protection
 - Volatile and non-volatile protection methods for each sector
- Separate 1024-byte one-time program array
- Operating Temperature
 - Industrial (–40°C to +85°C)
 - Industrial Plus (–40°C to +105°C)
 - Extended (–40°C to +125°C)
 - Automotive, AEC-Q100 Grade 3 (–40°C to +85°C)
 - Automotive, AEC-Q100 Grade 2 (–40°C to +105°C)
 - Automotive, AEC-Q100 Grade 1 (–40°C to +125°C)
- ISO/TS16949 and AEC Q100 Certified
- Endurance
 - 100,000 program/erase cycles
- Retention
 - 20 year data retention
- Erase and Program Current
 - Max Peak \leq 100 mA
- Packaging Options
 - 24-Ball FBGA
- Additional Features
 - ECC 1-bit correction, 2-bit detection
 - CRC

Performance Summary

| Read Access Timings | |
|---|---------|
| Maximum Clock Rate at 1.8V V_{CC}/V_{CCQ} | 166 MHz |
| Maximum Clock Rate at 3.0V V_{CC}/V_{CCQ} | 100 MHz |
| Maximum Access Time, (t_{ACC}) | 96 ns |
| Maximum CS# Access Time to First Word @ 166 MHz | 118 ns |

| Typical Program / Erase Times | |
|---|-----------------------|
| Single Word Programming (2B = 16b) | 500 μ s (~4 KBps) |
| Write Buffer Programming (512B = 4096b) | 475 μ s (~1 MBps) |
| Sector Erase Time (256 KB = 2 Mb) | 930 ms (~282 KBps) |

| Typical Current Consumption | |
|---|---------------------------------|
| Burst Read (Continuous Read at 166 MHz) | 80 mA |
| Power-On Reset | 80 mA |
| Sector Erase Current | 60 mA |
| Write Buffer Programming Current | 60 mA |
| Standby (CS# = High) | 25 μ A |
| Deep Power-Down (CS# = High, 85°C) | 30 μ A (512 Mb) |
| | 4 μ A (all other densities) |

Contents

| | | | |
|---|----|--|-----------|
| 1. General Description | 4 | 9.2 Data Retention | 71 |
| 1.1 DDR Center Aligned Read Strobe Functionality (DCARS) | 6 | Hardware Interface | |
| 1.2 Error Detection and Correction Functionality..... | 6 | 10. Electrical Specifications | 72 |
| 2. Connection Diagram | 9 | 10.1 Absolute Maximum Ratings..... | 72 |
| 2.1 FBGA 24-Ball 5 ´ 5 Array Footprint..... | 9 | 10.2 Thermal Impedance | 73 |
| 3. Signal Description | 10 | 10.3 Latchup Characteristics..... | 73 |
| 4. HyperBus Protocol | 11 | 10.4 Operating Ranges | 73 |
| 4.1 Command / Address Bit Assignments..... | 11 | 10.5 DC Characteristics (CMOS Compatible) | 74 |
| 4.2 Read Operations | 12 | 10.6 Power-Up and Power-Down | 77 |
| 4.3 HyperFlash Read with DCARS Timing..... | 15 | 10.7 Power-Off with Hardware Data Protection | 81 |
| 4.4 Write Operations | 16 | 10.8 Power Conservation Modes | 81 |
| 5. Address Space Maps | 18 | 11. Timing Specifications | 83 |
| 5.1 Flash Memory Array | 19 | 11.1 AC Test Conditions | 83 |
| 5.2 Device ID and CFI (ID-CFI) ASO..... | 21 | 11.2 AC Characteristics..... | 84 |
| 6. Embedded Operations | 23 | 12. Embedded Algorithm Performance | 89 |
| 6.1 Embedded Algorithm Controller (EAC)..... | 23 | 13. Ordering Information | 90 |
| 6.2 Program and Erase Summary..... | 24 | 13.1 Ordering Part Numbers | 90 |
| 6.3 Data Protection..... | 49 | 13.2 Valid Combinations — Standard | 91 |
| 7. Device ID and Common Flash Interface (ID-CFI) ASO Map | 58 | 13.3 Valid Combinations — Automotive Grade / AEC-Q100 | 93 |
| 7.1 Device ID and Common Flash Interface (ID-CFI) ASO Map — Standard..... | 58 | 14. Physical Interface | 95 |
| 7.2 Device ID and Common Flash Interface (ID-CFI) ASO Map — Automotive Grade / AEC-Q100..... | 63 | 14.1 Physical Diagram | 95 |
| 8. Software Interface Reference | 64 | 15. Document History Page | 96 |
| 8.1 Command Summary..... | 64 | Sales, Solutions, and Legal Information | 99 |
| 9. Data Integrity | 71 | Worldwide Sales and Design Support | 99 |
| 9.1 Endurance | 71 | Products | 99 |
| | | PSoC® Solutions | 99 |
| | | Cypress Developer Community | 99 |
| | | Technical Support | 99 |

1. General Description

The Cypress HyperFlash family of products are high-speed CMOS, MirrorBit[®] NOR flash devices with the HyperBus low signal count DDR interface, that achieves high speed read throughput. The DDR protocol transfers two data bytes per clock cycle on the data (DQ) signals. A read or write access for the HyperFlash consists of a series of 16-bit wide, one clock cycle data transfers at the internal HyperFlash core and two corresponding 8-bit wide, one-half-clock-cycle data transfers on the DQ signals.

Both data and command/address information are transferred in DDR fashion over the 8-bit data bus. The clock input signals are used for signal capture by the HyperFlash device when receiving command/address/data information on the DQ signals. The Read Data Strobe (RWDS) is an output from the HyperFlash device that indicates when data is being transferred from the memory to the host. RWDS is referenced to the rising and falling edges of CK during the data transfer portion of read operations.

Command/address/write-data values are center aligned with the clock edges and read-data values are edge aligned with the transitions of RWDS.

Read and write operations to the HyperFlash device are burst oriented. Read transactions can be specified to use either a wrapped or linear burst. During wrapped operation, accesses start at a selected location and continue for a configured number of locations in a group wrap sequence. During linear operation accesses start at a selected location and continue in a sequential manner until the read operation is terminated, when CS# returns High. Write transactions transfer one or more 16-bit values.

Figure 1. Logic Block Diagram



The HyperFlash family consists of multiple densities, 1.8V/3.0V core and I/O, non-volatile, synchronous flash memory devices. These devices have an 8-bit (1-byte) wide DDR data bus and use only word-wide (16-bit data) address boundaries. Read operations provide 16 bits of data during each clock cycle (8 bits on each clock edge). Write operations take 16 bits of data from each clock cycle (8 bits on each clock edge).

Each random read accesses a 32-byte length and aligned set of data called a page. Each page consists of a pair of 16-byte aligned groups of array data called half-pages. Half-pages are aligned on 16-byte address boundaries. A read access requires two clock cycles to define the target half-page address and the burst type, then an additional initial latency. During the initial latency period the third clock cycle will specify the starting address within the target half-page. After the initial data value has been output, additional data can be read from the Page on subsequent clock cycles in either a wrapped or linear manner. When configured in linear burst mode, while a page is being burst out, the device will automatically fetch the next sequential page from the MirrorBit flash memory array. This simultaneous burst output while fetching from the array allows for a linear sequential burst operation that can provide a sustained output of 333 MBps data rate [1-byte (8-bit data bus) * 2 (Data on both clock edges) * 166 MHz = 333 MBps].

Table 1. S26KS Address Map

| Type | Count | Addresses | Notes |
|---|---|------------|-----------|
| Word Address within a half-page (16 byte) | 8 (word addresses) | A2 – A0 | 16 bytes |
| Word Address within Write Buffer Line (512 byte) | 256 (word addresses) | A7 – A0 | 512 bytes |
| Half-pages (16 bytes) within Erase Sector (256 KB) | 8192 (half-pages) | A16 – A3 | |
| Write Buffer Lines (512 bytes) within Erase Sector (256 KB) | 512 (lines) | A16 – A8 | |
| Total Number of Erase Sectors (256 KB) | 256 (512 Mb) 128 (256 Mb) 64 (128 Mb) | Amax – A17 | |

The device control logic is subdivided into two parallel operating sections: the Host Interface Controller (HIC) and the Embedded Algorithm Controller (EAC). The HIC monitors signal levels on the device inputs and drives outputs as needed to complete read and write data transfers with the host system (HyperFlash master). The HIC delivers data from the currently entered address map on read transfers; places write transfer address and data information into the EAC command memory; notifies the EAC of power transition, and write transfers. The EAC looks in the command memory, after a write transfer, for legal command sequences and performs the related Embedded Algorithms.

Changing the non-volatile data in the memory array requires a complex sequence of operations that are called Embedded Algorithms (EA). The algorithms are managed entirely by the internal EAC. The main algorithms perform programming and erase of the main flash array data. The host system writes command codes to the flash device address space. The EAC receives the command, performs all the necessary steps to complete the command, and provides status information during the progress of an EA.

The erased state of each memory bit is a logic '1'. Programming changes a logic '1' (High) to a logic '0' (Low). Only an erase operation is able to change a '0' to a '1'. An erase operation must be performed on an entire 256-KB (or 4-KB for parameter sectors) aligned group of data called a Sector. When shipped from Cypress, all Sectors are erased.

Programming is done via a 512-byte Write Buffer. It is possible to write from one to 256 words, anywhere within the Write Buffer before starting a programming operation. Within the flash memory array, each 512-byte aligned group of data is called a Line. A programming operation transfers data from the volatile Write Buffer to a non-volatile memory array Line. The operation is called Write Buffer Programming.

The Write Buffer is filled with 1s after reset or the completion of any operation using the Write Buffer. Any locations not written to a '0' by a Write to Buffer command are by default still filled with 1s. Any 1s in the Write Buffer do not affect data in the memory array during a programming operation.

In addition to the mandatory signals (CS#, CK, CK#, DQ [7:0], RWDS) dedicated to the HyperBus, the device also includes optional signals (RESET#, INT#, RSTO#, and Phase Shifted clocks PSC/PSC#).

When RESET# transitions from Low to High the device returns to the default state that occurs after an internal Power-On Reset (POR).

The INT# output can provide an interrupt to the HyperFlash master to indicate when the HyperFlash transitions from busy to ready at the end of a program or erase operation.

The RSTO# is an open-drain output used to indicate when a POR is occurring within the device and can be used as a system level reset signal. Upon completion of the internal POR, the RSTO# signal will transition from Low to High impedance after a user defined timeout period has expired. Upon transition to the high impedance state, the external pull-up resistance will pull RSTO# High and the device immediately is placed into the Standby state.

PSC/PSC# are differential Phase Shifted Clock inputs used as a reference for RWDS edges instead of CK/CK#. Refer to [Section 1.1 DDR Center Aligned Read Strobe Functionality \(DCARS\)](#) on page 6 for more details.

1.1 DDR Center Aligned Read Strobe Functionality (DCARS)

The HyperFlash memories offer a configurable feature that enables independent skewing (phase shifting) of the RWDS signal with respect to the read data outputs.

When the DDR Center Aligned Read Strobe (DCARS) feature is enabled, a second differential Phase Shifted Clock input PSC/PSC# is used as the reference for RWDS edges instead of CK/CK#. The second clock is generally a copy of CK/CK# that is phase shifted 90° to place the RWDS edges centered within the DQ signals valid data window. However, other degrees of phase shift between CK/CK# and PSC/PSC# may be used to optimize the position of RWDS edges within the DQ signals valid data window so that RWDS provides the desired amount of data setup and hold time in relation to RWDS edges.

PSC/PSC# is not used during a write transaction. PSC and PSC# may be driven Low and High respectively or, both may be driven Low during write transactions.

1.2 Error Detection and Correction Functionality

1.2.1 Error Correction Code

HyperFlash memories provide embedded Hamming Error Correction Code (ECC) generation during Flash memory array programming, with error detection and correction during read.

As each 16-byte aligned half-page of data, loaded into the Write Buffer, is transferred to the 512-byte flash memory array Line, an Error Correction Code (ECC) for each Half-page ECC unit is also programmed in to a portion of the memory array not visible to the host system software.

The ECC information is checked during each Half-page Flash array read operation. Any one bit error within the Half-page will be corrected by the ECC logic during the access of each Half-page.

The ECC information for each Half-page can be written once after each erase of the sector containing each Half-page. Programming within the same Half-page more than once will disable error detection and correction within that Half-page.

Word Programming and Write Buffer Programming, more than once within a Half-page, is supported for legacy software compatibility. However, for the best data integrity, it is recommended to not use Word Programming or Write Buffer Programming to program within a Half-page, more than once. Multiple writes to the same half page without an erase will disable the ECC functionality since the ECC syndrome becomes invalid. For applications requiring multiple programming operations within the same Half-page, it is recommended to add system software Error Detection and Correction, to enhance the data integrity of Half-pages that are programmed more than once.

There is a mode that may be enabled for two bit error detection. When this mode is enabled, any one bit error in a Half-page is corrected and any two bit error is detected and reported. In this mode, the ability to write to the same half-page more than once, after an erase, is disabled. In this mode, attempting to program more than once in the same Half-page will result in programming operation failure status.

ECC errors may be detected by reading an ECC status register, enabling an interrupt, or enabling the RWDS to stop when an uncorrectable error is encountered - to create a bus error before data is transferred to the HyperBus master.

A register is provided to capture the address location of the ECC error.

A counter is provided to count ECC corrections or uncorrectable errors.

1.2.2 Cyclic Redundancy Check

A group of commands are provided to perform a hardware accelerated CRC calculation over a user defined address range. The calculation is another type of embedded operation similar to programming or erase, in which the device is busy while the calculation is in progress. The CRC operation uses a 32-bit polynomial able to detect up to a 32-bit long group of error bits.

A command is used to enter the CRC Address Space Overlay (ASO) where the desired address range is loaded to start the CRC calculation. While entered in the CRC ASO the status of the CRC operation may be checked, suspended to read from the memory array, resumed, and the resulting check-value read. Refer to [Section 5. Address Space Maps on page 18](#) for more details.

1.2.2.1 CRC Check-Value Calculation

The Check-value calculation command sequence causes the device to perform a CRC calculation over a user defined address range. The CRC calculation is achieved with the polynomial described in [Figure 2](#).

The Check-value generation sequence is started by entering the CRC ASO. The next step is to load the beginning address into the CRC Start Address Register identifying the beginning of the address range that will be covered by the CRC calculation. Next, the ending address is loaded into the CRC End Address Register, this step starts the CRC calculation. The CRC process calculates the Check-value on the data contained at the starting address through the ending address.

During the calculation period, the device goes into the Busy state (SR[7] = 0). Once the Check-value calculation has completed, the device returns to the Ready state (SR[7] = 1) and the calculated Check-value is available in the Check-value Low Result Register and the Check-value High Result Register. The Check-value Low Result Register contains Check-value bits 0-15 and can be read from address 0 while the device is in the CRC ASO. The Check-value High Result Register contains bits 16-31 and can be read from address 1 while the device is in the CRC ASO. The Check-value Low Result Register and the Check-value High Result Register are loaded with 0s once the CRC calculation process is initiated.

The Check-value calculation can only be initiated when the device is in Standby state and once started can be suspended with the CRC Suspend sequence to read data from the array. During the Suspended state, the CRC Suspend Status Bit (CRCSSB) in the Status Register will be set (SR[8] = 1). Once suspended, the host can read the Status Register, read data from the array and can resume the CRC calculation by using the CRC Resume command sequence. Once initiated, the CRC ASO can be terminated with the ASO Exit Command or a Hardware Reset to return the device to Read Array Mode. The Check-value calculation cannot be performed while another ASO is active. A Hardware Reset will clear the value in the CRC Start Address Register, CRC End Address Register, Check-value High Result Register, and the Check-value Low Result Register.

The Ending Address (EA) should be at least two addresses higher than the Starting Address (SA). If EA < SA + 2, the Check-value Calculation will abort and the device will return to the Ready state (SR[7] = 1). SR[3] will be set (1) to indicate the aborted condition. If EA < SA + 2, the Check-value High Result Register and the Check-value Low Result Register will hold indeterminate data.

Figure 2. CRC-32 Polynomial

$$\text{CRC-32C Polynomial} = X^{32} + X^{28} + X^{27} + X^{26} + X^{25} + X^{23} + X^{22} + X^{20} + X^{19} + X^{18} + X^{14} + X^{13} + X^{11} + X^{10} + X^9 + X^8 + X^6 + 1$$

Figure 3. Check-Value Calculation Sequence



The read data ordering used in calculating the check-value from the CRC-32 polynomial is shown as follows:



2. Connection Diagram

2.1 FBGA 24-Ball 5 × 5 Array Footprint

HyperFlash devices are provided in Fortified Ball Grid Array (FBGA), 1 mm pitch, 24-ball, 5 × 5 ball array footprint, with 6 mm × 8 mm body. The package height is device dependent and may be either 1 mm or 1.2 mm. Refer to [Section 13. Ordering Information on page 90](#) for more details. Refer to the device datasheet Ordering Part Number valid combinations section for the package in use.

Figure 4. 24-Ball FBGA, 6 × 8 mm, 5 × 5 Ball Footprint, Top View^[1, 2, 3]

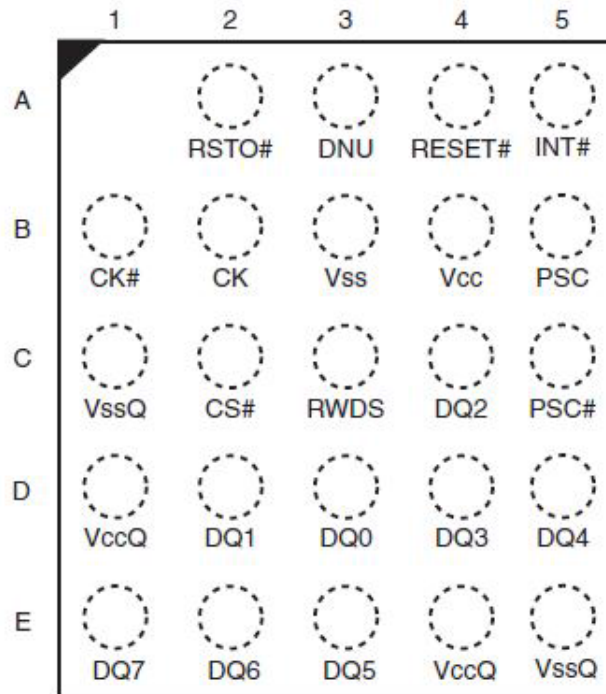

Notes

1. B1 (CK#) is RFU on the 3.0V device (model 02).
2. B5 (PSC) and C5 (PSC#) are RFU on standard 3.0V and 1.8V devices (model 02). C5 (PSC#) is RFU on 3V DCARS device (model 03).
3. DNU — Do not Use. This pin/ball is connected internally and must be left unconnected.

3. Signal Description

Figure 5. HyperFlash Interface



Table 2. Signal Description

| Symbol | Type | M / O | Description |
|------------------|---------------------|-------|--|
| CS# | Input | M | Chip Select. HyperFlash bus transactions are initiated with a High to Low transition. HyperFlash bus transactions are terminated with a Low to High transition. |
| CK, CK# | Input | M | Differential Clock. Command / Address / Data information is input or output with respect to the crossing of the CK and CK# signals. CK# is only used on the 1.8V devices and may be left open or connected to CK on 3V devices. |
| RWDS | Output | M | Read Write Data Strobe. Output data during read transactions are edge aligned with RWDS. |
| DQ[7..0] | Input / Output | M | Data Input / Output. Command / Address / Data information is transferred on these DQs during read and write transactions. |
| PSC, PSC# | Input | O | Phase Shifted Clock. PSC/PSC# allows independent skewing of the RWDS signal with respect to the CK/CK# inputs. PSC# is only used on the 1.8V device. PSC and PSC# may be driven High and Low respectively or both may be driven Low during write transactions. |
| INT# | Output (open drain) | O | INT Output. When Low, the device is indicating that an internal event has occurred. This signal is intended to be used as a system level interrupt for the device to indicate that an on-chip event has occurred. INT# is an open-drain output. |
| RESET# | Input | O | Hardware Reset. When Low, the device will self initialize and return to the array read state. RWDS and DQ[7:0] are placed into the High-Z state when RESET# is Low. RESET# includes a weak pull-up, if RESET# is left unconnected it will be pulled up to the High state. |
| RSTO# | Output (open drain) | O | RSTO# Output. RSTO# is an open-drain output used to indicate when a POR is occurring within the device and can be used as a system level reset signal. Upon completion of the internal POR the RSTO# signal will transition from Low to high impedance after a user defined timeout period has elapsed. Upon transition to the high impedance state the external pull-up resistance will pull RSTO# High and the device immediately is placed into the Standby state. |
| V _{CC} | Power Supply | P/G | Power. |
| V _{CCQ} | Power Supply | P/G | Input / Output Power. |
| V _{SS} | Power Supply | P/G | Ground. |
| V _{SSQ} | Power Supply | P/G | Input / Output Ground. |

Note

4. M = Mandatory; O = Optional; P/G = Power / Ground.

4. HyperBus Protocol

All bus transactions can be classified as either read or write. A bus transaction is started with CS# going Low with CK = Low and CK# = High. The transaction to be performed is presented to the HyperFlash device during the first three clock cycles in a DDR manner using all six clock edges. These first three clocks transfer three words of Command / Address (CA0, CA1, CA2) information to define the transaction characteristics:

- Read or write transaction.
- Whether the transaction will be to the memory array or to register space.
 - Although the HyperBus protocol provides for slave devices that have both memory and register address spaces, HyperFlash memories described in this specification do not differentiate between memory and registers as separate address spaces. There is a single address space selected by any transaction, independent of whether the transaction indicates the target location is in memory space or register space. Write transactions always place the transaction address and data into a command register set (buffer). Read transactions return data from the memory array or from a register address space window that has been temporarily overlaid within the single address space by the execution of commands. The single address space with register space overlays methodology is backward compatible with legacy parallel NOR Flash memory program and erase software drivers.
- Whether a transaction will use a linear or wrapped burst sequence.
 - HyperFlash write transactions do not support burst sequence and ignore the burst type indication. Write command transactions transfer a single word per write. Only the Word Program command write data transfer may be done with a linear burst at up to 50 MHz.
- The target half-page address (row and upper order column address).
- The target Word (within half-page) address (lower order column address).

Once the transaction has been defined, a number of idle clock cycles are used to satisfy any read latency requirements before data is transferred. Once the target data has been transferred, the HyperBus master host completes the transaction by driving CS# High with CK = Low and CK# = High. Data is transferred as 16-bit values with the first eight bits (15-8) transferred on a High going CK (write data or CA bits) or RWDS edge (read data) and the second eight bits (7-0) being transferred on the Low going CK or RWDS edge. Data transfers during read or write operations can be ended at any time by bringing CS# High when CK = Low and CK# = High. Read data is edge aligned with RWDS transitions and Write data is center aligned with clock edges.

4.1 Command / Address Bit Assignments

Table 3. Command / Address Bit Assignments

| CA Bit# | Bit Name | Bit Function |
|--------------------------------|------------------------------|---|
| 47 | R/W# | Identifies the transaction as a Read or Write. 1 = Read operation 0 = Write operation Target space is defined in CA46. |
| 46 | Target | Indicates whether the Read or Write operation accesses the memory or register spaces. 0 = memory space 1 = register space The register space is intended to be used by volatile memory and peripheral devices. The HyperFlash devices will not take advantage of this feature and this bit should be set to 0 during Read or Write transactions. |
| 45 | Burst Type | Indicates whether the burst will be linear or wrapped. 0 = Wrapped Burst 1 = Linear Burst |
| 44-39 (1 Gb) 44-38 (512 Mb) | Reserved | Reserved for future address expansion. Reserved bits should be set to 0 by the host controller. |
| 38-16 (1 Gb) 37-16 (512 Mb) | Row and Upper Column Address | Half page component of target address. |
| 15-3 | Reserved | Reserved for future column address expansion. Reserved bits should be set to 0 by the host controller. |
| 2-0 | Lower Column Address | Lower Column component of the target address: System word address bits A2-0 selecting the starting word within a half-page. |

4.2 Read Operations

CA0 indicates that a read operation is to be performed and also indicates the burst type (wrapped or linear). Read operations begin the internal array access as soon as the half-page address has been presented in CA0 and CA1. CA2 identifies the target word address within the chosen half-page. The host then continues clocking for a number of cycles defined by the latency count setting in the Configuration Register. Once these latency clocks have been completed, the memory starts to simultaneously transition the Read Write Data Strobe (RWDS) and begins outputting the target data. New data is output in an edge aligned fashion upon every transition of RWDS. Data will continue to be output as long as the host continues to transition the clock (CK and CK#). Wrapped bursts will continue to wrap within the burst length and linear burst will output data in a sequential manner across page boundaries. A Hybrid Burst provides one initial wrapped burst followed by linear burst, as described in [Section 6.3.11 Hybrid Burst on page 55](#). Wrapped reads can be performed from the main array, the CFI Tables in [Section 7. Device ID and Common Flash Interface \(ID-CFI\) ASO Map on page 58](#) and the Secure Silicon Region (see [Section 6.3.11 Hybrid Burst on page 55](#)). Read transfers can be ended at any time by bringing CS# High when CK = Low and CK# = High.

When a linear burst reaches the last address in the array, if the burst continues, the address counter will wrap around and roll back to address 000000h, allowing the read sequence to be continued indefinitely. The entire memory can therefore be read out with one single read instruction.

The 16-byte and 32-byte wrapped bursts do not cross page boundaries and do not incur inter-page boundary crossing latencies. For a 64-byte wrapped burst read, a latency may occur during the target address to next page boundary crossing, depending on the starting address (see [Table 22 on page 39](#)).

Figure 6. Read Operation^[5, 6, 7, 8]



Notes

- Transactions must be initiated with CK = Low and CK# = High. CS# must return High before a new transaction is initiated.
- Read access from the flash array starts once CA[23:16] is captured.
- The read latency is defined by the Read Latency value in the Volatile Configuration Register (or the Non-Volatile Configuration Register).
- In this example of a read operation, the Latency Count was set to five clocks.

Table 4. Maximum Operating Frequency for Latency Code Options

| Latency Code | Latency Clocks | Maximum Operating Frequency (MHz) |
|--------------|----------------|-----------------------------------|
| 0000 | 5 | 52 |
| 0001 | 6 | 62 |
| 0010 | 7 | 72 |
| 0011 | 8 | 83 |
| 0100 | 9 | 93 |
| 0101 | 10 | 104 |
| 0110 | 11 | 114 |
| 0111 | 12 | 125 |
| 1000 | 13 | 135 |
| 1001 | 14 | 145 |
| 1010 | 15 | 156 |
| 1011 | 16 | 166 |
| 1100 | Reserved | NA |
| 1101 | Reserved | NA |
| 1110 | Reserved | NA |
| 1111 | Reserved | NA |

Notes

- 9. Default NVCR latency setting when the device is shipped from the factory is 16 clocks.
- 10. The Latency Code is the value loaded into (Non) Volatile Configuration Register bits xVCR[7:4].
- 11. Maximum Operating Frequency assumed to be using a device with $t_{ACC} = 96$ ns.

Figure 7. Read Transaction Crossing a Page Boundary [12, 13, 14, 15, 16]

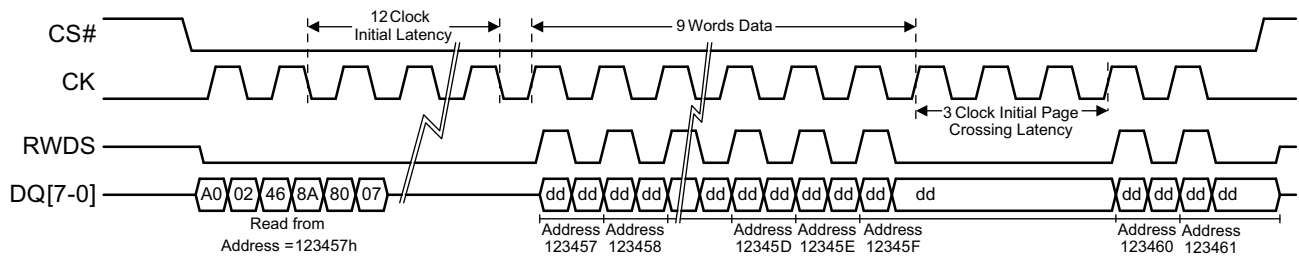

Notes

- 12. Read operation starting at device address 123457h.
- 13. Latency code loaded into the Configuration Register is 0111b which results in 12 latency clocks.
- 14. Page boundary crossing requires three clocks in this case. 12 clock initial latency minus 9 clocks (words) of initial data.
- 15. CK# is not shown but is the complement of the CK signal.
- 16. CA45 = 1 for a linear Read burst.

Table 5. First Page Boundary Crossing During Linear Read (Latency Count = 11 Clocks)

| Target Address | Clock Cycle | | | | | | | | | | | | | | | | | | | | | | | | | | | | | |
|----------------------|-------------|-----|-----|----------------------------------|-----|-----|-----|-----|-----|-----|-----|-----|-----|-----|-----|-----|-----|-----|-----|-----|-----|-----|-----|-----|--|--|--|--|--|--|
| | 0 | 1 | 2 | 3 | ... | 12 | 13 | 14 | 15 | 16 | 17 | 18 | 19 | 20 | 21 | 22 | 23 | 24 | 25 | 26 | 27 | 28 | 29 | 30 | | | | | | |
| 0 | CA0 | CA1 | CA2 | Bus Turnaround + Initial Latency | | | D0 | D1 | D2 | D3 | D4 | D5 | D6 | D7 | D8 | D9 | D10 | D11 | D12 | D13 | D14 | D15 | D16 | D17 | | | | | | |
| 1 | | | | | D1 | D2 | D3 | D4 | D5 | D6 | D7 | D8 | D9 | D10 | D11 | D12 | D13 | D14 | D15 | D16 | D17 | D18 | | | | | | | | |
| 2 | | | | | D2 | D3 | D4 | D5 | D6 | D7 | D8 | D9 | D10 | D11 | D12 | D13 | D14 | D15 | D16 | D17 | D18 | D19 | | | | | | | | |
| 3 | | | | | D3 | D4 | D5 | D6 | D7 | D8 | D9 | D10 | D11 | D12 | D13 | D14 | D15 | D16 | D17 | D18 | D19 | D20 | | | | | | | | |
| 4 | | | | | D4 | D6 | D6 | D7 | D8 | D9 | D10 | D11 | D12 | D13 | D14 | D15 | D16 | D17 | D18 | D19 | D20 | D21 | | | | | | | | |
| 5 | | | | | D5 | D6 | D7 | D8 | D9 | D10 | D11 | D12 | D13 | D14 | D15 | D16 | D17 | D18 | D19 | D20 | D21 | D22 | | | | | | | | |
| 6 | | | | | D6 | D7 | D8 | D9 | D10 | D11 | D12 | D13 | D14 | D15 | X | D16 | D17 | D18 | D19 | D20 | D21 | D22 | | | | | | | | |
| 7 | | | | | D7 | D8 | D9 | D10 | D11 | D12 | D13 | D14 | D15 | X | X | D16 | D17 | D18 | D19 | D20 | D21 | D22 | | | | | | | | |
| 8 | | | | | D8 | D9 | D10 | D11 | D12 | D13 | D14 | D15 | D16 | D17 | D18 | D19 | D20 | D21 | D22 | D23 | D24 | D25 | | | | | | | | |
| 9 | | | | | D9 | D10 | D11 | D12 | D13 | D14 | D15 | D16 | D17 | D18 | D19 | D20 | D21 | D22 | D23 | D24 | D25 | D26 | | | | | | | | |
| 10 | | | | | D10 | D11 | D12 | D13 | D14 | D15 | D16 | D17 | D18 | D19 | D20 | D21 | D22 | D23 | D24 | D25 | D26 | D27 | | | | | | | | |
| 11 | | | | | D11 | D12 | D13 | D14 | D15 | D16 | D17 | D18 | D19 | D20 | D21 | D22 | D23 | D24 | D25 | D26 | D27 | D28 | | | | | | | | |
| 12 | | | | | D12 | D13 | D14 | D15 | D16 | D17 | D18 | D19 | D20 | D21 | D22 | D23 | D24 | D25 | D26 | D27 | D28 | D29 | | | | | | | | |
| 13 | | | | | D13 | D14 | D15 | D16 | D17 | D18 | D19 | D20 | D21 | D22 | D23 | D24 | D25 | D26 | D27 | D28 | D29 | D30 | | | | | | | | |
| 14 | | | | | D14 | D15 | D16 | D17 | D18 | D19 | D20 | D21 | D22 | D23 | X | D24 | D25 | D26 | D27 | D28 | D29 | D30 | | | | | | | | |
| 15 | | | | | D15 | D16 | D17 | D18 | D19 | D20 | D21 | D22 | D23 | X | X | D24 | D25 | D26 | D27 | D28 | D29 | D30 | | | | | | | | |
| 16 | | | | | D16 | D17 | D18 | D19 | D20 | D21 | D22 | D23 | D24 | D25 | D26 | D27 | D28 | D29 | D30 | D31 | D32 | D33 | | | | | | | | |
| | — | — | 1 | 2 | ... | 11 | — | — | — | — | — | — | — | — | — | — | — | — | — | — | — | — | — | — | | | | | | |
| Latency Count | | | | | | | | | | | | | | | | | | | | | | | | | | | | | | |

Table 6. First Page Boundary Crossing During Linear Read (Latency Count = 16 Clocks)

| Target Address | Clock Cycle After CS# Goes Low | | | | | | | | | | | | | | | | | | | | | | | | | | | | | | | | | | |
|----------------------|--------------------------------|-----|-----|----------------------------------|-----|-----|-----|-----|-----|-----|-----|-----|-----|-----|-----|-----|-----|-----|-----|-----|-----|-----|-----|-----|--|--|--|--|--|--|--|--|--|--|--|
| | 0 | 1 | 2 | 3 | ... | 17 | 18 | 19 | 20 | 21 | 22 | 23 | 24 | 25 | 26 | 27 | 28 | 29 | 30 | 31 | 32 | 33 | 34 | 35 | | | | | | | | | | | |
| 0 | CA0 | CA1 | CA2 | Bus Turnaround + Initial Latency | | | D0 | D1 | D2 | D3 | D4 | D5 | D6 | D7 | D8 | D9 | D10 | D11 | D12 | D13 | D14 | D15 | D16 | D17 | | | | | | | | | | | |
| 1 | | | | | D1 | D2 | D3 | D4 | D5 | D6 | D7 | D8 | D9 | D10 | D11 | D12 | D13 | D14 | D15 | X | D16 | D17 | | | | | | | | | | | | | |
| 2 | | | | | D2 | D3 | D4 | D5 | D6 | D7 | D8 | D9 | D10 | D11 | D12 | D13 | D14 | D15 | X | X | D16 | D17 | | | | | | | | | | | | | |
| 3 | | | | | D3 | D4 | D5 | D6 | D7 | D8 | D9 | D10 | D11 | D12 | D13 | D14 | D15 | X | X | X | D16 | D17 | | | | | | | | | | | | | |
| 4 | | | | | D4 | D6 | D6 | D7 | D8 | D9 | D10 | D11 | D12 | D13 | D14 | D15 | X | X | X | X | D16 | D17 | | | | | | | | | | | | | |
| 5 | | | | | D5 | D6 | D7 | D8 | D9 | D10 | D11 | D12 | D13 | D14 | D15 | X | X | X | X | X | D16 | D17 | | | | | | | | | | | | | |
| 6 | | | | | D6 | D7 | D8 | D9 | D10 | D11 | D12 | D13 | D14 | D15 | X | X | X | X | X | X | D16 | D17 | | | | | | | | | | | | | |
| 7 | | | | | D7 | D8 | D9 | D10 | D11 | D12 | D13 | D14 | D15 | X | X | X | X | X | X | X | D16 | D17 | | | | | | | | | | | | | |
| 8 | | | | | D8 | D9 | D10 | D11 | D12 | D13 | D14 | D15 | D16 | D17 | D18 | D19 | D20 | D21 | D22 | D23 | D24 | D25 | | | | | | | | | | | | | |
| 9 | | | | | D9 | D10 | D11 | D12 | D13 | D14 | D15 | D16 | D17 | D18 | D19 | D20 | D21 | D22 | D23 | X | D24 | D25 | | | | | | | | | | | | | |
| 10 | | | | | D10 | D11 | D12 | D13 | D14 | D15 | D16 | D17 | D18 | D19 | D20 | D21 | D22 | D23 | X | X | D24 | D25 | | | | | | | | | | | | | |
| 11 | | | | | D11 | D12 | D13 | D14 | D15 | D16 | D17 | D18 | D19 | D20 | D21 | D22 | D23 | X | X | X | D24 | D25 | | | | | | | | | | | | | |
| 12 | | | | | D12 | D13 | D14 | D15 | D16 | D17 | D18 | D19 | D20 | D21 | D22 | D23 | X | X | X | X | D24 | D25 | | | | | | | | | | | | | |
| 13 | | | | | D13 | D14 | D15 | D16 | D17 | D18 | D19 | D20 | D21 | D22 | D23 | X | X | X | X | X | D24 | D25 | | | | | | | | | | | | | |
| 14 | | | | | D14 | D15 | D16 | D17 | D18 | D19 | D20 | D21 | D22 | D23 | X | X | X | X | X | X | D24 | D25 | | | | | | | | | | | | | |
| 15 | | | | | D15 | D16 | D17 | D18 | D19 | D20 | D21 | D22 | D23 | X | X | X | X | X | X | X | D24 | D25 | | | | | | | | | | | | | |
| 16 | | | | | D16 | D17 | D18 | D19 | D20 | D21 | D22 | D23 | D24 | D25 | D26 | D27 | D28 | D29 | D30 | D31 | D32 | D33 | | | | | | | | | | | | | |
| | — | — | 1 | 2 | ... | 16 | — | — | — | — | — | — | — | — | — | — | — | — | — | — | — | — | — | — | | | | | | | | | | | |
| Latency Count | | | | | | | | | | | | | | | | | | | | | | | | | | | | | | | | | | | |

To calculate latency when crossing a page boundary, use the following formula:

```

if ((PS - LTCY) < ADDR & (SP - 1))
{
  ((ADDR & (SP - 1)) - PS + LTCY)
}
else
{0}

```

where:

PS = page size = 16 words

SP = sub-page size = 8 words

LTCY = latency

ADDR = target address

4.3 HyperFlash Read with DCARS Timing

The illustrations and parameters in this section are only those needed to define the DCARS feature and show the relationship between the Phase Shifted Clock, RWDS, and data.

Figure 8. HyperFlash Read DCARS Timing Diagram^[17, 18, 19, 20]



Notes

17. Transactions must be initiated with CK = Low and CK# = High. CS# must return High before a new transaction is initiated.
18. CK# and PSC# are optional and shown as dashed line waveforms.
19. The memory drives RWDS during read transactions.
20. This example demonstrates a latency code setting of four clocks and no additional initial latency required.

4.4 Write Operations

A write operation starts with the first three clock cycles providing the CAx (Command / Address) information indicating the transaction characteristics. The Burst Type bit CA[45] is 'don't care' because the HyperFlash device only supports a single write transaction of 16b or a continuous linear write burst that is only supported when loading data during a Word Program command. Immediately following the CA information the host is able to transfer the write data on the DQ bus. The first byte (A) of data is presented on the rising edge of CK and the second byte (B) is presented on the falling edge of CK. Write data is center aligned with the CK/CK# inputs. Write transfers can be ended at any time by bringing CS# High when CK = Low and CK# = High.

Figure 9. Write Operation^[21, 22, 23]



Figure 10. Write Transaction Usage Example: Erase Operation Command Sequence^[24, 25, 26, 27]



Notes

- 21. Transactions must be initiated with CK = Low and CK# = High. CS# must return High before a new transaction is initiated.
- 22. RWDS will be driven Low as long as CS# is Low.
- 23. Write operations are limited to a transaction of a single word (16b) or a linear write burst supported only when loading data during a Word Program command. This example demonstrates a latency code setting of four clocks and no additional initial latency required.
- 24. See [Figure 16 on page 32](#) for the Erase Operation Command Sequence flowchart.
- 25. Erase operation to the sector starting at 0700000h.
- 26. CK# is not shown but is the complement of the CK signal.
- 27. RWDS is not shown and is not used during Write transactions.

Figure 11. Write Transaction Usage Example: Write Buffer Program Command Sequence^[28, 29, 30, 31]



Figure 12. Status Read Transaction Example^[30]



Notes

- 28. See Figure 14 on page 28 for the Write Buffer Program Operation Command Sequence flowchart.
- 29. Program 2345h into address 45678h, and 9876h into address 45679h.
- 30. CK# is not shown but is the complement of the CK signal.
- 31. RWDS is not shown and is not used during Write transactions.

5. Address Space Maps

Although the HyperBus protocol provides for slave devices that have both memory and register address spaces, HyperFlash memories described in this specification do not differentiate between memory and registers as separate address spaces. There is a single address space selected by any transaction, independent of whether the HyperBus transaction indicates the target location is in memory space or register space of the selected device.

Write transactions always place the transaction address and data into a command register set (buffer).

Read transactions return data from the memory array or from a register address space window that has been temporarily overlaid within the single address space by the execution of commands. The single address range with register space overlays methodology is backward compatible with legacy parallel NOR Flash memory program and erase software drivers.

There are several separate address spaces that may appear within the address range of the flash memory device. One address space is visible (entered) at any given time.

- **Flash Memory Array:** the main non-volatile memory array used for storage of data that may be randomly accessed by read operations.
 - **ID/CFI:** a flash memory array used for Cypress factory programmed device characteristics information. This area contains the Device Identification (ID) and Common Flash Interface (CFI) information tables.
 - **Secure Silicon Region (SSR):** a 1024-byte one-time programmable non-volatile memory array used for Cypress factory programmed permanent data, and customer programmable permanent data.
 - **Persistent Protection Bits (PPB):** a non-volatile memory array with one bit for each Sector. When programmed, each bit protects the related Sector from erasure and programming.
 - **PPB Lock Bit:** a volatile register bit used to enable or disable programming and erase of the PPB bits.
 - **Password:** an OTP non-volatile array used to store a 64-bit password used to enable changing the state of the PPB Lock Bit when using Password Mode Sector Protection.
 - **Dynamic Protection Bits (DYB):** a volatile array with one bit for each Sector. When set, each bit protects the related Sector from erasure and programming.
 - **ECC Status:** read the address of ECC corrected data and total ECC error count.
 - **CRC:** read the CRC Check-value.
 - **Status or Peripheral Registers:** register access used to display Embedded Algorithm status and read or write other registers.
- The Flash Memory Array is the primary and default address space but, it may be overlaid by one other address space, at any one time. Each alternate address space is called an Address Space Overlay (ASO).

Each ASO replaces (overlays) either the sector selected by the command that enters the ASO or the entire flash device address range, depending on the ASO entry command. If only one sector is overlaid by an ASO the remaining sectors of the memory array remain readable. Any address range not defined by a particular ASO address map, is reserved for future use. Unless otherwise stated all read accesses outside of an ASO address map returns non-valid (undefined) data. The locations will display actively driven data but their meaning is not defined.

There are multiple address map modes that determine what appears in the flash device address space at any given time:

- **Read Mode**
- **Status Register (SR) Mode**
- **Address Space Overlay (ASO) Mode**
- **Peripheral Register Mode**

In Read Mode, the entire Flash Memory Array may be directly read by the host system memory controller. The memory device Embedded Algorithm Controller (EAC), puts the device in Read Mode during Power-On, after a Hardware Reset, after a Command Reset, or after an Embedded Algorithm (EA) is suspended. Read accesses and commands are accepted in Read Mode. A subset of commands is accepted in Read Mode when an EA is suspended.

While in any mode, the Status Register read command may be issued to cause the Status Register ASO to appear at every word address in the device address space. In this Status Register ASO Mode, the device interface waits for a read access and, any write access is ignored. The next read access to the device accesses the content of the Status Register, exits the Status Register ASO, and returns to the previous (calling) mode in which the Status Register read command was received.

Similarly, commands that read and write other registers use Peripheral Register Mode, in which the register appears in a temporary ASO that is automatically exited after the read or write of the command selected register. The read or write occurs in the last cycle of the register access command sequence.

In EA Mode the EAC is performing an Embedded Algorithm, such as programming or erasing a non-volatile memory array. While in EA Mode, none of the Flash Memory Array is readable. While in EA Mode, only the Program / Erase Suspend command or the Status Register Read command will be accepted. All other commands are ignored. Thus, no other ASO may be entered from the EA Mode.

In ASO Mode, one of the remaining overlay address spaces is entered (overlaid on the Flash Memory Array address map). Only one ASO may be entered at any one time. Commands to the device affect the currently entered ASO. Only certain commands are valid for each ASO. These are listed in each ASO related section of [Table 40 on page 64](#).

The following ASOs have non-volatile data that may be programmed to change 1s to 0s:

- Secure Silicon Region
- ASP Configuration Register (ASPR)
- Persistent Protection Bits (PPB)
- Password
- Only the PPB ASO has non-volatile data that may be erased to change 0s to 1s.

When a program or erase command is issued while one of the non-volatile ASOs is entered, the EA operates on the ASO. The ASO is not readable while the EA is active. When the EA is completed the ASO remains entered and is again readable. Suspend and Resume commands are ignored during an EA operating on any of these ASOs.

The Peripheral Register Mode is used to manage the Power-On Reset Timer, Interrupt Configuration Register, Interrupt Status Register, Volatile Configuration Register, and the Non-Volatile Configuration Register.

5.1 Flash Memory Array

The S26KL/S26KS family has a uniform sector architecture with a sector size of 256 KB. The following tables show the sector architecture of the devices.

A user configuration option is available to overlay either the first sector (SA00) or last sector (SAmax) with eight 4-KB Parameter-Sectors. The Parameter-Sector address map showing how the lowest or highest sector is partitioned is shown in the following memory address map tables. The Parameter-Sectors can be erased and programmed in the normal manner using the standard erase and program command sequences targeting the appropriate Parameter-Sector addresses. Note that the smaller Parameter-Sectors need to include A[16:11] as part of the address identifying the target Parameter-Sector during erase and program command sequences. Configuring the first or last uniform sector to include the parameter sectors is accomplished with the Non-Volatile Configuration Register.

Note The following tables have been condensed to show sector related information for an entire device on a single page. Sectors and their address ranges that are not explicitly listed (such as SA001 – SA510) have sector starting and ending addresses that form the same pattern as all other sectors of that size. For example, all 256-KB sectors have the pattern XX00000h – XX1FFFFh.

Table 7. S26KL512S and S26KS512S Sector and Memory Address Map

| Sector Size (KB) | Sector Count | Sector Range | Address Range (16-bit) | Notes |
|------------------|--------------|--------------|------------------------|-------------------------|
| 256 | 256 | SA00 | 0000000h – 001FFFFh | Sector Starting Address |
| | | : | : | – |
| | | SA255 | 1FE0000h – 1FFFFFFh | Sector Ending Address |

Table 8. S26KL256S and S26KS256S Sector and Memory Address Map

| Sector Size (KB) | Sector Count | Sector Range | Address Range (16-bit) | Notes |
|------------------|--------------|--------------|------------------------|-------------------------|
| 256 | 128 | SA00 | 0000000h – 001FFFFh | Sector Starting Address |
| | | : | : | – |
| | | SA127 | 0FE0000h – 0FFFFFFh | Sector Ending Address |

Table 9. S26KL128S and S26KS128S Sector and Memory Address Map

| Sector Size (KB) | Sector Count | Sector Range | Address Range (16-bit) | Notes |
|------------------|--------------|--------------|------------------------|-------------------------|
| 256 | 64 | SA00 | 0000000h – 001FFFFh | Sector Starting Address |
| | | : | : | – |
| | | SA63 | 07E0000h – 07FFFFFFh | Sector Ending Address |

Table 10. Main Array Sector 0 Overlaid with Eight 4-KB Parameter-Sectors

| Main Array Sector Size | Parameter-Sector Number | Address Size | Address Range (16-bit) | Notes |
|------------------------|--|--------------|------------------------|--|
| 256 KB | 0 | 4 KB | 0000000h – 00007FFh | Start of Parameter-Sector 0 |
| | 1 | 4 KB | 0000800h – 0000FFFh | Parameter-Sector 1 |
| | 2 | 4 KB | 0001000h – 00017FFh | Parameter-Sector 2 |
| | 3 | 4 KB | 0001800h – 0001FFFh | Parameter-Sector 3 |
| | 4 | 4 KB | 0002000h – 00027FFh | Parameter-Sector 4 |
| | 5 | 4 KB | 0002800h – 0002FFFh | Parameter-Sector 5 |
| | 6 | 4 KB | 0003000h – 00037FFh | Parameter-Sector 6 |
| | 7 | 4 KB | 0003800h – 0003FFFh | End of Parameter-Sector 7 |
| | Exposed Portion of Main Array Sector 0 | 224 KB | 0004000h – 001FFFFh | Mapped to exposed portion of Main Array Sector 0 |

Table 11. Last Sector Overlaid with Eight 4-KB Parameter-Sectors

| Main Array Sector Size | Parameter-Sector Number | Address Size | Address Range (16-bit) | Notes |
|------------------------|--|--------------|------------------------|---|
| 256 KB | Exposed portion of last sector in main array | 224 KB | xx00000h – xx1BFFFh | Mapped to exposed portion of Main Array Sector (last) |
| | 0 | 4 KB | xx1C000h – xx1C7FFh | Start of Parameter-Sector 0 |
| | 1 | 4 KB | xx1C800h – xx1CFFFh | Parameter-Sector 1 |
| | 2 | 4 KB | xx1D000h – xx1D7FFh | Parameter-Sector 2 |
| | 3 | 4 KB | xx1D800h – xx1DFFFh | Parameter-Sector 3 |
| | 4 | 4 KB | xx1E000h – xx1E7FFh | Parameter-Sector 4 |
| | 5 | 4 KB | xx1E800h – xx1EFFFh | Parameter-Sector 5 |
| | 6 | 4 KB | xx1F000h – xx1F7FFh | Parameter-Sector 6 |
| | 7 | 4 KB | xx1F800h – xx1FFFFh | End of Parameter-Sector 7 |

5.2 Device ID and CFI (ID-CFI) ASO

There are two traditional methods for systems to identify the type of flash memory installed in the system. One is Device Identification (ID). The other method is called Common Flash Interface (CFI).

For ID, a command is used to enable an address space overlay where up to 16 word locations can be read to get JEDEC manufacturer identification (ID), device ID, and some configuration and protection status information from the flash memory. The system can use the manufacturer and device IDs to select the appropriate driver software to use with the flash device.

CFI also uses a command to enable an Address Space Overlay where an extendable table of standard information about how the flash memory is organized and operates can be read. With this method the driver software does not have to be written with the specifics of each possible memory device in mind. Instead the driver software is written in a more general way to handle many different devices but adjusts the driver behavior based on the information in the CFI table.

Traditionally these two address spaces have used separate commands and were separate overlays. However, the mapping of these two address spaces are non-overlapping and so can be combined in to a single address space and appear together in a single overlay. Either of the traditional commands used to access (enter) the Autoselect (ID) or CFI overlay will cause the now combined ID-CFI address map to appear.

The ID-CFI address map appears within, and overlays the Flash Memory Array data of the sector selected by the address used in the ID-CFI enter command. While the ID-CFI ASO is entered the content of all other sectors is undefined.

The ID-CFI address map starts at location zero of the selected sector. Locations above the maximum defined address of the ID-CFI ASO to the maximum address of the selected sector have undefined data. The ID-CFI enter commands use the same address and data values used on previous generation memories to access the JEDEC Manufacturer ID (Autoselect) and Common Flash Interface (CFI) information, respectively.

Table 12. ID-CFI Address Map Overview

| Word Address | Description | Read / Write |
|-----------------------|---|--------------|
| (SA) + 0000h to 000Fh | Device ID (traditional Autoselect values) | Read Only |
| (SA) + 0010h to 0079h | CFI data structure | Read Only |
| (SA) + 007Ah to 00FFh | Undefined | Read Only |

For the complete address map, see [Table 34 on page 58](#).

5.2.1 Device ID

The JEDEC standard JEP106T defines the manufacturer ID for a compliant memory. Common industry usage defined a method and format for reading the manufacturer ID and a device specific ID from a memory device. The manufacturer and device ID information is primarily intended for programming equipment to automatically match a device with the corresponding programming algorithm. Cypress has added additional fields within this 32-byte address space.

The original industry format was structured to work with any memory data bus width (for example: x8, x16, x32). The ID code values are traditionally byte wide but are located at bus width address boundaries such that incrementing the device address inputs will read successive byte, word, or double word locations with the ID codes always located in the least significant byte location of the data bus. Because the device data bus is word wide, each code byte is located in the lower half of each word location. The original industry format made the high order byte always zero. Cypress has modified the format to use both bytes in some words of the address space. For the detail description of the Device ID address map, see [Table 34](#).

5.2.2 Common Flash Memory Interface

The JEDEC CFI specification (JESD68.01) defines a standardized data structure that may be read from a flash memory device, which allows vendor-specified software algorithms to be used for entire families of devices. The data structure contains information for system configuration such as various electrical and timing parameters, and special functions supported by the device. Software support can then be device-independent, Device ID-independent, and forward-and-backward-compatible for entire flash device families.

The system can read CFI information at the addresses within the selected sector as shown in [Section 7. Device ID and Common Flash Interface \(ID-CFI\) ASO Map](#) on page 58.

Similar to the Device ID information, CFI information is structured to work with any memory data bus width (for example: x8, x16, x32). The code values are always byte wide but are located at data bus width address boundaries such that incrementing the device address reads successive byte, word, or double word locations with the codes always located in the least significant byte location of the data bus. Because the data bus is word wide, each code byte is located in the lower half of each word location and the high order byte is always zero.

For further information, refer to the *CFI Specification, Version 1.5* (or later), and the *JEDEC publications JEP137-A and JESD68.01*.

6. Embedded Operations

6.1 Embedded Algorithm Controller (EAC)

The EAC takes commands from the host system for programming and erasing the flash memory arrays and performs all the complex operations needed to change the non-volatile memory state. This frees the host system from any need to manage the program and erase processes.

There are five EAC operation categories:

- Deep Power-Down (DPD)
- Standby (Read Mode)
- Address Space Switching
- Embedded Algorithms (EA)
- Advanced Sector Protection (ASP) Management

6.1.1 Deep Power-Down

In the Deep Power-Down (DPD) Mode, current consumption is driven to the lowest level. The DPD Mode must be entered while the device is in the Standby state while not in an ASO.

6.1.2 EAC Standby

In the Standby state, current consumption is greatly reduced. The EAC enters its Standby state when no command is being processed and no Embedded Algorithm is in progress. If the device is deselected ($CS\# = \text{High}$) during an Embedded Algorithm, the device still draws active current until the operation is completed (I_{CC3}). I_{CC4} in [Section 10.5 DC Characteristics \(CMOS Compatible\) on page 74](#) represents the standby current specification when both the Host Interface and EAC are in their Standby state.

6.1.3 Address Space Switching

Writing specific address and data sequences (command sequences) switch the memory device address space from the Flash Memory Array to one of the Address Space Overlays (ASO).

Embedded Algorithms operate on the information visible in the currently active (entered) ASO. The system continues to have access to the ASO until the system issues an ASO Exit command, performs a Hardware Reset, or until power is removed from the device. An ASO Exit Command switches from an ASO back to the Flash Memory Array address space. The commands accepted when a particular ASO is entered are listed between the ASO Enter and Exit commands in the command definitions table. See [Section 8.1 Command Summary on page 64](#) for address and data requirements for all command sequences.

6.1.4 Embedded Algorithms (EA)

Changing the non-volatile data in the memory array requires a complex sequence of operations that are called Embedded Algorithms (EA). The algorithms are managed entirely by the device's internal Embedded Algorithm Controller (EAC). The main algorithms perform programming and erase of the Main Array Data and the ASOs. The host system writes command codes to the flash device address space. The EAC receives the commands, performs all the necessary steps to complete the command, and provides status information during the progress of an EA.

6.2 Program and Erase Summary

Flash data bits are erased in parallel in a large group called a sector. The erase operation places each data bit in the sector in the logical 1 state (High). Flash data bits may be individually programmed from the erased 1 state to the programmed logical 0 (low) state. A data bit of 0 cannot be programmed back to a 1. A succeeding read shows that the data is still 0. Only erase operations can convert a 0 to a 1. Programming the same word location more than once with different 0 bits will result in the logical AND of the previous data and the new data being programmed.

The duration of program and erase operations is shown in [Section 12. Embedded Algorithm Performance](#) on page 89.

Program and erase operations may be suspended.

- An erase operation may be suspended to allow either programming or reading of another sector (not in the erase sector) in the erase operation. No other erase operation can be started during an erase suspend.
- A program operation may be suspended to allow reading of another location (not in the Line being programmed).
- No other program or erase operation may be started during a suspended program operation; program or erase commands will be ignored during a suspended program operation.
- After an intervening program operation or read access is complete the suspended erase or program operation may be resumed.
- Program and Erase operations may be interrupted as often as necessary but in order for a program or erase operation to progress to completion there must be some periods of time between resume and the next suspend commands greater than or equal to t_{PRS} or t_{ERS} in [Section 12. Embedded Algorithm Performance](#) on page 89.
- When an Embedded Algorithm (EA) is complete, the EAC returns to the operation state and address space from which the EA was started (Erase Suspend or EAC Standby).

The system can determine the status of a program or erase operation by reading the Status Register ([Section 6.2.14 Error Types and Clearing Procedures](#) on page 44).

Any commands written to the device during the Embedded Program Algorithm are ignored except the Program Suspend, and Status Read command.

Any commands written to the device during the Embedded Erase Algorithm are ignored except Erase Suspend and Status Read command.

A Hardware Reset immediately terminates any in progress program / erase operation and returns to Read Mode after t_{RPH} time. The terminated operation should be reinitiated once the device has returned to the Standby state, to ensure data integrity.

For performance and reliability reasons programming is internally done on 16-byte half-pages, using an aligned 16-byte address range.

I_{CC3} in [Section 10.5 DC Characteristics \(CMOS Compatible\)](#) on page 74 represents the active current specification for a write (Embedded Algorithm) operation.

6.2.1 Program Granularity

The S26KL/S26KS supports two methods of programming, Word or Write Buffer Programming.

Word programming examines the data word supplied by the command and programs 0's in the addressed memory array word to match the 0's in the command data word.

Write Buffer Programming examines the write buffer and programs 0's in the addressed memory array Line to match the 0's in the write buffer. The write buffer does not need to be completely filled with data. It is allowed to program as little as a single bit, several bits, a single word, a few words, a half-page, multiple half-pages, or the entire buffer as one programming operation. Use of the write buffer method reduces host system overhead in writing program commands and reduces memory device internal overhead in programming operations to make Write Buffer Programming more efficient and thus faster than programming individual words with the Word Programming command.

Each half-page can be programmed by either method. Half-pages programmed by different methods may be mixed within a Line.

Word Programming and Write Buffer Programming, more than once within a half-page, is supported for legacy software compatibility. However, using Word Programming or Write Buffer Programming more than once within a half-page without an erase will disable the device's ECC functionality for that half-page. For applications requiring multiple programming operations within the same half-page, it is recommended to add system software Error Detection and Correction, to enhance the data integrity of half-pages.

Note If 2-bit ECC is enabled, multiple Word Programming or Write Buffer Programming within the same page will result in a Program Error.

Future silicon process generations of HyperFlash may no longer support multiple program operations, within the same half-page, without an erase operation on the sector containing the half-page. Planning for software migration to future generations should adopt data structures and data management methods that can support only one programming operation, per half-page, per erase.

6.2.2 Incremental Programming

The same word location or half-page may be programmed more than once, by either the Word or Write Buffer Programming methods, to incrementally change 1's to 0's. However as noted in [Section 6.2.1 Program Granularity](#) on page 24 incremental programming affects ECC syndrome bits and causes the device to disable ECC for that half-page.

Note If 2-bit ECC is enabled, multiple Word Programming or Write Buffer Programming within the same page will result in a Program Error.

6.2.3 Program Methods

6.2.3.1 Word Programming

Word programming is used to program a single word or a group of words anywhere in the flash memory arrays.

The minimum Word Programming command sequence requires four command write transactions. The program command sequence is initiated by issuing two unlock command write transactions (transactions one and two), followed by the program set-up command (transaction three). The program address and data are written next (transaction four), which in turn initiates the Embedded Programming algorithm. The system is not required to provide further controls or timing. The device automatically generates the program pulses and verifies the programmed cell margin internally. When the Embedded Programming algorithm is complete, the EAC then returns to its Standby State.

The four transaction Word Programming command sequence described earlier is used to program a single (16-bit) word (two bytes). Multiple sequential words can be programmed with the Word Programming sequence by using the burst write capability. The unlock and program command sequence is identical to a single Word Programming sequence but during the data / address transaction multiple sequential data values are loaded during a single assertion of CS#. The data presented is programmed into sequential addresses starting with the target address identified in the Command-Address phase of the burst write transaction. A maximum of 256 words (512 bytes) can be programmed as long as an aligned 256-word (512-byte) address boundary is not crossed.

The system can determine the status of the program operation by reading the Status Register. Refer to [Section 6.2.14 Error Types and Clearing Procedures](#) on page 44.

Any commands other than Program Suspend and Status Register Read written to the device during the Embedded Program algorithm are ignored.

Note that a Hardware Reset (RESET# = V_{IL}) or power loss immediately terminates the programming operation and returns the device to Read Mode after t_{RPH} time. The termination may leave the area being programmed in an intermediate state with invalid or unstable data values. Once the device has completed the Hardware Reset operation, the program command sequence may be reinitiated with the same data to complete the programming operation, to ensure the data is fully programmed. However, to ensure the best data integrity, the sector in which the program operation was terminated must be erased and re-programmed.

The Word Programming command may also be used when the SSR ASO is entered.

A modified version of the Word Programming command, without unlock write cycles, is used for programming when entered into the ASP Configuration Register (ASPR), Password, and PPB ASOs. The same command is used to change volatile bits when entered in to the PPB Lock, and DYB ASOs. See [Table 40](#) on page 64 for Program Command sequences.

Figure 13. Word Program Operation



6.2.3.2 Write Buffer Programming

A write buffer is used to program data within a 512-byte address range aligned on a 512-byte boundary (Line). Thus, a full Write Buffer Programming operation must be aligned on a Line boundary. Programming operations of less than a full 512 bytes may start on any word boundary but may not cross a Line boundary. At the start of a Write Buffer Programming operation all bit locations in the buffer are all 1's (FFFFh words) thus any locations not loaded will retain the existing data. See [Table 1 on page 5](#) for information on address map.

Write Buffer Programming allows up to 512 bytes to be programmed in one operation. It is possible to program from 1 bit up to 512 bytes in each Write Buffer Programming operation. It is strongly recommended that a multiple of 16-byte half-pages be written and each half-page written only once. For the very best performance, programming should be done in full Lines of 512 bytes aligned on 512-byte boundaries.

Write Buffer Programming is supported only in the Flash Memory Array or the SSR ASO.

The Write Buffer Programming operation is initiated by first writing two unlock cycles. This is followed by a third write cycle of the Write to Buffer command with the Sector Address (SA), in which programming is to occur. Next, the system writes the number of word locations minus one. This tells the device how many write buffer addresses will be loaded with data and therefore when to expect the Program Buffer to flash confirm command. The Sector Address provided in both the Write to Buffer command and the Write Word Count command must match. The Sector to be programmed must be unlocked (unprotected). If a programming operation is attempted to a locked sector, the operation will be aborted and the failure will be indicated in the Status Register (see [Table 17 on page 35](#)).

The system then writes the starting address and data word. This starting address is the first address and data pair to be programmed, and selects the starting word address within the write buffer Line. The Sector Address must match the Write to Buffer command Sector Address or the operation will abort and return to the initiating state. All subsequent single word address and data pair write transactions must be in sequential order. All write buffer addresses must be within the same Line. If the system attempts to load data outside this range, the operation will abort and return to the initiating state.

The word counter decrements for each data word loaded. Note that while counting down the data writes, every write is considered to be data being loaded into the write buffer. No commands are possible during the write buffer loading period. The only way to stop loading the write buffer is to write with an address that is outside the Line of the programming operation. This invalid address will immediately abort the Write to Buffer command sequence and set the Write Buffer Abort Status Bit (SR[3]).

Once the specified number of write buffer locations has been loaded, the system must then write the Program Buffer to Flash command at the Sector Address. The device then goes busy. The Embedded Program algorithm automatically programs and verifies the data for the correct data pattern. The system is not required to provide any controls or timings during these operations. If an incorrect number of write buffer locations have been loaded the operation will abort and return to the initiating state. The abort occurs as well when anything other than the Program Buffer to Flash is written when that command is expected at the end of the word count number of data words.

The Write-Buffer Embedded Programming operation can be suspended using the Program Suspend command. When the Embedded Program algorithm is complete, the EAC then returns to the EAC Standby or Erase Suspend Standby state where the programming operation was started.

The system can determine the status of the program operation by using the Status Register (see [Table 17 on page 35](#)). See [Figure 14 on page 28](#) for a diagram of the programming operation.

The Write Buffer Programming Sequence will be Aborted under the following conditions:

- Load a Word Count value greater than the buffer size (255).
- Write an address that is outside the Line provided in the Write to Buffer command.
- The Program Buffer to Flash command is not issued after the Write Word Count number of data words is loaded.

When any of the conditions that cause an abort of write buffer command occur the abort will happen immediately after the offending condition, and will indicate a Program Fail in the Status Register at bit location 4 (PSB = 1) due to Write Buffer Abort bit location 3 (WBASB = 1). The next successful program operation will clear the failure status or a Clear Status Register may be issued to clear the PSB status bit.

The Write Buffer Programming sequence can be terminated by the following: Hardware Reset or Power cycle. However, using either of these methods may leave the area being programmed in an intermediate state with invalid or unstable data values. In this case the same area will need to be reprogrammed with the same data or erased to ensure data values are properly programmed or erased. To ensure the best data integrity, the sector in which the program operation was terminated must be erased and re-programmed.

Figure 14. Write Buffer Programming Operation with Status Register^[32, 33]

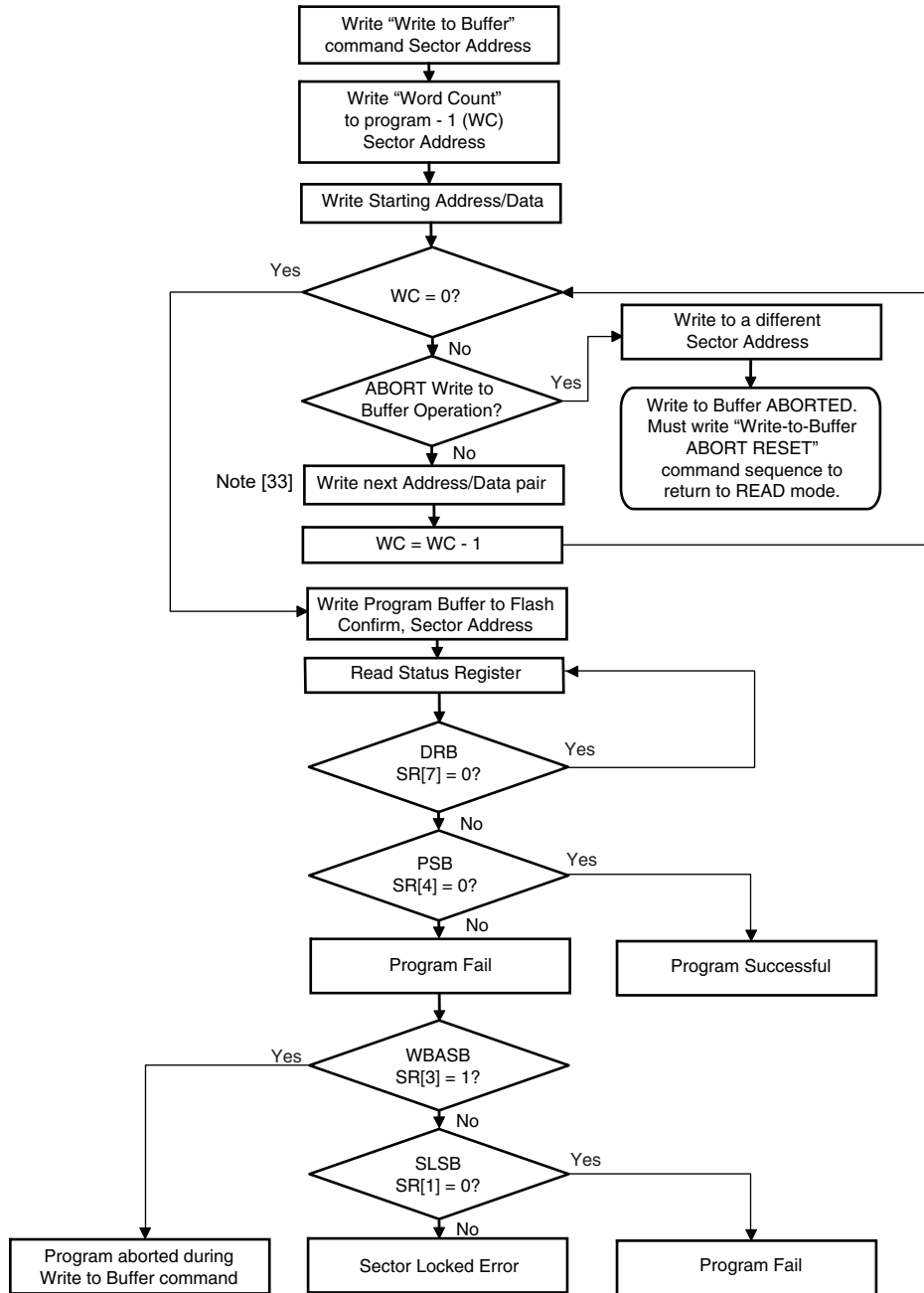

Notes

32. See Table 40 on page 64 for the command sequence as required for Write Buffer Programming.

33. When the Sector Address is specified, any address in the selected sector is acceptable. However, when loading Write-Buffer address locations with data, all addresses MUST fall within the selected Line.

Table 13. Write Buffer Programming Command Sequence

| Sequence | Address | Data | Comment |
|---|------------------|-------|--|
| Issue Unlock Command 1 | 555h | AAh | |
| Issue Unlock Command 2 | 2AAh | 55h | |
| Issue Write to Buffer Command at Sector Address | SA | 0025h | |
| Issue Number of Locations at Sector Address | SA | WC | WC = number of words to program minus 1. |
| Example: WC of 0 = 1 word to program WC of 1 = 2 words to program | | | |
| Load Starting Address / Data pair | Starting Address | PD | Selects a Line and loads first Address / Data Pair. |
| Load next Address / Data pair | WBL | PD | All addresses must be within the selected Line boundaries, and have to be loaded in sequential order. |
| Load LAST Address / Data pair | WBL | PD | All addresses must be within the selected Line boundaries, and have to be loaded in sequential order. |
| Issue Write Buffer Program Confirm at Sector Address | SA | 0029h | This command must follow the last write buffer location loaded, or the operation will ABORT. |
| Device goes busy | | | |

Legend:

SA = Sector Address (Non-Sector Address bits are 'don't care'. Any address within the Sector is sufficient.)
 WBL = Write Buffer Location (MUST be within the boundaries of the Line specified by the Starting Address.)
 WC = Word Count
 PD = Program Data

6.2.4 Program Suspend / Program Resume Commands

The Program Suspend command allows the system to interrupt an embedded programming operation so that data can be read from any non-suspended Line. When the Program Suspend command is written during a programming process, the device halts the programming operation within t_{PSL} (program suspend latency) and updates the status bits. Addresses are 'don't care' when writing the Program Suspend command.

After the programming operation has been suspended, the system can read array data from any non-suspended Line. The Program Suspend command may also be issued during a programming operation while an erase is suspended. In this case, data may be read from any addresses not in Erase Suspend or Program Suspend.

After the Program Resume command is written, the device reverts to programming and the status bits are updated. The system can determine the status of the program operation by reading the Status Register. Refer to [Section 6.2.14 Error Types and Clearing Procedures on page 44](#) for information on these status bits.

Accesses and commands that are valid during Program Suspend are:

- Read to any other non-erase-suspended sector
- Read to any other non-program-suspended Line
- Status Read command
- Exit ASO or Command Set Exit
- Program Resume command
- Load Interrupt Configuration Register
- Load Interrupt Status Register

The system must write the Program Resume command to exit the Program Suspend Mode and continue the programming operation. Further writes of the Program Resume command are ignored. Another Program Suspend command can be written after the device has resumed programming.

Program operations can be interrupted as often as necessary but in order for a program operation to progress to completion there must be some periods of time between resume and the next suspend command greater than or equal to t_{PRS} in [Section 6.1 Embedded Algorithm Controller \(EAC\)](#) on page 23.

Program suspend and resume is not supported while entered in an ASO. While in program suspend entry into ASO is not supported.

6.2.5 Blank Check

The Blank Check command will confirm if the selected Flash Memory Array sector is fully erased. The Blank Check command does not allow for reads to the array during the Blank Check. Reads to the array while this command is executing will return unknown data.

To initiate a Blank Check on a sector, write 33h to address 555h in the sector, while the EAC is in the Standby state.

The Blank Check command may not be written while the device is actively programming or erasing or suspended.

Use the Status Register read to confirm if the device is still busy and when complete if the sector is blank or not. Bit 7 of the Status Register will show if the device is performing a Blank Check (similar to an erase operation). Bit 5 of the Status Register will be cleared to 0 if the sector is erased and set to 1 if not erased.

As soon as any bit is found to not be erased, the device will halt the operation and report the results.

Once the Blank Check is completed, the EAC will return to the Standby state.

6.2.6 Evaluate Erase Status

The Evaluate Erase Status (EES) command verifies that the last erase operation on the addressed sector was completed successfully. If the selected sector was successfully erased the Sector Erase Status Bit in the Status Register (SR[0]) is set to 1. If the selected sector was not completely erased SR[0] is cleared to 0. See [Figure 15 on page 30](#) for details.

The EES command can be used to detect erase operations that failed due to loss of power, reset, or failure during an erase operation.

The EES command requires t_{EES} to complete and updates the Sector Erase Status Bit in the Status Register (SR[0]). The Device Ready Bit in the Status Register (SR[7]) may be read using the Read Status Register (70h) command to determine when the EES command has finished. Once the Device Ready Bit in the Status Register indicates that the device has returned to the Ready (1) state the Sector Erase Status Bit (SR[0]) indicates whether the target sector was successfully erased. If a sector is found not erased with SR[0] = 0, the sector must be erased again to ensure reliable storage of data in the sector.

The Sector Erase Count (SEC) function provides the capability to read the number of times each sector has been erased. The SEC command outputs the number of successful erase cycles for the addressed sector. The Sector address can start at any sector location of the memory array and the SEC command shifts out the count. The count consists of 24 bits (3 bytes) of data where count bits 22:0 contain the erase count giving a maximum of 8 million cycles. Count bit 23 is a flag indicating whether SEC has been reset in the past or not. A '1' indicates a Power Loss event during Erase resulting in the counter reset.

Figure 15. Evaluate Erase Status Software Sequence

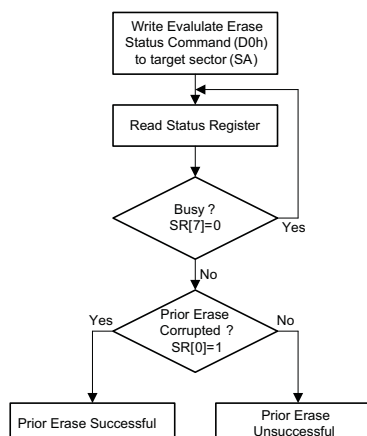

6.2.7 Erase Methods

6.2.7.1 Chip Erase

The Chip Erase function erases the entire Flash Memory Array. The device does not require the system to preprogram prior to erase. The Embedded Erase Algorithm automatically programs and verifies the entire memory for an all 0 data pattern prior to electrical erase. After a successful Chip Erase, all locations within the device contain FFFFh. The system is not required to provide any controls or timings during these operations. The Chip Erase command sequence is initiated by writing two unlock cycles, followed by a set-up command. Two additional unlock write cycles are then followed by the Chip Erase command, which in turn invokes the Embedded Erase Algorithm.

When the Embedded Erase Algorithm is complete, the EAC returns to the Standby state. Note that while the Embedded Erase operation is in progress, the system cannot read valid data from the array. The system can determine the status of the erase operation by reading the Status Register. Refer to [Section 6.2.14 Error Types and Clearing Procedures on page 44](#) for information on these status bits. Once the Chip Erase operation has begun, only a Status Read, Hardware Reset, or Power cycle are valid. All other commands are ignored. However, a Hardware Reset or Power Cycle immediately terminates the erase operation and returns to Read Mode after t_{RPH} time. If a chip erase operation is terminated, the Chip Erase command sequence must be reinitiated once the device has returned to the Standby state to ensure data integrity.

Sectors protected by the ASP DYB and PPB bits will not be erased. See [Section 8. Software Interface Reference on page 64](#). If a sector is protected during Chip Erase, Chip Erase will skip the protected sector and continue with next sector erase. The Status Register Erase Status Bit and Sector Lock Bit are not set to 1 by a failed erase on a protected sector.

6.2.7.2 Sector Erase

The Sector Erase function erases one sector in the memory array. The device does not require the system to preprogram prior to erase. The Embedded Erase Algorithm automatically programs and verifies the entire sector for an all 0 data pattern prior to electrical erase. After a successful sector erase, all locations within the erased sector contain FFFFh. The system is not required to provide any controls or timings during these operations. The Sector Erase command sequence is initiated by writing two unlock cycles, followed by a set-up command. Two additional unlock write cycles are then followed by the address of the sector to be erased, and the Sector Erase command.

The system can determine the status of the erase operation by reading the Status Register. Refer to [Section 6.2.14 Error Types and Clearing Procedures on page 44](#) for information on these status bits.

Once the sector erase operation has begun, the Status Register Read and Erase Suspend commands are valid. All other commands are ignored by the Embedded Algorithm Controller. However, note that a Hardware Reset immediately terminates the erase operation and returns to Read Mode after t_{RPH} time. If a sector erase operation is terminated, the Sector Erase command sequence must be reinitiated once the device has reset operation to ensure data integrity.

See [Section 6.1 Embedded Algorithm Controller \(EAC\) on page 23](#) for parameters and timing diagrams.

Sectors protected by the ASP DYB and PPB bits will not be erased. See [Section 8. Software Interface Reference on page 64](#). If an erase operation is attempted to a locked sector the operation will be aborted and the failure will be indicated in the Status Register (see [Table 17 on page 35](#)).

Figure 16. Sector Erase Operation

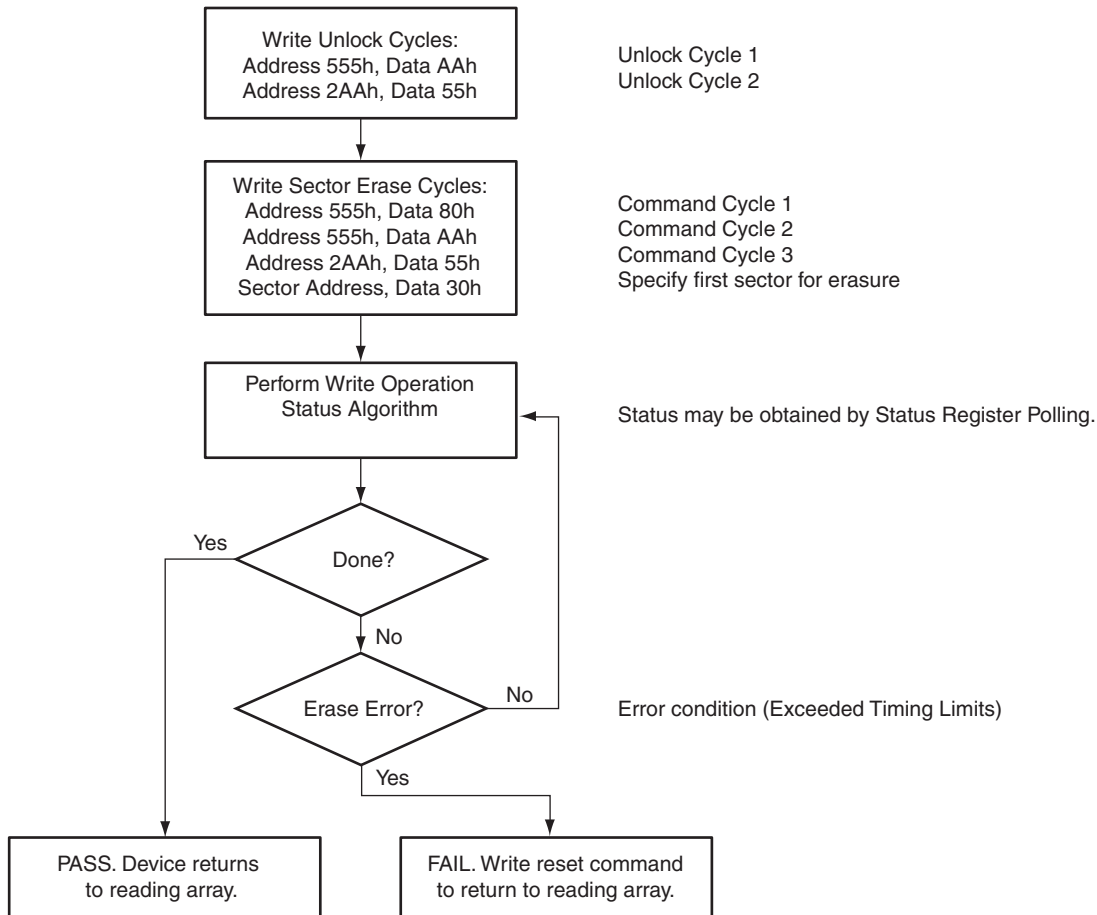

6.2.8 Erase Suspend / Erase Resume

The Erase Suspend command allows the system to interrupt a sector erase operation and then read data from, or program data to, the Flash Memory Array. This command is valid only during sector erase or program operation. The Erase Suspend command is ignored if written during the chip erase operation.

When the Erase Suspend command is written during the sector erase operation, the device requires a maximum of t_{ESL} (erase suspend latency) to suspend the erase operation and update the status bits.

After the erase operation has been suspended, the part enters the Erase-Suspend Mode. The system can read data from or program data to the Flash Memory Array. Reading at any address within erase-suspended sectors produces undetermined data. The system can determine if a sector is actively erasing or is erase-suspended by reading the Status Register. Refer to [Section 6.2.14 Error Types and Clearing Procedures](#) on page 44 for information on these status bits.

After an erase-suspended program operation is complete, the EAC returns to the Erase-Suspend state. The system can determine the status of the program operation by reading the Status Register, just as in the standard program operation.

If a program failure occurs during erase suspend the Status Register Clear or Software Reset commands will return the device to the erase suspended state. Erase will need to be resumed and completed before again trying to program the memory array.

Accesses and commands that are valid during Erase Suspend are:

- Read to any other non-suspended sector
- Program to any other non-suspended sector
- Status Read command
- Exit ASO or Command Set Exit
- Erase Resume command
- SSR Entry
- SSR Read
- SSR Program

To resume the sector erase operation, the system must write the Erase Resume command. The device will revert to erasing and the status bits will be updated. Further writes of the Resume command are ignored. Another Erase Suspend command can be written after the chip has resumed erasing.

Note that the DYB ASO can not be entered while the device is in the Erase Suspend state.

6.2.9 Volatile and Non-Volatile Register Summary

6.2.9.1 Non-Volatile Configuration Registers

Table 14. Non-Volatile Configuration Registers

| Symbol | Name | Width (bits) | NV Type | Default Value | Reference |
|---------|-------------------------------------|------------------|---------|-------------------------|---|
| NVCR | Non-Volatile Configuration Register | 16 | P/E | 8EBBh | Section 6.2.12 Non-Volatile Configuration Register and Volatile Configuration Register on page 36 |
| PASS | Password Protection Register | 64 | OTP | FFFF FFFF FFFF FFFFh | Section 6.3.9 Password Protection Mode on page 53 |
| PPB | Persistent Protection Bits | 1-bit per sector | P/E | 1 | Section 6.3.4 Persistent Protection Bits (PPB) on page 51 |
| ASPR | ASP Configuration Register | 16 | OTP | FEFFh | Section 6.3.7 ASP Configuration Register on page 52 |
| PORTime | Power-On Reset Time | 16 | OTP | FFFFh | Section 10.6.1 Power-On (Cold) Reset (POR) on page 78 |

6.2.9.2 Volatile Configuration Registers

Table 15. Volatile Configuration Registers

| Symbol | Name | Width (bits) | Default Value | Reference |
|--------|-----------------------------------|------------------|---------------|---|
| VCR | Volatile Configuration Register 0 | 16 | NVCR | Section 6.2.12 Non-Volatile Configuration Register and Volatile Configuration Register on page 36 |
| DYB | Dynamic Protection Bits | 1-bit per sector | 1 | Section 6.3.5 Dynamic Protection Bits (DYB) on page 51 |
| PPBL | PPB Lock Bit | 1 | ASPR[2] | Section 6.3.3 PPB Lock on page 51 |
| ICR | Interrupt Configuration Register | 16 | FFFFh | Section 6.3.12 INT# Output on page 56 |
| CRCS | CRC Start Address Register | 26 (1 Gb) | 3FFFFFFh | Section 1.2.2.1 CRC Check-Value Calculation on page 7 |
| CRCE | CRC End Address Register | 26 (1 Gb) | 3FFFFFFh | Section 1.2.2.1 CRC Check-Value Calculation on page 7 |

6.2.10 Volatile Results and Status Registers

Table 16. Volatile Results and Status Registers

| Name | Width (bits) | Default Value | Reference |
|---------------------------------------|------------------|---------------|--|
| Sector Lock Status | 3-bit per sector | NA | See (Note 85) for Table 40 on page 64. |
| Status Register | 16 | xx80h | Table 17 on page 35 |
| Interrupt Status Register | 16 | FFFBh | Table 33 on page 57 |
| ECC Status Register | 16 | NA | |
| Error Lower Address Trap Register | 16 | NA | Table 40 on page 64 |
| Error Upper Address Trap Register | 16 | NA | Table 40 on page 64 |
| Read Check-value Low Result Register | 16 | NA | Section 6.2.12.1 CRC Value Register on page 41 |
| Read Check-value High Result Register | 16 | NA | Section 6.2.12.1 CRC Value Register on page 41 |

6.2.11 Status and Configuration Register Definitions

6.2.11.1 Status Register Mode

The status of Embedded Algorithms is provided by a single 16-bit Status Register. The Status Register Read command is issued followed by one read access of the Status Register information. The contents of the Status Register is aliased (overlaid) in all locations of the device address space. The overlay is in effect for one read access, specifically the next read access that follows the Status Register Read command. After the one Status Register access, the Status Register ASO is exited.

The Status Register contains bits related to the results — success or failure — of the most recently initiated Embedded Algorithms (EA):

- Erase Status (bit 5),
- Program Status (bit 4),
- Write Buffer Abort (bit 3),
- Sector Locked Status (bit 1),
- Sector Erase Status Bit (bit 0).

and, bits related to the current state of any in process EA:

- Device Busy (bit 7),
- Erase Suspended (bit 6),
- Program Suspended (bit 2),
- CRC Calculation Suspended (bit 8)

The current state bits indicate whether an EA is in process, suspended, or completed.

The upper 7 bits (bits 15:9) are reserved. These have an undefined High or Low value that can change from one status read to another. These bits should be treated as 'don't care' and ignored by any software reading status.

The Clear Status Register command and the Software Reset command will clear to 0 the results related bits of the Status Register (bits 5, 4, 3, 1, and 0) but will not affect the current state bits.

Table 17. Status Register

| Bit Number | Bit Description | Bit Name | Reset Status | Busy Status | Ready Status |
|------------|-------------------------------|----------|--------------|-------------|---|
| [15:9] | Reserved | | X | Invalid | X |
| [8] | CRC Suspend Status Bit | CRCSSB | 0 | Invalid | 0 = No CRC in Suspension 1 = CRC in Suspension |
| [7] | Device Ready Bit | DRB | 1 | 0 | 1 |
| [6] | Erase Suspend Status Bit | ESSB | 0 | Invalid | 0 = No Erase in Suspension 1 = Erase in Suspension |
| [5] | Erase Status Bit | ESB | 0 | Invalid | 0 = Erase Successful 1 = Erase Fail |
| [4] | Program Status Bit | PSB | 0 | Invalid | 0 = Program Successful 1 = Program Fail |
| [3] | Write Buffer Abort Status Bit | WBASB | 0 | Invalid | 0 = Program Not Aborted 1 = Program Aborted during Write to Buffer Command |
| [2] | Program Suspend Status Bit | PSSB | 0 | Invalid | 0 = No Program in Suspension 1 = Program in Suspension |
| [1] | Sector Lock Status Bit | SLSB | 0 | Invalid | 0 = Sector Not Locked during Operation 1 = Sector Locked Error |
| [0] | Sector Erase Status Bit | ESTAT | 0 | Invalid | 0 = Sector Erase Status Command Result = previous erase did not complete successfully 1 = Sector Erase Status Command Result = previous erase completed successfully |

Notes

34. Bits 15 through 9 are reserved for future use and may display as 0 or 1. These bits should be ignored (masked) when checking status.
35. Bit 7 is 1 when there is no Embedded Algorithm in progress in the device.
36. Bit 8 and bits 6 through 0 are valid only if Bit 7 is 1.
37. All bits are put in their reset status by cold reset or warm reset.
38. Bits 5, 4, 3, 1, and 0 are cleared to 0 by the Clear Status Register command or Software Reset command.
39. Upon issuing the Erase Suspend command, the user must continue to read status until DRB becomes 1.
40. ESSB is cleared to 0 by the Erase Resume command.
41. ESB reflects success or failure of the most recent erase operation.
42. PSB reflects success or failure of the most recent program operation.
43. During Erase Suspend, programming to the suspended sector, will cause program failure and set the Program status bit to 1.
44. During Erase Suspend, an erase operation will cause an erase failure and set the Erase status bit to 1.
45. During Program Suspend, a programming operation will cause a program failure and set the Program status bit to 1.
46. During Program Suspend, an erase operation will cause an erase failure and set the Erase status bit to 1.
47. Upon issuing the Program Suspend command, the user must continue to read status until DRB becomes 1.
48. PSSB is cleared to 0 by the Program Resume command.
49. SLSB indicates that a program or erase operation failed because the target memory region was locked.
50. SLSB reflects the status of the most recent program or erase operation.
51. CRCSSB – During a suspended CRC calculation only read operations from the array are allowed.

6.2.12 Non-Volatile Configuration Register and Volatile Configuration Register

The Non-Volatile Configuration Register (NVCR) and the Volatile Configuration Register (VCR) are used to define the operating conditions for the HyperFlash bus. Configurable characteristics include:

1. Wrapped Burst Length (16-byte, 32-byte, or 64-byte wrapped burst).
 - a. 16-byte and 32-byte wrapped bursts behave in the legacy manner, 64-byte wrapped burst behave as shown in [Table 22 on page 39](#).
2. Read Latency (5 to 16 clocks to allow for initial read latency).
3. Output Driver Drive Strength.
4. Whether the 4-KB Parameter-Sectors are used and how they are mapped into the address map.
5. SSR Freeze bit to lock the Secure Silicon Region.
6. xVCR Freeze bit to lock the Volatile Configuration Register and the Non-Volatile Configuration Register.

The contents of the VCR and NVCR can be loaded and read back as described in [Table 40 on page 64](#). The HyperFlash device uses the contents of the NVCR to define bus characteristics upon Power-Up or after a Hardware Reset. If the host system loads the VCR, the bus characteristics will be defined by the contents of the VCR ([Figure 17](#)). The NVCR is intended to hold a default setting to allow alignment with the host controller settings during boot operation. The VCR will often be updated with optimized settings during the boot process. The source for bus characteristics will shift from the NVCR (after Power-Up or Hard Reset) to the VCR once the VCR is loaded. Once the VCR is loaded only a Power-Up or Hard Reset will return bus characteristics back to the NVCR settings. When unlocked the VCR can be altered at any time while the device is idle.

The number of times the NVCR can be erased and reprogrammed is defined by the NVCR spec. To assure consistent bus configuration during and after NVCR programming the VCR should be used to define bus operating characteristics when programming the NVCR.

Table 18. VCR and NVCR Configuration Register Bit Assignments

| xVCR Bit | Function | Settings (Binary) |
|-------------|--------------------------|---|
| xVCR[15] | Reserved | 1 = Reserved (default) |
| xVCR[14:12] | Drive Strength | See Table 19 on page 37 . |
| xVCR[11] | xVCR Freeze | 0 = VCR or NVCR Locked (No Programming or Erasing of NVCR, no changes to VCR) 1 = VCR and NVCR Unlocked (factory default) |
| xVCR[10] | SSR Freeze | 0 = Secure Silicon Region Locked (Programming not allowed) 1 = Secure Silicon Region Unlocked (factory default) |
| xVCR[9:8] | Parameter-Sector Mapping | 00 = Parameter-Sectors and Read Password Sectors mapped into lowest addresses 01 = Parameter-Sectors and Read Password Sectors mapped into highest addresses 10 = Uniform Sectors with Read Password Sector mapped into lowest addresses. (factory default) 11 = Uniform Sectors with Read Password Sector mapped into highest addresses |
| xVCR[7:4] | Read Latency | 0000 = 5 Clock Latency 0001 = 6 Clock Latency 0010 = 7 Clock Latency 0011 = 8 Clock Latency 0100 = 9 Clock Latency ... 1011 = 16 Clock Latency (factory default) See Table 4 on page 13 . |
| xVCR[3] | Reserved | 1 = Reserved (default) |
| xVCR[2] | RWDS Stall Control | 0 = RWDS will stall (remain Low) upon Dual Error Detect (default) 1 = RWDS will not be stalled upon Dual Error Detect |
| xVCR[1:0] | Burst Length | 00 = Reserved 01 = 64 bytes 10 = 16 bytes 11 = 32 bytes (factory default) |

Note

52. The placement of the Configuration Register bits are the same in both the Non-Volatile and Volatile Configuration Registers.

Table 19. Drive Strength Code

| xVCR[14:12] | Typical Impedance 1.8V V _{CCQ} | Typical Impedance 3V V _{CCQ} | Units |
|---------------|---|---------------------------------------|-------|
| 000 (default) | 27 | 20 | Ohms |
| 001 | 117 | 71 | |
| 010 | 68 | 40 | |
| 011 | 45 | 27 | |
| 100 | 34 | 20 | |
| 101 | 27 | 16 | |
| 110 | 24 | 14 | |
| 111 | 20 | 12 | |

Note

 56. Typical Impedance measured at nominal V_{CCQ}, 25°C.

Figure 17. Configuration Control^[53, 54, 55]

Table 20. VCR and NVCR Freeze Bits Immediately After Power-Up or Hardware Reset

| NVCR[11] Bit | VCR[11] Bit | NVCR | VCR |
|--------------|-------------|-------------------------|--|
| 1 | 1 | Programmable / Erasable | Settable / Clearable |
| 1 | 0 | Temporarily Locked | Temporarily Locked |
| 0 | 1 | Programmable / Erasable | Settable / Clearable ^[57, 59] |
| 0 | 0 | Permanently Locked | Permanently Locked ^[60] |

Notes

57. Programming / Erasing the NVCR will not impact behavior until after the next POR or Hardware Reset.

58. Loading the VCR will impact behavior immediately.

59. This state occurs after NVCR[11] = VCR[11] = 1 and the NVCR[11] bit is programmed. The state will only exist until the next POR or Hardware Reset. Thereafter NVCR[11] = VCR[11] = 0.

60. This state occurs after POR or Hardware Reset when NVCR[11] was previously programmed.

Notes

53. A Software Reset will not change the state of the CR Select Multiplexer.

54. Programming or erasure of the NVCR does not impact the contents of the VCR that has been previously loaded.

55. If the VCR has not been loaded, programming of the NVCR will result in the VCR being loaded with the new NVCR value.

Table 21. Example Burst Sequences

| VCR / NVCR [1:0] | CA[45] | Wrap Boundary (Bytes) | Start Address (Hex) | Address Sequence (Hex) (Words) |
|------------------|--------|-----------------------|---------------------|---|
| XX | 1 | Linear | XXXXXX03 | 03, 04, 05, 06, 07, 08, 09, 0A, 0B, 0C, 0D, 0E, 0F, 10, 11, 12, 13, 14, 15, 16, 17, 18, ... |
| 10 | 0 | 16 | XXXXXX02 | 02, 03, 04, 05, 06, 07, 00, 01, ... |
| 10 | 0 | 16 | XXXXXX0C | 0C, 0D, 0E, 0F, 08, 09, 0A, 0B, ... |
| 11 | 0 | 32 | XXXXXX0A | 0A, 0B, 0C, 0D, 0E, 0F, 00, 01, 02, 03, 04, 05, 06, 07, 08, 09, ... |
| 11 | 0 | 32 | XXXXXX1E | 1E, 1F, 10, 11, 12, 13, 14, 15, 16, 17, 18, 19, 1A, 1B, 1C, 1D, ... |
| 01 | 0 | 64 | XXXXXX03 | 03, 04, 05, 06, 07, 08, 09, 0A, 0B, 0C, 0D, 0E, 0F, 10, 11, 12, 13, 14, 15, 16, 17, 18, 19, 1A, 1B, 1C, 1D, 1E, 1F, 00, 01, 02, ... |
| 01 | 0 | 64 | XXXXXX2E | 2E, 2F, 30, 31, 32, 33, 34, 35, 36, 37, 38, 39, 3A, 3B, 3C, 3D, 3E, 3F, 20, 21, 22, 23, 24, 25, 26, 27, 28, 29, 2A, 2B, 2C, 2D, , ... |

6.2.12.1 CRC Value Register

The volatile CRC register (CRCR) stores the results of the CRC process that calculates the Check-value on the data contained at the starting address through the ending address.

Table 23. CRC Value Register Bit Assignments

| Bit Position | CRC Value Low Result Register | CRC Value High Result Register |
|--------------|-------------------------------|--------------------------------|
| [15] | R15 | R31 |
| [14] | R14 | R30 |
| [13] | R13 | R29 |
| [12] | R12 | R28 |
| [11] | R11 | R27 |
| [10] | R10 | R26 |
| [9] | R9 | R25 |
| [8] | R8 | R24 |
| [7] | R7 | R23 |
| [6] | R6 | R22 |
| [5] | R5 | R21 |
| [4] | R4 | R20 |
| [3] | R3 | R19 |
| [2] | R2 | R18 |
| [1] | R1 | R17 |
| [0] | R0 | R16 |

6.2.13 ASO Entry and Exit

6.2.13.1 ID-CFI ASO

The system can access the ID-CFI ASO by issuing the ID-CFI Entry command sequence during Read Mode. This entry command uses the Sector Address (SA) in the command to determine which sector will be overlaid. See the detail descriptions in [Table 40 on page 64](#), [Table 12 on page 21](#), [Section 5.2.1 Device ID on page 21](#), and [Section 5.2.2 Common Flash Memory Interface on page 22](#).

The ID-CFI ASO allows the following activities:

- Read ID-CFI ASO, using the same SA as used in the Entry command.
- ASO Exit.

The following is a C source code example of using the CFI Entry and Exit functions. Refer to the *Low Level Driver User Guide* for general information on Cypress flash memory software development guidelines.

```

/* Example: CFI Entry command */
*( (UINT16 *)base_addr + 0x555 ) = 0x0098; /* write CFI entry command */

/* Example: CFI Exit command */
*( (UINT16 *)base_addr + 0x000 ) = 0x00F0; /* write cfi exit command */

```

Note

61. CRC Value is a Volatile Register.

6.2.13.2 Status Register ASO

When the Status Register read command is issued, the current status is captured by the register and the ASO is entered. The first read access in the Status Register ASO exits the ASO and returns to the address space map in use when the Status Register read command was issued. No other command should be sent before reading the status to exit the Status Register ASO. The contents of the Status Register is only output as the first data value of a burst read, indeterminate data will be output during subsequent clock cycles.

6.2.13.3 Secure Silicon Region ASO

The system can access the Secure Silicon Region by issuing the Secure Silicon Region Entry command sequence during Read Mode. This entry command uses the Sector Address (SA) in the command to determine which sector will be overlaid.

The Secure Silicon Region ASO allows the following activities:

- Read Secure Silicon Region, using the same SA as used in the entry command. Reads within the overlaid SA but outside of the SSR will return indeterminate data.
- Reads to a SA outside of the Secure Silicon Region will retrieve array data. A read from the array will not cause an exit from the SSR ASO.
- Program the customer Secure Silicon Region using the Word or Write Buffer Programming commands.
- ASO Exit using legacy Secure Silicon Exit command for backward software compatibility.
- ASO Exit using the common exit command for all ASO – alternative for a consistent exit method.

6.2.13.4 ASP Configuration Register (ASPR) ASO

The system can access the ASP Configuration Register by issuing the ASP Configuration Register entry command sequence during Read Mode. This entry command does not use a sector address from the entry command. The ASP Configuration Register appears at word location 0 in the device address space. All other locations in the device address space are undefined.

The ASP Configuration Register ASO allows the following activities:

- Read ASP Configuration Register, using device address location 0.
- Program the customer ASP Configuration Register using a modified Word Programming command.
- ASO Exit using legacy Command Set Exit command for backward software compatibility.
- ASO Exit using the common exit command for all ASO – alternative for a consistent exit method.

6.2.13.5 Password ASO

The system can access the Password ASO by issuing the Password entry command sequence during Read Mode. This entry command does not use a sector address from the entry command. The Password appears at word locations 0 to 3 in the device address space. All other locations in the device address space are undefined.

The Password ASO allows the following activities:

- Read Password, using device address location 0 to 3.
- Program the Password using a modified Word Programming command.
- Unlock the PPB Lock Bit with the Password Unlock command.
- ASO Exit using legacy Command Set Exit command for backward software compatibility.
- ASO Exit using the common exit command for all ASO – alternative for a consistent exit method.

6.2.13.6 PPB ASO

The system can access the PPB ASO by issuing the PPB entry command sequence during Read Mode. This entry command does not use a sector address from the entry command. The PPB bit for a sector appears in bit 0 of all word locations in the sector.

The PPB ASO allows the following activities:

- Read PPB protection status of a sector in bit 0 of any word in the sector.
- Program the PPB bit using a modified Word Programming command.
- Erase all PPB bits with the PPB erase command.
- ASO Exit using legacy Command Set Exit command for backward software compatibility.
- ASO Exit using the common exit command for all ASO – alternative for a consistent exit method.

6.2.13.7 PPB Lock ASO

The system can access the PPB Lock ASO by issuing the PPB Lock entry command sequence during Read Mode. This entry command does not use a sector address from the entry command. The global PPB Lock bit appears in bit 0 of all word locations in the device.

The PPB Lock ASO allows the following activities:

- Read PPB Lock protection status in bit 0 of any word in the device address space.
- Clear the PPB Lock bit using a modified Word Programming command.
- ASO Exit using legacy Command Set Exit command for backward software compatibility.
- ASO Exit using the common exit command for all ASO – alternative for a consistent exit method.

6.2.13.8 Dynamic Protection Bits (DYB) ASO

The system can access the DYB ASO by issuing the DYB entry command sequence during Read Mode. This entry command does not use a sector address from the entry command. The DYB bit for a sector appears in bit 0 of all word locations in the sector.

The DYB ASO allows the following activities:

- Read DYB protection status of a sector in bit 0 of any word in the sector
- Set the DYB bit using a modified Word Programming command
- Clear the DYB bit using a modified Word Programming command
- ASO Exit using legacy Command Set Exit command for backward software compatibility
- ASO Exit using the common exit command for all ASO – alternative for a consistent exit method

6.2.13.9 ECC Status ASO

The ECC Status ASO displays the status of any error correction action when reading a half-page of the Flash Memory Array. A single word of status is displayed at any word location within a half-page.

The system can access the ECC Status ASO by issuing the ECC Status entry command sequence during Read Mode. This entry command does not use a sector address from the entry command. The ECC Status bits for a Half-page appears in bits 4, 3, 2, 1, and 0 of all word locations in the addressed half-page.

The ECC Status ASO allows the following activities:

- Read the ECC Status register value for the addressed half-page
- Read the Error-Detect Upper and Lower Address Trap Registers
- Read the ECC error counter register
- ASO Exit

6.2.13.10 CRC ASO

Entering the CRC ASO enables the CRC related commands and reading of the CRC calculation result check-value. While the CRC calculation is not suspended the CRC ASO overlays the entire Flash memory array. When the CRC calculation is suspended the Flash memory array is visible for reading. Only reading of the memory array is supported while entered in the CRC ASO and the CRC calculation is suspended. The CRC ASO allows the following activities:

- Load CRC beginning location
- Load CRC ending location
- CRC calculation suspend
- Flash array read during suspend
- CRC calculation resume
- Read check-value result
- Exit the CRC ASO

6.2.13.11 Software (Command) Reset / ASO exit

Software Reset is part of the command set (see [Table 40 on page 64](#)) that also returns the EAC to Standby state and must be used for the following conditions:

- Exit ID/CFI Mode
- Clear timeout bit (DQ5) for data polling when timeout occurs

Software Reset does not affect EA Mode. Reset commands are ignored once programming or erasure has begun, until the operation is complete. Software Reset does not affect outputs; it serves primarily to return to Read Mode from an ASO Mode or from a failed program or erase operation.

Software Reset may cause a return to Read Mode from undefined states that might result from invalid command sequences. However, a Hardware Reset may be required to return to normal operation from some undefined states.

There is no Software Reset latency requirement. The reset command is executed during the t_{WPH} period.

6.2.14 Error Types and Clearing Procedures

There are three types of errors reported by the embedded operation status methods. Depending on the error type, the status reported and procedure for clearing the error status is different. The following is the clearing of error status:

- If an ASO was entered before the error the device remains entered in the ASO awaiting ASO read or a command write.
- If an erase was suspended before the error the device returns to the erase suspended state awaiting flash array read or a command write.
- Otherwise, the device will be in Standby state awaiting flash array read or a command write.

6.2.14.1 Embedded Operation Error (and Invalid Password)

If an error occurs during an embedded operation (program, erase, blank check, or password unlock) the Embedded Algorithm Controller remains active. The Status Register shows ready (SR[7] = 1) with valid status bits indicating the reason for the error. The Embedded Algorithm Controller remains active until the error status is detected by the host system status monitoring and the error status is cleared.

During embedded algorithm error status the Status Register will show the following:

- SR[7] = 1; Valid status displayed
- SR[6] = X; May or may not be erase suspended during the EA error
- SR[5] = 1 on erase or blank check error, else = 0
- SR[4] = 1 on program error or invalid password, else = 0
- SR[3] = X; Treat as 'don't care' (masked)
- SR[2] = 0; No Program in suspension
- SR[1] = 0
- SR[0] = X; Treat as 'don't care' (masked)

When the embedded algorithm error status is detected, it is necessary to clear the error status in order to return to normal operation, ready for a new read or command write. The error status can be cleared by writing:

- Reset command
- Status Register Clear command

Commands that are accepted during embedded algorithm error status are:

- Status Register Read
- Reset command
- Status Register Clear command

6.2.14.2 Protection Error

If an embedded algorithm attempts to change data within a protected area (program, or erase of a protected sector or OTP area) the device (EAC) goes busy for a period of 20 to 100 μ s then returns to normal operation. Protection mechanisms include DYB, PPB, and Locks. During the busy period the Status Register shows not ready with invalid status bits (SR[7] = 0). If a programming or erase operation is attempted to a locked region the operation will be aborted and the failure will be indicated in the Status Register (see [Table 17 on page 35](#)).

Commands that are accepted during the protection error status busy period are:

- Status Register Read

When the busy period ends the device returns to normal operation, and the Status Register shows ready with valid status bits. The device is ready for flash array read or write of a new command.

After the protection error status busy period the Status Register will show the following:

- SR[7] = 1; Valid status displayed
- SR[6] = X; May or may not be erase suspended after the protection error busy period
- SR[5] = 1 on erase error, else = 0
- SR[4] = 1 on program or password unlock error, else = 0
- SR[3] = X; Treat as 'don't care' (masked)
- SR[2] = 0; No Program in suspension
- SR[1] = 1; Error due to attempting to change a protected location
- SR[0] = X; Treat as 'don't care' (masked)

Commands that are accepted after the protection error status busy period are:

- Any command

For cases where the Program Status Bit is set a further program operation will immediately clear SR[4]. For cases where the Erase Status Bit is set a further erase operation will immediately clear SR[6].

6.2.14.3 Write Buffer Abort

If an error occurs during a Write to Buffer command the device (EAC) remains busy. The Status Register shows ready with valid status bits. The device remains busy until the error status is detected by the host system status monitoring and the error status is cleared.

During embedded algorithm error status the Status Register will show the following:

- SR[7] = 1; Valid status displayed
- SR[6] = X; May or may not be erase suspended during the WBA error status
- SR[5] = 0; Erase successful
- SR[4] = 1; Programming related error, else = 0
- SR[3] = 1; Write buffer abort
- SR[2] = 0; No Program in suspension
- SR[1] = 0; Sector not locked during operation
- SR[0] = X; Treat as 'don't care' (masked)

When the WBA error status is detected, it is necessary to clear the error status in order to return to normal operation, ready for a new read or command write. The error status can be cleared by writing:

- Write Buffer Abort Reset command
 - Clears the status register and returns to normal operation
- Status Register Clear command

Commands that are accepted during embedded algorithm error status are:

- Status Register Read
 - Reads the status register and returns to WBA busy state
- Write Buffer Abort Reset command
- Status Register Clear command

During an embedded algorithm, read transactions not associated with a Status Register Read will toggle RWDS and return indeterminate data.

6.2.14.4 ECC Error

There are three methods for reporting to the host system when ECC errors are detected.

- There is an ECC Status ASO that provides the status of any error detection or correction action taken when reading a half-page location within the ASO.
- The Interrupt (INT#) output may be enabled to indicate when either a one or two bit error is detected as a Half-page is read.
- A mode may be enabled to cause the Read Write Data Strobe (RWDS) to stop toggling (stall) when reading a Half-page containing a two bit error. The stall condition can be detected by the HyperBus master as a bus error when RWDS does not transition for more than 32 clock cycles.

ECC Status Register (ECCSR)

ECCSR does not have user programmable non-volatile bits, all defined bits are volatile read only status. The status of ECC in each Half-page ECC unit is provided by the 16-bit ECC Status Register (ECCSR). The ECC Register Read command is written followed by an ECC unit address. The contents of the status register then indicates, for the selected ECC unit, whether there is an error in the ECC, the ECC unit data, or that ECC is disabled for that ECC unit. Results regarding 2-bit ECC Detection (ECCSR[4]) and 1-bit ECC Correction (ECCSR[3]) are global and not dependent on any specific ECC unit address.

Table 24. ECC Status Register Bit Assignments

| Bits | Field Name | Function | Type | Default State | Description |
|--------|------------|------------------------|---------------------|---------------|---|
| [15:5] | RFU | Reserved | Volatile, Read Only | 0 | Reserved for Future Use |
| [4] | 2BD | 2-bit ECC Detection | Volatile, Read Only | 0 | 1 = 2-bit ECC detection occurred since last ECC Status ASO exit 0 = No 2-bit ECC detection occurred since last ECC Status ASO exit |
| [3] | CB | 1-bit ECC Correction | Volatile, Read Only | 0 | 1 = ECC correction performed since last ECC Status ASO exit 0 = No ECC correction performed since last ECC Status ASO exit |
| [2] | EECC | Error in ECC | Volatile, Read Only | 0 | 1 = Single bit error found in the ECC unit error correction code 0 = No error |
| [1] | EECCD | Error in ECC unit data | Volatile, Read Only | 0 | 1 = Single bit error correction in ECC unit data 0 = No error |
| [0] | ECCD1 | ECC disabled | Volatile, Read Only | 0 | 1 = ECC is disabled in selected ECC unit 0 = ECC is enabled in selected ECC unit |

ECCSR[0] = 1 indicates the ECC is disabled in the ECC unit.

ECCSR[1] = 1 indicates an error was corrected in the ECC unit data.

ECCSR[2] = 1 indicates an error was corrected in the ECC syndrome.

The default state of 0 for ECCSR[2:0] bits indicates no failures and ECC is enabled.

ECCSR[3] = 1 indicates that an ECC correction has been performed since the last ECC Status ASO exit. An ECC Status ASO exit resets the ECCSR[3] value to the 0 state. Note that the ECC results for the current ECC Status Read may impact the ECCSR[3] bit.

ECCSR[4] = 1 indicates that a 2-bit ECC detection has occurred since the last ECC Status Register ASO exit. An ECC Status ASO exit resets the ECCSR[4] value to the 0 state. Note that the ECCSR[3:1] bits are not valid if a 2-bit ECC event has occurred. If a 2-bit ECC detection has occurred the address accessed when the error was detected is trapped in a pair of registers. Note that the ECC results for the current ECC Status Read may impact the ECCSR[4] bit.

The **ECCSR[15:5]** bits are reserved. These have undefined High or Low values that can change from one ECC status read to another. These bits should be treated as 'don't care' and ignored by any software reading ECC status.

The ECCSR is returned to the default state (0s) with a Hardware Reset or when the ECC Status ASO is exited with a Software-Reset / ASO-Exit command.

Address Trap Register (ATR)

A register is provided to capture the Half-page address where an ECC error is first encountered during a read of the Flash array. The 512 Mbit HyperFlash density devices only record the address where a two-bit error is encountered. All other HyperFlash devices may use the ASPR[13] configuration bit to enable the Address Trap Register to capture both 1-bit and 2-bit error locations. The Address Trap Register has a valid address when the ECC Status Register (ECCSR) bit 3 or 4 = 1.

The Error Lower Address Register and Error Upper Address Register contain the address that was accessed when the error is detected. The failing bits may not be located at the exact address indicated in the registers but will be located within the aligned 16-byte Half-page where the error was detected. If errors are found in multiple half-pages during a single read operation the address of the first failing Half-page address is captured in the Error Lower / Upper Address Registers. Only the address of the first enabled error type (2-bit or either 1-bit or 2-bit as selected in ASPR[13]) encountered after Power-On-Reset (POR), hardware reset, or exit from the ECC ASO is captured. Each ECC ASO exit clears the address trap register and ECCSR[4:3] bits.

When two-bit error detection is not enabled and the same Half-page is programmed more than once, ECC error detection for that Half-page is disabled so, no error can be recognized to trap the address.

Table 25. Error Upper / Lower Address Trap Register Bit Assignments

| Density | Error Lower Address Register | Error Upper Address Register | | |
|---------|------------------------------|------------------------------|--------|--------|
| | All | 128 Mb | 256 Mb | 512 Mb |
| [15] | A15 | 0 | 0 | 0 |
| [14] | A14 | 0 | 0 | 0 |
| [13] | A13 | 0 | 0 | 0 |
| [12] | A12 | 0 | 0 | 0 |
| [11] | A11 | 0 | 0 | 0 |
| [10] | A10 | 0 | 0 | 0 |
| [9] | A9 | 0 | 0 | 0 |
| [8] | A8 | 0 | 0 | A24 |
| [7] | A7 | 0 | A23 | A23 |
| [6] | A6 | A22 | A22 | A22 |
| [5] | A5 | A21 | A21 | A21 |
| [4] | A4 | A20 | A20 | A20 |
| [3] | A3 | A19 | A19 | A19 |
| [2] | 0 | A18 | A18 | A18 |
| [1] | 0 | A17 | A17 | A17 |
| [0] | 0 | A16 | A16 | A16 |

Error Detection Counter

The 512 Mb density HyperFlash devices do not support this feature. In HyperFlash devices other than the 512 Mbit density, a counter is provided to keep track of the number of 1-bit or 2-bit errors that occur as Half-pages are read from the Flash array. Only errors recognized in the main array (no active ASO) will cause the Error Detection counter to increment. The counter does not increment while the ECC ASO is entered.

The Error Detection Counter is not cleared when the ECC ASO is exited. The counter will be set to 0 on POR, Hardware Reset or with the Counter Clear command sequence. The Counter Read and Counter Clear command sequences operate only while in the ECC Status ASO. The 16-bit Error Detection Counter will not increment past FFFFh. If the error count has increased since the last ECC ASO exit, the ECC Address Trap register holds the valid address of the first ECC error found after the ECC ASO exit.

Note that during continuous read operations when a 2-bit error is detected and RWDS stops toggling (stalls), the clock may continue toggling and the memory device will continue incrementing the data address and placing new data on the DQ signals; any additional half-pages with errors that are encountered will be counted until CS# is brought back High.

During a burst read transaction only one error is counted for each Half-page found with an error. Each read transaction will cause a new read of the target Half-page. If multiple read transactions access the same Half-page containing an error, the error counter will increment each time that Half-page is read.

When two-bit error detection is not enabled and the same Half-page is programmed more than once, ECC error detection for that Half-page is disabled so, no error can be recognized or counted.

RWDS Stall

The RWDS Stall Control Bit in xVCR[2] can be used to enable RWDS stall when a two bit error is encountered. If enabled (xVCR[2] = 0), upon DED, the RWDS will be driven Low. RWDS will remain in the Low state as long as CS# remains asserted, normal RWDS functionality resumes as soon as CS# returns High. If the RWDS Stall Control Bit is in the disabled state (xVCR[2] = 1) RWDS behavior is not impacted.

6.3 Data Protection

6.3.1 Secure Silicon Region

Each device has a 1024-byte one-time programmable Secure Silicon Region (SSR) address space that is separate from the Flash Memory Array. The SSR area is divided into 32, individually lockable, 32-byte aligned and length regions.

In the 32-byte region starting at address zero:

- The 16 lowest address bytes are programmed by Cypress with a 128-bit random number. Only Cypress is able to program these bytes. Attempting to program 0s into these locations will fail and generate a Program Status Error (SR[4] = 1).
- The next 4 higher address bytes (SSR Lock Bytes) are used to provide one bit per SSR region to permanently protect each region from programming. The bytes are erased when shipped from Cypress. After an SSR region is programmed, it can be locked to prevent further programming, by programming the related protection bit in the SSR Lock Bytes.
- The next higher 12 bytes of the lowest address region are Reserved for Future Use (RFU). The bits in these RFU bytes may be programmed by the host system but it must be understood that a future device may use those bits for protection of a larger SSR space. The bytes are erased when shipped from Cypress.

The remaining regions are erased when shipped from Cypress, and are available for programming of additional permanent data.

Refer to [Figure 18 on page 49](#) for a pictorial representation of the SSR memory space.

The SSR memory space is intended for increased system security. SSR values, such as the random number programmed by Cypress, can be used to 'mate' a flash component with the system CPU / ASIC to prevent device substitution.

The configuration register SSR Freeze (xVCR[10]) bit protects the entire SSR memory space from programming when cleared (or programmed for NVCR) to 0. This allows trusted boot code to control programming of SSR regions then set the Freeze bit to prevent further SSR memory space programming during the remainder of normal power-on system operation.

6.3.1.1 Reading the Secure Silicon Region Memory Space

Reading the SSR Region is performed once the SSR ASO is entered using the SSR entry sequence. The SSR is mapped to a specific sector identified during the SSR Entry command sequence. SSR Read operations within the sector identified during the SSR Entry command sequence but outside the valid 8-KB SSR address range will yield indeterminate data. Reads to sectors not overlaid by the SSR ASO will retrieve array data. A SSR Exit sequence will return the device to the array read ASO.

6.3.1.2 Programming Secure Silicon Region Memory Space

Programming the SSR memory is performed once the SSR ASO is entered using the SSR Entry sequence. The protocol of the SSR programming command is the same as normal array programming. The SSR programming sequences can be issued multiple times to any given SSR address, but this address space can never be erased. The valid address range for SSR Program is depicted in [Figure 18](#). SSR Program operations outside the valid SSR address range will ignore address A9 and higher and will alias into the valid SSR address range. SSR Program operations while Freeze = 0 will fail with no indication of the failure. The SSR address space is not protected by the selection of an ASP Protection Mode. The Freeze SSR bit (xVCR.10) may be used to protect the SSR address space. A SSR Exit sequence will return the device to the Read Mode.

Figure 18. SSR Address Space

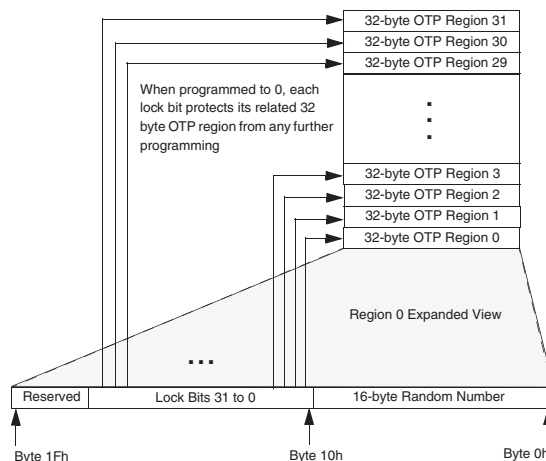

Table 26. SSR Address Map

| Region | Byte Address Range (Hex) | Contents | Initial Delivery State (Hex) |
|-----------|--------------------------|---|----------------------------------|
| Region 0 | 0000h | Least Significant Byte of Cypress Programmed Random Number | Cypress Programmed Random Number |
| | ... | ... | |
| | 000Fh | Most Significant Byte of Cypress Programmed Random Number | |
| | 0010h - 0013h | Region Locking Bits Byte 10 [bit 0] locks region 0 from programming when = 0 ... Byte 13 [bit 7] locks region 31 from programming when = 0 | All Bytes = FFh |
| | 0014h - 001Fh | Reserved for Future Use (RFU) | All Bytes = FFh |
| Region 1 | 0020h - 003Fh | Available for User Programming | All Bytes = FFh |
| Region 2 | 0040h - 005Fh | Available for User Programming | All Bytes = FFh |
| ... | ... | Available for User Programming | All Bytes = FFh |
| Region 31 | 03E0h - 03FFh | Available for User Programming | All Bytes = FFh |

6.3.2 Advanced Sector Protection (ASP)

Advanced Sector Protection (ASP) is a set of independent hardware and software methods used to disable or enable programming or erase operations, individually, in any or all sectors. This section describes the various methods of protecting data stored in the memory array. An overview of these methods is shown in Figure 19.

Figure 19. Advanced Sector Protection Overview



Every Flash Memory Array sector has a non-volatile (PPB) and a volatile (DYB) protection bit associated with it. When either bit is 0, the associated sector is protected from program and erase operations.

The PPB bits are protected from program and erase when the PPB Lock bit is 0. There are two methods for managing the state of the PPB Lock Bit, Persistent Protection and Password Protection.

The Persistent Protection method sets the PPB Lock Bit to 1 during POR or Hardware Reset so that the PPB bits are unprotected by a device reset. Software Reset does not affect the PPB Lock Bit. There is a command to clear the PPB Lock Bit to 0 to protect the PPB. There is no command in the Persistent Protection method to set the PPB Lock Bit therefore the PPB Lock Bit will remain at 0 until the next Power-Off or Hardware Reset. The Persistent Protection method allows boot code the option of changing sector protection by programming or erasing the PPB, then protecting the PPB from further change for the remainder of normal system operation by clearing (to 0) the PPB Lock Bit. This is sometimes called Boot-Code Controlled Sector Protection.

The Password method clears the PPB Lock Bit to 0 during POR or Hardware Reset to protect the PPB. A 64-bit password may be permanently programmed and hidden for the Password method. A command can be used to provide a password for comparison with the hidden password. If the password matches the PPB Lock Bit is set to 1 to unprotect the PPB. A command can be used to clear the PPB Lock Bit to 0. This method requires use of a password to control PPB Protection.

The selection of the PPB Lock management method is made by programming OTP bits in the ASP Configuration Register so as to permanently select the method used.

The PPB bits are erased so that all Flash Memory Array sectors are unprotected when shipped from Cypress.

6.3.3 PPB Lock

The Persistent Protection Lock Bit is a volatile bit for protecting all PPB bits. When cleared to 0, it locks all PPBs and when set to 1, it allows the PPBs to be changed. There is only one PPB Lock Bit per device.

The PPB Lock command is used to clear the bit to 0. The PPB Lock Bit must be cleared to 0 only after all the PPBs are configured to the desired settings.

In Persistent Protection Mode, the PPB Lock Bit is set to 1 during POR or a Hardware Reset. When cleared with the PPB Lock Bit Clear sequence, no software command sequence can set the PPB Lock Bit, only another Hardware Reset or Power-Up can set the PPB Lock Bit.

In the Password Protection Mode, the PPB Lock Bit is cleared to 0 during POR or a Hardware Reset. The PPB Lock Bit can only set to 1 by the Password Unlock command sequence. The PPB Lock Bit can be cleared back to 0 with the PPB Lock Bit Clear sequence.

6.3.4 Persistent Protection Bits (PPB)

The Persistent Protection Bits (PPB) are located in a separate non-volatile flash array. One of the PPB bits is assigned to each sector. When a PPB is programmed to 0 its related sector is protected from program and erase operations. The PPB are programmed individually but must be erased as a group, similar to the way individual words may be programmed in the main array but an entire sector must be erased at the same time. Preprogramming and verification prior to erasure are handled by the EAC.

Programming a PPB bit requires the typical word programming time. During a PPB bit programming operation or PPB bit erasing, the Status Register can be accessed to determine when the operation has completed. Erasing all the PPBs requires typical sector erase time.

If the PPB Lock Bit is 0, the PPB Program or erase command does not execute and times-out without programming or erasing the PPB. If an program or erase operation is attempted to the PPB bits when the PPB Lock Bit is 0 the operation will be aborted and the failure will be indicated in the Status Register (see [Table 17 on page 35](#)).

The protection state of a PPB for a given sector can be verified by writing a PPB Status Read command when entered in the PPB ASO.

6.3.5 Dynamic Protection Bits (DYB)

Dynamic Protection Bits are volatile and unique for each sector and can be individually modified. DYBs only control protection for sectors that have their PPBs cleared. By issuing the DYB Set or Clear command sequences, the DYB are set to 0 or cleared to 1, thus placing each sector in the protected or unprotected state respectively. This feature allows software to easily protect sectors against inadvertent changes, yet does not prevent the easy removal of protection when changes are needed.

The DYB can be set to 0 or cleared to 1 as often as needed.

6.3.6 Sector Protection States Summary

Each sector can be in one of the following protection states:

- Unlocked – The sector is unprotected and protection can be changed by a simple command. The protection state defaults to unprotected after a power cycle or Hardware Reset.
- Dynamically Locked – A sector is protected and protection can be changed by a simple command. The protection state is not saved across a power cycle or Hardware Reset.
- Persistently Locked – A sector is protected and protection can only be changed if the PPB Lock Bit is set to 1. The protection state is non-volatile and saved across a power cycle or Hardware Reset. Changing the protection state requires programming or erase of the PPB bits.

Table 27. Sector Protection States

| Protection Bit Values | | | Sector State |
|-----------------------|-----|-----|---|
| PPB Lock Bit | PPB | DYB | |
| 1 | 1 | 1 | Unprotected – PPB and DYB are changeable |
| 1 | 1 | 0 | Protected – PPB and DYB are changeable |
| 1 | 0 | 1 | Protected – PPB and DYB are changeable |
| 1 | 0 | 0 | Protected – PPB and DYB are changeable |
| 0 | 1 | 1 | Unprotected – PPB not changeable, DYB is changeable |
| 0 | 1 | 0 | Protected – PPB not changeable, DYB is changeable |
| 0 | 0 | 1 | Protected – PPB not changeable, DYB is changeable |
| 0 | 0 | 0 | Protected – PPB not changeable, DYB is changeable |

6.3.7 ASP Configuration Register

The ASP Configuration Register (ASPR) holds the non-volatile OTP bits for controlling security management.

Table 28. ASP Configuration Register

| Bit | Default Value | Name |
|---------|---------------|---|
| [15:14] | 1 | Reserved |
| [13] | 1 | 1-bit Address Trap Enable (not available on the 512-Mb device) ASPR[13] = 0: Address Trap Register will trap both 1-bit and 2-bit errors ASPR[13] = 1: Address Trap Register only traps 2-bit errors (legacy functionality) |
| [12] | 1 | Reserved |
| [11] | 1 | Hybrid Burst Type Enable ASPR[11] = 0: Hybrid – One Wrapped burst sequence followed by linear burst ASPR[11] = 1: Legacy – Wrapped burst sequence only |
| [10] | 1 | Reserved |
| [9] | 1 | DED / ECC On-Off Bit ASPR[9] = 0: ECC On-Off Bit Disabled, Dual Error Detect Enabled ASPR[9] = 1: ECC On-Off Bit Enabled, Dual Error Detect Disabled (default) |
| [8] | 0 | Reserved |
| [7] | X | Reserved |
| [6] | 1 | Reserved |
| [5] | 1 | Read Password Mode Enable ASPR[5] = 0: Read Password Mode Permanently Enabled ASPR[5] = 1: Read Password Mode Disabled (default from factory) |
| [4] | 1 | Reserved |
| [3] | 1 | Reserved |

Table 28. ASP Configuration Register (Continued)

| Bit | Default Value | Name |
|-------|---------------|--|
| [2:1] | 1 | Persistent / Password Protection Mode Lock Bits ASPR[2:1] = 00: Not Allowed ASPR[2:1] = 01: Password Mode Permanently Enabled, ASPR Frozen ASPR[2:1] = 10: Persistent Mode Permanently Enabled, ASPR Frozen ASPR[2:1] = 11: Persistent Mode Temporarily Enabled (default from factory) |
| [0] | 1 | Reserved |

As shipped from the factory, all devices default to the Persistent Protection method, with all sectors unprotected, when power is applied. The device programmer or host system can then choose which sector protection method to use. Programming either of the following two, one-time programmable, non-volatile bits, locks the part permanently in that mode:

- Persistent Protection Mode Lock Bit (ASPR[1])
- Password Protection Mode Lock Bit (ASPR[2])

If both lock bits (ASPR[2] and ASPR[1]) are selected to be programmed at the same time, the operation will abort and Status Register bits SR[4] and SR[1] will be set to indicate the failure. Once the Password Mode Lock Bit is programmed, the Persistent Mode Lock Bit is permanently disabled and no changes to the protection scheme are allowed. Similarly, if the Persistent Mode Lock Bit is programmed, the Password Mode is permanently disabled. Programming attempts to the ASPR after either ASPR[2] or ASPR[1] have been programmed will be aborted and Status Register bits SR[4] and SR[1] will be set to indicate the failure.

If the Password Mode is chosen, the password must be programmed prior to setting the corresponding Lock Register Bit. The four-word password must be programmed in order in a 0-1-2-3 sequence, other programming sequences will result in undefined behavior. After the Password Protection Mode Lock Bit is programmed, a power cycle, Hardware Reset, or PPB Lock Bit Set command is required to set the PPB Lock Bit to 0 to protect the PPB array.

The programming time of the ASP Configuration Register is the same as the typical word programming time. During a ASP Configuration Register programming EA. The system can also determine the status of the ASPR programming by reading the Status Register. See [Section 6.2.14 Error Types and Clearing Procedures on page 44](#) for information on these status bits.

6.3.8 Persistent Protection Mode

The Persistent Protection method sets the PPB Lock Bit to 1 during POR or Hardware Reset so that the PPB bits are unprotected by a device reset. There is a command to clear the PPB Lock Bit to 0 to protect the PPB. There is no command in the Persistent Protection method to set the PPB Lock Bit to 1 therefore the PPB Lock Bit will remain at 0 until the next power-off or Hardware Reset.

6.3.9 Password Protection Mode

Password Protection Mode allows an even higher level of security than the Persistent Sector Protection Mode, by requiring a 64-bit password for setting the PPB Lock Bit. In addition to this password requirement, after Power-Up or Hardware Reset, the PPB Lock Bit is cleared to 0 to ensure protection at Power-Up. Successful execution of the Password Unlock command by entering the entire password sets the PPB Lock Bit to 1, allowing for sector PPB modifications.

Password Protection Notes:

- The Password Program Command is only capable of programming 0's.
- The password is all 1's when shipped from Cypress. It is located in its own memory space and is accessible through the use of the Password Program and Password Read commands.
- All 64-bit password combinations are valid as a password.
- Once the Password is programmed and verified, the Password Protection Mode Locking Bit must be programmed (to 0) in order to prevent reading the password.
- The Password Protection Mode Lock Bit, once programmed (to 0), prevents reading the 64-bit password on the data bus and further password programming. All further program and read commands to the password region are disabled and these commands are ignored. Attempted programming of a protected Password will set the Sector Lock Status Bit (SR[1]) and the Program Status Bit (SR[4]). If a further programming operation is attempted on either the Password or the Password Protection Mode Lock Bit the operation will be aborted and the failure will be indicated in the Status Register (see [Table 17 on page 35](#)). There is no means to verify what the password is after the Password Protection Mode Lock Bit is programmed. Password verification is only allowed before selecting the Password Protection Mode.

- The Password Mode Lock Bit is not erasable.
- For the unlocking function to occur, the password portion can be entered in any order as long as the entire 64-bit password is entered. If the password unlock command provided password does not match the hidden internal password, the unlock operation fails in the same manner as a programming operation on a protected sector. The Status Register will return to the ready state with the Program Status Bit set to 1 indicating a failed programming operation due to a locked sector. In this case it is a failure to change the state of the PPB Lock Bit because it is still protected by the lack of a valid password.
- The device requires approximately $t_{PSWD} = 100 \mu s$ for setting the PPB Lock Bit after the valid 64-bit password is given to the device.
- The Password Unlock command cannot be accepted any faster than once every t_{PSWD} (see Table 60 on page 89). This makes it take an unreasonably long time (58 million years) for a hacker to run through all the 64-bit combinations in an attempt to correctly match a password. The EA status checking methods may be used to determine when the EAC is ready to accept a new password command.
- If the password is lost after setting the Password Mode Lock Bit, there is no way to clear the PPB Lock Bit.

6.3.10 Read Password Protection Mode

The Read Password Mode can replace the default Section 6.3.9 Password Protection Mode on page 53. The Read Password Mode is enabled to replace the default PPB Password Protection Mode when the user programs $ASPR[5] = 0$. The Read Password Mode is not active until the password is programmed and $ASPR[2]$ is programmed to 0.

The Read Password Protection Mode enables protecting the Flash Memory Array from read, program and erase. Only the lowest or highest (256-KB) sector address range, selected by the Non-Volatile Configuration Register bits $xVCR[9:8]$, remains readable until a successful Password Unlock command is completed. Note that reads from the read-protected portion of the array will alias back to the readable sector.

In this mode the PPB Lock Bit is used to control the high order bits of address. When the PPB Lock Bit is 1, the address bits operate normally. When the PPB Lock Bit is 0, the address bits that select a main array sector address range are forced either to 0s ($xVCR[9:8] = 00$ or 10) or to 1s ($xVCR[9:8] = 01$ or 11) to select the lowest or highest address Flash Memory Array address range per the table below. When $xVCR[9:8] = 00$ or 10 , the bottom (zero address) 256 KB of the array is readable. When $xVCR[9:8] = 01$ or 10 , the top (maximum address) 256 KB of the array is readable.

Table 29. ASP Configuration Register Selection of Persistent and Password Protection Modes

| ASPR Bit | Default Value | Name |
|----------|---------------|--|
| 2 | 1 | Persistent / Password Protection Mode Lock Bits $ASPR[2:1] = 00$: Not Allowed $ASPR[2:1] = 01$: Password Mode Permanently Enabled $ASPR[2:1] = 10$: Persistent Mode Permanently Enabled $ASPR[2:1] = 11$: Persistent Mode Temporarily Enabled (default from factory) |
| 1 | 1 | |

Table 30. xVCR Mapping of Boot Block Address Range

| xVCR Bit | Default Value | Name |
|-------------|---------------|--|
| $xVCR[9:8]$ | 11 | 00 - Map Parameter-Sectors and Read Password Sectors mapped into lowest addresses. 01 - Map Parameter-Sectors and Read Password Sectors mapped into highest addresses. 10 - Uniform Sectors with Read Password Sector mapped into lowest addresses. 11 - Uniform Sectors with Read Password Sector mapped into highest addresses. |

The PPB bits are protected from program and erase when the PPB Lock Bit is 0 and may be programmed or erased when the PPB Lock Bit is 1.

The PPB Lock Bit is set to 0 by POR or Hardware Reset, same as in PPB Password Protection Mode.

Read Password Protection Notes

- When the Read Password OPN option is ordered, the user can program the ASPR[5] bit to 0 and use Read Password, or not, as desired.
- The command sequence for programming, reading, and locking of the Password for Read Password Method is the same as the default for the PPB Password Method.
- When the Read Password Mode and Password Protection Mode are enabled (i.e. ASPR[2] and ASPR[5] are programmed to 0), then all addresses are redirected to the Boot Sector until the password unlocking sequence is properly entered, with the correct password. At which time, the Read Password Mode is disabled and all addressing will select the proper location.
- If a system Hardware Reset occurs, then the Read Password Mode is re-enabled.
- ASPR[5] is used to select between Read Password versus PPB Password options. If ASPR[5] = 0 then the device is ready for Read Password. However, Read Password is not enabled until ASPR[2] = 0. At which point, all addresses select only within the top or bottom sectors, until the device is unlocked with the proper unlocking sequence and Password. When ASPR[2] = 1 the addresses select normally. This allows users to program in code, test it, provide a password, and then lock it by programming ASPR[2] = 0.
- The Read Password command sequence return undefined results if sent when Read Password Protection is in use. The PPB Lock Bit may only be returned to 0 by a Hardware Reset, POR or the PPB Lock Bit Clear command sequence.
- Only the ID Read command, Password Unlock command and array reads are valid during Read Password Mode while the PPB Lock Bit = 0. Other commands are disabled until the password is supplied to enable reading of the entire device and normal command operation.
- When Read Password Protection Mode is active (ASPR[5] = 0, ASPR[2] = 0, PPB Lock Bit = 0), reading of the main array is allowed but forced to have only the boot sector visible via the forcing of memory sector address to 0 or 1s. Reading the DYB, or PPB address space returns undefined data.
- Programming memory spaces or writing registers is not allowed when Read Password Protection Mode is active. RESET operates normally, and bus protocol may be modified by resetting mode bits.

6.3.11 Hybrid Burst

An additional type of burst that combines one wrapped burst followed by linear burst, is supported by all members of the HyperFlash family.

The beginning of a hybrid burst will wrap once within the target address wrapped burst length group, before switching to linear burst of data beyond the end of the initial wrapped burst length group. Hybrid burst is supported for 16-byte and 32-byte but not 64-byte wrapped burst length groups.

Table 31. ASPR Bit Assignment for Hybrid Burst Type Enable

| Bit | Default Value | Name |
|------|---------------|--|
| [11] | 1 | Hybrid Burst Type Enable 0 = Hybrid - One Wrapped burst sequence followed by linear burst 1 = Legacy - Wrapped burst sequence only |

Example burst sequences for 32-byte, and 16-byte Hybrid burst reads:

1. 32-byte example (wrap within 32-byte boundary before transitioning to linear burst)
 - a. 06-07-08-09-0A-0B-0C-0D-0E-0F-00-01-02-03-04-05-10-11
 - a. 0E-0F-00-01-02-03-04-05-06-07-08-09-0A-0B-0C-0D-10-11
2. 16-byte example (wrap within 16-byte boundary before transitioning to linear burst)
 - a. 06-07-00-01-02-03-04-05-08-09
 - b. 03-04-05-06-07-00-01-02-08-09

6.3.12 INT# Output

The INT# pin is an open-drain output used to indicate to the host system that an event has occurred within the flash device. The user can select to transition the INT# output pin to the active (Low) state when:

- Transitioning from the Busy to the Ready state
- 2-bit ECC error is detected
- Transitioning from the Busy to the Ready state

The interrupt sources are enabled by the interrupt configuration register

Operation is controlled with the Interrupt Configuration Register (ICR) where the INT# output (normally High) is enabled. The Interrupt Configuration Register determines when an internal event is enabled to trigger a High to Low transition on the INT# output pin. The Interrupt Status Register indicates what enabled internal event(s) have occurred since the last time the ISR has been cleared. If enabled, the INT# output pin will then transition from High to Low upon the occurrence of an enabled event. Once the host recognizes that INT# has transitioned to the Low state the Interrupt Status Register can be read to determine which internal event was responsible.

The INT# output can be forced to transition back to the high impedance state (returned High by an external pull-up resistance) using three methods:

- Disable the INT# output by loading a 1 into bit 15 of the Interrupt Configuration Register. The Interrupt Status Register will be cleared upon loading ICR[15] with a 1.
- Disable the event channel responsible for causing the output to transition Low by loading a 1 into the appropriate event enable bit in the Interrupt Configuration Register. The associated bit in the Interrupt Status Register will be cleared upon loading a 1 into the corresponding bit in the ICR.
- Reset the appropriate bit (by writing a 1) in the Interrupt Status Register bit that indicates which internal event occurred to cause the output to go Low. All Interrupt Status Register bits that are Low and are also enabled in the Interrupt Configuration Register must be reset before the INT# output will return High.

The INT# output will also be returned to the default (disabled, High-Z) state with a Hardware Reset (RESET# = Low) or a Power-On Reset. Hardware Reset and Power-On Reset disable all interrupts by setting the Interrupt Configuration Register back to the default (all interrupts disabled) state.

Table 32. Interrupt Configuration Register

| Bits | Function | Type | POR Default State | RESET# Default State | Description |
|--------|--------------------|---------------------------|-------------------|----------------------|---|
| [15] | INT# Output Enable | Volatile, Read / Write | 1 | 1 | 1 = INT# output disabled (High or Open-Drain) 0 = INT# output enabled, internal events will cause a High to Low transition |
| [14] | Reserved | | 1 | 1 | Reserved |
| [13:5] | Reserved | | 1 | 1 | Reserved for Future Use |
| [4] | READY | | 1 | 1 | 1 = Ready/Busy transitions will not transition the INT# output 0 = A Busy to Ready transition will cause a High to Low transition on the INT# output |
| [3] | Reserved | | 1 | 1 | Reserved for future use |
| [2] | Reserved | | 1 | 1 | Reserved for future use |
| [1] | 2-bit Error Detect | | 1 | 1 | 1 = 2-bit error detection will not transition the INT# output 0 = 2-bit error detection will cause a High to Low transition on the INT# output |
| [0] | 1-bit Error Detect | | 1 | 1 | 1 = 1-bit error detection will not transition the INT# output 0 = 1-bit error detection will cause a High to Low transition on the INT# output |

Note

62. Both POR and Hardware Reset results in all interrupt channels being disabled.

Table 33. Interrupt Status Register

| Bits | Function | Type | POR Default State | RESET# Default State | Description |
|-------------------------|--------------------|------------------------|-------------------|----------------------|--|
| [15:5] | Reserved | Volatile, Read / Write | 1 | 1 | Reserved for Future Use |
| [4] | READY | | 1 | 1 | 1 = A Busy to Ready transition has not occurred 0 = A Busy to Ready transition has occurred |
| [3] | Reserved | | 1 | 1 | Reserved for future use |
| [2] ^[65, 66] | POR Detect | | 0 | 1 | 1 = POR has not occurred 0 = POR has occurred |
| [1] | 2-bit Error Detect | | 1 | 1 | 1 = 2-bit error detection has not occurred 0 = 2-bit error detection has occurred |
| [0] | 1-bit Error Detect | | 1 | 1 | 1 = 1-bit error detection has not occurred 0 = 1-bit error detection has occurred |

Note

63. Hardware Reset results in all ISR bits being set to 1.

64. POR results in the ISR POR Detect bit (ISR[2]) being cleared to 0, all other bits to be set to 1.

65. ISR[2] is cleared (to 0) during POR and is only set (to 1) with a Hardware Reset (RESET# = 0) or with a write to the ISR.

66. The INT# output state is not affected by the value of ISR[2].

67. Writing to the ISR can only flip bits from the 0 to the 1 state. Only an interrupt occurrence flips an ISR bit from the 1 to the 0 state.

7. Device ID and Common Flash Interface (ID-CFI) ASO Map

7.1 Device ID and Common Flash Interface (ID-CFI) ASO Map — Standard

The Device ID portion of the ASO (word locations 0h to 0Fh) provides manufacturer ID, device ID and basic feature set information for the device. For additional information, see [Section 6.2.13.1 ID-CFI ASO](#) on page 41.

Table 34. ID (Autoselect) Address Map

| Word Address | Data | Description |
|--------------|--|-------------------------|
| (SA) + 0000h | 0001h | Cypress Manufacturer ID |
| (SA) + 0001h | 007Eh | Device ID |
| (SA) + 0002h | Reserved | RFU |
| (SA) + 0003h | Reserved | |
| (SA) + 0004h | Reserved | |
| (SA) + 0005h | Reserved | |
| (SA) + 0006h | Reserved | |
| (SA) + 0007h | Reserved | |
| (SA) + 0008h | Reserved | |
| (SA) + 0009h | Reserved | |
| (SA) + 000Ah | Reserved | |
| (SA) + 000Bh | Reserved | |
| (SA) + 000Ch | 0005h | |
| (SA) + 000Dh | Reserved | Upper Software Bits |
| (SA) + 000Eh | 0070h = 512 Mb @ 1.8V 006Fh = 512 Mb @ 3.0V 0072h = 256 Mb @ 1.8V 0071h = 256 Mb @ 3.0V 0074h = 128 Mb @ 1.8V 0073h = 128 Mb @ 3.0V | Device ID |
| (SA) + 000Fh | 0000h | Device ID |

Table 35. CFI Query Identification String

| Word Address | Data | Description |
|--|-------------------------|---|
| (SA) + 0010h (SA) + 0011h (SA) + 0012h | 0051h 0052h 0059h | Query Unique ASCII string "QRY" |
| (SA) + 0013h (SA) + 0014h | 0002h 0000h | Primary OEM Command Set |
| (SA) + 0015h (SA) + 0016h | 0040h 0000h | Address for Primary Extended Table |
| (SA) + 0017h (SA) + 0018h | 0000h 0000h | Alternate OEM Command Set (00h = none exists) |
| (SA) + 0019h (SA) + 001Ah | 0000h 0000h | Address for Alternate OEM Extended Table (00h = none exists) |

Table 36. CFI System Interface String

| Word Address | Data | Description |
|--------------|--|--|
| (SA) + 001Bh | 0017h for $V_{CC} = 1.8V$ 0027h for $V_{CC} = 3.0V$ | V_{CC} Min. (erase / program) (D7-D4: volts, D3-D0: 100 millivolts) |
| (SA) + 001Ch | 0019h for $V_{CC} = 1.8V$ 0036h for $V_{CC} = 3.0V$ | V_{CC} Max. (erase / program) (D7-D4: volts, D3-D0: 100 millivolts) |
| (SA) + 001Dh | 0000h | V_{PP} Min. voltage (00h = no V_{PP} pin present) |
| (SA) + 001Eh | 0000h | V_{PP} Max. voltage (00h = no V_{PP} pin present) |
| (SA) + 001Fh | 0009h | Typical timeout per single word write $2^N \mu s$ |
| (SA) + 0020h | 0009h | Typical timeout for max multi-byte program, $2^N \mu s$ (00h = not supported) |
| (SA) + 0021h | 000Ah | Typical timeout per individual block erase $2^N ms$ |
| (SA) + 0022h | 0012h (512 Mb) 0011h (256 Mb) 0010h (128 Mb) | Typical timeout for full chip erase $2^N ms$ (00h = not supported) |
| (SA) + 0023h | 0002h | Max. timeout for single word write 2^N times typical |
| (SA) + 0024h | 0002h | Max. timeout for buffer write 2^N times typical |
| (SA) + 0025h | 0002h | Max. timeout per individual block erase 2^N times typical |
| (SA) + 0026h | 0002h | Max. timeout for full chip erase 2^N times typical (00h = not supported) |

Table 37. CFI Device Geometry Definition

| Word Address | Data | Description |
|--------------|--|--|
| (SA) + 0027h | 001Ah (512 Mb) 0019h (256 Mb) 0018h (128 Mb) | Device Size = 2 ^N byte |
| (SA) + 0028h | 0000h | Flash Device Interface Description 0 = x8-only, 1 = x16-only, 2 = x8 / x16 capable |
| (SA) + 0029h | 0000h | |
| (SA) + 002Ah | 0009h | Max. number of byte in multi-byte write = 2 ^N (00 = not supported) |
| (SA) + 002Bh | 0000h | |
| (SA) + 002Ch | 0001h | Number of Erase Block Regions within device 1 = Uniform Device, 2 = Boot Device |
| (SA) + 002Dh | See Description | Erase Block Region 1 Information (refer to JEDEC JESD68-01 or JEP137 specifications) 00FFh, 0000h, 0000h, 0004h = 512 Mb (256 x 2-Mb blocks) 007Fh, 0000h, 0000h, 0004h = 256 Mb (128 x 2-Mb blocks) 003Fh, 0000h, 0000h, 0004h = 128 Mb (64 x 2-Mb blocks) |
| (SA) + 002Eh | | |
| (SA) + 002Fh | | |
| (SA) + 0030h | | |
| (SA) + 0031h | 0000h | Erase Block Region 2 Information (refer to JEDEC JESD68-01 or JEP137 specifications) |
| (SA) + 0032h | 0000h | |
| (SA) + 0033h | 0000h | |
| (SA) + 0034h | 0000h | |
| (SA) + 0035h | 0000h | Erase Block Region 3 Information (refer to JEDEC JESD68-01 or JEP137 specifications) |
| (SA) + 0036h | 0000h | |
| (SA) + 0037h | 0000h | |
| (SA) + 0038h | 0000h | |
| (SA) + 0039h | 0000h | Erase Block Region 4 Information (refer to JEDEC JESD68-01 or JEP137 specifications) |
| (SA) + 003Ah | 0000h | |
| (SA) + 003Bh | 0000h | |
| (SA) + 003Ch | 0000h | |

Table 38. CFI Primary Vendor-Specific Extended Query

| Word Address | Data | Description |
|--------------|-------|---|
| (SA) + 0040h | 0050h | Query-unique ASCII string "PRI" |
| (SA) + 0041h | 0052h | |
| (SA) + 0042h | 0049h | |
| (SA) + 0043h | 0031h | Major version number, ASCII |
| (SA) + 0044h | 0035h | Minor version number, ASCII |
| (SA) + 0045h | 001Ch | Address Sensitive Unlock (Bits 1-0) 00b = Required, 01b = Not Required Process Technology (Bits 5-2) 0000b = 0.23 μ m Floating Gate 0001b = 0.17 μ m Floating Gate 0010b = 0.23 μ m MirrorBit 0011b = 0.13 μ m Floating Gate 0100b = 0.11 μ m MirrorBit 0101b = 0.09 μ m Floating Gate 0110b = 0.09 μ m MirrorBit 0111b = 0.065 μ m MirrorBit Eclipse 1000b = 0.065 μ m MirrorBit 1001b = 0.045 μ m MirrorBit |
| (SA) + 0046h | 0002h | Erase Suspend 0 = Not Supported 1 = Read Only 2 = Read and Write |
| (SA) + 0047h | 0001h | Sector Protect 00 = Not Supported X = Number of sectors in smallest group |
| (SA) + 0048h | 0000h | Temporary Sector Unprotect 00 = Not Supported 01 = Supported |
| (SA) + 0049h | 0008h | Sector Protect / Unprotect Scheme 04 = High Voltage Method 05 = Software Command Locking Method 08 = Advanced Sector Protection Method |
| (SA) + 004Ah | 0000h | Simultaneous Operation 00 = Not Supported X = Number of banks |
| (SA) + 004Bh | 0001h | Burst Mode Type 00 = Not Supported 01 = Supported |
| (SA) + 004Ch | 0000h | Page Read Mode Type 00 = Not Supported 01 = 4 Word Page 02 = 8 Word Page 03 = 16 Word Page |
| (SA) + 004Dh | 0000h | ACC (Acceleration) Supply Minimum 00 = Not Supported D7-D4: Volt D3-D0: 100 mV |
| (SA) + 004Eh | 0000h | ACC (Acceleration) Supply Maximum 00 = Not Supported D7-D4: Volt D3-D0: 100 mV |
| (SA) + 004Fh | 0000h | WP# Protection 00h = Flash device without WP Protect (No Boot) 01h = Eight 8-KB Sectors at TOP and Bottom with WP (Dual Boot) 02h = Bottom Boot Device with WP Protect (Bottom Boot) 03h = Top Boot Device with WP Protect (Top Boot) 04h = Uniform, Bottom WP Protect (Uniform Bottom Boot) 05h = Uniform, Top WP Protect (Uniform Top Boot) 06h = WP Protect for all sectors 07h = Uniform, Top or Bottom WP Protect |

Table 38. CFI Primary Vendor-Specific Extended Query (Continued)

| Word Address | Data | Description |
|---------------------------------|-------|--|
| (SA) + 0050h | 0001h | Program Suspend 00 = Not Supported 01 = Supported |
| (SA) + 0051h | 0000h | Unlock Bypass 00 = Not Supported 01 = Supported |
| (SA) + 0052h | 000Ah | Secure Silicon Sector (Customer OTP Area = 1024B) Size 2^N (bytes) |
| (SA) + 0053h | 008Dh | Software Features Bit 0: Status Register polling (1 = Supported, 0 = Not Supported) Bit 1: DQ polling (1 = Supported, 0 = Not Supported) Bit 2: New Program Suspend / Resume commands (1 = Supported, 0 = Not Supported) Bit 3: Word Programming (1 = Supported, 0 = Not Supported) Bit 4: Bit-Field Programming (1 = Supported, 0 = Not Supported) Bit 5: Autodetect Programming (1 = Supported, 0 = Not Supported) Bit 6: RFU Bit 7: Multiple Writes per Line (1 = Supported, 0 = Not Supported) |
| (SA) + 0054h | 0005h | Page Size = 2^N bytes |
| (SA) + 0055h | 0006h | Erase Suspend Timeout Maximum < 2^N (μ s) |
| (SA) + 0056h | 0006h | Program Suspend Timeout Maximum < 2^N (μ s) |
| (SA) + 0057h to (SA) + 0077h | FFFFh | Reserved for Future Use |
| (SA) + 0078h | 0006h | Embedded Hardware Reset Timeout Maximum < 2^N (μ s) Reset with Reset Pin |
| (SA) + 0079h | 0009h | Non-Embedded Hardware Reset Timeout Maximum < 2^N (μ s) Power-On Reset |

7.2 Device ID and Common Flash Interface (ID-CFI) ASO Map — Automotive Grade / AEC-Q100

The CFI Primary Vendor-Specific Extended Query for Automotive Grade / AEC-Q100 is extended to include Electronic Marking information for device traceability (see [Table 39](#)).

Table 39. Device ID and Common Flash Interface (ID-CFI) ASO Map^[68]

| Word Address | Data Field | Number of Bytes | Data Format | Example of Actual of Data | Hex Read Out of Example Data |
|--------------|--------------------------------|-----------------|-------------|---------------------------|---|
| (SA) + 0080h | Size of Electronic Marking | 1 | Hex | 19 | 0013h |
| (SA) + 0081h | Revision of Electronic Marking | 1 | Hex | 1 | 0001h |
| (SA) + 0082h | Fab Lot # | 7 | ASCII | LD87270 | 004Ch, 0044h, 0038h, 0037h, 0032h, 0037h, 0030h |
| (SA) + 0089h | Wafer # | 1 | Hex | 23 | 0017h |
| (SA) + 008Ah | Die X Coordinate | 1 | Hex | 10 | 000Ah |
| (SA) + 008Bh | Die Y Coordinate | 1 | Hex | 15 | 000Fh |
| (SA) + 008Ch | Class Lot # | 7 | ASCII | BR33150 | 0042h, 0052h, 0033h, 0033h, 0031h, 0035h, 0030h |
| (SA) + 0093h | Reserved for Future | 13 | NA | NA | Undefined |

Note

68. Fab Lot # + Wafer # + Die X Coordinate + Die Y Coordinate provides unique ID for each device.

8. Software Interface Reference

8.1 Command Summary

Table 40. Command Definitions

| Command Sequence | Cycles | Bus Cycles ^[69, 70, 71, 72] | | | | | | | | | | | | | |
|---|--------|--|------|--------|------|-------|------|--------|---------------|-------|------|-------|------|---------|------|
| | | First | | Second | | Third | | Fourth | | Fifth | | Sixth | | Seventh | |
| | | Addr | Data | Addr | Data | Addr | Data | Addr | Data | Addr | Data | Addr | Data | Addr | Data |
| Read ^[72] | 1 | RA | RD | | | | | | | | | | | | |
| Reset / ASO Exit ^[73, 82] | 1 | XXX | F0 | | | | | | | | | | | | |
| Status Register Read ^[84] | 2 | 555 | 70 | XXX | RD | | | | | | | | | | |
| Status Register Clear | 1 | 555 | 71 | | | | | | | | | | | | |
| Enter Deep Power-Down | 3 | 555 | AA | 2AA | 55 | XXX | B9 | | | | | | | | |
| Program Power-On Reset Timer Register | 4 | 555 | AA | 2AA | 55 | 555 | 34 | XXX | PORTime | | | | | | |
| Read Power-On Reset Timer Register | 4 | 555 | AA | 2AA | 55 | 555 | 3C | XXX | RD PORTime | | | | | | |
| Load Interrupt Configuration Register | 4 | 555 | AA | 2AA | 55 | 555 | 36 | XXX | ICR | | | | | | |
| Read Interrupt Configuration Register | 4 | 555 | AA | 2AA | 55 | 555 | C4 | XXX | RD ICR | | | | | | |
| Load Interrupt Status Register | 4 | 555 | AA | 2AA | 55 | 555 | 37 | XXX | ISR | | | | | | |
| Read Interrupt Status Register | 4 | 555 | AA | 2AA | 55 | 555 | C5 | XXX | RD ISR | | | | | | |
| Load Volatile Configuration Register | 4 | 555 | AA | 2AA | 55 | 555 | 38 | XXX | VCR | | | | | | |
| Read Volatile Configuration Register | 4 | 555 | AA | 2AA | 55 | 555 | C7 | XXX | RD VCR | | | | | | |
| Program Non-Volatile Configuration Register | 4 | 555 | AA | 2AA | 55 | 555 | 39 | XXX | NVCR | | | | | | |
| Erase Non-Volatile Configuration Register | 3 | 555 | AA | 2AA | 55 | 555 | C8 | | | | | | | | |

Notes

69. All values are in hexadecimal. All addresses reference 16-bit words.
70. Except for the following, all bus cycles are write cycle: read cycle during Read, ID/CFI Read (Manufacturing ID / Device ID), Indicator Bits, Secure Silicon Region Read, SSR Lock Read, and 2nd cycle of Status Register Read.
71. Data bits DQ15-DQ8 are 'don't care' in command sequences, except for RD, PD, WC and PWD.
72. Address bits A_{MAX}-A11 are 'don't care' for unlock and command cycles, unless SA or PA required. (A_{MAX} is the Highest Address pin.)
73. No unlock or command cycles required when reading array data.
74. The Reset command is required to return to reading array data when device is in the ID-CFI (Autoselect) Mode, or if DQ5 goes High (while the device is providing status data).
75. Command is valid when device is ready to read array data or when device is in ID-CFI (Autoselect) Mode.
76. The system can read and program / program suspend in non-erasing sectors, or enter the ID-CFI ASO, when in the Erase Suspend Mode. The Erase Suspend command is valid only during a sector erase operation.
77. The Erase Resume / Program Resume command is valid only during the Erase Suspend / Program Suspend Modes.
78. Issue this command sequence to return to READ Mode after detecting device is in a Write-to-Buffer-Abort state. Note that the full command sequence is required if resetting out of ABORT.
79. The Exit command returns the device to reading the array.
80. For PWDx, only one portion of the password can be programmed per each 'A0' command. Portions of the password must be programmed in sequential order (PWD0-PWD3).
81. All ASP Register bits are one-time programmable. The program state = 0 and the erase state = 1. Both the Persistent Protection Mode Lock Bit and the Password Protection Mode Lock Bit cannot be programmed at the same time or the ASPR Register Bits Program operation aborts and returns the device to Read Mode. ASPR Register bits that are reserved for future use are undefined and may be 0's or 1's.
82. If any of the Entry commands was issued, an Exit command must be issued to reset the device into Read Mode.
83. Bit 0 = 0 indicates the Protected State, Bit 0 = 1 indicates the Unprotected State. Bits 1 through 15 are all 1s. The sector address for DYB set, DYB clear, or PPB Program command may be any location within the sector; the lower order bits of the sector address are 'don't care'.
84. Data out during a Status Register Read transaction, DYB Read, PPB Read, SA Protection Read, Password Read, POR Timer Read, ICR Read, ISR Read, VCR Read, NVCR Read, FIDR Read, ASPR Read, PPBL Read Register Read transactions is only valid during the first word output by the device. Subsequent data values output if CK/CK# continue to toggle while CS# remains Low are undefined.
85. Data out during a SA Protection Status Read indicates whether the indicated sector is protected in bits 0-2.
 Bit 0 – Indicates whether the indicated sector is protected (0 = protected, 1 = unprotected).
 Bit 1 – Protected using the sector's DYB bit (0 = protected, 1 = unprotected).
 Bit 2 – Protected using the sector's PPB bit (0 = protected, 1 = unprotected).
 Bits 3 through 15 are all 1s.
86. The smaller parameter-sectors need to include A[16:11] as part of the address identifying the target parameter-sector during erase and program command sequences.
87. Both the ID (Autoselect) Entry and the CFI Entry allows access to the same ID/CFI data set. All data contained in within the ID/CFI data set is available after using either the ID or CFI Entry sequences.

Table 40. Command Definitions (Continued)

| Command Sequence | Cycles | Bus Cycles ^[69, 70, 71, 72] | | | | | | | | | | | | | |
|---|--------------------------------------|--|----------|----------|------|-------|----------|--------|---------|-------|------|-------|------|---------|------|
| | | First | | Second | | Third | | Fourth | | Fifth | | Sixth | | Seventh | |
| | | Addr | Data | Addr | Data | Addr | Data | Addr | Data | Addr | Data | Addr | Data | Addr | Data |
| Read Non-Volatile Configuration Register | 4 | 555 | AA | 2AA | 55 | 555 | C6 | XXX | RD NVCR | | | | | | |
| Word Program | 4 | 555 | AA | 2AA | 55 | 555 | A0 | PA | PD | | | | | | |
| Write to Buffer ^[86] | 6 | 555 | AA | 2AA | 55 | SA | 25 | SA | WC | WBL | PD | WBL | PD | | |
| Program Buffer to Flash (confirm) | 1 | SA | 29 | | | | | | | | | | | | |
| Write-to-Buffer-Abort Reset ^[78] | 3 | 555 | AA | 2AA | 55 | 555 | F0 | | | | | | | | |
| Chip Erase | 6 | 555 | AA | 2AA | 55 | 555 | 80 | 555 | AA | 2AA | 55 | 555 | 10 | | |
| Sector Erase ^[86] | 6 | 555 | AA | 2AA | 55 | 555 | 80 | 555 | AA | 2AA | 55 | SA | 30 | | |
| Blank Check | 1 | (SA) 555 | 33 | | | | | | | | | | | | |
| Evaluate Erase Status | 1 | (SA) 555 | D0 | | | | | | | | | | | | |
| Erase Suspend ^[76, 77] | 1 | XXX | B0 | | | | | | | | | | | | |
| Erase Resume ^[76, 77] | 1 | XXX | 30 | | | | | | | | | | | | |
| Program Suspend ^[76, 77] | 1 | XXX | 51 | | | | | | | | | | | | |
| Program Resume ^[76, 77] | 1 | XXX | 50 | | | | | | | | | | | | |
| ID-CFI (Autoselect) ASO ^[87] | ID (Autoselect) Entry | 3 | 555 | AA | 2AA | 55 | (SA) 555 | 90 | | | | | | | |
| | CFI Enter ^[75] | 1 | (SA) 555 | 98 | | | | | | | | | | | |
| | ID-CFI Read | 1 | (SA) RA | RD | | | | | | | | | | | |
| | Reset / ASO Exit ^[74, 82] | 1 | XXX | F0 or FF | | | | | | | | | | | |

Notes

- 69. All values are in hexadecimal. All addresses reference 16-bit words.
- 70. Except for the following, all bus cycles are write cycle: read cycle during Read, ID/CFI Read (Manufacturing ID / Device ID), Indicator Bits, Secure Silicon Region Read, SSR Lock Read, and 2nd cycle of Status Register Read.
- 71. Data bits DQ15-DQ8 are 'don't care' in command sequences, except for RD, PD, WC and PWD.
- 72. Address bits A_{MAX}-A11 are 'don't care' for unlock and command cycles, unless SA or PA required. (A_{MAX} is the Highest Address pin.)
- 73. No unlock or command cycles required when reading array data.
- 74. The Reset command is required to return to reading array data when device is in the ID-CFI (Autoselect) Mode, or if DQ5 goes High (while the device is providing status data).
- 75. Command is valid when device is ready to read array data or when device is in ID-CFI (Autoselect) Mode.
- 76. The system can read and program / program suspend in non-erasing sectors, or enter the ID-CFI ASO, when in the Erase Suspend Mode. The Erase Suspend command is valid only during a sector erase operation.
- 77. The Erase Resume / Program Resume command is valid only during the Erase Suspend / Program Suspend Modes.
- 78. Issue this command sequence to return to READ Mode after detecting device is in a Write-to-Buffer-Abort state. Note that the full command sequence is required if resetting out of ABORT.
- 79. The Exit command returns the device to reading the array.
- 80. For PWDx, only one portion of the password can be programmed per each 'A0' command. Portions of the password must be programmed in sequential order (PWD0-PWD3).
- 81. All ASP Register bits are one-time programmable. The program state = 0 and the erase state = 1. Both the Persistent Protection Mode Lock Bit and the Password Protection Mode Lock Bit cannot be programmed at the same time or the ASPR Register Bits Program operation aborts and returns the device to Read Mode. ASPR Register bits that are reserved for future use are undefined and may be 0's or 1's.
- 82. If any of the Entry commands was issued, an Exit command must be issued to reset the device into Read Mode.
- 83. Bit 0 = 0 indicates the Protected State, Bit 0 = 1 indicates the Unprotected State. Bits 1 through 15 are all 1s. The sector address for DYB set, DYB clear, or PPB Program command may be any location within the sector; the lower order bits of the sector address are 'don't care'.
- 84. Data out during a Status Register Read transaction, DYB Read, PPB Read, SA Protection Read, Password Read, POR Timer Read, ICR Read, ISR Read, VCR Read, NVCR Read, FIDR Read, ASPR Read, PPBL Read Register Read transactions is only valid during the first word output by the device. Subsequent data values output if CK/CK# continue to toggle while CS# remains Low are undefined.
- 85. Data out during a SA Protection Status Read indicates whether the indicated sector is protected in bits 0-2.
 Bit 0 – Indicates whether the indicated sector is protected (0 = protected, 1 = unprotected).
 Bit 1 – Protected using the sector's DYB bit (0 = protected, 1 = unprotected).
 Bit 2 – Protected using the sector's PPB bit (0 = protected, 1 = unprotected).
 Bits 3 through 15 are all 1s.
- 86. The smaller parameter-sectors need to include A[16:11] as part of the address identifying the target parameter-sector during erase and program command sequences.
- 87. Both the ID (Autoselect) Entry and the CFI Entry allows access to the same ID/CFI data set. All data contained in within the ID/CFI data set is available after using either the ID or CFI Entry sequences.

Table 40. Command Definitions (Continued)

| Command Sequence | | Cycles | Bus Cycles ^[69, 70, 71, 72] | | | | | | | | | | | | | |
|--|---|--------|--|------|--------|------|-------------|------|--------|------|-------|------|-------|------|---------|------|
| | | | First | | Second | | Third | | Fourth | | Fifth | | Sixth | | Seventh | |
| | | | Addr | Data | Addr | Data | Addr | Data | Addr | Data | Addr | Data | Addr | Data | Addr | Data |
| Secure Silicon Region Command Definitions | | | | | | | | | | | | | | | | |
| Secure Silicon Region (SSR) ASO | SSR Entry | 3 | 555 | AA | 2AA | 55 | (SA) 555 | 88 | | | | | | | | |
| | Read ^[73] | 1 | RA | RD | | | | | | | | | | | | |
| | Word Program | 4 | 555 | AA | 2AA | 55 | 555 | A0 | PA | PD | | | | | | |
| | Write to Buffer | 6 | 555 | AA | 2AA | 55 | SA | 25 | SA | WC | WBL | PD | WBL | PD | | |
| | Program Buffer to Flash (confirm) | 1 | SA | 29 | | | | | | | | | | | | |
| | Write-to-Buffer-Abort Reset ^[76] | 3 | 555 | AA | 2AA | 55 | 555 | F0 | | | | | | | | |
| | SSR Exit ^[78] | 4 | 555 | AA | 2AA | 55 | 555 | 90 | XX | 00h | | | | | | |
| | Reset / ASO Exit ^[74, 82] | 1 | XXX | F0 | | | | | | | | | | | | |
| ASP Config. Register (ASPR) ASO ^[81] | ASP Register Entry | 3 | 555 | AA | 2AA | 55 | 555 | 40 | | | | | | | | |
| | Program | 2 | XXX | A0 | XXX | PD | | | | | | | | | | |
| | ASPR Read ^[84] | 1 | 0 | RD | | | | | | | | | | | | |
| | ASPR ASO Exit ^[65, 66] | 2 | XXX | 90 | XXX | 0 | | | | | | | | | | |
| | Reset / ASO Exit ^[74, 82] | 1 | XXX | F0 | | | | | | | | | | | | |

Notes

- 69. All values are in hexadecimal. All addresses reference 16-bit words.
- 70. Except for the following, all bus cycles are write cycle: read cycle during Read, ID/CFI Read (Manufacturing ID / Device ID), Indicator Bits, Secure Silicon Region Read, SSR Lock Read, and 2nd cycle of Status Register Read.
- 71. Data bits DQ15-DQ8 are 'don't care' in command sequences, except for RD, PD, WC and PWD.
- 72. Address bits A_{MAX}-A11 are 'don't care' for unlock and command cycles, unless SA or PA required. (A_{MAX} is the Highest Address pin.)
- 73. No unlock or command cycles required when reading array data.
- 74. The Reset command is required to return to reading array data when device is in the ID-CFI (Autoselect) Mode, or if DQ5 goes High (while the device is providing status data).
- 75. Command is valid when device is ready to read array data or when device is in ID-CFI (Autoselect) Mode.
- 76. The system can read and program / program suspend in non-erasing sectors, or enter the ID-CFI ASO, when in the Erase Suspend Mode. The Erase Suspend command is valid only during a sector erase operation.
- 77. The Erase Resume / Program Resume command is valid only during the Erase Suspend / Program Suspend Modes.
- 78. Issue this command sequence to return to READ Mode after detecting device is in a Write-to-Buffer-Abort state. Note that the full command sequence is required if resetting out of ABORT.
- 79. The Exit command returns the device to reading the array.
- 80. For PWDx, only one portion of the password can be programmed per each 'A0' command. Portions of the password must be programmed in sequential order (PWD0-PWD3).
- 81. All ASP Register bits are one-time programmable. The program state = 0 and the erase state = 1. Both the Persistent Protection Mode Lock Bit and the Password Protection Mode Lock Bit cannot be programmed at the same time or the ASPR Register Bits Program operation aborts and returns the device to Read Mode. ASPR Register bits that are reserved for future use are undefined and may be 0's or 1's.
- 82. If any of the Entry commands was issued, an Exit command must be issued to reset the device into Read Mode.
- 83. Bit 0 = 0 indicates the Protected State, Bit 0 = 1 indicates the Unprotected State. Bits 1 through 15 are all 1s. The sector address for DYB set, DYB clear, or PPB Program command may be any location within the sector; the lower order bits of the sector address are 'don't care'.
- 84. Data out during a Status Register Read transaction, DYB Read, PPB Read, SA Protection Read, Password Read, POR Timer Read, ICR Read, ISR Read, VCR Read, NVCR Read, FIDR Read, ASPR Read, PPBL Read Register Read transactions is only valid during the first word output by the device. Subsequent data values output if CK/CK# continue to toggle while CS# remains Low are undefined.
- 85. Data out during a SA Protection Status Read indicates whether the indicated sector is protected in bits 0-2.
 Bit 0 – Indicates whether the indicated sector is protected (0 = protected, 1 = unprotected).
 Bit 1 – Protected using the sector's DYB bit (0 = protected, 1 = unprotected).
 Bit 2 – Protected using the sector's PPB bit (0 = protected, 1 = unprotected).
 Bits 3 through 15 are all 1s.
- 86. The smaller parameter-sectors need to include A[16:11] as part of the address identifying the target parameter-sector during erase and program command sequences.
- 87. Both the ID (Autoselect) Entry and the CFI Entry allows access to the same ID/CFI data set. All data contained in within the ID/CFI data set is available after using either the ID or CFI Entry sequences.

Table 40. Command Definitions (Continued)

| Command Sequence | | Cycles | Bus Cycles ^[69, 70, 71, 72] | | | | | | | | | | | | | |
|---|--|--------|--|--------|--------|------|-------|------|--------|------|-------|------|-------|-------|---------|------|
| | | | First | | Second | | Third | | Fourth | | Fifth | | Sixth | | Seventh | |
| | | | Addr | Data | Addr | Data | Addr | Data | Addr | Data | Addr | Data | Addr | Data | Addr | Data |
| Password Protection Command Set Definitions | | | | | | | | | | | | | | | | |
| Password ASO | Password ASO Entry | 3 | 555 | AA | 2AA | 55 | 555 | 60 | | | | | | | | |
| | Program ^[80] | 2 | XXX | A0 | PWA x | PWDx | | | | | | | | | | |
| | Read | 4 | 0 | PWD0 | 1 | PWD1 | 2 | PWD2 | 3 | PWD3 | | | | | | |
| | Unlock | 7 | 0 | 25 | 0 | 3 | 0 | PWD0 | 1 | PWD1 | 2 | PWD2 | 3 | PWD 3 | 0 | 29 |
| | Command Set Exit ^[79, 82] | 2 | XXX | 90 | XXX | 0 | | | | | | | | | | |
| | Reset / ASO Exit ^[74, 82] | 1 | XXX | F0 | | | | | | | | | | | | |
| Non-Volatile Sector Protection Command Set Definitions | | | | | | | | | | | | | | | | |
| PPB (Non-Volatile Sector Protection) | PPB Entry | 3 | 555 | AA | 2AA | 55 | 555 | C0 | | | | | | | | |
| | PPB Program ^[83] | 2 | XXX | A0 | SA | 0 | | | | | | | | | | |
| | All PPB Erase ^[83] | 2 | XXX | 80 | 0 | 30 | | | | | | | | | | |
| | PPB Read ^[83, 84] | 1 | SA | RD (0) | | | | | | | | | | | | |
| | SA Protection Status ^[84, 85] | 2 | XXX | 60 | SA | RD | | | | | | | | | | |
| | Command Set Exit ^[79, 82] | 2 | XXX | 90 | XXX | 0 | | | | | | | | | | |
| | Reset / ASO Exit ^[74, 82] | 1 | XXX | F0 | | | | | | | | | | | | |
| Global Non-Volatile Sector Protection Freeze Command Set Definitions | | | | | | | | | | | | | | | | |

Notes

69. All values are in hexadecimal. All addresses reference 16-bit words.
70. Except for the following, all bus cycles are write cycle: read cycle during Read, ID/CFI Read (Manufacturing ID / Device ID), Indicator Bits, Secure Silicon Region Read, SSR Lock Read, and 2nd cycle of Status Register Read.
71. Data bits DQ15-DQ8 are 'don't care' in command sequences, except for RD, PD, WC and PWD.
72. Address bits A_{MAX}-A11 are 'don't care' for unlock and command cycles, unless SA or PA required. (A_{MAX} is the Highest Address pin.)
73. No unlock or command cycles required when reading array data.
74. The Reset command is required to return to reading array data when device is in the ID-CFI (Autoselect) Mode, or if DQ5 goes High (while the device is providing status data).
75. Command is valid when device is ready to read array data or when device is in ID-CFI (Autoselect) Mode.
76. The system can read and program / program suspend in non-erasing sectors, or enter the ID-CFI ASO, when in the Erase Suspend Mode. The Erase Suspend command is valid only during a sector erase operation.
77. The Erase Resume / Program Resume command is valid only during the Erase Suspend / Program Suspend Modes.
78. Issue this command sequence to return to READ Mode after detecting device is in a Write-to-Buffer-Abort state. Note that the full command sequence is required if resetting out of ABORT.
79. The Exit command returns the device to reading the array.
80. For PWDx, only one portion of the password can be programmed per each 'A0' command. Portions of the password must be programmed in sequential order (PWD0-PWD3).
81. All ASP Register bits are one-time programmable. The program state = 0 and the erase state = 1. Both the Persistent Protection Mode Lock Bit and the Password Protection Mode Lock Bit cannot be programmed at the same time or the ASPR Register Bits Program operation aborts and returns the device to Read Mode. ASPR Register bits that are reserved for future use are undefined and may be 0's or 1's.
82. If any of the Entry commands was issued, an Exit command must be issued to reset the device into Read Mode.
83. Bit 0 = 0 indicates the Protected State, Bit 0 = 1 indicates the Unprotected State. Bits 1 through 15 are all 1s. The sector address for DYB set, DYB clear, or PPB Program command may be any location within the sector; the lower order bits of the sector address are 'don't care'.
84. Data out during a Status Register Read transaction, DYB Read, PPB Read, SA Protection Read, Password Read, POR Timer Read, ICR Read, ISR Read, VCR Read, NVCR Read, FIDR Read, ASPR Read, PPBL Read Register Read transactions is only valid during the first word output by the device. Subsequent data values output if CK/CK# continue to toggle while CS# remains Low are undefined.
85. Data out during a SA Protection Status Read indicates whether the indicated sector is protected in bits 0-2.
 Bit 0 – Indicates whether the indicated sector is protected (0 = protected, 1 = unprotected).
 Bit 1 – Protected using the sector's DYB bit (0 = protected, 1 = unprotected).
 Bit 2 – Protected using the sector's PPB bit (0 = protected, 1 = unprotected).
 Bits 3 through 15 are all 1s.
86. The smaller parameter-sectors need to include A[16:11] as part of the address identifying the target parameter-sector during erase and program command sequences.
87. Both the ID (Autoselect) Entry and the CFI Entry allows access to the same ID/CFI data set. All data contained in within the ID/CFI data set is available after using either the ID or CFI Entry sequences.

Table 40. Command Definitions (Continued)

| Command Sequence | | Cycles | Bus Cycles ^[69, 70, 71, 72] | | | | | | | | | | | | | |
|---|--|--------|--|--------|--------|------|-------|------|--------|------|-------|------|-------|------|---------|------|
| | | | First | | Second | | Third | | Fourth | | Fifth | | Sixth | | Seventh | |
| | | | Addr | Data | Addr | Data | Addr | Data | Addr | Data | Addr | Data | Addr | Data | Addr | Data |
| PPB Lock Bit | PPB Lock Entry | 3 | 555 | AA | 2AA | 55 | 555 | 50 | | | | | | | | |
| | PPB Lock Bit Clear | 2 | XXX | A0 | XXX | 0 | | | | | | | | | | |
| | PPB Lock Status Read ^[84] | 1 | XXX | RD (0) | | | | | | | | | | | | |
| | Command Set Exit ^[79, 82] | 2 | XXX | 90 | XXX | 0 | | | | | | | | | | |
| | Reset / ASO Exit ^[82] | 1 | XXX | F0 | | | | | | | | | | | | |
| Volatile Sector Protection Command Set Definitions | | | | | | | | | | | | | | | | |
| DYB (Volatile Sector Protection) ASO | DYB ASO Entry | 3 | 555 | AA | 2AA | 55 | 555 | E0 | | | | | | | | |
| | DYB Set ^[83] | 2 | XXX | A0 | SA | 0 | | | | | | | | | | |
| | DYB Clear ^[83] | 2 | XXX | A0 | SA | 1 | | | | | | | | | | |
| | DYB Status Read ^[84] | 1 | SA | RD (0) | | | | | | | | | | | | |
| | SA Protection Status ^[83, 84, 85] | 2 | XXX | 60 | SA | RD | | | | | | | | | | |
| | Command Set Exit ^[79, 82] | 2 | XXX | 90 | XXX | 0 | | | | | | | | | | |
| | Reset / ASO Exit ^[82] | 1 | XXX | F0 | | | | | | | | | | | | |

Notes

- 69. All values are in hexadecimal. All addresses reference 16-bit words.
- 70. Except for the following, all bus cycles are write cycle: read cycle during Read, ID/CFI Read (Manufacturing ID / Device ID), Indicator Bits, Secure Silicon Region Read, SSR Lock Read, and 2nd cycle of Status Register Read.
- 71. Data bits DQ15-DQ8 are 'don't care' in command sequences, except for RD, PD, WC and PWD.
- 72. Address bits A_{MAX}-A11 are 'don't care' for unlock and command cycles, unless SA or PA required. (A_{MAX} is the Highest Address pin.)
- 73. No unlock or command cycles required when reading array data.
- 74. The Reset command is required to return to reading array data when device is in the ID-CFI (Autoselect) Mode, or if DQ5 goes High (while the device is providing status data).
- 75. Command is valid when device is ready to read array data or when device is in ID-CFI (Autoselect) Mode.
- 76. The system can read and program / program suspend in non-erasing sectors, or enter the ID-CFI ASO, when in the Erase Suspend Mode. The Erase Suspend command is valid only during a sector erase operation.
- 77. The Erase Resume / Program Resume command is valid only during the Erase Suspend / Program Suspend Modes.
- 78. Issue this command sequence to return to READ Mode after detecting device is in a Write-to-Buffer-Abort state. Note that the full command sequence is required if resetting out of ABORT.
- 79. The Exit command returns the device to reading the array.
- 80. For PWDx, only one portion of the password can be programmed per each 'A0' command. Portions of the password must be programmed in sequential order (PWD0-PWD3).
- 81. All ASP Register bits are one-time programmable. The program state = 0 and the erase state = 1. Both the Persistent Protection Mode Lock Bit and the Password Protection Mode Lock Bit cannot be programmed at the same time or the ASPR Register Bits Program operation aborts and returns the device to Read Mode. ASPR Register bits that are reserved for future use are undefined and may be 0's or 1's.
- 82. If any of the Entry commands was issued, an Exit command must be issued to reset the device into Read Mode.
- 83. Bit 0 = 0 indicates the Protected State, Bit 0 = 1 indicates the Unprotected State. Bits 1 through 15 are all 1s. The sector address for DYB set, DYB clear, or PPB Program command may be any location within the sector; the lower order bits of the sector address are 'don't care'.
- 84. Data out during a Status Register Read transaction, DYB Read, PPB Read, SA Protection Read, Password Read, POR Timer Read, ICR Read, ISR Read, VCR Read, NVCR Read, FIDR Read, ASPR Read, PPBL Read Register Read transactions is only valid during the first word output by the device. Subsequent data values output if CK/CK# continue to toggle while CS# remains Low are undefined.
- 85. Data out during a SA Protection Status Read indicates whether the indicated sector is protected in bits 0-2.
 Bit 0 – Indicates whether the indicated sector is protected (0 = protected, 1 = unprotected).
 Bit 1 – Protected using the sector's DYB bit (0 = protected, 1 = unprotected).
 Bit 2 – Protected using the sector's PPB bit (0 = protected, 1 = unprotected).
 Bits 3 through 15 are all 1s.
- 86. The smaller parameter-sectors need to include A[16:11] as part of the address identifying the target parameter-sector during erase and program command sequences.
- 87. Both the ID (Autoselect) Entry and the CFI Entry allows access to the same ID/CFI data set. All data contained in within the ID/CFI data set is available after using either the ID or CFI Entry sequences.

Table 40. Command Definitions (Continued)

| Command Sequence | | Cycles | Bus Cycles ^[69, 70, 71, 72] | | | | | | | | | | | | | |
|------------------------------------|--|--------|--|------|--------|------|-------|------|--------|------|-------|------|-------|------|---------|------|
| | | | First | | Second | | Third | | Fourth | | Fifth | | Sixth | | Seventh | |
| | | | Addr | Data | Addr | Data | Addr | Data | Addr | Data | Addr | Data | Addr | Data | Addr | Data |
| ECC Command Set Definitions | | | | | | | | | | | | | | | | |
| ECC Status ASO | ECC Status Enter | 3 | 555 | AA | 2AA | 55 | 555 | 75 | | | | | | | | |
| | ECC Status Read ^[84] | 1 | RA | RD | | | | | | | | | | | | |
| | Error Lower Address Register | 2 | XXX | 60 | xx1 | RD | | | | | | | | | | |
| | Error Upper Address Register | 2 | XXX | 60 | xx2 | RD | | | | | | | | | | |
| | Read Error Detection Counter | 2 | XXX | 60 | xx3 | RD | | | | | | | | | | |
| | Clear ECC Errors | 1 | XXX | 50 | | | | | | | | | | | | |
| | Reset/ASO Exit | 1 | XXX | F0 | | | | | | | | | | | | |
| CRC Command Set Definitions | | | | | | | | | | | | | | | | |
| CRC ASO | CRC ASO Entry | 3 | 555 | AA | 2AA | 55 | 555 | 78 | | | | | | | | |
| | Load CRC Start Address | 1 | BL | C3 | | | | | | | | | | | | |
| | Load CRC End Address (start calculation) | 1 | EL | 3C | | | | | | | | | | | | |
| | CRC Suspend | 1 | XXX | C0 | | | | | | | | | | | | |
| | Array Read (during suspend) | 1 | RA | RD | | | | | | | | | | | | |
| | CRC Resume | 1 | XXX | C1 | | | | | | | | | | | | |
| | Read Check-value Low Result Register | 2 | XXX | 60 | XX0 | RD | | | | | | | | | | |
| | Read Check-value High Result Register | 2 | XXX | 60 | XX1 | RD | | | | | | | | | | |
| | Reset / ASO Exit | 1 | XXX | F0 | | | | | | | | | | | | |

Notes

- 69. All values are in hexadecimal. All addresses reference 16-bit words.
- 70. Except for the following, all bus cycles are write cycle: read cycle during Read, ID/CFI Read (Manufacturing ID / Device ID), Indicator Bits, Secure Silicon Region Read, SSR Lock Read, and 2nd cycle of Status Register Read.
- 71. Data bits DQ15-DQ8 are 'don't care' in command sequences, except for RD, PD, WC and PWD.
- 72. Address bits A_{MAX}-A11 are 'don't care' for unlock and command cycles, unless SA or PA required. (A_{MAX} is the Highest Address pin.)
- 73. No unlock or command cycles required when reading array data.
- 74. The Reset command is required to return to reading array data when device is in the ID-CFI (Autoselect) Mode, or if DQ5 goes High (while the device is providing status data).
- 75. Command is valid when device is ready to read array data or when device is in ID-CFI (Autoselect) Mode.
- 76. The system can read and program / program suspend in non-erasing sectors, or enter the ID-CFI ASO, when in the Erase Suspend Mode. The Erase Suspend command is valid only during a sector erase operation.
- 77. The Erase Resume / Program Resume command is valid only during the Erase Suspend / Program Suspend Modes.
- 78. Issue this command sequence to return to READ Mode after detecting device is in a Write-to-Buffer-Abort state. Note that the full command sequence is required if resetting out of ABORT.
- 79. The Exit command returns the device to reading the array.
- 80. For PWDx, only one portion of the password can be programmed per each 'A0' command. Portions of the password must be programmed in sequential order (PWD0-PWD3).
- 81. All ASP Register bits are one-time programmable. The program state = 0 and the erase state = 1. Both the Persistent Protection Mode Lock Bit and the Password Protection Mode Lock Bit cannot be programmed at the same time or the ASPR Register Bits Program operation aborts and returns the device to Read Mode. ASPR Register bits that are reserved for future use are undefined and may be 0's or 1's.
- 82. If any of the Entry commands was issued, an Exit command must be issued to reset the device into Read Mode.
- 83. Bit 0 = 0 indicates the Protected State, Bit 0 = 1 indicates the Unprotected State. Bits 1 through 15 are all 1s. The sector address for DYB set, DYB clear, or PPB Program command may be any location within the sector; the lower order bits of the sector address are 'don't care'.
- 84. Data out during a Status Register Read transaction, DYB Read, PPB Read, SA Protection Read, Password Read, POR Timer Read, ICR Read, ISR Read, VCR Read, NVCR Read, FIDR Read, ASPR Read, PPBL Read Register Read transactions is only valid during the first word output by the device. Subsequent data values output if CK/CK# continue to toggle while CS# remains Low are undefined.
- 85. Data out during a SA Protection Status Read indicates whether the indicated sector is protected in bits 0-2.
 Bit 0 – Indicates whether the indicated sector is protected (0 = protected, 1 = unprotected).
 Bit 1 – Protected using the sector's DYB bit (0 = protected, 1 = unprotected).
 Bit 2 – Protected using the sector's PPB bit (0 = protected, 1 = unprotected).
 Bits 3 through 15 are all 1s.
- 86. The smaller parameter-sectors need to include A[16:11] as part of the address identifying the target parameter-sector during erase and program command sequences.
- 87. Both the ID (Autoselect) Entry and the CFI Entry allows access to the same ID/CFI data set. All data contained in within the ID/CFI data set is available after using either the ID or CFI Entry sequences.

Command Definitions Legend:

X = Don't care.

RA = Address of the memory to be read.

RD = Data read from location RA during read operation.

PA = Address of the memory location to be programmed.

PD = Data to be programmed at location PA.

SA = Address of the sector selected. Address bits $A_{MAX}-A17$ for 256-KB sectors and $A_{MAX}-A11$ for 4-KB parameter sectors uniquely select any sector.

WBL = Write Buffer Location. The address must be within the same Line.

WC = Word Count is the number of write buffer locations to load minus 1.

PWAx = Password address for word0 = 00h, word1 = 01h, word2 = 02h, and word3 = 03h.

PWDx = Password data word0, word1, word2, and word3.

9. Data Integrity

9.1 Endurance

Table 41. Program / Erase Endurance

| Non-Volatile Unit | Temperature Range | Minimum | Unit |
|------------------------|-------------------|---------|----------------------|
| Any Sector | Industrial | 100K | Program-Erase cycles |
| | Industrial Plus | 100K | |
| | Extended | 10K | |
| Configuration Register | Industrial | 100K | |
| | Industrial Plus | 100K | |
| | Extended | 10K | |

Note

88. Cycling data collection was limited to 100K cycles.

9.2 Data Retention

Table 42. Data Retention

| Parameter | Typical | Unit |
|--|---------|-------|
| Data Retention Time after 1K cycles or less with one programming operation, per half-page, per erase | 20 | Years |

Hardware Interface

For the general description of the HyperBus hardware interface of HyperFlash memories refer to the HyperBus Specification. The following section describes HyperFlash device dependent aspects of hardware interface.

10. Electrical Specifications

The following section describes HyperFlash device dependent aspects of electrical specifications.

10.1 Absolute Maximum Ratings

| | |
|--|--------------------------------------|
| Storage Temperature Plastic Packages- | 65 °C to +150 °C |
| Ambient Temperature with Power Applied | -65 °C to +125 °C |
| Voltage with Respect to Ground | |
| All signals ^[89] | -0.5 V to +(V _{CC} + 0.5 V) |
| Output Short Circuit Current ^[90] | 100 mA |
| V _{CC} | -0.5 V to +4.0 V |

Notes:

1. Minimum DC voltage on input or I/O signal is -1.0 V. During voltage transitions, input or I/O signals may undershoot V_{SS} to -1.0 V for periods of up to 20 ns. See Figure 20. Maximum DC voltage on input or I/O signals is V_{CC} +1.0 V. During voltage transitions, input or I/O signals may overshoot to V_{CC} +1.0 V for periods up to 20 ns. See Figure 21.
2. No more than one output may be shorted to ground at a time. Duration of the short circuit should not be greater than one second.
3. Stresses above those listed under "Absolute Maximum Ratings" may cause permanent damage to the device. This is a stress rating only; functional operation of the device at these or any other conditions above those indicated in the operational sections of this data sheet is not implied. Exposure of the device to absolute maximum rating conditions for extended periods may affect device reliability.

10.1.1 Input Signal Overshoot

During DC conditions, input or I/O signals should remain equal to or between V_{SS} and V_{DD}. During voltage transitions, inputs or I/Os may negative overshoot V_{SS} to -1.0V or positive overshoot to V_{DD} +1.0V, for periods up to 20 ns.

Figure 20. Maximum Negative Overshoot Waveform



Figure 21. Maximum Positive Overshoot Waveform



Notes

89. Minimum DC voltage on input or I/O signal is -1.0 V. During voltage transitions, input or I/O signals may undershoot V_{SS} to -1.0 V for periods of up to 20 ns. See Figure 20. Maximum DC voltage on input or I/O signals is V_{CC} +1.0 V. During voltage transitions, input or I/O signals may overshoot to V_{CC} +1.0 V for periods up to 20 ns. See Figure 21.
90. No more than one output may be shorted to ground at a time. Duration of the short circuit should not be greater than one second.
91. Stresses above those listed under "Absolute Maximum Ratings" may cause permanent damage to the device. This is a stress rating only; functional operation of the device at these or any other conditions above those indicated in the operational sections of this data sheet is not implied. Exposure of the device to absolute maximum rating conditions for extended periods may affect device reliability.

10.2 Thermal Impedance

| Parameter | Description | VAA024 | Unit |
|---------------|--|--------|------|
| θ_{JA} | Thermal Resistance (Junction to Ambient) | 39 | °C/W |

Note

92. Test conditions follow standard methods and procedures for measuring thermal impedance in accordance with EIA/JESD51.

10.3 Latchup Characteristics

Table 43. Latchup Specification

| Description | Min | Max | Unit |
|---|------|-----------------|------|
| Input voltage with respect to V_{SSQ} on all input only connections | -1.0 | $V_{CCQ} + 1.0$ | V |
| Input voltage with respect to V_{SSQ} on all I/O connections | -1.0 | $V_{CCQ} + 1.0$ | V |
| V_{CCQ} Current | -100 | +100 | mA |

Note

93. Excludes power supplies V_{CC}/V_{CCQ} . Test conditions: $V_{CC} = V_{CCQ} = 1.8$ V, one connection at a time tested, connections not being tested are at V_{SS} .

10.4 Operating Ranges

Operating ranges define those limits between which the functionality of a device is guaranteed. The operating range is device specific. Consult the device data sheet Ordering Part Number valid combinations to know which operating ranges are supported by a particular device.

10.4.1 Temperature Ranges

| Parameter | Symbol | Device | Spec | | Unit |
|---------------------|--------|------------------------------|------|------|------|
| | | | Min | Max | |
| Ambient Temperature | T_A | Industrial | -40 | +85 | °C |
| | | Industrial Plus | -40 | +105 | |
| | | Extended | -40 | +125 | |
| | | Automotive, AEC-Q100 Grade 3 | -40 | +85 | |
| | | Automotive, AEC-Q100 Grade 2 | -40 | +105 | |
| | | Automotive, AEC-Q100 Grade 1 | -40 | +125 | |

10.4.2 Power Supply Voltages

| | |
|------------------------|---------------|
| V_{CC} and V_{CCQ} | 1.7V to 1.95V |
| V_{CC} and V_{CCQ} | 2.7V to 3.6V |

10.5 DC Characteristics (CMOS Compatible)

Table 44. DC Characteristics (CMOS Compatible)

| Parameter | Description | Test Conditions | Min | Typ ^[102] | Max | Unit |
|--------------------|---|---|--------------------------|----------------------|-------------------------|------|
| I _{CC1} | V _{CC} Active Read Current (core current only, IO switching current is not included) | CS# = V _{IL} , @166 MHz, V _{CC} = 1.95V | | 130 | 180 | mA |
| | | CS# = V _{IL} , @100 MHz, V _{CC} = 3.6V | | 80 | 100 | mA |
| I _{IO1} | V _{CCQ} Active Read Current of IOs | CS# = V _{IL} , @166 MHz, V _{CCQ} = 1.95V, C _{LOAD} = 20 pf | | 80 | 100 | mA |
| | | CS# = V _{IL} , @100 MHz, V _{CCQ} = 3.6V, C _{LOAD} = 20 pf | | 80 | 100 | mA |
| I _{CC3P} | V _{CC} Active Program Current ^[94, 95] | V _{CC} = V _{CC} max | | 60 | 100 | mA |
| I _{CC3E} | V _{CC} Active Erase Current ^[94, 95] | V _{CC} = V _{CC} max | | 60 | 100 | mA |
| I _{CC4I} | V _{CC} Standby Current for Industrial Temp. (-40°C to +85°C) | CS# = V _{IH} , RESET# = V _{CC} , V _{CC} = V _{CC} max | | 25 | 100 | μA |
| I _{CC4IC} | V _{CC} Standby Current for Industrial Plus (Automotive - In Cabin) Temp. (-40°C to +105°C) | CS# = V _{IH} , RESET# = V _{CC} , V _{CC} = V _{CC} max | | 25 | 300 | μA |
| I _{CC4E} | V _{CC} Standby Current for Extended Temp. (-40°C to +125°C) | CS# = V _{IH} , RESET# = V _{CC} , V _{CC} = V _{CC} max | | 25 | 300 | μA |
| I _{CC5} | V _{CC} Reset Current ^[98] | CS# = V _{IH} , RESET# = V _{SS} , V _{CC} = V _{CC} max | | 10 | 20 | mA |
| I _{CC6} | Active Clock Stop Mode ^[96] | V _{IH} = V _{CC} , V _{IL} = V _{SS} , V _{CC} = 1.95V | | 6 | 12 | mA |
| | | V _{IH} = V _{CC} , V _{IL} = V _{SS} , V _{CC} = 3.6V | | 6 | 12 | mA |
| I _{CC7} | V _{CC} Current during Power-Up ^[97] | CS# = X, V _{CC} = V _{CC} max, | | 80 | 100 | mA |
| I _{DPD} | Deep Power-Down Current 512 Mb @ 25 °C | CS# = V _{IH} , RESET#, V _{CC} = V _{CC} max | | 8 | 18 | μA |
| | Deep Power-Down Current 512 Mb @ 85 °C | | | 30 | 50 | μA |
| | Deep Power-Down Current 512 Mb @ 105 °C | | | 95 | 150 | μA |
| | Deep Power-Down Current 512 Mb @ 125 °C | | | 150 | 250 | μA |
| | Deep Power-Down Current (all other densities) @ 25 °C | | | 3 | 6 | μA |
| | Deep Power-Down Current (all other densities) @ 85 °C | | | 4 | 10 | μA |
| | Deep Power-Down Current (all other densities) @ 105 °C | | | 5 | 15 | μA |
| | Deep Power-Down Current 256 Mb @ 125 °C | | | 15 | 25 | μA |
| | Deep Power-Down Current 128 Mb @ 125 °C | | | 10 | 15 | μA |
| V _{IL} | Input Low Voltage | | -0.15 x V _{CCQ} | - | 0.35 x V _{CCQ} | V |
| V _{IH} | Input High Voltage | | 0.65 x V _{CCQ} | - | 1.15 x V _{CCQ} | V |

Notes

- 94. I_{CC} active while Embedded Algorithm is in progress.
- 95. Not 100% tested.
- 96. Active Clock Stop Mode enables the lower power mode when the CK/CK# signals remain stable for t_{ACC} + 30 ns.
- 97. V_{CCQ} = 1.70V to 1.95V or 2.7V to 3.6V.
- 98. V_{CC} = V_{CCQ} = 1.8V or V_{CC} = V_{CCQ} = 3.0V.
- 99. During Power-Up there are spikes of current demand, the system needs to be able to supply this current to insure the part initializes correctly.
- 100. If an embedded operation is in progress at the start of reset, the current consumption will remain at the embedded operation specification until the embedded operation is stopped by the reset. If no embedded operation is in progress when reset is started, or following the stopping of an embedded operation, I_{CC7} will be drawn during the remainder of t_{RPH}. After the end of t_{RPH} the device will go to Standby Mode until the next read or write.
- 101. The recommended pull-up resistor for the INT# and RSTO# outputs is 5k to 10k Ohms.
- 102. Typical I_{CC} values are measured at t_{AI} = 25°C and V_{CC} = V_{CCQ} = 1.8V or 3.0V (not applicable to I_{DPD} for 85°C and 105°C).

Table 44. DC Characteristics (CMOS Compatible) (Continued)

| Parameter | Description | Test Conditions | Min | Typ ^[102] | Max | Unit |
|-----------------|---------------------|---|-------------------------|----------------------|-------------------------|------|
| V _{OH} | Output High Voltage | I _{OH} = 100 μA for DQ[7:0] | V _{CCQ} - 0.20 | – | – | V |
| V _{OL} | Output Low Voltage | I _{OL} = 100 μA for DQ7-DQ0 I _{OL} = 2 mA for INT# and RSTO# | | | 0.15 x V _{CCQ} | V |

Notes

- 94. I_{CC} active while Embedded Algorithm is in progress.
- 95. Not 100% tested.
- 96. Active Clock Stop Mode enables the lower power mode when the CK/CK# signals remain stable for t_{ACC} + 30 ns.
- 97. V_{CCQ} = 1.70V to 1.95V or 2.7V to 3.6V.
- 98. V_{CC} = V_{CCQ} = 1.8V or V_{CC} = V_{CCQ} = 3.0V.
- 99. During Power-Up there are spikes of current demand, the system needs to be able to supply this current to insure the part initializes correctly.
- 100. If an embedded operation is in progress at the start of reset, the current consumption will remain at the embedded operation specification until the embedded operation is stopped by the reset. If no embedded operation is in progress when reset is started, or following the stopping of an embedded operation, I_{CC7} will be drawn during the remainder of t_{RPH}. After the end of t_{RPH} the device will go to Standby Mode until the next read or write.
- 101. The recommended pull-up resistor for the INT# and RSTO# outputs is 5k to 10k Ohms.
- 102. Typical I_{CC} values are measured at t_{AI} = 25°C and V_{CC} = V_{CCQ} = 1.8V or 3.0V (not applicable to I_{DPD} for 85°C and 105°C).

10.5.1 Capacitance Characteristics

Table 45. 1.8V Capacitive Characteristics

| Description | Parameter | Min | Max | Unit |
|---|-----------|-----|------|------|
| Input Capacitance (CK, CK#, CS#, PSC, PSC#) | CI | 3.5 | 4.5 | pF |
| Delta Input Capacitance (CK, CK#, CS#, PSC, PSC#) | CID | — | 0.25 | pF |
| Output Capacitance (RWDS) | CO | 5.0 | 6.0 | pF |
| I/O Pin Capacitance (DQx) | CIO | 5.0 | 6.0 | pF |
| I/O Pin Capacitance Delta (DQx) | CIOD | — | 0.8 | pF |
| INT#, RSTO# Pin Capacitance | COP | 5.0 | 6.0 | pF |
| RESET# Pin Capacitance | CIP | 6.5 | 9.0 | pF |

Notes

- 103. These values are guaranteed by design and are tested on a sample basis only.
- 104. Pin capacitance is measured according to JEP147 procedure for measuring capacitance using a vector network analyzer. V_{CC}, V_{CCQ} are applied and all other pins (except the pin under test) floating. DQs should be in the High Impedance state.
- 105. The capacitance values for the CK, CK#, RWDS and DQx pins must have similar capacitance values to allow for signal propagation time matching in the system. The capacitance value for CS# is not as critical because there are no critical timings between CS# going active (Low) and data being presented on the DQs bus.

Table 46. 3.0V Capacitive Characteristics

| Description | Parameter | Min | Max | Unit |
|---------------------------------|-----------|-----|-----|------|
| Input Capacitance (CK, CS#) | CI | 3.5 | 4.5 | pF |
| PSC | CI | 3.5 | 4.5 | pF |
| Output Capacitance (RWDS) | CO | 4.5 | 6.0 | pF |
| I/O Pin Capacitance (DQx) | CIO | 4.5 | 6.0 | pF |
| I/O Pin Capacitance Delta (DQx) | CIOD | – | 0.8 | pF |
| INT#, RSTO# Pin Capacitance | COP | 5.0 | 6.0 | pF |
| RESET# Pin Capacitance | CIP | 6.0 | 8.5 | pF |

Notes

- 106. These values are guaranteed by design and are tested on a sample basis only.
- 107. Pin capacitance is measured according to JEP147 procedure for measuring capacitance using a vector network analyzer. V_{CC}, V_{CCQ} are applied and all other pins (except the pin under test) floating. DQs should be in the High Impedance state.
- 108. The capacitance values for the CK, RWDS and DQx pins must have similar capacitance values to allow for signal propagation time matching in the system. The capacitance value for CS# is not as critical because there are no critical timings between CS# going active (Low) and data being presented on the DQs bus.

10.6 Power-Up and Power-Down

The memory is considered to be powered-off when the core power supply (V_{CC}) drops below the V_{CC} lock-out voltage (V_{LKO}). When V_{CC} is below V_{LKO} , the entire memory array is protected against a program or erase operation. This ensures that no spurious alteration of the memory content can occur during power transition. During a power supply transition down to the V_{SS} level, V_{CCQ} should remain less than or equal to V_{CC} .

If V_{CC} goes below V_{CC} Reset (V_{RST}) then returns above V_{RST} to V_{CC} minimum, the Power-On Reset interface state is entered and the EAC starts the Cold Reset Embedded Algorithm.

V_{CC} must always be greater than or equal to V_{CCQ} ($V_{CC} \geq V_{CCQ}$).

The device ignores all inputs until a time delay of t_{VCS} has elapsed after the moment that V_{CC} and V_{CCQ} both rise above, and stay above, the minimum V_{CC} thresholds. During t_{VCS} the device is performing Power-On Reset operations.

During Power-Down or voltage drops below V_{LKO} , the V_{CC} voltages must drop below V_{RST} for a period of t_{PD} for the part to initialize correctly when V_{CC} and V_{CCQ} again rise to their operating ranges. See [Figure 22 on page 77](#). If during a voltage drop the V_{CC} stays above V_{LKO} the part will stay initialized and will work correctly when V_{CC} is again above V_{CC} minimum. If the part locks up from improper initialization, a Software Reset can be used to initialize the part correctly.

Normal precautions must be taken for supply decoupling to stabilize the V_{CC} and V_{CCQ} power supplies. Each device in a system should have the V_{CC} and V_{CCQ} power supplies decoupled by a suitable capacitor close to the package connections (this capacitor is generally on the order of 0.1 μ F).

Figure 22. Power-Down or Voltage Drop



Table 47. 1.8V Power-Up / Power-Down Voltage and Timing

| Symbol | Parameter | Min | Max | Unit |
|-----------|---|-----|------|---------|
| V_{CC} | V_{CC} Power Supply | 1.7 | 1.95 | V |
| V_{LKO} | V_{CC} Cut-Off below which re-initialization is required | 1.5 | – | V |
| V_{RST} | V_{CC} Low Voltage needed to ensure initialization will occur | 0.5 | – | V |
| t_{VCS} | V_{CC} and $V_{CCQ} \geq$ minimum to first access RESET# Low to High transition to first access (V_{CC} and $V_{CCQ} \geq$ minimum) | – | 300 | μ s |
| t_{PD} | Duration of $V_{CC} \leq V_{RST}$ | 10 | – | μ s |

Note

109. V_{CC} ramp rate can be non-linear.

Table 48. 3.0V Power-Up / Power-Down Voltage and Timing

| Symbol | Parameter | Min | Max | Unit |
|-----------|---|-----|-----|---------|
| V_{CC} | V_{CC} Power Supply | 2.7 | 3.6 | V |
| V_{LKO} | V_{CC} Cut-Off below which re-initialization is required | 2.4 | – | V |
| V_{RST} | V_{CC} Low Voltage needed to ensure initialization will occur | 0.7 | – | V |
| t_{VCS} | V_{CC} and $V_{CCQ} \geq$ minimum to first access RESET# Low to High transition to first access (V_{CC} and $V_{CCQ} \geq$ minimum) | – | 300 | μ s |
| t_{PD} | Duration of $V_{CC} \leq V_{RST}$ | 10 | – | μ s |

Note

 110. V_{CC} ramp rate can be non-linear.

10.6.1 Power-On (Cold) Reset (POR)

When power is first applied, with supply voltage below V_{LKO} then rising to reach operating range minimum, internal device configuration and Cold Reset activities are initiated. RESET# and CS# are ignored during the duration of the POR operation (t_{VCS}) and any user extended period of RSTO# Low. Command sequences are blocked while the device is in the POR state or RSTO# is Low. During this period, the device can not be selected, will not accept commands, and does not drive outputs other than RSTO#. RESET# Low during this POR period is optional. If RESET# is driven Low during POR it must satisfy the Hardware Reset parameters t_{RP} and t_{RPH} in which case the POR operations will be completed at the end of t_{VCS} and t_{RPH} . If RESET# is Low during t_{VCS} it may remain Low at the end of t_{VCS} to hold the device in the Hardware Reset state. If RESET# is High at the end of t_{VCS} the device will go to the Standby state. CS# must go to V_{IH} before the end of RSTO# Low.

During Cold Reset, the device will draw I_{CC7} current. If CS# is Low during t_{VCS} the device may draw higher than typical POR current during t_{VCS} but will not exceed the maximum, and the level of CS# will not affect the Cold Reset EA.

If POR has not been properly completed by the end of t_{VCS} , a later transition to the Hardware Reset state will cause a transition to the Power-On Reset interface state and initiate the Cold Reset Embedded Algorithm. This ensures the device can complete a Cold Reset even if some aspect of the system Power-On voltage ramp-up causes the POR to not initiate or complete correctly.

RSTO# is an open-drain output used to indicate when a POR is occurring within the device and can be used as a system level reset signal. Upon completion of the internal POR the RSTO# signal will transition from Low to high impedance after a user defined timeout period has elapsed. Upon transition to the high impedance state the external pull-up resistance will pull RSTO# High and the device immediately is placed into the Standby state. While RSTO# is low, no commands are accepted by the device.

If the user wants to extend the RSTO# period beyond the POR (t_{VCS}) period, the non-volatile PORTime Register must be programmed. The default value for this register (FFFFh), provides zero added time. The RSTO# signal will return to high impedance at the end of t_{VCS} . A value programmed into the 16-bit PORTime Register is multiplied by t_{POR_CK} (see Table 49 on page 78) to define the length of extension to the RSTO# pulse beyond t_{VCS} . The length of the programmed extension to the RSTO# assertion is the value programmed into the PORTime Register plus one clock cycle. The PORTime Register is OTP and, once programmed, will fail subsequent programming attempts.

Table 49. User POR Extension Clock Timings

| Parameter | Symbol | Min | Max | Unit |
|----------------------------|---------------|-----|-----|---------|
| POR Extension Clock Period | t_{POR_CK} | 25 | 42 | μ s |

Note that both the RSTO# and INT# outputs are undefined while V_{CC} is below $V_{CC}(\min)$. By the time that $V_{CC}(\min)$ is reached, the INT# output will be in the high impedance state. The RSTO# output will transition from the Low to high impedance state after t_{VCS} , plus any additional user defined POR extension time, after $V_{CC}(\min)$ has been reached.

Figure 23. Power-On Reset Signal Diagram^[111, 112, 113]



10.6.2 Hardware Reset

- Terminates any operation in progress
- DQ[7:0] are placed into the High-Z state when RESET# is Low
- Exits any ASO
- Tristates all outputs
- Resets the Status Register
- Resets the EAC to Standby state
- CS# is ignored for the duration of the reset operation (t_{RPH})
- To meet the Reset current specification (I_{CC5}) CS# must be held High

To ensure data integrity, any non-volatile operation that was interrupted should be reinitiated once the device completes the Hardware Reset process.

Notes

111. V_{CCQ} must be the same voltage as V_{CC} .

112. $PORTime$ is a customer programmed configuration register intended to allow RSTO# assertion beyond t_{VCS} . $PORTime$ is described in Table 14 on page 33.

113. t_{POR_CK} is the internal (on-chip) clock period used to generate the extension to RSTO#. t_{POR_CK} is described in Table 49 on page 78.

10.6.3 Hardware (Warm) Reset

The RESET# input provides a hardware method of resetting the device to the Standby state. While RESET# is Low command sequences and read operations are not allowed. Command sequences are blocked while the device is in the reset state.

During Hardware Reset, the device will draw I_{CC5} current. When RESET# continues to be held at V_{SS} , the device draws CMOS standby current (I_{CC4}). If RESET# is held at V_{IL} , but not at V_{SS} , the standby current is greater.

A Hardware Reset will cause the bus configuration to be defined by the Non-Volatile Configuration Register (NVCR). See [Figure 24 on page 80](#).

After the device has completed POR and entered the Standby state, any later transition to the Hardware Reset state will initiate the Warm Reset Embedded Algorithm. A Warm Reset is much shorter than a Cold Reset, taking tens of μs (t_{RPH}) to complete. During the Warm Reset EA, any in progress Embedded Algorithm is stopped and the EAC is returned to its POR state without reloading EAC algorithms from non-volatile memory. After the Warm Reset EA is completed, the interface will remain in the Hardware Reset state if RESET# remains Low. When RESET# returns High the interface will transition to the Standby state. If RESET# is High at the end of the Warm Reset EA, the interface will directly transition to the Standby state.

If POR has not been properly completed by the end of t_{VCS} , a later transition to the Hardware Reset state will cause a transition to the Power-On Reset interface state and initiate the Cold Reset Embedded Algorithm. This ensures the device can complete a Cold Reset even if some aspect of the system Power-On voltage ramp-up causes the POR to not initiate or complete correctly.

Figure 24. Hardware Reset Timing Diagram

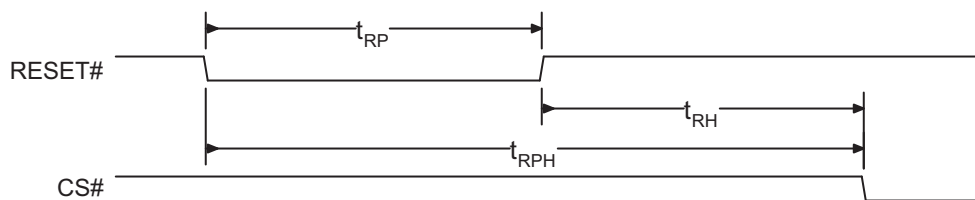

Table 50. Power-On and Reset Parameters

| Parameter | Description | Limit | Time | Unit |
|------------|--|-------|------|---------|
| t_{VCS} | V_{CC} Setup Time to first access ^[114] | Min | 300 | μs |
| t_{RPH} | RESET# Low to CS# Low | Min | 30 | μs |
| t_{RP} | RESET# Pulse Width | Min | 200 | ns |
| t_{RH} | Time between RESET# (High) and CS# (Low) | Min | 150 | ns |
| t_{PD} | Duration of $V_{CC} \leq V_{RST}$ | Min | 10 | μs |
| t_{CSHI} | Chip Select High Between Operations | Min | 6.0 | ns |

Notes

- 114. Bus transactions (read and write) are not allowed during the Power-Up Reset time (t_{VCS}).
- 115. Timing measured from V_{CC} reaching $V_{CC\ min}$ to V_{IH} on Reset and V_{IL} on CS#.
- 116. RESET# Low is optional during POR. If RESET is asserted during POR, the later of t_{RPH} and t_{VCS} will determine when CS# may go Low. If RESET# remains Low after t_{VCS} is satisfied, t_{RPH} is measured from the end of t_{VCS} . RESET must also be High t_{RH} before CS# goes Low.
- 117. V_{CC} ramp rate can be non-linear.
- 118. Sum of $t_{RP} + t_{RH}$ must be equal to or greater than t_{RPH} .

Hardware Reset can also be used to exit from DPD mode. Driving the RESET# input Low (for the minimum t_{RP} time) will also cause the device to exit the DPD Mode. The device will take t_{DPDOUT} to return to the Standby state. Upon exit from DPD, the device will have the same default settings that exist after Power-On Reset. See [Section 10.8.1 Deep Power-Down on page 81](#).

10.7 Power-Off with Hardware Data Protection

The memory is considered to be powered off when the core power supply (V_{CC}) drops below the lock-out voltage (V_{LKO}). When V_{CC} is below V_{LKO} , the entire memory array is protected against a program or erase operation. This ensures that no spurious alteration of the memory content can occur during power transition. During a power supply transition down to Power-Off, V_{CCQ} should remain less than or equal to V_{CC} .

If V_{CC} goes below V_{RST} (Min), then returns above V_{RST} (Min) to V_{CC} minimum, the Power-On Reset interface state is entered and the EAC starts the Cold Reset Embedded Algorithm.

10.8 Power Conservation Modes

10.8.1 Deep Power-Down

In the DPD Mode, current consumption is driven to the lowest level. The DPD Mode must be entered while the device is in the Standby state while not in an ASO. DPD is entered using the DPD Entry command sequence (See Table 40 on page 64). During the t_{DPDIN} period the device will ignore command sequences (read and write transactions will not be processed).

Exiting the DPD Mode is accomplished with the assertion of DPD Entry command sequence. During the t_{DPDOUT} period the device will ignore command sequences (read and write transactions will not be processed) and RWDS will not toggle during an attempted read transaction.

During the t_{DPDIN} period, the device will ignore CS#. Entering DPD mode is not interrupted or aborted by a command sequence. Exiting DPD mode must be done after satisfying t_{DPDIN} .

Driving the RESET# input Low (for the minimum t_{RP} time) will also cause the device to exit the DPD Mode. The device will take t_{DPDOUT} to return to the Standby state. Entering DPD mode is aborted by driving the RESET# input Low (for the minimum t_{RP} time) during t_{DPDIN} .

Upon exit from DPD mode, the device will have the same default settings that exist after POR.

Table 51. DPD Mode Entry and Exit Timing

| Symbol | Parameter | Min | Max | Unit |
|--------------|--|-----|-----|---------|
| t_{DPDIN} | Deep Power-Down CR[15]=0 register write to DPD power level | 10 | – | μ s |
| t_{DPDOUT} | Deep Power-Down to Standby wakeup time | – | 300 | μ s |

Figure 25. Deep Power Down Entry Timing



Figure 26. Deep Power Down CS# Exit Timing

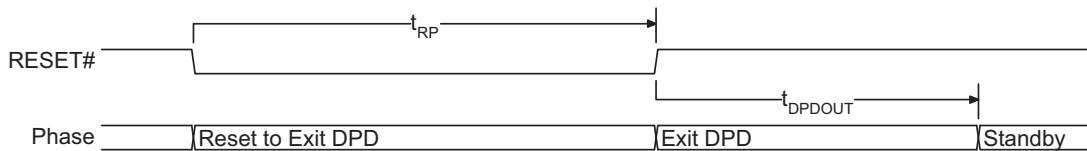
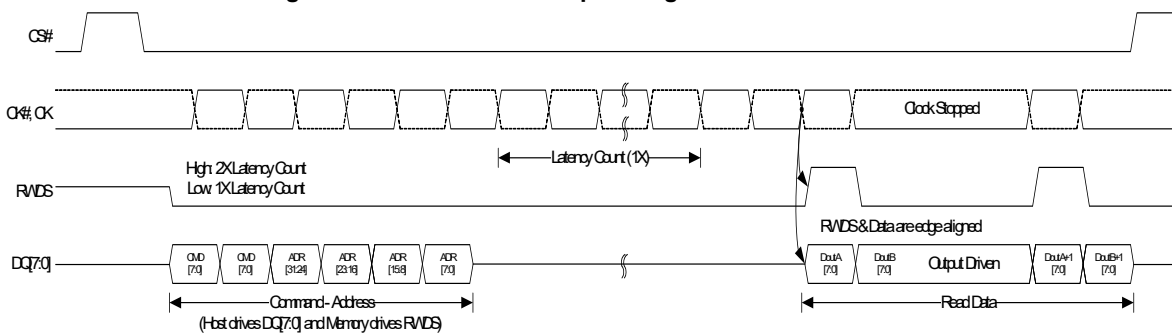

Figure 27. Deep Power Down RESET# Exit Timing

10.8.2 Active Clock Stop

The Active Clock Stop state reduces device interface energy consumption to the I_{CC6} level during the data transfer portion of a read or write operation. The device automatically enables this state when clock remains stable for $t_{ACC} + 30$ ns. While in Active Clock Stop state, read data is latched and always driven onto the data bus. I_{CC6} shown in [Section 10.5 DC Characteristics \(CMOS Compatible\)](#) on page 74.

Active Clock Stop state helps reduce current consumption when the host system clock has stopped to pause the data transfer. Even though CS# may be Low throughout these extended data transfer cycles, the memory device host interface will go into the Active Clock Stop current level at $t_{ACC} + 30$ ns. This allows the device to transition into a lower current state if the data transfer is stalled. Active read or write current will resume once the data transfer is restarted with a toggling clock. Clock can be stopped during any portion of the active transaction as long as it is in the Low state. Note that it is recommended to avoid stopping the clock during register access.

Figure 28. Active Clock Stop During Read Transaction^[119]

Note

119. CS is Low during the CA cycles. In this Read Transaction there is a single initial latency count for read data access because, this read transaction does not begin at a time when additional latency is required by the slave.

11. Timing Specifications

The following section describes HyperFlash device dependent aspects of timing specifications.

11.1 AC Test Conditions

Figure 29. Test Setup



Table 52. Test Specification

| Parameter | All Speeds | Units |
|---|----------------|-------|
| Output Load Capacitance, C_L | 20 | pF |
| Minimum Input Rise and Fall Slew Rates ^[121] | 2.0 | V/ns |
| Input Pulse Levels | 0.0- V_{CCQ} | V |
| Input timing measurement reference levels | $V_{CCQ}/2$ | V |
| Output timing measurement reference levels | $V_{CCQ}/2$ | V |

Notes

- 121. All AC timings assume an input slew rate of 2V/ns. CK/CK# differential slew rate of at least 4V/ns.
- 122. Input and output timing is referenced to $V_{CCQ}/2$ or to the crossing of CK/CK#.

Figure 30. Input Waveforms and Measurement Levels^[121]

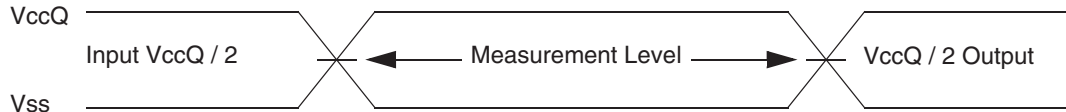

Note

- 120. Input timings for the differential CK/CK# pair are measured from clock crossings.

11.2 AC Characteristics

11.2.1 CLK Characteristics

Figure 31. Clock Characteristics



Table 53. Clock Timings

| Parameter | Symbol | 166 MHz | | 133 MHz | | 100 MHz | | 50 MHz ^[124] | | Unit |
|---|------------|---------|------|---------|-------|---------|------|-------------------------|------|----------|
| | | Min | Max | Min | Max | Min | Max | Min | Max | |
| CK Period | t_{CK} | 6 | – | 7.5 | – | 10 | – | 20 | – | ns |
| CK Half Period - Duty Cycle | t_{CKHP} | 0.45 | 0.55 | 0.45 | 0.55 | 0.45 | 0.55 | 0.45 | 0.55 | t_{CK} |
| CK Half Period at Frequency Min = 0.45 t_{CK} Min Max = 0.55 t_{CK} Min | t_{CKHP} | 2.7 | 3.3 | 3.375 | 4.125 | 4.5 | 5.5 | 9 | 11 | ns |

Notes

123. Clock jitter of $\pm 5\%$ is permitted.

124. 50 MHz timings are only relevant when a burst write is used to load data during a HyperFlash Word Program command.

125. CK# is only used on the 1.8V device and is shown as a dashed waveform.

Table 54. Clock AC/DC Electrical Characteristics

| Parameter | Symbol | Min | Max | Unit |
|----------------------------------|--------------|----------------------|----------------------|------|
| DC Input Voltage | V_{IN} | -0.3 | $V_{CCQ} + 0.3$ | V |
| DC Input Differential Voltage | $V_{ID(DC)}$ | $V_{CCQ} \times 0.4$ | $V_{CCQ} + 0.6$ | V |
| AC Input Differential Voltage | $V_{ID(AC)}$ | $V_{CCQ} \times 0.6$ | $V_{CCQ} + 0.6$ | V |
| AC Differential Crossing Voltage | V_{IX} | $V_{CCQ} \times 0.4$ | $V_{CCQ} \times 0.6$ | V |

Notes

126. CK and CK# input slew rate must be $\geq 1V/ns$ ($2V/ns$ if measured differentially).

127. V_{ID} is the magnitude of the difference between the input level on CK and the input level on CK#.

128. The value of V_{IX} is expected to equal $V_{CCQ}/2$ of the transmitting device and must track variations in the DC level of V_{CCQ} .

11.2.2 Read Transaction Diagrams

Figure 32. Read Timing Diagram



11.2.3 Read AC Parameters

Table 55. HyperBus 1.8V/3.0V Device Common Read Timing Parameters

| Parameter | Symbol | 166 MHz | | 133 MHz | | 100 MHz | | Unit |
|--|------------|---------|-------|---------|-------|---------|-------|------|
| | | Min | Max | Min | Max | Min | Max | |
| Chip Select High Between Transactions | t_{CSHI} | 6.00 | – | 7.50 | – | 10.00 | – | ns |
| Chip Select Setup to next CK Rising Edge | t_{CSS} | 3.00 | – | 3.00 | – | 3.00 | – | ns |
| Data Strobe Valid | t_{DSV} | – | 12.00 | – | 12.00 | – | 12.00 | ns |
| Input Setup | t_{IS} | 0.60 | – | 0.80 | – | 1.00 | – | ns |
| Input Hold | t_{IH} | 0.60 | – | 0.80 | – | 1.00 | – | ns |
| HyperFlash Read Initial Access Time | t_{ACC} | – | 96.00 | – | 96.00 | – | 96.00 | ns |
| Clock to DQs Low Z | t_{DQLZ} | 0 | – | 0 | – | 0 | – | ns |
| CK transition to DQ Valid | t_{CKD} | 1.00 | 5.50 | 1.00 | 5.50 | 1.00 | 5.50 | ns |
| CK transition to DQ Invalid | t_{CKDI} | 0 | 4.60 | 0 | 4.50 | 0 | 4.30 | ns |
| Data Valid ($t_{DV} \text{ min} = \text{the lessor of: } t_{CKHP} \text{ min} - t_{CKD} \text{ max} + t_{CKDI} \text{ max} \text{ or } t_{CKHP} \text{ min} - t_{CKD} \text{ min} + t_{CKDI} \text{ min}$) | t_{DV} | 1.70 | – | 2.37 | – | 3.30 | – | ns |
| CK transition to RWDS valid | t_{CKDS} | 1.00 | 5.50 | 1.00 | 5.50 | 1.00 | 5.50 | ns |
| RWDS transition to DQ Valid | t_{DSS} | -0.45 | +0.45 | -0.60 | +0.60 | -0.80 | +0.80 | ns |
| RWDS transition to DQ Invalid | t_{DSH} | -0.45 | +0.45 | -0.60 | +0.60 | -0.80 | +0.80 | ns |
| Chip Select Hold After CK Falling Edge | t_{CSH} | 0 | – | 0 | – | 0 | – | ns |
| Chip Select Inactive to RWDS High-Z | t_{DSZ} | – | 6.00 | – | 6.00 | – | 6.00 | ns |
| Chip Select Inactive to DQ High-Z | t_{OZ} | – | 6.00 | – | 6.00 | – | 6.00 | ns |

Note

129.A HyperBus device operates correctly with the t_{CSH} value shown, however, CS# must generally remain driven Low (active) by the HyperBus master longer, so that data remains valid long enough to account for t_{CKD} , t_{CKDS} , and the master interface phase shifting of RWDS to capture the last data transfer from the DQ signals. The HyperBus master will need to drive CS# Low for one or more additional clock periods to ensure capture of valid data from the last desired data transfer.

Figure 33. DCARS Data Valid Timing^[130, 131, 132]



Table 56. DCARS Read Timings (@ 3.0 V)^[133]

| Parameter | Symbol | 100 MHz | | Unit |
|---|-------------------------|---------|------|------|
| | | Min | Max | |
| HyperFlash PSC transition to RWDS transition | $t_{PSCRWDS}$ | 1 | 6.5 | ns |
| Time delta between CK to DQ valid and PSC to RWDS | $t_{PSCRWDS} - t_{CKD}$ | -1.0 | +0.5 | ns |

Table 57. DCARS Read Timings (@ 1.8 V)^[133]

| Parameter | Symbol | 133 MHz | | 100 MHz | | Unit |
|---|-------------------------|---------|------|---------|------|------|
| | | Min | Max | Min | Max | |
| HyperFlash PSC transition to RWDS transition | $t_{PSCRWDS}$ | 1 | 5.5 | 1 | 5.5 | ns |
| Time delta between CK to DQ valid and PSC to RWDS | $t_{PSCRWDS} - t_{CKD}$ | -1.0 | +0.5 | -1.0 | +0.5 | ns |

Note

130. CK# and PSC# are optional and shown as dashed line waveforms.

131. The delay (phase shift) from CK to PSC is controlled by the HyperBus master interface (Host) and is generally between 40 and 140 degrees in order to place the RWDS edge within the data valid window with sufficient set-up and hold time of data to RWDS. The requirements for data set-up and hold time to RWDS are determined by the HyperBus master interface design and are not addressed by the HyperBus slave timing parameters.

132. The HyperBus timing parameters of t_{CKD} and t_{CKDI} define the beginning and end position of the data valid period. The t_{CKD} and t_{CKDI} values track together (vary by the same ratio) because RWDS and Data are outputs from the same device under the same voltage and temperature conditions.

133. Sampled, not 100% tested.

11.2.4 Word Programming with Multiple Word Burst Data Load

Figure 34. Burst Write During Load of Multiple Words During a Word Program Command Timing Diagram^[134, 135, 136, 137, 138, 139]

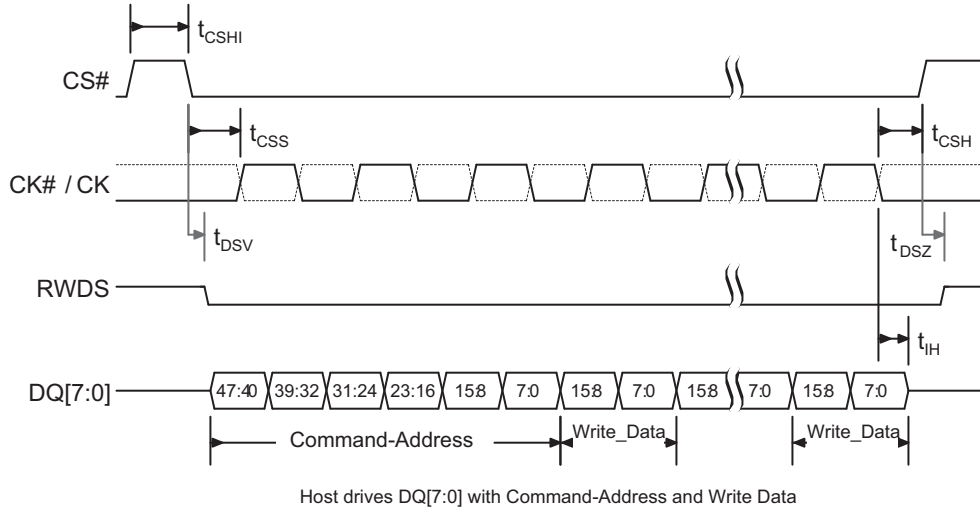

11.2.5 Write AC Parameters

Table 58. HyperFlash 1.8V/3.0V Device Common Write Timing Parameters

| Parameter | Symbol | 166 MHz | | 133 MHz | | 100 MHz | | Unit |
|--|------------|---------|-------|---------|-------|---------|-------|------|
| | | Min | Max | Min | Max | Min | Max | |
| Chip Select High Between Transactions | t_{CSHI} | 6.00 | – | 7.50 | – | 10.00 | – | ns |
| Chip Select Setup to next CK Rising Edge | t_{CSS} | 3.00 | – | 3.00 | – | 3.00 | – | ns |
| Data Strobe Valid | t_{DSV} | – | 12.00 | – | 12.00 | – | 12.00 | ns |
| Input Setup | t_{IS} | 0.60 | – | 0.80 | – | 1.00 | – | ns |
| Input Hold | t_{IH} | 0.60 | – | 0.80 | – | 1.00 | – | ns |
| Chip Select Hold After CK Falling Edge | t_{CSH} | 0 | – | 0 | – | 0 | – | ns |
| Chip Select Inactive or clock to RWDS High-Z | t_{DSZ} | – | 6.00 | – | 6.00 | – | 6.00 | ns |

Note

- 134. Transactions must be initiated with CK = Low and CK# = High. CS# must return High before a new transaction is initiated.
- 135. HyperFlash memory drives RWDS Low during write while CS# is Low.
- 136. Burst Write operations are not allowed while in an ASO state.
- 137. Burst Write operations are only allowed while loading multiple words during a Word Program command.
- 138. Burst write operations are linear only, no wrapped burst write capability is supported.
- 139. CK# is only used on the 1.8V device.

Table 59. Burst Write During Load of Multiple Words During a Word Program Command Timings

| Parameter | Symbol | 50 MHz ^[141] | | Unit |
|--|------------|-------------------------|-----|------|
| | | Min | Max | |
| Operating Frequency for Burst Write | | | 50 | MHz |
| Chip Select Setup to next CK Rising Edge | t_{CSS} | 3 | – | ns |
| Chip Select Active to RWDS Valid (Low) | t_{DSV} | – | 8 | ns |
| Input Setup | t_{IS} | 1.0 | – | ns |
| Input Hold | t_{IH} | 1.0 | – | ns |
| Chip Select Hold After CK Falling Edge | t_{CSH} | 0 | – | ns |
| Chip Select Inactive to RWDS High-Z | t_{DSZ} | – | 6 | ns |
| Chip Select High Between Operations | t_{CSHI} | 10.0 | – | ns |

Notes

140. Sampled, not 100% tested.

141. 50 MHz timings are only required when using a burst write during a Word Program command.

12. Embedded Algorithm Performance

Table 60. Embedded Algorithm Characteristics

| Parameter | Min | Typ ^[142] | Max ^[143] | Unit | Comments |
|--|-----|----------------------|----------------------|------|--|
| Sector Erase Time 256-KB | – | 930 | 2900 | ms | Includes pre-programming prior to erasure ^[145] |
| Parameter Sector Erase Time 4-KB | – | 240 | 725 | ms | |
| Chip Erase Time (128 Mb) | | 55 | 115 | s | |
| Chip Erase Time (256 Mb) | – | 110 | 231 | s | |
| Chip Erase Time (512 Mb) | – | 220 | 462 | s | |
| Single Word Programming Time | – | 270 | 1000 | μs | Word Programming Command Sequence |
| Half-page (16-byte) Buffered Programming Time | – | 270 | 1000 | μs | Buffered Programming Command Sequence |
| Buffer Programming Time (full 512-byte) | – | 475 | 2000 | μs | |
| Erase Suspend / Erase Resume (t_{ESL}) | – | | 50 | μs | |
| Program Suspend / Program Resume (t_{PSL}) | – | | 50 | μs | |
| Erase Resume to next Erase Suspend (t_{ERS}) | – | 100 | | μs | Minimum of 60 ns but \geq typical periods are needed for Erase to progress to completion |
| Program Resume to next Program Suspend (t_{PRS}) | – | 100 | | μs | Minimum of 60 ns but \geq typical periods are needed for Program to progress to completion |
| Blank Check (256-KB Sector) | – | 15 | 17 | ms | |
| NOP (Number of Program-operations, per Line) | – | | 256 | | Industrial Temperature |
| | – | | 32 | | Industrial Plus Temperature Only a single program operation on each 8-word (16-byte) half-page |
| Evaluate Erase Status Time (t_{EES}) | – | 70 | 100 | μs | |
| Password Comparison Time (t_{PSWD}) | 80 | 100 | 120 | μs | |
| CRC Suspend / CRC Resume (t_{CRCSL}) | — | | 25 | μs | |
| CRC Resume to next CRC Suspend (t_{CRCRS}) | — | 5 | | μs | Minimum of 60 ns but \geq typical periods are needed for the CRC calculation to progress to completion |
| CRC Calculation Setup Time (t_{CRC_SETUP}) | — | 10 | — | μs | |
| CRC Calculation Rate | 60 | 65 | | MBps | Calculation rate over a large (>1024-byte) block of data |

Notes

142. Typical program and erase times assume the following conditions: 25°C, (1.8V or 3.0V) V_{CC} , 10,000 cycle, and a checkerboard data pattern.

143. Under worst case conditions of 90°C, V_{CC} = (1.70V or 2.7V), 100,000 cycles, and a random data pattern.

144. Effective write buffer specification is based upon a 512-byte write buffer operation.

145. In the pre-programming step of the Embedded Erase algorithm, all words are programmed to 0000h before Sector and Chip erasure.

146. System-level overhead is the time required to execute the bus-cycle sequence for the program command. See [Table 40 on page 64](#) for further information on command definitions.

13. Ordering Information

13.1 Ordering Part Numbers

The ordering part number is formed by a valid combination of the following:



Notes

- 147.FBGA package marking omits the leading S2 and the packing type character from the ordering part number.
- 148.Halogen free definition is in accordance with IEC 61249-2-21 specification.

13.2 Valid Combinations — Standard

The Valid Combinations table lists configurations planned to be available in volume. The table will be updated as new combinations are released. Contact your local sales representative to confirm availability of specific combinations and to check on newly released combinations.

Table 61. Valid Combinations — Standard

| Device Number | Speed Option | Package and Material | Temperature Range | Model Number | Packing Type | Ordering Part Number (x = Packing Type) | Package Marking |
|---------------|--------------|----------------------|-------------------|--------------|--------------|---|-----------------|
| S26KL512S | DA | BH | I, V, N | 02 | 0, 3 | S26KL512SDABHI02x | 6KL512SDAHI02 |
| | | | | | | S26KL512SDABHV02x | 6KL512SDAHV02 |
| | | | | | | S26KL512SDABHN02x | 6KL512SDAHN02 |
| S26KL256S | DA | BH | I, V, N | 02 | 0, 3 | S26KL256SDABHI02x | 6KL256SDAHI02 |
| | | | | | | S26KL256SDABHV02x | 6KL256SDAHV02 |
| | | | | | | S26KL256SDABHN02x | 6KL256SDAHN02 |
| S26KL128S | DA | BH | I, V, N | 02 | 0, 3 | S26KL128SDABHI02x | 6KL128SDAHI02 |
| | | | | | | S26KL128SDABHV02x | 6KL128SDAHV02 |
| | | | | | | S26KL128SDABHN02x | 6KL128SDAHN02 |
| S26KS512S | DP | BH | I, V, N | 02 | 0, 3 | S26KS512SDPBHI02x | 6KS512SDPHI02 |
| | | | | | | S26KS512SDPBHV02x | 6KS512SDPHV02 |
| | | | | | | S26KS512SDPBHN02x | 6KS512SDPHN02 |
| S26KS256S | DP | BH | I, V, N | 02 | 0, 3 | S26KS256SDPBHI02x | 6KS256SDPHI02 |
| | | | | | | S26KS256SDPBHV02x | 6KS256SDPHV02 |
| | | | | | | S26KS256SDPBHN02x | 6KS256SDPHN02 |
| S26KS128S | DP | BH | I, V, N | 02 | 0, 3 | S26KS128SDPBHI02x | 6KS128SDPHI02 |
| | | | | | | S26KS128SDPBHV02x | 6KS128SDPHV02 |
| | | | | | | S26KS128SDPBHN02x | 6KS128SDPHN02 |

Note

149.FBGA package marking omits the leading S2 and the packing type character from the ordering part number.

Table 62. Valid Combinations — DCARS Standard

| Device Number | Speed Option | Package and Material | Temperature Range | Model Number | Packing Type | Ordering Part Number (x = Packing Type) | Package Marking |
|---------------|--------------|----------------------|-------------------|--------------|--------------|---|-----------------|
| S26KL512S | DA | BH | I, V, N | 03 | 0, 3 | S26KL512SDABHI03x | 6KL512SDAHI03 |
| | | | | | | S26KL512SDABHV03x | 6KL512SDAHV03 |
| | | | | | | S26KL512SDABHN03x | 6KL512SDAHN03 |
| S26KL256S | DA | BH | I, V, N | 03 | 0, 3 | S26KL256SDABHI03x | 6KL256SDAHI03 |
| | | | | | | S26KL256SDABHV03x | 6KL256SDAHV03 |
| | | | | | | S26KL256SDABHN03x | 6KL256SDAHN03 |
| S26KL128S | DA | BH | I, V, N | 03 | 0, 3 | S26KL128SDABHI03x | 6KL128SDAHI03 |
| | | | | | | S26KL128SDABHV03x | 6KL128SDAHV03 |
| | | | | | | S26KL128SDABHN03x | 6KL128SDAHN03 |
| S26KS512S | DA, DG | BH | I, V, N | 03 | 0, 3 | S26KS512SDABHI03x | 6KS512SDAHI03 |
| | | | | | | S26KS512SDABHV03x | 6KS512SDAHV03 |
| | | | | | | S26KS512SDABHN03x | 6KS512SDAHN03 |
| | | | | | | S26KS512SDGBHI03x | 6KS512SDGHI03 |
| | | | | | | S26KS512SDGBHV03x | 6KS512SDGHV03 |
| S26KS256S | DA, DG | BH | I, V, N | 03 | 0, 3 | S26KS256SDABHI03x | 6KS256SDAHI03 |
| | | | | | | S26KS256SDABHV03x | 6KS256SDAHV03 |
| | | | | | | S26KS256SDABHN03x | 6KS256SDAHN03 |
| | | | | | | S26KS256SDGBHI03x | 6KS256SDGHI03 |
| | | | | | | S26KS256SDGBHV03x | 6KS256SDGHV03 |
| | | | | | | S26KS256SDGBHN03x | 6KS256SDGHN03 |
| S26KS128S | DA, DG | BH | I, V, N | 03 | 0, 3 | S26KS128SDABHI03x | 6KS128SDAHI03 |
| | | | | | | S26KS128SDABHV03x | 6KS128SDAHV03 |
| | | | | | | S26KS128SDABHN03x | 6KS128SDAHN03 |
| | | | | | | S26KS128SDGBHI03x | 6KS128SDGHI03 |
| | | | | | | S26KS128SDGBHV03x | 6KS128SDGHV03 |
| | | | | | | S26KS128SDGBHN03x | 6KS128SDGHN03 |

Note
150.FBGA package marking omits the leading S2 and the packing type character from the ordering part number.

13.3 Valid Combinations — Automotive Grade / AEC-Q100

The table below lists configurations that are Automotive Grade / AEC-Q100 qualified and are planned to be available in volume. The table will be updated as new combinations are released. Contact your local sales representative to confirm availability of specific combinations and to check on newly released combinations.

Production Part Approval Process (PPAP) support is only provided for AEC-Q100 grade products.

Products to be used in end-use applications that require ISO/TS-16949 compliance must be AEC-Q100 grade products in combination with PPAP. Non-AEC-Q100 grade products are not manufactured or documented in full compliance with ISO/TS-16949 requirements.

AEC-Q100 grade products are also offered without PPAP support for end-use applications that do not require ISO/TS-16949 compliance.

Table 63. Valid Combinations — Automotive Grade / AEC-Q100

| Device Number | Speed Option | Package and Material | Temperature Range | Model Number | Packing Type | Ordering Part Number (x = Packing Type) | Package Marking |
|---------------|--------------|----------------------|-------------------|--------------|--------------|---|-----------------|
| S26KL512S | DA | BH | A, B, M | 02 | 0, 3 | S26KL512SDABHA02x | 6KL512SDAHA02 |
| | | | | | | S26KL512SDABHB02x | 6KL512SDAHB02 |
| | | | | | | S26KL512SDABHM02x | 6KL512SDAHM02 |
| S26KL256S | DA | BH | A, B, M | 02 | 0, 3 | S26KL256SDABHA02x | 6KL256SDAHA02 |
| | | | | | | S26KL256SDABHB02x | 6KL256SDAHB02 |
| | | | | | | S26KL256SDABHM02x | 6KL256SDAHM02 |
| S26KL128S | DA | BH | A, B, M | 02 | 0, 3 | S26KL128SDABHA02x | 6KL128SDAHA02 |
| | | | | | | S26KL128SDABHB02x | 6KL128SDAHB02 |
| | | | | | | S26KL128SDABHM02x | 6KL128SDAHM02 |
| S26KS512S | DP | BH | A, B, M | 02 | 0, 3 | S26KS512SDPBHA02x | 6KS512SDPHA02 |
| | | | | | | S26KS512SDPBHB02x | 6KS512SDPHB02 |
| | | | | | | S26KS512SDPBHM02x | 6KS512SDPHM02 |
| S26KS256S | DP | BH | A, B, M | 02 | 0, 3 | S26KS256SDPBHA02x | 6KS256SDPHA02 |
| | | | | | | S26KS256SDPBHB02x | 6KS256SDPHB02 |
| | | | | | | S26KS256SDPBHM02x | 6KS256SDPHM02 |
| S26KS128S | DP | BH | A, B, M | 02 | 0, 3 | S26KS128SDPBHA02x | 6KS128SDPHA02 |
| | | | | | | S26KS128SDPBHB02x | 6KS128SDPHB02 |
| | | | | | | S26KS128SDPBHM02x | 6KS128SDPHM02 |

Table 64. Valid Combinations — DCARS Automotive Grade / AEC-Q100

| Device Number | Speed Option | Package and Material | Temperature Range | Model Number | Packing Type | Ordering Part Number (x = Packing Type) | Package Marking |
|---------------|--------------|----------------------|-------------------|--------------|--------------|---|-----------------|
| S26KL512S | DA | BH | A, B, M | 03 | 0, 3 | S26KL512SDABHA03x | 6KL512SDAHA03 |
| | | | | | | S26KL512SDABHB03x | 6KL512SDAHB03 |
| | | | | | | S26KL512SDABHM03x | 6KL512SDAHM03 |
| S26KL256S | DA | BH | A, B, M | 03 | 0, 3 | S26KL256SDABHA03x | 6KL256SDAHA03 |
| | | | | | | S26KL256SDABHB03x | 6KL256SDAHB03 |
| | | | | | | S26KL256SDABHM03x | 6KL256SDAHM03 |
| S26KL128S | DA | BH | A, B, M | 03 | 0, 3 | S26KL128SDABHA03x | 6KL128SDAHA03 |
| | | | | | | S26KL128SDABHB03x | 6KL128SDAHB03 |
| | | | | | | S26KL128SDABHM03x | 6KL128SDAHM03 |
| S26KS512S | DA, DG | BH | A, B, M | 03 | 0, 3 | S26KS512SDABHA03x | 6KS512SDAHA03 |
| | | | | | | S26KS512SDABHB03x | 6KS512SDAHB03 |
| | | | | | | S26KS512SDABHM03x | 6KS512SDAHM03 |
| | | | | | | S26KS512SDGBHA03x | 6KS512SDGHA03 |
| | | | | | | S26KS512SDGBHB03x | 6KS512SDGHB03 |
| | | | | | | S26KS512SDGBHM03x | 6KS512SDGHM03 |
| S26KS256S | DA, DG | BH | A, B, M | 03 | 0, 3 | S26KS256SDABHA03x | 6KS256SDAHA03 |
| | | | | | | S26KS256SDABHB03x | 6KS256SDAHB03 |
| | | | | | | S26KS256SDABHM03x | 6KS256SDAHM03 |
| | | | | | | S26KS256SDGBHA03x | 6KS256SDGHA03 |
| | | | | | | S26KS256SDGBHB03x | 6KS256SDGHB03 |
| | | | | | | S26KS256SDGBHM03x | 6KS256SDGHM03 |
| S26KS128S | DA, DG | BH | A, B, M | 03 | 0, 3 | S26KS128SDABHA03x | 6KS128SDAHA03 |
| | | | | | | S26KS128SDABHB03x | 6KS128SDAHB03 |
| | | | | | | S26KS128SDABHM03x | 6KS128SDAHM03 |
| | | | | | | S26KS128SDGBHA03x | 6KS128SDGHA03 |
| | | | | | | S26KS128SDGBHB03x | 6KS128SDGHB03 |
| | | | | | | S26KS128SDGBHM03x | 6KS128SDGHM03 |

14. Physical Interface

14.1 Physical Diagram

14.1.1 Fortified Ball Grid Array 24-ball 6 × 8 × 1.0 mm (VAA024)



15. Document History Page

| Document Title: S26KL512S / S26KS512S / S26KL256S / S26KS256S / S26KL128S / S26KS128S, 512 Mb (64 MB)/256 Mb (32 MB)/128 Mb (16 MB), 1.8V/3.0V HyperFlash™ Family | | | | |
|---|---------|-----------------|-----------------|--|
| Document Number: 001-99198 | | | | |
| Rev. | ECN No. | Orig. of Change | Submission Date | Description of Change |
| ** | – | RYSU | 04/23/2015 | Initial release |
| *A | – | RYSU | 06/12/2015 | Global: Changed 'continuous' to 'linear' Distinctive Characteristics: Removed 'Feature Variations by Density' table Signal Descriptions: HyperFlash Interface figure: updated HyperBus Protocol: Updated section Embedded Operations: Deep Power-Down: updated section Data Integrity: Program / Erase Endurance table: added Extended temperature, updated Minimum and Typical values Data Retention table: Updated Parameter; added Note Hardware Interface: Updated section Electrical Specifications: Updated section Timing Specifications: Updated section Physical Interface: Updated section Physical Diagrams: FBGA 25-Ball, 6 x 8 x 1 mm, 5x5 Array Package Outline Drawing: updated figure Ordering Part Numbers: Updated Valid Combinations: Added 'Package Marking' |
| *B | – | RYSU | 07/16/2015 | Distinctive Characteristics: Updated Endurance and Retention Embedded Algorithm Performance: Embedded Algorithm Characteristics table: removed Note 6 Data Integrity: Program / Erase Endurance table: updated Minimum values, removed Typical values Data Retention table: updated Parameter, removed Note Physical Interface: Updated section; Removed connection diagram and physical diagrams Ordering Information: Updated section Valid Combinations: Updated table |
| *C | 4854296 | MAMC | 07/24/2015 | Updated to Cypress template. |
| *D | 4936066 | MAMC | 09/29/2015 | Changed status from Advance to Final. Template updates: Removed cover page and Spansion Revision History. |
| *E | 5035685 | RYSU / CRLE | 12/14/2015 | Updated Electrical Specifications . Updated DC Characteristics (CMOS Compatible) : Changed maximum value of I _{DDP} parameter corresponding to "512 Mb @ 25 °C" from 15 µA to 18 µA. Added values of I _{DDP} parameter corresponding to "512 Mb @ 125 °C", "256 Mb @ 125 °C" and "128 Mb @ 125 °C". Updated Ordering Information . Updated Valid Combinations: Added Extended Temperature part numbers. |
| *F | 5463504 | SZZX | 10/25/2016 | Removed Confidential NDA designation from datasheet. Updated Features on page 1. Added Automotive, AEC-Q100 Grade to Features on page 1. Updated Performance Summary on page 2. Updated Figure 1, Logic Block Diagram on page 4. Removed Wear Leveling section. Updated Section 1.2.2.1, CRC Check-Value Calculation on page 7. Updated Figure 4, 24-Ball FBGA, 6 ´ 8 mm, 5 ´ 5 Ball Footprint, Top View[1, 2, 3] on page 9. Updated Figure 5, HyperFlash Interface on page 10. Added formula in Section 4.2 on page 12. Updated Table 3, Command / Address Bit Assignments on page 11. Updated Table 4, Maximum Operating Frequency for Latency Code Options on page 13. Updated tables in Section 5.1, Flash Memory Array on page 19. Updated tables in Section 6.2.9, Volatile and Non-Volatile Register Summary on page 33. Removed Confidential NDA designation from datasheet. |

| Document Title: S26KL512S / S26KS512S / S26KL256S / S26KS256S / S26KL128S / S26KS128S, 512 Mb (64 MB)/256 Mb (32 MB)/ 128 Mb (16 MB), 1.8V/3.0V HyperFlash™ Family | | | | |
|--|---------|-----------------|-----------------|--|
| Document Number: 001-99198 | | | | |
| Rev. | ECN No. | Orig. of Change | Submission Date | Description of Change |
| *F (contd.) | 5463504 | SZZX | 10/25/2016 | <p>Updated Features on page 1. Added Automotive, AEC-Q100 Grade to Features on page 1. Updated Performance Summary on page 2. Updated Figure 1, Logic Block Diagram on page 4. Removed Wear Leveling section. Updated Section 1.2.2.1, CRC Check-Value Calculation on page 7. Updated Figure 4, 24-Ball FBGA, 6 × 8 mm, 5 × 5 Ball Footprint, Top View[1, 2, 3] on page 9. Updated Figure 5, HyperFlash Interface on page 10. Added formula in Section 4.2 on page 12. Updated Table 3, Command / Address Bit Assignments on page 11. Updated Table 4, Maximum Operating Frequency for Latency Code Options on page 13. Updated tables in Section 5.1, Flash Memory Array on page 19. Updated tables in Section 6.2.9, Volatile and Non-Volatile Register Summary on page 33. Updated Table 44, DC Characteristics (CMOS Compatible) on page 74. Updated Section 10.5.1, Capacitance Characteristics on page 75. Updated tables in Section 10.5.1, Capacitance Characteristics on page 75. Updated Section 11.2.2, Read Transaction Diagrams on page 85. Updated tables Section 11.2.3, Read AC Parameters on page 85.. Updated Section 11.2.5, Write AC Parameters on page 87. Removed JEDEC SPI Reset Method section. Updated Section 12., Embedded Algorithm Performance on page 89. Updated Section 13., Ordering Information on page 90. Updated Section 13.2, Valid Combinations — Standard on page 91. Added Section 13.3, Valid Combinations — Automotive Grade / AEC-Q100 on page 93. Updated Section 14.1, Physical Diagram on page 95. Updated Copyright and Disclaimer.</p> |
| *G | 5569499 | SZZX | 12/29/2016 | <p>Updated Embedded Operations: Updated Program and Erase Summary: Updated Non-Volatile Configuration Register and Volatile Configuration Register: Updated Table 18 (Updated details corresponding to xVCR.2 bit). Updated Error Types and Clearing Procedures: Updated ECC Error: Updated Table 24 (Updated description below). Updated description and Table 25 in Address Trap Register (ATR). Updated description in Error Detection Counter. Updated Data Protection: Updated ASP Configuration Register: Updated Table 28 (Updated details corresponding to Bit 13 and Bit 9). Updated Device ID and Common Flash Interface (ID-CFI) ASO Map: Updated Device ID and Common Flash Interface (ID-CFI) ASO Map — Standard: Updated Table 34 (Updated details corresponding to Word Address “(SA) + 000Eh”). Updated Table 36 (Updated details corresponding to Word Address “(SA) + 001Bh”, “(SA) + 001Ch” and “(SA) + 0022h”). Updated Table 37 (Updated details corresponding to Word Address “(SA) + 0027h”). Updated Electrical Specifications: Updated Operating Ranges: Updated Power Supply Voltages: Replaced “1.7V to 2.0V” with “1.7V to 1.95V”. Updated Power-Up and Power-Down: Updated Table 47 (Updated maximum value of V_{CC} parameter). Updated Timing Specifications: Updated AC Characteristics: Updated Read Transaction Diagrams: Updated Figure 32 (Updated caption only (Removed “No Additional Latency Required”). Removed figure “Read Timing Diagram – With Additional Latency”. Updated Read AC Parameters: Updated Table 11.2.3: Removed t_{RWR}, t_{CSM} parameters and their details. Removed details corresponding to “HyperRAM Read Initial Access Time” of t_{ACC} parameter.</p> |

Document Title: S26KL512S / S26KS512S / S26KL256S / S26KS256S / S26KL128S / S26KS128S, 512 Mb (64 MB)/256 Mb (32 MB)/
128 Mb (16 MB), 1.8V/3.0V HyperFlash™ Family

Document Number: 001-99198

| Rev. | ECN No. | Orig. of Change | Submission Date | Description of Change |
|------------|---------|-----------------|-----------------|--|
| *G (cont.) | 5569499 | SZZX | 12/29/2016 | Updated Table : Removed details corresponding to “HyperRAM PSC transition to RWDS transition” of $t_{PSCRWDS}$ parameter. Updated Table : Removed details corresponding to “HyperRAM PSC transition to RWDS transition” of $t_{PSCRWDS}$ parameter. Removed “Write Transaction Diagrams”. Added Word Programming with Multiple Word Burst Data Load . Updated Write AC Parameters : Updated Table 58 : Removed t_{RWR} , t_{DMV} , t_{ACC} , t_{CSM} parameters and their details. Updated Embedded Algorithm Performance : Updated Table 60 : Added t_{CRCSL} , t_{CRCS} , t_{CRC_SETUP} , CRC Calculation Rate parameters and their details. |
| *H | 5621104 | SZZX | 02/06/2017 | Updated Embedded Operations - ASP register Updated Software Interface Reference - Removed xVCR0/1 references. Updated Sales and Copyright information. |
| *I | 5844610 | SZZX | 08/10/2017 | Updated template. Updated Sales page and Copyright information. Changed 24-Ball FBGA package pin A3 to DNU. Added Thermal Impedance . |
| *J | 5865248 | SZZX | 08/28/2017 | Updated Ordering Part Numbers . Updated Table 50 . |
| *K | 6172250 | SZZX | 06/01/2018 | Added Active Clock Stop Waveforms. Word Program timing is made identical to 6-Byte Program timing. Removed Section 10.8.1 Active Clock Stop. Updated Sales page. |

Sales, Solutions, and Legal Information

Worldwide Sales and Design Support

Cypress maintains a worldwide network of offices, solution centers, manufacturer's representatives, and distributors. To find the office closest to you, visit us at [Cypress Locations](#).

Products

| | |
|---|--|
| Arm [®] Cortex [®] Microcontrollers | cypress.com/arm |
| Automotive | cypress.com/automotive |
| Clocks & Buffers | cypress.com/clocks |
| Interface | cypress.com/interface |
| Internet of Things | cypress.com/iot |
| Memory | cypress.com/memory |
| Microcontrollers | cypress.com/mcu |
| PSoC | cypress.com/psoc |
| Power Management ICs | cypress.com/pmic |
| Touch Sensing | cypress.com/touch |
| USB Controllers | cypress.com/usb |
| Wireless Connectivity | cypress.com/wireless |

PSoC[®] Solutions

[PSoC 1](#) | [PSoC 3](#) | [PSoC 4](#) | [PSoC 5LP](#) | [PSoC 6 MCU](#)

Cypress Developer Community

[Community](#) | [Projects](#) | [Video](#) | [Blogs](#) | [Training](#) | [Components](#)

Technical Support

cypress.com/support

© Cypress Semiconductor Corporation, 2015-2018. This document is the property of Cypress Semiconductor Corporation and its subsidiaries, including Spansion LLC ("Cypress"). This document, including any software or firmware included or referenced in this document ("Software"), is owned by Cypress under the intellectual property laws and treaties of the United States and other countries worldwide. Cypress reserves all rights under such laws and treaties and does not, except as specifically stated in this paragraph, grant any license under its patents, copyrights, trademarks, or other intellectual property rights. If the Software is not accompanied by a license agreement and you do not otherwise have a written agreement with Cypress governing the use of the Software, then Cypress hereby grants you a personal, non-exclusive, nontransferable license (without the right to sublicense) (1) under its copyright rights in the Software (a) for Software provided in source code form, to modify and reproduce the Software solely for use with Cypress hardware products, only internally within your organization, and (b) to distribute the Software in binary code form externally to end users (either directly or indirectly through resellers and distributors), solely for use on Cypress hardware product units, and (2) under those claims of Cypress's patents that are infringed by the Software (as provided by Cypress, unmodified) to make, use, distribute, and import the Software solely for use with Cypress hardware products. Any other use, reproduction, modification, translation, or compilation of the Software is prohibited.

TO THE EXTENT PERMITTED BY APPLICABLE LAW, CYPRESS MAKES NO WARRANTY OF ANY KIND, EXPRESS OR IMPLIED, WITH REGARD TO THIS DOCUMENT OR ANY SOFTWARE OR ACCOMPANYING HARDWARE, INCLUDING, BUT NOT LIMITED TO, THE IMPLIED WARRANTIES OF MERCHANTABILITY AND FITNESS FOR A PARTICULAR PURPOSE. No computing device can be absolutely secure. Therefore, despite security measures implemented in Cypress hardware or software products, Cypress does not assume any liability arising out of any security breach, such as unauthorized access to or use of a Cypress product. In addition, the products described in these materials may contain design defects or errors known as errata which may cause the product to deviate from published specifications. To the extent permitted by applicable law, Cypress reserves the right to make changes to this document without further notice. Cypress does not assume any liability arising out of the application or use of any product or circuit described in this document. Any information provided in this document, including any sample design information or programming code, is provided only for reference purposes. It is the responsibility of the user of this document to properly design, program, and test the functionality and safety of any application made of this information and any resulting product. Cypress products are not designed, intended, or authorized for use as critical components in systems designed or intended for the operation of weapons, weapons systems, nuclear installations, life-support devices or systems, other medical devices or systems (including resuscitation equipment and surgical implants), pollution control or hazardous substances management, or other uses where the failure of the device or system could cause personal injury, death, or property damage ("Unintended Uses"). A critical component is any component of a device or system whose failure to perform can be reasonably expected to cause the failure of the device or system, or to affect its safety or effectiveness. Cypress is not liable, in whole or in part, and you shall and hereby do release Cypress from any claim, damage, or other liability arising from or related to all Unintended Uses of Cypress products. You shall indemnify and hold Cypress harmless from and against all claims, costs, damages, and other liabilities, including claims for personal injury or death, arising from or related to any Unintended Uses of Cypress products.

Cypress, the Cypress logo, Spansion, the Spansion logo, and combinations thereof, WICED, PSoC, CapSense, EZ-USB, F-RAM, and Traveo are trademarks or registered trademarks of Cypress in the United States and other countries. For a more complete list of Cypress trademarks, visit cypress.com. Other names and brands may be claimed as property of their respective owners.



Стандарт Электрон Связь

Мы молодая и активно развивающаяся компания в области поставок электронных компонентов. Мы поставляем электронные компоненты отечественного и импортного производства напрямую от производителей и с крупнейших складов мира.

Благодаря сотрудничеству с мировыми поставщиками мы осуществляем комплексные и плановые поставки широчайшего спектра электронных компонентов.

Собственная эффективная логистика и склад в обеспечивает надежную поставку продукции в точно указанные сроки по всей России.

Мы осуществляем техническую поддержку нашим клиентам и предпродажную проверку качества продукции. На все поставляемые продукты мы предоставляем гарантию .

Осуществляем поставки продукции под контролем ВП МО РФ на предприятия военно-промышленного комплекса России , а также работаем в рамках 275 ФЗ с открытием отдельных счетов в уполномоченном банке. Система менеджмента качества компании соответствует требованиям ГОСТ ISO 9001.

Минимальные сроки поставки, гибкие цены, неограниченный ассортимент и индивидуальный подход к клиентам являются основой для выстраивания долгосрочного и эффективного сотрудничества с предприятиями радиоэлектронной промышленности, предприятиями ВПК и научно-исследовательскими институтами России.

С нами вы становитесь еще успешнее!

Наши контакты:

Телефон: +7 812 627 14 35

Электронная почта: sales@st-electron.ru

Адрес: 198099, Санкт-Петербург,
Промышленная ул, дом № 19, литера Н,
помещение 100-Н Офис 331