

■ Features :

- Constant current output: 300mA to 1000mA
- Wide input voltage: 9 ~ 56VDC
- Wide output LED string voltage: 2 ~ 52VDC
- High efficiency up to 97%
- DC/DC step-down converter
- Built-in EMI filter, comply with EN55015 and FCC part15 without additional input filter and capacitors
- Built-in PWM and remote ON/OFF control
- Protections: Short circuit / Over temperature
- Cooling by free air convection
- Fully encapsulated with IP67 level
- Compact size
- Low cost, high reliability
- Suitable for driving illumination LED
- 3 years warranty



LDD-350H Blank : pin style
 W : wire style

SPECIFICATION

ORDER NO.		LDD-300H <input type="checkbox"/>	LDD-350H <input type="checkbox"/>	LDD-500H <input type="checkbox"/>	LDD-600H <input type="checkbox"/>	LDD-700H <input type="checkbox"/>	LDD-1000H <input type="checkbox"/>	
OUTPUT	CURRENT RANGE	300mA	350mA	500mA	600mA	700mA	1000mA	
	VOLTAGE RANGE	2 ~ 52VDC						
	CURRENT ACCURACY (Typ.)	±3% at 24VDC input ; ±4% at 48VDC input						
	RIPPLE & NOISE(max.) Note.2	150mVp-p	150mVp-p	150mVp-p	200mVp-p	200mVp-p	350mVp-p	
	SWITCHING FREQUENCY	40KHz ~ 1000KHz						
	EXTERNAL CAPACITANCE LOAD (max.)	2.2uF						
INPUT	VOLTAGE RANGE	9 ~ 56VDC						
	EFFICIENCY (max.)	97% at full load and 36VDC/48VDC input						
	DC CURRENT	Full load Note.3	270mA	320mA	450mA	550mA	650mA	900mA
		No load	10mA					
FILTER	Capacitor							
PWM DIMMING & ON/OFF CONTROL	REMOTE ON/OFF	Leave open if not use Power ON with dimming: DIM ~ -Vin >2.5 ~ 6VDC or open circuit Power OFF : DIM ~ -Vin < 0.8VDC or short						
	PWM FREQUENCY	100 ~ 1KHz						
	QUIESCENT INPUT CURRENT IN SHUTDOWN MODE(max.)	1mA at PWM dimming OFF and 24VDC input						
PROTECTION	SHORT CIRCUIT	Regulated at rated output current Protection type : Can be continued, recovers automatically after fault condition is removed						
	OVER TEMPERATURE	Tj 150°C typically(IC1) detect on main control IC Protection type : Shut down, recovers automatically after temperature goes down						
ENVIRONMENT	WORKING TEMP.	-40 ~ + 85°C (Refer to derating curve)						
	WORKING HUMIDITY	20% ~ 90% RH non-condensing						
	STORAGE TEMP., HUMIDITY	-55 ~ +125°C, 10 ~ 95% RH						
	TEMP. COEFFICIENT	±0.03% / °C						
	VIBRATION	10 ~ 500Hz, 2G 10min./1 cycle, period for 60min. each along X, Y, Z axes						
	OPERATING CASE TEMP. (max.)	100°C						
EMC	EMI CONDUCTION & RADIATION	Compliance to EN55015, FCC part 15 class B						
	EMS IMMUNITY	Compliance to EN61000-4-2,3,4,6,8, light industry level, criteria A						
OTHERS	MTBF	2000Khrs min. MIL-HDBK-217F (25°C)						
	DIMENSION	31.8*20.3*12.2mm or 1.25**0.8**0.48" inch (L*W*H)						
	WEIGHT	LDD-H:16g ; LDD-HW:18.6g						
	POTTING MATERIAL	Epoxy(UL94-V0)						
NOTE	1. All parameters are specified at normal input(48VDC), rated load, 25°C 70% RH ambient. 2. Ripple & noise are measured at 20MHz by using a 12" twisted pair terminated with a 0.1uf capacitor. 3. Test condition: 48VDC input.							

■ Mechanical Specification

Blank type(LDD – __H):

Unit: mm (inch)

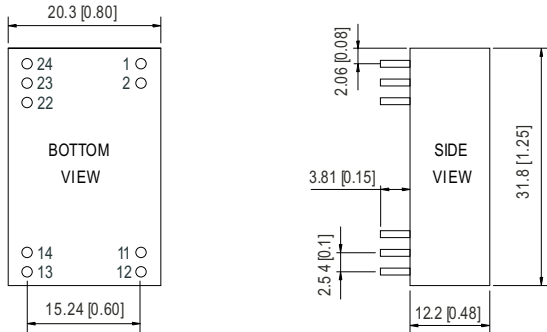

NOTE: Pin size tolerance 0.60 ϕ \pm 0.05mm

W type(LDD – __HW):

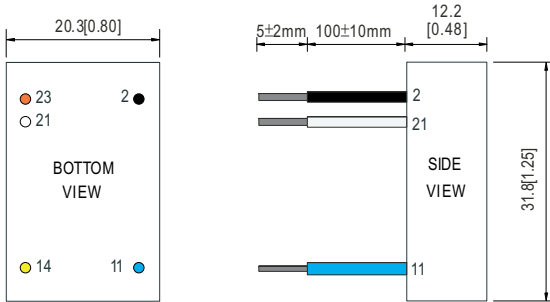

■ Derating Curve

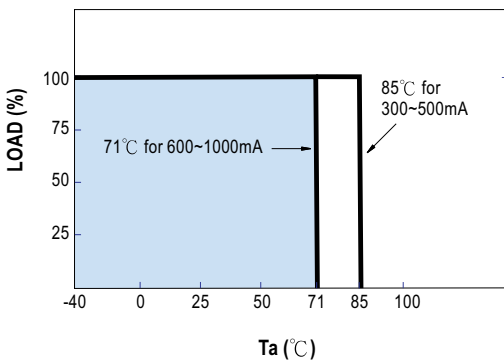

■ Pin Configuration

Pin No.	Output	Comment
1,2	-Vin	Don't connect to -Vout
11,12	-Vout	LED - Connection
13,14	+Vout	LED + Connection
22	PWM DIM	ON/OFF and PWM Dimming (Leave open if not used)
23,24	+Vin	DC Supply

Pin No.	Output	Comment
2	-Vin (Black)	Don't connect to -Vout
11	-Vout (Blue)	LED - Connection
14	+Vout (Yellow)	LED + Connection
21	PWM DIM (White)	ON/OFF and PWM Dimming (Leave open if not used)
23	+Vin (Red)	DC Supply

■ PWM Dimming Control

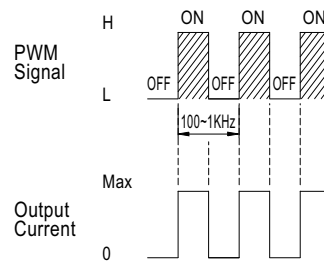

© During PWM dimming operation, the output current will change to PWM style.

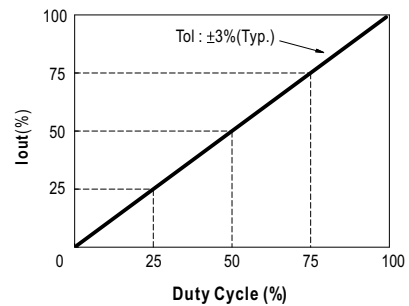

Standard Application

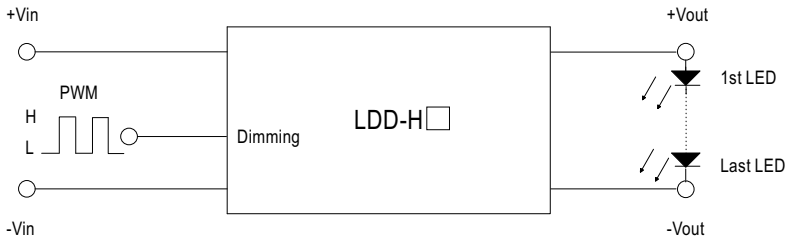

H: >2.5~6VDC or open circuit

L: <0.8VDC or short

Efficiency VS Output Voltage(Number of LEDs)

Fig-1 12VDC input, 1~3 LEDs(Vf=3V)

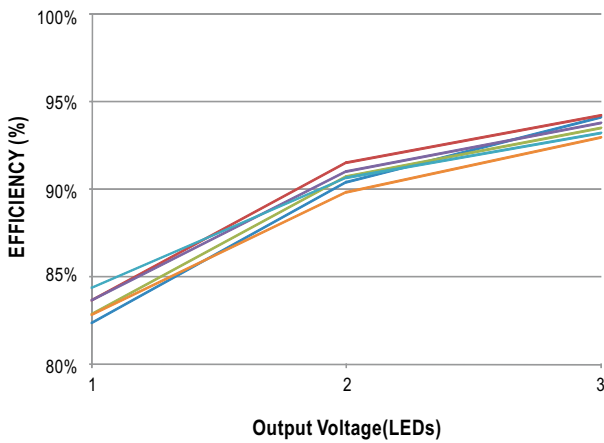

Fig-2 24VDC input, 1~7 LEDs(Vf=3V)

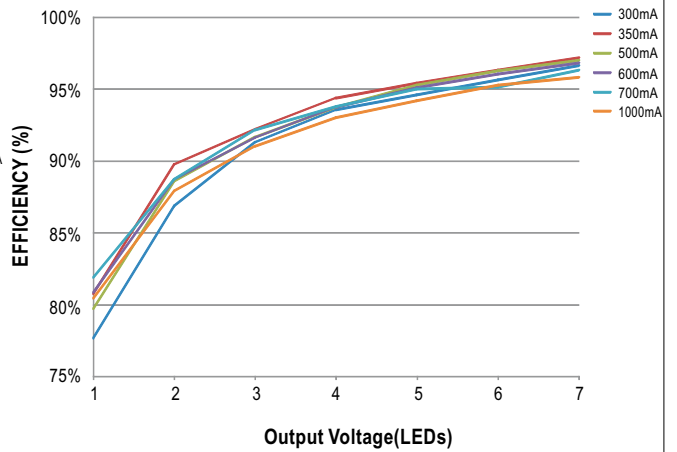

Fig-3 36VDC input, 1~10 LEDs(Vf=3V)

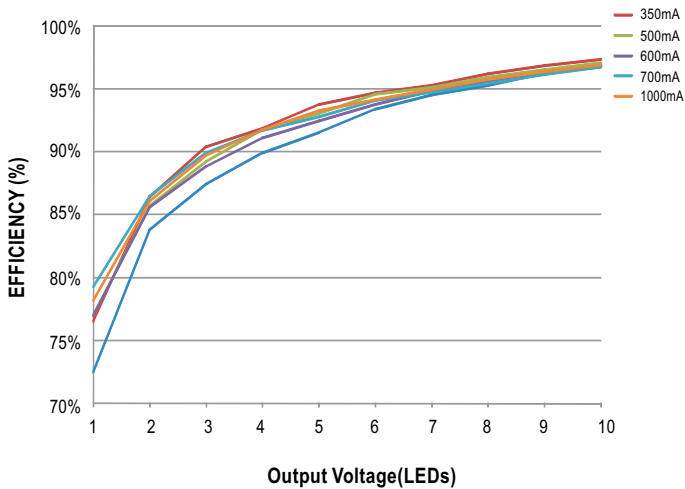
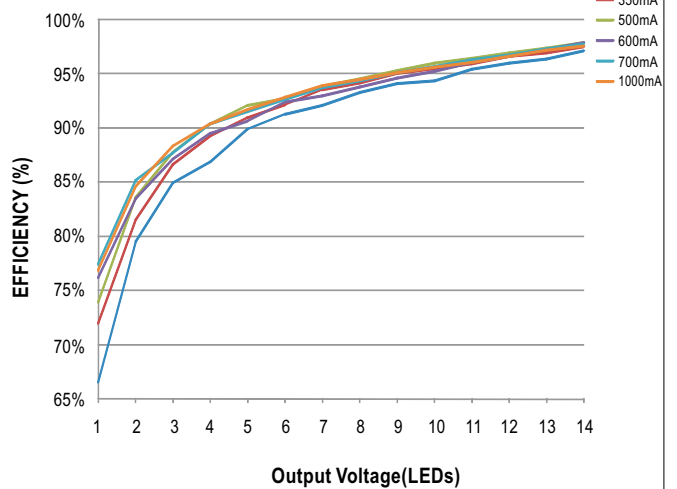

Fig-4 48VDC input, 1~14 LEDs(Vf=3V)





Стандарт Электрон Связь

Мы молодая и активно развивающаяся компания в области поставок электронных компонентов. Мы поставляем электронные компоненты отечественного и импортного производства напрямую от производителей и с крупнейших складов мира.

Благодаря сотрудничеству с мировыми поставщиками мы осуществляем комплексные и плановые поставки широчайшего спектра электронных компонентов.

Собственная эффективная логистика и склад в обеспечивает надежную поставку продукции в точно указанные сроки по всей России.

Мы осуществляем техническую поддержку нашим клиентам и предпродажную проверку качества продукции. На все поставляемые продукты мы предоставляем гарантию .

Осуществляем поставки продукции под контролем ВП МО РФ на предприятия военно-промышленного комплекса России , а также работаем в рамках 275 ФЗ с открытием отдельных счетов в уполномоченном банке. Система менеджмента качества компании соответствует требованиям ГОСТ ISO 9001.

Минимальные сроки поставки, гибкие цены, неограниченный ассортимент и индивидуальный подход к клиентам являются основой для выстраивания долгосрочного и эффективного сотрудничества с предприятиями радиоэлектронной промышленности, предприятиями ВПК и научно-исследовательскими институтами России.

С нами вы становитесь еще успешнее!

Наши контакты:

Телефон: +7 812 627 14 35

Электронная почта: sales@st-electron.ru

Адрес: 198099, Санкт-Петербург,
Промышленная ул, дом № 19, литера Н,
помещение 100-Н Офис 331