

Driver Characteristics

Parameter	Rating	Units
V_{OFFSET}	600	V
$I_{\text{O} \pm}$ (Source/Sink)	2/2	A
V_{OUT}	10-20	V
$t_{\text{on}}/t_{\text{off}}$	113/100	ns
Delay Matching (Max)	20	ns

Features

- Floating Channel for Bootstrap Operation to +600V with Absolute Maximum Rating of +700V
- Outputs Capable of Sourcing and Sinking 2A
- Gate Drive Supply Range From 10V to 20V
- Enhanced Robustness due to SOI Process
- Tolerant to Negative Voltage Transients: dV/dt Immune
- 3.3V Logic Compatible
- Undervoltage Lockout for Both High-side and Low-Side Outputs
- Matched Propagation Delays

Description

The IX2113 is a high voltage integrated circuit that can drive high speed MOSFETs and IGBTs that operate at up to +600V. The IX2113 is configured with independent high-side and low-side referenced output channels, both of which can source and sink 2A. The floating high-side channel can drive an N-channel power MOSFET or IGBT 600V from the common reference.

Manufactured on IXYS Integrated Circuits Division's proprietary high-voltage BCDMOS on SOI (silicon on insulator) process, the IX2113 is extremely robust, and is virtually immune to negative transients. The UVLO circuit prevents the turn-on of the MOSFET or IGBT until there is sufficient V_{BS} or V_{CC} supply voltage. Propagation delays are matched for use in high frequency applications.

The IX2113 is available in a 14-pin DIP package and in a 16-pin SOIC package.

Ordering Information

Part	Description
IX2113G	14-Pin DIP (25/Tube)
IX2113B	16-Pin SOIC (50/Tube)
IX2113BTR	16-Pin SOIC (1000/Reel)

IX2113 Functional Block Diagram

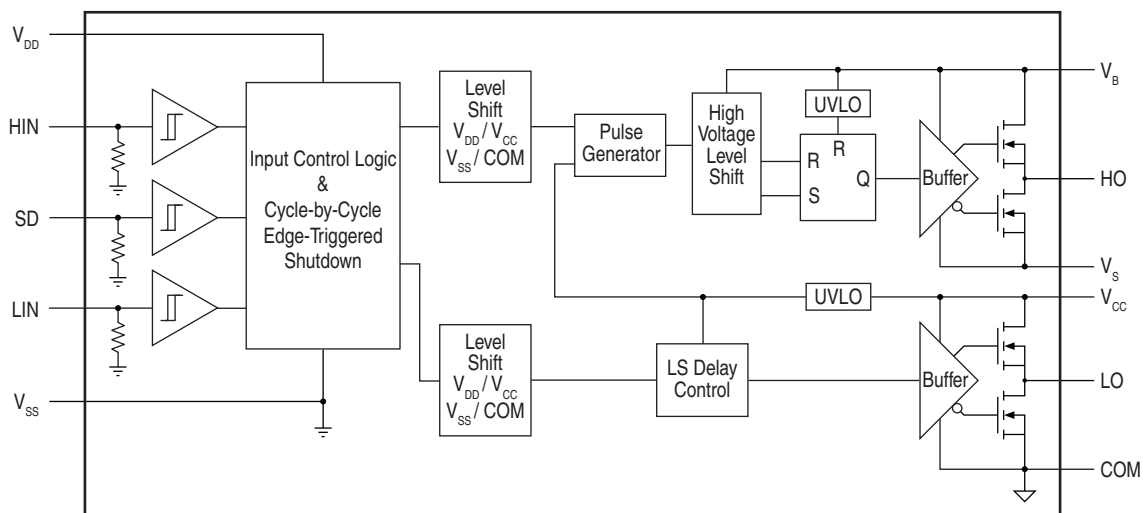

1. Specifications	3
1.1 Package Pinout: 16-Pin SOIC Package	3
1.2 Pin Description: 16-Pin SOIC Package	3
1.3 Package Pinout: 14-Pin DIP Package	3
1.4 Pin Description: 14-Pin DIP Package	3
1.5 Absolute Maximum Ratings	4
1.6 Recommended Operating Conditions	4
1.7 Dynamic Electrical Characteristics	5
1.8 Static Electrical Characteristics	5
1.9 Test Waveforms	6
2. Typical Performance Data	7
3. Manufacturing Information	11
3.1 Moisture Sensitivity	11
3.2 ESD Sensitivity	11
3.3 Reflow Profile	11
3.4 Board Wash	11
3.5 Mechanical Dimensions	12

1 Specifications

1.1 Package Pinout: 16-Pin SOIC Package

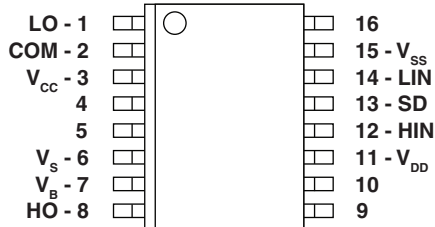

1.3 Package Pinout: 14-Pin DIP Package

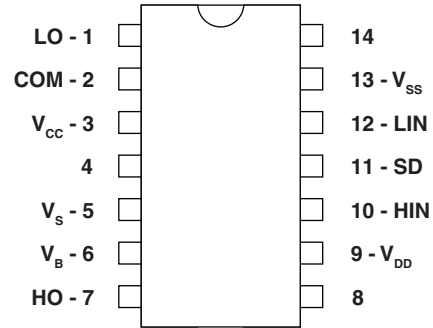

1.2 Pin Description: 16-Pin SOIC Package

Pin#	Name	Description
1	LO	Low-Side Gate Drive Output
2	COM	Low-Side Return
3	V_{CC}	Low-Side Supply
4	-	No Connection
5	-	No Connection
6	V_S	High-Side Floating Supply Return
7	V_B	High-Side Floating Supply
8	HO	High-Side Gate Drive Output
9	-	No Connection
10	-	No Connection
11	V_{DD}	Logic Supply
12	HIN	Logic Input for High-Side Gate Driver Output (HO), In-Phase
13	SD	Logic Input for Shutdown
14	LIN	Logic Input for Low-Side Gate Driver Output (LO), In-Phase
15	V_{SS}	Logic Ground
16	-	No Connection

1.4 Pin Description: 14-Pin DIP Package

Pin#	Name	Description
1	LO	Low-Side Gate Drive Output
2	COM	Low-Side Return
3	V_{CC}	Low-Side Supply
4	-	No Connection
5	V_S	High-Side Floating Supply Return
6	V_B	High-Side Floating Supply
7	HO	High-Side Gate Drive Output
8	-	No Connection
9	V_{DD}	Logic Supply
10	HIN	Logic Input for High-Side Gate Driver Output (HO), In-Phase
11	SD	Logic Input for Shutdown
12	LIN	Logic Input for Low-Side Gate Driver Output (LO), In-Phase
13	V_{SS}	Logic Ground
14	-	No Connection

1.5 Absolute Maximum Ratings

Absolute maximum ratings indicate sustained limits beyond which damage to the device may occur. All voltage parameters are absolute voltages referenced to COM. The thermal resistance and power dissipation ratings are measured under board-mounted and still-air conditions.

Parameter	Symbol	Min	Max	Units	
High-Side Floating Supply Voltage	V_B	-0.3	700	V	
High-Side Floating Supply Offset Voltage	V_S	V_B-20	$V_B+0.3$	V	
High-Side Floating Output Voltage	V_{HO}	$V_S-0.3$	$V_B+0.3$	V	
Low-Side Fixed Supply Voltage	V_{CC}	-0.3	20	V	
Low-Side Output Voltage	V_{LO}	-0.3	$V_{CC}+0.3$	V	
Logic Supply Voltage	V_{DD}	-0.3	$V_{SS}+20$	V	
Logic Supply Offset Voltage	V_{SS}	$V_{CC}-20$	$V_{CC}+0.3$	V	
Logic Input Voltage (HIN, LIN, SD)	V_{IN}	$V_{SS}-0.3$	$V_{DD}+0.3$	V	
Allowable Offset Supply Voltage Transient	dV_S/dt	-	50	V/ns	
Package Power Dissipation @ $T_A \leq 25^\circ\text{C}$	16-Pin SOIC	PD	-	1.25	W
	14-Pin DIP			1.6	
Thermal Resistance, Junction to Ambient	16-Pin SOIC	$R_{\theta JA}$	-	100	$^\circ\text{C/W}$
	14-Pin DIP			75	
Junction Temperature	T_J	-	150	$^\circ\text{C}$	
Storage Temperature	T_S	-55	150	$^\circ\text{C}$	
Lead Temperature (Soldering, 10 Seconds)	T_L	-	300	$^\circ\text{C}$	

1.6 Recommended Operating Conditions

For proper operation, the device should be used within the recommended conditions. The V_S and V_{SS} offset ratings are tested with all supplies biased at a 15V differential.

Parameter	Symbol	Min	Max	Units
High-Side Floating Supply Absolute Voltage	V_B	V_S+10	V_S+20	V
High-Side Floating Supply Offset Voltage	V_S	-	600	
High-Side Floating Output Voltage	V_{HO}	V_S	V_B	
Low-Side Fixed Supply Voltage	V_{CC}	10	20	
Low-Side Output Voltage	V_{LO}	0	V_{CC}	
Logic Supply Voltage	V_{DD}	$V_{SS}+3$	$V_{SS}+20$	
Logic Supply Offset Voltage	V_{SS}	-5	5	
Logic Input Voltage (HIN, LIN, SD)	V_{IN}	V_{SS}	V_{DD}	
Ambient Temperature	T_A	-40	+125	$^\circ\text{C}$

1.7 Dynamic Electrical Characteristics
 V_{BIAS} (V_{CC} , V_{BS} , V_{DD})=15V, C_L =1000 pF, T_A =25°C, and V_{SS} =COM unless otherwise specified.

Parameter	Conditions	Symbol	Min	Typ	Max	Units
Turn-On propagation Delay	$V_S=0V$	t_{on}	-	113	160	ns
Turn-Off propagation Delay	$V_S=600V$	t_{off}	-	100	150	
Shutdown propagation Delay		t_{SD}	-	94	160	
Turn-On Rise Time	-	t_r	-	9.4	35	
Turn-Off Fall Time	-	t_f	-	9.7	25	
Delay Matching, HS & LS Turn-On/Off	-	MT	-	-	20	

1.8 Static Electrical Characteristics
 V_{BIAS} (V_{CC} , V_{BS} , V_{DD})=15V, T_A =25°C and V_{SS} =COM unless otherwise specified. The V_{IN} , V_{TH} , and I_{IN} parameters are referenced to V_{SS} and are applicable to all three logic input leads: HIN, LIN, and SD. The V_O and I_O parameters are referenced to COM and are applicable to the respective output leads: HO or LO.

Parameter	Conditions	Symbol	Min	Typ	Max	Units
Logic "1" Input Voltage	$V_{DD}=15V$	V_{IH}	9.5	-	-	V
Logic "0" Input Voltage		V_{IL}	-	-	6	
Logic "1" Input Voltage	$V_{DD}=3V$	V_{IH}	2.5	-	-	V
Logic "0" Input Voltage		V_{IL}	-	-	0.8	
High-Level Output Voltage, $V_{BIAS}-V_O$	$I_O=0A$	V_{OH}	-	1.6	2.5	V
Low-Level Output Voltage, V_O	$I_O=20mA$	V_{OL}	-	-	0.15	
Offset Supply Leakage Current	$V_B=V_S=600V$	I_{LK}	-	-	60	μA
Quiescent V_{BS} Supply Current	$V_{IN}=0V$ or V_{DD}	I_{QBS}	-	187	310	
Quiescent V_{CC} Supply Current	$V_{IN}=0V$ or V_{DD}	I_{QCC}	-	300	420	
Quiescent V_{DD} Supply Current	$V_{IN}=0V$ or V_{DD}	I_{QDD}	-	-	1	
Logic "1" Input Bias Current	$V_{IN}=V_{DD}$	I_{IN+}	-	22	40	μA
Logic "0" Input Bias Current	$V_{IN}=0V$	I_{IN-}	-	-	5	
V_{BB} Supply Undervoltage Positive Going Threshold	-	V_{BSUV+}	7.5	8.4	9.7	V
V_{BB} Supply Undervoltage Negative Going Threshold	-	V_{BSUV-}	7	7.8	9.4	
V_{CC} Supply Undervoltage Positive Going Threshold	-	V_{CCUV+}	7.4	8.4	9.6	
V_{CC} Supply Undervoltage Negative Going Threshold	-	V_{CCUV-}	7	7.8	9.4	
Output High Short Circuit Pulsed Current	$V_O=0V$, $V_{IN}=V_{DD}$, $PW \leq 10\mu s$	I_{O+}	2	2.5	-	A
Output Low Short Circuit Pulsed Current	$V_O=15V$, $V_{IN}=0V$, $PW \leq 10\mu s$	I_{O-}	2	2.5	-	

1.9 Test Waveforms

1.9.1 Switching Time Test Circuit

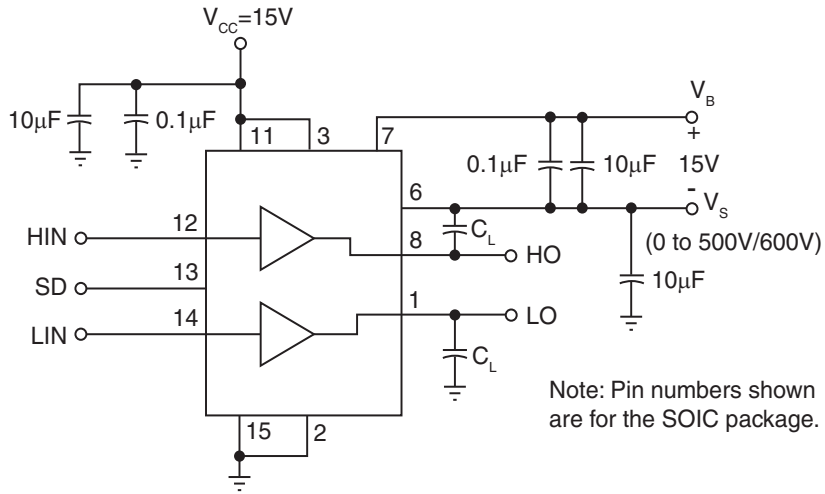

1.9.2 Input/Output Timing Diagram

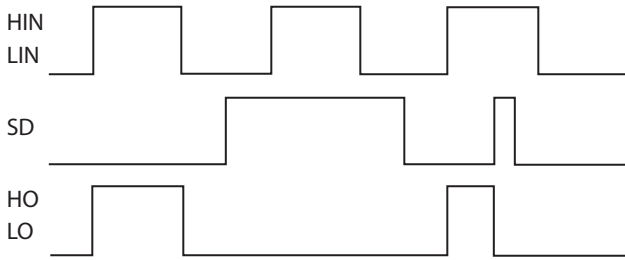

1.9.4 Shutdown Waveform Definitions

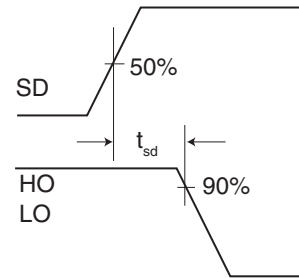

1.9.3 Switching Time Waveform Definition

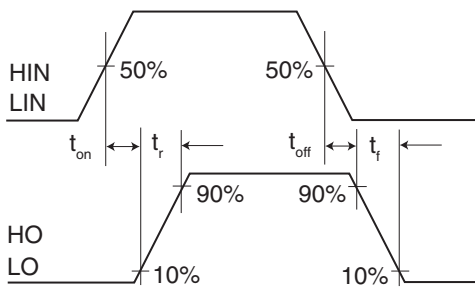

1.9.5 Delay Matching Waveform Definitions

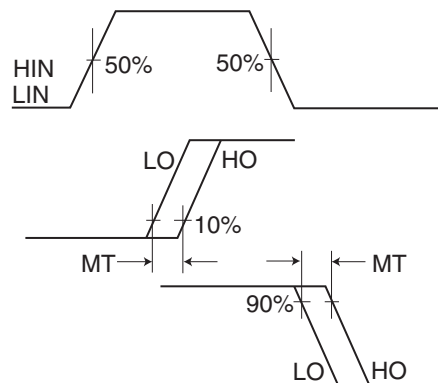

2 Typical Performance Data

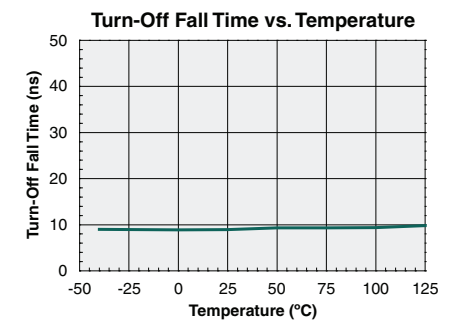
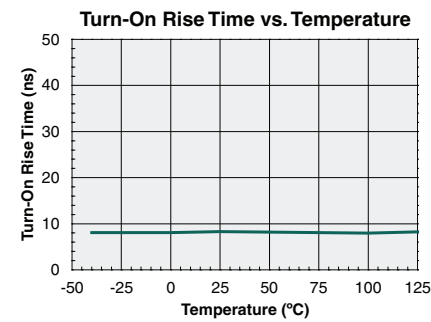
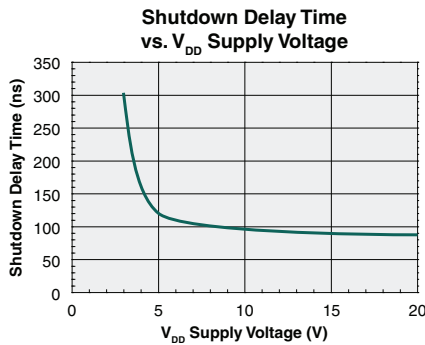
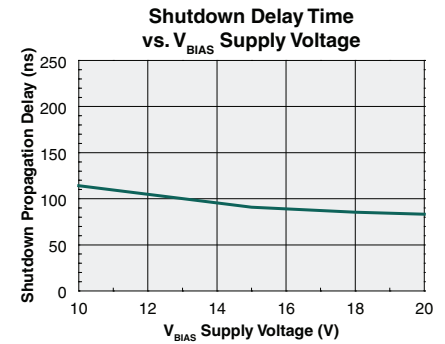
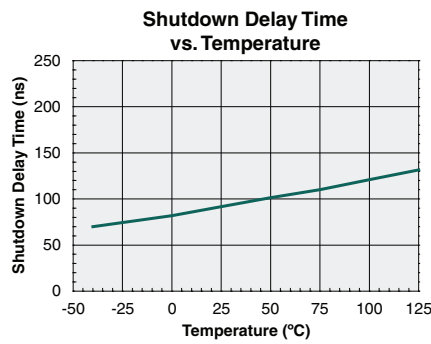
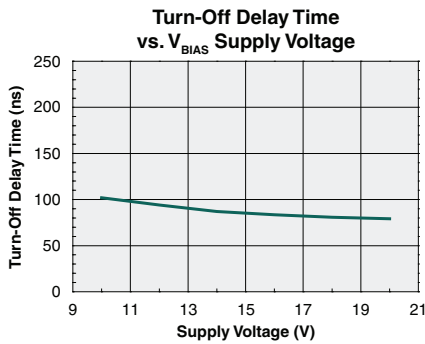
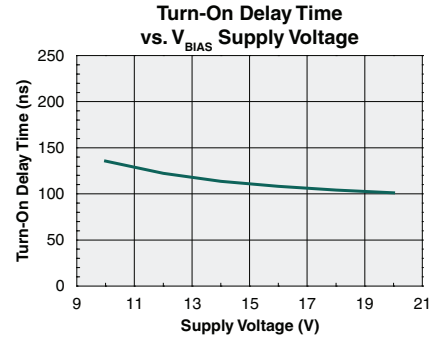
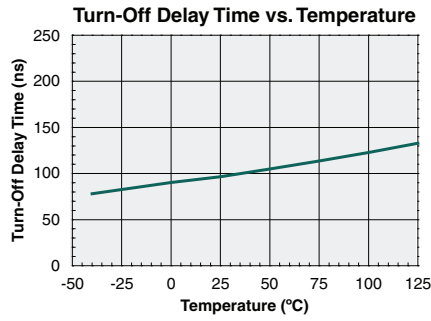
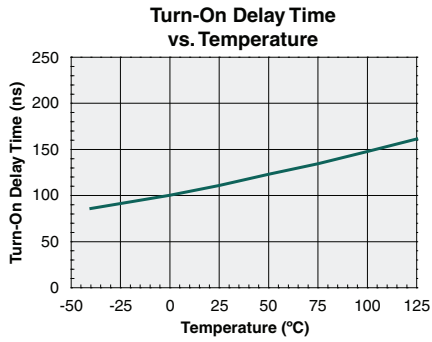

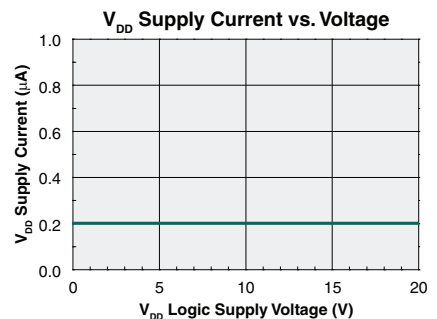
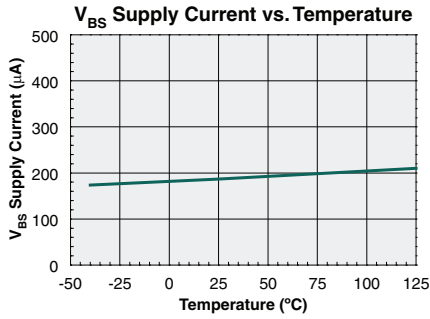
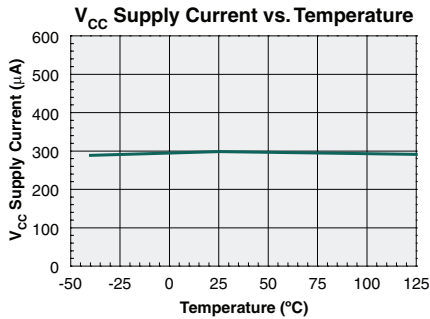
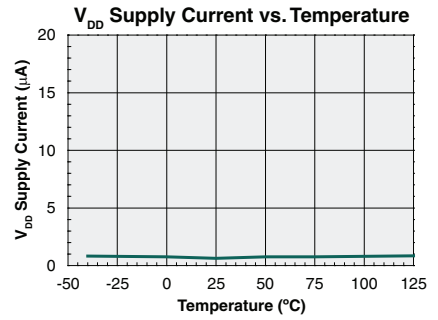
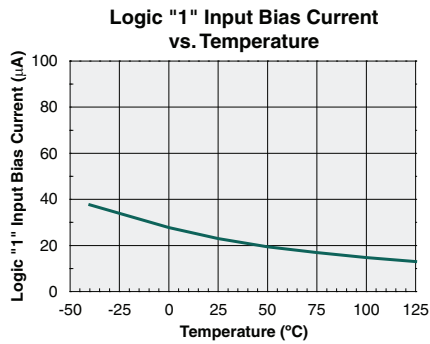
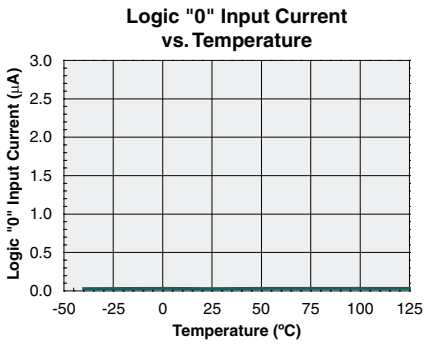
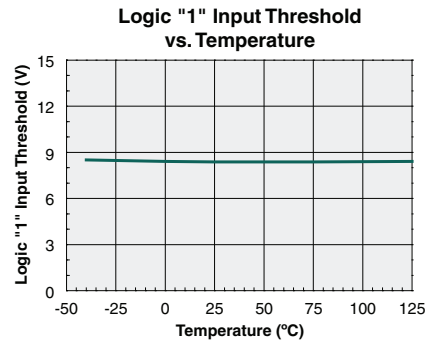
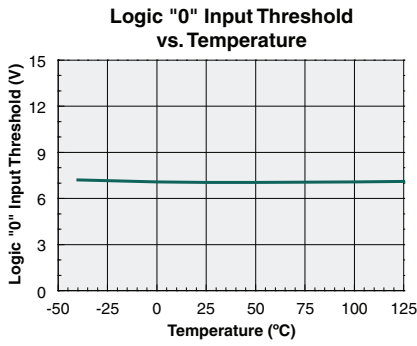
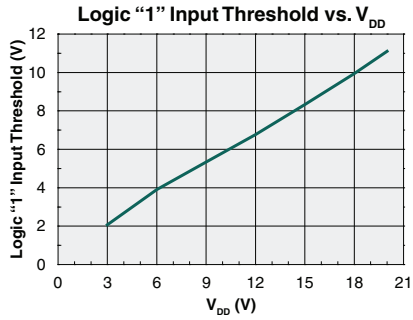
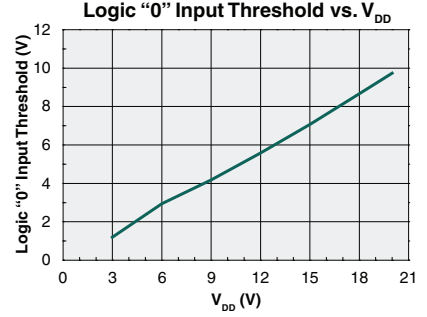
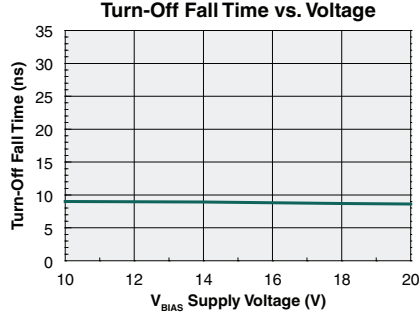
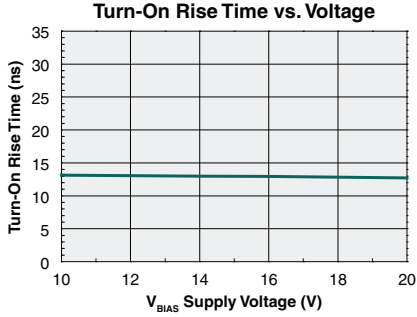

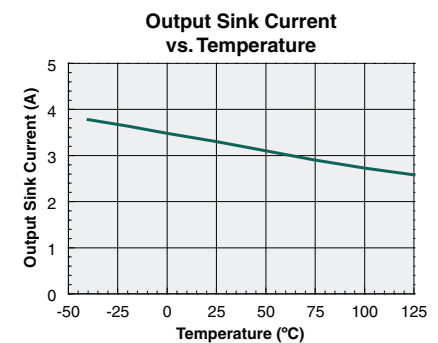
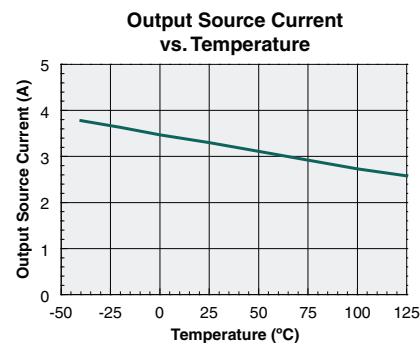
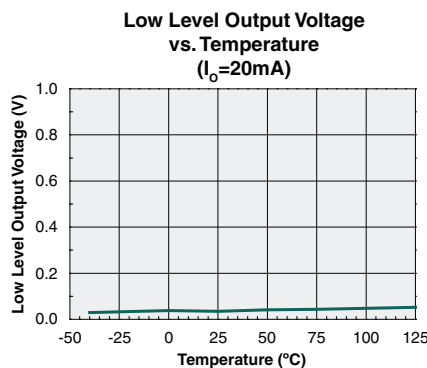
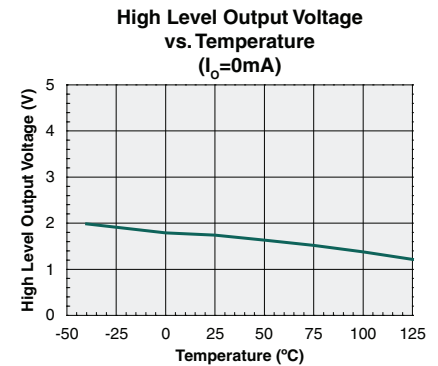
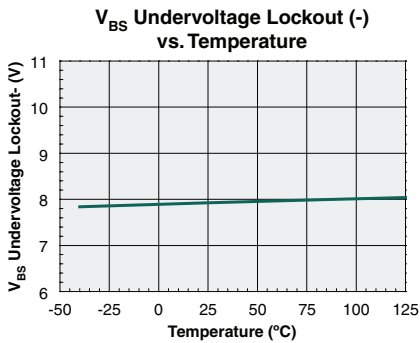
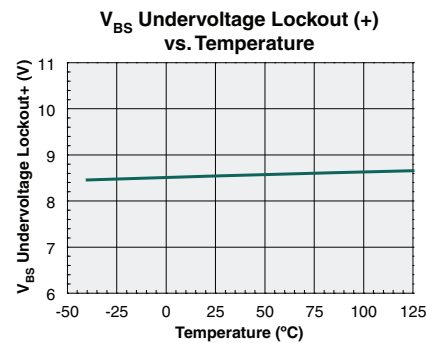
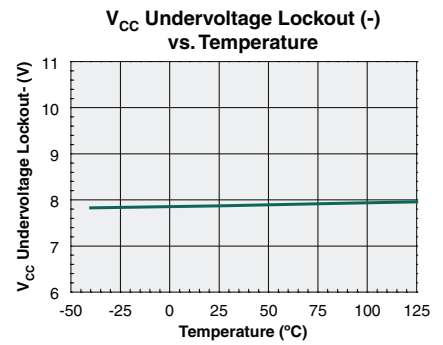
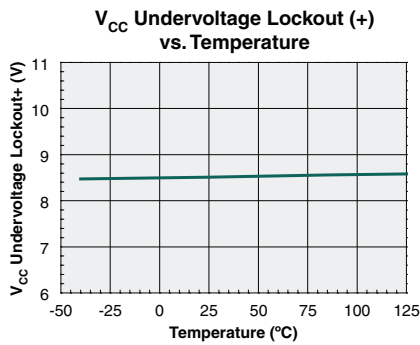
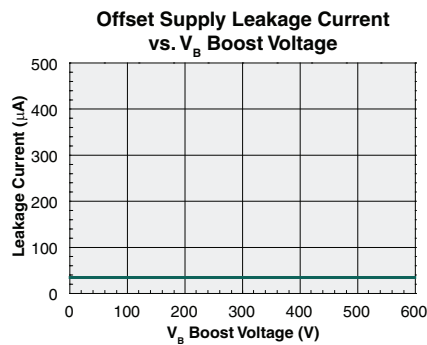
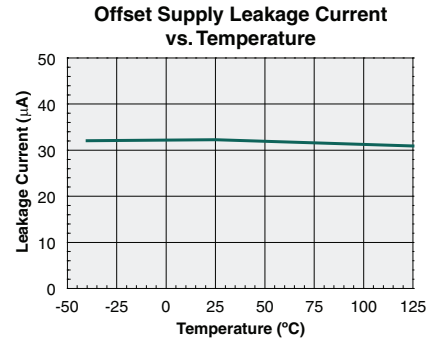
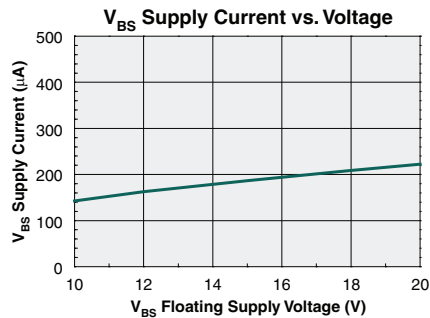
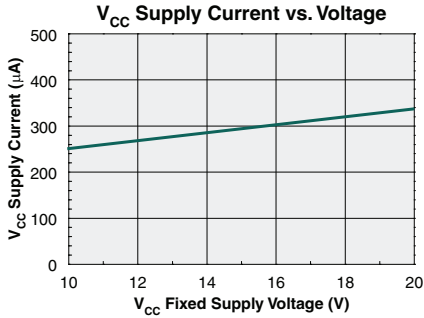

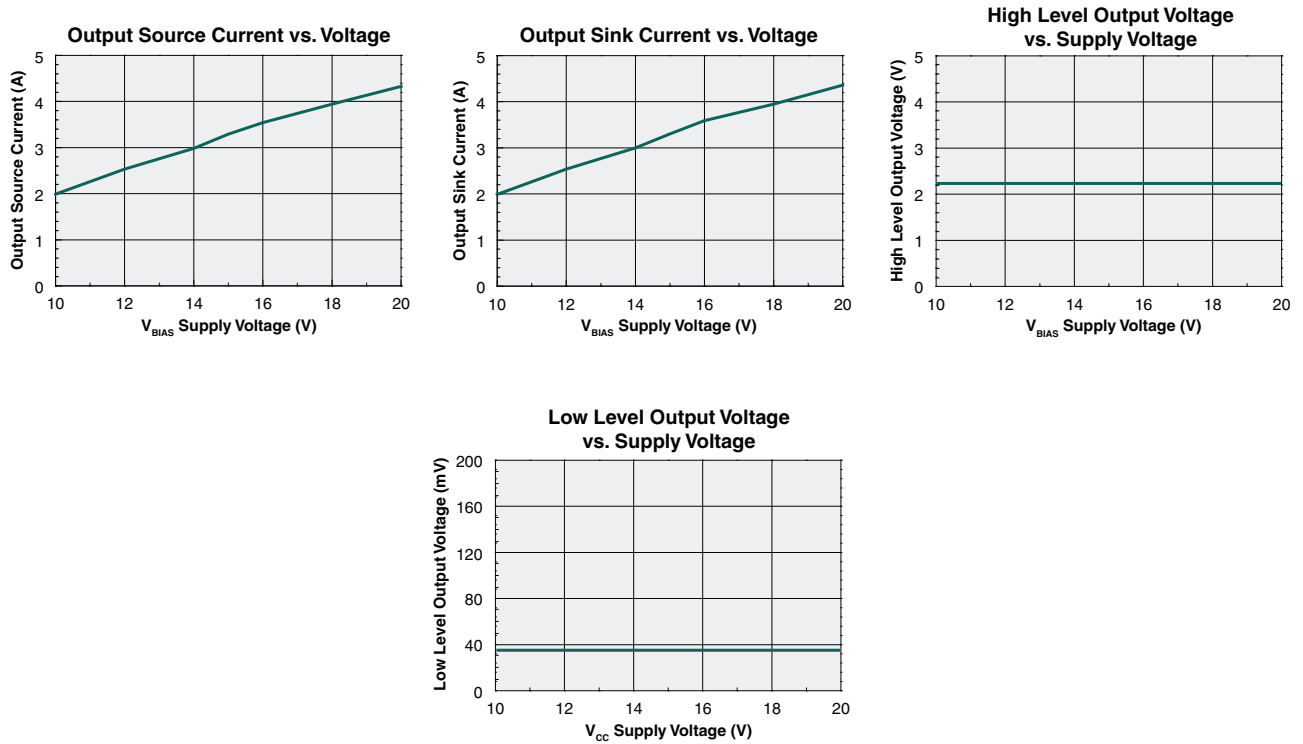
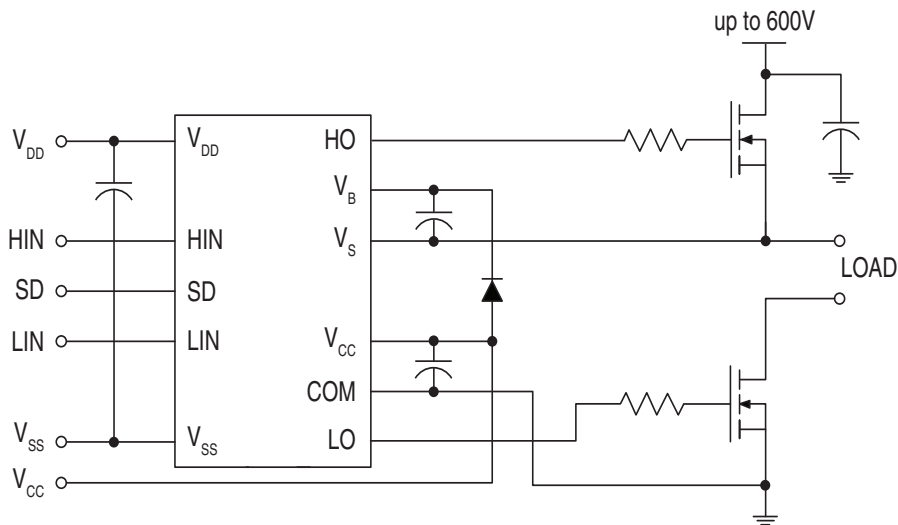

Figure 1. Typical Connection Diagram



3 Manufacturing Information

3.1 Moisture Sensitivity



All plastic encapsulated semiconductor packages are susceptible to moisture ingress. IXYS Integrated Circuits Division classified all of its plastic encapsulated devices for moisture sensitivity according to the latest version of the joint industry standard, **IPC/JEDEC J-STD-020**, in force at the time of product evaluation. We test all of our products to the maximum conditions set forth in the standard, and guarantee proper operation of our devices when handled according to the limitations and information in that standard as well as to any limitations set forth in the information or standards referenced below.

Failure to adhere to the warnings or limitations as established by the listed specifications could result in reduced product performance, reduction of operable life, and/or reduction of overall reliability.

This product carries a **Moisture Sensitivity Level (MSL) rating** as shown below, and should be handled according to the requirements of the latest version of the joint industry standard **IPC/JEDEC J-STD-033**.

Device	Moisture Sensitivity Level (MSL) Rating
IX2113B, IX2113G	MSL 1

3.2 ESD Sensitivity



This product is **ESD Sensitive**, and should be handled according to the industry standard **JESD-625**.

3.3 Reflow Profile

This product has a maximum body temperature and time rating as shown below. All other guidelines of **J-STD-020** must be observed.

Device	Maximum Temperature x Time
IX2113B	260°C for 30 seconds
IX2113G	245°C for 30 seconds

3.4 Board Wash

IXYS Integrated Circuits Division recommends the use of no-clean flux formulations. However, board washing to remove flux residue is acceptable, and the use of a short drying bake may be necessary. Chlorine-based or Fluorine-based solvents or fluxes should not be used. Cleaning methods that employ ultrasonic energy should not be used.



3.5 Mechanical Dimensions

3.5.1 IX2113B: 16-Pin SOIC Package

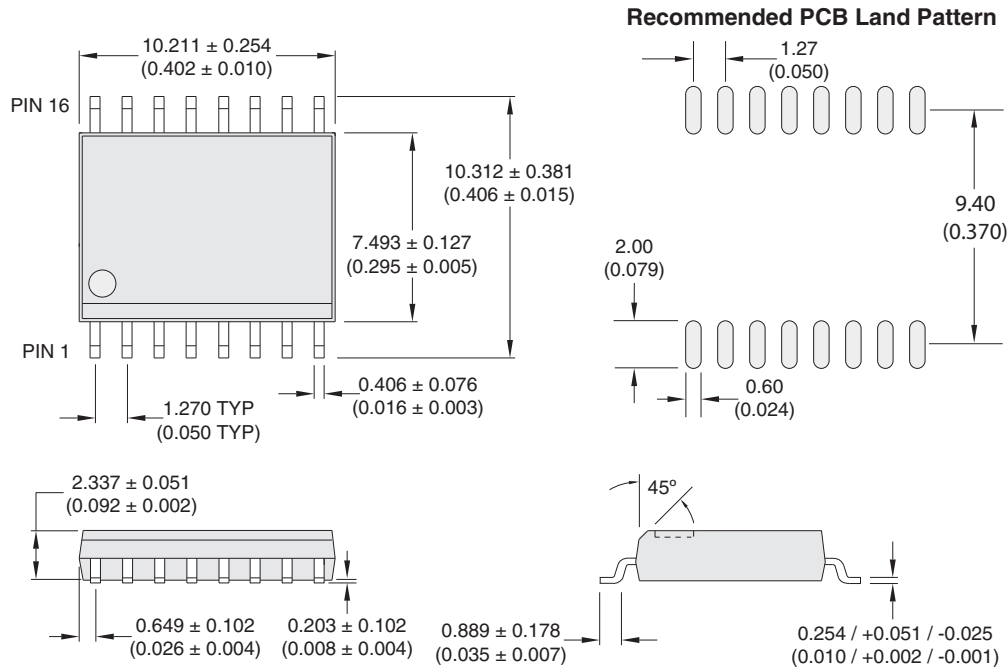

- NOTES:
1. Coplanarity = 0.1016 (0.004) max.
 2. Leadframe thickness does not include solder plating (1000 microinch maximum).

DIMENSIONS
mm
(inches)

3.5.2 IX2113BTR: Tape & Reel Packaging for 16-Pin SOIC Package

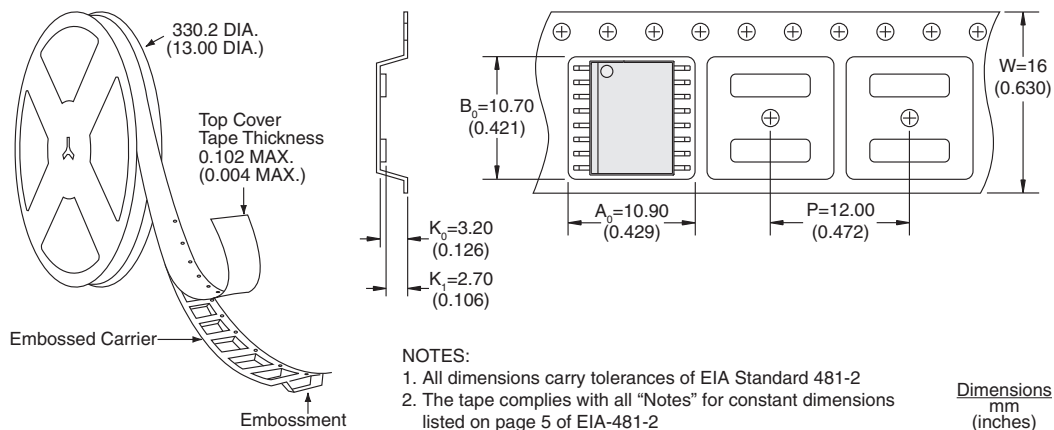

- NOTES:
1. All dimensions carry tolerances of EIA Standard 481-2
 2. The tape complies with all "Notes" for constant dimensions listed on page 5 of EIA-481-2

Dimensions
mm
(inches)

3.5.3 IX2113G: 14-Pin DIP Through-Hole Package

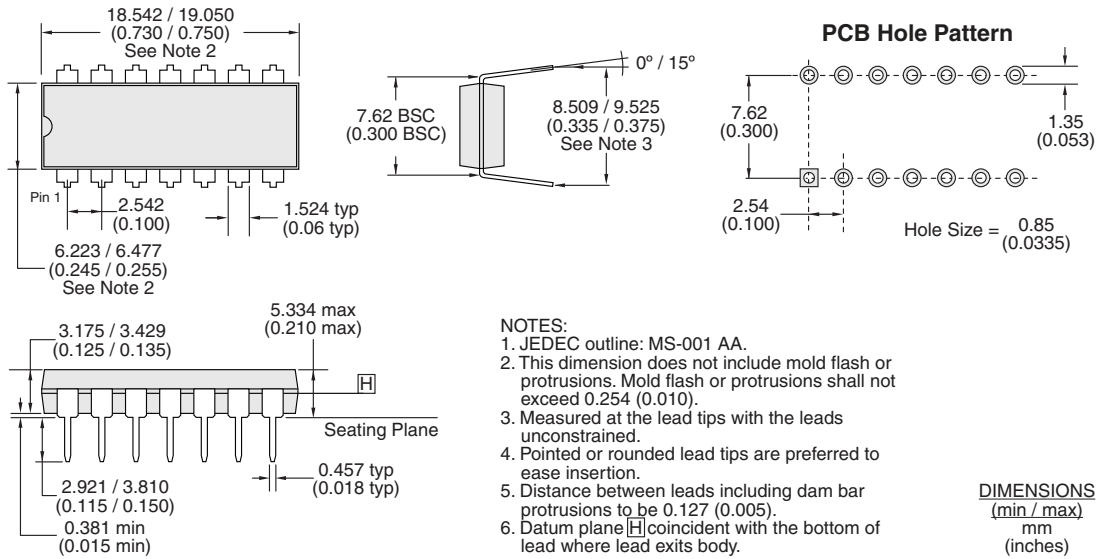

For additional information please visit our website at: www.ixysic.com

IXYS Integrated Circuits Division makes no representations or warranties with respect to the accuracy or completeness of the contents of this publication and reserves the right to make changes to specifications and product descriptions at any time without notice. Neither circuit patent licenses nor indemnity are expressed or implied. Except as set forth in IXYS Integrated Circuits Division's Standard Terms and Conditions of Sale, IXYS Integrated Circuits Division assumes no liability whatsoever, and disclaims any express or implied warranty, relating to its products including, but not limited to, the implied warranty of merchantability, fitness for a particular purpose, or infringement of any intellectual property right.

The products described in this document are not designed, intended, authorized or warranted for use as components in systems intended for surgical implant into the body, or in other applications intended to support or sustain life, or where malfunction of IXYS Integrated Circuits Division's product may result in direct physical harm, injury, or death to a person or severe property or environmental damage. IXYS Integrated Circuits Division reserves the right to discontinue or make changes to its products at any time without notice.

Specification: DS-IX2113-R03
 ©Copyright 2014, IXYS Integrated Circuits Division
 All rights reserved. Printed in USA.
 6/9/2014



Стандарт Электрон Связь

Мы молодая и активно развивающаяся компания в области поставок электронных компонентов. Мы поставляем электронные компоненты отечественного и импортного производства напрямую от производителей и с крупнейших складов мира.

Благодаря сотрудничеству с мировыми поставщиками мы осуществляем комплексные и плановые поставки широчайшего спектра электронных компонентов.

Собственная эффективная логистика и склад в обеспечивает надежную поставку продукции в точно указанные сроки по всей России.

Мы осуществляем техническую поддержку нашим клиентам и предпродажную проверку качества продукции. На все поставляемые продукты мы предоставляем гарантию .

Осуществляем поставки продукции под контролем ВП МО РФ на предприятия военно-промышленного комплекса России , а также работаем в рамках 275 ФЗ с открытием отдельных счетов в уполномоченном банке. Система менеджмента качества компании соответствует требованиям ГОСТ ISO 9001.

Минимальные сроки поставки, гибкие цены, неограниченный ассортимент и индивидуальный подход к клиентам являются основой для выстраивания долгосрочного и эффективного сотрудничества с предприятиями радиоэлектронной промышленности, предприятиями ВПК и научно-исследовательскими институтами России.

С нами вы становитесь еще успешнее!

Наши контакты:

Телефон: +7 812 627 14 35

Электронная почта: sales@st-electron.ru

Адрес: 198099, Санкт-Петербург,
Промышленная ул, дом № 19, литера Н,
помещение 100-Н Офис 331