



SANYO Semiconductors

DATA SHEET

An ON Semiconductor Company

PNP / NPN Epitaxial Planar Silicon Transistors

MCH3105/MCH3205 — High-Current Switching Applications

Applications

- DC / DC converters, relay drivers, lamp drivers, motor drivers, flash

Features

- Adoption of FBET, MBIT processes
- Low collector-to-emitter saturation voltage
- Ultrasmall package facilitates miniaturization in end products (mounting height : 0.85mm)
- High allowable power dissipation
- Large current capacity
- High-speed switching

Specifications () : MCH3105

Absolute Maximum Ratings at Ta=25°C

| Parameter | Symbol | Conditions | Ratings | Unit |
|------------------------------|------------------|---|-------------|------|
| Collector-to-Base Voltage | V _{CBO} | | (-50)80 | V |
| Collector-to-Emitter Voltage | V _{CES} | | (-50)80 | V |
| | V _{CEO} | | (-50) | V |
| Emitter-to-Base Voltage | V _{EBO} | | (-6) | V |
| Collector Current | I _C | | (-3) | A |
| Collector Current (Pulse) | I _{CP} | | (-6) | A |
| Base Current | I _B | | (-600) | mA |
| Collector Dissipation | P _C | When mounted on ceramic substrate (600mm ² ×0.8mm) | 0.8 | W |
| Junction Temperature | T _J | | 150 | °C |
| Storage Temperature | T _{stg} | | -55 to +150 | °C |

Package Dimensions

unit : mm (typ)

7019A-004

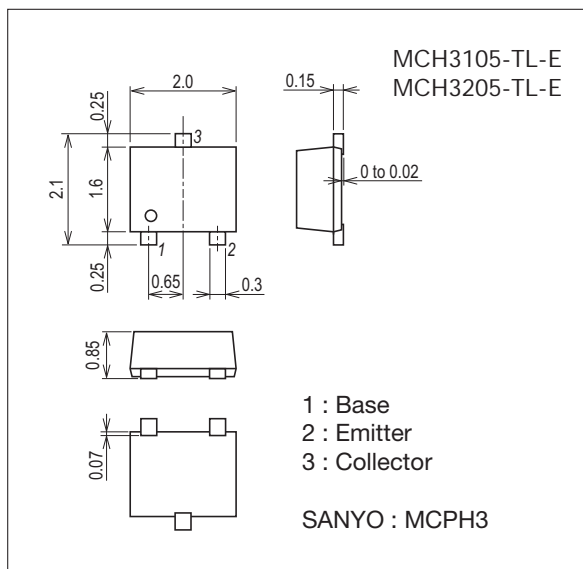

Product & Package Information

- Package : MCPH3
- JEITA, JEDEC : SC-70, SOT-323
- Minimum Packing Quantity : 3,000 pcs./reel

Packing Type : TL

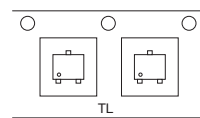

Marking

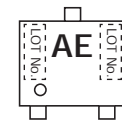

MCH3105

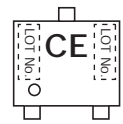

MCH3205

Electrical Connection

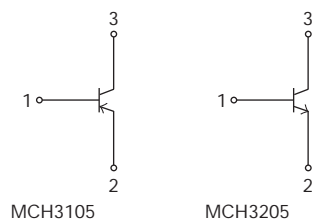

MCH3105/MCH3205

Electrical Characteristics at Ta=25°C

| Parameter | Symbol | Conditions | Ratings | | | Unit |
|---|----------------|-----------------------------------|----------|------------|-----------|---------|
| | | | min | typ | max | |
| Collector Cutoff Current | I_{CBO} | $V_{CB}=(-)40V, I_E=0A$ | | | (-) 1 | μA |
| Emitter Cutoff Current | I_{EBO} | $V_{EB}=(-)4V, I_C=0A$ | | | (-) 1 | μA |
| DC Current Gain | h_{FE} | $V_{CE}=(-)2V, I_C=(-)100mA$ | 200 | | 560 | |
| Gain-Bandwidth Product | f_T | $V_{CE}=(-)10V, I_C=(-)500mA$ | | (360)380 | | MHz |
| Output Capacitance | C_{ob} | $V_{CB}=(-)10V, f=1MHz$ | | (24)13 | | pF |
| Collector-to-Emitter Saturation Voltage | $V_{CE(sat)1}$ | $I_C=(-)1A, I_B=(-)50mA$ | | (-100)80 | (-200)120 | mV |
| | $V_{CE(sat)2}$ | $I_C=(-)2A, I_B=(-)100mA$ | | (-185)140 | (-500)210 | mV |
| Base-to-Emitter Saturation Voltage | $V_{BE(sat)}$ | $I_C=(-)2A, I_B=(-)100mA$ | | (-) 0.88 | (-) 1.2 | V |
| Collector-to-Base Breakdown Voltage | $V_{(BR)CBO}$ | $I_C=(-)10\mu A, I_E=0A$ | (-) 50 | 80 | | V |
| Collector-to-Emitter Breakdown Voltage | $V_{(BR)CES}$ | $I_C=(-)100\mu A, R_{BE}=0\Omega$ | (-) 50 | 80 | | V |
| | $V_{(BR)CEO}$ | $I_C=(-)1mA, R_{BE}=\infty$ | (-) 50 | | | V |
| Emitter-to-Base Breakdown Voltage | $V_{(BR)EBO}$ | $I_E=(-)10\mu A, I_C=0A$ | (-) 6 | | | V |
| Turn-On Time | t_{on} | See specified Test Circuit. | | (30)35 | | ns |
| Storage Time | t_{stg} | | | (230)300 | | ns |
| Fall Time | t_f | | | (15)22 | | ns |

Switching Time Test Circuit

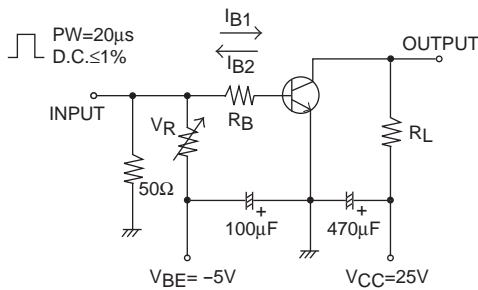

$I_C=10I_{B1}=-10I_{B2}=1A$
 (For PNP, the polarity is reversed.)

Ordering Information

| Device | Package | Shipping | memo |
|--------------|---------|----------------|---------|
| MCH3105-TL-E | MCPH3 | 3,000pcs./reel | Pb Free |
| MCH3205-TL-E | MCPH3 | 3,000pcs./reel | |

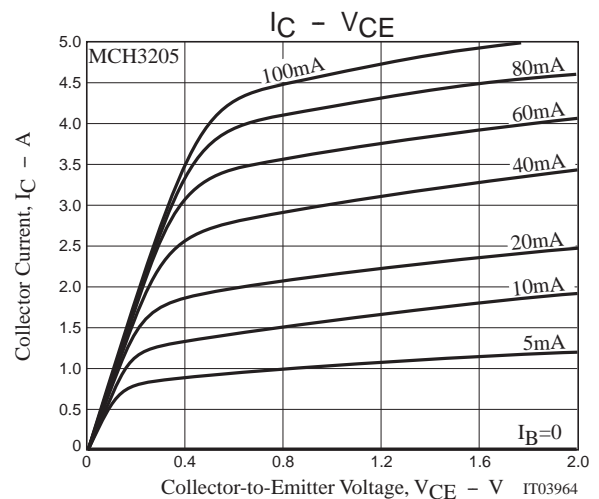
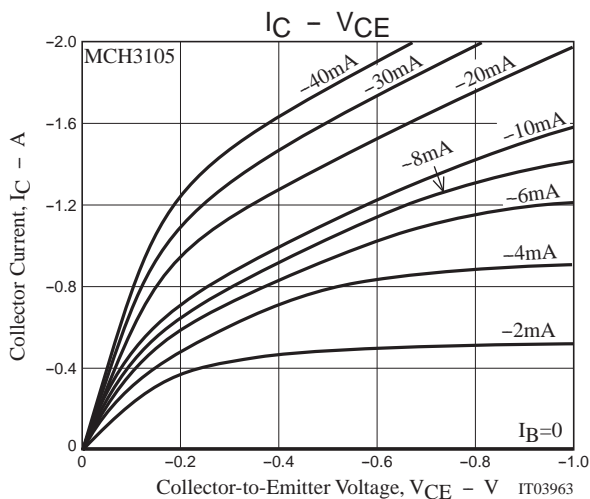

MCH3105/MCH3205

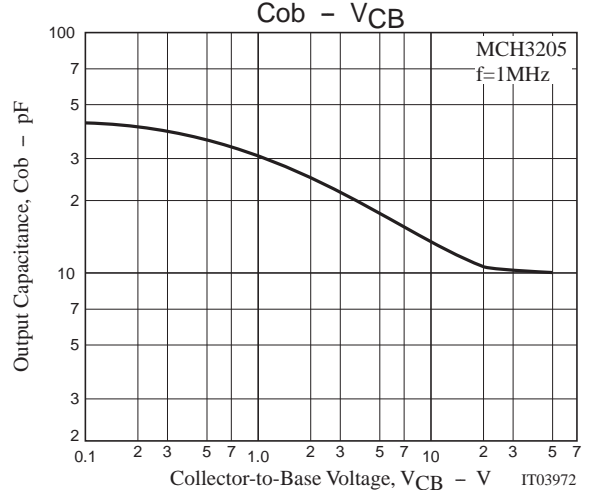
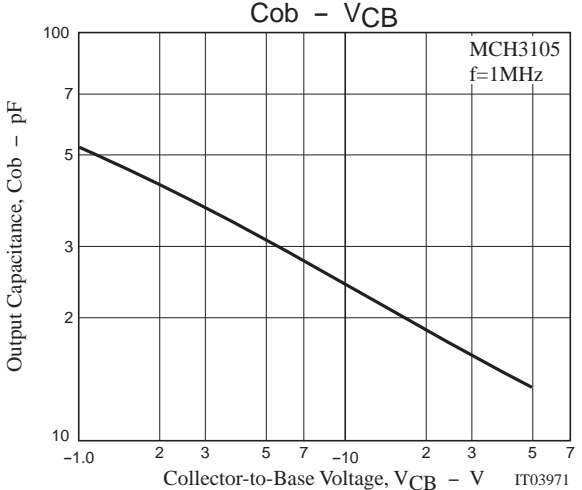
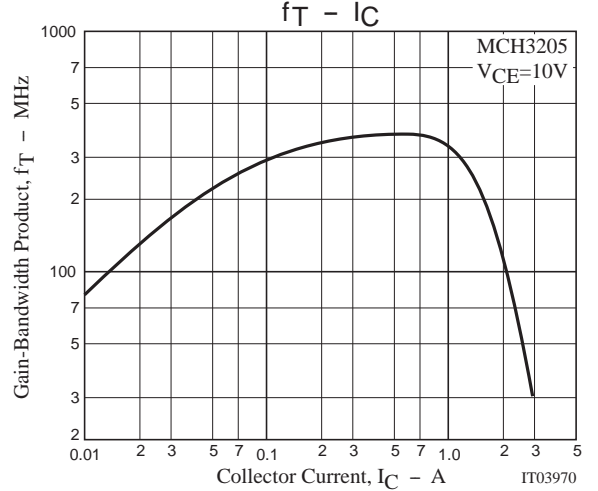
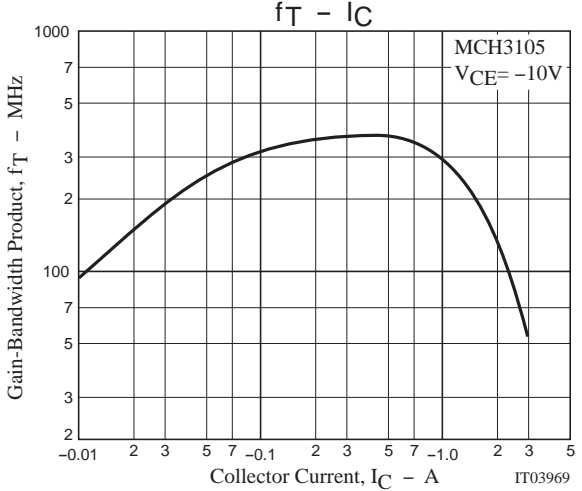
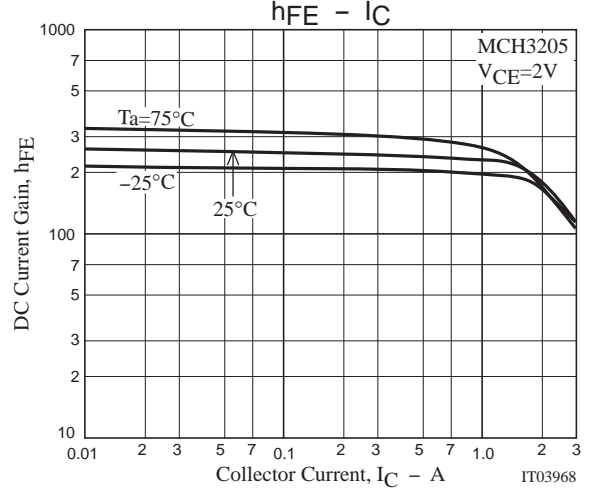
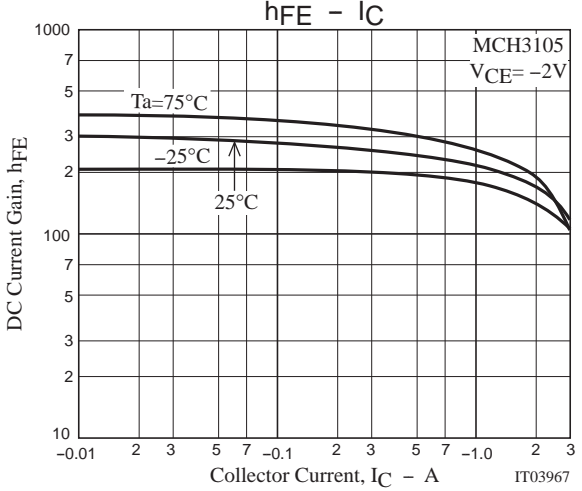
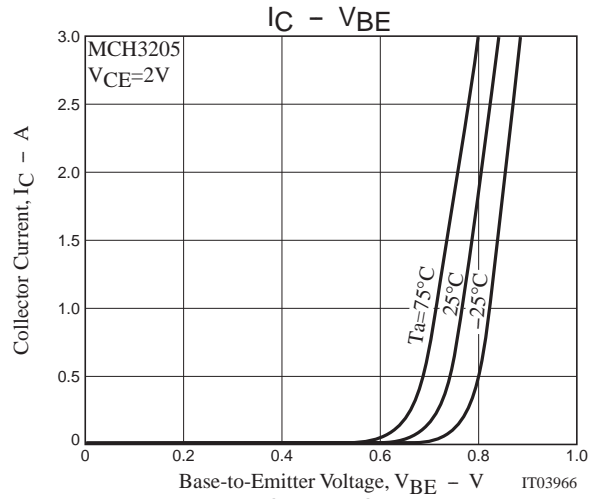
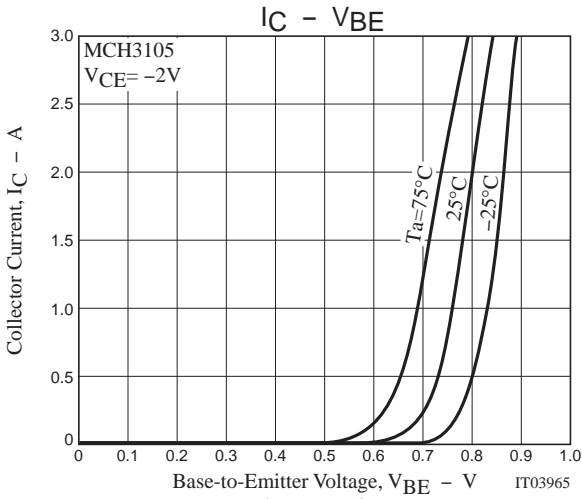

MCH3105/MCH3205

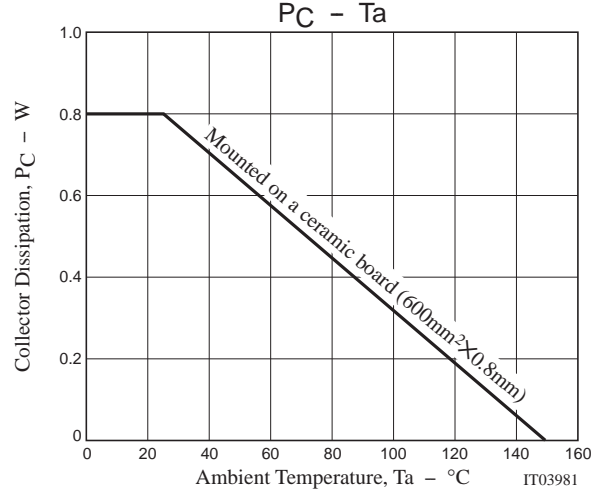
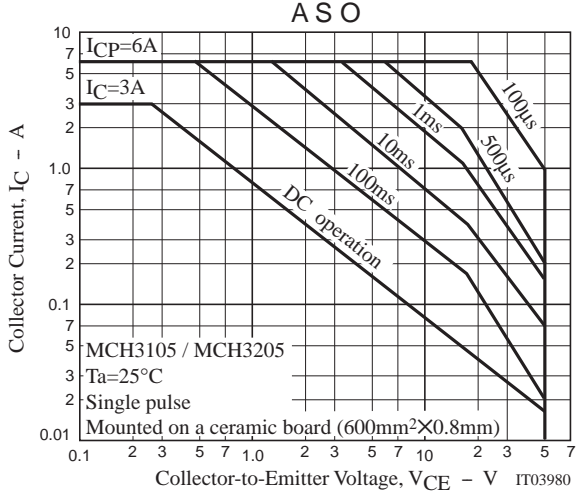
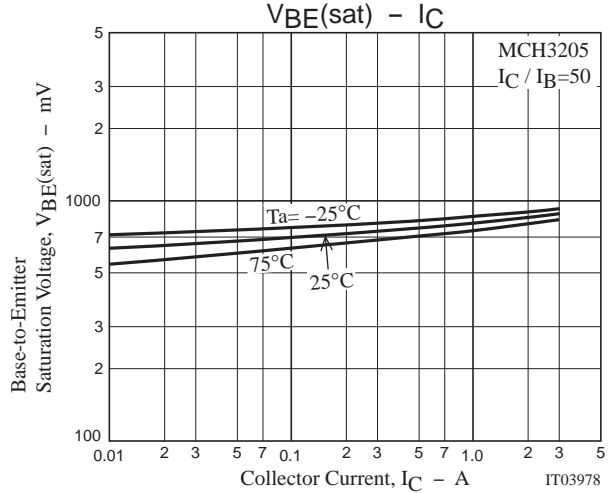
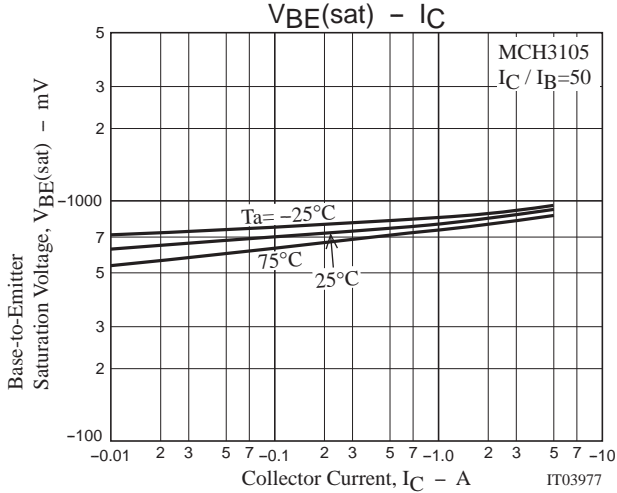
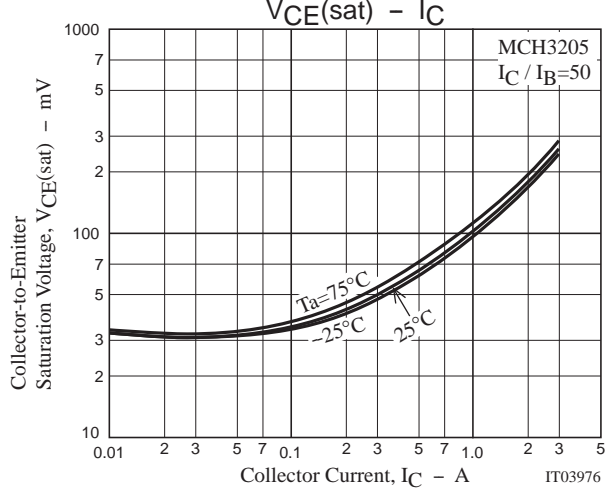
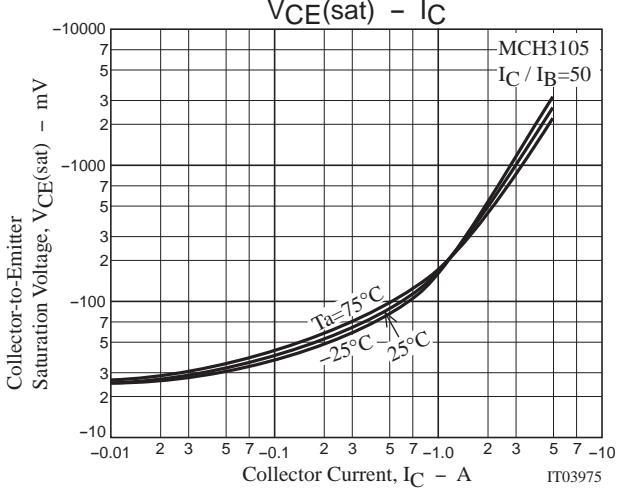
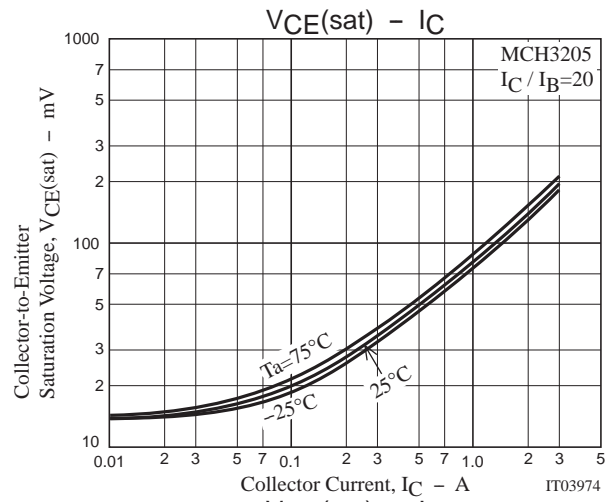
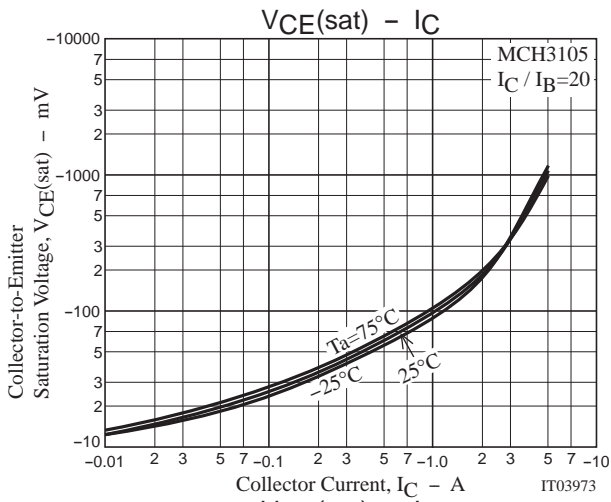

MCH3105/MCH3205

Outline Drawing

MCH3105-TL-E, MCH3205-TL-E

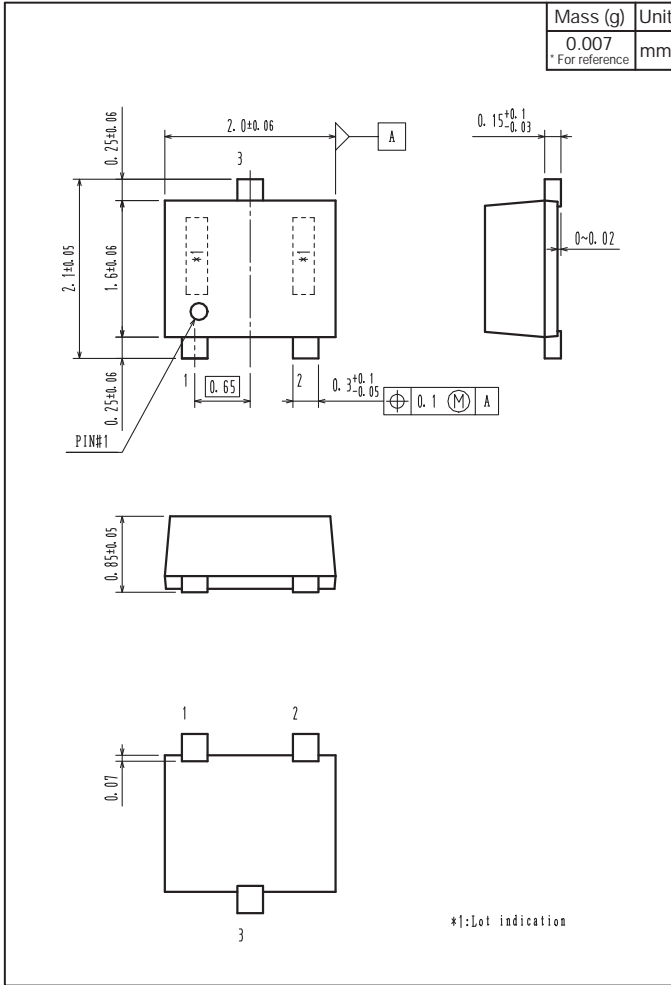

Land Pattern Example

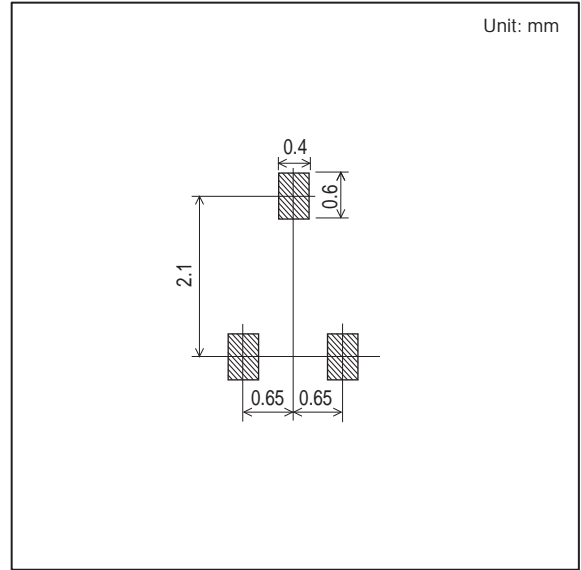

- Any and all SANYO Semiconductor Co.,Ltd. products described or contained herein are, with regard to "standard application", intended for the use as general electronics equipment. The products mentioned herein shall not be intended for use for any "special application" (medical equipment whose purpose is to sustain life, aerospace instrument, nuclear control device, burning appliances, transportation machine, traffic signal system, safety equipment etc.) that shall require extremely high level of reliability and can directly threaten human lives in case of failure or malfunction of the product or may cause harm to human bodies, nor shall they grant any guarantee thereof. If you should intend to use our products for new introduction or other application different from current conditions on the usage of automotive device, communication device, office equipment, industrial equipment etc. , please consult with us about usage condition (temperature, operation time etc.) prior to the intended use. If there is no consultation or inquiry before the intended use, our customer shall be solely responsible for the use.
- Specifications of any and all SANYO Semiconductor Co.,Ltd. products described or contained herein stipulate the performance, characteristics, and functions of the described products in the independent state, and are not guarantees of the performance, characteristics, and functions of the described products as mounted in the customer's products or equipment. To verify symptoms and states that cannot be evaluated in an independent device, the customer should always evaluate and test devices mounted in the customer's products or equipment.
- SANYO Semiconductor Co.,Ltd. assumes no responsibility for equipment failures that result from using products at values that exceed, even momentarily, rated values (such as maximum ratings, operating condition ranges, or other parameters) listed in products specifications of any and all SANYO Semiconductor Co.,Ltd. products described or contained herein.
- Regarding monolithic semiconductors, if you should intend to use this IC continuously under high temperature, high current, high voltage, or drastic temperature change, even if it is used within the range of absolute maximum ratings or operating conditions, there is a possibility of decrease reliability. Please contact us for a confirmation.
- SANYO Semiconductor Co.,Ltd. strives to supply high-quality high-reliability products, however, any and all semiconductor products fail or malfunction with some probability. It is possible that these probabilistic failures or malfunction could give rise to accidents or events that could endanger human lives, trouble that could give rise to smoke or fire, or accidents that could cause damage to other property. When designing equipment, adopt safety measures so that these kinds of accidents or events cannot occur. Such measures include but are not limited to protective circuits and error prevention circuits for safe design, redundant design, and structural design.
- In the event that any or all SANYO Semiconductor Co.,Ltd. products described or contained herein are controlled under any of applicable local export control laws and regulations, such products may require the export license from the authorities concerned in accordance with the above law.
- No part of this publication may be reproduced or transmitted in any form or by any means, electronic or mechanical, including photocopying and recording, or any information storage or retrieval system, or otherwise, without the prior written consent of SANYO Semiconductor Co.,Ltd.
- Any and all information described or contained herein are subject to change without notice due to product/technology improvement, etc. When designing equipment, refer to the "Delivery Specification" for the SANYO Semiconductor Co.,Ltd. product that you intend to use.
- Upon using the technical information or products described herein, neither warranty nor license shall be granted with regard to intellectual property rights or any other rights of SANYO Semiconductor Co.,Ltd. or any third party. SANYO Semiconductor Co.,Ltd. shall not be liable for any claim or suits with regard to a third party's intellectual property rights which has resulted from the use of the technical information and products mentioned above.

This catalog provides information as of August, 2012. Specifications and information herein are subject to change without notice.



Стандарт Электрон Связь

Мы молодая и активно развивающаяся компания в области поставок электронных компонентов. Мы поставляем электронные компоненты отечественного и импортного производства напрямую от производителей и с крупнейших складов мира.

Благодаря сотрудничеству с мировыми поставщиками мы осуществляем комплексные и плановые поставки широчайшего спектра электронных компонентов.

Собственная эффективная логистика и склад в обеспечивает надежную поставку продукции в точно указанные сроки по всей России.

Мы осуществляем техническую поддержку нашим клиентам и предпродажную проверку качества продукции. На все поставляемые продукты мы предоставляем гарантию .

Осуществляем поставки продукции под контролем ВП МО РФ на предприятия военно-промышленного комплекса России , а также работаем в рамках 275 ФЗ с открытием отдельных счетов в уполномоченном банке. Система менеджмента качества компании соответствует требованиям ГОСТ ISO 9001.

Минимальные сроки поставки, гибкие цены, неограниченный ассортимент и индивидуальный подход к клиентам являются основой для выстраивания долгосрочного и эффективного сотрудничества с предприятиями радиоэлектронной промышленности, предприятиями ВПК и научно-исследовательскими институтами России.

С нами вы становитесь еще успешнее!

Наши контакты:

Телефон: +7 812 627 14 35

Электронная почта: sales@st-electron.ru

Адрес: 198099, Санкт-Петербург,
Промышленная ул, дом № 19, литера Н,
помещение 100-Н Офис 331