



Package: SOT-89



Product Description

RFMD's SBB3089Z is a high performance InGaP HBT MMIC amplifier utilizing a Darlington configuration with an active bias network. The active bias network provides stable current over temperature and process Beta variations. The SBB3089Z product is designed for high linearity 5V gain block applications that require excellent gain flatness, small size, and minimal external components. It is internally matched to 50Ω.

Optimum Technology Matching® Applied

- GaAs HBT
- GaAs MESFET
- InGaP HBT
- SiGe BiCMOS
- Si BiCMOS
- SiGe HBT
- GaAs pHEMT
- Si CMOS
- Si BJT
- GaN HEMT
- InP HBT
- RF MEMS
- LDMOS

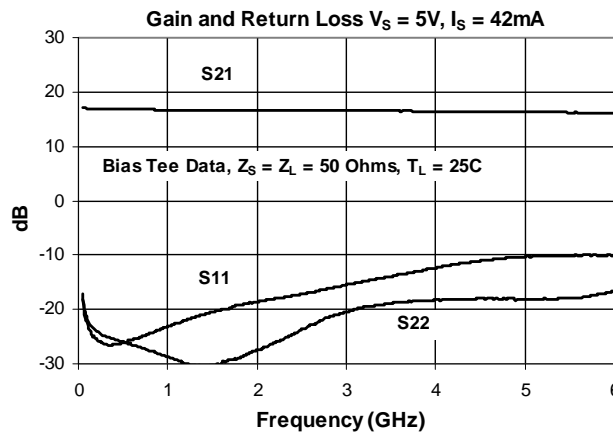

Features

- Single Fixed 5V Supply
- Patented Self Bias Circuit and Thermal Design
- Gain = 16.4dBm at 1950MHz
- $P_{1dB} = 15.2dBm$ at 1950MHz
- $OIP_3 = 29.5dBm$ at 1950MHz
- Robust 1000V ESD, Class 1C HBM

Applications

- PA Driver Amplifier
- Cellular, PCS, GSM, UMTS
- IF Amplifier
- Wireless Data, Satellite
- Wideband Instrumentation

| Parameter | Specification | | | Unit | Condition |
|------------------------------------|---------------|------|------|---------------|----------------------------------|
| | Min. | Typ. | Max. | | |
| Small Signal Gain | 15.1 | 16.6 | 18.1 | dB | 850MHz |
| | 14.9 | 16.4 | 17.9 | dB | 1950MHz |
| | | 16.3 | | dB | 2400MHz |
| Output Power at 1dB Compression | | 15.6 | | dBm | 850MHz |
| | 14.2 | 15.2 | | dBm | 1950MHz |
| | | 15.4 | | dBm | 2400MHz |
| Output Third Order Intercept Point | | 30.0 | | dBm | 850MHz |
| | 27.5 | 29.5 | | dBm | 1950MHz |
| | | 29.5 | | dBm | 2400MHz |
| Input Return Loss | 16 | 21 | | dB | 1950MHz |
| Output Return Loss | 19 | 25.5 | | dB | 1950MHz |
| Noise Figure | | 3.9 | 4.9 | dB | 1950MHz |
| Device Operating Voltage | | 4.2 | 4.3 | V | $R_{DC} = 20\Omega, V_S = 5.0V$ |
| Device Operating Current | 38 | 42 | 46 | mA | $R_{DC} = 20\Omega, V_S = 5.0V$ |
| Operational Current Range | 30 | | 46 | mA | Per user preference via R_{DC} |
| Thermal Resistance | | 80 | | $^{\circ}C/W$ | Junction to lead |

Test Conditions: $V_D = 4.2V, I_D = 42mA, T_L = 25^{\circ}C, OIP_3$ Tone Spacing = 1MHz, $R_{DC} = 20\Omega$, Bias Tee Data, $Z_S = Z_L = 50\Omega, P_{OUT}$ per tone = -5dBm

Absolute Maximum Ratings

| Parameter | Rating | Unit |
|---------------------------------------|------------|------|
| Max Device Current (I_D) | 100 | mA |
| Max Device Voltage (V_D) | 6 | V |
| Max RF Input Power* (See Note) | +20 | dBm |
| Max Junction Temperature (T_J) | +150 | °C |
| Operating Temperature Range (T_L) | -40 to +85 | °C |
| Max Storage Temperature | +150 | °C |
| ESD Rating - Human Body Model (HBM) | Class 1C | |
| Moisture Sensitivity Level | MSL 2 | |



Caution! ESD sensitive device.

Exceeding any one or a combination of the Absolute Maximum Rating conditions may cause permanent damage to the device. Extended application of Absolute Maximum Rating conditions to the device may reduce device reliability. Specified typical performance or functional operation of the device under Absolute Maximum Rating conditions is not implied.

RoHS status based on EU Directive 2002/95/EC (at time of this document revision).

The information in this publication is believed to be accurate and reliable. However, no responsibility is assumed by RF Micro Devices, Inc. ("RFMD") for its use, nor for any infringement of patents, or other rights of third parties, resulting from its use. No license is granted by implication or otherwise under any patent or patent rights of RFMD. RFMD reserves the right to change component circuitry, recommended application circuitry and specifications at any time without prior notice.

*Note: Load condition $Z_L = 50\Omega$

Operation of this device beyond any one of these limits may cause permanent damage. For reliable continuous operation, the device voltage and current must not exceed the maximum operating values specified in the table on page one.

Bias Conditions should also satisfy the following expression:

$$I_D V_D < (T_J - T_L) / R_{TH} + j - I \text{ and } T_L = T_{LEAD}$$

Typical RF Performance at Key Operating Frequencies (Bias Tee Data)

| Parameter | Unit | 100 MHz | 500 MHz | 850 MHz | 1950 MHz | 2140 MHz | 2400 MHz | 3500 MHz |
|------------------------------------|------|---------|---------|---------|----------|----------|----------|----------|
| Small Signal Gain | dB | 16.9 | 16.6 | 16.6 | 16.4 | 16.4 | 16.3 | 16.1 |
| Output Third Order Intercept Point | dBm | 29.5 | 30.5 | 30.0 | 29.5 | 29.0 | 29.5 | 27.0 |
| Output Power at 1dB Compression | dBm | 15.6 | 16.0 | 15.6 | 15.2 | 15.0 | 15.4 | 15.2 |
| Input Return Loss | dB | 24.0 | 26.5 | 24.5 | 21.0 | 20.5 | 20.0 | 15.5 |
| Output Return Loss | dB | 21.5 | 26.0 | 26.0 | 25.5 | 25.5 | 27.5 | 21.0 |
| Reverse Isolation | dB | 19.5 | 19.0 | 19.5 | 19.5 | 19.5 | 19.5 | 19.5 |
| Noise Figure | dB | 3.7 | 3.9 | 3.9 | 3.9 | 3.9 | 4.0 | 3.8 |

Test Conditions: $V_D = 4.2V$ $I_D = 42mA$ OIP_3 Tone Spacing = 1MHz, P_{OUT} per tone = -5 dBm $R_{DC} = 20\Omega$ $T_L = 25^\circ C$ $Z_S = Z_L = 50\Omega$

Typical Performance with Bias Tees, $V_D = 5V$ with $R_{DC} = 20\Omega$, $I_D = 42mA$

OIP3 versus Frequency,
(-5dBm/tone, 1MHz spacing)

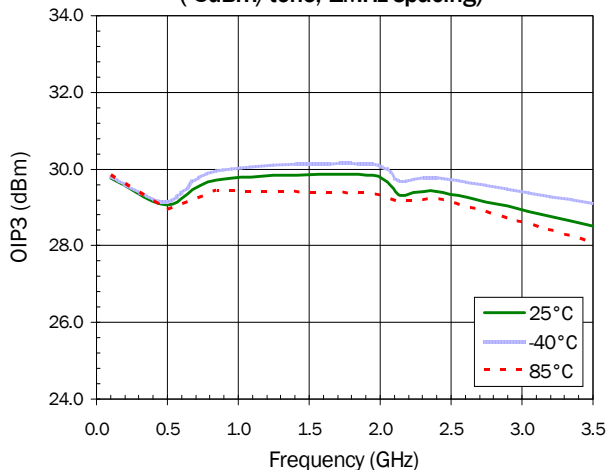

P1dB versus Frequency

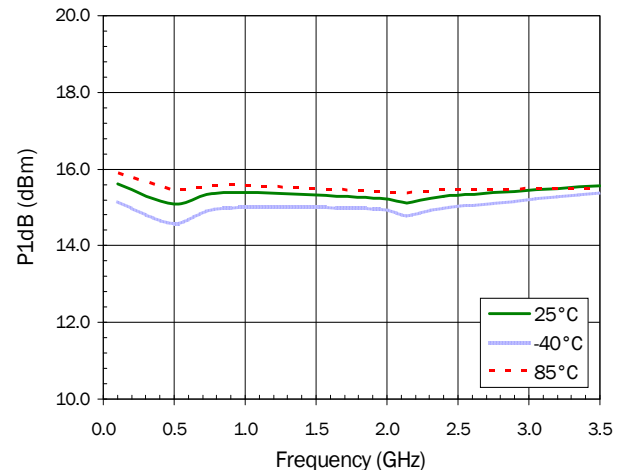

Typical Performance with Bias Tees, $V_S=5V$, $R_{DC}=20\Omega$, $I_D=42mA$

S11 versus Frequency

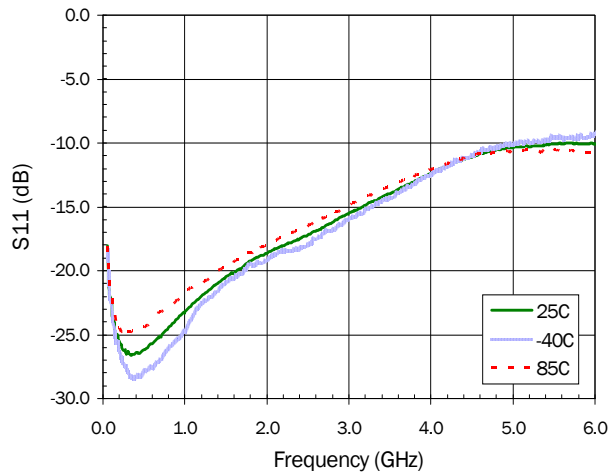

S21 versus Frequency

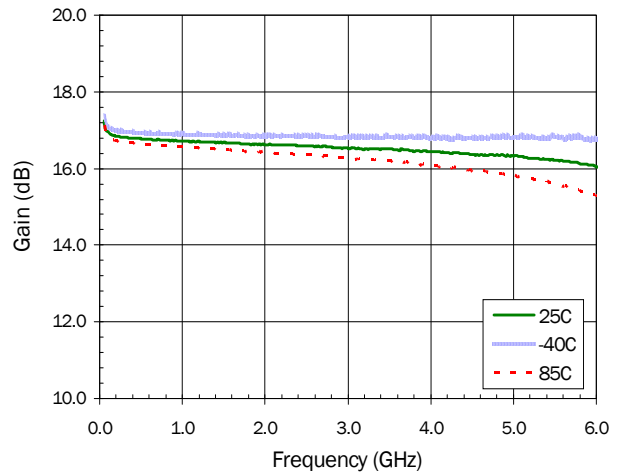

S12 versus Frequency

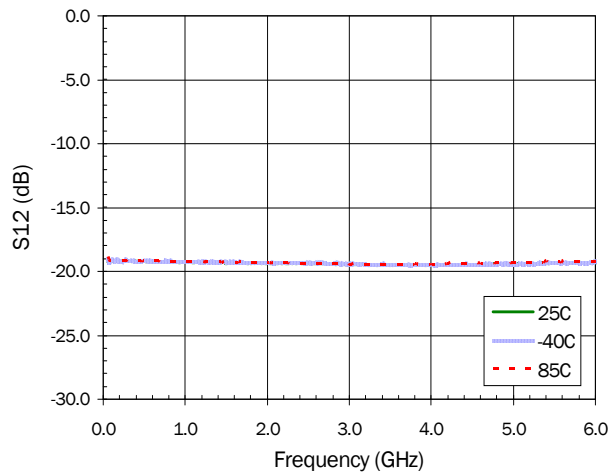

S22 versus Frequency

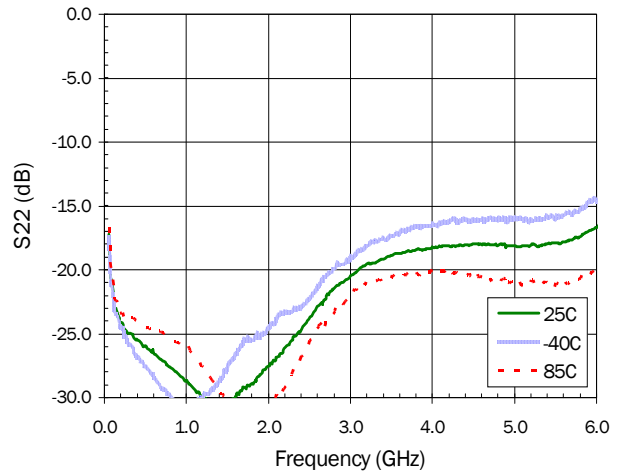

NF versus Frequency

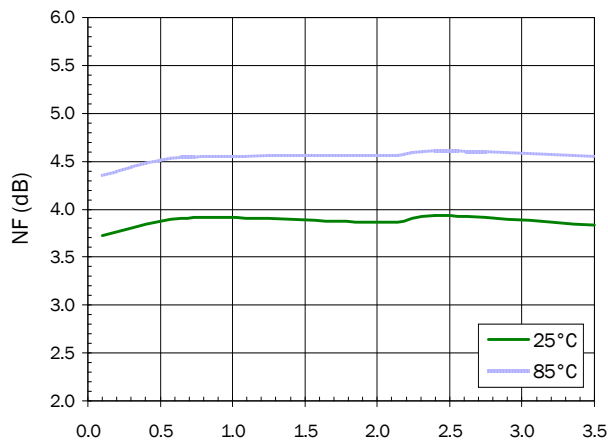

DCIV

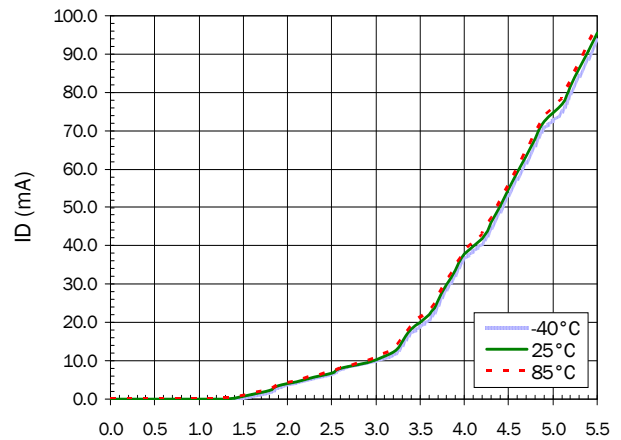

Application Schematic

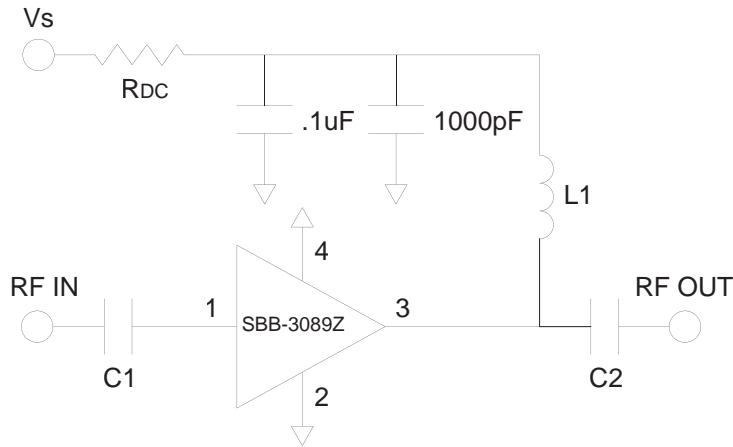

Application Circuit Element Values

| Reference Designator | 500MHz to 3500MHz |
|----------------------|-----------------------|
| C1 | 1000pF |
| C2 | 68pF |
| L1 | 48nH 0805HQ Coilcraft |

Evaluation Board Layout

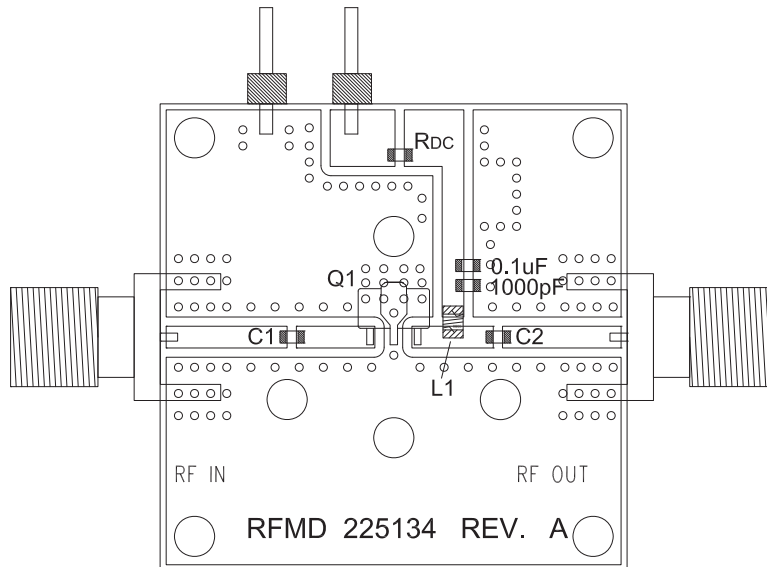

Mounting Instructions

1. Solder the copper pad on the backside of the device package to the ground plane.
2. Use a large ground pad area with many plated through-holes as shown.
3. We recommend 1 or 2 ounce copper. Measurements for this data sheet were made on a 31mm thick FR-4 board with 1 ounce copper on both sides.

Recommended Bias Resistor Values for $I_D = 42\text{mA}$ $R_{DC} = (V_S - V_D) / I_D$

| Supply Voltage (V_S) | 5V | 6V | 8V | 10V | 12V |
|--------------------------|-------------|-------------|-------------|--------------|--------------|
| R_{DC} | 20 Ω | 43 Ω | 91 Ω | 139 Ω | 187 Ω |

| Pin | Function | Description |
|------|--------------------|---|
| 1 | RF IN | RF input pin. This pin requires the use of an external DC blocking capacitor chosen for the frequency of operation. |
| 2, 4 | GND | Connection to ground. Use via holes as close to the device ground leads as possible to reduce ground inductance and achieve optimum RF performance. |
| 3 | RF OUT/ DC BIAS | RF output and bias pin. This pin requires the use of an external DC blocking capacitor chosen for the frequency of operation. |

Part Identification

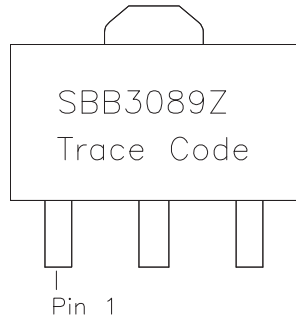

Suggested Pad Layout

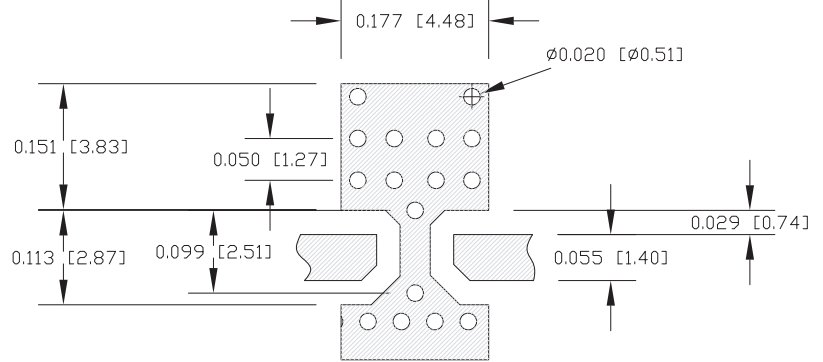

Package Drawing

Dimensions in inches (millimeters)

Refer to drawing posted at www.rfmd.com for tolerances.

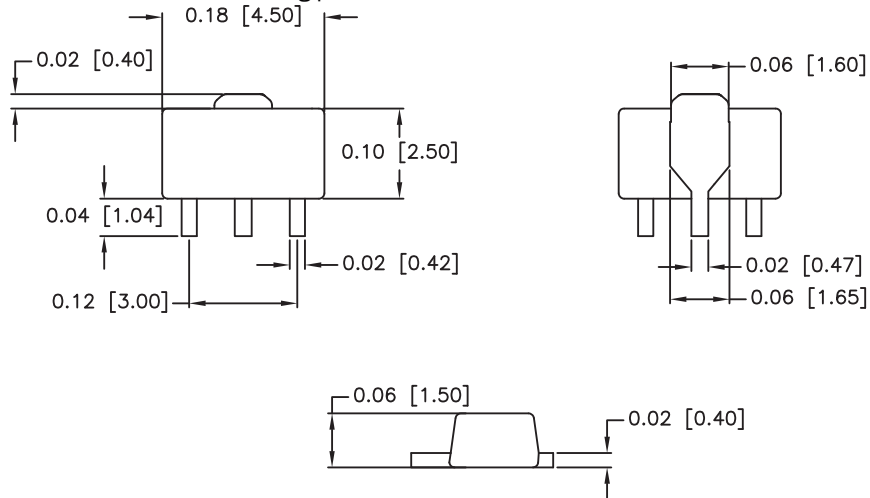

Ordering Information

| Ordering Code | Description |
|---------------|--|
| SBB3089Z | 7" Reel with 1000 pieces |
| SBB3089ZSQ | Sample bag with 25 pieces |
| SBB3089ZSR | 7" Reel with 100 pieces |
| SBB3089ZPCK1 | 500MHz to 3500MHz PCBA with 5-piece sample bag |



Стандарт Электрон Связь

Мы молодая и активно развивающаяся компания в области поставок электронных компонентов. Мы поставляем электронные компоненты отечественного и импортного производства напрямую от производителей и с крупнейших складов мира.

Благодаря сотрудничеству с мировыми поставщиками мы осуществляем комплексные и плановые поставки широчайшего спектра электронных компонентов.

Собственная эффективная логистика и склад в обеспечивает надежную поставку продукции в точно указанные сроки по всей России.

Мы осуществляем техническую поддержку нашим клиентам и предпродажную проверку качества продукции. На все поставляемые продукты мы предоставляем гарантию .

Осуществляем поставки продукции под контролем ВП МО РФ на предприятия военно-промышленного комплекса России , а также работаем в рамках 275 ФЗ с открытием отдельных счетов в уполномоченном банке. Система менеджмента качества компании соответствует требованиям ГОСТ ISO 9001.

Минимальные сроки поставки, гибкие цены, неограниченный ассортимент и индивидуальный подход к клиентам являются основой для выстраивания долгосрочного и эффективного сотрудничества с предприятиями радиоэлектронной промышленности, предприятиями ВПК и научно-исследовательскими институтами России.

С нами вы становитесь еще успешнее!

Наши контакты:

Телефон: +7 812 627 14 35

Электронная почта: sales@st-electron.ru

Адрес: 198099, Санкт-Петербург,
Промышленная ул, дом № 19, литера Н,
помещение 100-Н Офис 331