



Parameter	Rating	Units
Load Voltage	250	$V_P$
Load Current	170	$mA_{rms} / mA_{DC}$
On-Resistance (max)	15	$\Omega$

### Features

- 3750V<sub>rms</sub> Input/Output Isolation
- Low Drive Power Requirements (TTL/CMOS Compatible)
- High Reliability
- Arc-Free With No Snubbing Circuits
- FCC Compatible
- VDE Compatible
- No EMI/RFI Generation
- Small 6-Pin Package
- Machine Insertable, Wave Solderable
- Tape & Reel, Surface Mount Version Available

### Applications

- Telecommunications
  - Telecom Switching
  - Tip/Ring Circuits
  - Modem Switching (Laptop, Notebook, Pocket Size)
  - Hook Switch
  - Dial Pulsing
  - Ground Start
  - Ringing Injection
- Instrumentation
  - Multiplexers
  - Data Acquisition
  - Electronic Switching
  - I/O Subsystems
- Meters (Watt-Hour, Water, Gas)
- Medical Equipment—Patient/Equipment Isolation
- Security
- Aerospace
- Industrial Controls

### Description

LCB126 is a 250V, 170mA, 15 $\Omega$ , single-pole, normally closed (1-Form-B) solid state relay featuring enhanced peak load capability and lower on-resistance. It uses optically coupled relay technology to provide an enhanced 3750V<sub>rms</sub> isolation barrier between the input and the output of the relay.

The efficient MOSFET switches use the patented OptoMOS architecture. A highly efficient GaAlAs infrared LED controls the optically coupled output.

### Approvals

- UL Recognized Component: File E76270
- CSA Certified Component: Certificate 1175739
- EN/IEC 60950-1 Certified Component: TUV Certificate B 09 07 49410 006

### Ordering Information

Part #	Description
LCB126	6-Pin DIP (50/Tube)
LCB126S	6-Pin Surface Mount (50/Tube)
LCB126STR	6-Pin Surface Mount (1000/Reel)

### Pin Configuration

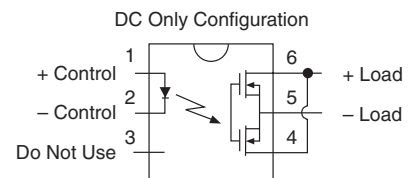
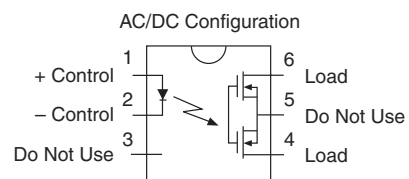

### Switching Characteristics of Normally Closed Devices

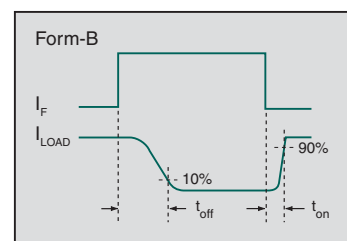

### Absolute Maximum Ratings @ 25°C

Parameter	Ratings	Units
Blocking Voltage	250	V <sub>P</sub>
Reverse Input Voltage	5	V
Input Control Current	50	mA
Peak (10ms)	1	A
Input Power Dissipation <sup>1</sup>	150	mW
Total Power Dissipation <sup>2</sup>	800	mW
Isolation Voltage, Input to Output	3750	V <sub>rms</sub>
Operational Temperature	-40 to +85	°C
Storage Temperature	-40 to +125	°C

<sup>1</sup> Derate linearly 1.33 mW / °C

<sup>2</sup> Derate linearly 6.67 mW / °C

*Absolute Maximum Ratings are stress ratings. Stresses in excess of these ratings can cause permanent damage to the device. Functional operation of the device at conditions beyond those indicated in the operational sections of this data sheet is not implied.*

### Electrical Characteristics @ 25°C

Parameter	Conditions	Symbol	Min	Typ	Max	Units
<b>Output Characteristics</b>						
Load Current						
AC/DC Configuration, Continuous	-	I <sub>L</sub>	-	-	170	mA <sub>rms</sub> / mA <sub>DC</sub>
DC Configuration, Continuous	-		-	-	300	mA <sub>DC</sub>
Peak	t=10ms	I <sub>LPK</sub>	-	-	±400	mA
On-Resistance						
AC/DC Configuration	I <sub>L</sub> =170mA	R <sub>ON</sub>	-	10	15	Ω
DC Configuration	I <sub>L</sub> =300mA		-	4	5	
Off-State Leakage Current	V <sub>L</sub> =250V <sub>P</sub>	I <sub>LEAK</sub>	-	-	1	μA
Switching Speeds						
Turn-On	I <sub>F</sub> =5mA, V <sub>L</sub> =10V	t <sub>on</sub>	-	-	5	ms
Turn-Off		t <sub>off</sub>	-	-	5	
Output Capacitance	V <sub>L</sub> =50V, f=1MHz	C <sub>OUT</sub>	-	50	-	pF
<b>Input Characteristics</b>						
Input Control Current to Activate	I <sub>L</sub> =170mA	I <sub>F</sub>	-	-	5	mA
Input Control Current to Deactivate	-	I <sub>F</sub>	0.4	0.7	-	mA
Input Voltage Drop	I <sub>F</sub> =5mA	V <sub>F</sub>	0.9	1.2	1.4	V
Reverse Input Current	V <sub>R</sub> =5V	I <sub>R</sub>	-	-	10	μA
<b>Common Characteristics</b>						
Capacitance, Input to Output	-	C <sub>I/O</sub>	-	3	-	pF

**PERFORMANCE DATA\* (@25°C Unless Otherwise Noted)**

**Typical LED Forward Voltage Drop**  
(N=50, I<sub>F</sub>=5mA)

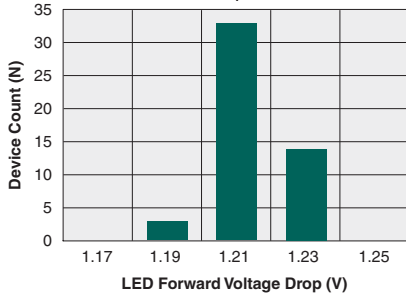

**Typical Turn-On Time**  
(N=50, I<sub>F</sub>=5mA, I<sub>L</sub>=170mA<sub>DC</sub>)

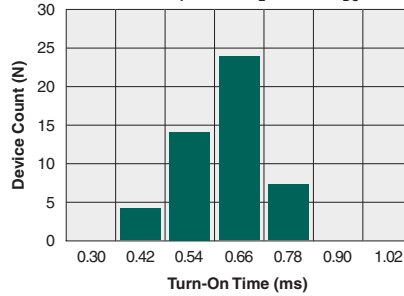

**Typical Turn-Off Time**  
(N=50, I<sub>F</sub>=5mA, I<sub>L</sub>=170mA<sub>DC</sub>)

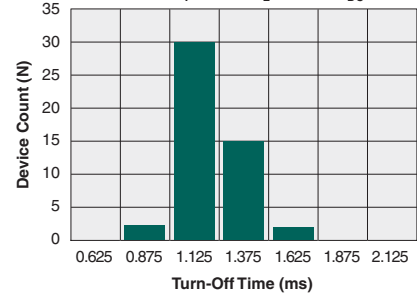

**Typical I<sub>F</sub> for Switch Operation**  
(N=50, I<sub>L</sub>=170mA<sub>DC</sub>)

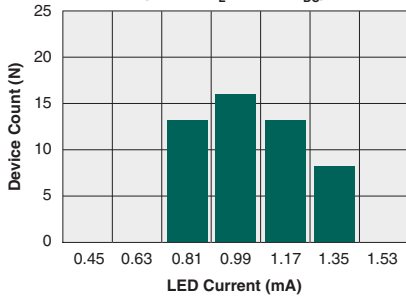

**Typical I<sub>F</sub> for Switch Dropout**  
(N=50, I<sub>L</sub>=170mA<sub>DC</sub>)

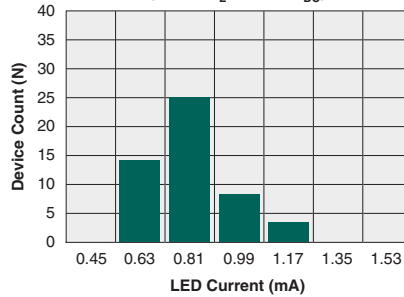

**Typical On-Resistance Distribution**  
(N=50, I<sub>L</sub>=170mA<sub>DC</sub>)

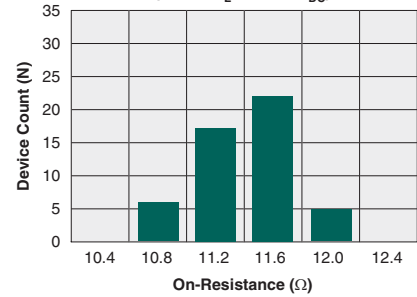

**Typical Blocking Voltage Distribution**  
(N=50)

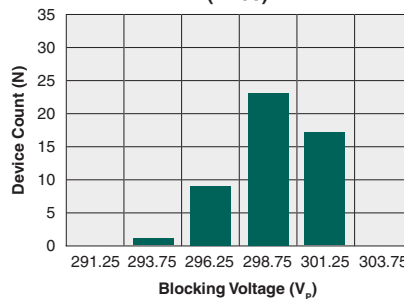

**Typical LED Forward Voltage Drop vs. Temperature**

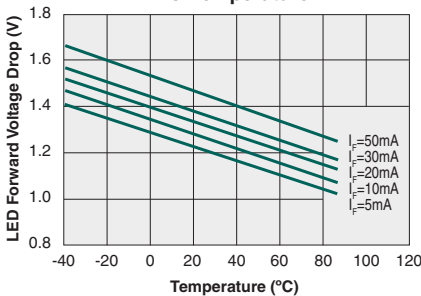

**Typical Turn-On Time vs. LED Forward Current**  
(I<sub>L</sub>=170mA<sub>DC</sub>)

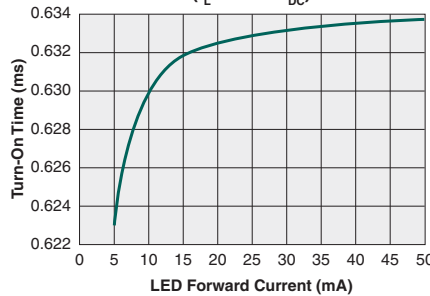

**Typical Turn-Off Time vs. LED Forward Current**  
(I<sub>L</sub>=170mA<sub>DC</sub>)

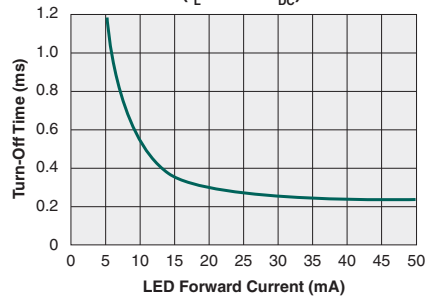

\*The Performance data shown in the graphs above is typical of device performance. For guaranteed parameters not indicated in the written specifications, please contact our application department.

**PERFORMANCE DATA\* (@25°C Unless Otherwise Noted)**

**Typical On-Resistance vs. Temperature**  
( $I_F=5\text{mA}$ ,  $I_L=170\text{mA}_{DC}$ )

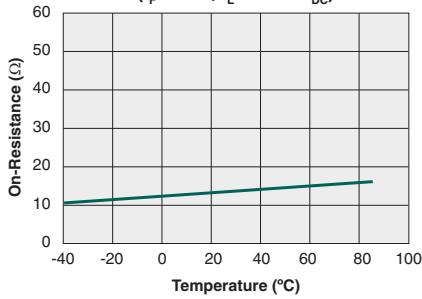

**Typical Turn-On Time vs. Temperature**  
( $I_F=5\text{mA}$ ,  $I_L=170\text{mA}_{DC}$ )

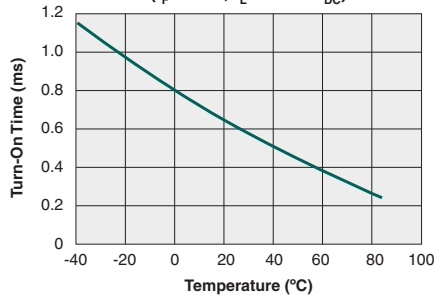

**Typical Turn-Off Time vs. Temperature**  
( $I_L=170\text{mA}_{DC}$ )

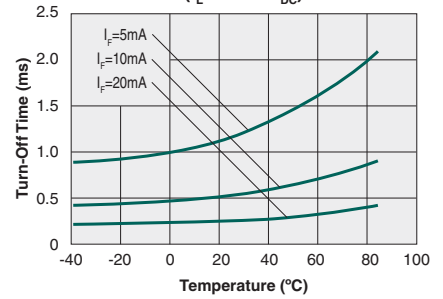

**Typical  $I_F$  for Switch Operation vs. Temperature**  
( $I_L=170\text{mA}_{DC}$ )

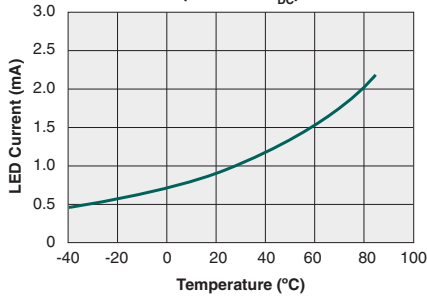

**Typical  $I_F$  for Switch Dropout vs. Temperature**  
( $I_L=170\text{mA}_{DC}$ )

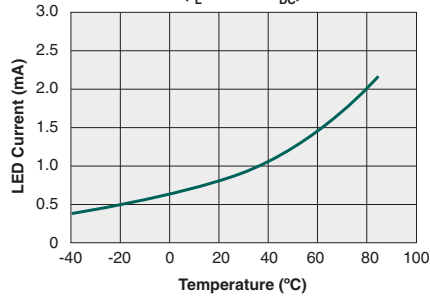

**Typical Load Current vs. Load Voltage**  
( $I_F=5\text{mA}$ )

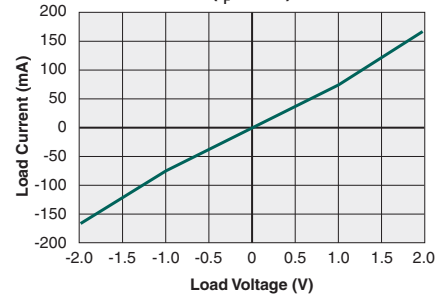

**Maximum Load Current vs. Temperature**  
( $I_F=5\text{mA}$ )

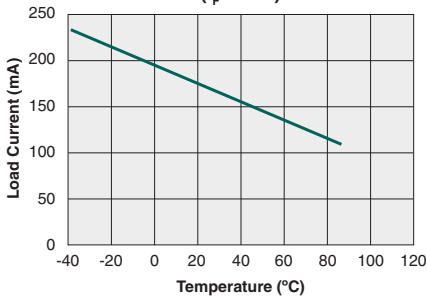

**Typical Blocking Voltage vs. Temperature**

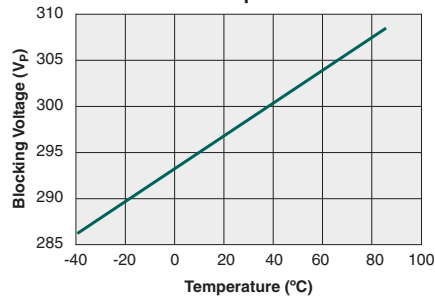

**Typical Leakage vs. Temperature Measured across Pins 4&6**

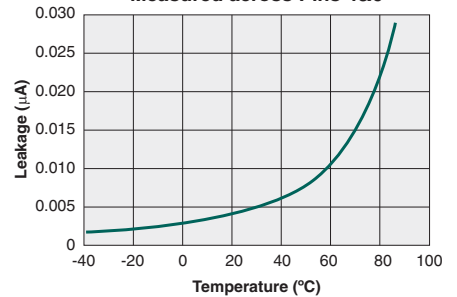

**Energy Rating Curve**

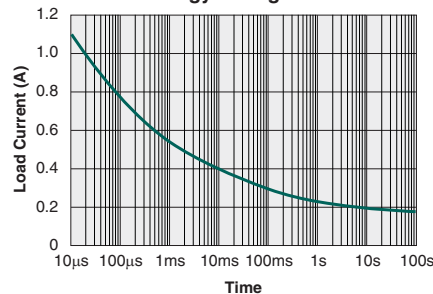

\*The Performance data shown in the graphs above is typical of device performance. For guaranteed parameters not indicated in the written specifications, please contact our application department.

## Manufacturing Information

### Moisture Sensitivity



All plastic encapsulated semiconductor packages are susceptible to moisture ingress. IXYS Integrated Circuits Division classified all of its plastic encapsulated devices for moisture sensitivity according to the latest version of the joint industry standard, **IPC/JEDEC J-STD-020**, in force at the time of product evaluation. We test all of our products to the maximum conditions set forth in the standard, and guarantee proper operation of our devices when handled according to the limitations and information in that standard as well as to any limitations set forth in the information or standards referenced below.

Failure to adhere to the warnings or limitations as established by the listed specifications could result in reduced product performance, reduction of operable life, and/or reduction of overall reliability.

This product carries a **Moisture Sensitivity Level (MSL) rating** as shown below, and should be handled according to the requirements of the latest version of the joint industry standard **IPC/JEDEC J-STD-033**.

Device	Moisture Sensitivity Level (MSL) Rating
LCB126 / LCB126S	MSL 1

### ESD Sensitivity



This product is **ESD Sensitive**, and should be handled according to the industry standard **JESD-625**.

### Reflow Profile

This product has a maximum body temperature and time rating as shown below. All other guidelines of **J-STD-020** must be observed.

Device	Maximum Temperature x Time
LCB126 / LCB126S	250°C for 30 seconds

### Board Wash

IXYS Integrated Circuits Division recommends the use of no-clean flux formulations. However, board washing to remove flux residue is acceptable. Since IXYS Integrated Circuits Division employs the use of silicone coating as an optical waveguide in many of its optically isolated products, the use of a short drying bake could be necessary if a wash is used after solder reflow processes. Chlorine- or Fluorine-based solvents or fluxes should not be used. Cleaning methods that employ ultrasonic energy should not be used.



**LCB126**

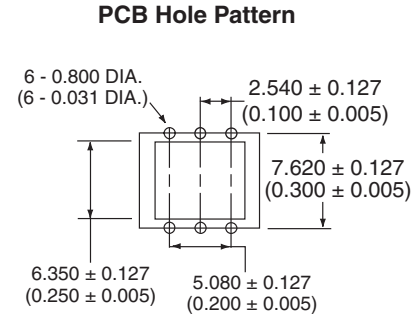
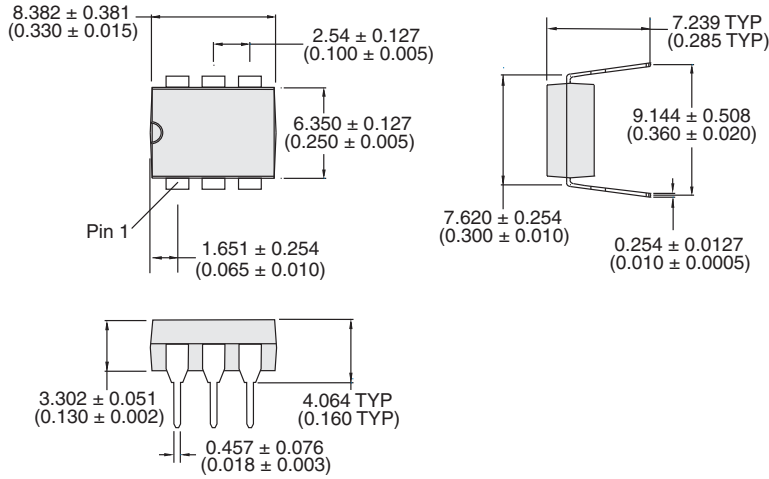

Dimensions  
mm  
(inches)

**LCB126S**

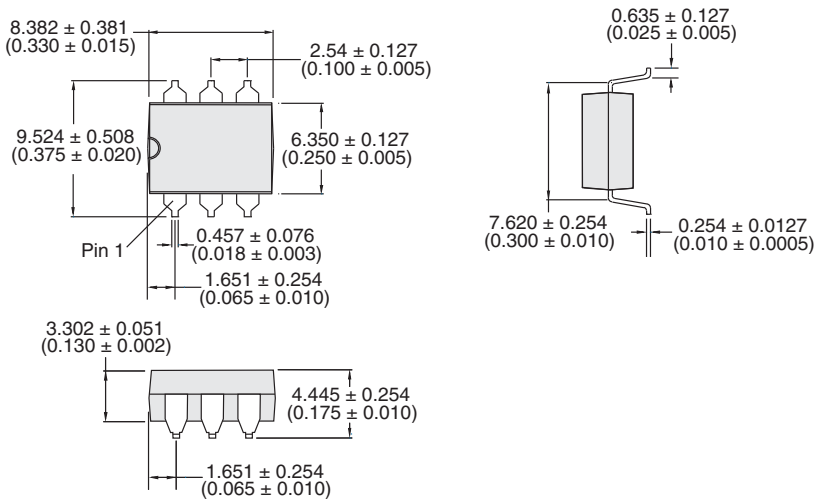

**PCB Land Pattern**

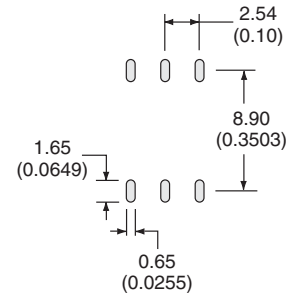

Dimensions  
mm  
(inches)

## LCB126STR Tape & Reel

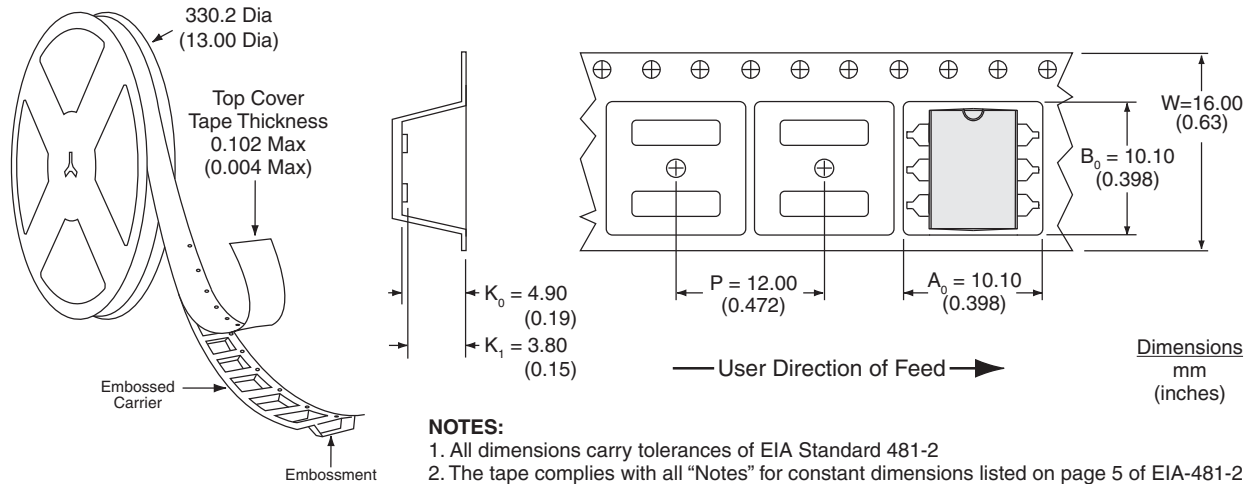

### For additional information please visit our website at: [www.ixysic.com](http://www.ixysic.com)

IXYS Integrated Circuits Division makes no representations or warranties with respect to the accuracy or completeness of the contents of this publication and reserves the right to make changes to specifications and product descriptions at any time without notice. Neither circuit patent licenses nor indemnity are expressed or implied. Except as set forth in IXYS Integrated Circuits Division's Standard Terms and Conditions of Sale, IXYS Integrated Circuits Division assumes no liability whatsoever, and disclaims any express or implied warranty, relating to its products including, but not limited to, the implied warranty of merchantability, fitness for a particular purpose, or infringement of any intellectual property right.

The products described in this document are not designed, intended, authorized or warranted for use as components in systems intended for surgical implant into the body, or in other applications intended to support or sustain life, or where malfunction of IXYS Integrated Circuits Division's product may result in direct physical harm, injury, or death to a person or severe property or environmental damage. IXYS Integrated Circuits Division reserves the right to discontinue or make changes to its products at any time without notice.



## Стандарт Электрон Связь

Мы молодая и активно развивающаяся компания в области поставок электронных компонентов. Мы поставляем электронные компоненты отечественного и импортного производства напрямую от производителей и с крупнейших складов мира.

Благодаря сотрудничеству с мировыми поставщиками мы осуществляем комплексные и плановые поставки широчайшего спектра электронных компонентов.

Собственная эффективная логистика и склад в обеспечивает надежную поставку продукции в точно указанные сроки по всей России.

Мы осуществляем техническую поддержку нашим клиентам и предпродажную проверку качества продукции. На все поставляемые продукты мы предоставляем гарантию .

Осуществляем поставки продукции под контролем ВП МО РФ на предприятия военно-промышленного комплекса России , а также работаем в рамках 275 ФЗ с открытием отдельных счетов в уполномоченном банке. Система менеджмента качества компании соответствует требованиям ГОСТ ISO 9001.

Минимальные сроки поставки, гибкие цены, неограниченный ассортимент и индивидуальный подход к клиентам являются основой для выстраивания долгосрочного и эффективного сотрудничества с предприятиями радиоэлектронной промышленности, предприятиями ВПК и научно-исследовательскими институтами России.

С нами вы становитесь еще успешнее!

### Наши контакты:

**Телефон:** +7 812 627 14 35

**Электронная почта:** [sales@st-electron.ru](mailto:sales@st-electron.ru)

**Адрес:** 198099, Санкт-Петербург,  
Промышленная ул, дом № 19, литера Н,  
помещение 100-Н Офис 331