

MC74VHCT373A

Octal D-Type Latch with 3-State Output

The MC74VHCT373A is an advanced high speed CMOS octal latch with 3-state output fabricated with silicon gate CMOS technology. It achieves high speed operation similar to equivalent Bipolar Schottky TTL while maintaining CMOS low power dissipation.

This 8-bit D-type latch is controlled by a latch enable input and an output enable input. When the output enable input is high, the eight outputs are in a high impedance state.

The internal circuit is composed of three stages, including a buffer output which provides high noise immunity and stable output.

The VHCT inputs are compatible with TTL levels. This device can be used as a level converter for interfacing 3.3 V to 5.0 V, because it has full 5.0 V CMOS level output swings.

The VHCT373A input and output (when disabled) structures provide protection when voltages between 0 V and 5.5 V are applied, regardless of the supply voltage. These input and output structures help prevent device destruction caused by supply voltage-input/output voltage mismatch, battery backup, hot insertion, etc.

Features

- High Speed: $t_{PD} = 7.7$ ns (Typ) at $V_{CC} = 5.0$ V
- Low Power Dissipation: $I_{CC} = 4$ μ A (Max) at $T_A = 25^\circ$ C
- TTL-Compatible Inputs: $V_{IL} = 0.8$ V; $V_{IH} = 2.0$ V
- Power Down Protection Provided on Inputs and Outputs
- Balanced Propagation Delays
- Designed for 4.5 V to 5.5 V Operating Range
- Low Noise: $V_{OLP} = 1.6$ V (Max)
- Pin and Function Compatible with Other Standard Logic Families
- Latchup Performance Exceeds 300 mA
- ESD Performance:
 - Human Body Model > 2000 V;
 - Machine Model > 200 V
- Chip Complexity: 196 FETs or 49 Equivalent Gates
- These Devices are Pb-Free and are RoHS Compliant



ON Semiconductor®

<http://onsemi.com>

MARKING DIAGRAMS

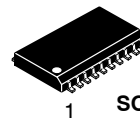

**SOIC-20WB
SUFFIX DW
CASE 751D**

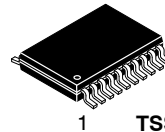
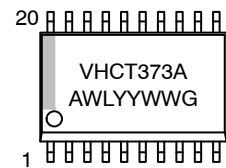

**TSSOP-20
SUFFIX DT
CASE 948E**

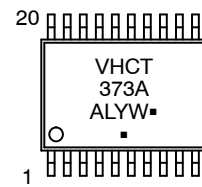

A = Assembly Location
 WL, L = Wafer Lot
 YY, Y = Year
 WW, W = Work Week
 G or \blacksquare = Pb-Free Package
 (Note: Microdot may be in either location)

FUNCTION TABLE

INPUTS			OUTPUT
OE	LE	D	Q
L	H	H	H
L	H	L	L
L	L	X	No Change
H	X	X	Z

ORDERING INFORMATION

See detailed ordering and shipping information in the package dimensions section on page 4 of this data sheet.

MC74VHCT373A

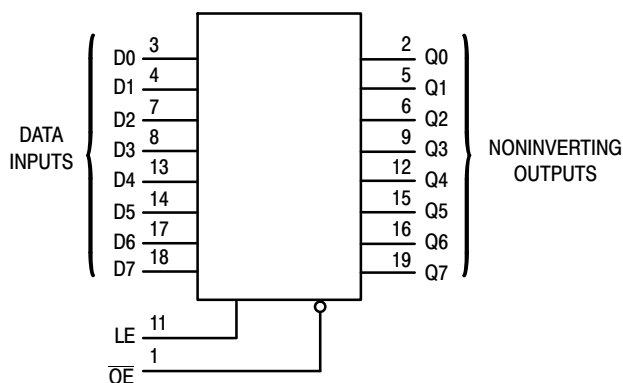

Figure 1. Logic Diagram

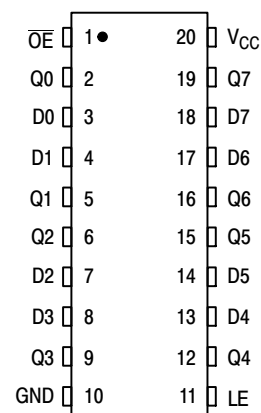

Figure 2. Pin Assignment

MAXIMUM RATINGS

Symbol	Parameter	Value	Unit
V_{CC}	DC Supply Voltage	- 0.5 to + 7.0	V
V_{in}	DC Input Voltage	- 0.5 to + 7.0	V
V_{out}	DC Output Voltage Outputs in 3-State High or Low State	- 0.5 to + 7.0 - 0.5 to $V_{CC} + 0.5$	V
I_{IK}	Input Diode Current	- 20	mA
I_{OK}	Output Diode Current ($V_{OUT} < GND$; $V_{OUT} > V_{CC}$)	± 20	mA
I_{out}	DC Output Current, per Pin	± 25	mA
I_{CC}	DC Supply Current, V_{CC} and GND Pins	± 75	mA
P_D	Power Dissipation in Still Air, SOIC Packages† TSSOP Package†	500 450	mW
T_{stg}	Storage Temperature	- 65 to + 150	°C

This device contains protection circuitry to guard against damage due to high static voltages or electric fields. However, precautions must be taken to avoid applications of any voltage higher than maximum rated voltages to this high-impedance circuit. For proper operation, V_{in} and V_{out} should be constrained to the range $GND \leq (V_{in} \text{ or } V_{out}) \leq V_{CC}$. Unused inputs must always be tied to an appropriate logic voltage level (e.g., either GND or V_{CC}). Unused outputs must be left open.

Maximum ratings are those values beyond which device damage can occur. Maximum ratings applied to the device are individual stress limit values (not normal operating conditions) and are not valid simultaneously. If these limits are exceeded, device functional operation is not implied, damage may occur and reliability may be affected.

†Derating - SOIC Packages: - 7 mW/°C from 65° to 125°C
TSSOP Package: - 6.1 mW/°C from 65° to 125°C

RECOMMENDED OPERATING CONDITIONS

Symbol	Parameter	Min	Max	Unit
V_{CC}	DC Supply Voltage	4.5	5.5	V
V_{in}	DC Input Voltage	0	5.5	V
V_{out}	DC Output Voltage Outputs in 3-State High or Low State	0 0	5.5 V_{CC}	V
T_A	Operating Temperature	- 40	+ 85	°C
t_r, t_f	Input Rise and Fall Time $V_{CC} = 5.0V \pm 0.5V$	0	20	ns/V

MC74VHCT373A

DC ELECTRICAL CHARACTERISTICS

Symbol	Parameter	Test Conditions	V _{CC} V	T _A = 25°C			T _A = -40 to 85°C		Unit
				Min	Typ	Max	Min	Max	
V _{IH}	Minimum High-Level Input Voltage		4.5 to 5.5	2.0			2.0		V
V _{IL}	Maximum Low-Level Input Voltage		4.5 to 5.5			0.8		0.8	V
V _{OH}	Minimum High-Level Output Voltage V _{in} = V _{IH} or V _{IL}	I _{OH} = -50μA	4.5	4.4	4.5		4.4		V
		I _{OH} = -8mA	4.5	3.94			3.80		
V _{OL}	Maximum Low-Level Output Voltage V _{in} = V _{IH} or V _{IL}	I _{OL} = 50μA	4.5		0.0	0.1		0.1	V
		I _{OL} = 8mA	4.5			0.36		0.44	
I _{in}	Maximum Input Leakage Current	V _{in} = 5.5 V or GND	0 to 5.5			±0.1		±1.0	μA
I _{OZ}	Maximum 3-State Leakage Current	V _{in} = V _{IL} or V _{IH} V _{out} = V _{CC} or GND	5.5			±0.25		±2.5	μA
I _{CC}	Maximum Quiescent Supply Current	V _{in} = V _{CC} or GND	5.5			4.0		40.0	μA
I _{CC(T)}	Quiescent Supply Current	Per Input: V _{IN} = 3.4V Other Input: V _{CC} or GND	5.5			1.35		1.50	mA
I _{OPD}	Output Leakage Current	V _{OUT} = 5.5V	0			0.5		5.0	μA

AC ELECTRICAL CHARACTERISTICS (Input t_r = t_f = 3.0ns)

Symbol	Parameter	Test Conditions	T _A = 25°C			T _A = -40 to 85°C		Unit
			Min	Typ	Max	Min	Max	
t _{PLH} , t _{PHL}	Maximum Propagation Delay, LE to Q	V _{CC} = 5.0 ± 0.5V C _L = 15pF C _L = 50pF		7.7	12.3	1.0	13.5	ns
				8.5	13.3	1.0	14.5	
t _{PLH} , t _{PHL}	Maximum Propagation Delay, D to Q	V _{CC} = 5.0 ± 0.5V C _L = 15pF C _L = 50pF		5.1	8.5	1.0	9.5	ns
				5.9	9.5	1.0	10.5	
t _{PZL} , t _{PZH}	Output Enable Time, OE to Q	V _{CC} = 5.0 ± 0.5V R _L = 1kΩ C _L = 50pF		6.3	10.9	1.0	12.5	ns
				7.1	11.9	1.0	13.5	
t _{PLZ} , t _{PHZ}	Output Disable Time, OE to Q	V _{CC} = 5.0 ± 0.5V R _L = 1kΩ		8.8	11.2	1.0	12.0	ns
t _{OSLH} , t _{OSHL}	Output to Output Skew	V _{CC} = 5.5 ± 0.5V C _L = 50pF (Note 1)			1.0		1.0	ns
C _{in}	Maximum Input Capacitance			4	10		10	pF
C _{out}	Maximum Three-State Output Capacitance (Output in High-Impedance State)			6				pF

C _{PD}	Power Dissipation Capacitance (Note 2)	Typical @ 25°C, V _{CC} = 5.0V		pF
		25		

- Parameter guaranteed by design. t_{OSLH} = |t_{PLHm} - t_{PLHn}|, t_{OSHL} = |t_{PHLm} - t_{PHLn}|.
- C_{PD} is defined as the value of the internal equivalent capacitance which is calculated from the operating current consumption without load. Average operating current can be obtained by the equation: I_{CC(OPR)} = C_{PD} • V_{CC} • f_{in} + I_{CC}/8 (per latch). C_{PD} is used to determine the no-load dynamic power consumption; P_D = C_{PD} • V_{CC}² • f_{in} + I_{CC} • V_{CC}.

MC74VHCT373A

NOISE CHARACTERISTICS (Input $t_r = t_f = 3.0\text{ns}$, $C_L = 50\text{pF}$, $V_{CC} = 5.0\text{V}$)

Symbol	Parameter	$T_A = 25^\circ\text{C}$		Unit
		Typ	Max	
V_{OLP}	Quiet Output Maximum Dynamic V_{OL}	1.2	1.6	V
V_{OLV}	Quiet Output Minimum Dynamic V_{OL}	-1.2	-1.6	V
V_{IHD}	Minimum High Level Dynamic Input Voltage		2.0	V
V_{ILD}	Maximum Low Level Dynamic Input Voltage		0.8	V

TIMING REQUIREMENTS (Input $t_r = t_f = 3.0\text{ns}$)

Symbol	Parameter	Test Conditions	$T_A = 25^\circ\text{C}$		$T_A = -40\text{ to }85^\circ\text{C}$	Unit
			Typ	Limit	Limit	
$t_{w(h)}$	Minimum Pulse Width, LE	$V_{CC} = 5.0 \pm 0.5\text{V}$		6.5	8.5	ns
t_{su}	Minimum Setup Time, D to LE	$V_{CC} = 5.0 \pm 0.5\text{V}$		1.5	1.5	ns
t_h	Minimum Hold Time, D to LE	$V_{CC} = 5.0 \pm 0.5\text{V}$		3.5	3.5	ns

ORDERING INFORMATION

Device	Package	Shipping [†]
MC74VHCT373ADWRG	SOIC-20WB (Pb-Free)	1000 / Tape & Reel
MC74VHCT373ADTRG	TSSOP-20*	2500 / Tape & Reel

[†]For information on tape and reel specifications, including part orientation and tape sizes, please refer to our Tape and Reel Packaging Specifications Brochure, BRD8011/D.

*This package is inherently Pb-Free.

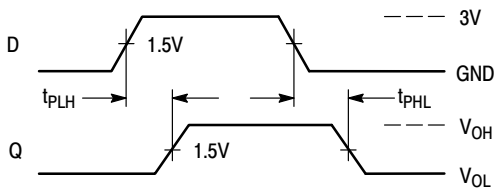

Figure 3. Switching Waveform

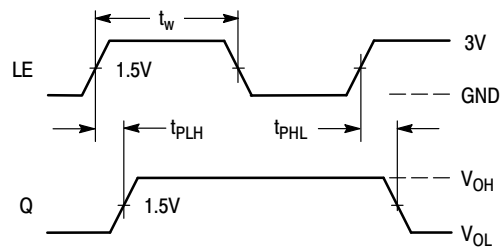

Figure 4. Switching Waveform

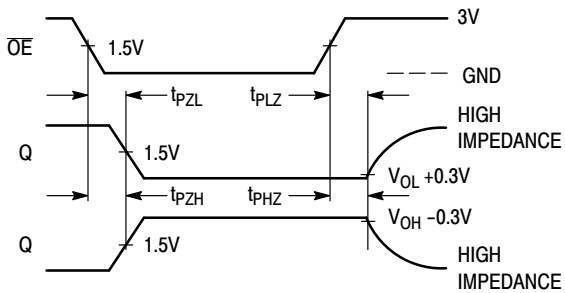

Figure 5. Switching Waveform

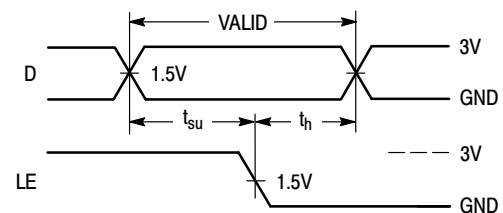
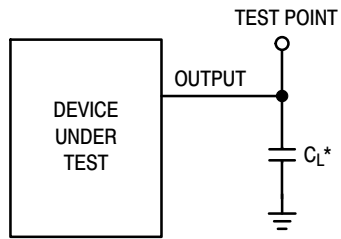

Figure 6. Switching Waveform

MC74VHCT373A



*Includes all probe and jig capacitance

Figure 7. Test Circuit

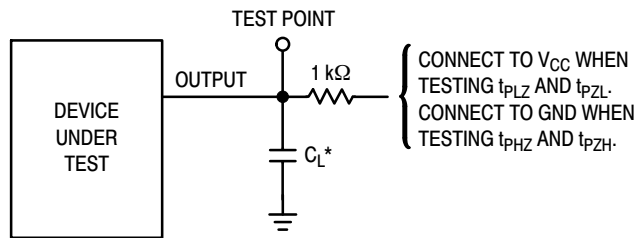

*Includes all probe and jig capacitance

Figure 8. Test Circuit

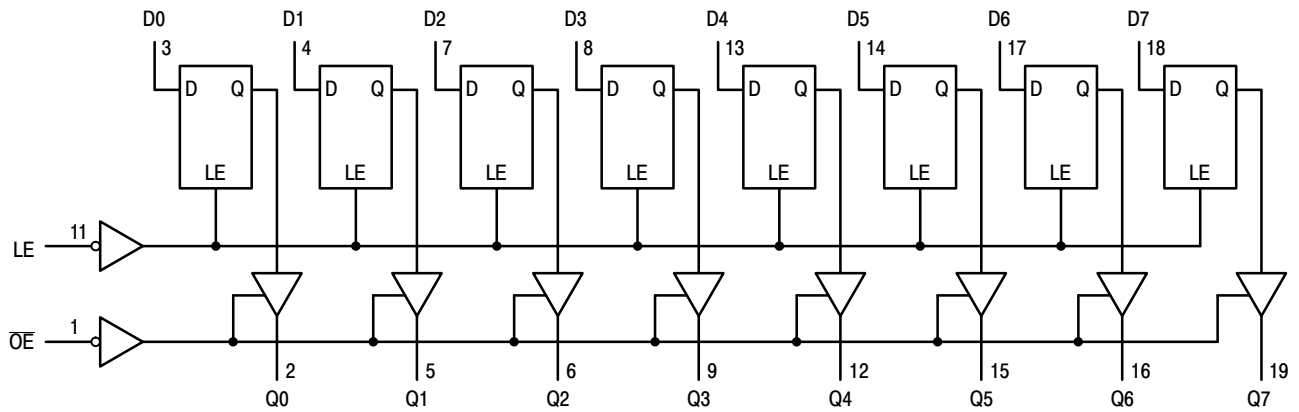
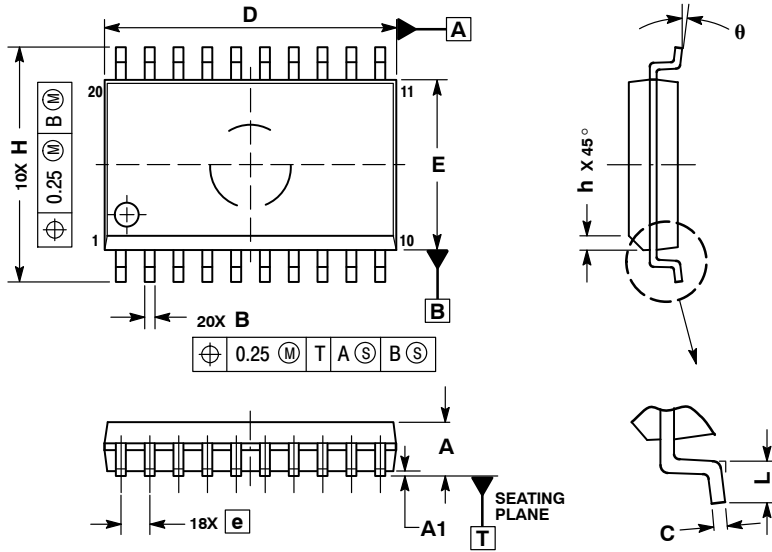

Figure 9. Expanded Logic Diagram

MC74VHCT373A

PACKAGE DIMENSIONS

SOIC-20 WB
DW SUFFIX
CASE 751D-05
ISSUE G



NOTES:

1. DIMENSIONS ARE IN MILLIMETERS.
2. INTERPRET DIMENSIONS AND TOLERANCES PER ASME Y14.5M, 1994.
3. DIMENSIONS D AND E DO NOT INCLUDE MOLD PROTRUSION.
4. MAXIMUM MOLD PROTRUSION 0.15 PER SIDE.
5. DIMENSION B DOES NOT INCLUDE DAMBAR PROTRUSION. ALLOWABLE PROTRUSION SHALL BE 0.13 TOTAL IN EXCESS OF B DIMENSION AT MAXIMUM MATERIAL CONDITION.

DIM	MILLIMETERS	
	MIN	MAX
A	2.35	2.65
A1	0.10	0.25
B	0.35	0.49
C	0.23	0.32
D	12.65	12.95
E	7.40	7.60
e	1.27 BSC	
H	10.05	10.55
h	0.25	0.75
L	0.50	0.90
theta	0°	7°

ON Semiconductor and are registered trademarks of Semiconductor Components Industries, LLC (SCILLC). SCILLC reserves the right to make changes without further notice to any products herein. SCILLC makes no warranty, representation or guarantee regarding the suitability of its products for any particular purpose, nor does SCILLC assume any liability arising out of the application or use of any product or circuit, and specifically disclaims any and all liability, including without limitation special, consequential or incidental damages. "Typical" parameters which may be provided in SCILLC data sheets and/or specifications can and do vary in different applications and actual performance may vary over time. All operating parameters, including "Typicals" must be validated for each customer application by customer's technical experts. SCILLC does not convey any license under its patent rights nor the rights of others. SCILLC products are not designed, intended, or authorized for use as components in systems intended for surgical implant into the body, or other applications intended to support or sustain life, or for any other application in which the failure of the SCILLC product could create a situation where personal injury or death may occur. Should Buyer purchase or use SCILLC products for any such unintended or unauthorized application, Buyer shall indemnify and hold SCILLC and its officers, employees, subsidiaries, affiliates, and distributors harmless against all claims, costs, damages, and expenses, and reasonable attorney fees arising out of, directly or indirectly, any claim of personal injury or death associated with such unintended or unauthorized use, even if such claim alleges that SCILLC was negligent regarding the design or manufacture of the part. SCILLC is an Equal Opportunity/Affirmative Action Employer. This literature is subject to all applicable copyright laws and is not for resale in any manner.

PUBLICATION ORDERING INFORMATION

LITERATURE FULFILLMENT:
Literature Distribution Center for ON Semiconductor
P.O. Box 5163, Denver, Colorado 80217 USA
Phone: 303-675-2175 or 800-344-3860 Toll Free USA/Canada
Fax: 303-675-2176 or 800-344-3867 Toll Free USA/Canada
Email: orderlit@onsemi.com

N. American Technical Support: 800-282-9855 Toll Free
USA/Canada
Europe, Middle East and Africa Technical Support:
Phone: 421 33 790 2910
Japan Customer Focus Center
Phone: 81-3-5773-3850

ON Semiconductor Website: www.onsemi.com
Order Literature: <http://www.onsemi.com/orderlit>
For additional information, please contact your local Sales Representative



Стандарт Электрон Связь

Мы молодая и активно развивающаяся компания в области поставок электронных компонентов. Мы поставляем электронные компоненты отечественного и импортного производства напрямую от производителей и с крупнейших складов мира.

Благодаря сотрудничеству с мировыми поставщиками мы осуществляем комплексные и плановые поставки широчайшего спектра электронных компонентов.

Собственная эффективная логистика и склад в обеспечивает надежную поставку продукции в точно указанные сроки по всей России.

Мы осуществляем техническую поддержку нашим клиентам и предпродажную проверку качества продукции. На все поставляемые продукты мы предоставляем гарантию .

Осуществляем поставки продукции под контролем ВП МО РФ на предприятия военно-промышленного комплекса России , а также работаем в рамках 275 ФЗ с открытием отдельных счетов в уполномоченном банке. Система менеджмента качества компании соответствует требованиям ГОСТ ISO 9001.

Минимальные сроки поставки, гибкие цены, неограниченный ассортимент и индивидуальный подход к клиентам являются основой для выстраивания долгосрочного и эффективного сотрудничества с предприятиями радиоэлектронной промышленности, предприятиями ВПК и научно-исследовательскими институтами России.

С нами вы становитесь еще успешнее!

Наши контакты:

Телефон: +7 812 627 14 35

Электронная почта: sales@st-electron.ru

Адрес: 198099, Санкт-Петербург,
Промышленная ул, дом № 19, литера Н,
помещение 100-Н Офис 331