

FJP5304D

NPN Silicon Transistor

High Voltage High Speed Power Switch Application

- Wide Safe Operating Area
- Built-in Free Wheeling diode Suitable for Electronic Ballast Application
- Suitable for Electronic Ballast Application
- Small Variance in Storage Time

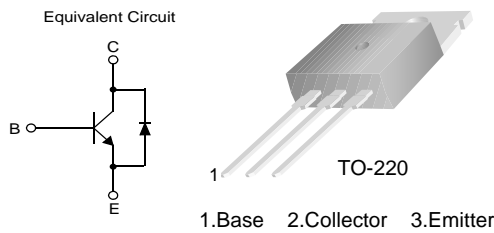

Absolute Maximum Ratings $T_C=25^\circ\text{C}$ unless otherwise noted

| Symbol | Parameter | Value | Units |
|-----------|--|------------|------------------|
| V_{CBO} | Collector-Base Voltage | 700 | V |
| V_{CEO} | Collector-Emitter Voltage | 400 | V |
| V_{EBO} | Emitter-Base Voltage | 12 | V |
| I_C | Collector Current (DC) | 4 | A |
| I_{CP} | * Collector Current (Pulse) | 8 | A |
| I_B | Base Current (DC) | 2 | A |
| I_{BP} | * Base Current (Pulse) | 4 | A |
| P_C | Collector Dissipation ($T_C=25^\circ\text{C}$) | 70 | W |
| T_{STG} | Storage Temperature | - 65 ~ 150 | $^\circ\text{C}$ |

* Pulse Test Pulse Width = 5ms, Duty Cycle \geq 1.0%

Electrical Characteristics $T_C=25^\circ\text{C}$ unless otherwise noted

| Symbol | Parameter | Test Condition | Min. | Typ. | Max. | Units |
|------------|-------------------------------------|------------------------------------|------|------|------|-------|
| BV_{CBO} | Collector-Base Breakdown Voltage | $I_C = 1\text{mA}, I_E = 0$ | 700 | | | V |
| BV_{CEO} | Collector-Emitter Breakdown Voltage | $I_C = 5\text{mA}, I_B = 0$ | 400 | | | V |
| BV_{EBO} | Emitter-Base Breakdown Voltage | $I_E = 1\text{mA}, I_C = 0$ | 12 | | | V |
| I_{CES} | Collector Cut-off Current | $V_{CE} = 700\text{V}, V_{EB} = 0$ | | | 100 | mA |
| I_{CEO} | Collector Cut-off Current | $V_{CE} = 400\text{V}, I_B = 0$ | | | 250 | mA |
| I_{EBO} | Emitter Cut-off Current | $V_{EB} = 12\text{V}, I_C = 0$ | | | 100 | mA |

| | | | | | | |
|--|--------------------------------------|--|---------|-----|-------------------|---------|
| h_{FE} | DC Current Gain | $V_{CE} = 5V, I_C = 10mA$ $V_{CE} = 5V, I_C = 2A$ | 10 8 | | 40 | |
| $V_{CE(sat)}$ | Collector-Emitter Saturation Voltage | $I_C = 0.5A, I_B = 0.1A$ $I_C = 1A, I_B = 0.2A$ $I_C = 2.5A, I_B = 0.5A$ | | | 0.7 1.0 1.5 | V |
| $V_{BE(sat)}$ | Base-Emitter Saturation Voltage | $I_C = 0.5A, I_B = 0.1A$ $I_C = 1A, I_B = 0.2A$ $I_C = 2.5A, I_B = 0.5A$ | | | 1.1 1.2 1.3 | V |
| V_f | Internal Diode Forward Voltage Drop | $I_F = 2A$ | | | 2.5 | V |
| Inductive Load Switching ($V_{CC} = 200V$) | | | | | | |
| t_{stg} | Storage Time | $I_C = 2A, I_{B1} = 0.4A$ $V_{BE(off)} = -5V, L = 200\mu H$ | | 0.6 | | μs |
| t_f | Fall Time | | | 0.1 | | |
| Resistive Load Switching ($V_{CC} = 250V$) | | | | | | |
| t_{stg} | Storage Time | $I_C = 2A, I_{B1} = I_{B2} = 0.4A$ $T_P = 30\mu s$ | | | 2.9 | μs |
| t_f | Fall Time | | | 0.2 | | |

* Pulse test: $PW \leq 300\mu s$, Duty cycle $\leq 2\%$

Thermal Characteristics

| Symbol | Parameter | Max. | Units |
|-----------------|---|------|---------------|
| $R_{\theta JC}$ | Thermal Resistance, Junction to Case | 1.78 | $^{\circ}C/W$ |
| $R_{\theta JA}$ | Thermal Resistance, Junction to Ambient | 62.5 | $^{\circ}C/W$ |

Typical Characteristics

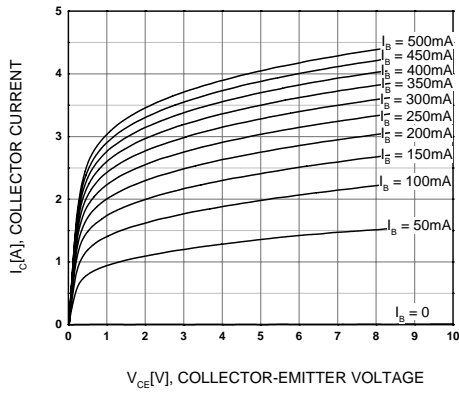

Figure 1. Static Characteristic

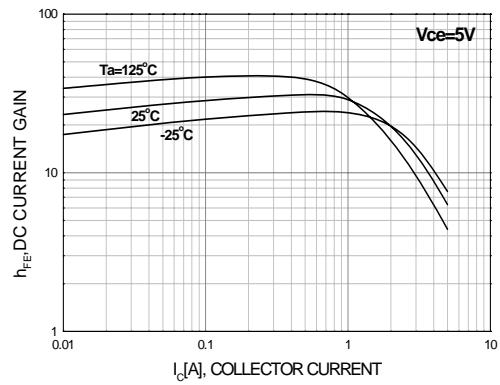

Figure 2. DC Current Gain

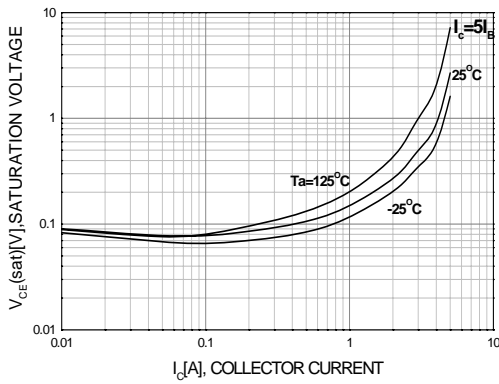

Figure 3. Collector-Emitter Saturation Voltage

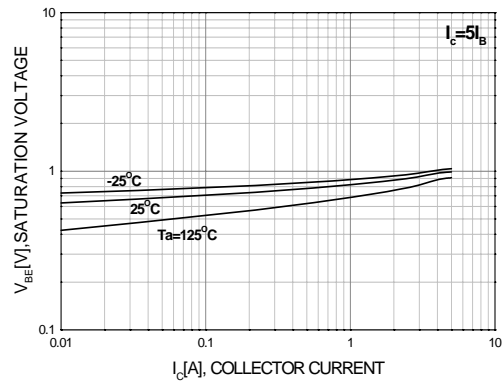

Figure 4. Base-Emitter Saturation Voltage

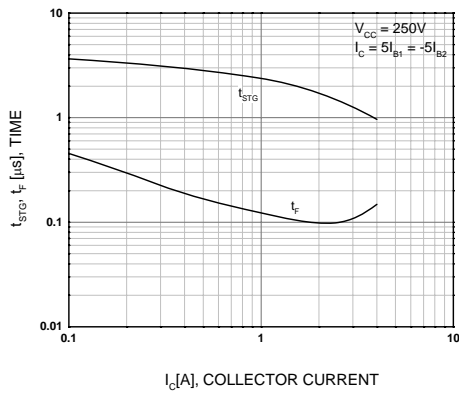

Figure 5. Resistive Load Switching Time

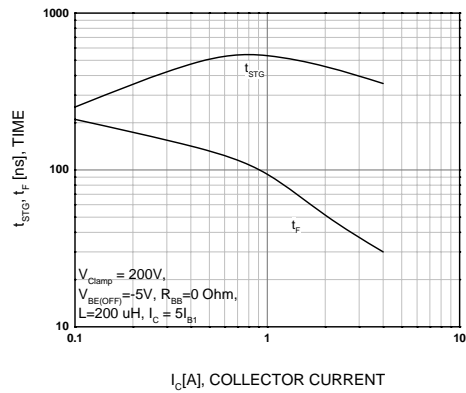

Figure 6. Inductive Load Switching Time

Typical Characteristics (Continued)

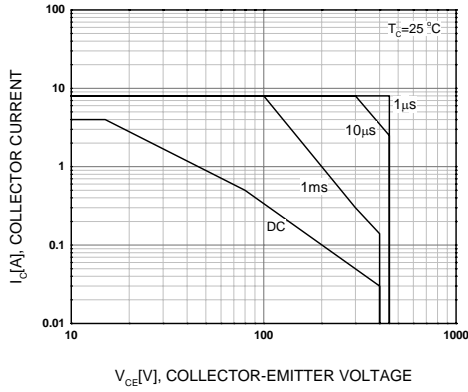

Figure 1. Forward Bias Safe Operating Area

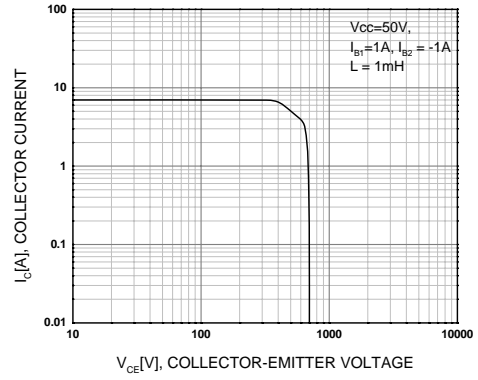

Figure 2. Reverse Bias Safe Operating Area

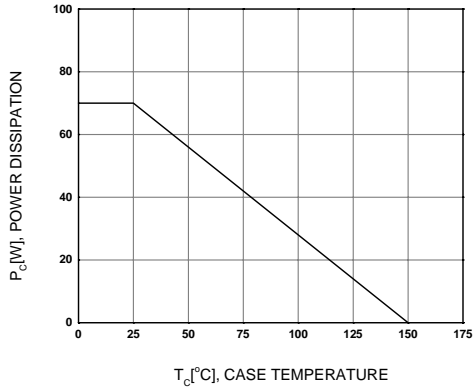
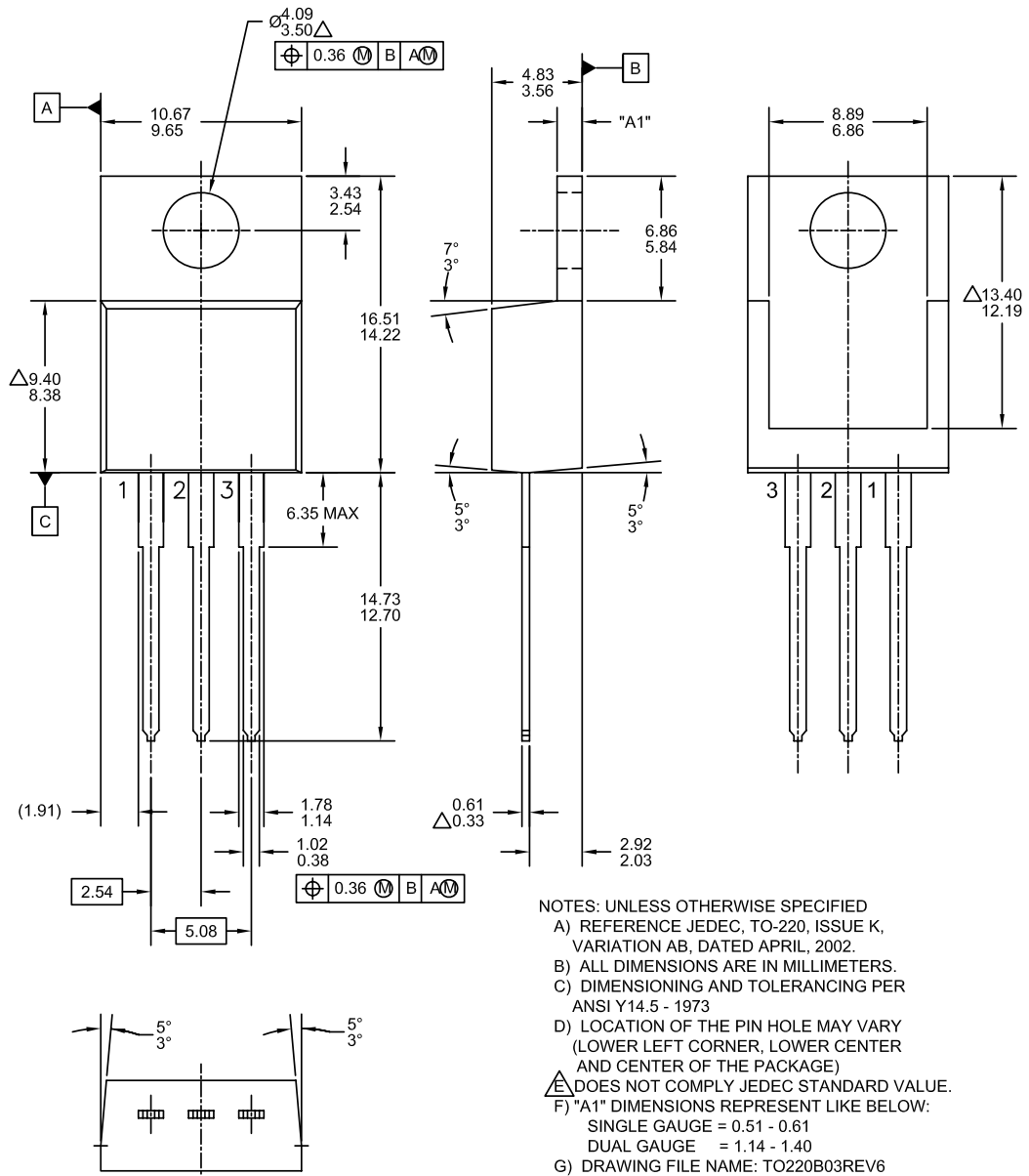

Figure 3. Power Derating

Mechanical Dimensions

TO220





TRADEMARKS

The following includes registered and unregistered trademarks and service marks, owned by Fairchild Semiconductor and/or its global subsidiaries, and is not intended to be an exhaustive list of all such trademarks.

- | | | | |
|---|-------------------------------------|---|---|
| Build it Now™ | FPS™ | PDP SPM™ | The Power Franchise® |
| CorePLUS™ | F-PFS™ | Power-SPM™ |  |
| CorePOWER™ | FRFET® | PowerTrench® | TinyBoost™ |
| CROSSVOLT™ | Global Power Resource SM | Programmable Active Droop™ | TinyBuck™ |
| CTL™ | Green FPST™ | QFET® | TinyLogic® |
| Current Transfer Logic™ | Green FPST™ e-Series™ | QST™ | TINYOPTO™ |
| EcoSPARK® | GTO™ | Quiet Series™ | TinyPower™ |
| EfficientMax™ | IntelliMAX™ | RapidConfigure™ | TinyPWM™ |
| EZSWITCH™ * | ISOPLANAR™ | Saving our world, 1mW at a time™ | TinyWire™ |
|  | MegaBuck™ | SmartMax™ | μSerDes™ |
|  | MICROCOUPLER™ | SMART START™ |  |
| Fairchild® | MicroFET™ | SPM® | UHC® |
| Fairchild Semiconductor® | MicroPak™ | STEALTH™ | Ultra FRFET™ |
| FACT Quiet Series™ | MillerDrive™ | SuperFET™ | UniFET™ |
| FACT® | MotionMax™ | SuperSOT™.3 | VCM™ |
| FAST® | Motion-SPM™ | SuperSOT™.6 | VisualMax™ |
| FastvCore™ | OPTOLOGIC® | SuperSOT™.8 | |
| FlashWriter® * | OPTOPLANAR® | SupreMOS™ | |
| | | SyncFET™ | |
| | |  | |

* EZSWITCH™ and FlashWriter® are trademarks of System General Corporation, used under license by Fairchild Semiconductor.

DISCLAIMER

FAIRCHILD SEMICONDUCTOR RESERVES THE RIGHT TO MAKE CHANGES WITHOUT FURTHER NOTICE TO ANY PRODUCTS HEREIN TO IMPROVE RELIABILITY, FUNCTION, OR DESIGN. FAIRCHILD DOES NOT ASSUME ANY LIABILITY ARISING OUT OF THE APPLICATION OR USE OF ANY PRODUCT OR CIRCUIT DESCRIBED HEREIN; NEITHER DOES IT CONVEY ANY LICENSE UNDER ITS PATENT RIGHTS, NOR THE RIGHTS OF OTHERS. THESE SPECIFICATIONS DO NOT EXPAND THE TERMS OF FAIRCHILD'S WORLDWIDE TERMS AND CONDITIONS, SPECIFICALLY THE WARRANTY THEREIN, WHICH COVERS THESE PRODUCTS.

LIFE SUPPORT POLICY

FAIRCHILD'S PRODUCTS ARE NOT AUTHORIZED FOR USE AS CRITICAL COMPONENTS IN LIFE SUPPORT DEVICES OR SYSTEMS WITHOUT THE EXPRESS WRITTEN APPROVAL OF FAIRCHILD SEMICONDUCTOR CORPORATION.

As used herein:

1. Life support devices or systems are devices or systems which, (a) are intended for surgical implant into the body or (b) support or sustain life, and (c) whose failure to perform when properly used in accordance with instructions for use provided in the labeling, can be reasonably expected to result in a significant injury of the user.
2. A critical component in any component of a life support, device, or system whose failure to perform can be reasonably expected to cause the failure of the life support device or system, or to affect its safety or effectiveness.

ANTI-COUNTERFEITING POLICY

Fairchild Semiconductor Corporation's Anti-Counterfeiting Policy. Fairchild's Anti-Counterfeiting Policy is also stated on our external website, www.fairchildsemi.com, under Sales Support.

Counterfeiting of semiconductor parts is a growing problem in the industry. All manufacturers of semiconductor products are experiencing counterfeiting of their parts. Customers who inadvertently purchase counterfeit parts experience many problems such as loss of brand reputation, substandard performance, failed applications, and increased cost of production and manufacturing delays. Fairchild is taking strong measures to protect ourselves and our customers from the proliferation of counterfeit parts. Fairchild strongly encourages customers to purchase Fairchild parts either directly from Fairchild or from Authorized Fairchild Distributors who are listed by country on our web page cited above. Products customers buy either from Fairchild directly or from Authorized Fairchild Distributors are genuine parts, have full traceability, meet Fairchild's quality standards for handling and storage and provide access to Fairchild's full range of up-to-date technical and product information. Fairchild and our Authorized Distributors will stand behind all warranties and will appropriately address any warranty issues that may arise. Fairchild will not provide any warranty coverage or other assistance for parts bought from Unauthorized Sources. Fairchild is committed to combat this global problem and encourage our customers to do their part in stopping this practice by buying direct or from authorized distributors.

PRODUCT STATUS DEFINITIONS

Definition of Terms

| Datasheet Identification | Product Status | Definition |
|--------------------------|-----------------------|---|
| Advance Information | Formative / In Design | Datasheet contains the design specifications for product development. Specifications may change in any manner without notice. |
| Preliminary | First Production | Datasheet contains preliminary data; supplementary data will be published at a later date. Fairchild Semiconductor reserves the right to make changes at any time without notice to improve design. |
| No Identification Needed | Full Production | Datasheet contains final specifications. Fairchild Semiconductor reserves the right to make changes at any time without notice to improve the design. |
| Obsolete | Not In Production | Datasheet contains specifications on a product that is discontinued by Fairchild Semiconductor. The datasheet is for reference information only. |

Rev. 135



Стандарт Электрон Связь

Мы молодая и активно развивающаяся компания в области поставок электронных компонентов. Мы поставляем электронные компоненты отечественного и импортного производства напрямую от производителей и с крупнейших складов мира.

Благодаря сотрудничеству с мировыми поставщиками мы осуществляем комплексные и плановые поставки широчайшего спектра электронных компонентов.

Собственная эффективная логистика и склад в обеспечивает надежную поставку продукции в точно указанные сроки по всей России.

Мы осуществляем техническую поддержку нашим клиентам и предпродажную проверку качества продукции. На все поставляемые продукты мы предоставляем гарантию .

Осуществляем поставки продукции под контролем ВП МО РФ на предприятия военно-промышленного комплекса России , а также работаем в рамках 275 ФЗ с открытием отдельных счетов в уполномоченном банке. Система менеджмента качества компании соответствует требованиям ГОСТ ISO 9001.

Минимальные сроки поставки, гибкие цены, неограниченный ассортимент и индивидуальный подход к клиентам являются основой для выстраивания долгосрочного и эффективного сотрудничества с предприятиями радиоэлектронной промышленности, предприятиями ВПК и научно-исследовательскими институтами России.

С нами вы становитесь еще успешнее!

Наши контакты:

Телефон: +7 812 627 14 35

Электронная почта: sales@st-electron.ru

Адрес: 198099, Санкт-Петербург,
Промышленная ул, дом № 19, литера Н,
помещение 100-Н Офис 331