

Low Noise Silicon Bipolar RF Transistor

- For low noise, low distortion broadband amplifiers in antenna and telecommunications systems up to 1.5 GHz at collector currents from 20 mA to 80 mA
- Power amplifier for DECT and PCN systems
- $f_T = 7.5$ GHz, $NF_{min} = 1.3$ dB at 900 MHz
- Pb-free (RoHS compliant) and halogen-free package with visible leads
- Qualification report according to AEC-Q101 available



ESD (Electrostatic discharge) sensitive device, observe handling precaution!

| Type | Marking | Pin Configuration | | | | | | Package |
|---------|---------|-------------------|-------|-------|-------|---|---|---------|
| BFP196W | RIs | 1 = E | 2 = C | 3 = E | 4 = B | - | - | SOT343 |

Maximum Ratings at $T_A = 25$ °C, unless otherwise specified

| Parameter | Symbol | Value | Unit |
|---|-----------|-------------|------|
| Collector-emitter voltage | V_{CEO} | 12 | V |
| Collector-emitter voltage | V_{CES} | 20 | |
| Collector-base voltage | V_{CBO} | 20 | |
| Emitter-base voltage | V_{EBO} | 2 | |
| Collector current | I_C | 150 | mA |
| Base current | I_B | 15 | |
| Total power dissipation ¹⁾ $T_S \leq 69$ °C | P_{tot} | 700 | mW |
| Junction temperature | T_J | 150 | °C |
| Ambient temperature | T_A | -65 ... 150 | |
| Storage temperature | T_{Stg} | -65 ... 150 | |

Thermal Resistance

| Parameter | Symbol | Value | Unit |
|--|------------|-------|------|
| Junction - soldering point ²⁾ | R_{thJS} | 115 | K/W |

¹⁾ T_S is measured on the collector lead at the soldering point to the pcb

²⁾ For the definition of R_{thJS} please refer to Application Note AN077 (Thermal Resistance Calculation)

Electrical Characteristics at $T_A = 25\text{ °C}$, unless otherwise specified

| Parameter | Symbol | Values | | | Unit |
|---|---------------|--------|------|------|---------------|
| | | min. | typ. | max. | |
| DC Characteristics | | | | | |
| Collector-emitter breakdown voltage $I_C = 1\text{ mA}, I_B = 0$ | $V_{(BR)CEO}$ | 12 | - | - | V |
| Collector-emitter cutoff current $V_{CE} = 20\text{ V}, V_{BE} = 0$ | I_{CES} | - | - | 100 | μA |
| Collector-base cutoff current $V_{CB} = 10\text{ V}, I_E = 0$ | I_{CBO} | - | - | 100 | nA |
| Emitter-base cutoff current $V_{EB} = 1\text{ V}, I_C = 0$ | I_{EBO} | - | - | 1 | μA |
| DC current gain $I_C = 50\text{ mA}, V_{CE} = 8\text{ V}$, pulse measured | h_{FE} | 70 | 100 | 140 | - |

Electrical Characteristics at $T_A = 25\text{ }^\circ\text{C}$, unless otherwise specified

| Parameter | Symbol | Values | | | Unit |
|---|---------------|--------|------|------|------|
| | | min. | typ. | max. | |
| AC Characteristics (verified by random sampling) | | | | | |
| Transition frequency $I_C = 70\text{ mA}$, $V_{CE} = 8\text{ V}$, $f = 500\text{ MHz}$ | f_T | 5 | 7.5 | - | GHz |
| Collector-base capacitance $V_{CB} = 10\text{ V}$, $f = 1\text{ MHz}$, $V_{BE} = 0$, emitter grounded | C_{cb} | - | 0.86 | 1.3 | pF |
| Collector emitter capacitance $V_{CE} = 10\text{ V}$, $f = 1\text{ MHz}$, $V_{BE} = 0$, base grounded | C_{ce} | - | 0.4 | - | |
| Emitter-base capacitance $V_{EB} = 0.5\text{ V}$, $f = 1\text{ MHz}$, $V_{CB} = 0$, collector grounded | C_{eb} | - | 3.9 | - | |
| Minimum noise figure $I_C = 20\text{ mA}$, $V_{CE} = 8\text{ V}$, $Z_S = Z_{Sopt}$, $f = 900\text{ MHz}$ $f = 1.8\text{ GHz}$ | NF_{min} | - | 1.3 | - | dB |
| Power gain, maximum available ¹⁾ $I_C = 50\text{ mA}$, $V_{CE} = 8\text{ V}$, $Z_S = Z_{Sopt}$, $Z_L = Z_{Lopt}$, $f = 900\text{ MHz}$ $f = 1.8\text{ GHz}$ | G_{ma} | - | 19 | - | |
| Transducer gain $I_C = 50\text{ mA}$, $V_{CE} = 8\text{ V}$, $Z_S = Z_L = 50\Omega$, $f = 900\text{ MHz}$ $f = 1.8\text{ GHz}$ | $ S_{21e} ^2$ | - | 13 | - | dB |
| Third order intercept point at output ²⁾ $I_C = 50\text{ mA}$, $V_{CE} = 8\text{ V}$, $Z_S = Z_L = 50\Omega$, $f = 0.9\text{ GHz}$ | IP_3 | - | 32 | - | dBm |
| 1dB Compression point at output $I_C = 50\text{ mA}$, $V_{CE} = 8\text{ V}$, $Z_S = Z_L = 50\Omega$, $f = 0.9\text{ GHz}$ | P_{-1dB} | - | 19 | - | |

$$^1G_{ma} = |S_{21} / S_{12}| (k - (k^2 - 1)^{1/2})$$

²IP3 value depends on termination of all intermodulation frequency components.

Termination used for this measurement is 50Ω from 0.2 MHz to 12 GHz

Total power dissipation $P_{tot} = f(T_S)$

Permissible Pulse Load $R_{thJS} = f(t_p)$

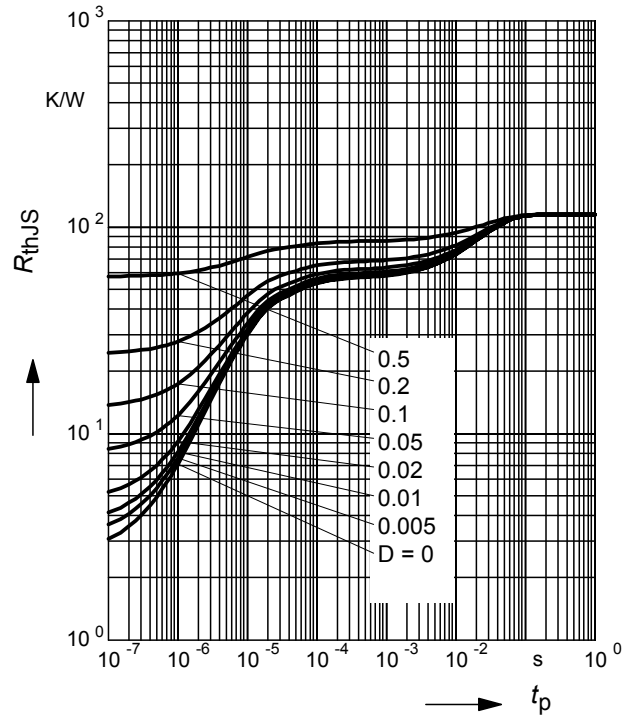
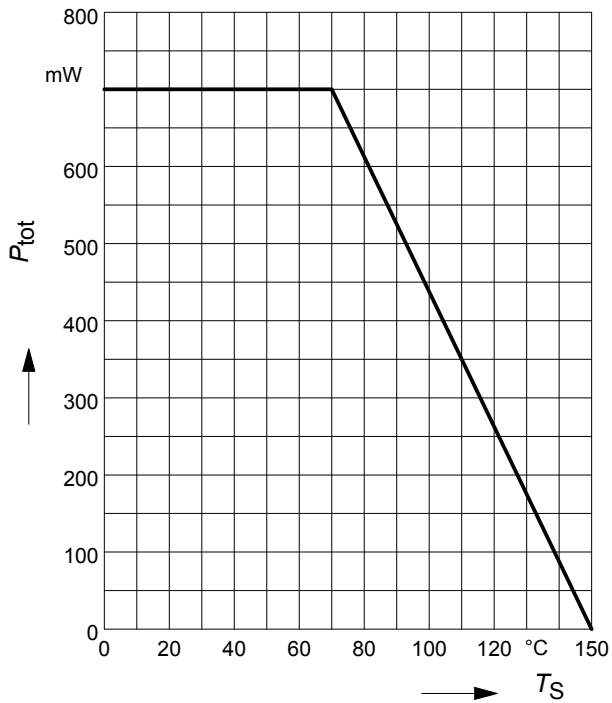

Permissible Pulse Load

$P_{totmax}/P_{totDC} = f(t_p)$

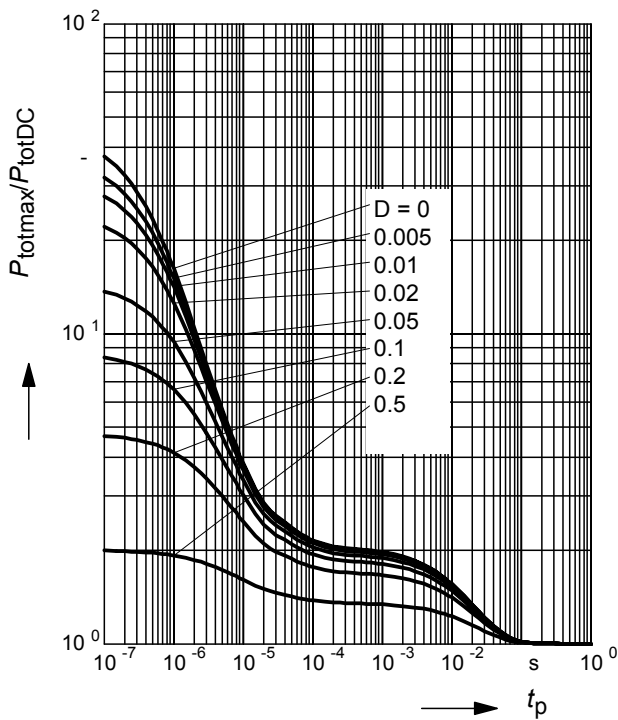

Package Outline

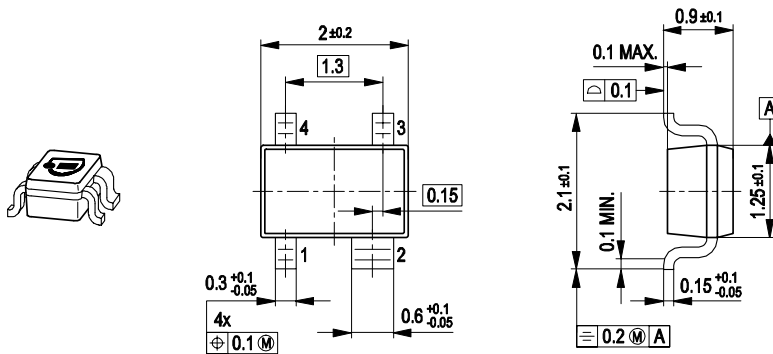

Foot Print

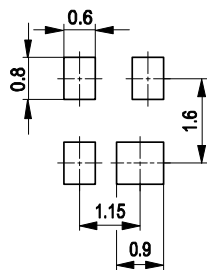

Marking Layout (Example)

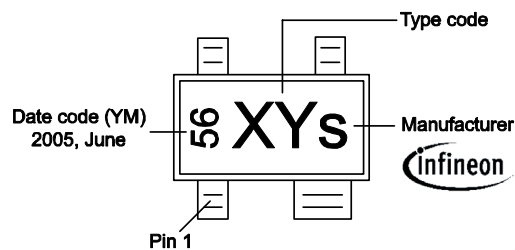

Standard Packing

Reel ø180 mm = 3.000 Pieces/Reel
 Reel ø330 mm = 10.000 Pieces/Reel

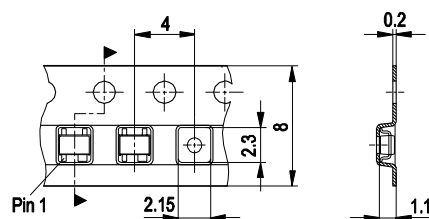

Edition 2009-11-16

**Published by
Infineon Technologies AG
81726 Munich, Germany**

**© 2009 Infineon Technologies AG
All Rights Reserved.**

Legal Disclaimer

The information given in this document shall in no event be regarded as a guarantee of conditions or characteristics. With respect to any examples or hints given herein, any typical values stated herein and/or any information regarding the application of the device, Infineon Technologies hereby disclaims any and all warranties and liabilities of any kind, including without limitation, warranties of non-infringement of intellectual property rights of any third party.

Information

For further information on technology, delivery terms and conditions and prices, please contact the nearest Infineon Technologies Office (www.infineon.com).

Warnings

Due to technical requirements, components may contain dangerous substances. For information on the types in question, please contact the nearest Infineon Technologies Office.

Infineon Technologies components may be used in life-support devices or systems only with the express written approval of Infineon Technologies, if a failure of such components can reasonably be expected to cause the failure of that life-support device or system or to affect the safety or effectiveness of that device or system. Life support devices or systems are intended to be implanted in the human body or to support and/or maintain and sustain and/or protect human life. If they fail, it is reasonable to assume that the health of the user or other persons may be endangered.



Стандарт Электрон Связь

Мы молодая и активно развивающаяся компания в области поставок электронных компонентов. Мы поставляем электронные компоненты отечественного и импортного производства напрямую от производителей и с крупнейших складов мира.

Благодаря сотрудничеству с мировыми поставщиками мы осуществляем комплексные и плановые поставки широчайшего спектра электронных компонентов.

Собственная эффективная логистика и склад в обеспечивает надежную поставку продукции в точно указанные сроки по всей России.

Мы осуществляем техническую поддержку нашим клиентам и предпродажную проверку качества продукции. На все поставляемые продукты мы предоставляем гарантию .

Осуществляем поставки продукции под контролем ВП МО РФ на предприятия военно-промышленного комплекса России , а также работаем в рамках 275 ФЗ с открытием отдельных счетов в уполномоченном банке. Система менеджмента качества компании соответствует требованиям ГОСТ ISO 9001.

Минимальные сроки поставки, гибкие цены, неограниченный ассортимент и индивидуальный подход к клиентам являются основой для выстраивания долгосрочного и эффективного сотрудничества с предприятиями радиоэлектронной промышленности, предприятиями ВПК и научно-исследовательскими институтами России.

С нами вы становитесь еще успешнее!

Наши контакты:

Телефон: +7 812 627 14 35

Электронная почта: sales@st-electron.ru

Адрес: 198099, Санкт-Петербург,
Промышленная ул, дом № 19, литера Н,
помещение 100-Н Офис 331