

MAXIM

High-Gain Vector Multipliers

General Description

The MAX2045/MAX2046/MAX2047 low-cost, fully integrated vector multipliers alter the magnitude and phase of an RF signal. Each device is optimized for the UMTS (MAX2045), DCS/PCS (MAX2046), or cellular/GSM (MAX2047) frequency bands. These devices feature differential RF inputs and outputs.

The MAX2045/MAX2046/MAX2047 provide vector adjustment through the differential I/Q amplifiers. The I/Q amplifiers can interface with voltage and/or current digital-to-analog converters (DACs). The voltage inputs are designed to interface to a voltage-mode DAC, while the current inputs are designed to interface to a current-mode DAC. An internal 2.5V reference voltage is provided for applications using single-ended voltage DACs.

The MAX2045/MAX2046/MAX2047 operate from a 4.75V to 5.25V single supply. All devices are offered in a compact 5mm x 5mm, 32-lead thin QFN exposed-paddle packages.

The MAX2045/MAX2046/MAX2047 evaluation kits are available, contact factory for availability.

Applications

UMTS/PCS/DCS/Cellular/GSM Base Station
Feed-Forward and Predistortion Power Amplifiers
RF Magnitude and Phase Adjustment
RF Cancellation Loops
Beam-Forming Applications

Ordering Information

PART	TEMP RANGE	PIN-PACKAGE
MAX2045ETJ-T	-40°C to +85°C	32 Thin QFN-EP*
MAX2046ETJ-T	-40°C to +85°C	32 Thin QFN-EP*
MAX2047ETJ-T	-40°C to +85°C	32 Thin QFN-EP*

*EP = Exposed paddle.

Features

- ◆ Multiple RF Frequency Bands of Operation
 - 2040MHz to 2240MHz (MAX2045)
 - 1740MHz to 2060MHz (MAX2046)
 - 790MHz to 1005MHz (MAX2047)
- ◆ ± 0.2 dB Gain Flatness
- ◆ $\pm 1^\circ$ Phase Flatness
- ◆ 3dB Control Bandwidth: 260MHz
- ◆ 15dBm Input IP3
- ◆ 15dB Gain Control Range
- ◆ Continuous 360° Phase Control Range
- ◆ 6.5dB Maximum Gain for Continuous Phase
- ◆ On-Chip Reference for Single-Ended Voltage-Mode Operation
- ◆ 800mW Power Consumption
- ◆ Space-Saving 5mm x 5mm Thin QFN Package
- ◆ Single 5V supply

Pin Configuration/Block Diagram

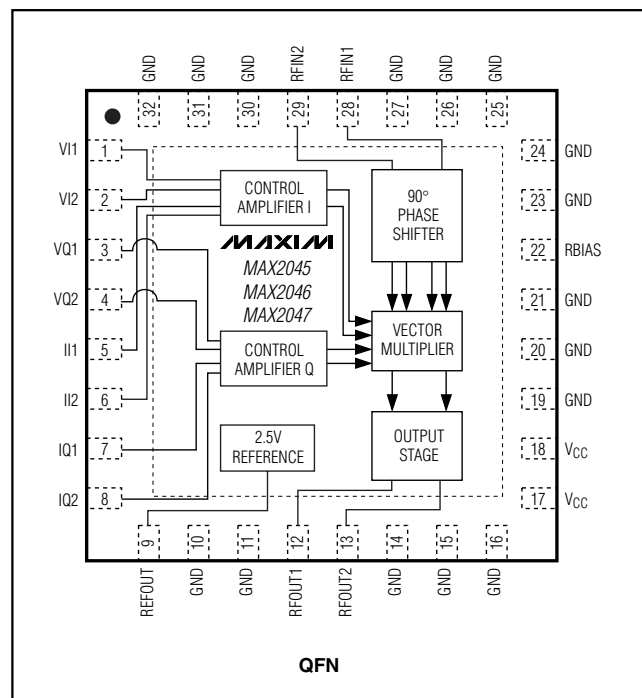

High-Gain Vector Multipliers

ABSOLUTE MAXIMUM RATINGS

V _{CC} to GND	-0.3V to +6V	Continuous RF Input Power (CW).....	+15dBm
VI1, V12, VQ1, VQ2, RFIN1, RFIN2, RFOUT1, RFOUT2	-0.3V to V _{CC} + 0.3V	Continuous Power Dissipation (T _A = +70°C) 32-Pin Thin QFN (derate 21.3mW/°C above +70°C)	1.7W
RFOUT1, RFOUT2 Sink Current.....	35mA	Operating Temperature Range	-40°C to +85°C
REFOUT Source Current.....	4mA	Junction Temperature	+150°C
II1, II2, IQ1, IQ2.....	-0.3V to +1V	Storage Temperature Range	-40°C to +150°C
II1, II2, IQ1, IQ2 Sink Current	+10mA	Lead Temperature (soldering, 10s)	+300°C

Stresses beyond those listed under "Absolute Maximum Ratings" may cause permanent damage to the device. These are stress ratings only, and functional operation of the device at these or any other conditions beyond those indicated in the operational sections of the specifications is not implied. Exposure to absolute maximum rating conditions for extended periods may affect device reliability.

DC ELECTRICAL CHARACTERISTICS

(Typical Operating Circuit as shown in Figure 1; V_{CC} = 4.75V to 5.25V, T_A = -40°C to +85°C, R_{BIAS} = 280Ω, no RF inputs applied, RF input and output ports are terminated with 50Ω. Typical values are at V_{CC} = 5V and T_A = +25°C, unless otherwise noted.)

PARAMETER	SYMBOL	CONDITIONS	MIN	TYP	MAX	UNITS
Supply Voltage Range	V _{CC}		4.75	5	5.25	V
Operating Supply Current	I _{CC}	MAX2045	120	160	200	mA
		MAX2046	120	160	200	
		MAX2047	120	160	200	
Differential Input Resistance, VI1 to VI2, VQ1 to VQ2		Input resistance between VI1 and VI2 or VQ1 and VQ2	6.5	9	11.5	kΩ
Common-Mode Input Voltage, VI1, VI2, VQ1, VQ2	V _{CM}			2.5		V
Input Resistance, II1, II2, IQ1, IQ2		Single-ended resistance to ground	150	200	250	Ω
Reference Voltage	V _{REFOUT}	REFOUT unloaded	2.3	2.45	2.6	V

AC ELECTRICAL CHARACTERISTICS

(Typical Operating Circuit as shown in Figure 1; V_{CC} = 4.75V to 5.25V, T_A = -40°C to +85°C, R_{BIAS} = 280Ω, f_{IN} = 2.14GHz (MAX2045), f_{IN} = 1.9GHz (MAX2046), f_{IN} = 915MHz (MAX2047), input current range = 0 to 4mA (if using a current-mode DAC), and differential input voltage range = 0 to 0.707V (if using a voltage-mode DAC). If using a current-mode DAC, voltage mode I/Q inputs are left open. If using a voltage-mode DAC, all current-mode I/Q inputs are left open. Typical values are at V_{CC} = 5V and T_A = +25°C, unless otherwise noted.) (Notes 1, 2, 3)

PARAMETER	CONDITIONS	MIN	TYP	MAX	UNITS
RF Differential Input Impedance			50		Ω
RF Differential Output Impedance			300		Ω
RF Differential Load Impedance			200		Ω
Continuous Phase Range		0		360	Degrees

High-Gain Vector Multipliers

MAX2045/MAX2046/MAX2047

MAX2045 ELECTRICAL CHARACTERISTICS

(Typical Operating Circuit as shown in Figure 1; $V_{CC} = 4.75V$ to $5.25V$, $T_A = -40^{\circ}C$ to $+85^{\circ}C$, $R_{BIAS} = 280\Omega$, $f_{IN} = 2.14GHz$, input current range = 0 to 4mA (if using a current-mode DAC), and differential input voltage range = 0 to 0.707V (if using a voltage-mode DAC). If using a current-mode DAC, voltage mode I/Q inputs are left open. If using a voltage-mode DAC, all current-mode I/Q inputs are left open. Typical values are at $V_{CC} = 5V$ and $T_A = +25^{\circ}C$, unless otherwise noted.) (Notes 1, 2, 3)

PARAMETER	CONDITIONS	MIN	TYP	MAX	UNITS
Frequency Range		2040		2240	MHz
RF Input Return Loss			-14		dB
RF Output Return Loss			-16.4		dB
VOLTAGE MODE					
Power Gain	$V_I = V_Q = 0.707V$ (radius = 1V)		7		dB
	$V_I = V_Q = 0.5V$ (radius = 0.707V)		3.4		
	$V_I = V_Q = 0.25V$ (radius = 0.35V)		-3		
	$V_I = V_Q = 0.125V$ (radius = 0.175V)		-8.7		
Power-Gain Range	Difference in gain between $V_I = V_Q = 0.707V$ and $V_I = V_Q = 0.125V$		15.7		dB
Reverse Isolation	Over entire control range		-74		dB
Maximum Power Gain for Continuous Coverage of Phase Change	0 to 360° (radius = 1V)		6.1		dB
Maximum Power Gain with Reduced Phase Coverage	0 to 360° (radius = 1V)		7		dB
Group Delay	$V_I = V_Q = 0.707V$ (radius = 1V)		1.38		ns
Gain Drift Over Temperature	$V_I = V_Q = 0.707V$ (radius = 1V)		-0.027		dB/ $^{\circ}C$
Gain Flatness Over Frequency	$V_I = V_Q = 0.707V$ (radius = 1V); UMTS, $f_{IN} = 2140MHz \pm 100MHz$		± 0.21		dB
Phase Flatness Over Frequency	Electrical delay removed, $V_I = V_Q = 0.707V$ (radius = 1V), UMTS, $f_{IN} = 2140MHz \pm 100MHz$		± 0.2		Degrees
Output Noise Power	$V_I = V_Q = 0.707V$ (radius = 1V)		-147.7		dBm/Hz
	$V_I = V_Q = 0.5V$ (radius = 0.707V)		-148.3		
	$V_I = V_Q = 0.25V$ (radius = 0.35V)		-148.2		
	$V_I = V_Q = 0.125V$ (radius = 0.175V)		-148.1		
IP1dB	$V_I = V_Q = 0.707V$ (radius = 1V)		6.7		dBm
	$V_I = V_Q = 0.125V$ (radius = 0.175V)		9.3		
IIP3	$V_I = V_Q = 0.707V$ (radius = 1V)		15.2		dBm
	$V_I = V_Q = 0.125V$ (radius = 0.175V)		14.7		

High-Gain Vector Multipliers

MAX2045 ELECTRICAL CHARACTERISTICS (continued)

(Typical Operating Circuit as shown in Figure 1; $V_{CC} = 4.75V$ to $5.25V$, $T_A = -40^{\circ}C$ to $+85^{\circ}C$, $R_{BIAS} = 280\Omega$, $f_{IN} = 2.14GHz$, input current range = 0 to 4mA (if using a current-mode DAC), and differential input voltage range = 0 to 0.707V (if using a voltage-mode DAC). If using a current-mode DAC, voltage mode I/Q inputs are left open. If using a voltage-mode DAC, all current-mode I/Q inputs are left open. Typical values are at $V_{CC} = 5V$ and $T_A = +25^{\circ}C$, unless otherwise noted.) (Notes 1, 2, 3)

PARAMETER	CONDITIONS	MIN	TYP	MAX	UNITS
CURRENT MODE					
Power Gain (Note 4)	$I_{I1} = I_{Q1} = 4mA$, $I_{I2} = I_{Q2} = 0mA$		6.2		dB
	$I_{I1} = I_{Q1} = 1mA$, $I_{I2} = I_{Q2} = 0mA$		-8.7		
Power-Gain Range	Difference in gain between $I_{I1} = I_{Q1} = 4mA$, $I_{I2} = I_{Q2} = 0mA$ and $I_{I1} = I_{Q1} = 1mA$, $I_{I2} = I_{Q2} = 0mA$		14.9		dB
Gain Flatness Over Frequency	$I_{I1} = I_{Q1} = 4mA$, $I_{I2} = I_{Q2} = 0mA$; UMTS, $f_{IN} = 2140MHz \pm 100MHz$		± 0.27		dB
Phase Flatness Over Frequency	Electrical delay removed, $I_{I1} = I_{Q1} = 4mA$, $I_{I2} = I_{Q2} = 0mA$		± 0.8		Degrees

MAX2046 ELECTRICAL CHARACTERISTICS

(Typical Operating Circuit as shown in Figure 1; $V_{CC} = 4.75V$ to $5.25V$, $T_A = -40^{\circ}C$ to $+85^{\circ}C$, $R_{BIAS} = 280\Omega$, $f_{IN} = 1.9GHz$, input current range = 0 to 4mA (if using a current-mode DAC), and differential input voltage range = 0 to 0.707V (if using a voltage-mode DAC). If using a current-mode DAC, voltage mode I/Q inputs are left open. If using a voltage-mode DAC, all current-mode I/Q inputs are left open. Typical values are at $V_{CC} = 5V$ and $T_A = +25^{\circ}C$, unless otherwise noted.) (Notes 1, 2, 3)

PARAMETER	CONDITIONS	MIN	TYP	MAX	UNITS
Frequency Range		1740		2060	MHz
RF Input Return Loss			-21.1		dB
RF Output Return Loss			-21.7		dB
VOLTAGE MODE					
Power Gain	$V_I = V_Q = 0.707V$ (radius = 1V)		7.4		dB
	$V_I = V_Q = 0.5V$ (radius = 0.707V)		3.8		
	$V_I = V_Q = 0.25V$ (radius = 0.35V)		-2.5		
	$V_I = V_Q = 0.125V$ (radius = 0.175V)		-8.2		
Power-Gain Range	Difference in gain between $V_I = V_Q = 0.707V$ and $V_I = V_Q = 0.125V$		15.6		dB
Reverse Isolation	Over entire control range		-76		dB
Maximum Power Gain for Continuous Coverage of Phase Change	0 to 360° (radius = 1V)		6.5		dB
Maximum Power Gain with Reduced Phase Coverage	0 to 360° (radius = 1V)		7.4		dB
Group Delay	$V_I = V_Q = 0.707V$ (radius = 1V)		1.54		ns
Gain Drift Over Temperature	$V_I = V_Q = 0.707V$ (radius = 1V)		-0.026		dB/ $^{\circ}C$
Gain Flatness Over Frequency	$V_I = V_Q = 0.707V$ (radius = 1V)	PCS, $f_{IN} = 1960MHz \pm 100MHz$		± 0.14	dB
		DCS, $f_{IN} = 1842.5MHz \pm 100MHz$		± 0.3	

High-Gain Vector Multipliers

MAX2045/MAX2046/MAX2047

MAX2046 ELECTRICAL CHARACTERISTICS (continued)

(Typical Operating Circuit as shown in Figure 1; $V_{CC} = 4.75V$ to $5.25V$, $T_A = -40^{\circ}C$ to $+85^{\circ}C$, $R_{BIAS} = 280\Omega$, $f_{IN} = 1.9GHz$, input current range = 0 to 4mA (if using a current-mode DAC), and differential input voltage range = 0 to 0.707V (if using a voltage-mode DAC). If using a current-mode DAC, voltage mode I/Q inputs are left open. If using a voltage-mode DAC, all current-mode I/Q inputs are left open. Typical values are at $V_{CC} = 5V$ and $T_A = +25^{\circ}C$, unless otherwise noted.) (Notes 1, 2, 3)

PARAMETER	CONDITIONS		MIN	TYP	MAX	UNITS
Phase Flatness Over Frequency	Electrical delay removed, $V_I = V_Q = 0.707V$ (radius = 1V)	PCS, $f_{IN} = 1960MHz$ $\pm 100MHz$		± 1.3		Degrees
		DCS, $f_{IN} = 1842.5MHz$ $\pm 100MHz$		± 1.2		
Output Noise Power	$V_I = V_Q = 0.707V$ (radius = 1V)			-146.8		dBm/Hz
	$V_I = V_Q = 0.5V$ (radius = 0.707V)			-147.4		
	$V_I = V_Q = 0.25V$ (radius = 0.35V)			-147.4		
	$V_I = V_Q = 0.125V$ (radius = 0.175V)			-147.3		
IP1dB	$V_I = V_Q = 0.707V$ (radius = 1V)			6.5		dBm
	$V_I = V_Q = 0.125V$ (radius = 0.175V)			9.1		
IIP3	$V_I = V_Q = 0.707V$ (radius = 1V)			15.2		dBm
	$V_I = V_Q = 0.125V$ (radius = 0.175V)			14.8		
CURRENT MODE						
Power Gain (Note 4)	$I_{I1} = I_{Q1} = 4mA$, $I_{I2} = I_{Q2} = 0mA$			6.6		dB
	$I_{I1} = I_{Q1} = 1mA$, $I_{I2} = I_{Q2} = 0mA$			-8.2		
Power-Gain Range	Difference in gain between $I_{I1} = I_{Q1} = 4mA$, $I_{I2} = I_{Q2} = 0mA$ and $I_{I1} = I_{Q1} = 1mA$, $I_{I2} = I_{Q2} = 0mA$			14.8		dB
Gain Flatness Over Frequency	$I_{I1} = I_{Q1} = 4mA$, $I_{I2} = I_{Q2} = 0mA$	PCS, $f_{IN} = 1960MHz$ $\pm 100MHz$		± 0.14		dB
		DCS, $f_{IN} = 1842.5MHz$ $\pm 100MHz$		± 0.33		
Phase Flatness Over Frequency	Electrical delay removed, $I_{I1} = I_{Q1} = 4mA$, $I_{I2} = I_{Q2} = 0mA$	PCS, $f_{IN} = 1960MHz$ $\pm 100MHz$		± 0.8		Degrees
		DCS, $f_{IN} = 1842.5MHz$ $\pm 100MHz$		± 1.6		

High-Gain Vector Multipliers

MAX2047 ELECTRICAL CHARACTERISTICS

(Typical Operating Circuit as shown in Figure 1; $V_{CC} = 4.75V$ to $5.25V$, $T_A = -40^{\circ}C$ to $+85^{\circ}C$, $R_{BIAS} = 280\Omega$, $f_{IN} = 915MHz$, input current range = 0 to 4mA (if using a current-mode DAC), and differential input voltage range = 0 to 0.707V (if using a voltage-mode DAC). If using a current-mode DAC, voltage mode I/Q inputs are left open. If using a voltage-mode DAC, all current-mode I/Q inputs are left open. Typical values are at $V_{CC} = 5V$ and $T_A = +25^{\circ}C$, unless otherwise noted.) (Notes 1, 2, 3)

PARAMETER	CONDITIONS		MIN	TYP	MAX	UNITS
Frequency Range			790		1005	MHz
RF Input Return Loss				-21.8		dB
RF Output Return Loss				-11.7		dB
VOLTAGE MODE						
Power Gain	VI = VQ = 0.707V (radius = 1V)			8.4		dB
	VI = VQ = 0.5V (radius = 0.707V)			5.1		
	VI = VQ = 0.25V (radius = 0.35V)			-0.9		
	VI = VQ = 0.125V (radius = 0.175V)			-6.3		
Power-Gain Range	Difference in gain between VI = VQ = 0.707V and VI = VQ = 0.125V			14.7		dB
Reverse Isolation	Over entire control range			-75		dB
Maximum Power Gain for Continuous Coverage of Phase Change	0 to 360° (radius = 1V)			7.1		dB
Maximum Power Gain with Reduced Phase Coverage	0 to 360° (radius = 1V)			8.4		dB
Group Delay	VI = VQ = 0.707V (radius = 1V)			2.02		ns
Gain Drift Over Temperature	VI = VQ = 0.707V (radius = 1V)			-0.024		dB/°C
Gain Flatness Over Frequency	VI = VQ = 0.707V (radius = 1V)	GSM, $f_{IN} = 942.5MHz$ $\pm 62.5MHz$		± 0.25		dB
		US cell, $f_{IN} = 881.5MHz$ $\pm 62.5MHz$		± 0.13		
		JCDMA, $f_{IN} = 850MHz$ $\pm 60MHz$		± 0.1		
		KDI/JDC/PDC, $f_{IN} = 820MHz$ $\pm 30MHz$		± 0.1		
Phase Flatness Over Frequency	Electrical delay removed , VI = VQ = 0.707V (radius = 1V)	GSM, $f_{IN} = 942.5MHz$ $\pm 62.5MHz$		± 0.9		Degrees
		US cell, $f_{IN} = 881.5MHz$ $\pm 62.5MHz$		± 1.1		
		JCDMA, $f_{IN} = 850MHz$ $\pm 60MHz$		± 1.2		
		KDI/JDC/PDC, $f_{IN} = 820MHz$ $\pm 30MHz$		± 0.3		

High-Gain Vector Multipliers

MAX2045/MAX2046/MAX2047

MAX2047 ELECTRICAL CHARACTERISTICS (continued)

(Typical Operating Circuit as shown in Figure 1; $V_{CC} = 4.75V$ to $5.25V$, $T_A = -40^{\circ}C$ to $+85^{\circ}C$, $R_{BIAS} = 280\Omega$, $f_{IN} = 915MHz$, input current range = 0 to 4mA (if using a current-mode DAC), and differential input voltage range = 0 to 0.707V (if using a voltage-mode DAC). If using a current-mode DAC, voltage mode I/Q inputs are left open. If using a voltage-mode DAC, all current-mode I/Q inputs are left open. Typical values are at $V_{CC} = 5V$ and $T_A = +25^{\circ}C$, unless otherwise noted.) (Notes 1, 2, 3)

PARAMETER	CONDITIONS		MIN	TYP	MAX	UNITS
Output Noise Power	$V_I = V_Q = 0.707V$ (radius = 1V)			-147.5		dBm/Hz
	$V_I = V_Q = 0.5V$ (radius = 0.707V)			-148.4		
	$V_I = V_Q = 0.25V$ (radius = 0.35V)			-148.6		
	$V_I = V_Q = 0.125V$ (radius = 0.175V)			-148.6		
IP1dB	$V_I = V_Q = 0.707V$ (radius = 1V)			6.1		dBm
	$V_I = V_Q = 0.125V$ (radius = 0.175V)			6.9		
IIP3	$V_I = V_Q = 0.707V$ (radius = 1V)			15.6		dBm
	$V_I = V_Q = 0.125V$ (radius = 0.175V)			14.1		
CURRENT MODE						
Power Gain (Note 4)	$I_{I1} = I_{Q1} = 4mA$, $I_{I2} = I_{Q2} = 0mA$			8.1		dB
	$I_{I1} = I_{Q1} = 1mA$, $I_{I2} = I_{Q2} = 0mA$			-6.2		
Power-Gain Range	Difference in gain between $I_{I1} = I_{Q1} = 4mA$, $I_{I2} = I_{Q2} = 0mA$ and $I_{I1} = I_{Q1} = 1mA$, $I_{I2} = I_{Q2} = 0mA$			14.3		dB
Gain Flatness Over Frequency	$I_{I1} = I_{Q1} = 4mA$, $I_{I2} = I_{Q2} = 0mA$	GSM, $f_{IN} = 942.5MHz$ $\pm 62.5MHz$		± 0.25		dB
		US cell, $f_{IN} = 881.5MHz$ $\pm 62.5MHz$		± 0.12		
		JCDMA, $f_{IN} = 850MHz$ $\pm 60MHz$		± 0.1		
		KDI/JDC/PDC, $f_{IN} = 820MHz$ $\pm 30MHz$		± 0.1		
Phase Flatness Over Frequency	Electrical delay removed, $I_{I1} = I_{Q1} = 4mA$, $I_{I2} = I_{Q2} = 0mA$	GSM, $f_{IN} = 942.5MHz$ $\pm 62.5MHz$		± 0.8		Degrees
		US cell, $f_{IN} = 881.5MHz$ $\pm 62.5MHz$		± 1.1		
		JCDMA, $f_{IN} = 850MHz$ $\pm 60MHz$		± 1.3		
		KDI/JDC/PDC, $f_{IN} = 820MHz$ $\pm 30MHz$		± 0.4		

Note 1: Guaranteed by design and characterization.

Note 2: All specifications reflect losses and delays of external components (matching components, baluns, and PC board traces). Output measurements taken at the RF OUTPUT of the Typical Operating Circuit.

Note 3: Radius is defined as $(V_I^2 + V_Q^2)^{0.5}$. V_I denotes the difference between V_{I1} and V_{I2} . V_Q denotes the difference between V_{Q1} and V_{Q2} . For differential operation: $V_{I1} = V_{REF} + 0.5 \times V_I$, $V_{I2} = V_{REF} - 0.5 \times V_I$, $V_{Q1} = V_{REF} + 0.5 \times V_Q$, $V_{Q2} = V_{REF} - 0.5 \times V_Q$. For single-ended operation: $V_{I1} = V_{REF} + V_I$, $V_{I2} = V_{REF}$, $V_{Q1} = V_{REF} + V_Q$, $V_{Q2} = V_{REF}$.

Note 4: When using the I/Q current inputs, maximum gain occurs when one differential input current is zero and the other corresponding differential input is 5mA. Minimum gain occurs when both differential inputs are equal.

High-Gain Vector Multipliers

Typical Operating Characteristics (MAX2045)

($V_{CC} = 5V$, $f_{IN} = 2140MHz$, $V_{-1} = V_{I1}$ and V_{Q1} , $V_{-2} = V_{I2}$ and V_{Q2} , $I_{-1} = I_{I1}$ and I_{Q1} , $I_{-2} = I_{I2}$ and I_{Q2} , $V_{I1} = V_{Q1} = 3.2V$, $V_{I2} = V_{Q2} = REFOUT$, $P_{IN} = -15dBm$ per tone at 1MHz offset (IIP3), and $T_A = +25^\circ C$, unless otherwise noted.)

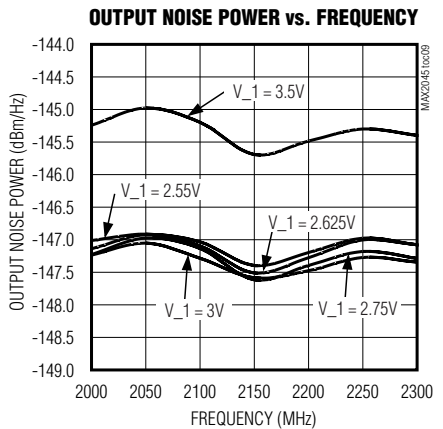
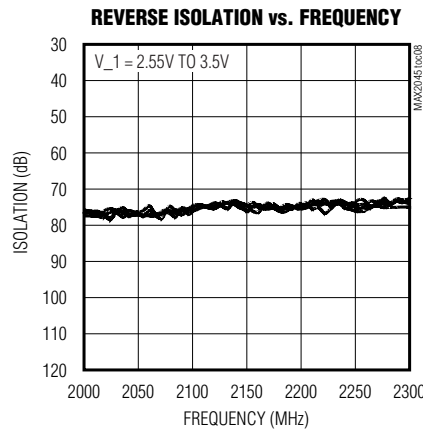
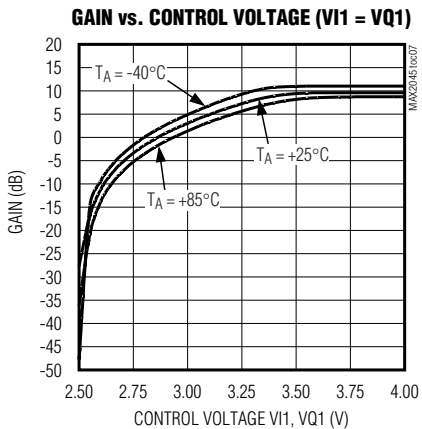
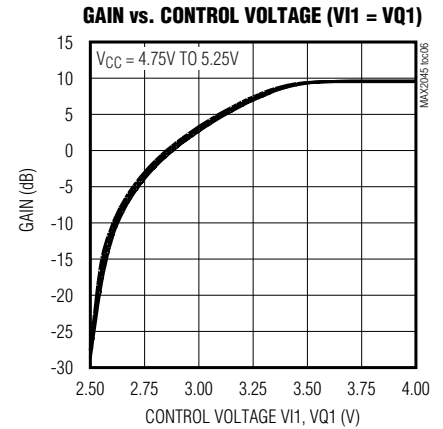
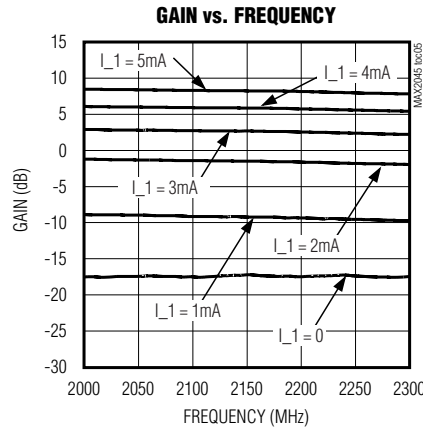
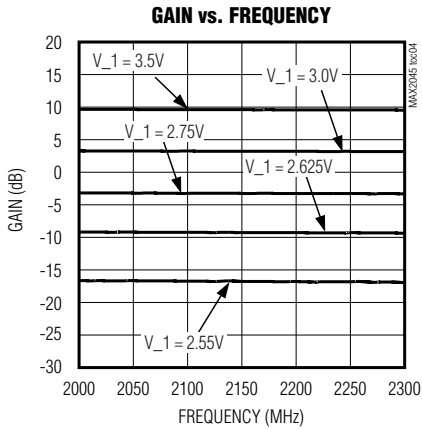
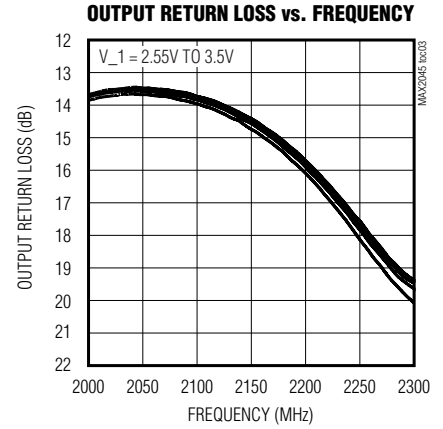
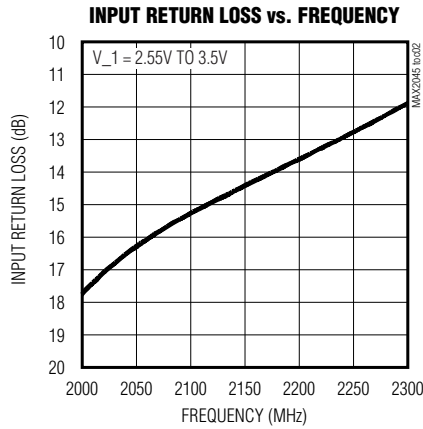
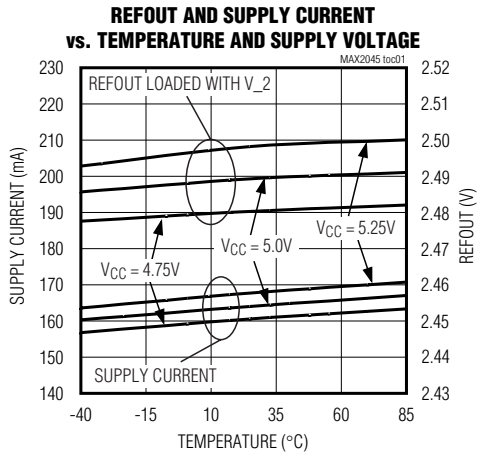

High-Gain Vector Multipliers

Typical Operating Characteristics (MAX2045) (continued)

($V_{CC} = 5V$, $f_{IN} = 2140MHz$, $V_{-1} = VI1$ and $VQ1$, $V_{-2} = VI2$ and $VQ2$, $I_{-1} = II1$ and $IQ1$, $I_{-2} = II2$ and $IQ2$, $VI1 = VQ1 = 3.2V$, $VI2 = VQ2 = REFOUT$, $P_{IN} = -15dBm$ per tone at 1MHz offset (IIP3), and $T_A = +25^\circ C$, unless otherwise noted.)

MAX2045/MAX2046/MAX2047

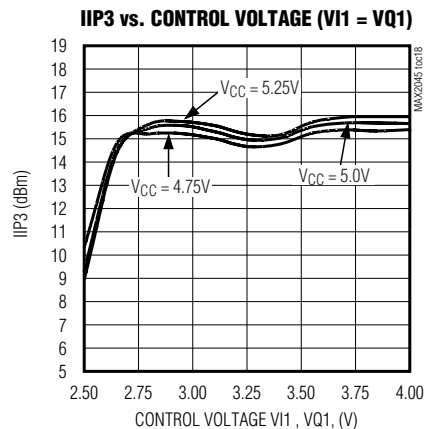
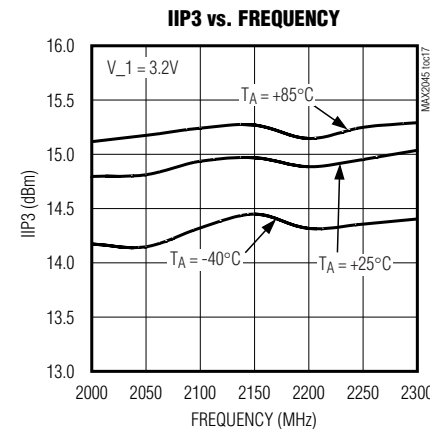
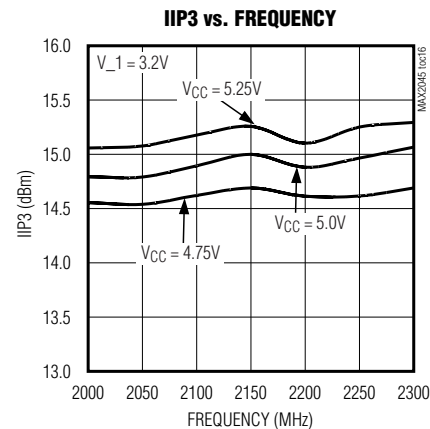
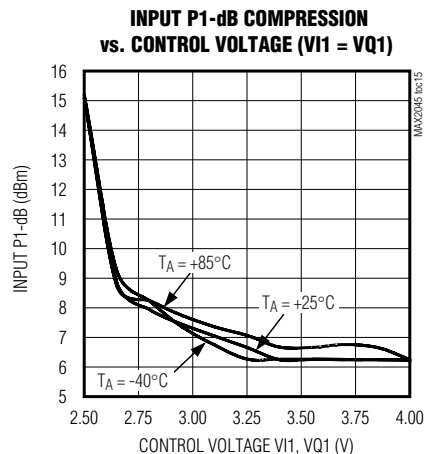
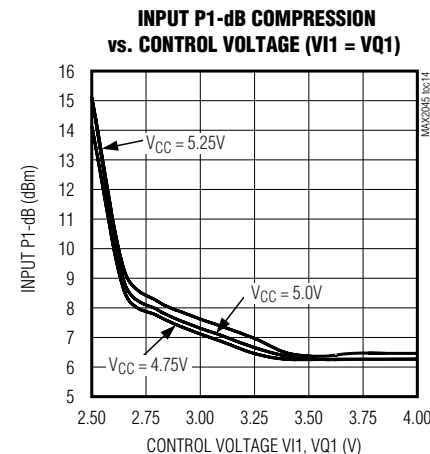
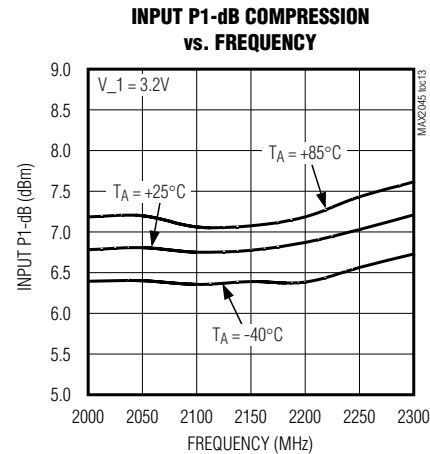
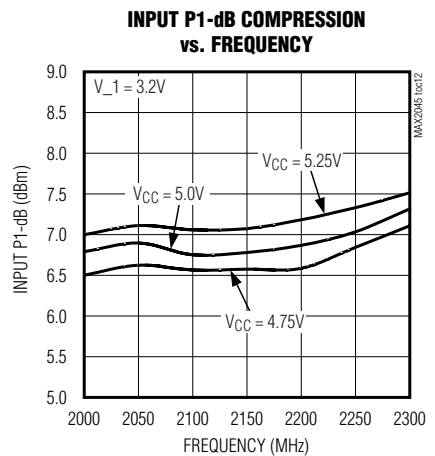
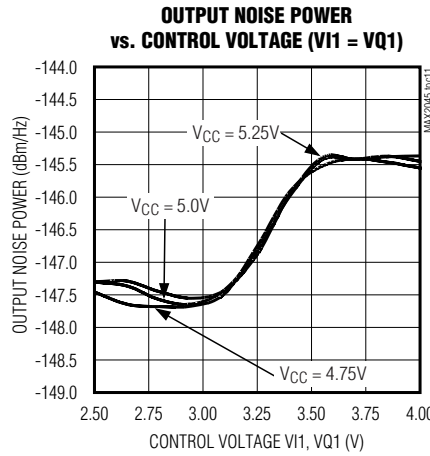
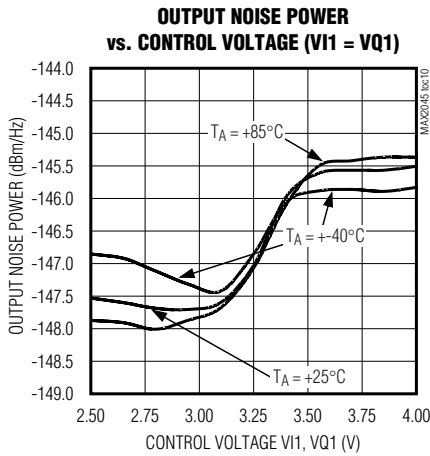

High-Gain Vector Multipliers

Typical Operating Characteristics (MAX2045) (continued)

($V_{CC} = 5V$, $f_{IN} = 2140MHz$, $V_1 = VI1$ and $VQ1$, $V_2 = VI2$ and $VQ2$, $I_1 = II1$ and $IQ1$, $I_2 = II2$ and $IQ2$, $VI1 = VQ1 = 3.2V$, $VI2 = VQ2 = REFOUT$, $P_{IN} = -15dBm$ per tone at 1MHz offset (IIP3), and $T_A = +25^\circ C$, unless otherwise noted.)

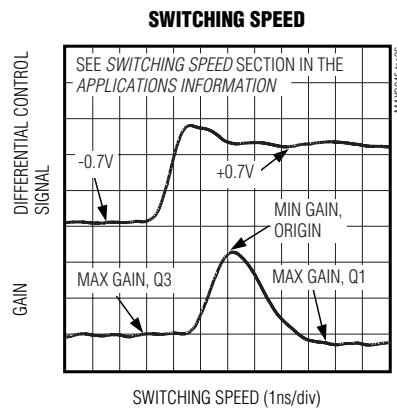
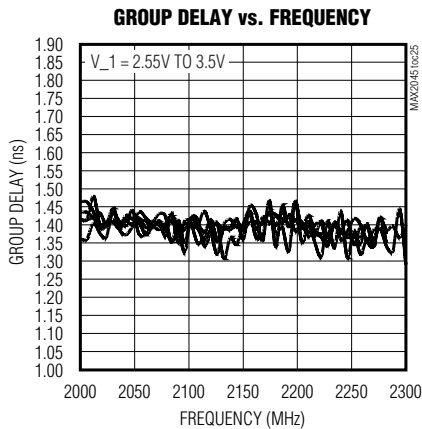
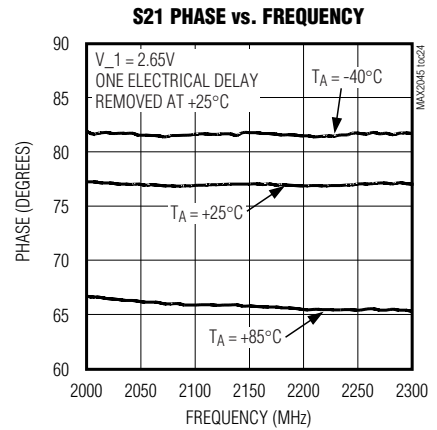
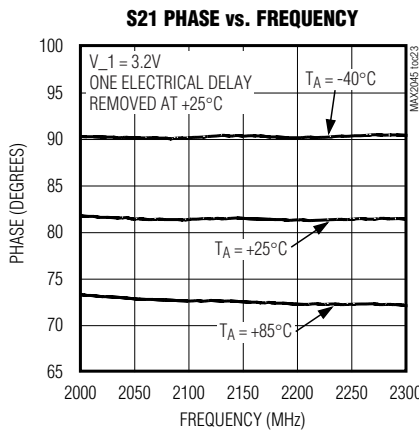
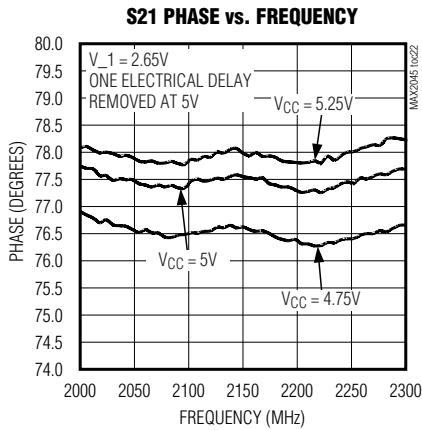
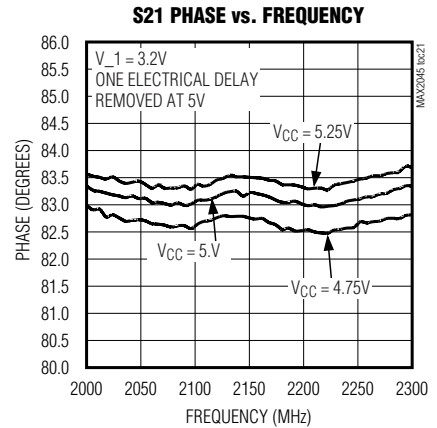
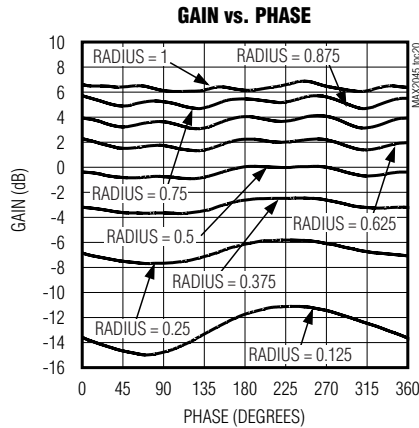
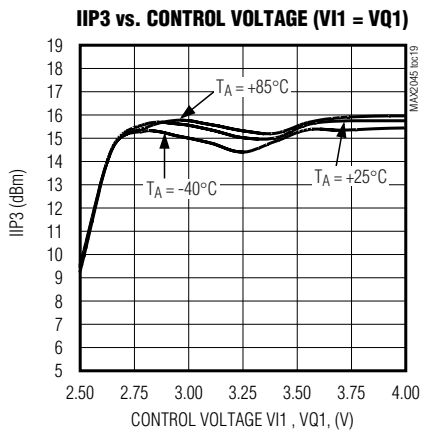

High-Gain Vector Multipliers

Typical Operating Characteristics (MAX2046)

($V_{CC} = 5V$, $f_{IN} = 1900MHz$, $V_1 = V_{I1}$ and V_{Q1} , $V_2 = V_{I2}$ and V_{Q2} , $I_1 = I_{I1}$ and I_{Q1} , $I_2 = I_{I2}$ and I_{Q2} , $V_{I1} = V_{Q1} = 3.2V$, $V_{I2} = V_{Q2} = REFOUT$, $P_{IN} = -15dBm$ per tone at 1MHz offset (IIP3), and $T_A = +25^\circ C$, unless otherwise noted.)

MAX2045/MAX2046/MAX2047

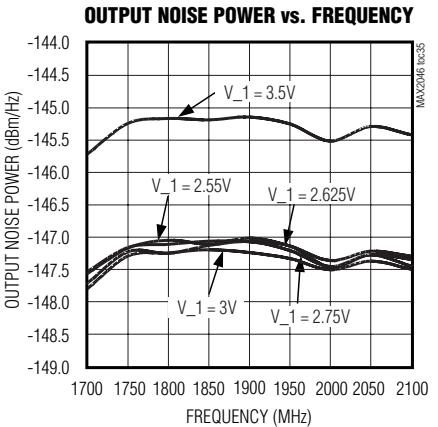
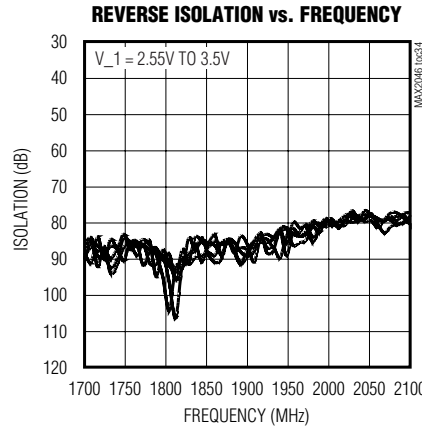
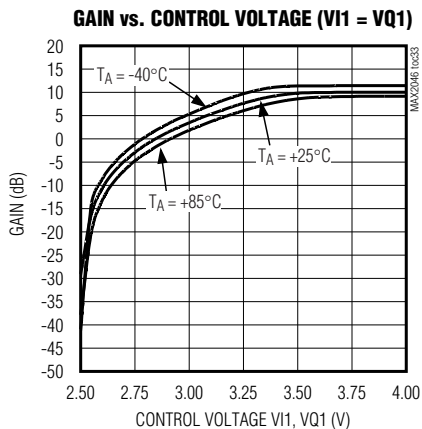
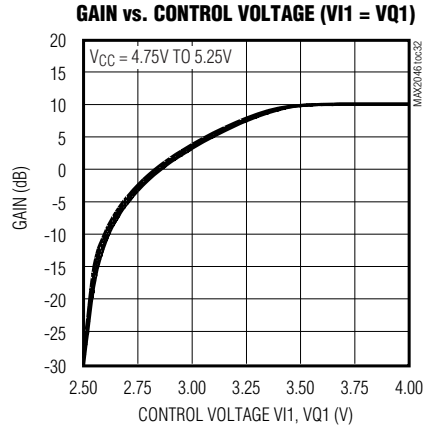
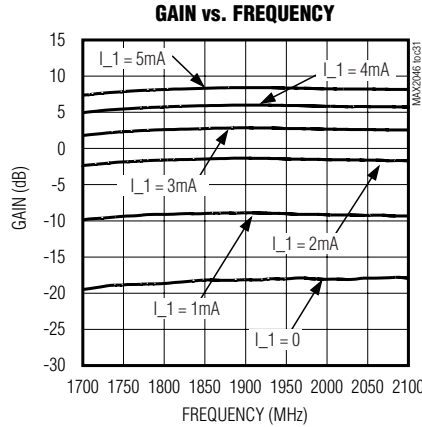
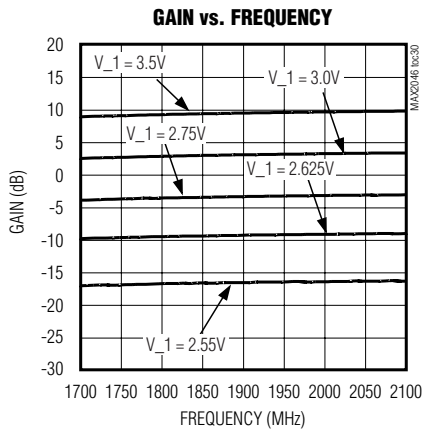
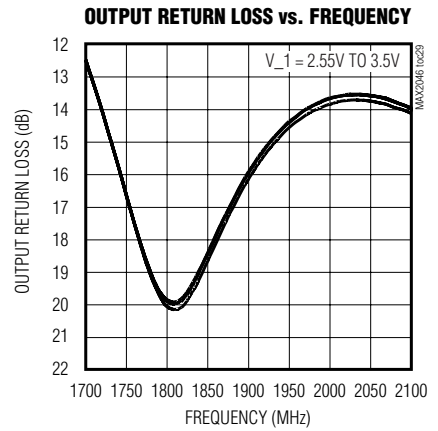
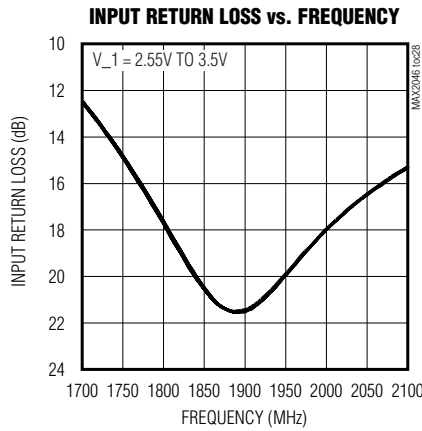
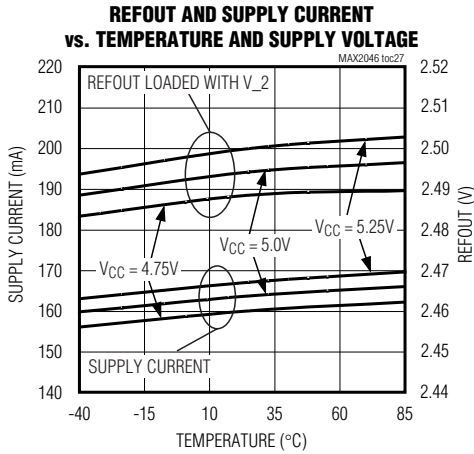

High-Gain Vector Multipliers

Typical Operating Characteristics (MAX2046) (continued)

($V_{CC} = 5V$, $f_{IN} = 1900MHz$, $V_{1} = VI1$ and $VQ1$, $V_{2} = VI2$ and $VQ2$, $I_{1} = II1$ and $IQ1$, $I_{2} = II2$ and $IQ2$, $VI1 = VQ1 = 3.2V$, $VI2 = VQ2 = REFOUT$, $P_{IN} = -15dBm$ per tone at 1MHz offset (IIP3), and $T_A = +25^{\circ}C$, unless otherwise noted.)

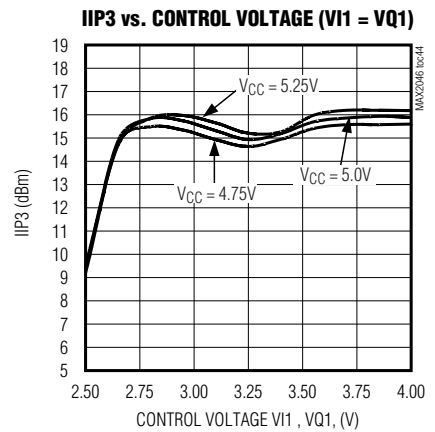
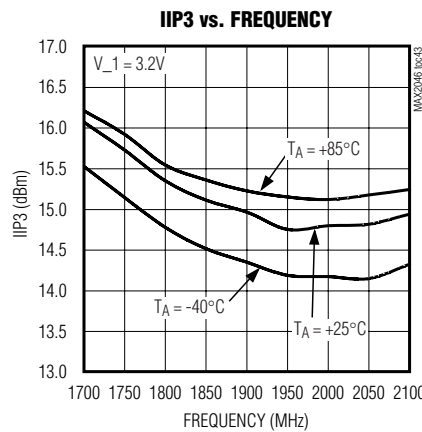
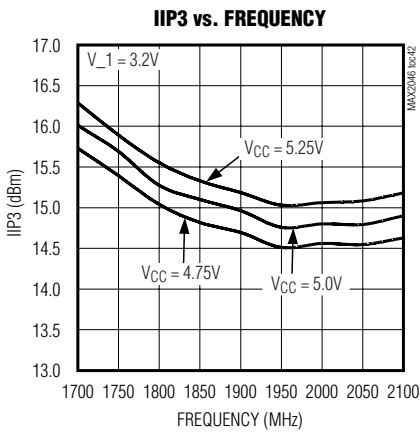
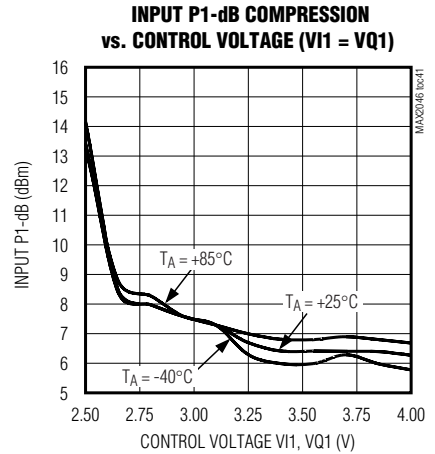
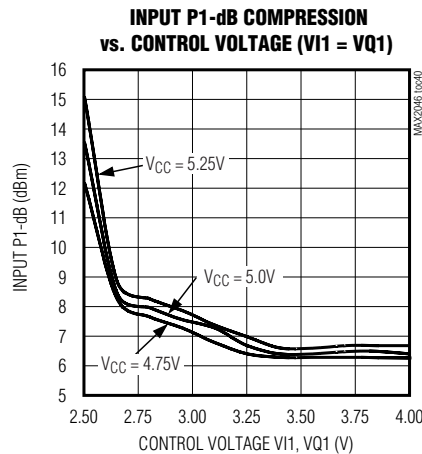
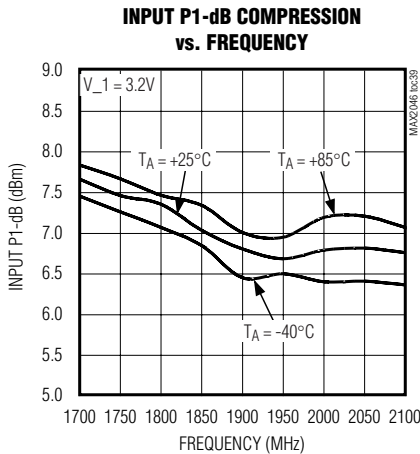
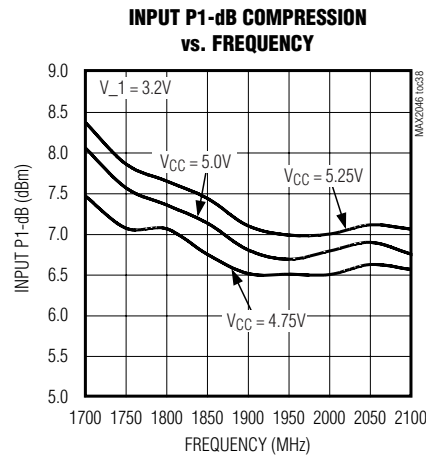
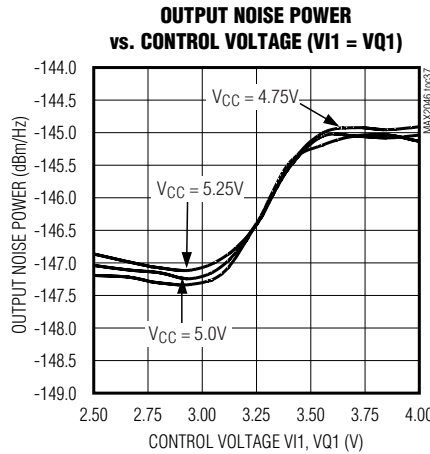
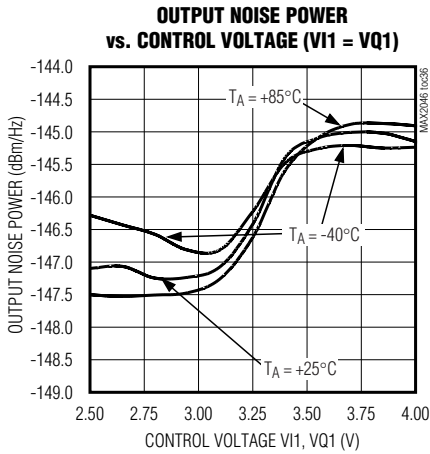

High-Gain Vector Multipliers

Typical Operating Characteristics (MAX2046) (continued)

($V_{CC} = 5V$, $f_{IN} = 1900MHz$, $V_{1} = VI1$ and $VQ1$, $V_{2} = VI2$ and $VQ2$, $I_{1} = II1$ and $IQ1$, $I_{2} = II2$ and $IQ2$, $VI1 = VQ1 = 3.2V$, $VI2 = VQ2 = REFOUT$, $P_{IN} = -15dBm$ per tone at 1MHz offset (IIP3), and $T_A = +25^{\circ}C$, unless otherwise noted.)

MAX2045/MAX2046/MAX2047

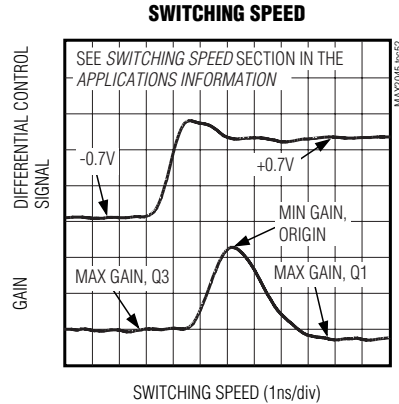
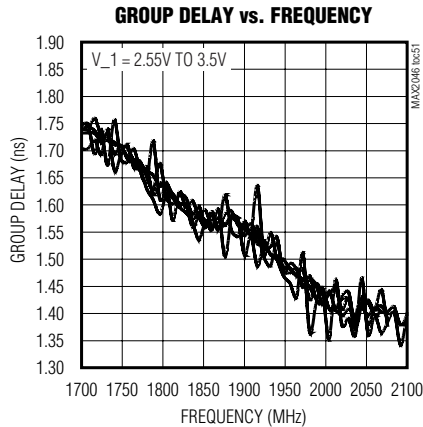
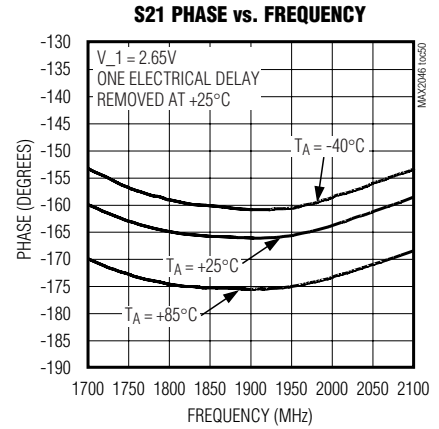
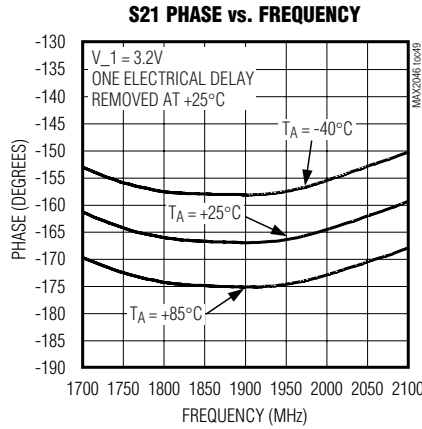
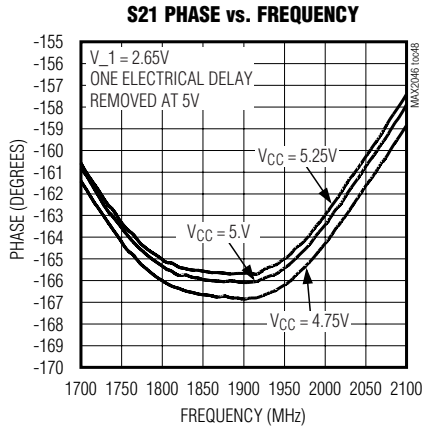
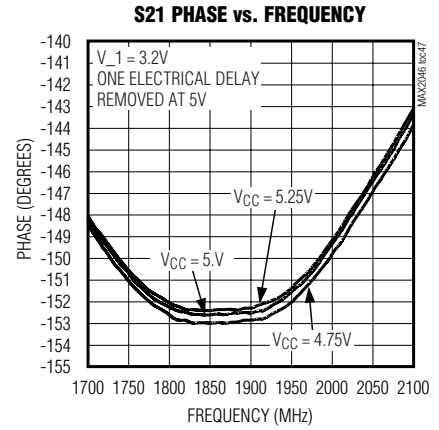
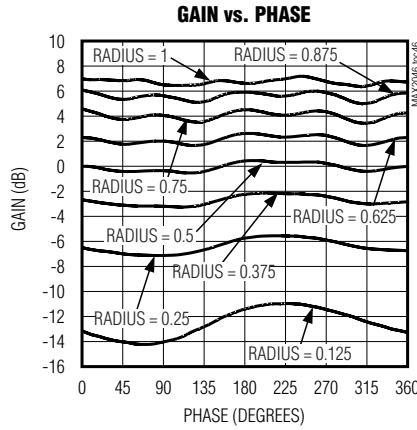
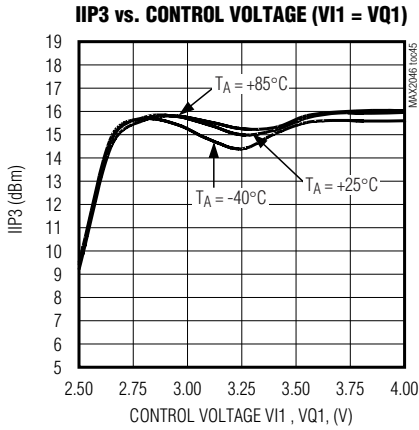

High-Gain Vector Multipliers

Typical Operating Characteristics (MAX2047)

($V_{CC} = 5V$, $f_{IN} = 915MHz$, $V_{_1} = VI1$ and $VQ1$, $V_{_2} = VI2$ and $VQ2$, $I_{_1} = II1$ and $IQ1$, $I_{_2} = II2$ and $IQ2$, $VI1 = VQ1 = 3.2V$, $VI2 = VQ2 = REFOUT$, $P_{IN} = -15dBm$ per tone at 1MHz offset (IIP3), and $T_A = +25^\circ C$, unless otherwise noted.)

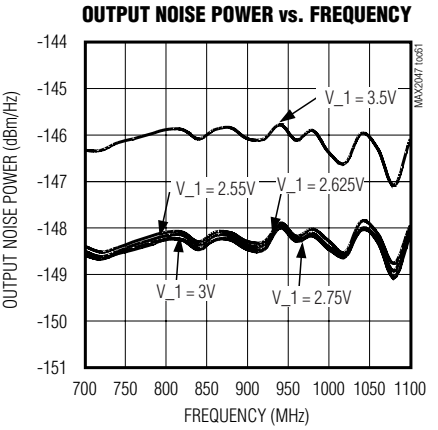
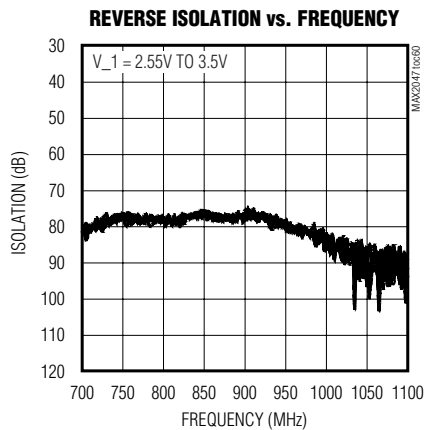
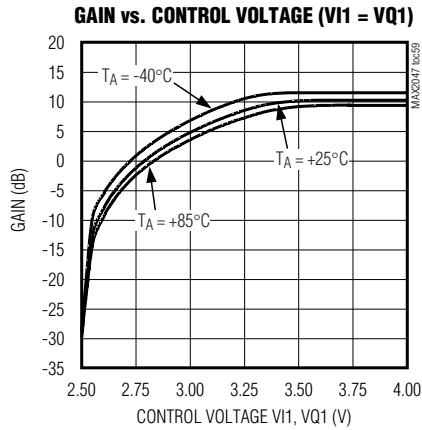
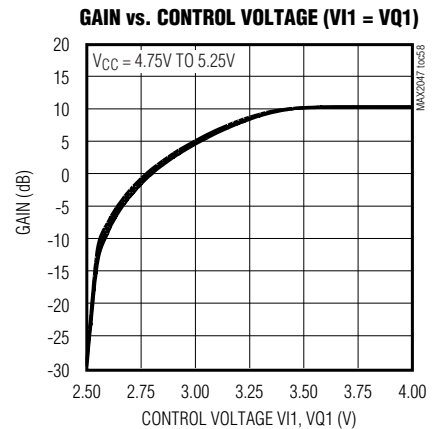
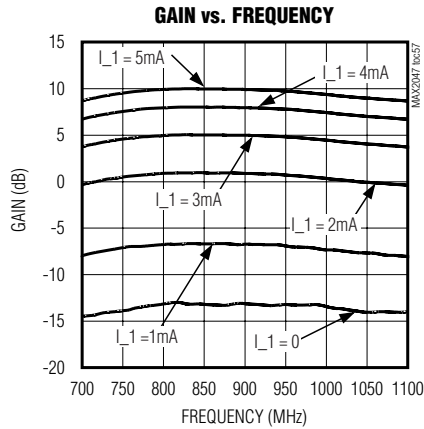
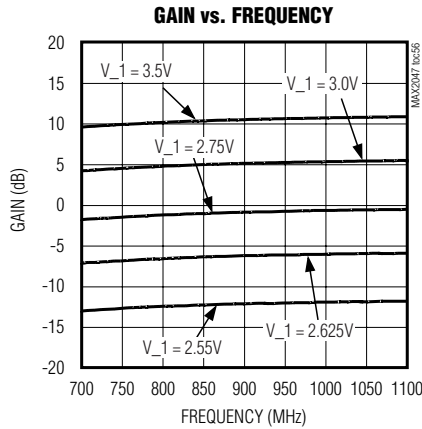
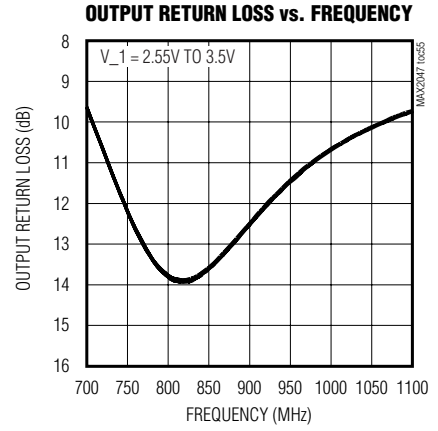
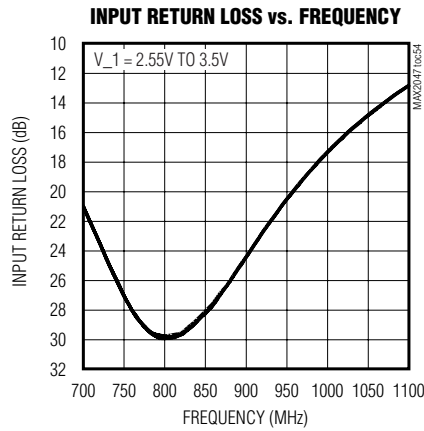
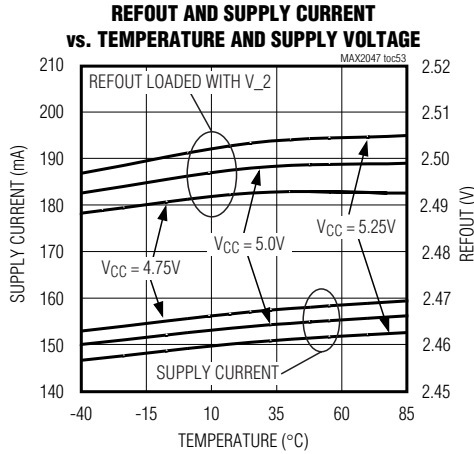

High-Gain Vector Multipliers

MAX2045/MAX2046/MAX2047

Typical Operating Characteristics (MAX2047) (continued)

($V_{CC} = 5V$, $f_{IN} = 915MHz$, $V_{1} = VI1$ and $VQ1$, $V_{2} = VI2$ and $VQ2$, $I_{1} = II1$ and $IQ1$, $I_{2} = II2$ and $IQ2$, $VI1 = VQ1 = 3.2V$, $VI2 = VQ2 = REFOUT$, $P_{IN} = -15dBm$ per tone at 1MHz offset (IIP3), and $T_A = +25^{\circ}C$, unless otherwise noted.)

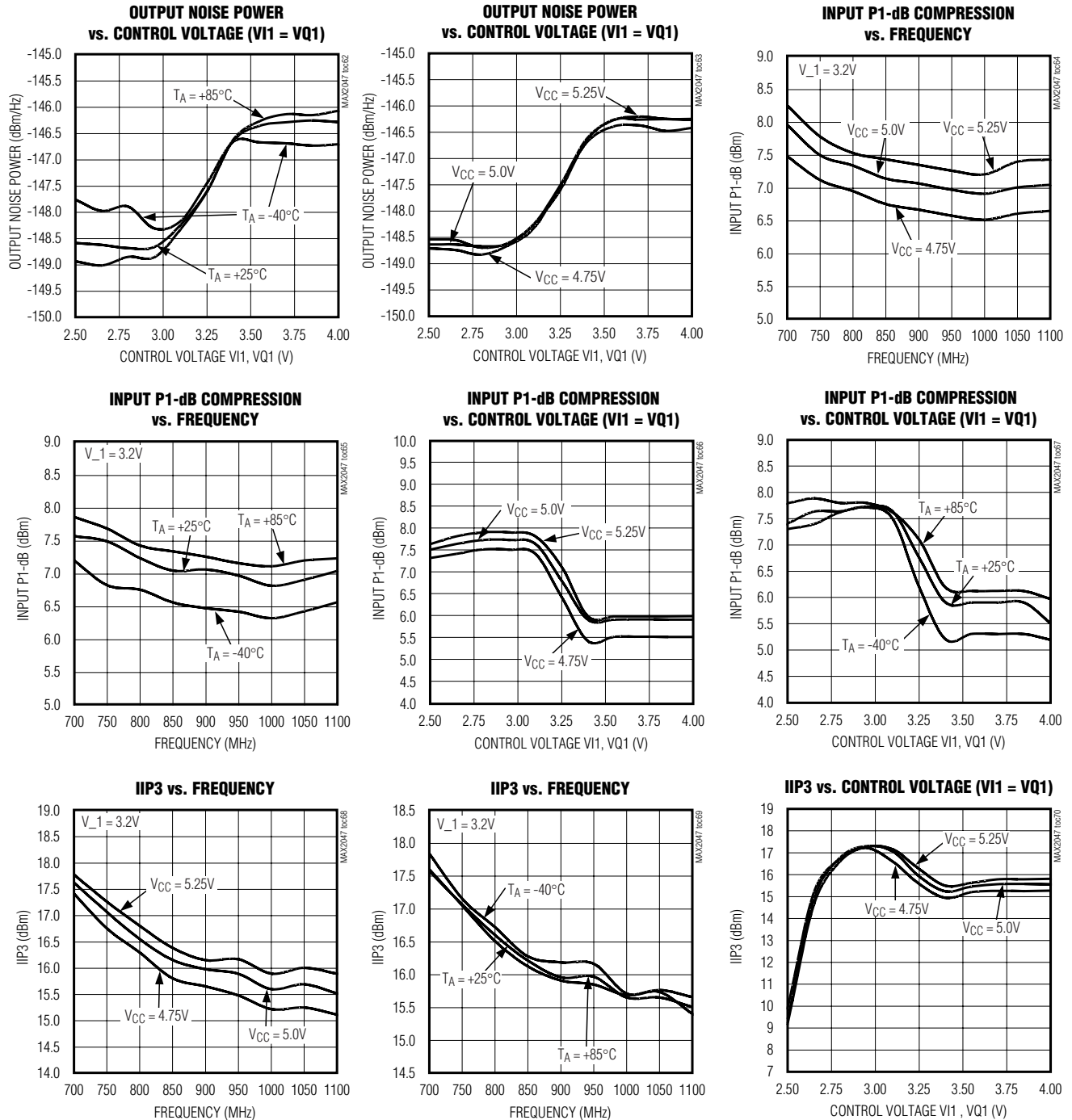

High-Gain Vector Multipliers

Typical Operating Characteristics (MAX2047) (continued)

($V_{CC} = 5V$, $f_{IN} = 915MHz$, $V_{-1} = VI1$ and $VQ1$, $V_{-2} = VI2$ and $VQ2$, $I_{-1} = II1$ and $IQ1$, $I_{-2} = II2$ and $IQ2$, $VI1 = VQ1 = 3.2V$, $VI2 = VQ2 = REFOUT$, $P_{IN} = -15dBm$ per tone at 1MHz offset (IIP3), and $T_A = +25^\circ C$, unless otherwise noted.)

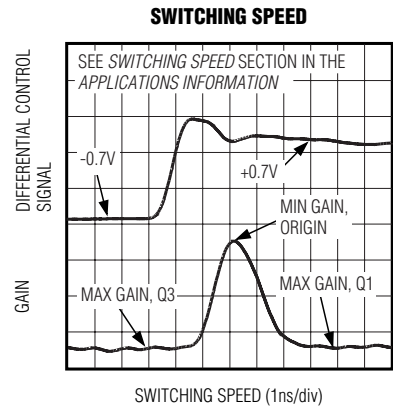
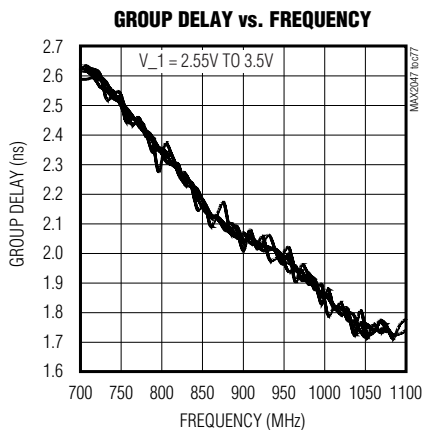
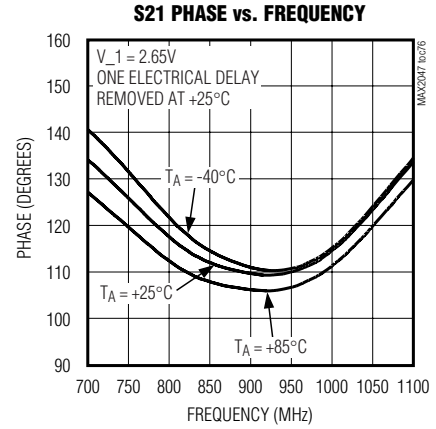
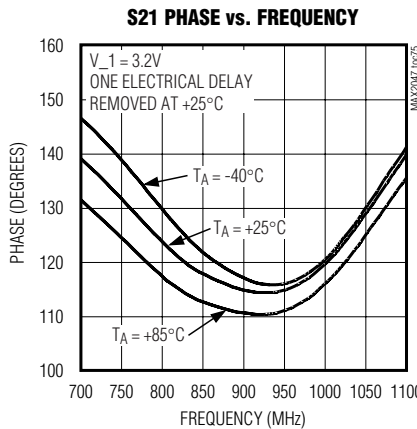
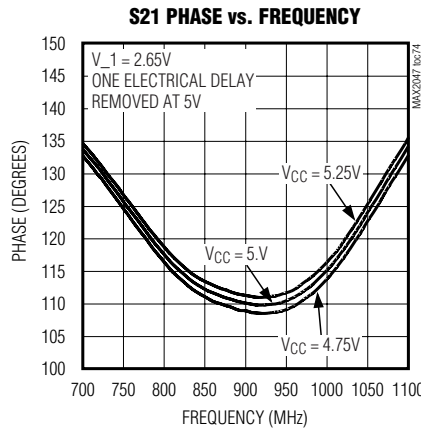
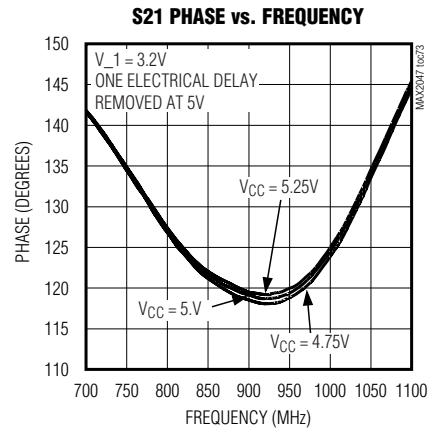
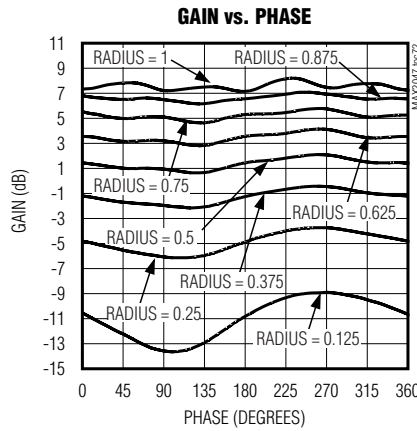
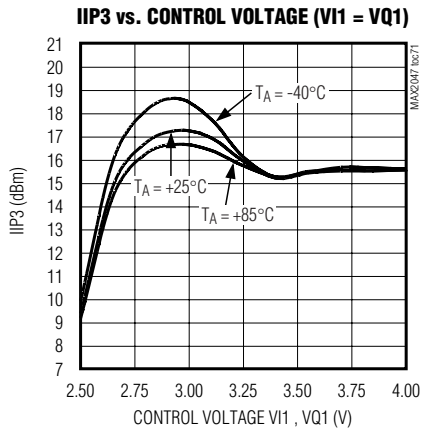

High-Gain Vector Multipliers

MAX2045/MAX2046/MAX2047

Pin Description

PIN	NAME	FUNCTION
1	VI1	Noninverting in-phase voltage-control input. Requires common-mode input voltage (2.5V typ).
2	VI2	Inverting in-phase voltage-control input. Requires common-mode input voltage (2.5V typ).
3	VQ1	Noninverting quadrature voltage-control input. Requires common-mode input voltage (2.5V typ).
4	VQ2	Inverting quadrature voltage-control input. Requires common-mode input voltage (2.5V typ).
5	II1	Noninverting in-phase current-control input. This pin can only sink current. It cannot source current.
6	II2	Inverting in-phase current-control input. This pin can only sink current. It cannot source current.
7	IQ1	Noninverting quadrature current-control input. This pin can only sink current. It cannot source current.
8	IQ2	Inverting quadrature current-control input. This pin can only sink current. It cannot source current.
9	REFOUT	2.5V Reference Output. Integrated reference voltage provides a 2.5V output for single-ended voltage-control applications. For single-ended operation, connect REFOUT to the inverting voltage inputs (VI2, VQ2).
10, 11, 14, 15, 16, 19, 20, 21, 23–27, 30, 31, 32	GND	Ground
12	RFOUT1	Noninverting RF Output
13	RFOUT2	Inverting RF Output
17, 18	VCC	Supply Voltage
22	RBIAS	Bias Setting Resistor. Connect a 280Ω (±1%) resistor from this pin to ground to set the bias current for the IC.
28	RFIN1	Noninverting RF Input
29	RFIN2	Inverting RF Input
Exposed Pad	—	Exposed Pad. Exposed pad on the bottom of the IC should be soldered to the ground plane for proper heat dissipation and RF grounding.

Detailed Description

The MAX2045/MAX2046/MAX2047 provide vector adjustment through the differential I/Q amplifiers. Each part is optimized for separate frequency ranges: MAX2045 for $f_{IN} = 2040\text{MHz}$ to 2240MHz , MAX2046 for $f_{IN} = 1740\text{MHz}$ to 2060MHz , and MAX2047 for $f_{IN} = 790\text{MHz}$ to 1005MHz . All three devices can be interfaced using current- and/or voltage-mode DACs.

The MAX2045/MAX2046/MAX2047 accept differential RF inputs, which are internally phase shifted 90 degrees to produce differential I/Q signals. The phase and magnitude of each signal can then be adjusted using the voltage- and/or current-control inputs. Figure 1 shows a typical operating circuit when using both current- and voltage-mode DACs. When using only one of the two, leave the unused I/Q inputs open.

RF Ports

The RF input and output ports require external matching for optimal performance. See Figures 1 and 2 for appropriate component values. The output ports require external biasing. In Figures 1 and 2, the outputs are biased through the balun (T2). The RF input ports can be driven differentially or single ended (Figures 1, 2) using a balun. The matching values for the MAX2045/MAX2046 were set to be the same during characterization. An optimized set of values can be found in the *MAX2045/MAX2046/MAX2047 Evaluation Kit* data sheet.

I/Q Inputs

The control amplifiers convert a voltage, current, or voltage and current input to a predistorted voltage that controls the multipliers. The I/Q voltage-mode inputs can be operated differentially (Figure 1) or single ended (Figure 2). A 2.5V reference is provided on-chip for single-ended operation.

High-Gain Vector Multipliers

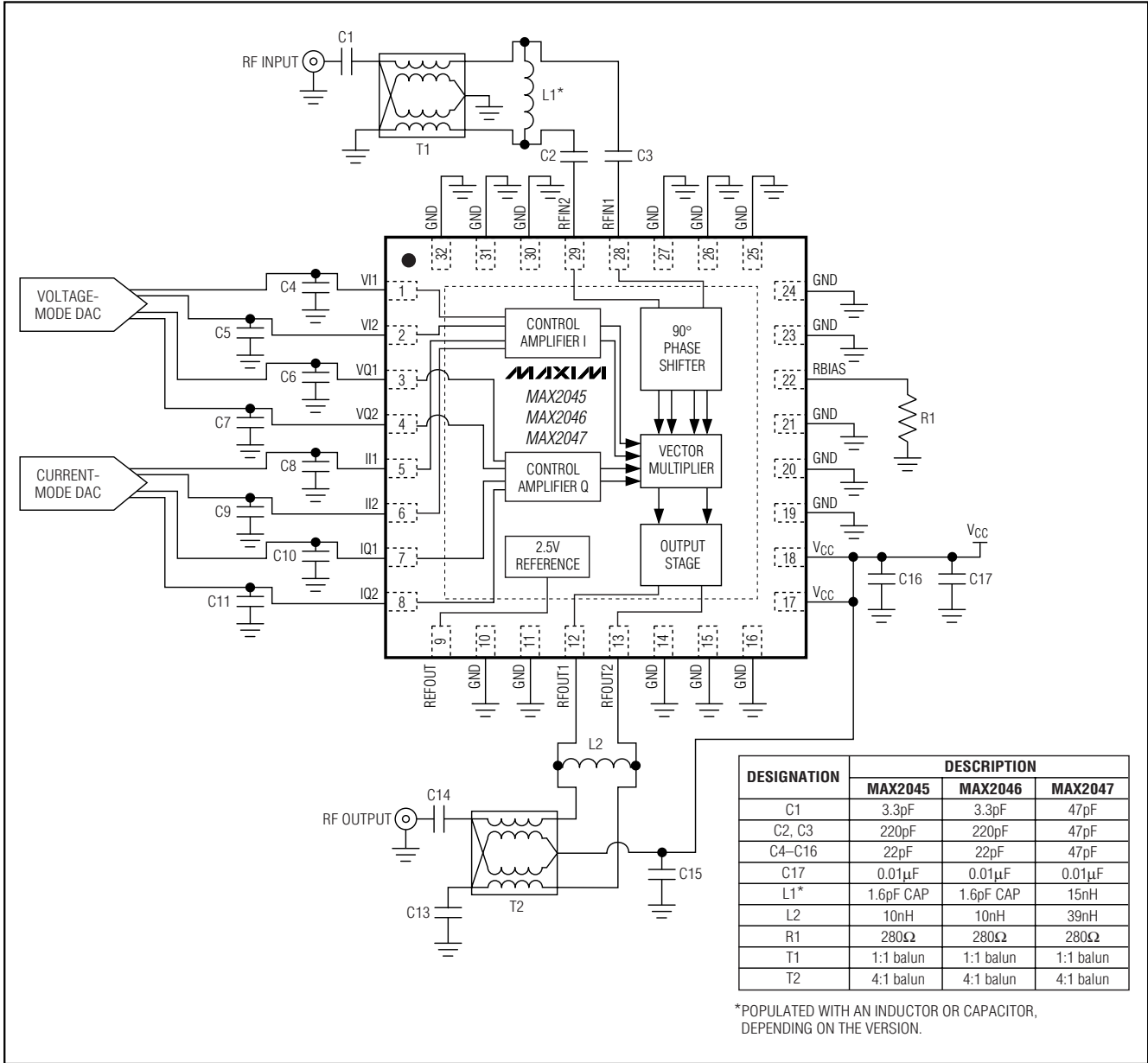

Figure 1. Typical Operating Circuit Using Differential Current- and Voltage-Mode DACs

High-Gain Vector Multipliers

MAX2045/MAX2046/MAX2047

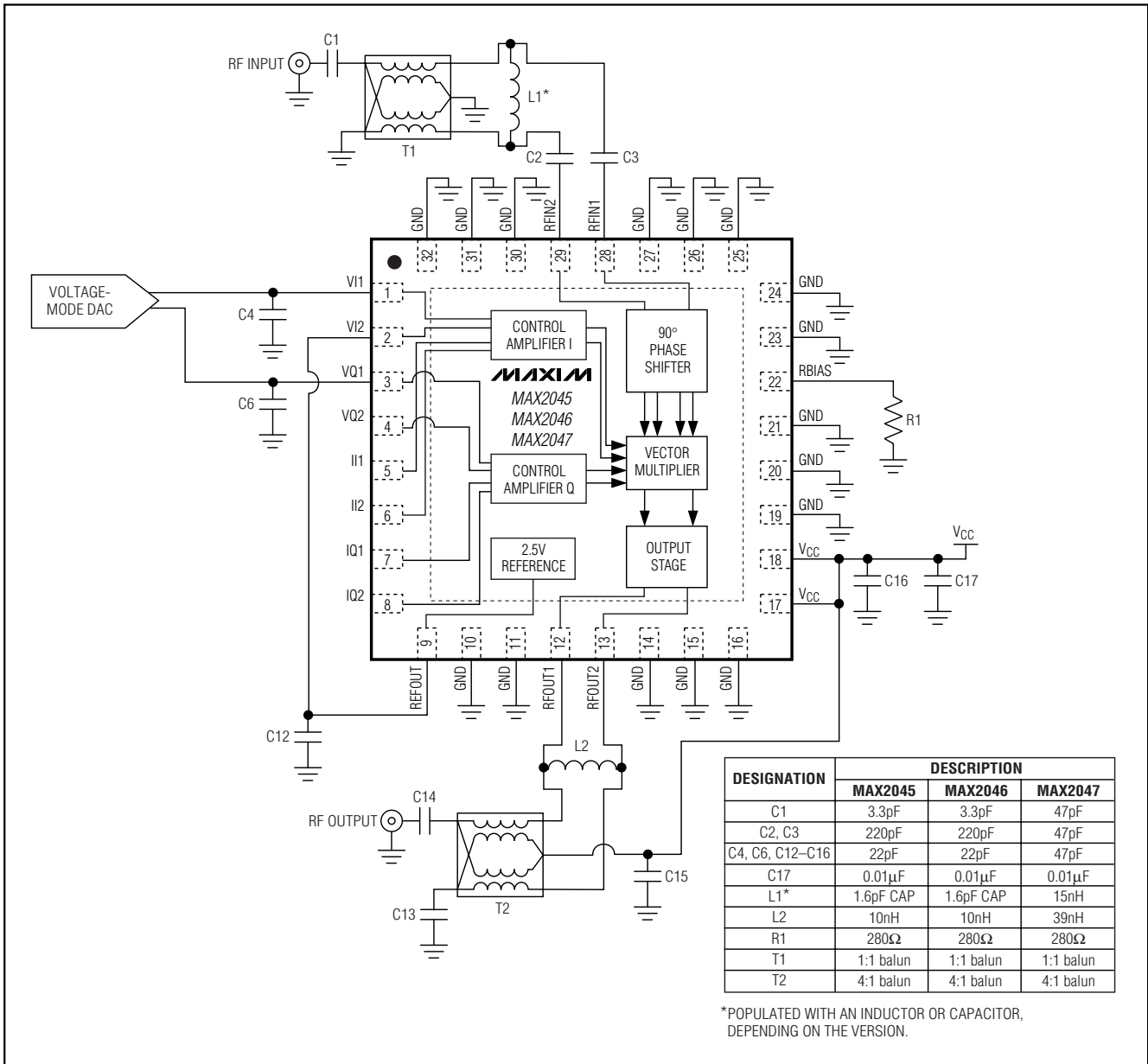

Figure 2. Typical Operating Circuit Using Single-Ended Voltage Mode DACs

High-Gain Vector Multipliers

On-Chip Reference Voltage

An on-chip, 2.5V reference voltage is provided for single-ended control mode. Connect REFOUT to VI2 and VQ2 to provide a stable reference voltage. The equivalent output resistance of the REFOUT pin is approximately 80Ω . REFOUT is capable of sourcing 1mA of current, with $<10\text{mV}$ drop-in voltage.

Applications Information

RF Single-Ended Operation

The RF input impedance is 50Ω differential into the IC. An external low-loss 1:1 balun can be used for single-ended operation. The RF output impedance is 300Ω differential into the IC. An external low-loss 4:1 balun transforms this impedance down to 50Ω single-ended output (Figures 1 and 2).

Bias Resistor

The bias resistor value (280Ω) was optimized during characterization at the factory. This value should not be adjusted. If the 280Ω ($\pm 1\%$) resistor is not readily available, substitute a standard 280Ω ($\pm 5\%$) resistor, which may result in more current part-to-part variation.

Switching Speed

The control inputs have a typical 3dB BW of 260MHz. This BW provides the device with the ability to adjust gain/phase at a very rapid rate. The Switching Speed graphs in the *Typical Operating Characteristics* try to capture the control ability of the vector multipliers. These measurements were done by first removing capacitors C4–C7 to reduce driving capacitance.

The test for gathering the curves shown, uses a MAX9602 differential output comparator to drive VI1, VI2, VQ1, and VQ2. One output of the comparator is connected to VI1/VQ1, while the other is connected to VI2/VQ2. The input to the vector multiplier is driven by an RF source and the output is connected to a crystal detector. The switching signal produces a waveform that results in a $\pm 0.7\text{V}$ differential input signal to the vector multiplier.

This signal switches the signal from quadrant 3 (-0.7V case), through the origin (maximum attenuation), and into quadrant 1 ($+0.7\text{V}$ case). The before-and-after amplitude (S21) stays about the same between the two quadrants but the phase changes by 180° .

As the differential control signal approaches zero, the gain approaches its minimum value. This appears as the null in the *Typical Operating Characteristics*. The measurement results include rise-time errors from the crystal detector (specified by manufacturing to be approximately 8ns to 12ns), the comparator (approximately 500ps), and the 500MHz BW oscilloscope (used to measure the control and detector signals).

Layout Issues

A properly designed PC board is an essential part of any RF/microwave circuit. Keep RF signal lines as short as possible to reduce losses, radiation, and inductance. For best performance, route the ground pin traces directly to the exposed pad underneath the package. This pad should be connected to the ground plane of the board by using multiple vias under the device to provide the best RF/thermal conduction path. Solder the exposed pad on the bottom of the device package to a PC board exposed pad.

The MAX2045/MAX2046/MAX2047 Evaluation Kit can be used as a reference for board layout. Gerber files are available upon request at www.maxim-ic.com.

Power-Supply Bypassing

Proper voltage-supply bypassing is essential for high-frequency circuit stability. Bypass the VCC pins with 10nF and 22pF (47pF for the MAX2047) capacitors. Connect the high-frequency capacitor as close to the device as possible.

Exposed Paddle RF Thermal Considerations

The EP of the 32-lead thin QFN package provides a low thermal-resistance path to the die. It is important that the PC board on which the IC is mounted be designed to conduct heat from this contact. In addition, the EP provides a low-inductance RF ground path for the device.

It is recommended that the EP be soldered to a ground plane on the PC board, either directly or through an array of plated via holes.

Soldering the pad to ground is also critical for proper heat dissipation. Use a solid ground plane wherever possible.

Chip Information

TRANSISTOR COUNT: 599

High-Gain Vector Multipliers

Package Information

(The package drawing(s) in this data sheet may not reflect the most current specifications. For the latest package outline information, go to www.maxim-ic.com/packages.)

MAX2045/MAX2046/MAX2047

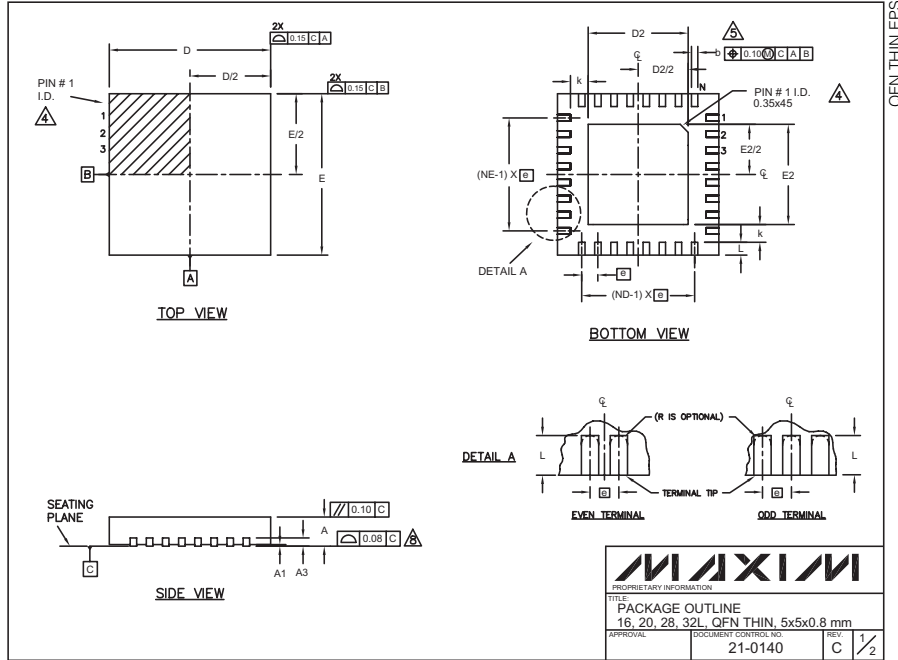

PKG. SYMBOL	16L 5x5				20L 5x5				28L 5x5				32L 5x5			
	MIN.	NOM.	MAX.		MIN.	NOM.	MAX.		MIN.	NOM.	MAX.		MIN.	NOM.	MAX.	
A	0.70	0.75	0.80		0.70	0.75	0.80		0.70	0.75	0.80		0.70	0.75	0.80	
A1	0	0.02	0.05	0	0.02	0.05	0	0.02	0.05	0	0.02	0.05	0	0.02	0.05	
A3	0.20 REF.				0.20 REF.				0.20 REF.				0.20 REF.			
b	0.25	0.30	0.35	0.25	0.30	0.35	0.25	0.30	0.35	0.25	0.30	0.25	0.30	0.25	0.30	
D	4.90	5.00	5.10	4.90	5.00	5.10	4.90	5.00	5.10	4.90	5.00	5.10	4.90	5.00	5.10	
E	4.90	5.00	5.10	4.90	5.00	5.10	4.90	5.00	5.10	4.90	5.00	5.10	4.90	5.00	5.10	
e	0.80 BSC.				0.65 BSC.				0.50 BSC.				0.50 BSC.			
k	0.25	-	-	0.25	-	-	0.25	-	-	0.25	-	-	0.25	-	-	
L	0.45	0.55	0.65	0.45	0.55	0.65	0.45	0.55	0.65	0.30	0.40	0.50				
N	16				20				28				32			
ND	4				5				7				8			
NE	4				5				7				8			
JEDEC	WHHB				WHHC				WHHD-1				WHHD-2			

PKG. CODES	D2			E2		
	MIN.	NOM.	MAX.	MIN.	NOM.	MAX.
T1855-1	3.00	3.10	3.20	3.00	3.10	3.20
T2055-2	3.00	3.10	3.20	3.00	3.10	3.20
T2855-1	3.15	3.25	3.35	3.15	3.25	3.35
T2855-2	2.80	2.70	2.80	2.80	2.80	2.80
T3255-2	3.00	3.10	3.20	3.00	3.10	3.20

NOTES:

- DIMENSIONING & TOLERANCING CONFORM TO ASME Y14.5M-1994.
- ALL DIMENSIONS ARE IN MILLIMETERS. ANGLES ARE IN DEGREES.
- N IS THE TOTAL NUMBER OF TERMINALS.
- THE TERMINAL #1 IDENTIFIER AND TERMINAL NUMBERING CONVENTION SHALL CONFORM TO JESD 95-1 SPP-012. DETAILS OF TERMINAL #1 IDENTIFIER ARE OPTIONAL, BUT MUST BE LOCATED WITHIN THE ZONE INDICATED. THE TERMINAL #1 IDENTIFIER MAY BE EITHER A MOLD OR MARKED FEATURE.
- DIMENSION b APPLIES TO METALLIZED TERMINAL AND IS MEASURED BETWEEN 0.25 mm AND 0.30 mm FROM TERMINAL TIP.
- ND AND NE REFER TO THE NUMBER OF TERMINALS ON EACH D AND E SIDE RESPECTIVELY.
- DEPOPULATION IS POSSIBLE IN A SYMMETRICAL FASHION.
- COPLANARITY APPLIES TO THE EXPOSED HEAT SINK SLUG AS WELL AS THE TERMINALS.
- DRAWING CONFORMS TO JEDEC MO220.
- WARPAGE SHALL NOT EXCEED 0.10 mm.



Maxim cannot assume responsibility for use of any circuitry other than circuitry entirely embodied in a Maxim product. No circuit patent licenses are implied. Maxim reserves the right to change the circuitry and specifications without notice at any time.

Maxim Integrated Products, 120 San Gabriel Drive, Sunnyvale, CA 94086 408-737-7600 21



Стандарт Электрон Связь

Мы молодая и активно развивающаяся компания в области поставок электронных компонентов. Мы поставляем электронные компоненты отечественного и импортного производства напрямую от производителей и с крупнейших складов мира.

Благодаря сотрудничеству с мировыми поставщиками мы осуществляем комплексные и плановые поставки широчайшего спектра электронных компонентов.

Собственная эффективная логистика и склад в обеспечивает надежную поставку продукции в точно указанные сроки по всей России.

Мы осуществляем техническую поддержку нашим клиентам и предпродажную проверку качества продукции. На все поставляемые продукты мы предоставляем гарантию .

Осуществляем поставки продукции под контролем ВП МО РФ на предприятия военно-промышленного комплекса России , а также работаем в рамках 275 ФЗ с открытием отдельных счетов в уполномоченном банке. Система менеджмента качества компании соответствует требованиям ГОСТ ISO 9001.

Минимальные сроки поставки, гибкие цены, неограниченный ассортимент и индивидуальный подход к клиентам являются основой для выстраивания долгосрочного и эффективного сотрудничества с предприятиями радиоэлектронной промышленности, предприятиями ВПК и научно-исследовательскими институтами России.

С нами вы становитесь еще успешнее!

Наши контакты:

Телефон: +7 812 627 14 35

Электронная почта: sales@st-electron.ru

Адрес: 198099, Санкт-Петербург,
Промышленная ул, дом № 19, литера Н,
помещение 100-Н Офис 331