

NPN SILICON PLANAR EPITAXIAL TRANSISTORS

**CMBT8098
CMBT8099**

**SOT-23
Formed SMD Package**

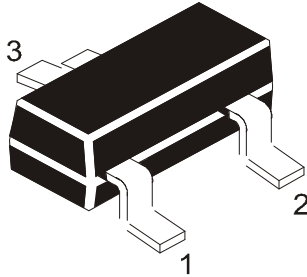

PIN CONFIGURATION (NPN)

- 1 = BASE
- 2 = EMITTER
- 3 = COLLECTOR

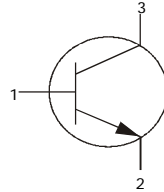

Marking

CMBT8098- KA

CMBT8099- KB

ABSOLUTE MAXIMUM RATING

DESCRIPTION	SYMBOL	CMBT8098	CMBT8099	UNITS
Collector Base Voltage	V_{CBO}	60	80	V
Collector Emitter Voltage	V_{CEO}	60	80	V
Emitter Base Voltage	V_{EBO}	6.0		V
Collector Current Continuous	I_C	500		mA
Power Dissipation $T_a=25^\circ\text{C}$ (Note1)	P_D	225		mW
Derate Above 25°C		1.8		mW/°C
Power Dissipation $T_a=25^\circ\text{C}$ (Note2)	P_D	300		mW
Derate Above 25°C		2.4		mW/°C
Operating And Storage Junction Temperature Range	T_j, T_{stg}	- 55 to +150		°C

Thermal Resistance

Junction to Ambient (Note1)	$R_{th(j-a)}$	556	°C/W
Junction to Ambient (Note2)	$R_{th(j-a)}$	417	°C/W

Note (1) FR-5 Board=25.4 x 19.05 x 1.58 mm (1.0 x 0.75 x 0.062 inches.)

Note (2) Alumina Substrate=10.16 x 7.62 x 0.61 mm (0.4 x 0.3 x 0.024 inches.) 99.5% alumina.

ELECTRICAL CHARACTERISTICS ($T_a=25^\circ\text{C}$ unless specified otherwise)

DESCRIPTION	SYMBOL	TEST CONDITION	MIN	TYP	MAX	UNITS
Collector Base Voltage	V_{CBO}	$I_C=100\mu\text{A}, I_E=0$	CMBT8098	60		V
			CMBT8099	80		V
Collector Emitter Voltage	V_{CEO}	$I_C=10\text{mA}, I_B=0$	CMBT8098	60		V
			CMBT8099	80		V
Emitter Base Voltage	V_{EBO}	$I_E=10\mu\text{A}, I_C=0$	6.0			V
Collector Cut Off Current	I_{CES}	$V_{CE}=60\text{V}, I_B=0$			0.1	μA
Collector Cut Off Current	I_{CBO}	$V_{CB}=60\text{V}, I_E=0$	CMBT8098		0.1	μA
			CMBT8099		0.1	μA
Emitter Cut Off Current	I_{EBO}	$V_{EB}=6\text{V}, I_C=0$			0.1	μA

NPN SILICON PLANAR EPITAXIAL TRANSISTORS

CMBT8098
CMBT8099

SOT-23
Formed SMD Package

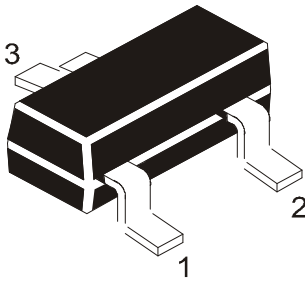

PIN CONFIGURATION (NPN)

- 1 = BASE
- 2 = EMITTER
- 3 = COLLECTOR

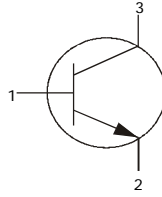

ELECTRICAL CHARACTERISTICS (T_a=25° C unless specified otherwise)

DESCRIPTION	SYMBOL	TEST CONDITION	MIN	TYP	MAX	UNITS
DC Current Gain	h_{FE}^*	$I_C=1mA, V_{CE}=5V$	100		300	
		$I_C=10mA, V_{CE}=5V$	100			
		$I_C=100mA, V_{CE}=5V$	75			
Collector Emitter Saturation Voltage	$V_{CE(sat)}^*$	$I_C=100mA, I_B=5mA$			0.4	V
		$I_C=100mA, I_B=10mA$			0.3	V
Base Emitter On Voltage	$V_{BE(on)}^*$	CMBT8098 $I_C=1mA, V_{CE}=5V$	0.5		0.7	V
		CMBT8099 $I_C=10mA, V_{CE}=5V$	0.6		0.8	V

Small Signal Characteristics

Current Gain Bandwidth Product	f_T	$I_C=10mA, V_{CE}=5V, f=100MHz$	150			MHz
Output Capacitance	C_{obo}	$I_E=0, V_{CB}=5V, f=1MHz$			6.0	pF
Input Capacitance	C_{ibo}	$I_C=0, V_{EB}=0.5V, f=1MHz$			25	pF

*Pulse Test: Pulse Width $\leq 300\mu s$, Duty Cycle $\leq 2\%$

SOT-23 Formed SMD Package

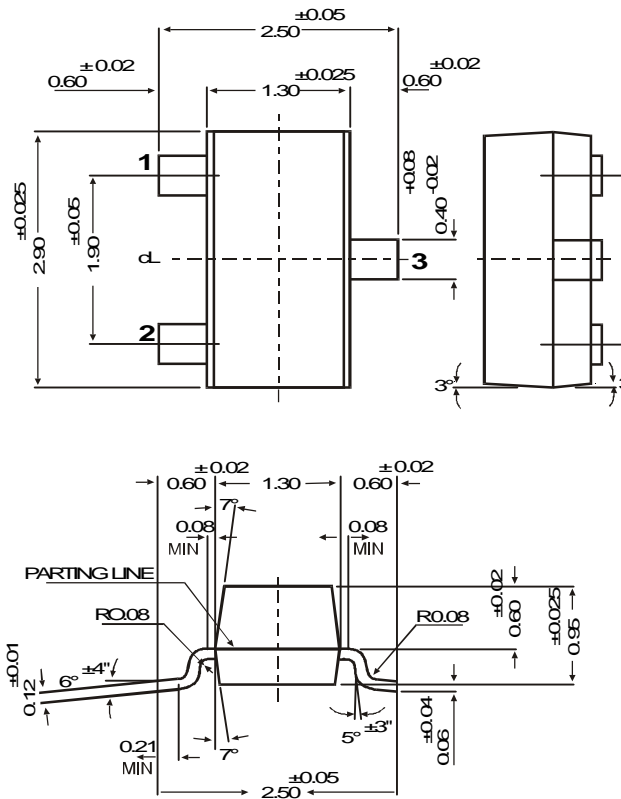

**SOT-23 Package Reel Information
Reel Specifications for W Packing (13") and 7"**

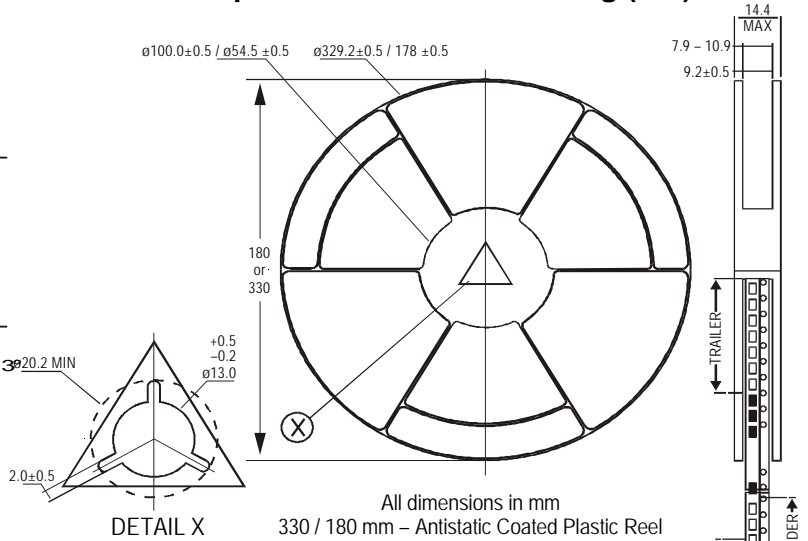

NOTES:

1. The bandolier of 330 mm reel contains at least 10,000 devices.
2. The bandolier of 180 mm reel contains at least 3,000 devices.
3. No more than 0.5% missing devices / reel. 50 empty compartments for 330 mm reel. 15 empty compartments for 180 mm reel.
4. Three consecutive empty places might be found provided this gap is followed by 6 consecutive devices.
5. The carrier tape (leader) starts with at least 75 empty positions (equivalent to 330 mm). In order to fix the carrier tape a self adhesive tape of 20 to 50 mm is applied. At the end of the bandolier at least 40 empty positions (equivalent to 160 mm) are there.

All dimensions in mm

8mm Tape Size of Reel	8mm Tape Size of Reel
330 mm (13")	180 mm (7")
No. of Devices 10,000 Pcs	No. of Devices 3,000 Pcs

Tape Specification for SOT-23 Surface Mount Device

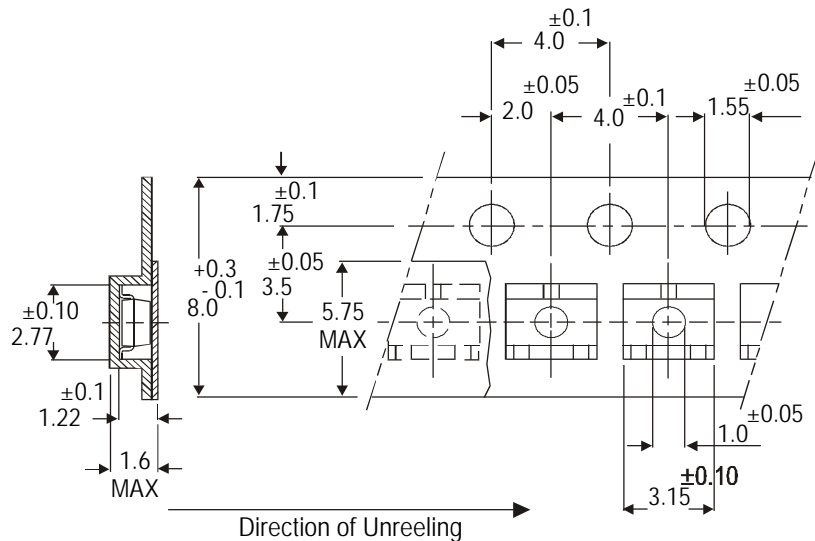

All dimensions in mm

Packing Detail

PACKAGE	STANDARD PACK		INNER CARTON BOX		OUTER CARTON BOX		
	Details	Net Weight/Qty	Size	Qty	Size	Qty	Gr Wt
SOT-23 T&R	3K/feel	136 gm/3K pcs	3" x 7.5" x 7.5"	12 K	17" x 15" x 13.5"	192 K	12 kgs
	10K/feel	415 gm/10K pcs	9" x 9" x 9"	51 K	19" x 19" x 19"	408 K	28 kgs
			13" x 13" x 0.5"	10 K	17" x 15" x 13.5"	300 K	16 kgs

Disclaimer

The product information and the selection guides facilitate selection of the CDIL's Discrete Semiconductor Device(s) best suited for application in your product(s) as per your requirement. It is recommended that you completely review our Data Sheet(s) so as to confirm that the Device(s) meet functionality parameters for your application. The information furnished on the CDIL Web Site/CD are believed to be accurate and reliable. CDIL however, does not assume responsibility for inaccuracies or incomplete information. Furthermore, CDIL does not assume liability whatsoever, arising out of the application or use of any CDIL product; neither does it convey any license under its patent rights nor rights of others. These products are not designed for use in life saving/support appliances or systems. CDIL customers selling these products (either as individual Discrete Semiconductor Devices or incorporated in their end products), in any life saving/support appliances or systems or applications do so at their own risk and CDIL will not be responsible for any damages resulting from such sale(s).

CDIL strives for continuous improvement and reserves the right to change the specifications of its products without prior notice.



CDIL is a registered Trademark of
Continental Device India Limited

C-120 Naraina Industrial Area, New Delhi 110 028, India.

Telephone + 91-11-2579 6150, 5141 1112 Fax + 91-11-2579 5290, 5141 1119

email@cdil.com www.cdilsemi.com



**Стандарт
Электрон
Связь**

Мы молодая и активно развивающаяся компания в области поставок электронных компонентов. Мы поставляем электронные компоненты отечественного и импортного производства напрямую от производителей и с крупнейших складов мира.

Благодаря сотрудничеству с мировыми поставщиками мы осуществляем комплексные и плановые поставки широчайшего спектра электронных компонентов.

Собственная эффективная логистика и склад в обеспечивает надежную поставку продукции в точно указанные сроки по всей России.

Мы осуществляем техническую поддержку нашим клиентам и предпродажную проверку качества продукции. На все поставляемые продукты мы предоставляем гарантию .

Осуществляем поставки продукции под контролем ВП МО РФ на предприятия военно-промышленного комплекса России , а также работаем в рамках 275 ФЗ с открытием отдельных счетов в уполномоченном банке. Система менеджмента качества компании соответствует требованиям ГОСТ ISO 9001.

Минимальные сроки поставки, гибкие цены, неограниченный ассортимент и индивидуальный подход к клиентам являются основой для выстраивания долгосрочного и эффективного сотрудничества с предприятиями радиоэлектронной промышленности, предприятиями ВПК и научно-исследовательскими институтами России.

С нами вы становитесь еще успешнее!

Наши контакты:

Телефон: +7 812 627 14 35

Электронная почта: sales@st-electron.ru

Адрес: 198099, Санкт-Петербург,
Промышленная ул, дом № 19, литера Н,
помещение 100-Н Офис 331