

**NPN SURFACE MOUNT SMALL SIGNAL TRANSISTOR**
**Features**

- Ideally Suited for Automated Insertion
- Epitaxial Planar Die Construction
- For Switching, AF Driver and Amplifier Applications
- Complementary PNP Types Available (BC807)
- **Lead, Halogen and Antimony Free, RoHS Compliant**
- **"Green" Device (Notes 3 and 4)**
- **Qualified to AEC-Q101 Standards for High Reliability**

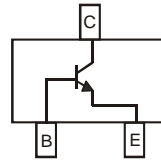

Top View



Device Schematic

**Mechanical Data**

- Case: SOT-23
- Case Material: Molded Plastic, "Green" Molding Compound, Note 4. UL Flammability Classification Rating 94V-0
- Moisture Sensitivity: Level 1 per J-STD-020D
- Terminals: Matte Tin Finish annealed over Alloy 42 leadframe (Lead Free Plating) Solderable per MIL-STD-202, Method 208
- Pin Connections: See Diagram
- Marking Information: See Page 3
- Ordering Information: See Page 3
- Weight: 0.008 grams (approximate)

**Maximum Ratings** @ $T_A = 25^\circ\text{C}$  unless otherwise specified

Characteristic	Symbol	Value	Unit
Collector-Emitter Voltage	$V_{CEO}$	45	V
Emitter-Base Voltage	$V_{EBO}$	5.0	V
Collector Current	$I_C$	800	mA
Peak Collector Current	$I_{CM}$	1000	mA
Peak Emitter Current	$I_{EM}$	1000	mA

**Thermal Characteristics**

Characteristic	Symbol	Value	Unit
Power Dissipation at $T_{SB} = 50^\circ\text{C}$ (Note 1)	$P_D$	310	mW
Thermal Resistance, Junction to Substrate Backside (Note 1)	$R_{\theta SB}$	320	$^\circ\text{C}/\text{W}$
Thermal Resistance, Junction to Ambient Air (Note 1)	$R_{\theta JA}$	403	$^\circ\text{C}/\text{W}$
Operating and Storage Temperature Range	$T_J, T_{STG}$	-65 to +150	$^\circ\text{C}$

**Electrical Characteristics** @ $T_A = 25^\circ\text{C}$  unless otherwise specified

Characteristic (Note 2)	Symbol	Min	Max	Unit	Test Condition
DC Current Gain	$h_{FE}$	100	250	—	$V_{CE} = 1.0\text{V}, I_C = 100\text{mA}$
		160	400		
		250	600		
Current Gain Group -16 -25 -40	$h_{FE}$	60	—	—	$V_{CE} = 1.0\text{V}, I_C = 300\text{mA}$
		100	—		
		170	—		
Collector-Emitter Saturation Voltage	$V_{CE(SAT)}$	—	0.7	V	$I_C = 500\text{mA}, I_B = 50\text{mA}$
Base-Emitter Voltage	$V_{BE}$	—	1.2	V	$V_{CE} = 1.0\text{V}, I_C = 300\text{mA}$
Collector-Emitter Cutoff Current	$I_{CES}$	—	100 5.0	nA $\mu\text{A}$	$V_{CE} = 45\text{V}$ $V_{CE} = 25\text{V}, T_j = 150^\circ\text{C}$
Emitter-Base Cutoff Current	$I_{EBO}$	—	100	nA	$V_{EB} = 4.0\text{V}$
Gain Bandwidth Product	$f_T$	100	—	MHz	$V_{CE} = 5.0\text{V}, I_C = 10\text{mA},$ $f = 50\text{MHz}$
Collector-Base Capacitance	$C_{CBO}$	—	12	pF	$V_{CB} = 10\text{V}, f = 1.0\text{MHz}$

- Notes:
1. Device mounted on Ceramic Substrate 0.7mm; 2.5cm<sup>2</sup> area.
  2. Short duration pulse test used to minimize self-heating effect.
  3. No purposefully added lead. Halogen and Antimony Free.
  4. Product manufactured with Data Code V9 (week 33, 2008) and newer are built with Green Molding Compound. Product manufactured prior to Date Code V9 are built with Non-Green Molding Compound and may contain Halogens or Sb<sub>2</sub>O<sub>3</sub> Fire Retardants.

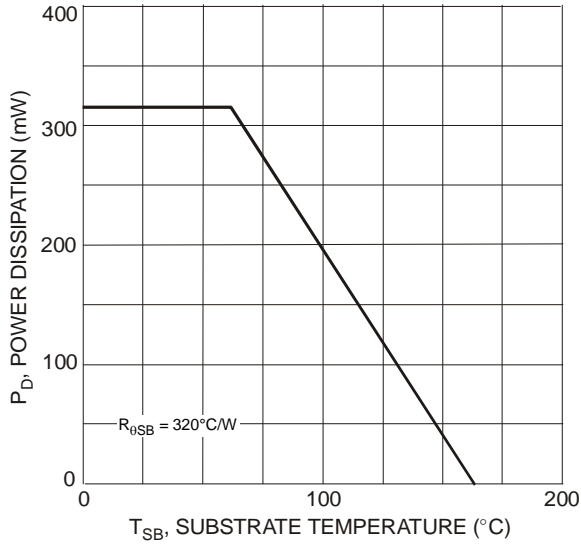

Fig. 1 Power Dissipation vs. Substrate Temperature (Note 1)

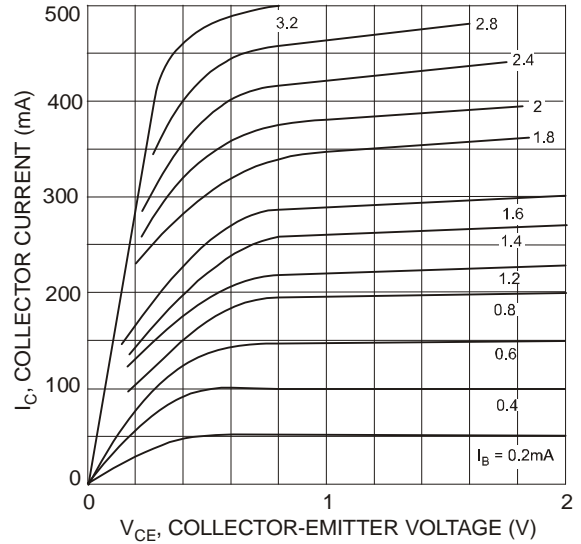

Fig. 2 Typical Collector Current vs. Collector-Emitter Voltage

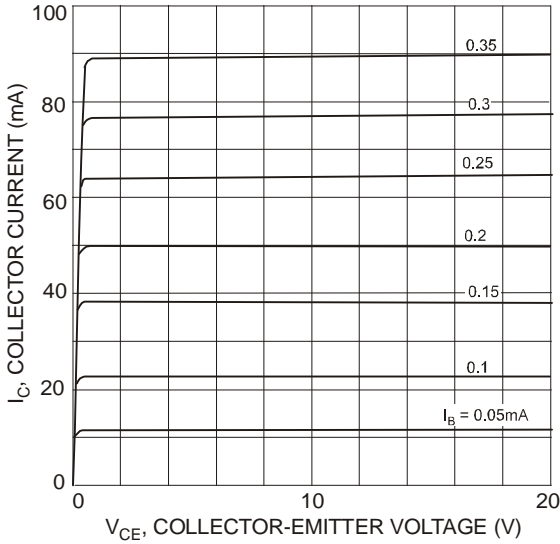

Fig. 3 Typical Collector Current vs. Collector-Emitter Voltage

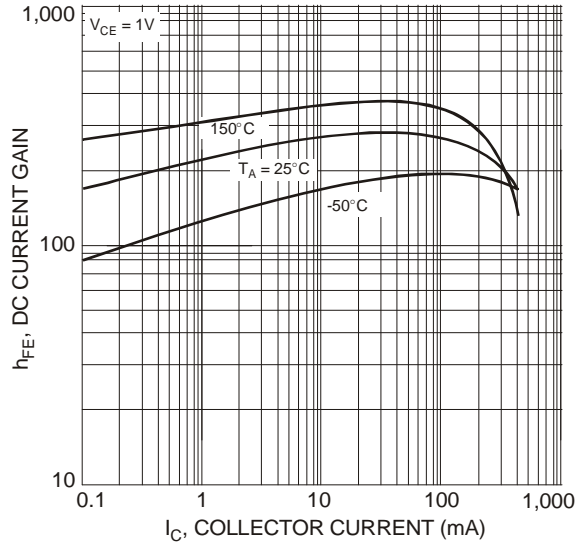

Fig. 4 Typical DC Current Gain vs. Collector Current

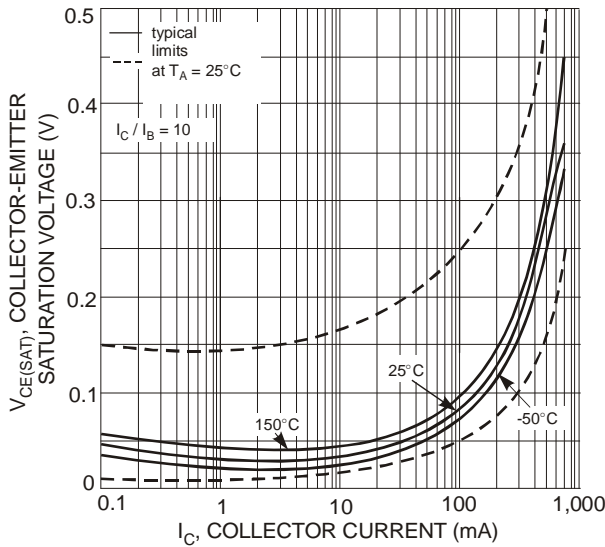

Fig. 5 Typical Collector-Emitter Saturation Voltage vs. Collector Current

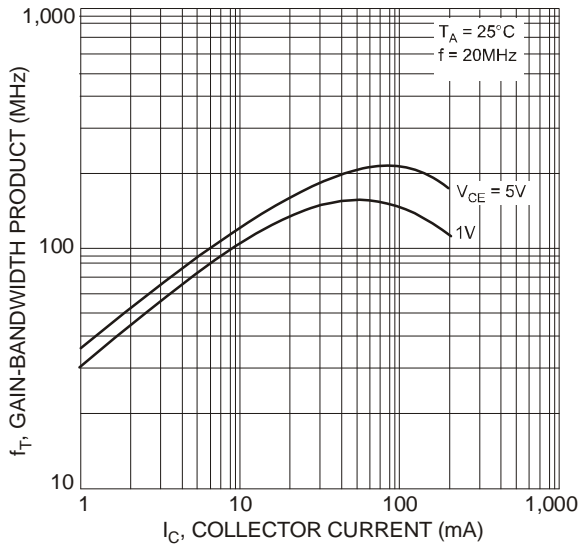

Fig. 6 Gain-Bandwidth Product vs. Collector Current

### Ordering Information (Note 5)

Part Number	Case	Packaging
BC817-xx-7-F	SOT-23	3000/Tape & Reel

\*xx = gain group, e.g. BC817-16-7-F.

Notes: 5. For packaging details, go to our website at <http://www.diodes.com/datasheets/ap02007.pdf>.

### Marking Information

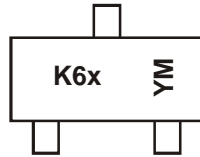

K6x = Product Type Marking Code:

K6A = BC817-16

K6B = BC817-25

K6C = BC817-40

YM = Date Code Marking

Y = Year (ex: T = 2006)

M = Month (ex: 9 = September)

Date Code Key

Year	1998	1999	2000	2001	2002	2003	2004	2005	2006	2007	2008	2009	2010	2011	2012	2013	2014	2015
Code	J	K	L	M	N	P	R	S	T	U	V	W	X	Y	Z	A	B	C
Month	Jan	Feb	Mar	Apr	May	Jun	Jul	Aug	Sep	Oct	Nov	Dec						
Code	1	2	3	4	5	6	7	8	9	O	N	D						

### Package Outline Dimensions

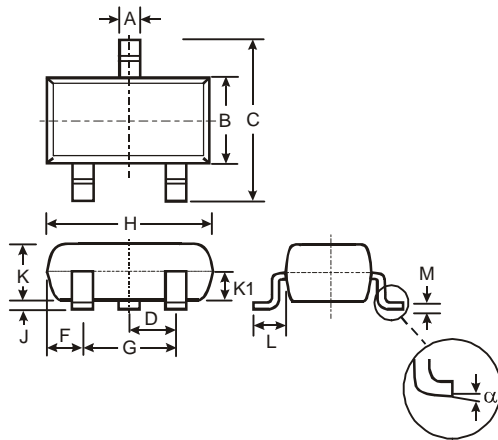

SOT-23			
Dim	Min	Max	Typ
A	0.37	0.51	0.40
B	1.20	1.40	1.30
C	2.30	2.50	2.40
D	0.89	1.03	0.915
F	0.45	0.60	0.535
G	1.78	2.05	1.83
H	2.80	3.00	2.90
J	0.013	0.10	0.05
K	0.903	1.10	1.00
K1	-	-	0.400
L	0.45	0.61	0.55
M	0.085	0.18	0.11
α	0°	8°	-
<b>All Dimensions in mm</b>			

### Suggested Pad Layout

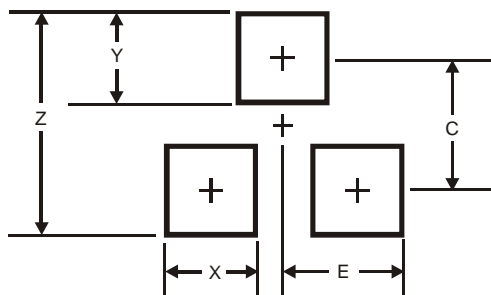

Dimensions	Value (in mm)
Z	2.9
X	0.8
Y	0.9
C	2.0
E	1.35

**IMPORTANT NOTICE**

DIODES INCORPORATED MAKES NO WARRANTY OF ANY KIND, EXPRESS OR IMPLIED, WITH REGARDS TO THIS DOCUMENT, INCLUDING, BUT NOT LIMITED TO, THE IMPLIED WARRANTIES OF MERCHANTABILITY AND FITNESS FOR A PARTICULAR PURPOSE (AND THEIR EQUIVALENTS UNDER THE LAWS OF ANY JURISDICTION).

Diodes Incorporated and its subsidiaries reserve the right to make modifications, enhancements, improvements, corrections or other changes without further notice to this document and any product described herein. Diodes Incorporated does not assume any liability arising out of the application or use of this document or any product described herein; neither does Diodes Incorporated convey any license under its patent or trademark rights, nor the rights of others. Any Customer or user of this document or products described herein in such applications shall assume all risks of such use and will agree to hold Diodes Incorporated and all the companies whose products are represented on Diodes Incorporated website, harmless against all damages.

Diodes Incorporated does not warrant or accept any liability whatsoever in respect of any products purchased through unauthorized sales channel. Should Customers purchase or use Diodes Incorporated products for any unintended or unauthorized application, Customers shall indemnify and hold Diodes Incorporated and its representatives harmless against all claims, damages, expenses, and attorney fees arising out of, directly or indirectly, any claim of personal injury or death associated with such unintended or unauthorized application.

Products described herein may be covered by one or more United States, international or foreign patents pending. Product names and markings noted herein may also be covered by one or more United States, international or foreign trademarks.

**LIFE SUPPORT**

Diodes Incorporated products are specifically not authorized for use as critical components in life support devices or systems without the express written approval of the Chief Executive Officer of Diodes Incorporated. As used herein:

A. Life support devices or systems are devices or systems which:

1. are intended to implant into the body, or
2. support or sustain life and whose failure to perform when properly used in accordance with instructions for use provided in the labeling can be reasonably expected to result in significant injury to the user.

B. A critical component is any component in a life support device or system whose failure to perform can be reasonably expected to cause the failure of the life support device or to affect its safety or effectiveness.

Customers represent that they have all necessary expertise in the safety and regulatory ramifications of their life support devices or systems, and acknowledge and agree that they are solely responsible for all legal, regulatory and safety-related requirements concerning their products and any use of Diodes Incorporated products in such safety-critical, life support devices or systems, notwithstanding any devices- or systems-related information or support that may be provided by Diodes Incorporated. Further, Customers must fully indemnify Diodes Incorporated and its representatives against any damages arising out of the use of Diodes Incorporated products in such safety-critical, life support devices or systems.

Copyright © 2009, Diodes Incorporated

[www.diodes.com](http://www.diodes.com)



**Стандарт  
Электрон  
Связь**

Мы молодая и активно развивающаяся компания в области поставок электронных компонентов. Мы поставляем электронные компоненты отечественного и импортного производства напрямую от производителей и с крупнейших складов мира.

Благодаря сотрудничеству с мировыми поставщиками мы осуществляем комплексные и плановые поставки широчайшего спектра электронных компонентов.

Собственная эффективная логистика и склад в обеспечивает надежную поставку продукции в точно указанные сроки по всей России.

Мы осуществляем техническую поддержку нашим клиентам и предпродажную проверку качества продукции. На все поставляемые продукты мы предоставляем гарантию .

Осуществляем поставки продукции под контролем ВП МО РФ на предприятия военно-промышленного комплекса России , а также работаем в рамках 275 ФЗ с открытием отдельных счетов в уполномоченном банке. Система менеджмента качества компании соответствует требованиям ГОСТ ISO 9001.

Минимальные сроки поставки, гибкие цены, неограниченный ассортимент и индивидуальный подход к клиентам являются основой для выстраивания долгосрочного и эффективного сотрудничества с предприятиями радиоэлектронной промышленности, предприятиями ВПК и научно-исследовательскими институтами России.

С нами вы становитесь еще успешнее!

**Наши контакты:**

**Телефон:** +7 812 627 14 35

**Электронная почта:** [sales@st-electron.ru](mailto:sales@st-electron.ru)

**Адрес:** 198099, Санкт-Петербург,  
Промышленная ул, дом № 19, литера Н,  
помещение 100-Н Офис 331