

Wide Supply Range, Rail-to-Rail Output Instrumentation Amplifier with a Minimum Gain of 5

Check for Samples: [INA827](#)

FEATURES

- Eliminates Errors from External Resistors at Gain of 5
- Common-Mode Range Goes Below Negative Supply
- Input Protection: Up to ± 40 V
- Rail-to-Rail Output
- Outstanding Precision:
 - Common-Mode Rejection: 88 dB, min
 - Low Offset Voltage: 150 μ V, max
 - Low Drift: 2.5 μ V/ $^{\circ}$ C, max
 - Low Gain Drift: 1 ppm/ $^{\circ}$ C, max (G = 5 V/V)
 - Power-Supply Rejection: 100 dB, min (G = 5)
 - Noise: 17 nV/ $\sqrt{\text{Hz}}$, G = 1000 V/V
- High Bandwidth:
 - G = 5: 600 kHz
 - G = 100: 150 kHz
- Supply Current: 200 μ A, typ
- Supply Range:
 - Single Supply: +2.7 V to +36 V
 - Dual Supply: ± 1.35 V to ± 18 V
- Specified Temperature Range: -40° C to $+125^{\circ}$ C
- Package: MSOP-8

APPLICATIONS

- Industrial Process Controls
- Multichannel Systems
- Power Automation
- Weigh Scales
- Medical Instrumentation
- Data Acquisition

DESCRIPTION

The INA827 is a low-cost instrumentation amplifier (INA) that offers extremely low power consumption and operates over a very wide single- or dual-supply range. The device is optimized for the lowest possible gain drift of only 1 ppm per degree Celsius in G = 5, which requires no external resistor. However, a single external resistor sets any gain from 5 to 1000.

The INA827 is optimized to provide excellent common-mode rejection ratio (CMRR) of over 88 dB (G = 5) over frequencies up to 5 kHz. In G = 5, CMRR exceeds 88 dB across the full input common-mode range from the negative supply all the way up to 1 V of the positive supply. Using a rail-to-rail output, the INA827 is well-suited for low-voltage operation from a 2.7 V single-supply as well as dual supplies up to ± 18 V. Additional circuitry protects the inputs against overvoltage of up to ± 40 V beyond the power supplies by limiting the input currents to a safe level.

The INA827 is available in a small MSOP-8 package and is specified for the -40° C to $+125^{\circ}$ C temperature range. For a similar instrumentation amplifier with a gain range of 1 V/V to 1000 V/V, see the [INA826](#).

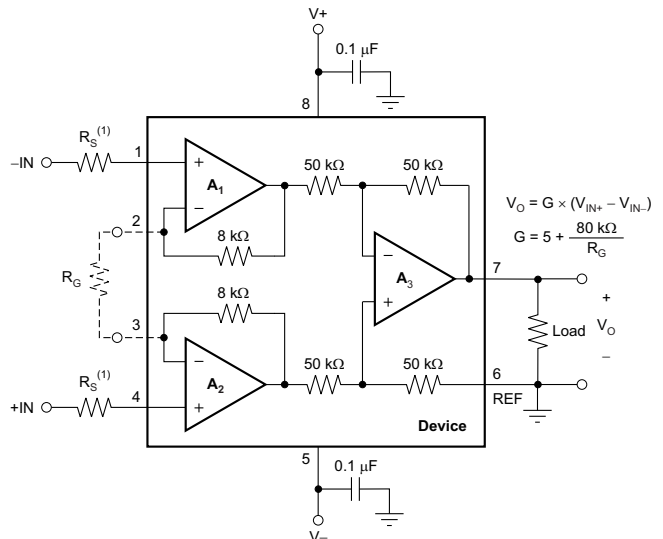

Please be aware that an important notice concerning availability, standard warranty, and use in critical applications of Texas Instruments semiconductor products and disclaimers thereto appears at the end of this data sheet.

PhotoMOS is a registered trademark of Panasonic Electric Works Europe AG.
All other trademarks are the property of their respective owners.



This integrated circuit can be damaged by ESD. Texas Instruments recommends that all integrated circuits be handled with appropriate precautions. Failure to observe proper handling and installation procedures can cause damage.

ESD damage can range from subtle performance degradation to complete device failure. Precision integrated circuits may be more susceptible to damage because very small parametric changes could cause the device not to meet its published specifications.

PACKAGE AND ORDERING INFORMATION⁽¹⁾

PRODUCT	PACKAGE-LEAD	PACKAGE DESIGNATOR	PACKAGE MARKING	ORDERING NUMBER	TRANSPORT MEDIA, QUANTITY
INA827	MSOP-8	DGK	IPSI	INA827AIDGK	Tape and Reel, 250
				INA827AIDGKR	Tape and Reel, 3000

(1) For the most current package and ordering information, see the Package Option Addendum at the end of this document, or visit the device product folder at www.ti.com.

ABSOLUTE MAXIMUM RATINGS⁽¹⁾

		VALUE	UNIT
Voltage	Supply	±20	V
	Input	±40	V
REF input		±20	V
Output short-circuit ⁽²⁾		Continuous	
Temperature range	Operating, T _A	–55 to +150	°C
	Storage, T _{stg}	–65 to +150	°C
	Junction, T _J	+175	°C
Electrostatic discharge (ESD) rating	Human body model (HBM)	2000	V

(1) Stresses above these ratings may cause permanent damage. Exposure to absolute maximum conditions for extended periods may degrade device reliability. These are stress ratings only, and functional operation of the device at these or any other conditions beyond those specified is not implied.

(2) Short-circuit to V_S / 2.

ELECTRICAL CHARACTERISTICS

At $T_A = +25^\circ\text{C}$, $V_S = \pm 15\text{ V}$, $R_L = 10\text{ k}\Omega$, $V_{\text{REF}} = 0\text{ V}$, and $G = 5$, unless otherwise noted.

PARAMETER			TEST CONDITIONS	INA827			UNIT
				MIN	TYP	MAX	
INPUT							
V_{OSI}	Offset voltage ⁽¹⁾	Input stage	$\text{RTI}, V_{\text{OS}} = V_{\text{OSI}} + (V_{\text{OSO}} / G)$	40	150		μV
			$T_A = -40^\circ\text{C to } +125^\circ\text{C}$	0.5	2.5		$\mu\text{V}/^\circ\text{C}$
V_{OSO}		Output stage	$\text{RTI}, V_{\text{OS}} = V_{\text{OSI}} + (V_{\text{OSO}} / G)$	500	2000		μV
			$T_A = -40^\circ\text{C to } +125^\circ\text{C}$	5	30		$\mu\text{V}/^\circ\text{C}$
PSRR	Power-supply rejection ratio		$G = 5, V_S = \pm 1.35\text{ V to } \pm 18\text{ V}$	100	120		dB
			$G = 10, V_S = \pm 1.35\text{ V to } \pm 18\text{ V}$	106	126		dB
			$G > 100, V_S = \pm 1.35\text{ V to } \pm 18\text{ V}$	120	140		dB
Z_{IN}	Impedance	Differential		2 1			$\text{G}\Omega \parallel \text{pF}$
		Common-mode		10 5			$\text{G}\Omega \parallel \text{pF}$
		RFI filter, -3-dB frequency		25			MHz
V_{CM}	Operating input range ⁽²⁾		$V_S = \pm 1.35\text{ V to } \pm 18\text{ V}, V_O = 0\text{ V}$	$(V-) - 0.2$	$(V+) - 0.9$		V
			$V_S = \pm 1.35\text{ V to } \pm 18\text{ V}, V_O = 0\text{ V}, T_A = +125^\circ\text{C}$	$(V-) - 0.05$	$(V+) - 0.8$		V
			$V_S = \pm 1.35\text{ V to } \pm 18\text{ V}, V_O = 0\text{ V}, T_A = -40^\circ\text{C}$	$(V-) - 0.3$	$(V+) - 0.95$		V
	Input overvoltage range	$T_A = -40^\circ\text{C to } +125^\circ\text{C}$		$(V+) - 40$	$(V-) + 40$		V
CMRR	Common-mode rejection ratio	DC to 60 Hz	$G = 5, V_{\text{CM}} = V- \text{ to } (V+) - 1\text{ V}$	88	100		dB
			$G = 10, V_{\text{CM}} = V- \text{ to } (V+) - 1\text{ V}$	94	106		dB
			$G > 100, V_{\text{CM}} = V- \text{ to } (V+) - 1\text{ V}$	110	126		dB
		At 5 kHz	$G = 5, V_{\text{CM}} = V- \text{ to } (V+) - 1\text{ V}$		88		dB
			$G = 10, V_{\text{CM}} = V- \text{ to } (V+) - 1\text{ V}$		94		dB
			$G > 100, V_{\text{CM}} = V- \text{ to } (V+) - 1\text{ V}$		104		dB
BIAS CURRENT							
I_B	Input bias current			35	50		nA
		$T_A = -40^\circ\text{C to } +125^\circ\text{C}$			95		nA
I_{OS}	Input offset current			-5	0.7	5	nA
		$T_A = -40^\circ\text{C to } +125^\circ\text{C}$				10	nA
NOISE VOLTAGE⁽³⁾							
e_{NI}	Voltage noise	Input	$f = 1\text{ kHz}, G = 1000, R_S = 0\ \Omega$	17	18		$\text{nV}/\sqrt{\text{Hz}}$
		Output	$f = 1\text{ kHz}, G = 5, R_S = 0\ \Omega$	250	285		$\text{nV}/\sqrt{\text{Hz}}$
RTI	Referred-to-input		$G = 5, f_B = 0.1\text{ Hz to } 10\text{ Hz}, R_S = 0\ \Omega$	1.4			μV_{PP}
			$G = 1000, f_B = 0.1\text{ Hz to } 10\text{ Hz}, R_S = 0\ \Omega$	0.5			μV_{PP}
i_{N}	Noise current		$f = 1\text{ kHz}$	120			$\text{fA}/\sqrt{\text{Hz}}$
			$f_B = 0.1\text{ Hz to } 10\text{ Hz}$	5			pA_{PP}

(1) Total offset, referred-to-input (RTI): $V_{\text{OS}} = V_{\text{OSI}} + (V_{\text{OSO}} / G)$.

(2) Input voltage range of the INA827 input stage. The input range depends on the common-mode voltage, differential voltage, gain, and reference voltage. See the [Typical Characteristics](#) for more information.

(3)

$$\text{Total RTI voltage noise} = \sqrt{(e_{\text{NI}})^2 + \left[\frac{e_{\text{NO}}}{G} \right]^2}$$

ELECTRICAL CHARACTERISTICS (continued)

At $T_A = +25^\circ\text{C}$, $V_S = \pm 15\text{ V}$, $R_L = 10\text{ k}\Omega$, $V_{\text{REF}} = 0\text{ V}$, and $G = 5$, unless otherwise noted.

PARAMETER		TEST CONDITIONS	INA827			UNIT
			MIN	TYP	MAX	
GAIN						
G	Gain equation		$5 + \left[\frac{80\text{ k}\Omega}{R_G} \right]$			V/V
G	Range of gain		5		1000	V/V
GE	Gain error	$G = 5, V_O = \pm 10\text{ V}$		± 0.005	± 0.035	%
		$G = 10\text{ to }1000, V_O = \pm 10\text{ V}$		± 0.1	± 0.4	%
	Gain versus temperature ⁽⁴⁾	$G = 5, T_A = -40^\circ\text{C to }+125^\circ\text{C}$		± 0.1	± 1	ppm/ $^\circ\text{C}$
		$G > 5, T_A = -40^\circ\text{C to }+125^\circ\text{C}$		8	25	ppm/ $^\circ\text{C}$
	Gain nonlinearity	$G = 5\text{ to }100, V_O = -10\text{ V to }+10\text{ V}, R_L = 10\text{ k}\Omega$		2	5	ppm
		$G = 1000, V_O = -10\text{ V to }+10\text{ V}, R_L = 10\text{ k}\Omega$		20	50	ppm
OUTPUT						
	Voltage swing	$R_L = 10\text{ k}\Omega$	$(V-) + 0.1$		$(V+) - 0.15$	V
	Load capacitance stability			1000		pF
	Short-circuit current	Continuous to common		± 16		mA
FREQUENCY RESPONSE						
BW	Bandwidth, -3 dB	$G = 5$		600		kHz
		$G = 10$		530		kHz
		$G = 100$		150		kHz
		$G = 1000$		15		kHz
SR	Slew rate	$G = 5, V_O = \pm 14.5\text{ V}$		1.5		V/ μs
		$G = 100, V_O = \pm 14.5\text{ V}$		1.5		V/ μs
t_s	Settling time	To 0.01%	$G = 5, V_{\text{STEP}} = 10\text{ V}$		10	μs
			$G = 100, V_{\text{STEP}} = 10\text{ V}$		12	μs
			$G = 1000, V_{\text{STEP}} = 10\text{ V}$		95	μs
		To 0.001%	$G = 1, V_{\text{STEP}} = 10\text{ V}$		11	μs
			$G = 100, V_{\text{STEP}} = 10\text{ V}$		18	μs
			$G = 1000, V_{\text{STEP}} = 10\text{ V}$		118	μs
REFERENCE INPUT						
R_{IN}	Input impedance			60		k Ω
	Voltage range		$V-$		$V+$	V
	Gain to output			1		V/V
	Reference gain error			0.01		%
POWER SUPPLY						
V_S	Power-supply voltage	Single		+2.7	+36	V
		Dual		± 1.35	± 18	V
I_Q	Quiescent current	$V_{\text{IN}} = 0\text{ V}$		200	250	μA
		$T_A = -40^\circ\text{C to }+125^\circ\text{C}$		250	320	μA
TEMPERATURE RANGE						
	Specified		-40		+125	$^\circ\text{C}$
	Operating		-50		+150	$^\circ\text{C}$
θ_{JA}	Thermal resistance			215		$^\circ\text{C/W}$

(4) The values specified for $G > 5$ do not include the effects of the external gain-setting resistor, R_G .

THERMAL INFORMATION

THERMAL METRIC ⁽¹⁾		INA827	UNITS
		DGK (MSOP)	
		8 PINS	
θ_{JA}	Junction-to-ambient thermal resistance	215.4	°C/W
θ_{JcTop}	Junction-to-case (top) thermal resistance	66.3	
θ_{JB}	Junction-to-board thermal resistance	97.8	
ψ_{JT}	Junction-to-top characterization parameter	10.5	
ψ_{JB}	Junction-to-board characterization parameter	96.1	
θ_{JcBot}	Junction-to-case (bottom) thermal resistance	N/A	

(1) For more information about traditional and new thermal metrics, see the *IC Package Thermal Metrics* application report, [SPRA953](#).

PIN CONFIGURATION

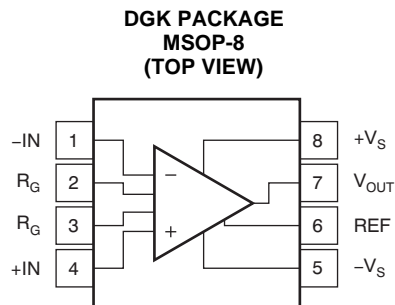

PIN DESCRIPTIONS

NAME	NO.	DESCRIPTION
-IN	1	Negative input
+IN	4	Positive input
REF	6	Reference input. This pin must be driven by low impedance.
R_G	2, 3	Gain setting pin. Place a gain resistor between pin 2 and pin 3.
V_{OUT}	7	Output
$-V_S$	5	Negative supply
$+V_S$	8	Positive supply

TYPICAL CHARACTERISTICS

At $T_A = +25^\circ\text{C}$, $V_S = \pm 15\text{ V}$, $R_L = 10\text{ k}\Omega$, $V_{REF} = 0\text{ V}$, and $G = 5$, unless otherwise noted.

TYPICAL DISTRIBUTION OF INPUT OFFSET VOLTAGE

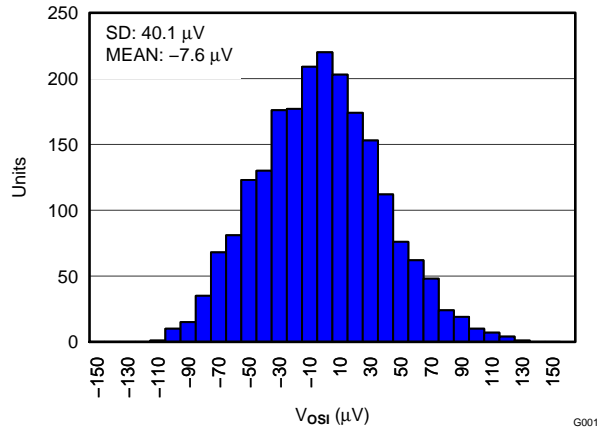

Figure 1.

TYPICAL DISTRIBUTION OF INPUT OFFSET VOLTAGE DRIFT

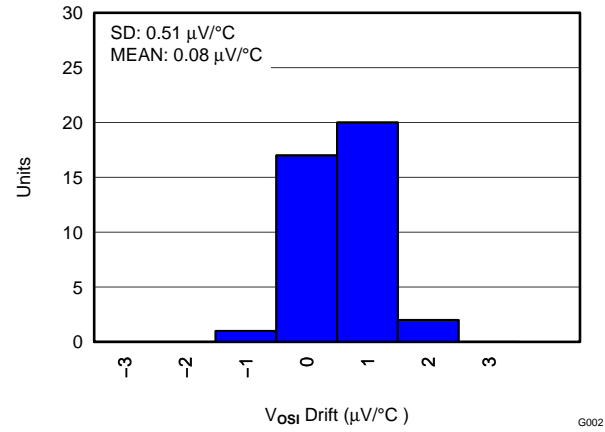

Figure 2.

TYPICAL DISTRIBUTION OF OUTPUT OFFSET VOLTAGE

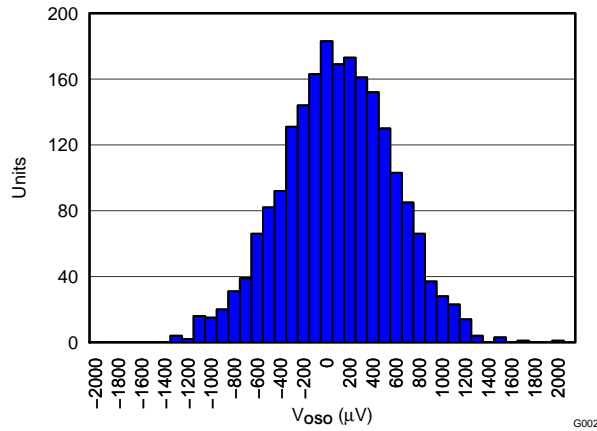

Figure 3.

TYPICAL DISTRIBUTION OF OUTPUT OFFSET VOLTAGE DRIFT

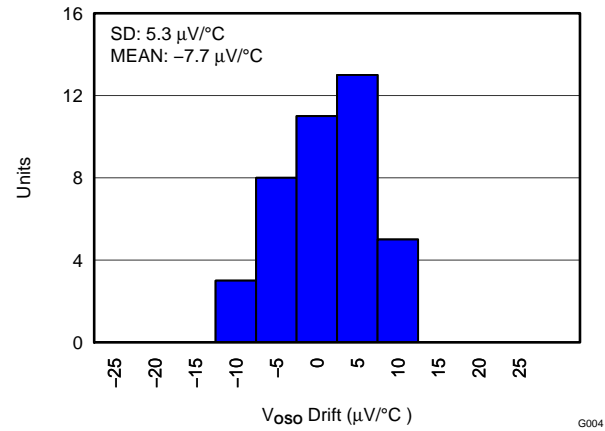

Figure 4.

TYPICAL CHARACTERISTICS (continued)

At $T_A = +25^\circ\text{C}$, $V_S = \pm 15\text{ V}$, $R_L = 10\text{ k}\Omega$, $V_{REF} = 0\text{ V}$, and $G = 5$, unless otherwise noted.

TYPICAL DISTRIBUTION OF INPUT BIAS CURRENT

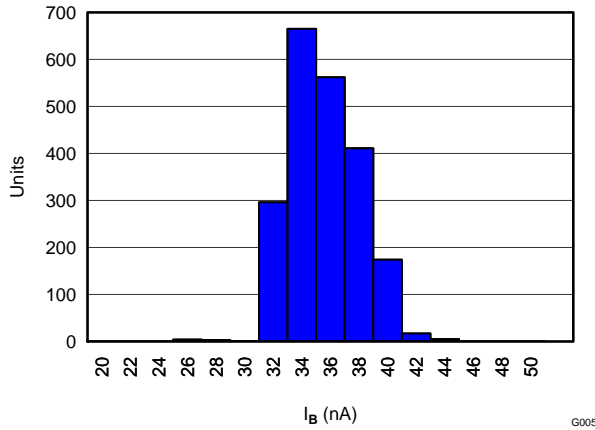

Figure 5.

TYPICAL DISTRIBUTION OF INPUT OFFSET CURRENT

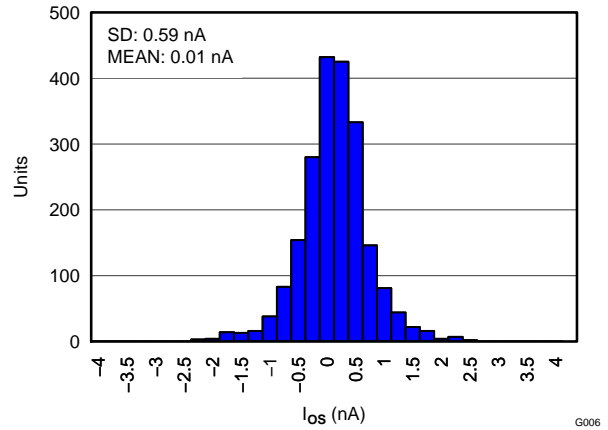

Figure 6.

INPUT COMMON-MODE VOLTAGE vs OUTPUT VOLTAGE (Single Supply, $V_S = +2.7\text{ V}$, $G = 5$)

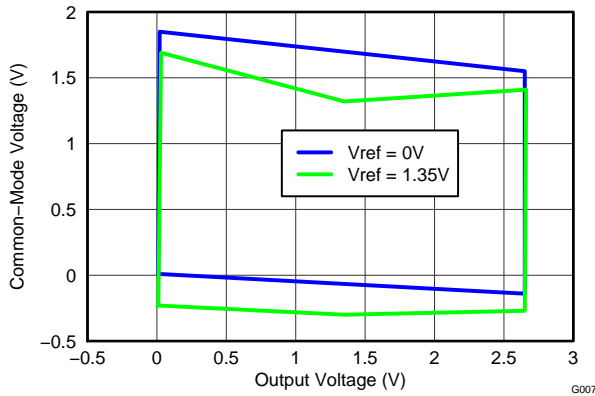

Figure 7.

INPUT COMMON-MODE VOLTAGE vs OUTPUT VOLTAGE (Single Supply, $V_S = +2.7\text{ V}$, $G = 100$)

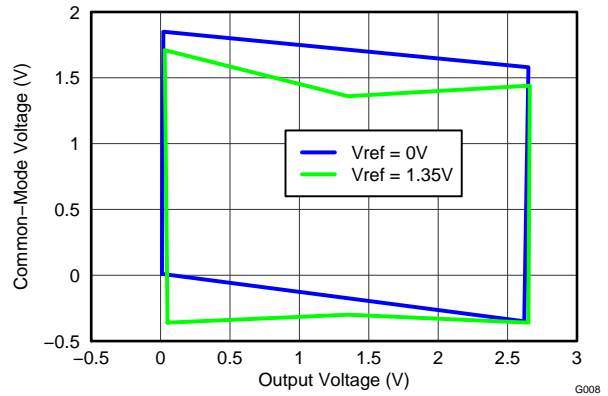

Figure 8.

INPUT COMMON-MODE VOLTAGE vs OUTPUT VOLTAGE (Single Supply, $V_S = +5\text{ V}$, $G = 5$)

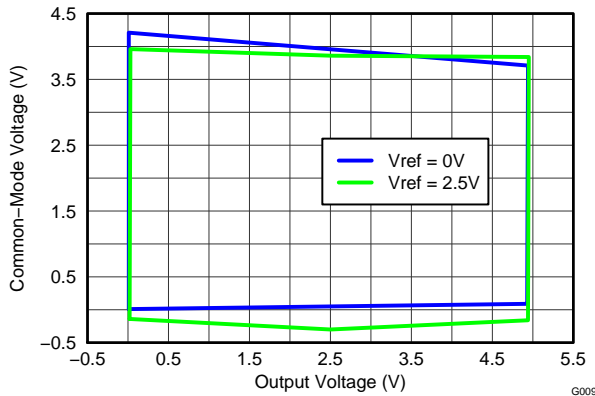

Figure 9.

INPUT COMMON-MODE VOLTAGE vs OUTPUT VOLTAGE (Single Supply, $V_S = +5\text{ V}$, $G = 100$)

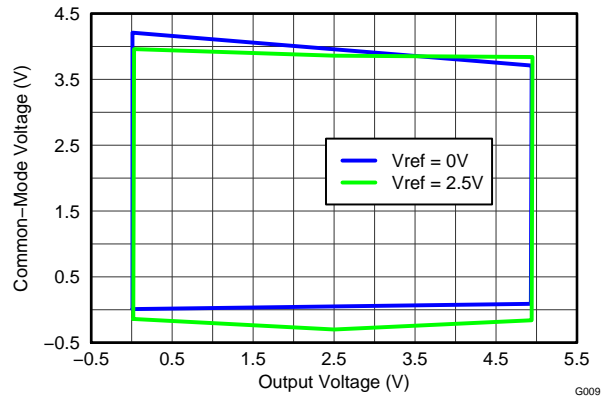

Figure 10.

TYPICAL CHARACTERISTICS (continued)

At $T_A = +25^\circ\text{C}$, $V_S = \pm 15\text{ V}$, $R_L = 10\text{ k}\Omega$, $V_{REF} = 0\text{ V}$, and $G = 5$, unless otherwise noted.

INPUT COMMON-MODE VOLTAGE vs OUTPUT VOLTAGE
(Dual Supply, $V_S = \pm 5\text{ V}$)

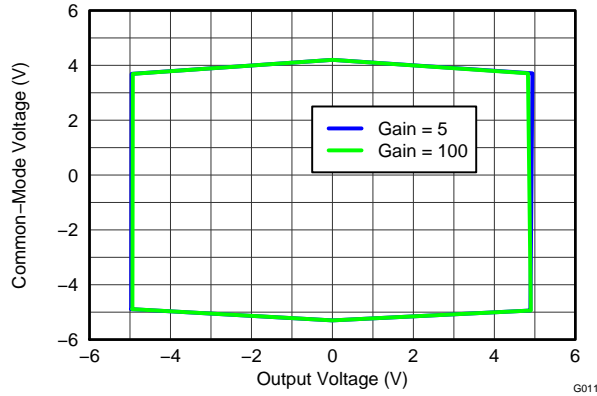

Figure 11.

INPUT COMMON-MODE VOLTAGE vs OUTPUT VOLTAGE
(Dual Supply, $V_S = \pm 15\text{ V}$, $\pm 12\text{ V}$, $G = 5$)

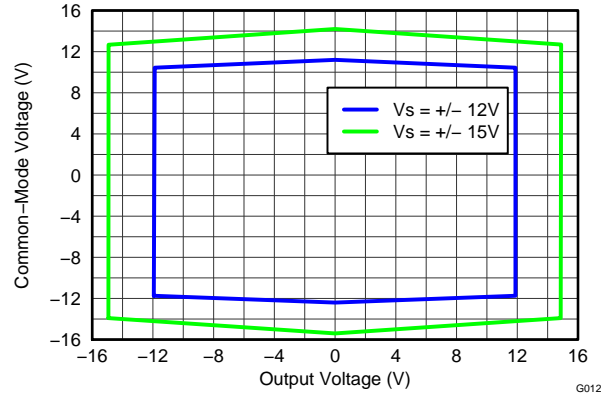

Figure 12.

INPUT COMMON-MODE VOLTAGE vs OUTPUT VOLTAGE
(Dual Supply, $V_S = \pm 15\text{ V}$, $\pm 12\text{ V}$, $G = 100$)

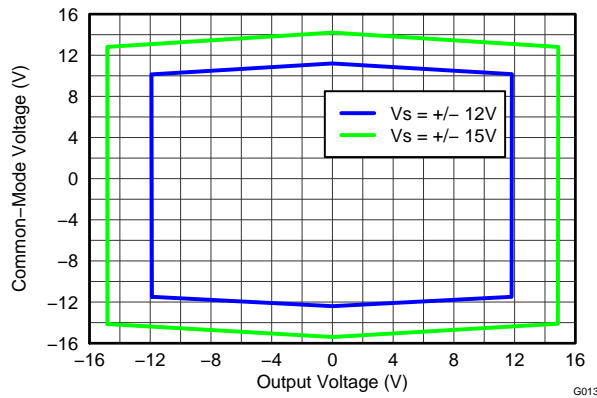

Figure 13.

INPUT OVERVOLTAGE vs INPUT CURRENT
($G = 1$, $V_S = \pm 15\text{ V}$)

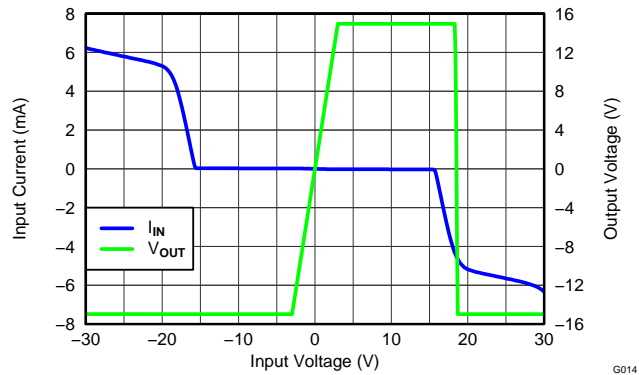

Figure 14.

CMRR vs FREQUENCY
(RTI)

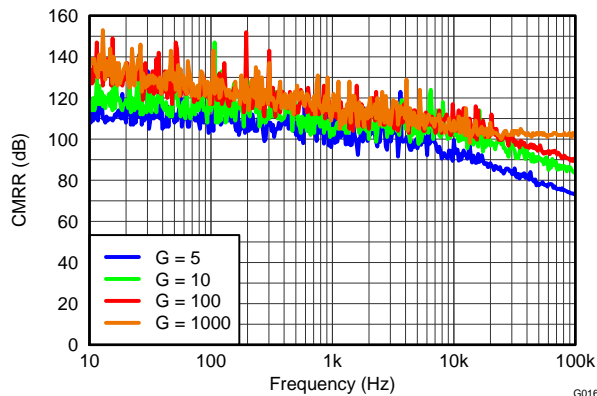

Figure 15.

CMRR vs FREQUENCY
(RTI, 1-k Ω Source Imbalance)

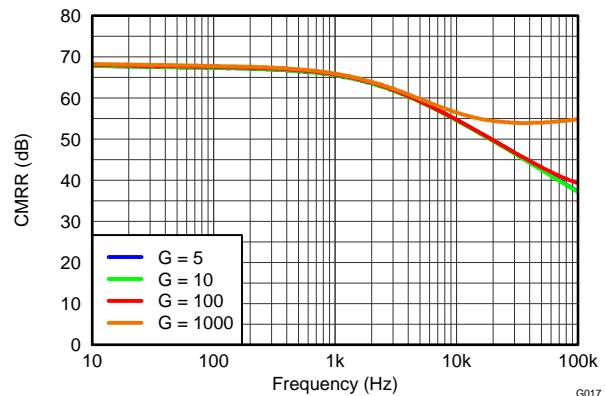

Figure 16.

TYPICAL CHARACTERISTICS (continued)

At $T_A = +25^\circ\text{C}$, $V_S = \pm 15\text{ V}$, $R_L = 10\text{ k}\Omega$, $V_{REF} = 0\text{ V}$, and $G = 5$, unless otherwise noted.

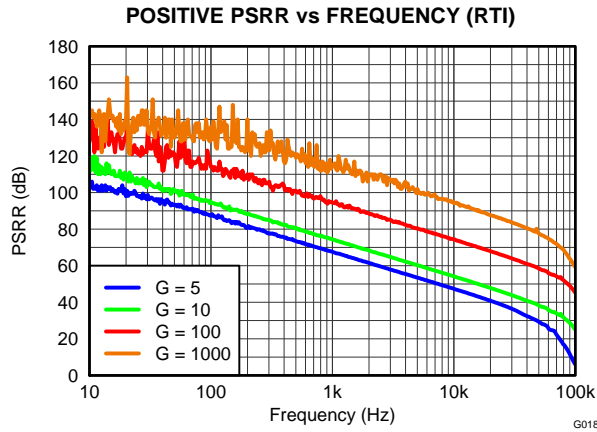

Figure 17.

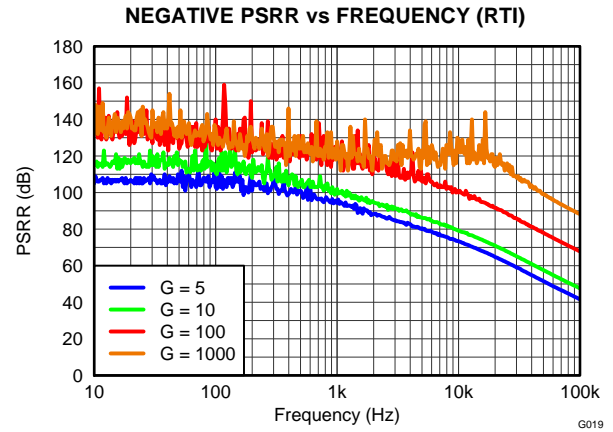

Figure 18.

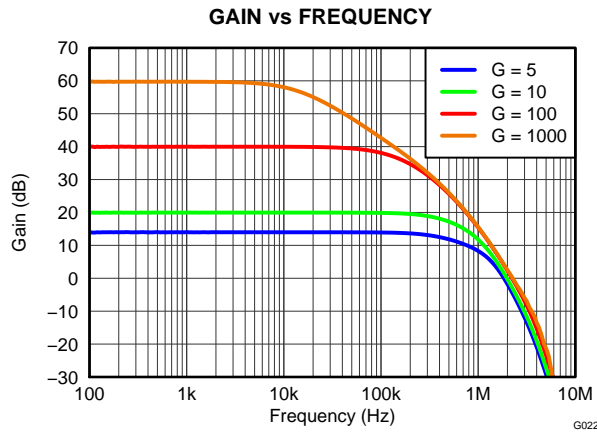

Figure 19.

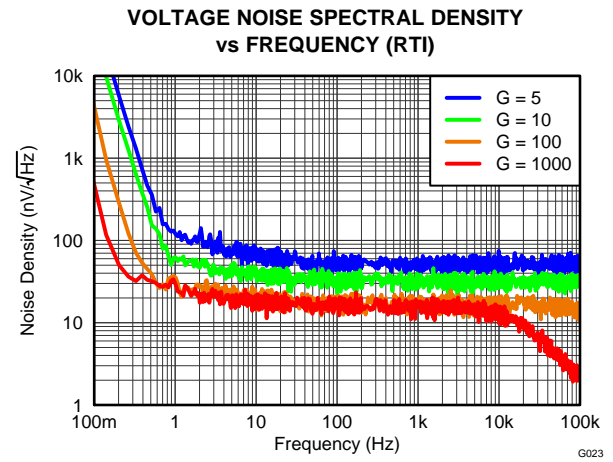

Figure 20.

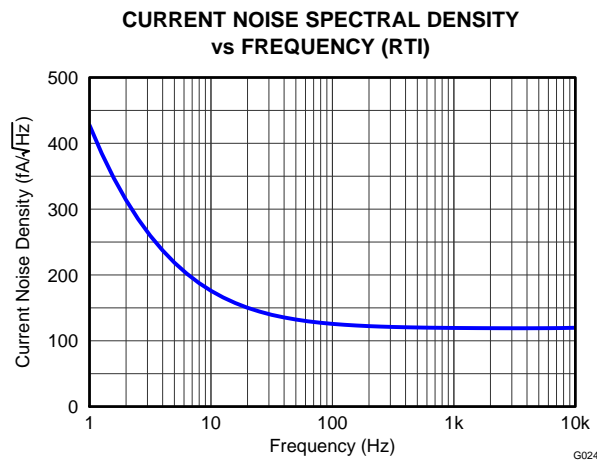

Figure 21.

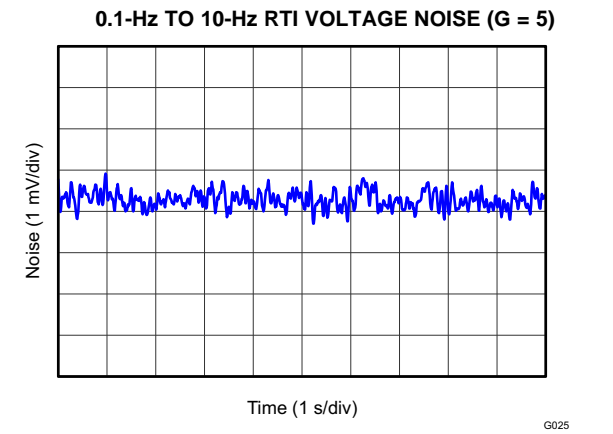

Figure 22.

TYPICAL CHARACTERISTICS (continued)

At $T_A = +25^\circ\text{C}$, $V_S = \pm 15\text{ V}$, $R_L = 10\text{ k}\Omega$, $V_{REF} = 0\text{ V}$, and $G = 5$, unless otherwise noted.

0.1-Hz TO 10-Hz RTI VOLTAGE NOISE (G = 1000)

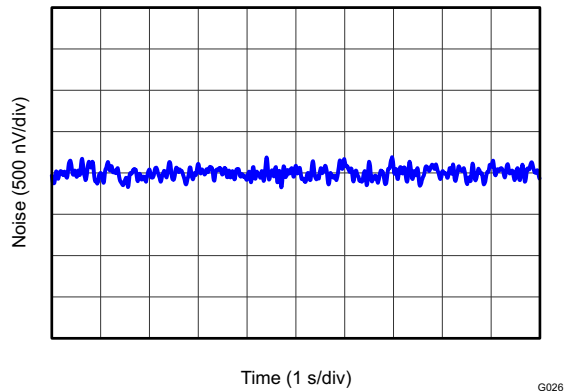

Figure 23.

0.1-Hz TO 10-Hz RTI CURRENT NOISE

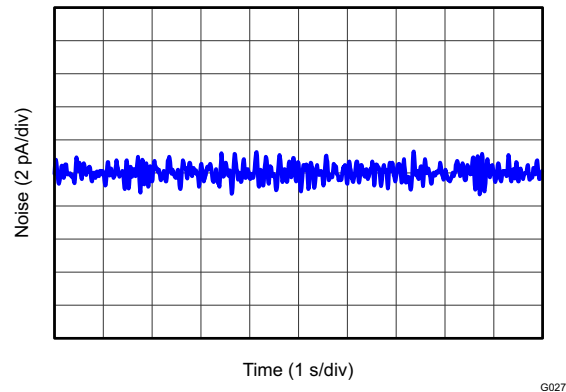

Figure 24.

INPUT BIAS CURRENT vs COMMON-MODE VOLTAGE ($V_S = +2.7\text{ V}$)

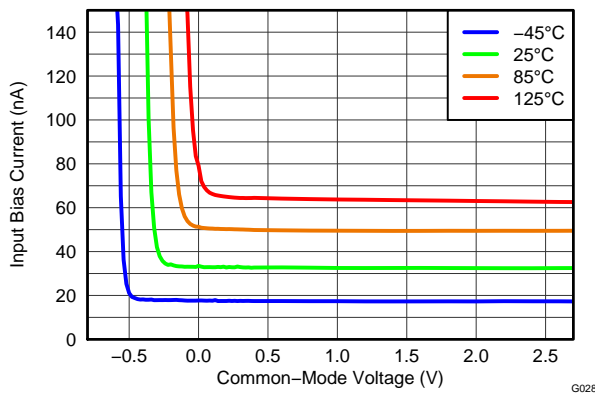

Figure 25.

INPUT BIAS CURRENT vs COMMON-MODE VOLTAGE ($V_S = \pm 15\text{ V}$)

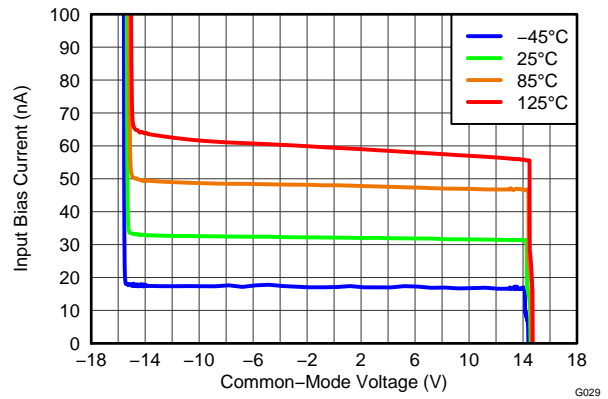

Figure 26.

INPUT BIAS CURRENT vs TEMPERATURE

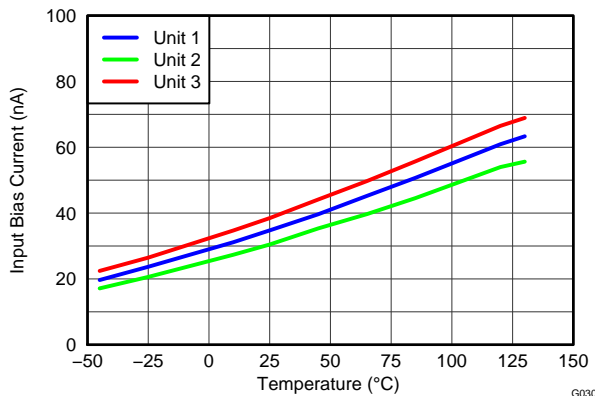

Figure 27.

INPUT OFFSET CURRENT vs TEMPERATURE

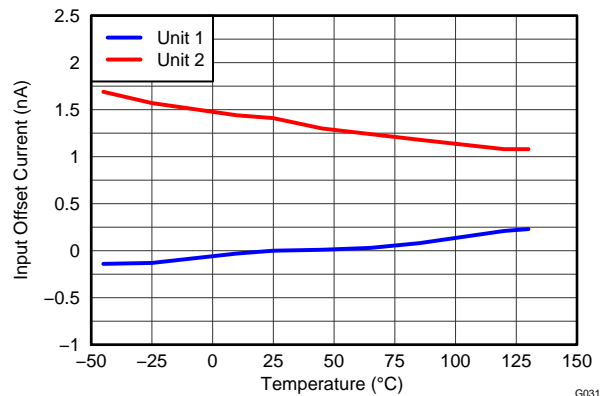

Figure 28.

TYPICAL CHARACTERISTICS (continued)

At $T_A = +25^\circ\text{C}$, $V_S = \pm 15\text{ V}$, $R_L = 10\text{ k}\Omega$, $V_{REF} = 0\text{ V}$, and $G = 5$, unless otherwise noted.

**GAIN ERROR vs TEMPERATURE
(G = 5)**

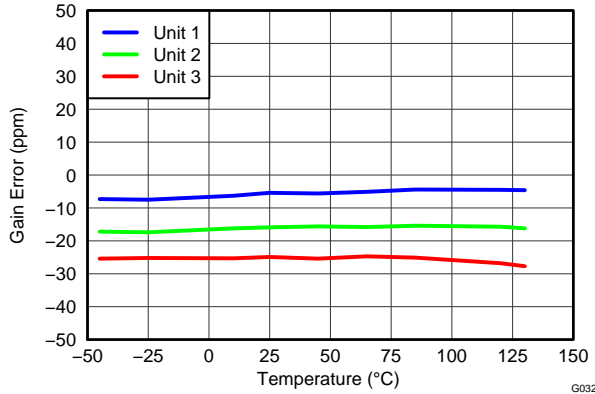

Figure 29.

SUPPLY CURRENT vs TEMPERATURE

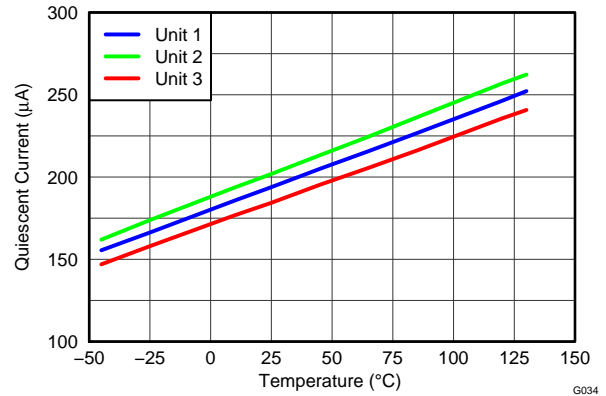

Figure 30.

GAIN NONLINEARITY (G = 5)

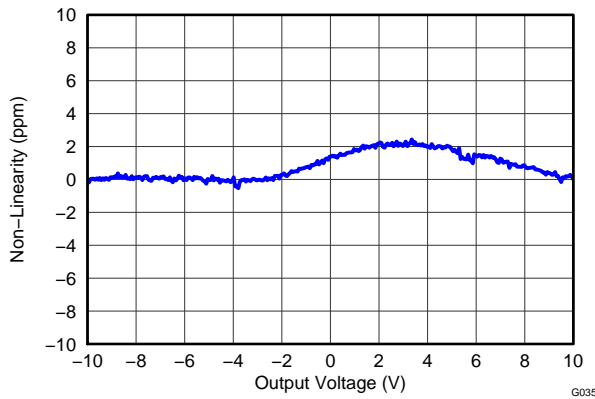

Figure 31.

GAIN NONLINEARITY (G = 10)

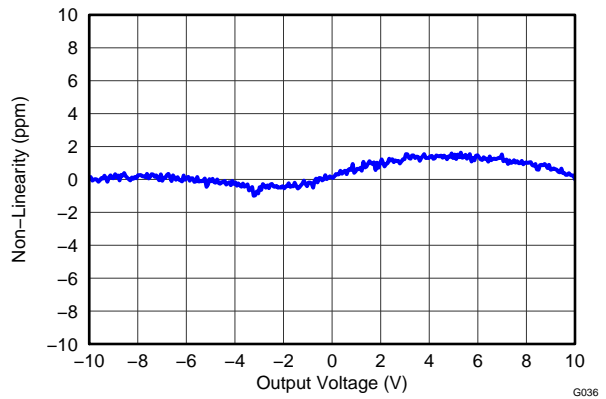

Figure 32.

GAIN NONLINEARITY (G = 100)

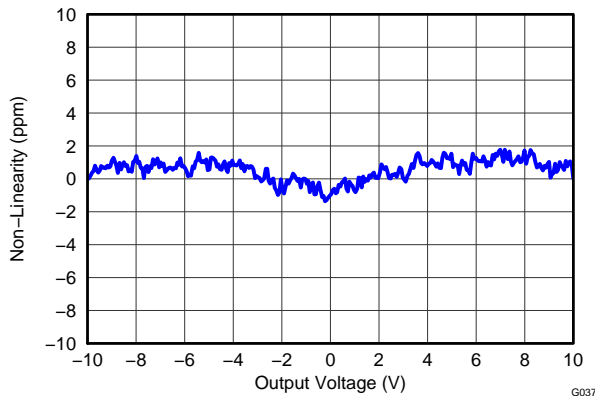

Figure 33.

GAIN NONLINEARITY (G = 1000)

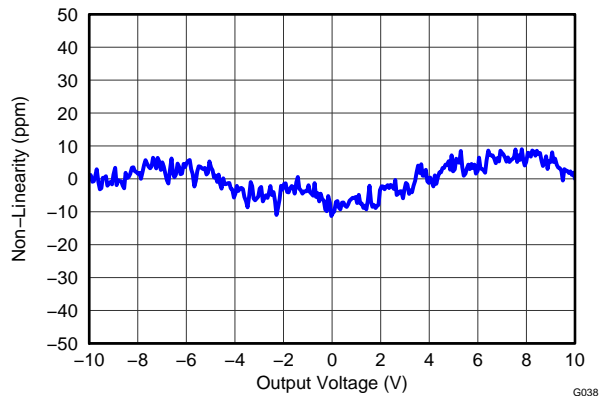

Figure 34.

TYPICAL CHARACTERISTICS (continued)

At $T_A = +25^\circ\text{C}$, $V_S = \pm 15\text{ V}$, $R_L = 10\text{ k}\Omega$, $V_{\text{REF}} = 0\text{ V}$, and $G = 5$, unless otherwise noted.

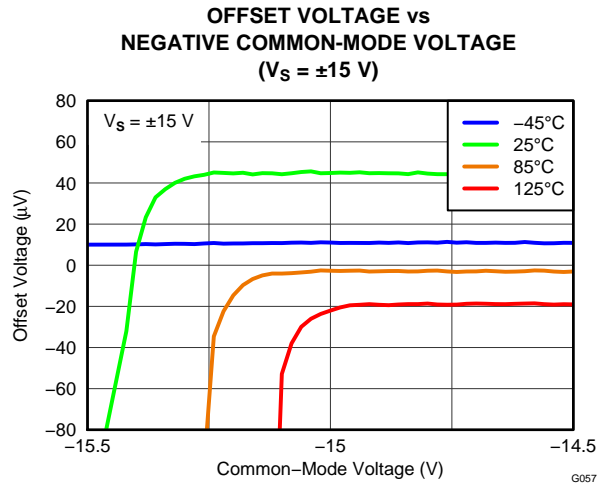

Figure 35.

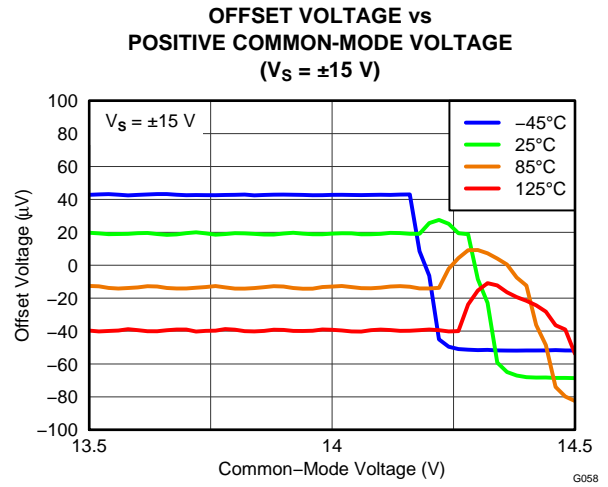

Figure 36.

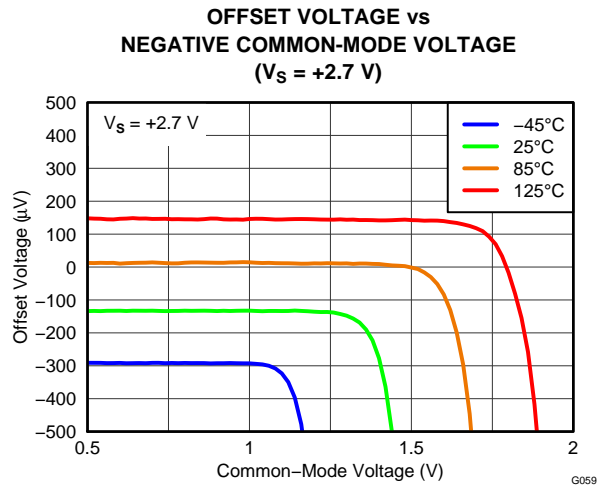

Figure 37.

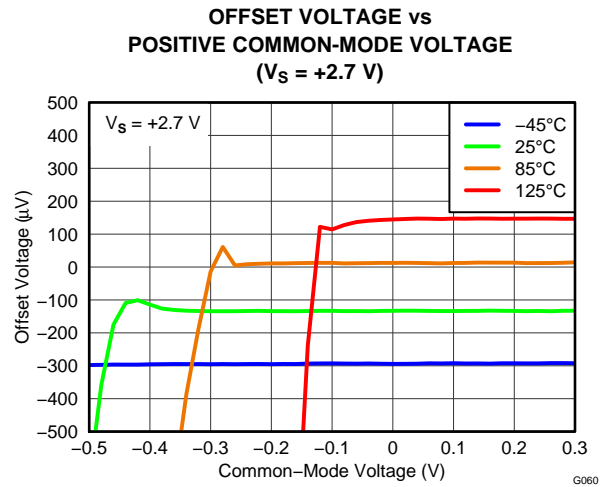

Figure 38.

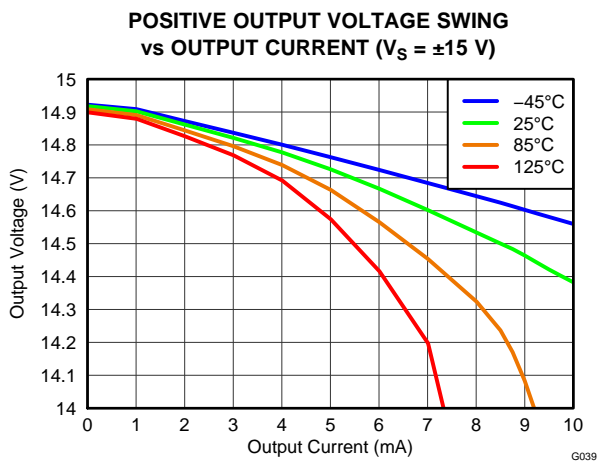

Figure 39.

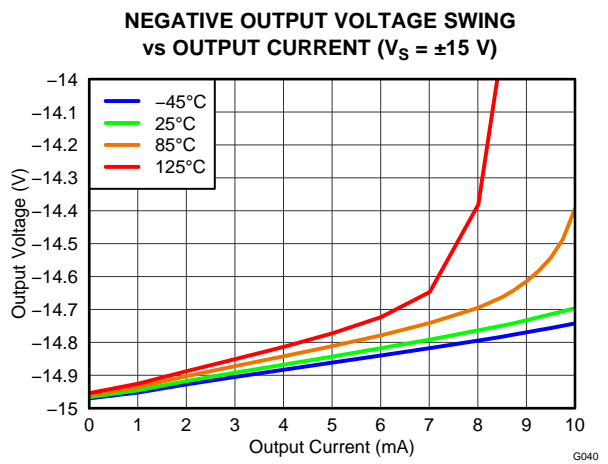

Figure 40.

TYPICAL CHARACTERISTICS (continued)

At $T_A = +25^\circ\text{C}$, $V_S = \pm 15\text{ V}$, $R_L = 10\text{ k}\Omega$, $V_{REF} = 0\text{ V}$, and $G = 5$, unless otherwise noted.

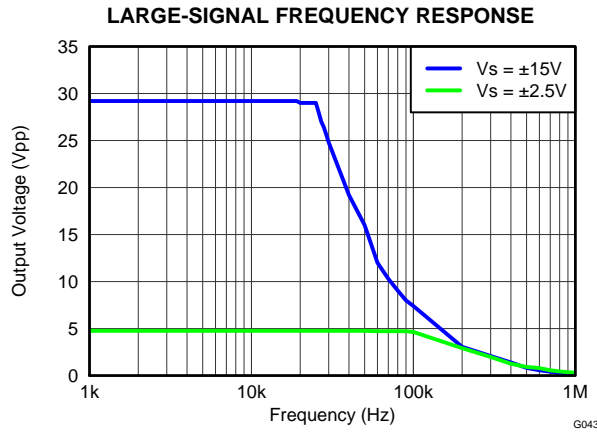

Figure 41.

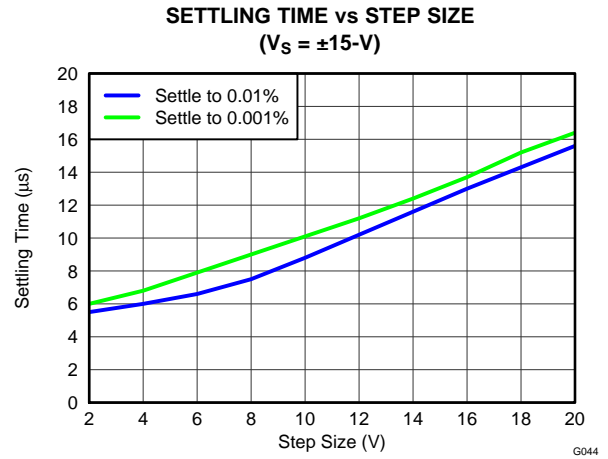

Figure 42.

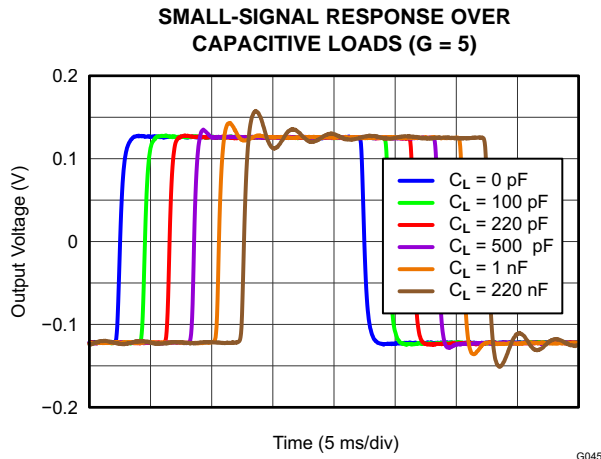

Figure 43.

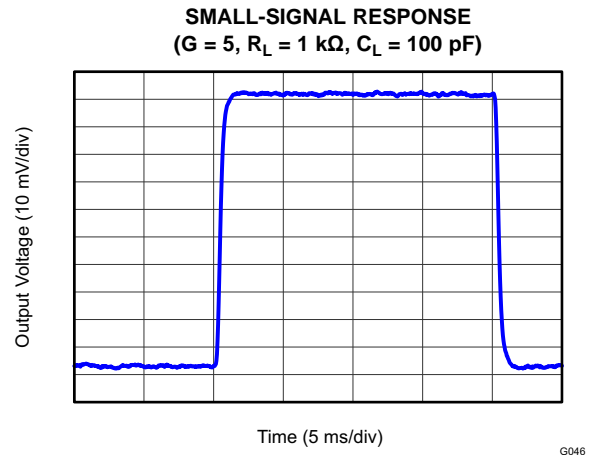

Figure 44.

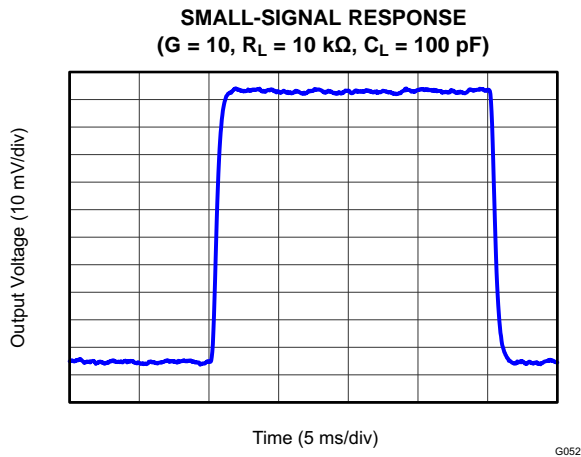

Figure 45.

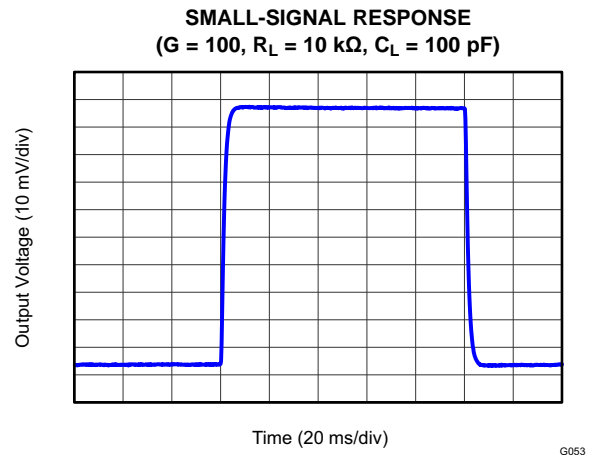

Figure 46.

TYPICAL CHARACTERISTICS (continued)

At $T_A = +25^\circ\text{C}$, $V_S = \pm 15\text{ V}$, $R_L = 10\text{ k}\Omega$, $V_{REF} = 0\text{ V}$, and $G = 5$, unless otherwise noted.

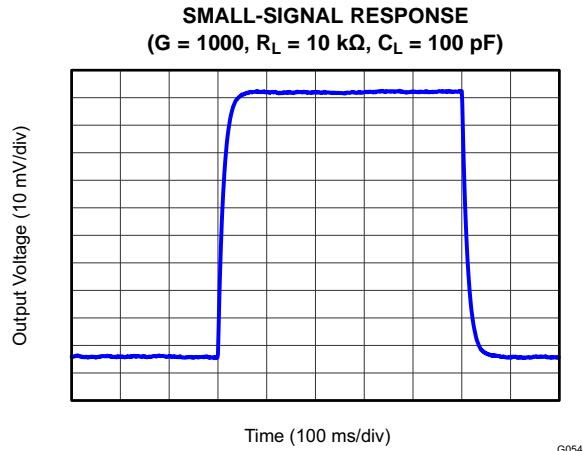

Figure 47.

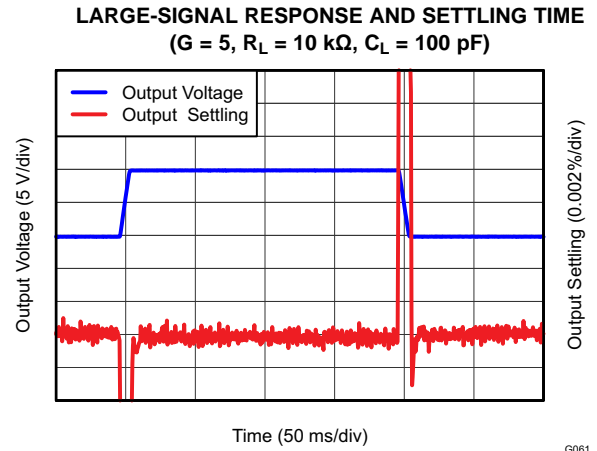

Figure 48.

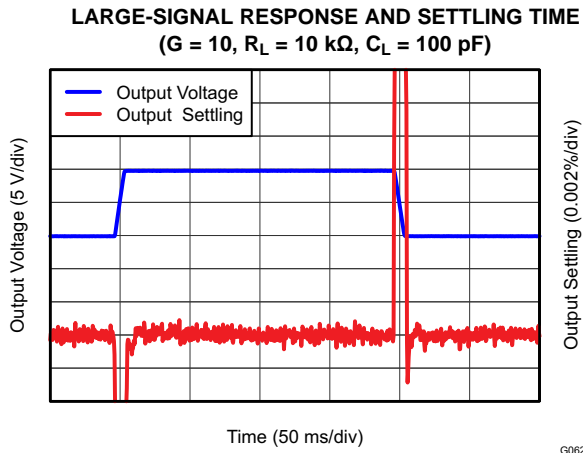

Figure 49.

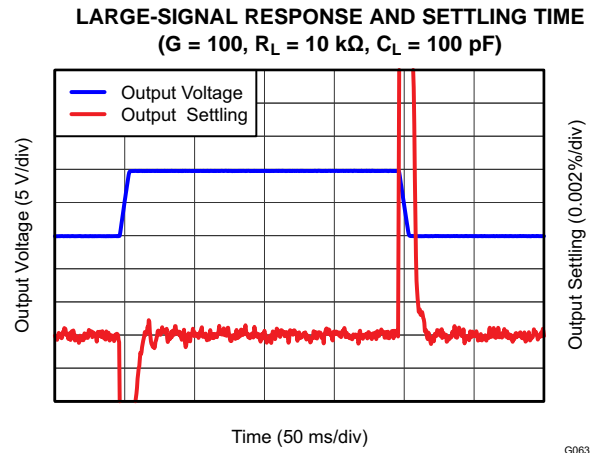

Figure 50.

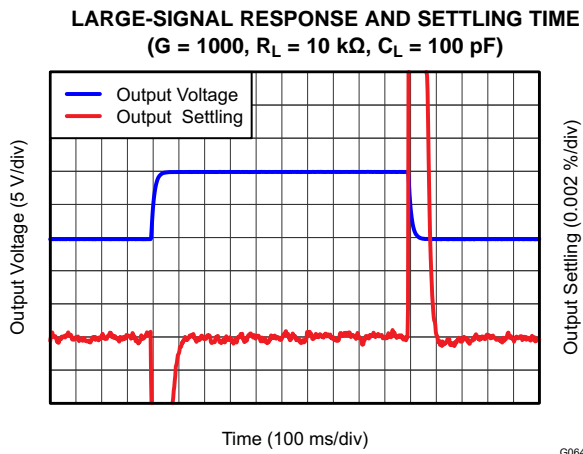

Figure 51.

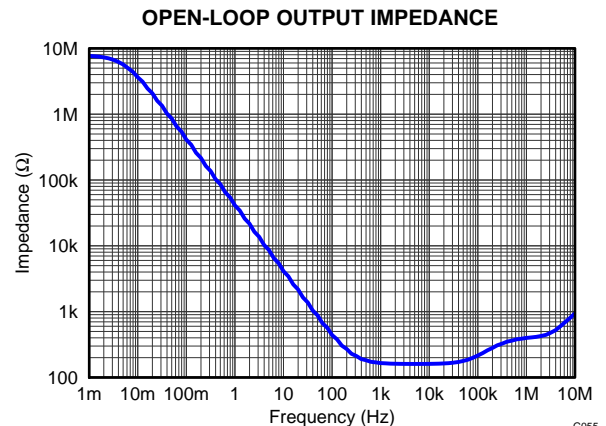

Figure 52.

TYPICAL CHARACTERISTICS (continued)

At $T_A = +25^\circ\text{C}$, $V_S = \pm 15\text{ V}$, $R_L = 10\text{ k}\Omega$, $V_{REF} = 0\text{ V}$, and $G = 5$, unless otherwise noted.

CHANGE IN INPUT OFFSET VOLTAGE vs WARM-UP TIME

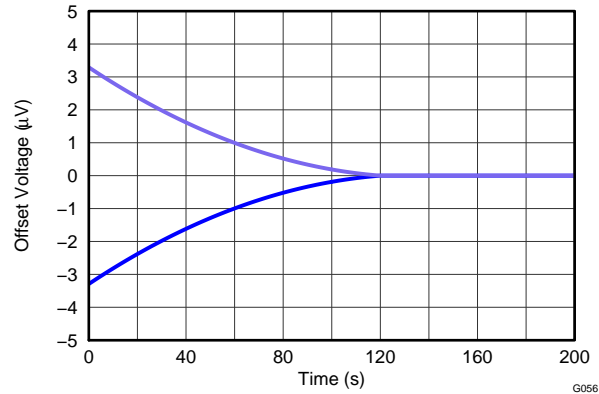
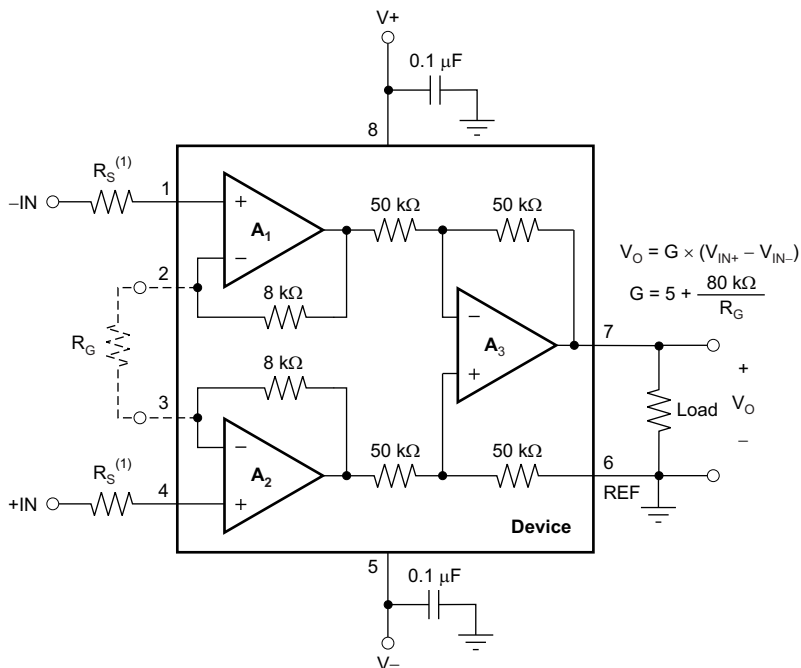

Figure 53.

APPLICATION INFORMATION

Figure 54 shows the basic connections required for device operation. Good layout practice mandates that bypass capacitors are placed as close to the device pins as possible.

The INA827 output is referred to the output reference (REF) terminal, which is normally grounded. This connection must be low-impedance to assure good common-mode rejection. Although 5 Ω or less of stray resistance can be tolerated while maintaining specified CMRR, small stray resistances of tens of ohms in series with the REF pin can cause noticeable degradation in CMRR.



(1) This resistor is optional if the input voltage remains above [(V-) - 2 V] or if the signal source current drive capability is limited to less than 3.5 mA. See the [Input Protection](#) section for more details.

Figure 54. Basic Connections

SETTING THE GAIN

Device gain is set by a single external resistor (R_G), connected between pins 2 and 3. The value of R_G is selected according to [Equation 1](#):

$$5 + \left(\frac{80 \text{ k}\Omega}{R_G} \right) \quad (1)$$

[Table 1](#) lists several commonly-used gains and resistor values. The on-chip resistors are laser-trimmed to accurate absolute values. The accuracy and temperature coefficients of these resistors are included in the gain accuracy and drift specifications of the INA827.

Table 1. Commonly-Used Gains and Resistor Values

DESIRED GAIN (V/V)	R_G (Ω)	NEAREST 1% R_G (Ω)
5	—	—
10	16.00k	15.8k
20	5.333k	5.36k
50	1.778k	1.78k
100	842.1	845
200	410.3	412
500	161.6	162
1000	80.40	80.6

Gain Drift

The stability and temperature drift of the external gain setting resistor (R_G) also affects gain. The R_G contribution to gain accuracy and drift can be directly inferred from the gain of [Equation 1](#).

The best gain drift of 1 ppm per degree Celsius can be achieved when the INA827 uses $G = 5$ without R_G connected. In this case, the gain drift is limited only by the slight temperature coefficient mismatch of the integrated 50-k Ω resistors in the differential amplifier (A_3). At gains greater than 5, the gain drift increases as a result of the individual drift of the resistors in the feedback of A_1 and A_2 , relative to the drift of the external gain resistor R_G . Process improvements to the temperature coefficient of the feedback resistors now enable a maximum gain drift of the feedback resistors to be specified at 35 ppm per degree Celsius, thus significantly improving the overall temperature stability of applications using gains greater than 5.

Low resistor values required for high gains can make wiring resistance important. Sockets add to wiring resistance and contribute additional gain error (such as possible unstable gain errors) at gains of approximately 100 or greater. To ensure stability, avoid parasitic capacitances greater than a few picofarads at R_G connections. Careful matching of any parasitics on both R_G pins maintains optimal CMRR over frequency; see the [Typical Characteristics](#).

OFFSET TRIMMING

Most applications require no external offset adjustment; however, if necessary, adjustments can be made by applying a voltage to the REF terminal. Figure 55 shows an optional circuit for trimming the output offset voltage. The voltage applied to the REF terminal is summed at the output. The op amp buffer provides low impedance at the REF terminal to preserve good common-mode rejection.

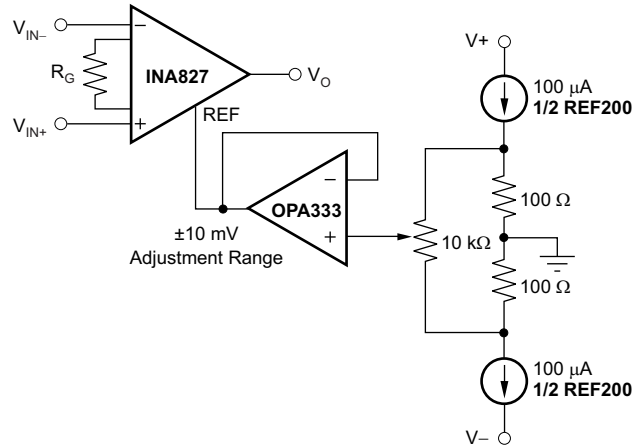

Figure 55. Optional Trimming of Output Offset Voltage

INPUT COMMON-MODE RANGE

The linear input voltage range of the INA827 input circuitry extends from the negative supply voltage to 1 V below the positive supply, while maintaining 88-dB (minimum) common-mode rejection throughout this range. The common-mode range for most common operating conditions is described in Figure 14 and Figure 35 through Figure 38. The INA827 can operate over a wide range of power supplies and V_{REF} configurations, thus making a comprehensive guide to common-mode range limits for all possible conditions impractical to provide.

The most commonly overlooked overload condition occurs when a circuit exceeds the output swing of A_1 and A_2 , which are internal circuit nodes that cannot be measured. Calculating the expected voltages at the output of A_1 and A_2 (see Figure 56) provides a check for the most common overload conditions. The A_1 and A_2 designs are identical and the outputs can swing to within approximately 100 mV of the power-supply rails. For example, when the A_2 output is saturated, A_1 may continue to be in linear operation and responding to changes in the noninverting input voltage. This difference may give the appearance of linear operation but the output voltage is invalid.

A single-supply instrumentation amplifier has special design considerations. To achieve a common-mode range that extends to single-supply ground, the INA827 employs a current-feedback topology with PNP input transistors; see Figure 56. The matched PNP transistors (Q_1 and Q_2) shift the input voltages of both inputs up by a diode drop and (through the feedback network) shift the output of A_1 and A_2 by approximately +0.8 V. With both inputs and V_{REF} at single-supply ground (negative power supply), the output of A_1 and A_2 is well within the linear range, allowing differential measurements to be made at the GND level. As a result of this input level-shifting, the voltages at pins 2 and 3 are not equal to the respective input terminal voltages (pins 1 and 4). For most applications, this inequality is not important because only the gain-setting resistor connects to these pins.

INSIDE THE INA827

Refer to [Figure 54](#) for a simplified representation of the INA827. A more detailed diagram (shown in [Figure 56](#)) provides additional insight into the INA827 operation.

Each input is protected by two field-effect transistors (FETs) that provide a low series resistance under normal signal conditions and preserve excellent noise performance. When excessive voltage is applied, these transistors limit input current to approximately 8 mA.

The differential input voltage is buffered by Q_1 and Q_2 and is applied across R_G , causing a signal current to flow through R_G , R_1 , and R_2 . The output difference amplifier (A_3) removes the common-mode component of the input signal and refers the output signal to the REF terminal.

The equations shown in [Figure 56](#) describe the output voltages of A_1 and A_2 . The V_{BE} and voltage drop across R_1 and R_2 produce output voltages on A_1 and A_2 that are approximately 0.8 V higher than the input voltages.

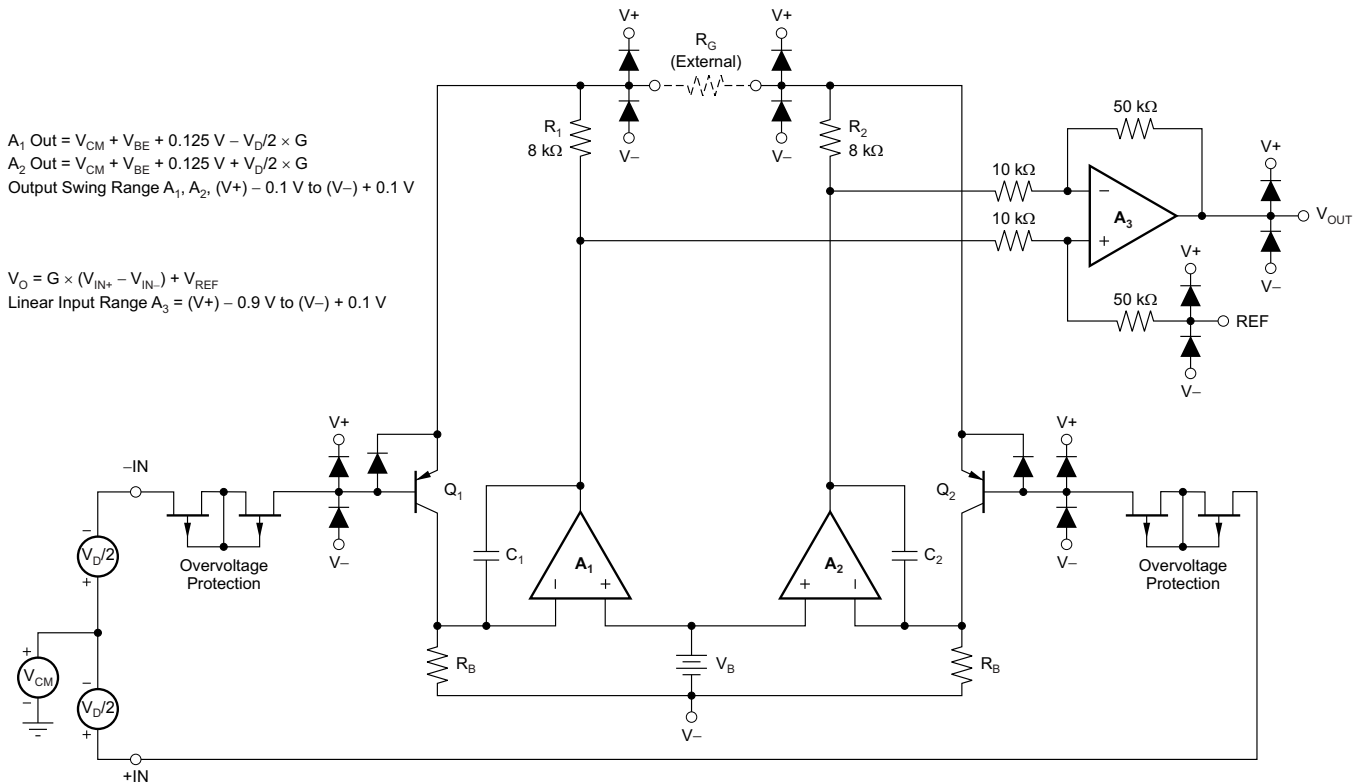

Figure 56. INA827 Simplified Circuit Diagram

INPUT PROTECTION

The INA827 inputs are individually protected for voltages up to $\pm 40 \text{ V}$. For example, a condition of -40 V on one input and $+40 \text{ V}$ on the other input does not cause damage. However, if the input voltage exceeds $[(V-) - 2 \text{ V}]$ and the signal source current drive capability exceeds 3.5 mA , the output voltage switches to the opposite polarity; see [Figure 14](#). This polarity reversal can easily be avoided by adding a $10\text{-k}\Omega$ resistance in series with both inputs.

Internal circuitry on each input provides low series impedance under normal signal conditions. If the input is overloaded, the protection circuitry limits the input current to a safe value of approximately 8 mA . [Figure 14](#) illustrates this input current limit behavior. The inputs are protected even if the power supplies are disconnected or turned off.

INPUT BIAS CURRENT RETURN PATH

The INA827 input impedance is extremely high—approximately 20 G Ω . However, a path must be provided for the input bias current of both inputs. This input bias current is typically 35 nA. High input impedance means that this input bias current changes very little with varying input voltage.

Input circuitry must provide a path for this input bias current for proper operation. [Figure 57](#) shows various provisions for an input bias current path. Without a bias current path, the inputs float to a potential that exceeds the INA827 common-mode range, and the input amplifiers saturate. If the differential source resistance is low, the bias current return path can be connected to one input (as shown in the thermocouple example in [Figure 57](#)). With higher source impedance, using two equal resistors provides a balanced input with possible advantages of lower input offset voltage as a result of bias current and better high-frequency common-mode rejection.

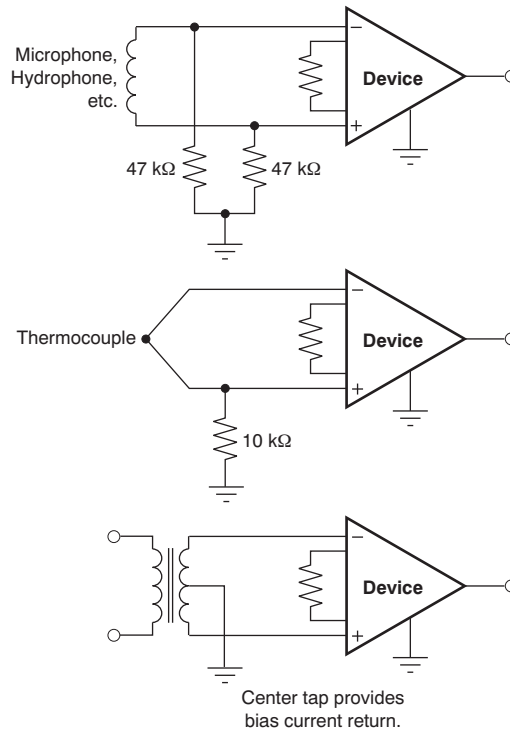

Figure 57. Providing an Input Common-Mode Current Path

REFERENCE TERMINAL

The INA827 output voltage is developed with respect to the voltage on the reference terminal. Often, in dual-supply operation, the reference pin (pin 6) is connected to the low-impedance system ground. Offsetting the output signal to a precise mid-supply level (for example, 2.5 V in a 5-V supply environment) can be useful in single-supply operation. The signal can be shifted by applying a voltage to the device REF pin, which can be useful when driving a single-supply ADC.

For best performance, any source impedance to the REF terminal should be kept below 5 Ω . Referring to [Figure 54](#), the reference resistor is at one end of a 50-k Ω resistor. Additional impedance at the REF pin adds to this 50-k Ω resistor. The imbalance in resistor ratios results in degraded common-mode rejection ratio (CMRR).

[Figure 58](#) shows two different methods of driving the reference pin with low impedance. The [OPA330](#) is a low-power, chopper-stabilized amplifier and therefore offers excellent stability over temperature. The OPA330 is available in the space-saving SC70 and even smaller chip-scale package. The [REF3225](#) is a precision reference in a small SOT23-6 package.

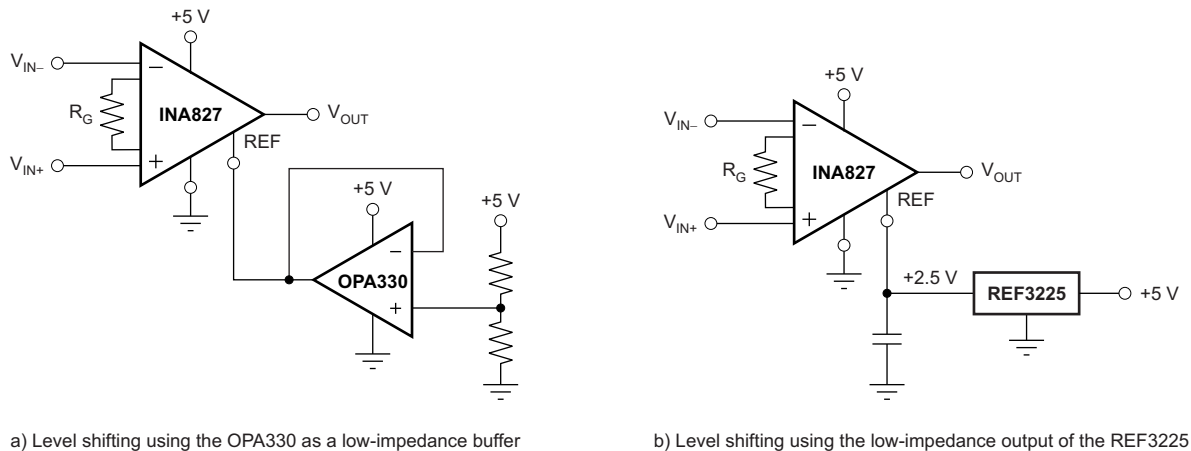

Figure 58. Options for Low-Impedance Level Shifting

DYNAMIC PERFORMANCE

[Figure 19](#) illustrates that, despite having low quiescent current of only 200 μ A, the INA827 achieves much wider bandwidth than other instrumentation amplifiers (INAs) in its class. This achievement is a result of using TI's proprietary high-speed precision bipolar process technology. The current-feedback topology provides the INA827 with wide bandwidth even at high gains. Settling time also remains excellent at high gain because of a 1.5-V/ μ s high slew rate.

OPERATING VOLTAGE

The INA827 operates over a power-supply range of +2.7 V to +36 V (± 1.35 V to ± 18 V). Supply voltages higher than 40 V (± 20 V) can permanently damage the device. Parameters that vary over supply voltage or temperature are shown in the [Typical Characteristics](#) section.

Low-Voltage Operation

The INA827 can operate on power supplies as low as ± 1.35 V. Most parameters vary only slightly throughout this supply voltage range; see the [Typical Characteristics](#) section. Operation at very low supply voltage requires careful attention to assure that the input voltages remain within the linear range. Voltage swing requirements of the internal nodes limit the input common-mode range with low power-supply voltage. [Figure 7](#) to [Figure 13](#) and [Figure 35](#) to [Figure 38](#) describe the linear operation range for various supply voltages, reference connections, and gains.

ERROR SOURCES

Most modern signal-conditioning systems calibrate errors at room temperature. However, calibration of errors that result from a change in temperature is normally difficult and costly. Therefore, it is important to minimize these errors by choosing high-precision components such as the INA827 that have improved specifications in critical areas that impact overall system precision. [Figure 59](#) shows an example application.

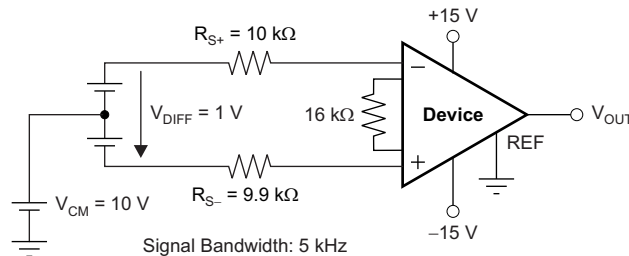

Figure 59. Example Application with $G = 10$ V/V and 1-V Differential Voltage

Resistor-adjustable INAs such as the INA827 yield the lowest gain error at $G = 5$ because of the inherently well-matched drift of the internal resistors of the differential amplifier. At gains greater than 5 (for instance, $G = 10$ V/V or $G = 100$ V/V) gain error becomes a significant error source because of the resistor drift contribution of the feedback resistors in conjunction with the external gain resistor. Except for very high gain applications, gain drift is by far the largest error contributor compared to other drift errors (such as offset drift). The INA827 offers the lowest gain error over temperature in the marketplace for both $G > 5$ and $G = 5$ (no external gain resistor). [Table 2](#) summarizes the major error sources in common INA applications and compares the two cases of $G = 5$ (no external resistor) and $G = 10$ (with a 16-k Ω external resistor). As can be seen in [Table 2](#), while the static errors (absolute accuracy errors) in $G = 5$ are almost twice as great as compared to $G = 10$, there is a great reduction in drift errors because of the significantly lower gain error drift. In most applications, these static errors can readily be removed during calibration in production. All calculations refer the error to the input for easy comparison and system evaluation.

Table 2. Error Calculation

ERROR SOURCE	ERROR CALCULATION	INA827		
		SPECIFICATION	G = 10 ERROR (ppm)	G = 1 ERROR (ppm)
ABSOLUTE ACCURACY AT +25°C				
Input offset voltage (μ V)	V_{OSI} / V_{DIFF}	150	150	150
Output offset voltage (μ V)	$V_{OSO} / (G \times V_{DIFF})$	2000	200	400
Input offset current (nA)	$I_{OS} \times \text{maximum}(R_{S+}, R_{S-}) / V_{DIFF}$	5	50	50
CMRR (dB)	$V_{CM} / (10^{CMRR/20} \times V_{DIFF})$	94 (G = 10), 88 (G = 5)	200	398
Total absolute accuracy error (ppm)			600	998
DRIFT TO +105°C				
Gain drift (ppm/°C)	$GTC \times (T_A - 25)$	25 (G = 10), 1 (G = 5)	2000	80
Input offset voltage drift (μ V/°C)	$(V_{OSI_TC} / V_{DIFF}) \times (T_A - 25)$	5	200	200
Output offset voltage drift (μ V/°C)	$[V_{OSO_TC} / (G \times V_{DIFF})] \times (T_A - 25)$	30	240	240
Total drift error (ppm)			2440	760
RESOLUTION				
Gain nonlinearity (ppm of FS)		5	5	5
Voltage noise (1 kHz)	$\sqrt{BW} \times \sqrt{(e_{NI}^2 + \left[\frac{e_{NO}}{G}\right]^2)} \times \frac{6}{V_{DIFF}}$	$e_{NI} = 17$ $e_{NO} = 250$	6	6
Total resolution error (ppm)			11	11
TOTAL ERROR				
Total error	Total error = sum of all error sources		3051	1769

LAYOUT GUIDELINES

Attention to good layout practices is always recommended. Keep traces short and, when possible, use a printed circuit board (PCB) ground plane with surface-mount components placed as close to the device pins as possible. Place 0.1- μ F bypass capacitors close to the supply pins. These guidelines should be applied throughout the analog circuit to improve performance and provide benefits such as reducing the electromagnetic-interference (EMI) susceptibility.

CMRR vs Frequency

The INA827 pinout has been optimized for achieving maximum CMRR performance over a wide range of frequencies. However, care must be taken to ensure that both input paths are well-matched for source impedance and capacitance to avoid converting common-mode signals into differential signals. In addition, parasitic capacitance at the gain-setting pins can also affect CMRR over frequency. For example, in applications that implement gain switching using switches or PhotoMOS[®] relays to change the value of R_G , the component should be chosen so that the switch capacitance is as small as possible.

APPLICATION EXAMPLE

Programmable Logic Controller (PLC) Input

An example programmable logic controller (PLC) input application using an INA827 is shown in [Figure 60](#).

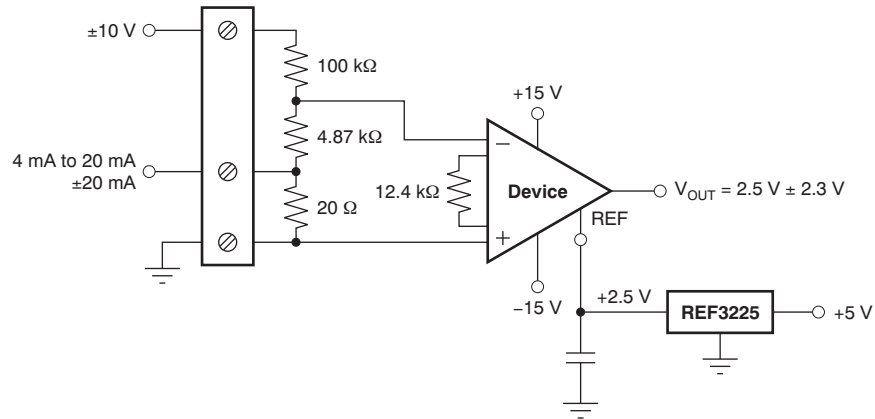

Figure 60. $\pm 10\text{-V}$, 4-mA to 20-mA PLC Input

PACKAGING INFORMATION

Orderable Device	Status ⁽¹⁾	Package Type	Package Drawing	Pins	Package Qty	Eco Plan ⁽²⁾	Lead/ Ball Finish	MSL Peak Temp ⁽³⁾	Samples (Requires Login)
INA827AIDGK	ACTIVE	VSSOP	DGK	8	80	Green (RoHS & no Sb/Br)	CU NIPDAUAG	Level-2-260C-1 YEAR	
INA827AIDGKR	ACTIVE	VSSOP	DGK	8	2500	Green (RoHS & no Sb/Br)	CU NIPDAUAG	Level-2-260C-1 YEAR	

⁽¹⁾ The marketing status values are defined as follows:

ACTIVE: Product device recommended for new designs.

LIFEBUY: TI has announced that the device will be discontinued, and a lifetime-buy period is in effect.

NRND: Not recommended for new designs. Device is in production to support existing customers, but TI does not recommend using this part in a new design.

PREVIEW: Device has been announced but is not in production. Samples may or may not be available.

OBsolete: TI has discontinued the production of the device.

⁽²⁾ Eco Plan - The planned eco-friendly classification: Pb-Free (RoHS), Pb-Free (RoHS Exempt), or Green (RoHS & no Sb/Br) - please check <http://www.ti.com/productcontent> for the latest availability information and additional product content details.

TBD: The Pb-Free/Green conversion plan has not been defined.

Pb-Free (RoHS): TI's terms "Lead-Free" or "Pb-Free" mean semiconductor products that are compatible with the current RoHS requirements for all 6 substances, including the requirement that lead not exceed 0.1% by weight in homogeneous materials. Where designed to be soldered at high temperatures, TI Pb-Free products are suitable for use in specified lead-free processes.

Pb-Free (RoHS Exempt): This component has a RoHS exemption for either 1) lead-based flip-chip solder bumps used between the die and package, or 2) lead-based die adhesive used between the die and leadframe. The component is otherwise considered Pb-Free (RoHS compatible) as defined above.

Green (RoHS & no Sb/Br): TI defines "Green" to mean Pb-Free (RoHS compatible), and free of Bromine (Br) and Antimony (Sb) based flame retardants (Br or Sb do not exceed 0.1% by weight in homogeneous material)

⁽³⁾ MSL, Peak Temp. -- The Moisture Sensitivity Level rating according to the JEDEC industry standard classifications, and peak solder temperature.

Important Information and Disclaimer: The information provided on this page represents TI's knowledge and belief as of the date that it is provided. TI bases its knowledge and belief on information provided by third parties, and makes no representation or warranty as to the accuracy of such information. Efforts are underway to better integrate information from third parties. TI has taken and continues to take reasonable steps to provide representative and accurate information but may not have conducted destructive testing or chemical analysis on incoming materials and chemicals. TI and TI suppliers consider certain information to be proprietary, and thus CAS numbers and other limited information may not be available for release.

In no event shall TI's liability arising out of such information exceed the total purchase price of the TI part(s) at issue in this document sold by TI to Customer on an annual basis.

TAPE AND REEL INFORMATION

REEL DIMENSIONS

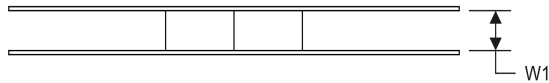
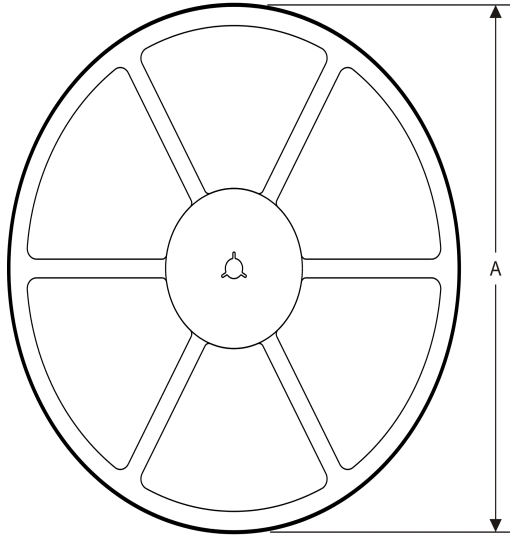

TAPE DIMENSIONS

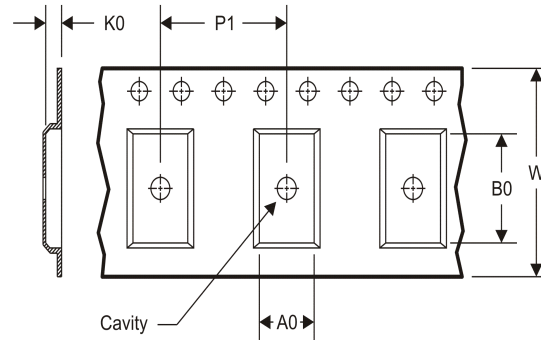

A0	Dimension designed to accommodate the component width
B0	Dimension designed to accommodate the component length
K0	Dimension designed to accommodate the component thickness
W	Overall width of the carrier tape
P1	Pitch between successive cavity centers

TAPE AND REEL INFORMATION

*All dimensions are nominal

Device	Package Type	Package Drawing	Pins	SPQ	Reel Diameter (mm)	Reel Width W1 (mm)	A0 (mm)	B0 (mm)	K0 (mm)	P1 (mm)	W (mm)	Pin1 Quadrant
INA827AIDGKR	VSSOP	DGK	8	2500	330.0	12.4	5.3	3.4	1.4	8.0	12.0	Q1

TAPE AND REEL BOX DIMENSIONS



*All dimensions are nominal

Device	Package Type	Package Drawing	Pins	SPQ	Length (mm)	Width (mm)	Height (mm)
INA827AIDGKR	VSSOP	DGK	8	2500	366.0	364.0	50.0

DGK (S-PDSO-G8)

PLASTIC SMALL-OUTLINE PACKAGE



- NOTES:
- A. All linear dimensions are in millimeters.
 - B. This drawing is subject to change without notice.
 - C. Body length does not include mold flash, protrusions, or gate burrs. Mold flash, protrusions, or gate burrs shall not exceed 0.15 per end.
 - D. Body width does not include interlead flash. Interlead flash shall not exceed 0.50 per side.
 - E. Falls within JEDEC MO-187 variation AA, except interlead flash.

IMPORTANT NOTICE

Texas Instruments Incorporated and its subsidiaries (TI) reserve the right to make corrections, enhancements, improvements and other changes to its semiconductor products and services per JESD46C and to discontinue any product or service per JESD48B. Buyers should obtain the latest relevant information before placing orders and should verify that such information is current and complete. All semiconductor products (also referred to herein as "components") are sold subject to TI's terms and conditions of sale supplied at the time of order acknowledgment.

TI warrants performance of its components to the specifications applicable at the time of sale, in accordance with the warranty in TI's terms and conditions of sale of semiconductor products. Testing and other quality control techniques are used to the extent TI deems necessary to support this warranty. Except where mandated by applicable law, testing of all parameters of each component is not necessarily performed.

TI assumes no liability for applications assistance or the design of Buyers' products. Buyers are responsible for their products and applications using TI components. To minimize the risks associated with Buyers' products and applications, Buyers should provide adequate design and operating safeguards.

TI does not warrant or represent that any license, either express or implied, is granted under any patent right, copyright, mask work right, or other intellectual property right relating to any combination, machine, or process in which TI components or services are used. Information published by TI regarding third-party products or services does not constitute a license to use such products or services or a warranty or endorsement thereof. Use of such information may require a license from a third party under the patents or other intellectual property of the third party, or a license from TI under the patents or other intellectual property of TI.

Reproduction of significant portions of TI information in TI data books or data sheets is permissible only if reproduction is without alteration and is accompanied by all associated warranties, conditions, limitations, and notices. TI is not responsible or liable for such altered documentation. Information of third parties may be subject to additional restrictions.

Resale of TI components or services with statements different from or beyond the parameters stated by TI for that component or service voids all express and any implied warranties for the associated TI component or service and is an unfair and deceptive business practice. TI is not responsible or liable for any such statements.

Buyer acknowledges and agrees that it is solely responsible for compliance with all legal, regulatory and safety-related requirements concerning its products, and any use of TI components in its applications, notwithstanding any applications-related information or support that may be provided by TI. Buyer represents and agrees that it has all the necessary expertise to create and implement safeguards which anticipate dangerous consequences of failures, monitor failures and their consequences, lessen the likelihood of failures that might cause harm and take appropriate remedial actions. Buyer will fully indemnify TI and its representatives against any damages arising out of the use of any TI components in safety-critical applications.

In some cases, TI components may be promoted specifically to facilitate safety-related applications. With such components, TI's goal is to help enable customers to design and create their own end-product solutions that meet applicable functional safety standards and requirements. Nonetheless, such components are subject to these terms.

No TI components are authorized for use in FDA Class III (or similar life-critical medical equipment) unless authorized officers of the parties have executed a special agreement specifically governing such use.

Only those TI components which TI has specifically designated as military grade or "enhanced plastic" are designed and intended for use in military/aerospace applications or environments. Buyer acknowledges and agrees that any military or aerospace use of TI components which have **not** been so designated is solely at the Buyer's risk, and that Buyer is solely responsible for compliance with all legal and regulatory requirements in connection with such use.

TI has specifically designated certain components which meet ISO/TS16949 requirements, mainly for automotive use. Components which have not been so designated are neither designed nor intended for automotive use; and TI will not be responsible for any failure of such components to meet such requirements.

Products

Audio	www.ti.com/audio
Amplifiers	amplifier.ti.com
Data Converters	dataconverter.ti.com
DLP® Products	www.dlp.com
DSP	dsp.ti.com
Clocks and Timers	www.ti.com/clocks
Interface	interface.ti.com
Logic	logic.ti.com
Power Mgmt	power.ti.com
Microcontrollers	microcontroller.ti.com
RFID	www.ti-rfid.com
OMAP Mobile Processors	www.ti.com/omap
Wireless Connectivity	www.ti.com/wirelessconnectivity

Applications

Automotive and Transportation	www.ti.com/automotive
Communications and Telecom	www.ti.com/communications
Computers and Peripherals	www.ti.com/computers
Consumer Electronics	www.ti.com/consumer-apps
Energy and Lighting	www.ti.com/energy
Industrial	www.ti.com/industrial
Medical	www.ti.com/medical
Security	www.ti.com/security
Space, Avionics and Defense	www.ti.com/space-avionics-defense
Video and Imaging	www.ti.com/video

TI E2E Community e2e.ti.com



**Стандарт
Электрон
Связь**

Мы молодая и активно развивающаяся компания в области поставок электронных компонентов. Мы поставляем электронные компоненты отечественного и импортного производства напрямую от производителей и с крупнейших складов мира.

Благодаря сотрудничеству с мировыми поставщиками мы осуществляем комплексные и плановые поставки широчайшего спектра электронных компонентов.

Собственная эффективная логистика и склад в обеспечивает надежную поставку продукции в точно указанные сроки по всей России.

Мы осуществляем техническую поддержку нашим клиентам и предпродажную проверку качества продукции. На все поставляемые продукты мы предоставляем гарантию .

Осуществляем поставки продукции под контролем ВП МО РФ на предприятия военно-промышленного комплекса России , а также работаем в рамках 275 ФЗ с открытием отдельных счетов в уполномоченном банке. Система менеджмента качества компании соответствует требованиям ГОСТ ISO 9001.

Минимальные сроки поставки, гибкие цены, неограниченный ассортимент и индивидуальный подход к клиентам являются основой для выстраивания долгосрочного и эффективного сотрудничества с предприятиями радиоэлектронной промышленности, предприятиями ВПК и научно-исследовательскими институтами России.

С нами вы становитесь еще успешнее!

Наши контакты:

Телефон: +7 812 627 14 35

Электронная почта: sales@st-electron.ru

Адрес: 198099, Санкт-Петербург,
Промышленная ул, дом № 19, литера Н,
помещение 100-Н Офис 331