

MOC215-M

MOC216-M

MOC217-M

DESCRIPTION

These devices consist of a gallium arsenide infrared emitting diode optically coupled to a monolithic silicon phototransistor detector, in a surface mountable, small outline, plastic package. They are ideally suited for high density applications, and eliminate the need for through-the-board mounting.

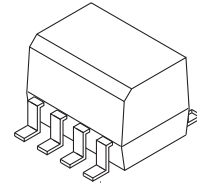

FEATURES

- UL Recognized (File #E90700, Volume 2)
- VDE Recognized (File #13616) (add option "V" for VDE approval, i.e., MOC215V-M)
- Convenient Plastic SOIC-8 Surface Mountable Package Style
- Low LED Input Current Required, for Easier Logic Interfacing
- Standard SOIC-8 Footprint, with 0.050" Lead Spacing
- Compatible with Dual Wave, Vapor Phase and IR Reflow Soldering
- High Input-Output Isolation of 2500 Vac (rms) Guaranteed

APPLICATIONS

- Low power Logic Circuits
- Interfacing and coupling systems of different potentials and impedances
- Telecommunications equipment
- Portable electronics

Marking Information:

- MOC215-M = 215
- MOC216-M = 216
- MOC217-M = 217

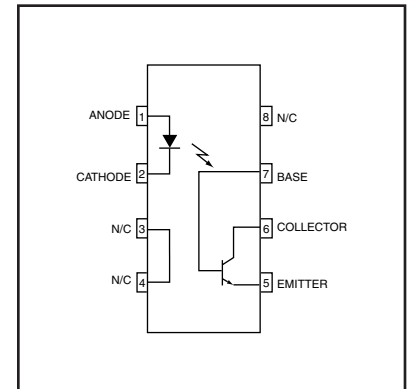

MOC215-M

MOC216-M

MOC217-M

ABSOLUTE MAXIMUM RATINGS ($T_A = 25^\circ\text{C}$ Unless otherwise specified)			
Rating	Symbol	Value	Unit
EMITTER			
Forward Current - Continuous	I_F	60	mA
Forward Current - Peak (PW = 100 μs , 120 pps)	I_F (pk)	1.0	A
Reverse Voltage	V_R	6.0	V
LED Power Dissipation @ $T_A = 25^\circ\text{C}$ Derate above 25°C	P_D	90 0.8	mW mW/ $^\circ\text{C}$
DETECTOR			
Collector-Emitter Voltage	V_{CEO}	30	V
Collector-Base Voltage	V_{CBO}	70	V
Emitter-Collector Voltage	V_{ECO}	7.0	V
Collector Current-Continuous	I_C	150	mA
Detector Power Dissipation @ $T_A = 25^\circ\text{C}$ Derate above 25°C	P_D	150 1.76	mW mW/ $^\circ\text{C}$
TOTAL DEVICE			
Input-Output Isolation Voltage ^(1,2) (60 Hz, 1 minute duration)	V_{ISO}	2500	Vac(rms)
Total Device Power Dissipation @ $T_A = 25^\circ\text{C}$ Derate above 25°C	P_D	250 2.94	mW mW/ $^\circ\text{C}$
Ambient Operating Temperature Range	T_A	-40 to +100	$^\circ\text{C}$
Storage Temperature Range	T_{stg}	-40 to +125	$^\circ\text{C}$

MOC215-M

MOC216-M

MOC217-M

ELECTRICAL CHARACTERISTICS ($T_A = 25^\circ\text{C}$ Unless otherwise specified)						
Characteristic		Symbol	Min	Typ**	Max	Unit
EMITTER						
Forward Voltage	($I_F = 1.0\text{ mA}$)	V_F	—	1.07	1.3	V
Reverse Leakage Current	($V_R = 6.0\text{ V}$)	I_R	—	0.001	100	μA
Capacitance		C	—	18	—	pF
DETECTOR						
Collector-Emitter Dark Current	($V_{CE} = 5.0\text{ V}, T_A = 25^\circ\text{C}$)	I_{CEO}	—	1.0	50	nA
	($V_{CE} = 5.0\text{ V}, T_A = 100^\circ\text{C}$)		—	1.0	—	μA
Collector-Emitter Breakdown Voltage	($I_C = 100\ \mu\text{A}$)	BV_{CEO}	30	100	—	V
Emitter-Collector Breakdown Voltage	($I_E = 100\ \mu\text{A}$)	BV_{ECO}	7.0	10	—	V
Collector-Emitter Capacitance	($f = 1.0\text{ MHz}, V_{CE} = 0$)	C_{CE}	—	7.0	—	pF
COUPLED						
Output Collector Current ⁽⁴⁾	MOC215-M MOC216-M MOC217-M	I_C	20 50 100	— — —	— — —	%
	($I_F = 1.0\text{ mA}, V_{CE} = 5.0\text{ V}$)					
Collector-Emitter Saturation Voltage	($I_C = 100\ \mu\text{A}, I_F = 1.0\text{ mA}$)					
Turn-On Time	($I_C = 2.0\text{ mA}, V_{CC} = 10\text{ V}, R_L = 100\ \Omega$, fig. 10)	t_{on}	—	4.0	—	μs
Turn-Off Time	($I_C = 2.0\text{ mA}, V_{CC} = 10\text{ V}, R_L = 100\ \Omega$, fig. 10)	t_{off}	—	4.0	—	μs
Rise Time	($I_C = 2.0\text{ mA}, V_{CC} = 10\text{ V}, R_L = 100\ \Omega$, fig. 10)	t_r	—	3.0	—	μs
Fall Time	($I_C = 2.0\text{ mA}, V_{CC} = 10\text{ V}, R_L = 100\ \Omega$, fig. 10)	t_f	—	3.0	—	μs
Input-Output Isolation Voltage ^(1,2,3)	($f = 60\text{ Hz}, t = 1.0\text{ min.}$)	V_{ISO}	2500	—	—	Vac(rms)
Isolation Resistance ⁽²⁾	($V_{I-O} = 500\text{ V}$)	R_{ISO}	10^{11}	—	—	Ω
Isolation Capacitance ⁽²⁾	($V_{I-O} = 0, f = 1.0\text{ MHz}$)	C_{ISO}	—	0.2	—	pF

** Typical values at $T_A = 25^\circ\text{C}$ unless otherwise noted.

1. Input-Output Isolation Surge Voltage, V_{ISO} , is an internal device dielectric breakdown rating.
2. For this test, Pins 1 and 2 are common and Pins 5, 6 and 7 are common.
3. V_{ISO} rating of 2,500 $V_{AC(RMS)}$ for $t = 1$ minute is equivalent to a rating of 3,000 $V_{AC(RMS)}$ for $t = 1$ second.
4. Current Transfer Ratio (CTR) = $I_C/I_F \times 100\%$.

MOC215-M

MOC216-M

MOC217-M

Fig. 1 LED Forward Voltage vs. Forward Current

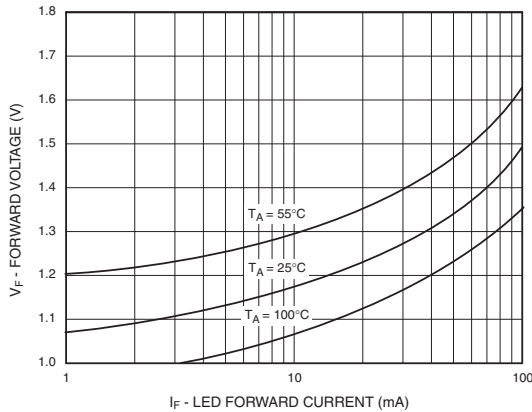

Fig. 2 Output Current vs. Input Current

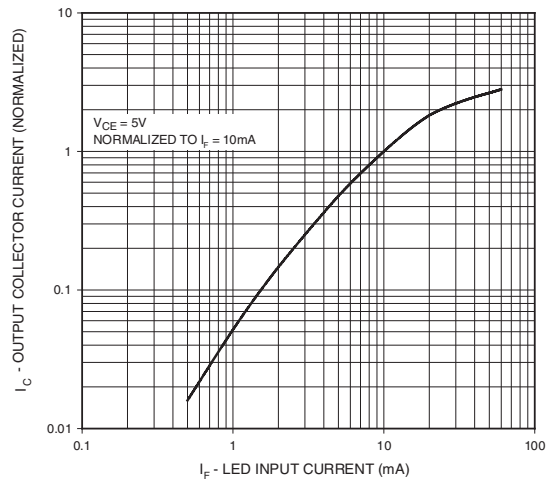

Fig. 3 Output Current vs. Ambient Temperature

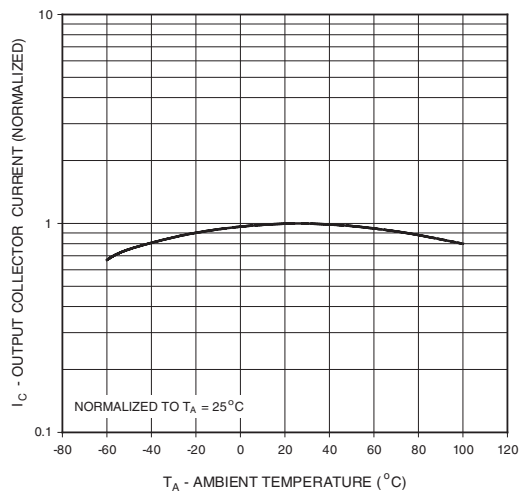

Fig. 4 Output Current vs. Collector - Emitter Voltage

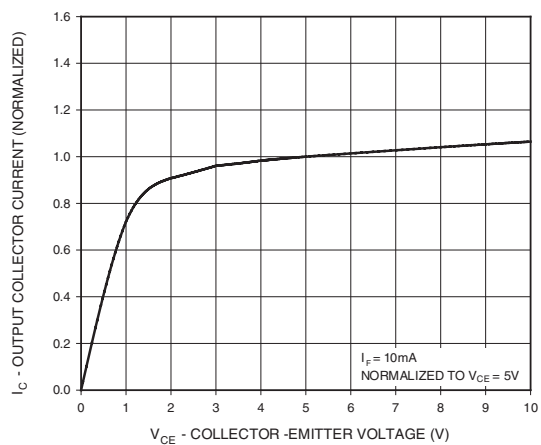

Fig. 5 Dark Current vs. Ambient Temperature

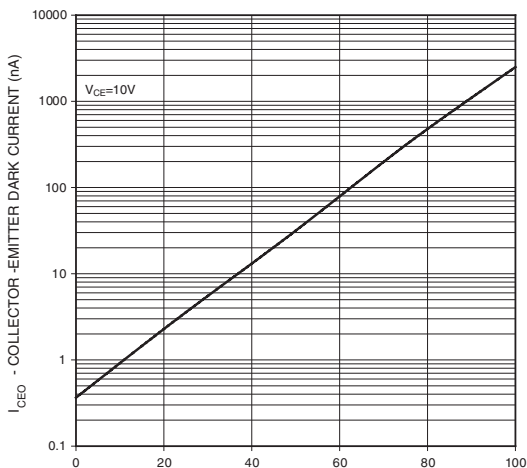
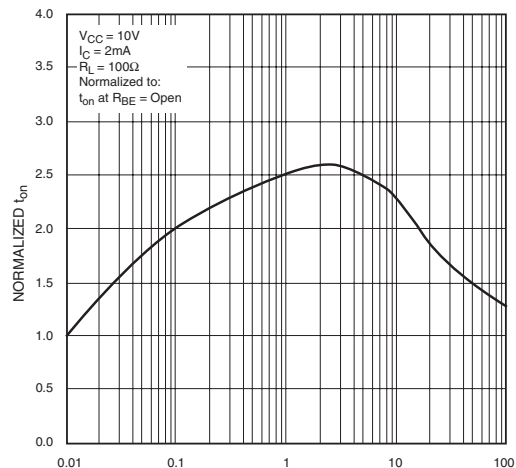

Fig. 6 Normalized t_{on} vs. R_{BE}



MOC215-M

MOC216-M

MOC217-M

Fig. 7 Normalized t_{off} vs. R_{BE}

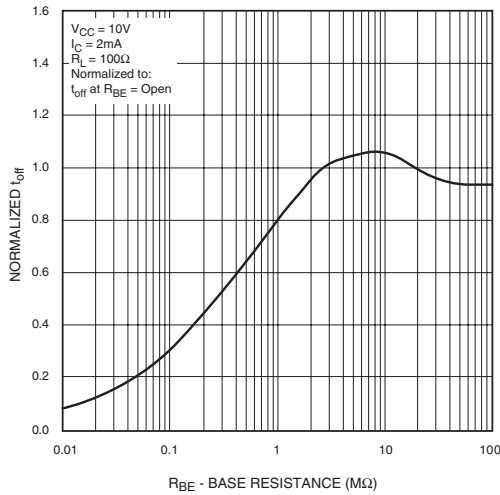

Fig. 8 CTR vs. R_{BE} (Saturated)

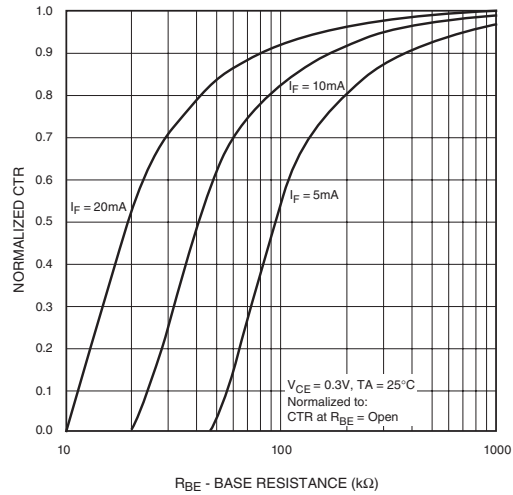
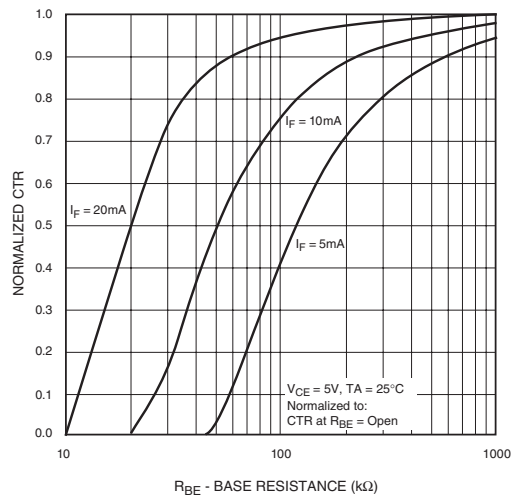

Fig. 9 CTR vs. R_{BE} (Unsaturated)



MOC215-M

MOC216-M

MOC217-M

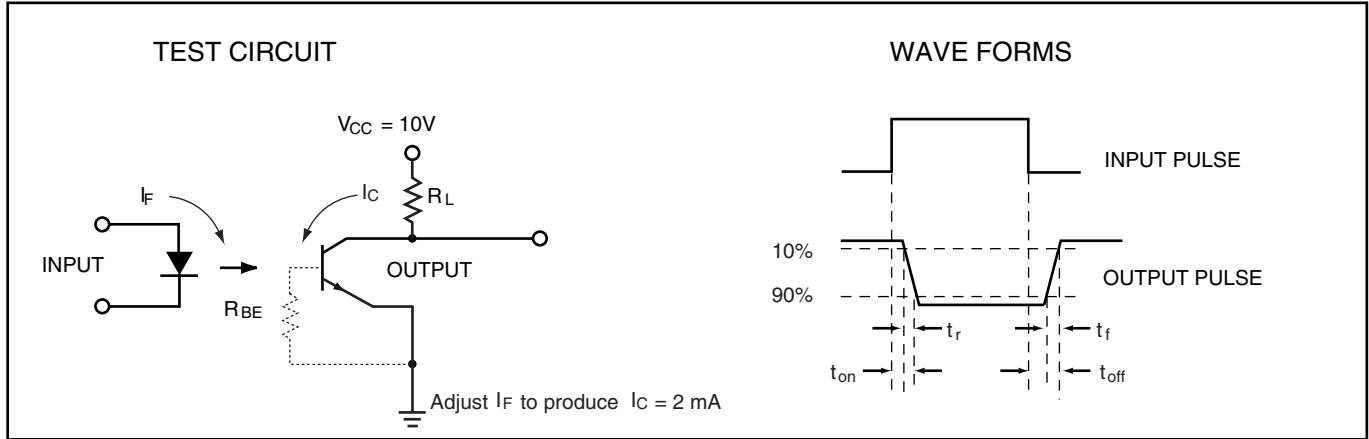
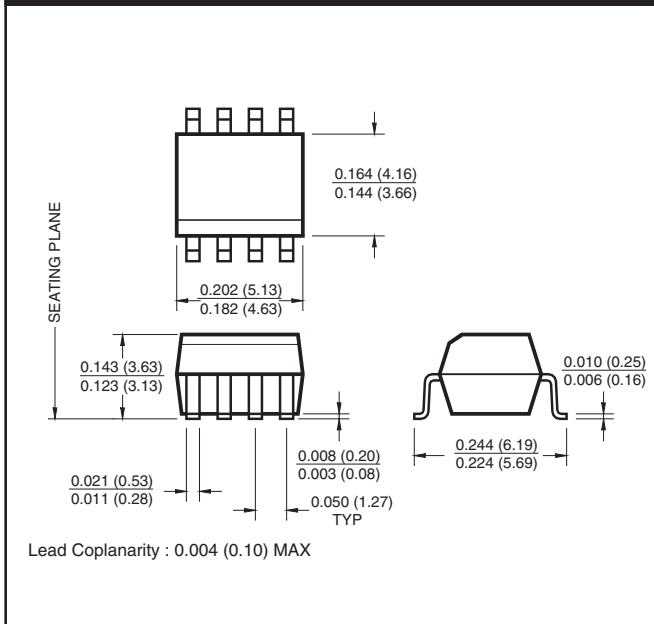
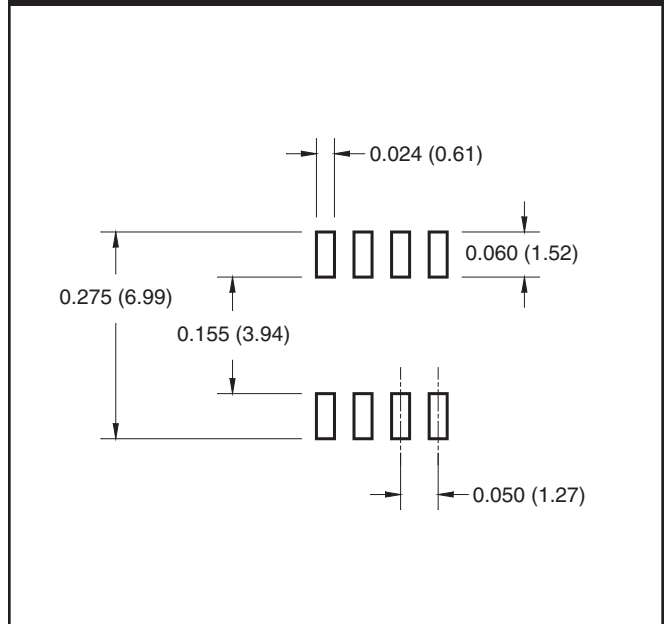

Figure 10. Switching Time Test Circuit and Waveforms

Package Dimensions (Surface Mount)



8-Pin Small Outline



MOC215-M

MOC216-M

MOC217-M

ORDERING INFORMATION

Option	Order Entry Identifier	Description
V	V	VDE 0084
R1	R1	Tape and reel (500 units per reel)
R1V	R1V	VDE 0884, Tape and reel (500 units per reel)
R2	R2	Tape and reel (2500 units per reel)
R2V	R2V	VDE 0884, Tape and reel (2500 units per reel)

MARKING INFORMATION

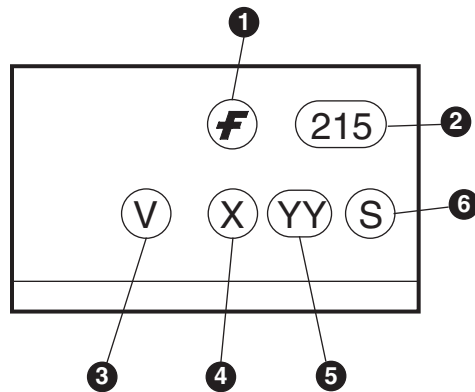

Definitions	
1	Fairchild logo
2	Device number
3	VDE mark (Note: Only appears on parts ordered with VDE option – See order entry table)
4	One digit year code, e.g., '3'
5	Two digit work week ranging from '01' to '53'
6	Assembly package code

MOC215-M

MOC216-M

MOC217-M

Carrier Tape Specifications

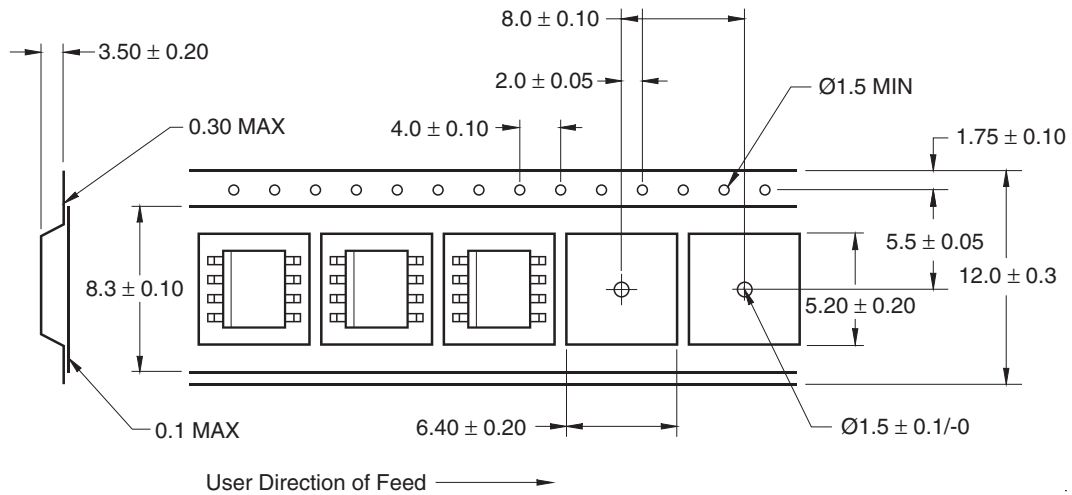

Reflow Profile

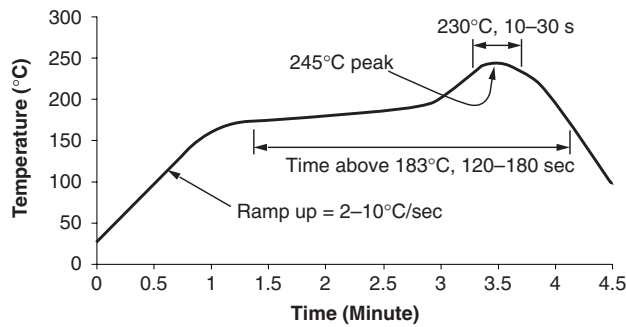

- Peak reflow temperature: 245°C (package surface temperature)
- Time of temperature higher than 183°C for 120-180 seconds
- One time soldering reflow is recommended

MOC215-M

MOC216-M

MOC217-M

DISCLAIMER

FAIRCHILD SEMICONDUCTOR RESERVES THE RIGHT TO MAKE CHANGES WITHOUT FURTHER NOTICE TO ANY PRODUCTS HEREIN TO IMPROVE RELIABILITY, FUNCTION OR DESIGN. FAIRCHILD DOES NOT ASSUME ANY LIABILITY ARISING OUT OF THE APPLICATION OR USE OF ANY PRODUCT OR CIRCUIT DESCRIBED HEREIN; NEITHER DOES IT CONVEY ANY LICENSE UNDER ITS PATENT RIGHTS, NOR THE RIGHTS OF OTHERS.

LIFE SUPPORT POLICY

FAIRCHILD'S PRODUCTS ARE NOT AUTHORIZED FOR USE AS CRITICAL COMPONENTS IN LIFE SUPPORT DEVICES OR SYSTEMS WITHOUT THE EXPRESS WRITTEN APPROVAL OF THE PRESIDENT OF FAIRCHILD SEMICONDUCTOR CORPORATION. As used herein:

1. Life support devices or systems are devices or systems which, (a) are intended for surgical implant into the body, or (b) support or sustain life, and (c) whose failure to perform when properly used in accordance with instructions for use provided in the labeling, can be reasonably expected to result in a significant injury of the user.
2. A critical component in any component of a life support device or system whose failure to perform can be reasonably expected to cause the failure of the life support device or system, or to affect its safety or effectiveness.



Стандарт Электрон Связь

Мы молодая и активно развивающаяся компания в области поставок электронных компонентов. Мы поставляем электронные компоненты отечественного и импортного производства напрямую от производителей и с крупнейших складов мира.

Благодаря сотрудничеству с мировыми поставщиками мы осуществляем комплексные и плановые поставки широчайшего спектра электронных компонентов.

Собственная эффективная логистика и склад в обеспечивает надежную поставку продукции в точно указанные сроки по всей России.

Мы осуществляем техническую поддержку нашим клиентам и предпродажную проверку качества продукции. На все поставляемые продукты мы предоставляем гарантию .

Осуществляем поставки продукции под контролем ВП МО РФ на предприятия военно-промышленного комплекса России , а также работаем в рамках 275 ФЗ с открытием отдельных счетов в уполномоченном банке. Система менеджмента качества компании соответствует требованиям ГОСТ ISO 9001.

Минимальные сроки поставки, гибкие цены, неограниченный ассортимент и индивидуальный подход к клиентам являются основой для выстраивания долгосрочного и эффективного сотрудничества с предприятиями радиоэлектронной промышленности, предприятиями ВПК и научно-исследовательскими институтами России.

С нами вы становитесь еще успешнее!

Наши контакты:

Телефон: +7 812 627 14 35

Электронная почта: sales@st-electron.ru

Адрес: 198099, Санкт-Петербург,
Промышленная ул, дом № 19, литера Н,
помещение 100-Н Офис 331