

FEATURES

1.8 V to 5.5 V single supply
2 Ω (typical) on resistance
Low on resistance flatness
-3 dB bandwidth > 200 MHz
Rail-to-rail operation
Fast switching times
 t_{ON} 18 ns
 t_{OFF} 12 ns
Typical power consumption < 0.01 μ W
TTL/CMOS-compatible

APPLICATIONS

Battery-powered systems
Communications systems
Sample-and-hold systems
Audio signal routing
Video switching
Mechanical reed relay replacement

GENERAL DESCRIPTION

The ADG701/ADG702 are monolithic CMOS SPST switches. These switches are designed on an advanced submicron process that provides low power dissipation yet high switching speed, low on resistance, and low leakage currents. In addition, -3 dB bandwidths of greater than 200 MHz can be achieved.

The ADG701/ADG702 can operate from a single 1.8 V to 5.5 V supply, making it ideal for use in battery-powered instruments and with the new generation of DACs and ADCs from Analog Devices, Inc.

Figure 1 shows that with a logic input of 1, the switch of the ADG701 is closed and that of the ADG702 is open. Each switch conducts equally well in both directions when on.

The ADG701/ADG702 are available in 5-lead SOT-23, 6-lead SOT-23, and 8-lead MSOP packages.

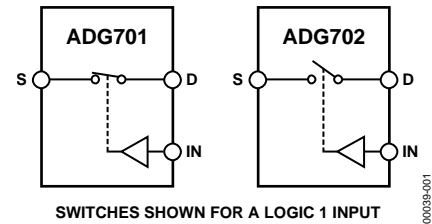
FUNCTIONAL BLOCK DIAGRAM

SWITCHES SHOWN FOR A LOGIC 1 INPUT

Figure 1.

PRODUCT HIGHLIGHTS

- 1.8 V to 5.5 V Single-Supply Operation.
The ADG701/ADG702 offer high performance, including low on resistance and fast switching times, and are fully specified and guaranteed with 3 V and 5 V supply rails.
- Very Low R_{ON} (3 Ω Maximum at 5 V, 5 Ω Maximum at 3 V).
At 1.8 V operation, R_{ON} is typically 40 Ω over the temperature range.
- On Resistance Flatness $R_{FLAT(ON)}$ (1 Ω Maximum).
- 3 dB Bandwidth > 200 MHz.
- Low Power Dissipation.
CMOS construction ensures low power dissipation.
- Fast t_{ON}/t_{OFF} .

Table 1. Related Devices

Part No.	Description
ADG701L/ADG702L	Low voltage 2 Ω SPST switches with guaranteed leakage specifications

Rev. C

Information furnished by Analog Devices is believed to be accurate and reliable. However, no responsibility is assumed by Analog Devices for its use, nor for any infringements of patents or other rights of third parties that may result from its use. Specifications subject to change without notice. No license is granted by implication or otherwise under any patent or patent rights of Analog Devices. Trademarks and registered trademarks are the property of their respective owners.

TABLE OF CONTENTS

Features	1	Typical Performance Characteristics	7
Applications.....	1	Terminology.....	8
Functional Block Diagram	1	Test Circuits.....	9
General Description	1	Applications Information	10
Product Highlights	1	ADG701/ADG702 Supply Voltages.....	10
Revision History	2	Bandwidth	10
Specifications.....	3	Off Isolation	10
Absolute Maximum Ratings.....	5	Outline Dimensions	11
ESD Caution.....	5	Ordering Guide	12
Pin Configurations and Function Descriptions	6		

REVISION HISTORY

7/06—Rev. B to Rev. C

Changes to Product Highlights.....	1
Added Table 1.....	1
Changes to Table 2.....	3
Changes to Table 3.....	4
Added Pb-Free Reflow Soldering to Absolute Maximum Ratings ..	5
Changes to Ordering Guide	13

6/04—Rev. A to Rev. B

Updated Format.....	Universal
Added 5-Lead SOT-23 Package	Universal
Updated Outline Dimensions	10
Changes to Ordering Guide	11

8/98—Rev. 0 to Rev. A

SPECIFICATIONS

$V_{DD} = 5\text{ V} \pm 10\%$, $GND = 0\text{ V}$. Temperature range for B version is -40°C to $+85^{\circ}\text{C}$, unless otherwise noted.

Table 2.

Parameter	B Version		Unit	Test Conditions/Comments
	+25°C	-40°C to +85°C		
ANALOG SWITCH				
Analog Signal Range		0 V to V_{DD}	V	
On Resistance (R_{ON})	2		Ω typ	$V_S = 0\text{ V to }V_{DD}$, $I_S = -10\text{ mA}$; Figure 11
	3	4	Ω max	
On Resistance Flatness ($R_{FLAT(ON)}$)	0.5		Ω typ	$V_S = 0\text{ V to }V_{DD}$, $I_S = -10\text{ mA}$
		1.0	Ω max	
LEAKAGE CURRENTS				
Source OFF Leakage, I_S (OFF)	± 0.01		nA typ	$V_{DD} = 5.5\text{ V}$ $V_S = 4.5\text{ V}/1\text{ V}$, $V_D = 1\text{ V}/4.5\text{ V}$; Figure 12
Drain OFF Leakage, I_D (OFF)	± 0.01		nA typ	$V_S = 4.5\text{ V}/1\text{ V}$, $V_D = 1\text{ V}/4.5\text{ V}$; Figure 12
Channel ON Leakage, I_D , I_S (ON)	± 0.01		nA typ	$V_S = V_D = 1\text{ V}$, or 4.5 V ; Figure 13
DIGITAL INPUTS				
Input High Voltage, V_{INH}		2.4	V min	
Input Low Voltage, V_{INL}		0.8	V max	
Input Current				
I_{INL} or I_{INH}	0.005		μA typ	$V_{IN} = V_{INL}$ or V_{INH}
		± 0.1	μA max	
DYNAMIC CHARACTERISTICS¹				
t_{ON}	12		ns typ	$R_L = 300\ \Omega$, $C_L = 35\text{ pF}$ $V_S = 3\text{ V}$; Figure 14
		18	ns max	
t_{OFF}	8		ns typ	$R_L = 300\ \Omega$, $C_L = 35\text{ pF}$ $V_S = 3\text{ V}$; Figure 14
		12	ns max	
Charge Injection	5		pC typ	$V_S = 2\text{ V}$, $R_S = 0\ \Omega$, $C_L = 1\text{ nF}$; Figure 15
Off Isolation	-55		dB typ	$R_L = 50\ \Omega$, $C_L = 5\text{ pF}$, $f = 10\text{ MHz}$ $R_L = 50\ \Omega$, $C_L = 5\text{ pF}$, $f = 1\text{ MHz}$; Figure 16
	-75		dB typ	
Bandwidth -3 dB	200		MHz typ	$R_L = 50\ \Omega$, $C_L = 5\text{ pF}$; Figure 17
C_S (OFF)	17		pF typ	
C_D (OFF)	17		pF typ	
C_D , C_S (ON)	38		pF typ	
POWER REQUIREMENTS				
I_{DD}	0.001		μA typ	$V_{DD} = 5.5\text{ V}$ Digital inputs = 0 V or 5 V
		1.0	μA max	

¹ Guaranteed by design, not subject to production test.

ADG701/ADG702

$V_{DD} = 3\text{ V} \pm 10\%$, $GND = 0\text{ V}$. Temperature range for B version is -40°C to $+85^{\circ}\text{C}$, unless otherwise noted.

Table 3.

Parameter	B Version		Unit	Test Conditions/Comments
	+25°C	-40°C to +85°C		
ANALOG SWITCH				
Analog Signal Range		0 V to V_{DD}	V	
On Resistance (R_{ON})	3.5		Ω typ	$V_S = 0\text{ V}$ to V_{DD} , $I_S = -10\text{ mA}$; Figure 11
	5	6	Ω max	
On Resistance Flatness ($R_{FLAT(ON)}$)	1.5		Ω typ	$V_S = 0\text{ V}$ to V_{DD} , $I_S = -10\text{ mA}$
LEAKAGE CURRENTS				
Source OFF Leakage I_S (OFF)	± 0.01		nA typ	$V_{DD} = 3.3\text{ V}$ $V_S = 3\text{ V}/1\text{ V}$, $V_D = 1\text{ V}/3\text{ V}$; Figure 12
Drain OFF Leakage I_D (OFF)	± 0.01		nA typ	$V_S = 3\text{ V}/1\text{ V}$, $V_D = 1\text{ V}/3\text{ V}$; Figure 12
Channel ON Leakage I_D , I_S (ON)	± 0.01		nA typ	$V = V_D = 1\text{ V}$, or 3 V ; Figure 13
DIGITAL INPUTS				
Input High Voltage, V_{INH}		2.0	V min	
Input Low Voltage, V_{INL}		0.4	V max	
Input Current				
I_{INL} or I_{INH}	0.005		μA typ	$V_{IN} = V_{INL}$ or V_{INH}
		± 0.1	μA max	
DYNAMIC CHARACTERISTICS¹				
t_{ON}	14		ns typ	$R_L = 300\ \Omega$, $C_L = 35\text{ pF}$
		20	ns max	$V_S = 2\text{ V}$, Figure 14
t_{OFF}	8		ns typ	$R_L = 300\ \Omega$, $C_L = 35\text{ pF}$
		13	ns max	$V_S = 2\text{ V}$, Figure 14
Charge Injection	4		pC typ	$V_S = 1.5\text{ V}$, $R_S = 0\ \Omega$, $C_L = 1\text{ nF}$; Figure 15
Off Isolation	-55		dB typ	$R_L = 50\ \Omega$, $C_L = 5\text{ pF}$, $f = 10\text{ MHz}$
	-75		dB typ	$R_L = 50\ \Omega$, $C_L = 5\text{ pF}$, $f = 1\text{ MHz}$; Figure 16
Bandwidth -3 dB	200		MHz typ	$R_L = 50\ \Omega$, $C_L = 5\text{ pF}$; Figure 17
C_S (OFF)	17		pF typ	
C_D (OFF)	17		pF typ	
C_D , C_S (ON)	38		pF typ	
POWER REQUIREMENTS				
I_{DD}	0.001		μA typ	$V_{DD} = 3.3\text{ V}$ Digital inputs = 0 V or 3 V
		1.0	μA max	

¹ Guaranteed by design, not subject to production test.

ABSOLUTE MAXIMUM RATINGS

$T_A = +25^\circ\text{C}$, unless otherwise noted.

Table 4.

Parameter	Rating
V_{DD} to GND	-0.3 V to +7 V
Analog and Digital Inputs ¹	-0.3 V to $V_{DD} + 0.3$ V or 30 mA, whichever occurs first
Continuous Current, S or D	30 mA
Peak Current, S or D	100 mA, pulsed at 1 ms, 10% duty cycle maximum
Operating Temperature Range	
Industrial (B Version)	-40°C to +85°C
Storage Temperature Range	-65°C to +150°C
Junction Temperature	150°C
MSOP Package, Power Dissipation	315 mW
θ_{JA} Thermal Impedance	206°C/W
θ_{JC} Thermal Impedance	44°C/W
SOT-23 Package, Power Dissipation	282 mW
θ_{JA} Thermal Impedance	229.6°C/W
θ_{JC} Thermal Impedance	91.99°C/W
Lead Temperature, Soldering	
Vapor Phase (60 sec)	215°C
Infrared (15 sec)	220°C
Pb-free Reflow Soldering	
Peak Temperature	260(+0/-5)°C
Time at Peak Temperature	10 sec to 40 sec
ESD	2 kV

¹ Overvoltages at IN, S, or D are clamped by internal diodes. Current should be limited to the maximum ratings given.

Stresses above those listed under Absolute Maximum Ratings may cause permanent damage to the device. This is a stress rating only; functional operation of the device at these or any other conditions above those indicated in the operational section of this specification is not implied. Exposure to absolute maximum rating conditions for extended periods may affect device reliability.

Only one absolute maximum rating may be applied at any one time.

Table 5. Truth Table

ADG701 In	ADG702 In	Switch Condition
0	1	Off
1	0	On

ESD CAUTION

ESD (electrostatic discharge) sensitive device. Electrostatic charges as high as 4000 V readily accumulate on the human body and test equipment and can discharge without detection. Although this product features proprietary ESD protection circuitry, permanent damage may occur on devices subjected to high energy electrostatic discharges. Therefore, proper ESD precautions are recommended to avoid performance degradation or loss of functionality.



ADG701/ADG702

PIN CONFIGURATIONS AND FUNCTION DESCRIPTIONS

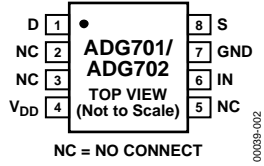

Figure 2. 8-Lead MSOP

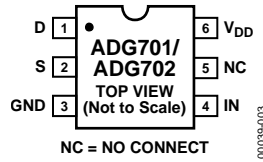

Figure 3. 6-Lead SOT-23

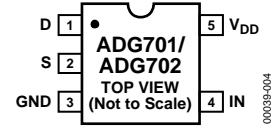

Figure 4. 5-Lead SOT-23

Table 6. Pin Descriptions

Pin No.			Mnemonic	Description
8-Lead MSOP	6-Lead SOT-23	5-Lead SOT-23		
1	1	1	D	Drain Terminal. Can be an input or output.
2, 3, 5	5		NC	No Connect
4	6	5	V _{DD}	Most Positive Power Supply Potential.
6	4	4	IN	Logic Control Input.
7	3	3	GND	Ground (0 V) Reference.
8	2	2	S	Source Terminal. Can be an input or output.

TYPICAL PERFORMANCE CHARACTERISTICS

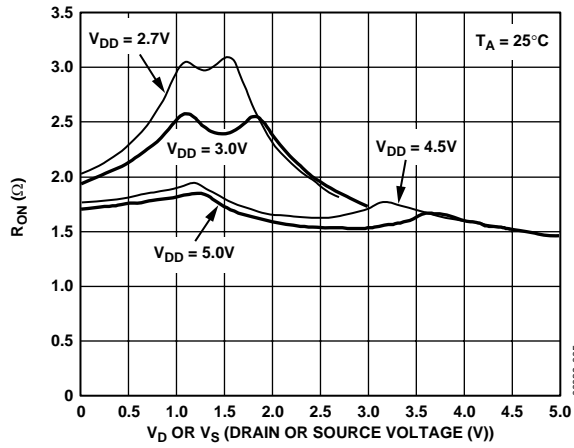

Figure 5. On Resistance as a Function of V_D (V_S) Single Supplies

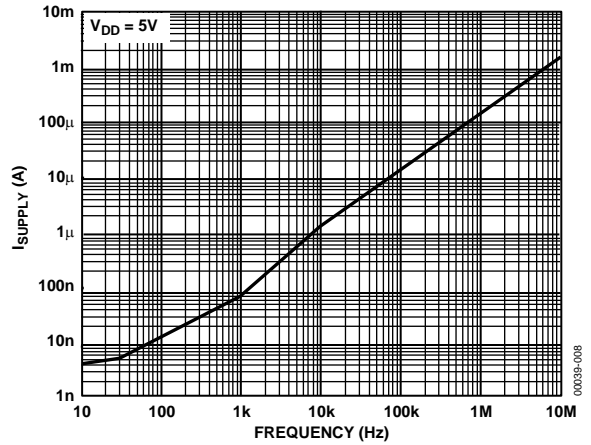

Figure 8. Supply Current vs. Input Switching Frequency

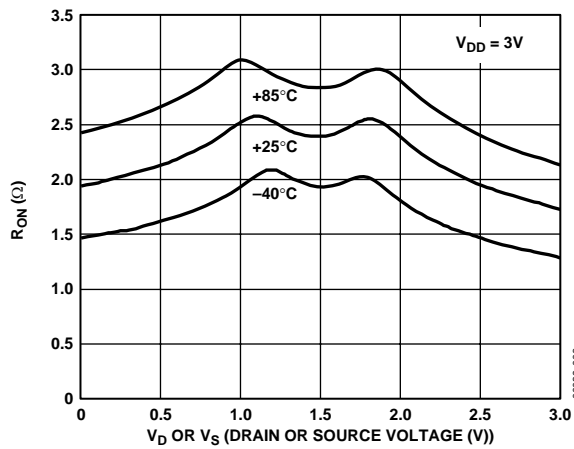

Figure 6. On Resistance as a Function of V_D (V_S) for Different Temperatures
 $V_{DD} = 3V$

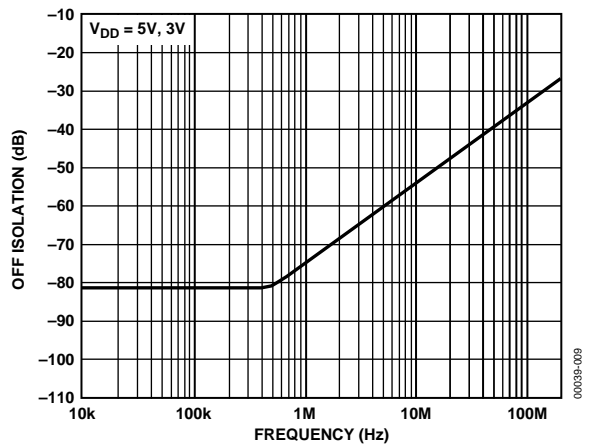

Figure 9. Off Isolation vs. Frequency

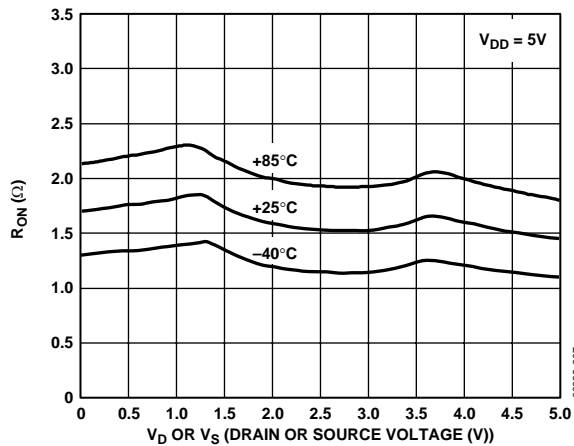

Figure 7. On Resistance as a Function of V_D (V_S) for Different Temperatures
 $V_{DD} = 5V$

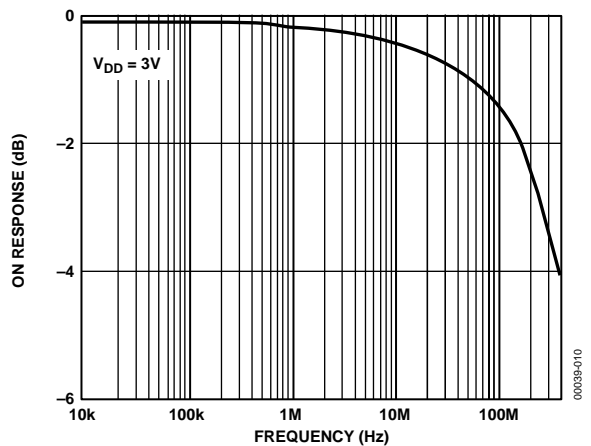

Figure 10. Bandwidth

TERMINOLOGY

Table 7.

Term	Description
R_{ON}	Ohmic resistance between D and S.
$R_{FLAT(ON)}$	Flatness is defined as the difference between the maximum and minimum value of on resistance as measured over the specified analog signal range.
I_S (OFF)	Source leakage current with the switch off.
I_D (OFF)	Drain leakage current with the switch off.
I_D, I_S (ON)	Channel leakage current with the switch on.
V_D (VS)	Analog voltage on terminals D and S.
C_S (OFF)	Off switch source capacitance.
C_D (OFF)	Off switch drain capacitance.
C_D, C_S (ON)	On switch capacitance.
t_{ON}	Delay between applying the digital control input and the output switching on. See Figure 14.
t_{OFF}	Delay between applying the digital control input and the output switching off.
Off Isolation	A measure of unwanted signal coupling through an off switch.
Charge Injection	A measure of the glitch impulse transferred from the digital input to the analog output during switching.
Bandwidth	The frequency at which the output is attenuated by -3 dB.
On Response	The frequency response of the on switch.
On Loss	The voltage drop across the on switch seen in Figure 10 as the number of decibels that the signal is from 0 dB at very low frequencies.

TEST CIRCUITS

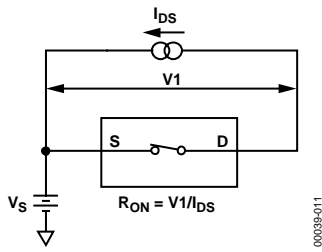

Figure 11. On Resistance

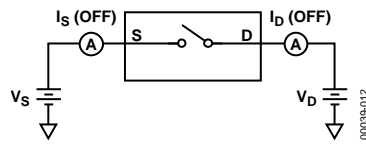

Figure 12. Off Leakage

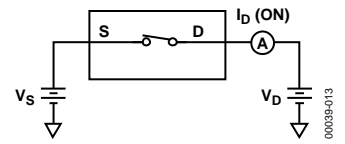

Figure 13. On Leakage

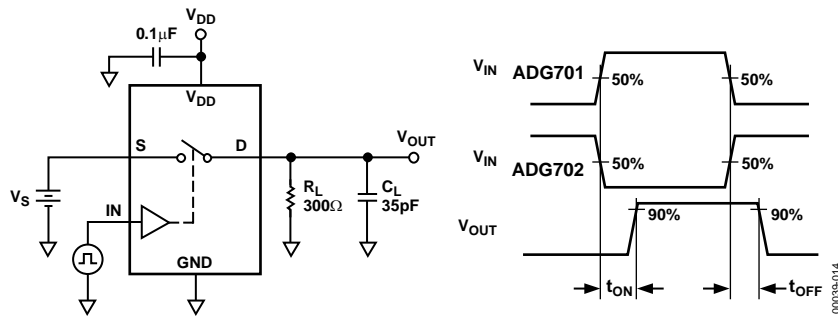

Figure 14. Switching Times

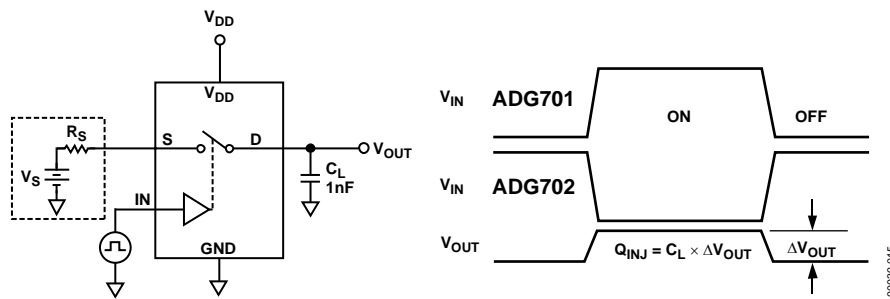

Figure 15. Charge Injection

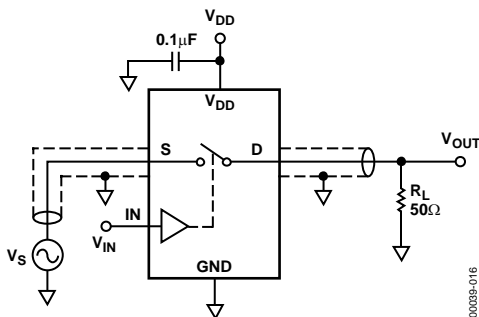

Figure 16. Off Isolation

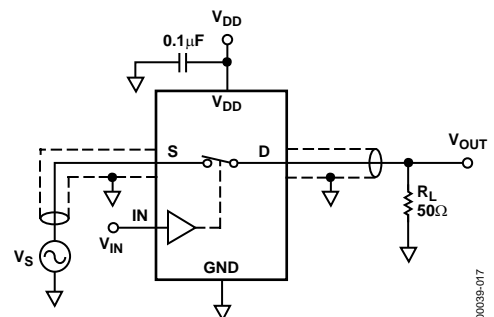

Figure 17. Bandwidth

APPLICATIONS INFORMATION

The ADG701/ADG702 belong to the Analog Devices family of CMOS switches. This series of general-purpose switches has improved switching times, lower on resistance, higher bandwidth, low power consumption, and low leakage currents.

ADG701/ADG702 SUPPLY VOLTAGES

Functionality of the ADG701/ADG702 extends from 1.8 V to 5.5 V single supply, making the parts ideal for battery-powered instruments, where power efficiency and performance are important design parameters.

It is important to note that the supply voltage affects the input signal range, on resistance, and switching times of the part. The effects of the power supplies can be clearly seen in the Typical Performance Characteristics and the Specifications sections.

For $V_{DD} = 1.8$ V operation, R_{ON} is typically 40 Ω over the temperature range.

BANDWIDTH

Figure 18 illustrates the parasitic components that affect the ac performance of CMOS switches (a box surrounds the switch). Additional external capacitances further degrade performance by affecting feedthrough, crosstalk, and system bandwidth.

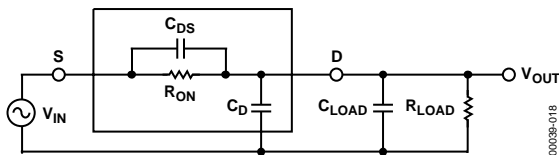

Figure 18. Switch Represented by Equivalent Parasitic Components

The transfer function that describes the equivalent diagram of the switch (see Figure 18) is of the form $A(s)$, shown in the following equation:

$$A(s) = R_T \left[\frac{s(R_{ON}C_{DS}) + 1}{s(R_{ON}C_T R_T) + 1} \right]$$

where $C_T = C_{LOAD} + C_D + C_{DS}$.

The signal transfer characteristic is dependent on the switch channel capacitance, C_{DS} . This capacitance creates a frequency zero in the numerator of the transfer function $A(s)$. Because the switch on resistance is small, this zero usually occurs at high frequencies. The bandwidth is a function of the switch output capacitance combined with C_{DS} and the load capacitance. The frequency pole corresponding to these capacitances appears in the denominator of $A(s)$.

The dominant effect of the output capacitance, C_D , causes the pole breakpoint frequency to occur first. To maximize bandwidth, a switch must have a low input and output capacitance and low on resistance. The on response vs. frequency for the ADG701/ADG702 can be seen in Figure 10.

OFF ISOLATION

Off isolation is a measure of the input signal coupled through an off switch to the switch output. The capacitance, C_{DS} , couples the input signal to the output load when the switch is off, as shown in Figure 19.

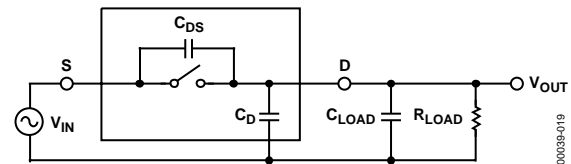
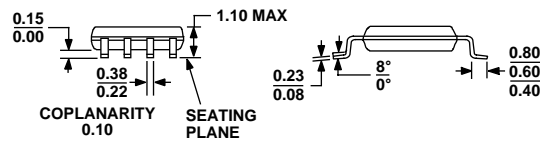
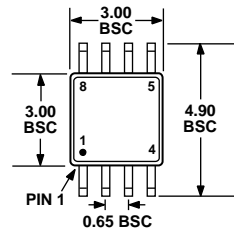

Figure 19. Off Isolation Is Affected by External Load Resistance and Capacitance

The larger the value of C_{DS} , the larger the values of feedthrough produced. Figure 9 illustrates the drop in off isolation as a function of frequency. From dc to roughly 1 MHz, the switch shows better than -75 dB isolation. Up to frequencies of 10 MHz, the off isolation remains better than -55 dB. As the frequency increases, more of the input signal is coupled through to the output. Off isolation can be maximized by choosing a switch with the smallest C_{DS} possible. The values of load resistance and capacitance also affect off isolation, because they contribute to the coefficients of the poles and zeros in the transfer function of the switch when open.

$$A(s) = R_T \left[\frac{s(R_{LOAD}C_{DS}) + 1}{s(R_{LOAD})(C_T) + 1} \right]$$

OUTLINE DIMENSIONS



COMPLIANT TO JEDEC STANDARDS MO-187-AA

Figure 20. 8-Lead Mini Small Outline Package [MSOP] (RM-8)

Dimensions shown in millimeters

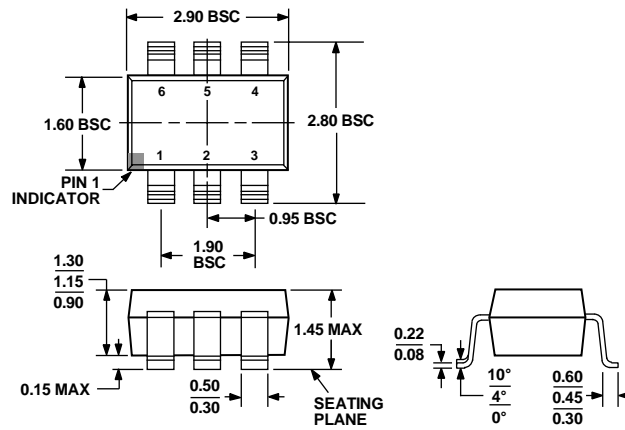

COMPLIANT TO JEDEC STANDARDS MO-178-AB

Figure 21. 6-Lead Small Outline Transistor Package [SOT-23] (RT-6)

Dimensions shown in millimeters

ADG701/ADG702

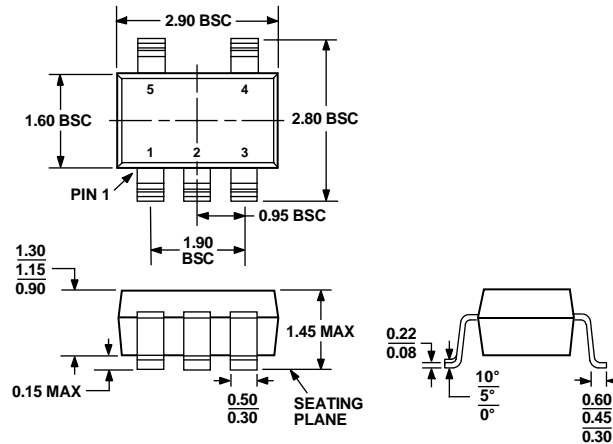

COMPLIANT TO JEDEC STANDARDS MO-178-AA

Figure 22. 5-Lead Small Outline Transistor Package [SOT-23] (RJ-5)

Dimensions shown in millimeters

ORDERING GUIDE

Model	Package Description	Package Option	Branding
ADG701BRJ-500RL7	5-Lead Small Outline Transistor Package [SOT-23]	RJ-5	S3B
ADG701BRJ-REEL	5-Lead Small Outline Transistor Package [SOT-23]	RJ-5	S3B
ADG701BRJ-REEL7	5-Lead Small Outline Transistor Package [SOT-23]	RJ-5	S3B
ADG701BRM	8-Lead Mini Small Outline Package [MSOP]	RM-8	S3B
ADG701BRM-REEL	8-Lead Mini Small Outline Package [MSOP]	RM-8	S3B
ADG701BRM-REEL7	8-Lead Mini Small Outline Package [MSOP]	RM-8	S3B
ADG701BRT-REEL	6-Lead Small Outline Transistor Package [SOT-23]	RT-6	S3B
ADG701BRT-REEL7	6-Lead Small Outline Transistor Package [SOT-23]	RT-6	S3B
ADG701BRJZ-500RL7 ¹	5-Lead Small Outline Transistor Package [SOT-23]	RJ-5	S3B#
ADG701BRJZ-REEL ¹	5-Lead Small Outline Transistor Package [SOT-23]	RJ-5	S3B#
ADG701BRJZ-REEL7 ¹	5-Lead Small Outline Transistor Package [SOT-23]	RJ-5	S3B#
ADG701BRMZ ¹	8-Lead Mini Small Outline Package [MSOP]	RM-8	S0S
ADG701BRMZ-REEL7 ¹	8-Lead Mini Small Outline Package [MSOP]	RM-8	S0S
ADG701BRTZ-REEL ¹	6-Lead Small Outline Transistor Package [SOT-23]	RT-6	S3B#
ADG701BRTZ-REEL7 ¹	6-Lead Small Outline Transistor Package [SOT-23]	RT-6	S3B#
ADG702BRJ-500RL7	5-Lead Small Outline Transistor Package [SOT-23]	RJ-5	S4B
ADG702BRJ-REEL	5-Lead Small Outline Transistor Package [SOT-23]	RJ-5	S4B
ADG702BRJ-REEL7	5-Lead Small Outline Transistor Package [SOT-23]	RJ-5	S4B
ADG702BRM	8-Lead Mini Small Outline Package [MSOP]	RM-8	S4B
ADG702BRM-REEL	8-Lead Mini Small Outline Package [MSOP]	RM-8	S4B
ADG702BRM-REEL7	8-Lead Mini Small Outline Package [MSOP]	RM-8	S4B
ADG702BRT-REEL	6-Lead Small Outline Transistor Package [SOT-23]	RT-6	S4B
ADG702BRT-REEL7	6-Lead Small Outline Transistor Package [SOT-23]	RT-6	S4B
ADG702BRJZ-500RL7 ¹	5-Lead Small Outline Transistor Package [SOT-23]	RJ-5	S14
ADG702BRJZ-REEL ¹	5-Lead Small Outline Transistor Package [SOT-23]	RJ-5	S14
ADG702BRJZ-REEL7 ¹	5-Lead Small Outline Transistor Package [SOT-23]	RJ-5	S14
ADG702BRMZ ¹	8-Lead Mini Small Outline Package [MSOP]	RM-8	S14
ADG702BRMZ-REEL7 ¹	8-Lead Mini Small Outline Package [MSOP]	RM-8	S14
ADG702BRTZ-REEL ¹	6-Lead Small Outline Transistor Package [SOT-23]	RT-6	S4B#
ADG702BRTZ-REEL7 ¹	6-Lead Small Outline Transistor Package [SOT-23]	RT-6	S4B#

¹ Z = Pb-free part, # denotes lead-free product, may be top or bottom marked.



Стандарт Электрон Связь

Мы молодая и активно развивающаяся компания в области поставок электронных компонентов. Мы поставляем электронные компоненты отечественного и импортного производства напрямую от производителей и с крупнейших складов мира.

Благодаря сотрудничеству с мировыми поставщиками мы осуществляем комплексные и плановые поставки широчайшего спектра электронных компонентов.

Собственная эффективная логистика и склад в обеспечивает надежную поставку продукции в точно указанные сроки по всей России.

Мы осуществляем техническую поддержку нашим клиентам и предпродажную проверку качества продукции. На все поставляемые продукты мы предоставляем гарантию .

Осуществляем поставки продукции под контролем ВП МО РФ на предприятия военно-промышленного комплекса России , а также работаем в рамках 275 ФЗ с открытием отдельных счетов в уполномоченном банке. Система менеджмента качества компании соответствует требованиям ГОСТ ISO 9001.

Минимальные сроки поставки, гибкие цены, неограниченный ассортимент и индивидуальный подход к клиентам являются основой для выстраивания долгосрочного и эффективного сотрудничества с предприятиями радиоэлектронной промышленности, предприятиями ВПК и научно-исследовательскими институтами России.

С нами вы становитесь еще успешнее!

Наши контакты:

Телефон: +7 812 627 14 35

Электронная почта: sales@st-electron.ru

Адрес: 198099, Санкт-Петербург,
Промышленная ул, дом № 19, литера Н,
помещение 100-Н Офис 331