

SN54ALS574B, SN54AS574, SN54AS575 SN74ALS574B, SN74ALS575A, SN74AS574, SN74AS575 OCTAL D-TYPE EDGE-TRIGGERED FLIP-FLOPS WITH 3-STATE OUTPUTS

SDAS165B – JUNE 1982 – REVISED JULY 1995

- 3-State Buffer-Type Noninverting Outputs Drive Bus Lines Directly
- Bus-Structured Pinout
- Buffered Control Inputs
- SN74ALS575A and 'AS575 Have Synchronous Clear
- Package Options Include Plastic Small-Outline (DW) Packages, Ceramic Chip Carriers (FK), Standard Plastic (N, NT) and Ceramic (J, JT) 300-mil DIPs, and Ceramic Flat (W) Packages

description

These octal D-type edge-triggered flip-flops feature 3-state outputs designed specifically for bus driving. They are particularly suitable for implementing buffer registers, I/O ports, bidirectional bus drivers, and working registers.

The eight flip-flops enter data on the low-to-high transition of the clock (CLK) input. The SN74ALS575A, SN54AS575, and SN74AS575 may be synchronously cleared by taking the clear ($\overline{\text{CLR}}$) input low.

The output-enable ($\overline{\text{OE}}$) input does not affect internal operations of the flip-flops. Old data can be retained or new data can be entered while the outputs are in the high-impedance state.

The SN54ALS574B, SN54AS574, and SN54AS575 are characterized for operation over the full military temperature range of -55°C to 125°C . The SN74ALS574B, SN74ALS575A, SN74AS574, and SN74AS575 are characterized for operation from 0°C to 70°C .

SN54ALS574B, SN54AS574 . . . J OR W PACKAGE
SN74ALS574B, SN74AS574 . . . DW OR N PACKAGE
(TOP VIEW)



SN54ALS574B, SN54AS574 . . . FK PACKAGE
(TOP VIEW)



SN54AS575 . . . JT OR W PACKAGE
SN74ALS575A, SN74AS575 . . . DW OR NT PACKAGE
(TOP VIEW)



SN54AS575 . . . FK PACKAGE
(TOP VIEW)



NC – No internal connection

SN54ALS574B, SN54AS574, SN54AS575
SN74ALS574B, SN74ALS575A, SN74AS574, SN74AS575
OCTAL D-TYPE EDGE-TRIGGERED FLIP-FLOPS WITH 3-STATE OUTPUTS

SDAS165B – JUNE 1982 – REVISED JULY 1995

Function Tables

SN54ALS574B, SN74ALS574B, SN54AS574, SN74AS574
 (each flip-flop)

INPUTS			OUTPUT
\overline{OE}	CLK	D	Q
L	↑	H	H
L	↑	L	L
L	L	X	Q_0
H	X	X	Z

SN74ALS575A, SN54AS575, SN74AS575
 (each flip-flop)

INPUTS				OUTPUT
\overline{OE}	CLR	CLK	D	Q
L	L	↑	X	L
L	H	↑	H	H
L	H	↑	L	L
L	H	L	X	Q_0
H	X	H	X	Z

logic symbol†

SN54ALS574B, SN74ALS574B,
SN54AS574, SN74AS574

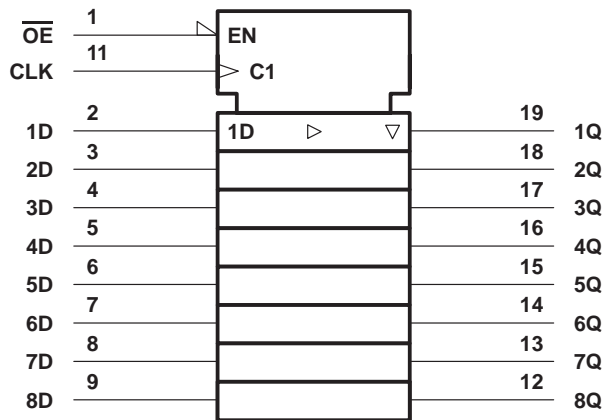

SN74ALS575A, SN54AS575,
SN74AS575

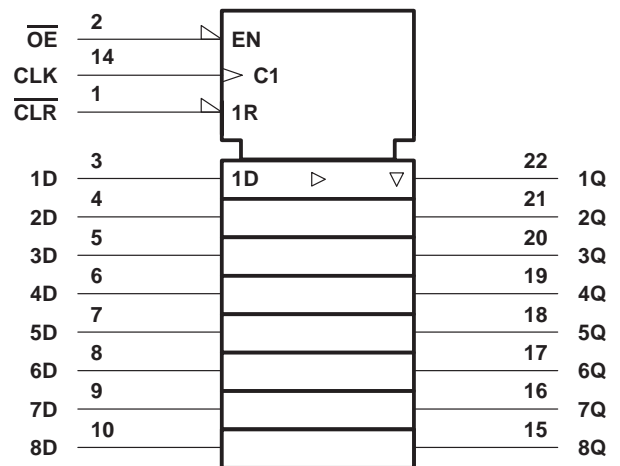

† These symbols are in accordance with ANSI/IEEE Std 91-1984 and IEC Publication 617-12. Pin numbers shown are for the DW, J, JT, N, and NT packages.

SN54ALS574B, SN54AS574, SN54AS575
SN74ALS574B, SN74ALS575A, SN74AS574, SN74AS575
OCTAL D-TYPE EDGE-TRIGGERED FLIP-FLOPS WITH 3-STATE OUTPUTS

SDAS165B – JUNE 1982 – REVISED JULY 1995

logic diagrams (positive logic)

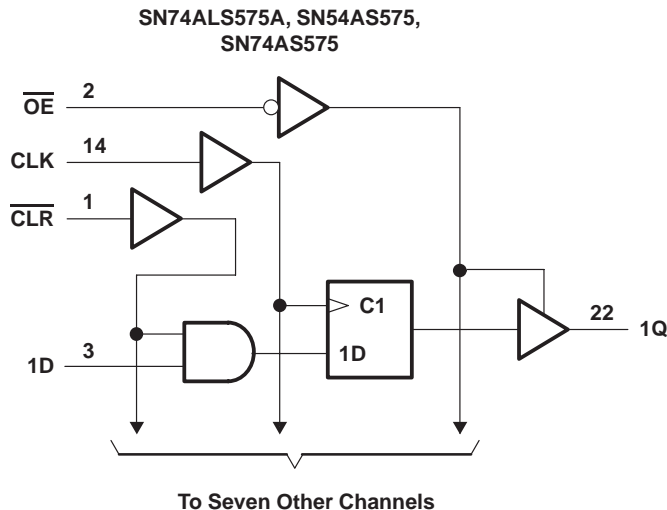

Pin numbers shown are for the DW, J, JT, N, and NT packages.

absolute maximum ratings over operating free-air temperature range (unless otherwise noted)†

Supply voltage, V_{CC}	7 V
Input voltage, V_I	7 V
Voltage applied to a disabled 3-state output	5.5 V
Operating free-air temperature range, T_A : SN54ALS574B	-55°C to 125°C
SN74ALS574B, SN74ALS575A	0°C to 70°C
Storage temperature range	-65°C to 150°C

† Stresses beyond those listed under "absolute maximum ratings" may cause permanent damage to the device. These are stress ratings only, and functional operation of the device at these or any other conditions beyond those indicated under "recommended operating conditions" is not implied. Exposure to absolute-maximum-rated conditions for extended periods may affect device reliability.

recommended operating conditions

		SN54ALS574B			SN74ALS574B SN74ALS575A			UNIT
		MIN	NOM	MAX	MIN	NOM	MAX	
V_{CC}	Supply voltage	4.5	5	5.5	4.5	5	5.5	V
V_{IH}	High-level input voltage	2			2			V
V_{IL}	Low-level input voltage			0.7			0.8	V
I_{OH}	High-level output current			-1			-2.6	mA
I_{OL}	Low-level output current			12			24	mA
f_{clock}	Clock frequency	'ALS574B	0	28	0		35	MHz
		SN74ALS575A			0		30	
t_w	Pulse duration	'ALS574B, CLK high or low	16.5		14			ns
		SN74ALS575A, CLK high or low			16.5			
t_{su}	Setup time before CLK↑	Data	15		15			ns
		SN74ALS575A, \overline{CLR}			15			
t_h	Hold time after CLK↑	Data	4		0			ns
		SN74ALS575A, \overline{CLR}			0			
T_A	Operating free-air temperature	-55		125	0		70	°C



SN54ALS574B, SN54AS574, SN54AS575
SN74ALS574B, SN74ALS575A, SN74AS574, SN74AS575
OCTAL D-TYPE EDGE-TRIGGERED FLIP-FLOPS WITH 3-STATE OUTPUTS

SDAS165B – JUNE 1982 – REVISED JULY 1995

electrical characteristics over recommended operating free-air temperature range (unless otherwise noted)

PARAMETER	TEST CONDITIONS		SN54ALS574B			SN74ALS574B SN74ALS575A			UNIT
			MIN	TYP†	MAX	MIN	TYP†	MAX	
V_{IK}	$V_{CC} = 4.5\text{ V}$, $I_I = -18\text{ mA}$		-1.2			-1.2			V
V_{OH}	$V_{CC} = 4.5\text{ V to } 5.5\text{ V}$, $I_{OH} = -0.4\text{ mA}$		$V_{CC} - 2$			$V_{CC} - 2$			V
	$V_{CC} = 4.5\text{ V}$	$I_{OH} = -1\text{ mA}$	2.4	3.3					
		$I_{OH} = -2.6\text{ mA}$				2.4	3.2		
V_{OL}	$V_{CC} = 4.5\text{ V}$	$I_{OL} = 12\text{ mA}$	0.25	0.4		0.25	0.4	V	
		$I_{OL} = 24\text{ mA}$				0.35	0.5		
I_{OZH}	$V_{CC} = 5.5\text{ V}$,	$V_O = 2.7\text{ V}$	20			20			μA
I_{OZL}	$V_{CC} = 5.5\text{ V}$,	$V_O = 0.4\text{ V}$	-20			-20			μA
I_I	$V_{CC} = 5.5\text{ V}$,	$V_I = 7\text{ V}$	0.1			0.1			mA
I_{IH}	$V_{CC} = 5.5\text{ V}$,	$V_I = 2.7\text{ V}$	20			20			μA
I_{IL}	$V_{CC} = 5.5\text{ V}$,	$V_I = 0.4\text{ V}$	-0.2			-0.2			mA
$I_{O\ddagger}$	$V_{CC} = 5.5\text{ V}$,	$V_O = 2.25\text{ V}$	-20		-112	-30		-112	mA
I_{CC}	'ALS574B	$V_{CC} = 5.5\text{ V}$	Outputs high	11	18	11	18	mA	
			Outputs low	17	27	17	27		
			Outputs disabled	17	28	17	28		
	SN74ALS575A	$V_{CC} = 5.5\text{ V}$	Outputs high	10	17	10	17		
			Outputs low	15	24	15	24		
			Outputs disabled	16	30	16	30		

† All typical values are at $V_{CC} = 5\text{ V}$, $T_A = 25^\circ\text{C}$.

‡ The output conditions have been chosen to produce a current that closely approximates one half of the true short-circuit output current, I_{OS} .

switching characteristics (see Figure 1)

PARAMETER	FROM (INPUT)	TO (OUTPUT)	$V_{CC} = 4.5\text{ V to } 5.5\text{ V}$, $C_L = 50\text{ pF}$, $R_1 = 500\ \Omega$, $R_2 = 500\ \Omega$, $T_A = \text{MIN to MAX}\S$						UNIT
			SN54ALS574B		SN74ALS574B		SN74ALS575A		
			MIN	MAX	MIN	MAX	MIN	MAX	
f_{max}			28		35		30	MHz	
t_{PLH}	CLK	Q	4	22	3	14	4	14	ns
t_{PHL}			4	17	4	14	4	14	
t_{PZH}	$\overline{\text{OE}}$	Q	4	21	3	18	4	18	ns
t_{PZL}			4	26	4	18	4	18	
t_{PHZ}	$\overline{\text{OE}}$	Q	2	16	1	10	2	10	ns
t_{PLZ}			2	25	2	12	3	13	

§ For conditions shown as MIN or MAX, use the appropriate value specified under recommended operating conditions.



SN54ALS574B, SN54AS574, SN54AS575
SN74ALS574B, SN74ALS575A, SN74AS574, SN74AS575
OCTAL D-TYPE EDGE-TRIGGERED FLIP-FLOPS WITH 3-STATE OUTPUTS

SDAS165B – JUNE 1982 – REVISED JULY 1995

absolute maximum ratings over operating free-air temperature range (unless otherwise noted)†

Supply voltage, V_{CC}	7 V
Input voltage, V_I	7 V
Voltage applied to a disabled 3-state output	5.5 V
Operating free-air temperature range, T_A : SN54AS574, SN54AS575	–55°C to 125°C
SN74AS574, SN74AS575	0°C to 70°C
Storage temperature range	–65°C to 150°C

† Stresses beyond those listed under “absolute maximum ratings” may cause permanent damage to the device. These are stress ratings only, and functional operation of the device at these or any other conditions beyond those indicated under “recommended operating conditions” is not implied. Exposure to absolute-maximum-rated conditions for extended periods may affect device reliability.

recommended operating conditions

		SN54AS574 SN54AS575			SN74AS574 SN74AS575			UNIT
		MIN	NOM	MAX	MIN	NOM	MAX	
V_{CC}	Supply voltage	4.5	5	5.5	4.5	5	5.5	V
V_{IH}	High-level input voltage	2			2			V
V_{IL}	Low-level input voltage			0.8			0.8	V
I_{OH}	High-level output current			–12			–15	mA
I_{OL}	Low-level output current			32			48	mA
f_{clock}^*	Clock frequency	0		100	0		90	MHz
t_w^*	Pulse duration	CLK high		5	5.5		ns	
		CLK low		4	5.5			
t_{su}^*	Setup time before CLK↑	Data		3	5.5		ns	
		'AS575, \overline{CLR} high or low		6.5	6.5			
t_h^*	Hold time after CLK↑	Data		3	3		ns	
		'AS575, \overline{CLR}		0	0			
T_A	Operating free-air temperature	–55		125	0		70	°C

* On products compliant to MIL-STD-883, Class B, this parameter is based on characterization data but is not production tested.



SN54ALS574B, SN54AS574, SN54AS575
SN74ALS574B, SN74ALS575A, SN74AS574, SN74AS575
OCTAL D-TYPE EDGE-TRIGGERED FLIP-FLOPS WITH 3-STATE OUTPUTS

SDAS165B – JUNE 1982 – REVISED JULY 1995

electrical characteristics over recommended operating free-air temperature range (unless otherwise noted)

PARAMETER	TEST CONDITIONS		SN54AS574 SN54AS575		SN74AS574 SN74AS575		UNIT	
			MIN	TYP†	MAX	MIN		TYP†
V_{IK}	$V_{CC} = 4.5\text{ V}$, $I_I = -18\text{ mA}$		-1.2		-1.2		V	
V_{OH}	$V_{CC} = 4.5\text{ V to }5.5\text{ V}$, $I_{OH} = -2\text{ mA}$		$V_{CC} - 2$		$V_{CC} - 2$		V	
	$V_{CC} = 4.5\text{ V}$	$I_{OH} = -12\text{ mA}$	2.4	3.2				
		$I_{OH} = -15\text{ mA}$			2.4	3.3		
V_{OL}	$V_{CC} = 4.5\text{ V}$	$I_{OL} = 32\text{ mA}$	0.29	0.5			V	
		$I_{OL} = 48\text{ mA}$			0.34	0.5		
I_{OZH}	$V_{CC} = 5.5\text{ V}$, $V_O = 2.7\text{ V}$	50		50		μA		
I_{OZL}	$V_{CC} = 5.5\text{ V}$, $V_O = 0.4\text{ V}$	-50		-50		μA		
I_I	$V_{CC} = 5.5\text{ V}$, $V_I = 7\text{ V}$	0.1		0.1		mA		
I_{IH}	$V_{CC} = 5.5\text{ V}$, $V_I = 2.7\text{ V}$	20		20		μA		
I_{IL}	\overline{OE} , CLK, \overline{CLR}	$V_{CC} = 5.5\text{ V}$, $V_I = 0.4\text{ V}$	-0.5		-0.5		mA	
	D		-3		-2			
$I_{O\ddagger}$	$V_{CC} = 5.5\text{ V}$, $V_O = 2.25\text{ V}$	-30	-112	-30	-112	mA		
I_{CC}	'AS574	$V_{CC} = 5.5\text{ V}$	Outputs high	73	116	73	116	mA
			Outputs low	85	134	85	134	
			Outputs disabled	84	134	84	134	
	'AS575	$V_{CC} = 5.5\text{ V}$	Outputs high	78	126	78	126	
			Outputs low	89	142	89	142	
			Outputs disabled	88	142	88	142	

† All typical values are at $V_{CC} = 5\text{ V}$, $T_A = 25^\circ\text{C}$.

‡ The output conditions have been chosen to produce a current that closely approximates one half of the true short-circuit output current, I_{OS} .

switching characteristics (see Figure 1)

PARAMETER	FROM (INPUT)	TO (OUTPUT)	$V_{CC} = 4.5\text{ V to }5.5\text{ V}$, $C_L = 50\text{ pF}$, $R_1 = 500\ \Omega$, $R_2 = 500\ \Omega$, $T_A = \text{MIN to MAX}\S$				UNIT
			SN54AS574 SN54AS575		SN74AS574 SN74AS575		
			MIN	MAX	MIN	MAX	
f_{max}^*			100		90	MHz	
t_{PLH}	CLK	Any Q	3	11	3	8	ns
t_{PHL}			4	11	4	9	
t_{PZH}	\overline{OE}	Any Q	2	7	2	6	ns
t_{PZL}			3	11	3	10	
t_{PHZ}	\overline{OE}	Any Q	2	7	2	6	ns
t_{PLZ}			2	7	2	6	

* On products compliant to MIL-STD-883, Class B, this parameter is based on characterization data but is not production tested.

§ For conditions shown as MIN or MAX, use the appropriate value specified under recommended operating conditions.



SN54ALS574B, SN54AS574, SN54AS575
 SN74ALS574B, SN74ALS575A, SN74AS574, SN74AS575
 OCTAL D-TYPE EDGE-TRIGGERED FLIP-FLOPS WITH 3-STATE OUTPUTS

SDAS165B – JUNE 1982 – REVISED JULY 1995

**PARAMETER MEASUREMENT INFORMATION
 SERIES 54ALS/74ALS AND 54AS/74AS DEVICES**

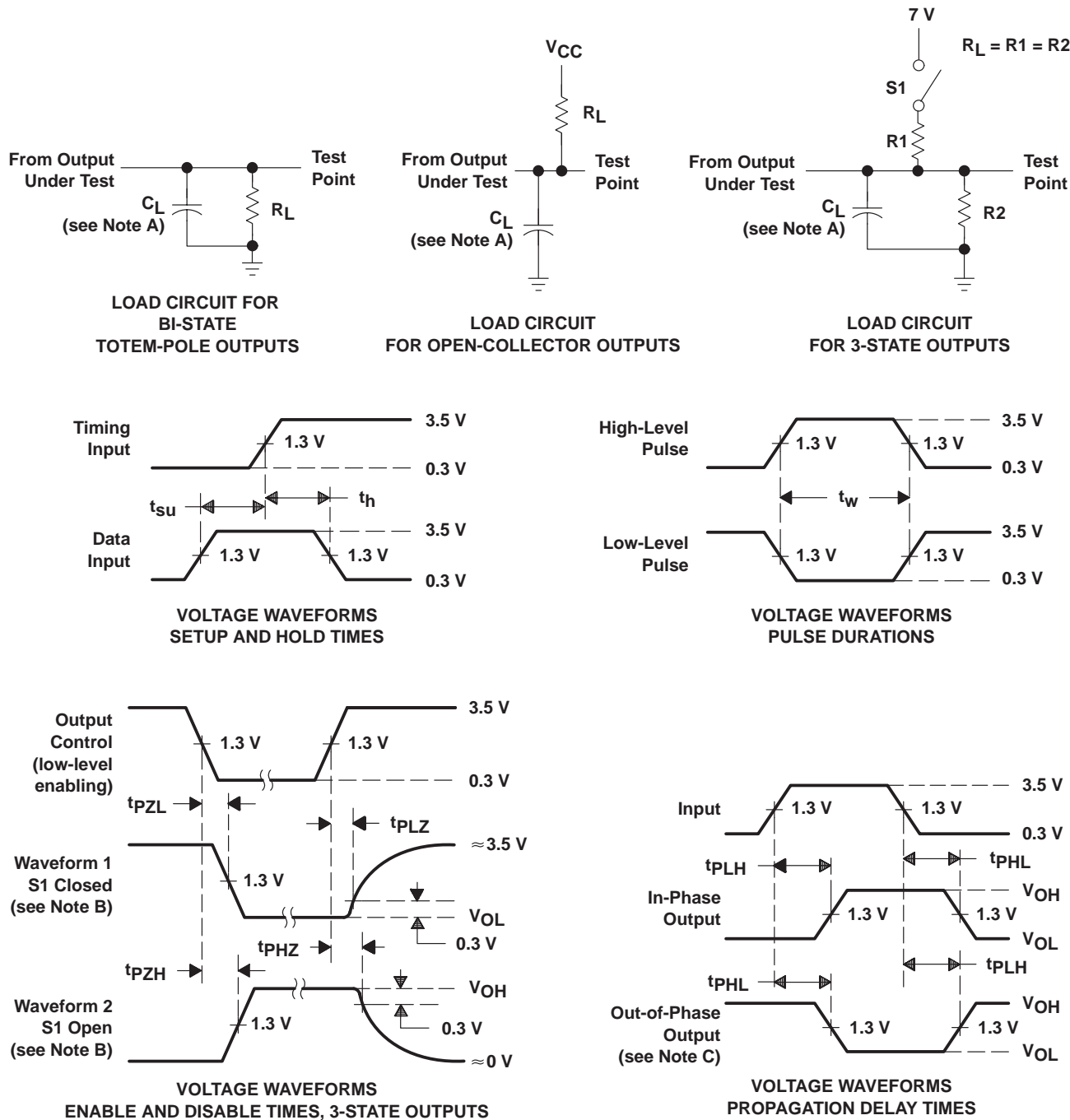

- NOTES: A. C_L includes probe and jig capacitance.
 B. Waveform 1 is for an output with internal conditions such that the output is low except when disabled by the output control. Waveform 2 is for an output with internal conditions such that the output is high except when disabled by the output control.
 C. When measuring propagation delay items of 3-state outputs, switch S1 is open.
 D. All input pulses have the following characteristics: $PRR \leq 1$ MHz, $t_r = t_f = 2$ ns, duty cycle = 50%.
 E. The outputs are measured one at a time with one transition per measurement.

Figure 1. Load Circuits and Voltage Waveforms

PACKAGING INFORMATION

Orderable Device	Status (1)	Package Type	Package Drawing	Pins	Package Qty	Eco Plan (2)	Lead/Ball Finish	MSL Peak Temp (3)	Op Temp (°C)	Device Marking (4/5)	Samples
84001012A	ACTIVE	LCCC	FK	20	1	TBD	POST-PLATE	N / A for Pkg Type	-55 to 125	84001012A SNJ54ALS 574BFK	Samples
8400101RA	ACTIVE	CDIP	J	20	1	TBD	A42	N / A for Pkg Type	-55 to 125	8400101RA SNJ54ALS574BJ	Samples
8400101SA	ACTIVE	CFP	W	20	1	TBD	Call TI	N / A for Pkg Type	-55 to 125	8400101SA SNJ54ALS574BW	Samples
JM38510/37104B2A	ACTIVE	LCCC	FK	20	1	TBD	POST-PLATE	N / A for Pkg Type	-55 to 125	JM38510/ 37104B2A	Samples
JM38510/37104BRA	ACTIVE	CDIP	J	20	1	TBD	A42	N / A for Pkg Type	-55 to 125	JM38510/ 37104BRA	Samples
M38510/37104B2A	ACTIVE	LCCC	FK	20	1	TBD	POST-PLATE	N / A for Pkg Type	-55 to 125	JM38510/ 37104B2A	Samples
M38510/37104BRA	ACTIVE	CDIP	J	20	1	TBD	A42	N / A for Pkg Type	-55 to 125	JM38510/ 37104BRA	Samples
SN54ALS574BJ	ACTIVE	CDIP	J	20	1	TBD	A42	N / A for Pkg Type	-55 to 125	SN54ALS574BJ	Samples
SN54AS574J	ACTIVE	CDIP	J	20	1	TBD	A42	N / A for Pkg Type	-55 to 125	SN54AS574J	Samples
SN54AS575JT	OBSOLETE	CDIP	JT	24		TBD	Call TI	Call TI	-55 to 125		
SN74ALS574BDW	ACTIVE	SOIC	DW	20	25	Green (RoHS & no Sb/Br)	CU NIPDAU	Level-1-260C-UNLIM	0 to 70	ALS574B	Samples
SN74ALS574BDWE4	ACTIVE	SOIC	DW	20	25	Green (RoHS & no Sb/Br)	CU NIPDAU	Level-1-260C-UNLIM	0 to 70	ALS574B	Samples
SN74ALS574BDWG4	ACTIVE	SOIC	DW	20	25	Green (RoHS & no Sb/Br)	CU NIPDAU	Level-1-260C-UNLIM	0 to 70	ALS574B	Samples
SN74ALS574BDWR	ACTIVE	SOIC	DW	20	2000	Green (RoHS & no Sb/Br)	CU NIPDAU	Level-1-260C-UNLIM	0 to 70	ALS574B	Samples
SN74ALS574BDWRE4	ACTIVE	SOIC	DW	20	2000	Green (RoHS & no Sb/Br)	CU NIPDAU	Level-1-260C-UNLIM	0 to 70	ALS574B	Samples
SN74ALS574BDWRG4	ACTIVE	SOIC	DW	20	2000	Green (RoHS & no Sb/Br)	CU NIPDAU	Level-1-260C-UNLIM	0 to 70	ALS574B	Samples
SN74ALS574BN	ACTIVE	PDIP	N	20	20	Pb-Free (RoHS)	CU NIPDAU	N / A for Pkg Type	0 to 70	SN74ALS574BN	Samples
SN74ALS574BN3	OBSOLETE	PDIP	N	20		TBD	Call TI	Call TI	0 to 70		

Orderable Device	Status (1)	Package Type	Package Drawing	Pins	Package Qty	Eco Plan (2)	Lead/Ball Finish	MSL Peak Temp (3)	Op Temp (°C)	Device Marking (4/5)	Samples
SN74ALS574BNE4	ACTIVE	PDIP	N	20	20	Pb-Free (RoHS)	CU NIPDAU	N / A for Pkg Type	0 to 70	SN74ALS574BN	Samples
SN74ALS574BNSR	ACTIVE	SO	NS	20	2000	Green (RoHS & no Sb/Br)	CU NIPDAU	Level-1-260C-UNLIM	0 to 70	ALS574B	Samples
SN74ALS574BNSRE4	ACTIVE	SO	NS	20	2000	Green (RoHS & no Sb/Br)	CU NIPDAU	Level-1-260C-UNLIM	0 to 70	ALS574B	Samples
SN74ALS574BNSRG4	ACTIVE	SO	NS	20	2000	Green (RoHS & no Sb/Br)	CU NIPDAU	Level-1-260C-UNLIM	0 to 70	ALS574B	Samples
SN74ALS575ADW	ACTIVE	SOIC	DW	24	25	Green (RoHS & no Sb/Br)	CU NIPDAU	Level-1-260C-UNLIM	0 to 70	ALS575A	Samples
SN74ALS575ADWE4	ACTIVE	SOIC	DW	24	25	Green (RoHS & no Sb/Br)	CU NIPDAU	Level-1-260C-UNLIM	0 to 70	ALS575A	Samples
SN74ALS575ADWG4	ACTIVE	SOIC	DW	24	25	Green (RoHS & no Sb/Br)	CU NIPDAU	Level-1-260C-UNLIM	0 to 70	ALS575A	Samples
SN74ALS575ANT	ACTIVE	PDIP	NT	24	15	Pb-Free (RoHS)	CU NIPDAU	N / A for Pkg Type	0 to 70	SN74ALS575ANT	Samples
SN74ALS575ANTE4	ACTIVE	PDIP	NT	24	15	Pb-Free (RoHS)	CU NIPDAU	N / A for Pkg Type	0 to 70	SN74ALS575ANT	Samples
SN74AS574DW	ACTIVE	SOIC	DW	20	25	Green (RoHS & no Sb/Br)	CU NIPDAU	Level-1-260C-UNLIM	0 to 70	AS574	Samples
SN74AS574DWE4	ACTIVE	SOIC	DW	20	25	Green (RoHS & no Sb/Br)	CU NIPDAU	Level-1-260C-UNLIM	0 to 70	AS574	Samples
SN74AS574DWG4	ACTIVE	SOIC	DW	20	25	Green (RoHS & no Sb/Br)	CU NIPDAU	Level-1-260C-UNLIM	0 to 70	AS574	Samples
SN74AS574DWR	ACTIVE	SOIC	DW	20	2000	Green (RoHS & no Sb/Br)	CU NIPDAU	Level-1-260C-UNLIM	0 to 70	AS574	Samples
SN74AS574DWRE4	ACTIVE	SOIC	DW	20	2000	Green (RoHS & no Sb/Br)	CU NIPDAU	Level-1-260C-UNLIM	0 to 70	AS574	Samples
SN74AS574DWRG4	ACTIVE	SOIC	DW	20	2000	Green (RoHS & no Sb/Br)	CU NIPDAU	Level-1-260C-UNLIM	0 to 70	AS574	Samples
SN74AS574N	ACTIVE	PDIP	N	20	20	Pb-Free (RoHS)	CU NIPDAU	N / A for Pkg Type	0 to 70	SN74AS574N	Samples
SN74AS574NE4	ACTIVE	PDIP	N	20	20	Pb-Free (RoHS)	CU NIPDAU	N / A for Pkg Type	0 to 70	SN74AS574N	Samples
SN74AS575DW	OBSOLETE	SOIC	DW	24		TBD	Call TI	Call TI	0 to 70		
SN74AS575DWR	OBSOLETE	SOIC	DW	24		TBD	Call TI	Call TI	0 to 70		

Orderable Device	Status (1)	Package Type	Package Drawing	Pins	Package Qty	Eco Plan (2)	Lead/Ball Finish	MSL Peak Temp (3)	Op Temp (°C)	Device Marking (4/5)	Samples
SN74AS575NT	OBSOLETE	PDIP	NT	24		TBD	Call TI	Call TI	0 to 70		
SNJ54ALS574BFK	ACTIVE	LCCC	FK	20	1	TBD	POST-PLATE	N / A for Pkg Type	-55 to 125	84001012A SNJ54ALS 574BFK	Samples
SNJ54ALS574BJ	ACTIVE	CDIP	J	20	1	TBD	A42	N / A for Pkg Type	-55 to 125	8400101RA SNJ54ALS574BJ	Samples
SNJ54ALS574BW	ACTIVE	CFP	W	20	1	TBD	Call TI	N / A for Pkg Type	-55 to 125	8400101SA SNJ54ALS574BW	Samples
SNJ54AS574FK	ACTIVE	LCCC	FK	20	1	TBD	POST-PLATE	N / A for Pkg Type	-55 to 125	SNJ54AS 574FK	Samples
SNJ54AS574J	ACTIVE	CDIP	J	20	1	TBD	A42	N / A for Pkg Type	-55 to 125	SNJ54AS574J	Samples
SNJ54AS575FK	OBSOLETE	LCCC	FK	28		TBD	Call TI	Call TI	-55 to 125		
SNJ54AS575JT	OBSOLETE	CDIP	JT	24		TBD	Call TI	Call TI	-55 to 125		
SNJ54AS575W	OBSOLETE	CFP	W	24		TBD	Call TI	Call TI	-55 to 125		

(1) The marketing status values are defined as follows:

ACTIVE: Product device recommended for new designs.

LIFEBUY: TI has announced that the device will be discontinued, and a lifetime-buy period is in effect.

NRND: Not recommended for new designs. Device is in production to support existing customers, but TI does not recommend using this part in a new design.

PREVIEW: Device has been announced but is not in production. Samples may or may not be available.

OBSOLETE: TI has discontinued the production of the device.

(2) Eco Plan - The planned eco-friendly classification: Pb-Free (RoHS), Pb-Free (RoHS Exempt), or Green (RoHS & no Sb/Br) - please check <http://www.ti.com/productcontent> for the latest availability information and additional product content details.

TBD: The Pb-Free/Green conversion plan has not been defined.

Pb-Free (RoHS): TI's terms "Lead-Free" or "Pb-Free" mean semiconductor products that are compatible with the current RoHS requirements for all 6 substances, including the requirement that lead not exceed 0.1% by weight in homogeneous materials. Where designed to be soldered at high temperatures, TI Pb-Free products are suitable for use in specified lead-free processes.

Pb-Free (RoHS Exempt): This component has a RoHS exemption for either 1) lead-based flip-chip solder bumps used between the die and package, or 2) lead-based die adhesive used between the die and leadframe. The component is otherwise considered Pb-Free (RoHS compatible) as defined above.

Green (RoHS & no Sb/Br): TI defines "Green" to mean Pb-Free (RoHS compatible), and free of Bromine (Br) and Antimony (Sb) based flame retardants (Br or Sb do not exceed 0.1% by weight in homogeneous material)

(3) MSL, Peak Temp. -- The Moisture Sensitivity Level rating according to the JEDEC industry standard classifications, and peak solder temperature.

(4) There may be additional marking, which relates to the logo, the lot trace code information, or the environmental category on the device.

⁽⁵⁾ Multiple Device Markings will be inside parentheses. Only one Device Marking contained in parentheses and separated by a "-" will appear on a device. If a line is indented then it is a continuation of the previous line and the two combined represent the entire Device Marking for that device.

Important Information and Disclaimer:The information provided on this page represents TI's knowledge and belief as of the date that it is provided. TI bases its knowledge and belief on information provided by third parties, and makes no representation or warranty as to the accuracy of such information. Efforts are underway to better integrate information from third parties. TI has taken and continues to take reasonable steps to provide representative and accurate information but may not have conducted destructive testing or chemical analysis on incoming materials and chemicals. TI and TI suppliers consider certain information to be proprietary, and thus CAS numbers and other limited information may not be available for release.

In no event shall TI's liability arising out of such information exceed the total purchase price of the TI part(s) at issue in this document sold by TI to Customer on an annual basis.

OTHER QUALIFIED VERSIONS OF SN54ALS574B, SN54AS574, SN54AS575, SN74ALS574B, SN74AS574, SN74AS575 :

- Catalog: [SN74ALS574B](#), [SN74AS574](#), [SN74AS575](#)
- Military: [SN54ALS574B](#), [SN54AS574](#), [SN54AS575](#)

NOTE: Qualified Version Definitions:

- Catalog - TI's standard catalog product
- Military - QML certified for Military and Defense Applications

TAPE AND REEL INFORMATION

QUADRANT ASSIGNMENTS FOR PIN 1 ORIENTATION IN TAPE

*All dimensions are nominal

Device	Package Type	Package Drawing	Pins	SPQ	Reel Diameter (mm)	Reel Width W1 (mm)	A0 (mm)	B0 (mm)	K0 (mm)	P1 (mm)	W (mm)	Pin1 Quadrant
SN74ALS574BDWR	SOIC	DW	20	2000	330.0	24.4	10.8	13.0	2.7	12.0	24.0	Q1
SN74ALS574BNSR	SO	NS	20	2000	330.0	24.4	8.2	13.0	2.5	12.0	24.0	Q1
SN74AS574DWR	SOIC	DW	20	2000	330.0	24.4	10.8	13.0	2.7	12.0	24.0	Q1

TAPE AND REEL BOX DIMENSIONS

*All dimensions are nominal

Device	Package Type	Package Drawing	Pins	SPQ	Length (mm)	Width (mm)	Height (mm)
SN74ALS574BDWR	SOIC	DW	20	2000	367.0	367.0	45.0
SN74ALS574BNSR	SO	NS	20	2000	367.0	367.0	45.0
SN74AS574DWR	SOIC	DW	20	2000	367.0	367.0	45.0

J (R-GDIP-T**)

14 LEADS SHOWN

CERAMIC DUAL IN-LINE PACKAGE



DIM \ PINS **	14	16	18	20
A	0.300 (7,62) BSC	0.300 (7,62) BSC	0.300 (7,62) BSC	0.300 (7,62) BSC
B MAX	0.785 (19,94)	.840 (21,34)	0.960 (24,38)	1.060 (26,92)
B MIN	—	—	—	—
C MAX	0.300 (7,62)	0.300 (7,62)	0.310 (7,87)	0.300 (7,62)
C MIN	0.245 (6,22)	0.245 (6,22)	0.220 (5,59)	0.245 (6,22)



4040083/F 03/03

- NOTES:
- All linear dimensions are in inches (millimeters).
 - This drawing is subject to change without notice.
 - This package is hermetically sealed with a ceramic lid using glass frit.
 - Index point is provided on cap for terminal identification only on press ceramic glass frit seal only.
 - Falls within MIL STD 1835 GDIP1-T14, GDIP1-T16, GDIP1-T18 and GDIP1-T20.

JT (R-GDIP-T**)

CERAMIC DUAL-IN-LINE

24 LEADS SHOWN



- NOTES: A. All linear dimensions are in inches (millimeters).
 B. This drawing is subject to change without notice.
 C. This package can be hermetically sealed with a ceramic lid using glass frit.
 D. Index point is provided on cap for terminal identification.
 E. Falls within MIL STD 1835 GDIP3-T24, GDIP4-T28, and JEDEC MO-058 AA, MO-058 AB

W (R-GDFP-F20)

CERAMIC DUAL FLATPACK



- NOTES:
- A. All linear dimensions are in inches (millimeters).
 - B. This drawing is subject to change without notice.
 - C. This package can be hermetically sealed with a ceramic lid using glass frit.
 - D. Index point is provided on cap for terminal identification only.
 - E. Falls within Mil-Std 1835 GDFP2-F20

W (R-GDFP-F24)

CERAMIC DUAL FLATPACK

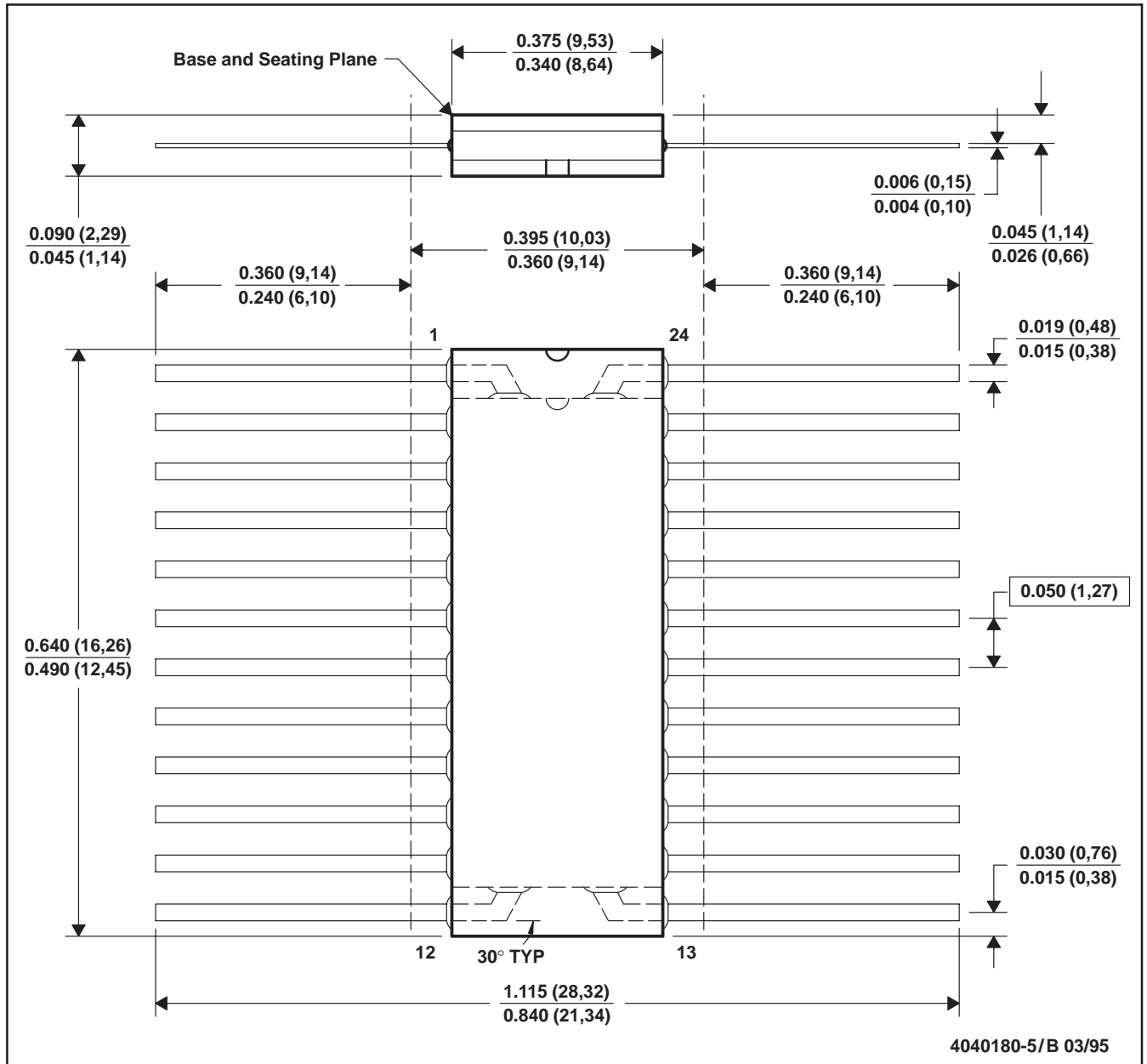

- NOTES: A. All linear dimensions are in inches (millimeters).
 B. This drawing is subject to change without notice.
 C. This package can be hermetically sealed with a ceramic lid using glass frit.
 D. Falls within MIL-STD-1835 GDFP2-F24 and JEDEC MO-070AD
 E. Index point is provided on cap for terminal identification only.

FK (S-CQCC-N**)

LEADLESS CERAMIC CHIP CARRIER

28 TERMINAL SHOWN



NO. OF TERMINALS **	A		B	
	MIN	MAX	MIN	MAX
20	0.342 (8,69)	0.358 (9,09)	0.307 (7,80)	0.358 (9,09)
28	0.442 (11,23)	0.458 (11,63)	0.406 (10,31)	0.458 (11,63)
44	0.640 (16,26)	0.660 (16,76)	0.495 (12,58)	0.560 (14,22)
52	0.740 (18,78)	0.761 (19,32)	0.495 (12,58)	0.560 (14,22)
68	0.938 (23,83)	0.962 (24,43)	0.850 (21,6)	0.858 (21,8)
84	1.141 (28,99)	1.165 (29,59)	1.047 (26,6)	1.063 (27,0)



4040140/D 01/11

- NOTES:
- All linear dimensions are in inches (millimeters).
 - This drawing is subject to change without notice.
 - This package can be hermetically sealed with a metal lid.
 - Falls within JEDEC MS-004

N (R-PDIP-T**)

PLASTIC DUAL-IN-LINE PACKAGE

16 PINS SHOWN



- NOTES:
- A. All linear dimensions are in inches (millimeters).
 - B. This drawing is subject to change without notice.
 - (C) Falls within JEDEC MS-001, except 18 and 20 pin minimum body length (Dim A).
 - (D) The 20 pin end lead shoulder width is a vendor option, either half or full width.

4040049/E 12/2002

MECHANICAL DATA

NT (R-PDIP-T**) 24 PINS SHOWN

PLASTIC DUAL-IN-LINE PACKAGE



- NOTES:
- A. All linear dimensions are in millimeters. Dimensioning and tolerancing per ASME Y14.5M-1994.
 - B. This drawing is subject to change without notice.
 -  The 28 pin end lead shoulder width is a vendor option, either half or full width.

DW (R-PDSO-G20)

PLASTIC SMALL OUTLINE



- NOTES:
- A. All linear dimensions are in inches (millimeters). Dimensioning and tolerancing per ASME Y14.5M-1994.
 - B. This drawing is subject to change without notice.
 - C. Body dimensions do not include mold flash or protrusion not to exceed 0.006 (0,15).
 - D. Falls within JEDEC MS-013 variation AC.

DW (R-PDSO-G20)

PLASTIC SMALL OUTLINE

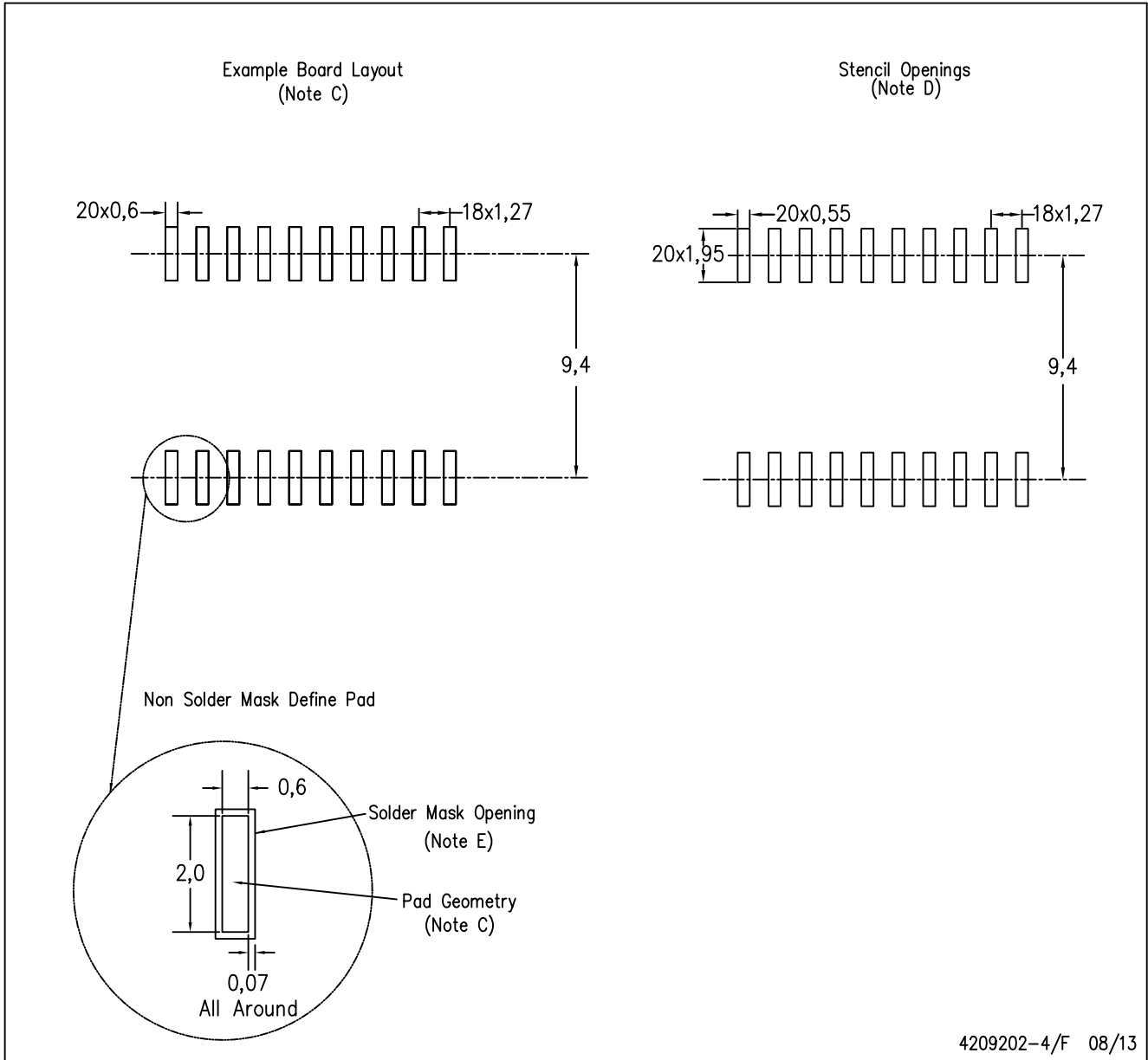

4209202-4/F 08/13

- NOTES:
- A. All linear dimensions are in millimeters.
 - B. This drawing is subject to change without notice.
 - C. Refer to IPC7351 for alternate board design.
 - D. Laser cutting apertures with trapezoidal walls and also rounding corners will offer better paste release. Customers should contact their board assembly site for stencil design recommendations. Refer to IPC-7525
 - E. Customers should contact their board fabrication site for solder mask tolerances between and around signal pads.

DW (R-PDSO-G24)

PLASTIC SMALL OUTLINE



- NOTES:
- A. All linear dimensions are in inches (millimeters). Dimensioning and tolerancing per ASME Y14.5M-1994.
 - B. This drawing is subject to change without notice.
 - C. Body dimensions do not include mold flash or protrusion not to exceed 0.006 (0,15).
 - D. Falls within JEDEC MS-013 variation AD.

MECHANICAL DATA

NS (R-PDSO-G**)

PLASTIC SMALL-OUTLINE PACKAGE

14-PINS SHOWN



- NOTES:
- A. All linear dimensions are in millimeters.
 - B. This drawing is subject to change without notice.
 - C. Body dimensions do not include mold flash or protrusion, not to exceed 0,15.

IMPORTANT NOTICE

Texas Instruments Incorporated and its subsidiaries (TI) reserve the right to make corrections, enhancements, improvements and other changes to its semiconductor products and services per JESD46, latest issue, and to discontinue any product or service per JESD48, latest issue. Buyers should obtain the latest relevant information before placing orders and should verify that such information is current and complete. All semiconductor products (also referred to herein as "components") are sold subject to TI's terms and conditions of sale supplied at the time of order acknowledgment.

TI warrants performance of its components to the specifications applicable at the time of sale, in accordance with the warranty in TI's terms and conditions of sale of semiconductor products. Testing and other quality control techniques are used to the extent TI deems necessary to support this warranty. Except where mandated by applicable law, testing of all parameters of each component is not necessarily performed.

TI assumes no liability for applications assistance or the design of Buyers' products. Buyers are responsible for their products and applications using TI components. To minimize the risks associated with Buyers' products and applications, Buyers should provide adequate design and operating safeguards.

TI does not warrant or represent that any license, either express or implied, is granted under any patent right, copyright, mask work right, or other intellectual property right relating to any combination, machine, or process in which TI components or services are used. Information published by TI regarding third-party products or services does not constitute a license to use such products or services or a warranty or endorsement thereof. Use of such information may require a license from a third party under the patents or other intellectual property of the third party, or a license from TI under the patents or other intellectual property of TI.

Reproduction of significant portions of TI information in TI data books or data sheets is permissible only if reproduction is without alteration and is accompanied by all associated warranties, conditions, limitations, and notices. TI is not responsible or liable for such altered documentation. Information of third parties may be subject to additional restrictions.

Resale of TI components or services with statements different from or beyond the parameters stated by TI for that component or service voids all express and any implied warranties for the associated TI component or service and is an unfair and deceptive business practice. TI is not responsible or liable for any such statements.

Buyer acknowledges and agrees that it is solely responsible for compliance with all legal, regulatory and safety-related requirements concerning its products, and any use of TI components in its applications, notwithstanding any applications-related information or support that may be provided by TI. Buyer represents and agrees that it has all the necessary expertise to create and implement safeguards which anticipate dangerous consequences of failures, monitor failures and their consequences, lessen the likelihood of failures that might cause harm and take appropriate remedial actions. Buyer will fully indemnify TI and its representatives against any damages arising out of the use of any TI components in safety-critical applications.

In some cases, TI components may be promoted specifically to facilitate safety-related applications. With such components, TI's goal is to help enable customers to design and create their own end-product solutions that meet applicable functional safety standards and requirements. Nonetheless, such components are subject to these terms.

No TI components are authorized for use in FDA Class III (or similar life-critical medical equipment) unless authorized officers of the parties have executed a special agreement specifically governing such use.

Only those TI components which TI has specifically designated as military grade or "enhanced plastic" are designed and intended for use in military/aerospace applications or environments. Buyer acknowledges and agrees that any military or aerospace use of TI components which have **not** been so designated is solely at the Buyer's risk, and that Buyer is solely responsible for compliance with all legal and regulatory requirements in connection with such use.

TI has specifically designated certain components as meeting ISO/TS16949 requirements, mainly for automotive use. In any case of use of non-designated products, TI will not be responsible for any failure to meet ISO/TS16949.

Products

Audio	www.ti.com/audio
Amplifiers	amplifier.ti.com
Data Converters	dataconverter.ti.com
DLP® Products	www.dlp.com
DSP	dsp.ti.com
Clocks and Timers	www.ti.com/clocks
Interface	interface.ti.com
Logic	logic.ti.com
Power Mgmt	power.ti.com
Microcontrollers	microcontroller.ti.com
RFID	www.ti-rfid.com
OMAP Applications Processors	www.ti.com/omap
Wireless Connectivity	www.ti.com/wirelessconnectivity

Applications

Automotive and Transportation	www.ti.com/automotive
Communications and Telecom	www.ti.com/communications
Computers and Peripherals	www.ti.com/computers
Consumer Electronics	www.ti.com/consumer-apps
Energy and Lighting	www.ti.com/energy
Industrial	www.ti.com/industrial
Medical	www.ti.com/medical
Security	www.ti.com/security
Space, Avionics and Defense	www.ti.com/space-avionics-defense
Video and Imaging	www.ti.com/video

TI E2E Community

e2e.ti.com



Стандарт Электрон Связь

Мы молодая и активно развивающаяся компания в области поставок электронных компонентов. Мы поставляем электронные компоненты отечественного и импортного производства напрямую от производителей и с крупнейших складов мира.

Благодаря сотрудничеству с мировыми поставщиками мы осуществляем комплексные и плановые поставки широчайшего спектра электронных компонентов.

Собственная эффективная логистика и склад в обеспечивает надежную поставку продукции в точно указанные сроки по всей России.

Мы осуществляем техническую поддержку нашим клиентам и предпродажную проверку качества продукции. На все поставляемые продукты мы предоставляем гарантию .

Осуществляем поставки продукции под контролем ВП МО РФ на предприятия военно-промышленного комплекса России , а также работаем в рамках 275 ФЗ с открытием отдельных счетов в уполномоченном банке. Система менеджмента качества компании соответствует требованиям ГОСТ ISO 9001.

Минимальные сроки поставки, гибкие цены, неограниченный ассортимент и индивидуальный подход к клиентам являются основой для выстраивания долгосрочного и эффективного сотрудничества с предприятиями радиоэлектронной промышленности, предприятиями ВПК и научно-исследовательскими институтами России.

С нами вы становитесь еще успешнее!

Наши контакты:

Телефон: +7 812 627 14 35

Электронная почта: sales@st-electron.ru

Адрес: 198099, Санкт-Петербург,
Промышленная ул, дом № 19, литера Н,
помещение 100-Н Офис 331