

Tantalum & Aluminum Surface Mount Capacitors

Low ESR



One world. One KEMET.

The Capacitance Company
KEMET
CHARGED.®

| Table of Contents | Page |
|--|------------|
| Why Choose KEMET | 3 |
| MnO₂ | |
| T494 Industrial Grade Low ESR MnO ₂ Series..... | 9 |
| T495 Surge Robust Low ESR MnO ₂ Series | 25 |
| T510 Multiple Anode Low ESR MnO ₂ Series..... | 41 |
| Tantalum Stack MnO ₂ (TSM) Series | 50 |
| Polymer | |
| T520 Series Polymer Tantalum | 60 |
| T521 High Voltage Polymer Tantalum | 77 |
| T522 Reduced Leakage Polymer Tantalum | 86 |
| T525 125°C Rated Polymer Tantalum | 95 |
| T528 Low ESL/Facedown Terminal Polymer Tantalum | 104 |
| T530 High Capacitance/125°C Rated Polymer Tantalum..... | 113 |
| T543 Series Polymer Tantalum COTS | 123 |
| T545 Series High Energy Polymer Tantalum | 142 |
| Tantalum Stack Polymer (TSP) Series | 151 |
| KEMET Organic Capacitor (AO-CAP) | |
| A700 Series Polymer Aluminum..... | 161 |
| Packaging Information..... | 172 |
| Packaging Information for T520 and T522 | 177 |
| KEMET Corporation Sales Offices | 182 |
| Other KEMET Resources..... | 183 |



One world. One source. One KEMET.

No bouncing from supplier to supplier to find what you need. No multiple web sites and phone calls to get answers.

When you partner with KEMET, our entire global organization seamlessly provides you with the coordinated action and service you need. We're your single, integrated source for capacitance solutions worldwide, offering 95% of possible dielectric solutions, to cover practically any application. With new, innovative products year after year after year. Global availability. Full design collaboration, with fast custom design and prototyping to give your new products a competitive edge. Plus consistent quality, reliability and on-time delivery.

All from one company that's easy to work with and totally dedicated to your success. For anything to do with capacitance, call *The Capacitance Company* – KEMET.



Looking for a hassle-free source for 95% of possible dielectric solutions?

KEMET is the place for one-stop dielectric shopping. We offer our customers the broadest selection of capacitor technologies in the industry, including tantalum, ceramic, aluminum, electrolytic, film and paper.

But the range of products is only the beginning. You simply won't find an electronic components manufacturer more determined to find new technological solutions to customer problems, or more committed to product quality and on-time delivery – in every case, lowering your total cost of ownership as much as we possibly can. It's how we've helped customers succeed for more than 90 years. And it's how we're helping them succeed today.



We're everywhere you need us to be.

AMERICA

Canada
Mexico
USA

EMEA

Bulgaria
Finland
France
Germany
Italy
Portugal
Sweden
Switzerland
United Kingdom

ASIA-PACIFIC

China
Hong Kong
India
Indonesia
Japan
Malaysia
Singapore
Taiwan

The next time you board an airplane, boot up your computer or read about a breakthrough medical device, a piece of our technology is likely involved. KEMET customers include nearly all of the world's major electronics original equipment manufacturers, manufacturing services companies and electronics distributors. High Reliability versions of our capacitors are even in outer space, part of every important military and aerospace effort of the past 60 years, from the first Telstar satellite and Apollo 11 to the Patriot missile, International Space Station and Mars Pathfinder.

Our sales offices can't be quite as ubiquitous as our products, but we do pride ourselves on being where you need us. This map shows you our sales offices around the world.

As you can see, we're not only easy to work with, we're easy to find. And we're more than ready to be your single source capacitance solutions supplier.

One world. One source. One KEMET.



Why The Capacitance Company is also the “Easy-To-Buy-From” company.

When you choose KEMET, you'll enjoy a level of responsiveness you just won't get from any other component manufacturer. You simply won't find an electronic components manufacturer more passionate about customer service. Our innovative service offerings and superior localized support are known throughout the industry, powered by our global, customer-focused sales organization and worldwide logistics capabilities. We're 100% committed to serving any customer, anywhere, and meeting customer needs when they need to be met.

Whether you need rush samples, technical assistance, in-person consultations or accelerated custom design, design collaboration and prototype services, we have a solution. If it's anything to do with capacitance, we can help – and help fast.



Working to make a better world.

At KEMET, we're proud to work with customers to develop products that truly make the world a better, safer, more connected place to live – from hand-held devices to automotive systems to the greenest energy technology.

As a company, KEMET is dedicated to economically, environmentally and socially sustainable development. We've adopted the Electronic Industry Code of Conduct (EICC), addressing all aspects of corporate responsibility. All of our commercial-grade products are available in RoHS-compliant versions with Pb-free terminations. Our manufacturing facilities have won numerous environmental excellence awards and recognitions. And our supply chain is certified to be sourced from areas that are neither environmentally protected nor under conflict.

After all, we believe that doing the right thing is in everyone's interest.



Which capacitor is right for you?

As The Capacitance Company, we make over 95% of possible dielectric solutions – the broadest selection of capacitor technologies in the industry. By offering a wide variety of dielectrics, dimensions, voltages, temperature characteristics and terminations, KEMET capacitors satisfy an expansive range of customer requirements and applications.

In fact, if the capacitor you need hasn't been invented, it's only because you haven't asked. We can quickly develop custom products and carry out early-stage manufacturing through our accelerated collaboration services. Available through our global innovation and manufacturing centers around the world, accelerated collaboration brings together the necessary people, equipment and facilities together to get the job done, on time and in budget.

Of course, when you're under pressure to design smaller and smaller products with greater and greater functionality, there's no time for the traditional back-and-forth with your suppliers. With KEMET, you get direct contact to the engineers and other professionals who can help you successfully solve your design problems, and in record time. We deal personally with customers to ascertain the new part types needed for their next-generation products. In many cases, we can go from start to samples in only four months.

We've helped some of the world's most prominent electronics companies slash time to market and gain significant windows of competitive advantage. We can do the same for you, too.

Overview

The KEMET T494 Series is a lower ESR version of the popular T491 Series, designed specifically for today's highly automated surface mount processes and equipment. The T494 combines KEMET's proven solid tantalum technology, acclaimed and respected throughout the world, with the latest in materials, processes and automation, resulting in unsurpassed total performance and value. This product meets or exceeds the requirements of EIA Standard 535BAAC. The T494 standard terminations are available in 100% matte tin and provide

excellent wetting characteristics and compatibility with today's surface mount solder systems. Tin/lead (Sn/Pb) terminations are available upon request for any part number. Gold-plated terminations are also available for use with conductive epoxy attachment processes.

Standard packaging of these devices is tape and reel in accordance with EIA 481-1. This system provides perfect compatibility with all tape-fed placement units.

Benefits

- Meets or exceeds EIA Standard 535BAAC
- Taped and reeled per EIA 481-1
- Symmetrical, compliant terminations
- Optional gold-plated terminations
- Laser-marked case
- 100% surge current test on C, D, E, U, V, X sizes
- Halogen-free epoxy
- Capacitance values of 0.1 μ F to 1,000 μ F
- Tolerances of $\pm 10\%$ and $\pm 20\%$
- Voltage rating of 2.5 – 50 VDC
- Extended range values
- Low profile case sizes
- RoHS Compliant and lead-free terminations
- Operating temperature range of -55°C to +125°C

Applications

Typical applications include decoupling and filtering in industrial and automotive end applications, such as DC/DC converters, portable electronics, telecommunications, and control units.



Environmental Compliance

RoHS Compliant (6/6) according to Directive 2002/95/EC when ordered with 100% Sn Solder



RoHS Compliant

SPICE

For a detailed analysis of specific part numbers, please visit www.kemet.com for a free download of KEMET's SPICE software. The KEMET SPICE program is freeware intended to aid design engineers in analyzing the performance of these capacitors over frequency, temperature, ripple, and DC bias conditions.

Ordering Information

| T | 494 | T | 336 | M | 004 | A | T | |
|-----------------|----------------------|------------------------------|--|-----------------------|--|---------------------|---|------------------------------------|
| Capacitor Class | Series | Case Size | Capacitance Code (pF) | Capacitance Tolerance | Voltage | Failure Rate/Design | Lead Material | Packaging (C-Spec) |
| T = Tantalum | Industrial - Low ESR | A, B, C, D, E, S, T, U, V, X | First two digits represent significant figures. Third digit specifies number of zeros. | K = ±10% M = ±20% | 2R5 = 2.5 V 003 = 3 V 004 = 4 V 006 = 6.3 V 010 = 10 V 016 = 16 V 020 = 20 V 025 = 25 V 035 = 35 V 050 = 50 V | A = N/A | T = 100% Matte Tin (Sn) Plated H = Standard Solder Coated (SnPb 5% Pb minimum) G = Gold Plated (A, B, C, D, X only) | Blank = 7" Reel 7280 = 13" Reel |

Performance Characteristics

| Item | Performance Characteristics |
|-------------------------|---|
| Operating Temperature | -55°C to 125°C |
| Rated Capacitance Range | 0.1 – 1,000 µF @ 120 Hz/25°C |
| Capacitance Tolerance | K Tolerance (10%), M Tolerance (20%) |
| Rated Voltage Range | 2.5 – 50 V |
| DF (120 Hz) | Refer to Part Number Electrical Specification Table |
| ESR (100 kHz) | Refer to Part Number Electrical Specification Table |
| Leakage Current | ≤ 0.01 CV (µA) at rated voltage after 5 minutes |

Qualification

| Test | Condition | Characteristics | | | | |
|----------------------------|--|-----------------|------------------------------|-------|----------|----------|
| Endurance | 85°C @ rated voltage, 2,000 hours 125°C @ 2/3 rated voltage, 2,000 hours | Δ C/C | Within ±10% of initial value | | | |
| | | DF | Within initial limits | | | |
| | | DCL | Within 1.25 x initial limit | | | |
| | | ESR | Within initial limits | | | |
| Storage Life | 125°C @ 0 volts, 2,000 hours | Δ C/C | Within ±10% of initial value | | | |
| | | DF | Within initial limits | | | |
| | | DCL | Within 1.25 x initial limit | | | |
| | | ESR | Within initial limits | | | |
| Thermal Shock | MIL-STD-202, Method 107, Condition B, mounted, -55°C to 125°C, 1,000 cycles | Δ C/C | Within ±5% of initial value | | | |
| | | DF | Within initial limits | | | |
| | | DCL | Within 1.25 x initial limit | | | |
| | | ESR | Within initial limits | | | |
| Temperature Stability | Extreme temperature exposure at a succession of continuous steps at +25°C, -55°C, +25°C, +85°C, +125°C, +25°C. | +25°C | -55°C | +85°C | +125°C | |
| | | Δ C/C | IL* | ±10% | ±10% | ±20% |
| | | DF | IL | IL | 1.5 x IL | 1.5 x IL |
| Surge Voltage | 25°C and 85°C, 1.32 x rated voltage 1,000 cycles (125°C, 1.2 x rated voltage). | DCL | IL | | | |
| | | ESR | n/a | | | |
| | | DCL | 10 x IL | | | |
| Mechanical Shock/Vibration | MIL-STD-202, Method 213, Condition I, 100 G peak MIL-STD-202, Method 204, Condition D, 10 Hz to 2,000 Hz, 20 G peak | Δ C/C | Within ±10% of initial value | | | |
| | | DF | Within initial limits | | | |
| | | DCL | Within initial limits | | | |

*IL = Initial limit

Electrical Characteristics

ESR vs. Frequency



Capacitance vs. Frequency



Dimensions – Millimeters (Inches)

Metric will govern



| Case Size | | Component | | | | | | | | | | | | | |
|-----------|---------|----------------------------|----------------------------|----------------------------|--------------------|--------------------|-------------------------|------------------------------|------------|------------|-------------|-------------|------------|------------|--|
| KEMET | EIA | L* | W* | H* | F* ±0.1 ±(.004) | S* ±0.3 ±(.012) | B* ±0.15 (Ref) ±.006 | X (Ref) | P (Ref) | R (Ref) | T (Ref) | A (Min) | G (Ref) | E (Ref) | |
| A | 3216-18 | 3.2 ±0.2 (0.126 ±0.008) | 1.6 ±0.2 (0.063 ±0.008) | 1.6 ±0.2 (0.063 ±0.008) | 1.2 (.047) | 0.8 (.031) | 0.4 (.016) | 0.10 ±0.10 (0.004 ±0.004) | 0.4 (.016) | 0.4 (.016) | 0.13 (.005) | 0.8 (.31) | 1.1 (.043) | 1.3 (.051) | |
| B | 3528-21 | 3.5 ±0.2 (0.138 ±0.008) | 2.8 ±0.2 (0.110 ±0.008) | 1.9 ±0.2 (0.075 ±0.008) | 2.2 (.087) | 0.8 (.031) | 0.4 (.016) | 0.10 ±0.10 (0.004 ±0.004) | 0.5 (.020) | 1.0 (.039) | 0.13 (.005) | 1.1 (0.043) | 1.8 (.071) | 2.2 (.087) | |
| C | 6032-28 | 6.0 ±0.3 (0.236 ±0.03) | 3.2 ±0.3 (0.126 ±0.012) | 2.5 ±0.3 (0.098 ±0.012) | 2.2 (.087) | 1.3 (.051) | 0.5 (.020) | 0.10 ±0.10 (0.004 ±0.004) | 0.9 (.035) | 1.0 (.039) | 0.13 (.005) | 2.5(.098) | 2.8 (.110) | 2.4 (.094) | |
| D | 7343-31 | 7.3 ±0.3 (0.287 ±0.012) | 4.3 ±0.3 (0.169 ±0.012) | 2.8 ±0.3 (0.110 ±0.012) | 2.4 (.094) | 1.3 (.051) | 0.5 (.020) | 0.10 ±0.10 (0.004 ±0.004) | 0.9 (.035) | 1.0 (.039) | 0.13 (.005) | 3.8 (.150) | 3.5 (.138) | 3.5 (.138) | |
| X | 7343-43 | 7.3 ±0.3 (0.287 ±0.012) | 4.3 ±0.3 (0.169 ±0.012) | 4.0 ±0.3 (0.157 ±0.012) | 2.4 (.094) | 1.3 (.051) | 0.5 (.020) | 0.10 ±0.10 (0.004 ±0.004) | 1.7 (.067) | 1.0 (.039) | 0.13 (.005) | 3.8 (.150) | 3.5 (.138) | 3.5 (.138) | |
| E | 7360-38 | 7.3 ±0.3 (0.287 ±0.012) | 6.0 ±0.3 (0.236 ±0.012) | 3.6 ±0.2 (0.142 ±0.008) | 4.1 (.161) | 1.3 (.051) | 0.5 (.020) | 0.10 ±0.10 (0.004 ±0.004) | n/a | n/a | 0.13 (.005) | 3.8 (.150) | 3.5 (.138) | 3.5 (.138) | |
| S | 3216-12 | 3.2 ±0.2 (0.126 ±0.008) | 1.6 ±0.2 (0.063 ±0.008) | 1.2 (.047) | 1.2 (.047) | 0.8 (.031) | n/a | 0.05 (.002) | n/a | n/a | 0.13 (.005) | 0.8 (.031) | 1.1 (.043) | 1.3 (.051) | |
| T | 3528-12 | 3.5 ±0.2 (0.138 ±0.008) | 2.8 ±0.2 (0.110 ±0.008) | 1.2 (.047) | 2.2 (.087) | 0.8 (.031) | n/a | 0.05 (.002) | n/a | n/a | 0.13 (.005) | 1.1 (.043) | 1.8 (.071) | 2.2 (.087) | |
| U | 6032-15 | 6.0 ±0.3 (0.236 ±0.012) | 3.2 ±0.2 (0.110 ±0.008) | 1.5 (.059) | 2.2 (.087) | 1.3 (.051) | n/a | 0.05 (.002) | n/a | n/a | 0.13 (.005) | 2.5(.098) | 2.8 (.110) | 2.4 (.094) | |
| V | 7343-20 | 7.3 ±0.3 (0.287 ±0.012) | 4.3 ±0.3 (0.169 ±0.012) | 2.0 (.079) | 2.4 (.094) | 1.3 (.051) | n/a | 0.05 (.002) | n/a | n/a | 0.13 (.005) | 3.8 (.150) | 3.5 (.138) | 3.5 (.138) | |

Notes: (Ref) – Dimensions provided for reference only. No dimensions provided for B, P or R because low profile cases do not have a bevel or a notch.

* MIL-PRF-55365/8 specified dimensions

Table 1 – Ratings & Part Number Reference

| Rated Voltage | Rated Cap | Case Code/ Case Size | KEMET Part Number | DC Leakage | DF | ESR | Maximum Allowable Ripple Current | | | Moisture Sensitivity |
|---------------|-----------|-------------------------|------------------------------|------------------------|------------------------|-------------------------|----------------------------------|----------------------|-----------------------|------------------------|
| VDC | µF | KEMET/EIA | (See below for part options) | µA @ 20°C Max/5 Min | % @ 20°C 120 Hz Max | Ω @ 20°C 100 kHz Max | (mA) 100 kHz 25°C | (mA) 100 kHz 85°C | (mA) 100 kHz 125°C | Reflow Temp ≤ 260°C |
| 2.5 | 100 | T/3528-12 | T494T107(1)2R5A(2) | 2.5 | 24.0 | 3.5 | 141 | 127 | 56 | 1 |
| 2.5 | 220 | D/7343-31 | T494D227(1)2R5A(2) | 5.5 | 8.0 | 0.2 | 866 | 779 | 346 | 1 |
| 3 | 33 | A/3216-18 | T494A336(1)003A(2) | 1.0 | 6.0 | 2.0 | 194 | 175 | 78 | 1 |
| 4 | 3.3 | A/3216-18 | T494A335(1)004A(2) | 0.5 | 6.0 | 4.0 | 137 | 123 | 55 | 1 |
| 4 | 4.7 | A/3216-18 | T494A475(1)004A(2) | 0.5 | 6.0 | 3.5 | 146 | 131 | 58 | 1 |
| 4 | 6.8 | A/3216-18 | T494A685(1)004A(2) | 0.5 | 6.0 | 3.0 | 158 | 142 | 63 | 1 |
| 4 | 6.8 | S/3216-12 | T494S685(1)004A(2) | 0.5 | 6.0 | 7.0 | 93 | 84 | 37 | 1 |
| 4 | 10 | B/3528-21 | T494B106(1)004A(2) | 0.5 | 6.0 | 1.2 | 266 | 239 | 106 | 1 |
| 4 | 10 | A/3216-18 | T494A106(1)004A(2) | 0.5 | 6.0 | 2.0 | 194 | 175 | 78 | 1 |
| 4 | 10 | S/3216-12 | T494S106(1)004A(2) | 0.5 | 6.0 | 9.0 | 82 | 74 | 33 | 1 |
| 4 | 10 | R/2012-12 | T494R106(M)004A(2) | 0.5 | 8.0 | 6.0 | 65 | 59 | 26 | 1 |
| 4 | 15 | B/3528-21 | T494B156(1)004A(2) | 0.6 | 6.0 | 1.2 | 266 | 239 | 106 | 1 |
| 4 | 15 | A/3216-18 | T494A156(1)004A(2) | 0.6 | 6.0 | 1.5 | 224 | 202 | 90 | 1 |
| 4 | 15 | T/3528-12 | T494T156(1)004A(2) | 0.6 | 6.0 | 2.0 | 187 | 168 | 75 | 1 |
| 4 | 15 | S/3216-12 | T494S156(M)004A(2) | 0.6 | 10.0 | 9.0 | 82 | 74 | 33 | 1 |
| 4 | 22 | C/6032-28 | T494C226(1)004A(2) | 0.9 | 6.0 | 0.5 | 469 | 422 | 188 | 1 |
| 4 | 22 | B/3528-21 | T494B226(1)004A(2) | 0.9 | 6.0 | 0.6 | 376 | 338 | 150 | 1 |
| 4 | 22 | A/3216-18 | T494A226(1)004A(2) | 0.9 | 6.0 | 1.5 | 224 | 202 | 90 | 1 |
| 4 | 22 | S/3216-12 | T494S226(M)004A(2) | 0.9 | 10.0 | 8.0 | 87 | 78 | 35 | 1 |
| 4 | 22 | T/3528-12 | T494T226(1)004A(2) | 0.9 | 6.0 | 2.5 | 167 | 150 | 67 | 1 |
| 4 | 33 | C/6032-28 | T494C336(1)004A(2) | 1.3 | 6.0 | 0.5 | 469 | 422 | 188 | 1 |
| 4 | 33 | U/6032-15 | T494U336(1)004A(2) | 1.3 | 6.0 | 0.6 | 387 | 348 | 155 | 1 |
| 4 | 33 | B/3528-21 | T494B336(1)004A(2) | 1.3 | 6.0 | 0.5 | 412 | 371 | 165 | 1 |
| 4 | 33 | A/3216-18 | T494A336(1)004A(2) | 1.3 | 6.0 | 3.0 | 158 | 142 | 63 | 1 |
| 4 | 33 | T/3528-12 | T494T336(M)004A(2) | 1.3 | 8.0 | 3.5 | 141 | 127 | 56 | 1 |
| 4 | 47 | C/6032-28 | T494C476(1)004A(2) | 1.9 | 6.0 | 0.5 | 469 | 422 | 188 | 1 |
| 4 | 47 | U/6032-15 | T494U476(1)004A(2) | 1.9 | 6.0 | 0.6 | 387 | 348 | 155 | 1 |
| 4 | 47 | B/3528-21 | T494B476(1)004A(2) | 1.9 | 6.0 | 0.5 | 412 | 371 | 165 | 1 |
| 4 | 47 | A/3216-18 | T494A476(M)004A(2) | 1.9 | 12.0 | 2.0 | 194 | 175 | 78 | 1 |
| 4 | 47 | T/3528-12 | T494T476(M)004A(2) | 1.9 | 12.0 | 4.0 | 132 | 119 | 53 | 1 |
| 4 | 68 | D/7343-31 | T494D686(1)004A(2) | 2.7 | 6.0 | 0.20 | 866 | 779 | 346 | 1 |
| 4 | 68 | C/6032-28 | T494C686(1)004A(2) | 2.7 | 6.0 | 0.25 | 663 | 597 | 265 | 1 |
| 4 | 68 | U/6032-15 | T494U686(1)004A(2) | 2.7 | 6.0 | 0.60 | 387 | 348 | 155 | 1 |
| 4 | 68 | B/3528-21 | T494B686(1)004A(2) | 2.7 | 6.0 | 2.00 | 206 | 185 | 82 | 1 |
| 4 | 68 | A/3216-18 | T494A686(1)004A(2) | 2.7 | 30.0 | 3.00 | 158 | 142 | 63 | 1 |
| 4 | 100 | D/7343-31 | T494D107(1)004A(2) | 4.0 | 8.0 | 0.20 | 866 | 779 | 346 | 1 |
| 4 | 100 | C/6032-28 | T494C107(1)004A(2) | 4.0 | 8.0 | 0.20 | 742 | 668 | 297 | 1 |
| 4 | 100 | U/6032-15 | T494U107(1)004A(2) | 4.0 | 10.0 | 1.00 | 300 | 270 | 120 | 1 |
| 4 | 100 | B/3528-21 | T494B107(M)004A(2) | 4.0 | 8.0 | 0.65 | 362 | 326 | 145 | 1 |
| 4 | 100 | A/3216-18 | T494A107(M)004A(2) | 4.0 | 30.0 | 3.00 | 158 | 142 | 63 | 1 |
| 4 | 100 | T/3528-12 | T494T107(M)004A(2) | 4.0 | 30.0 | 4.50 | 125 | 113 | 50 | 1 |
| 4 | 150 | D/7343-31 | T494D157(1)004A(2) | 6.0 | 8.0 | 0.15 | 1000 | 900 | 400 | 1 |
| 4 | 150 | V/7343-20 | T494V157(1)004A(2) | 6.0 | 8.0 | 0.20 | 791 | 712 | 316 | 1 |
| 4 | 150 | C/6032-28 | T494C157(1)004A(2) | 6.0 | 8.0 | 0.30 | 606 | 545 | 242 | 1 |
| 4 | 150 | B/3528-21 | T494B157(M)004A(2) | 6.0 | 12.0 | 1.00 | 292 | 263 | 117 | 1 |
| 4 | 220 | V/7343-20 | T494V227(1)004A(2) | 8.8 | 8.0 | 0.30 | 645 | 581 | 258 | 1 |
| 4 | 220 | B/3528-21 | T494B227(M)004A(2) | 8.8 | 8.0 | 0.40 | 461 | 415 | 184 | 1 |
| 4 | 330 | D/7343-31 | T494D337(1)004A(2) | 13.2 | 8.0 | 0.15 | 1000 | 900 | 400 | 1 |
| 4 | 330 | C/6032-28 | T494C337(1)004A(2) | 13.2 | 10.0 | 0.09 | 1106 | 995 | 442 | 1 |
| VDC | µF | KEMET/EIA | (See below for part options) | µA @ 20°C Max/5 Min | % @ 20°C 120 Hz Max | Ω @ 20°C 100 kHz Max | (mA) 100 kHz 25°C | (mA) 100 kHz 85°C | (mA) 100 kHz 125°C | Reflow Temp ≤ 260°C |
| Rated Voltage | Rated Cap | Case Code/ Case Size | KEMET Part Number | DC Leakage | DF | ESR | Maximum Allowable Ripple Current | | | Moisture Sensitivity |

(1) To complete KEMET part number, insert M for ±20% or K for ±10%. Designates capacitance tolerance.

(2) To complete KEMET part number, insert T = 100% Matte Tin (Sn) Plated, G = Gold Plated, H = Standard Solder coated (SnPb 5% Pb minimum). Designates termination finish.

Refer to Ordering Information for additional detail.

Higher voltage ratings and tighter tolerance product including ESR may be substituted within the same size at KEMET's option. Voltage substitution will be marked with the higher voltage rating. Substitutions can include better than series.

Table 1 – Ratings & Part Number Reference cont'd

| Rated Voltage | Rated Cap | Case Code/ Case Size | KEMET Part Number | DC Leakage | DF | ESR | Maximum Allowable Ripple Current | | | Moisture Sensitivity |
|---------------|-----------|-------------------------|------------------------------|------------------------|------------------------|-------------------------|----------------------------------|----------------------|-----------------------|------------------------|
| VDC | μF | KEMET/EIA | (See below for part options) | μA @ 20°C Max/5 Min | % @ 20°C 120 Hz Max | Ω @ 20°C 100 kHz Max | (mA) 100 kHz 25°C | (mA) 100 kHz 85°C | (mA) 100 kHz 125°C | Reflow Temp ≤ 260°C |
| 4 | 330 | V/7343-20 | T494V337(1)004A(2) | 13.2 | 12.0 | 0.30 | 645 | 581 | 258 | 1 |
| 4 | 470 | X/7343-43 | T494X477(1)004A(2) | 18.8 | 8.0 | 0.15 | 1049 | 944 | 420 | 1 |
| 4 | 470 | D/7343-31 | T494D477(1)004A(2) | 18.8 | 8.0 | 0.15 | 1000 | 900 | 400 | 1 |
| 4 | 680 | X/7343-43 | T494X687(M)004A(2) | 27.2 | 12.0 | 0.10 | 1285 | 1157 | 514 | 1 |
| 4 | 680 | D/7343-31 | T494D687(M)004A(2) | 27.2 | 12.0 | 0.15 | 1000 | 900 | 400 | 1 |
| 4 | 1000 | X/7343-43 | T494X108(1)004A(2) | 40.0 | 12.0 | 0.10 | 1285 | 1157 | 514 | 1 |
| 4 | 1000 | E/7360-38 | T494E108(M)004A(2) | 40.0 | 15.0 | 0.08 | 1581 | 1423 | 632 | 1 |
| 6.3 | 2.2 | R/2012-12 | T494R225(1)006A(2) | 0.5 | 6.0 | 20.0 | 35 | 32 | 14 | 1 |
| 6.3 | 2.2 | A/3216-18 | T494A225(1)006A(2) | 0.5 | 6.0 | 6.0 | 112 | 101 | 45 | 1 |
| 6.3 | 3.3 | A/3216-18 | T494A335(1)006A(2) | 0.5 | 6.0 | 6.0 | 112 | 101 | 45 | 1 |
| 6.3 | 4.7 | A/3216-18 | T494A475(1)006A(2) | 0.5 | 6.0 | 3.5 | 146 | 131 | 58 | 1 |
| 6.3 | 4.7 | S/3216-12 | T494S475(1)006A(2) | 0.5 | 6.0 | 8.0 | 87 | 78 | 35 | 1 |
| 6.3 | 6.8 | B/3528-21 | T494B685(1)006A(2) | 0.5 | 6.0 | 1.2 | 266 | 239 | 106 | 1 |
| 6.3 | 6.8 | A/3216-18 | T494A685(1)006A(2) | 0.5 | 6.0 | 2.0 | 194 | 175 | 78 | 1 |
| 6.3 | 6.8 | S/3216-12 | T494S685(1)006A(2) | 0.5 | 6.0 | 9.0 | 82 | 74 | 33 | 1 |
| 6.3 | 6.8 | R/2012-12 | T494R685(1)006A(2) | 0.5 | 8.0 | 10.0 | 50 | 45 | 20 | 1 |
| 6.3 | 10 | B/3528-21 | T494B106(1)006A(2) | 0.6 | 6.0 | 1.0 | 292 | 263 | 117 | 1 |
| 6.3 | 10 | A/3216-18 | T494A106(1)006A(2) | 0.6 | 6.0 | 2.0 | 194 | 175 | 78 | 1 |
| 6.3 | 10 | T/3528-12 | T494T106(1)006A(2) | 0.6 | 6.0 | 1.2 | 242 | 218 | 97 | 1 |
| 6.3 | 10 | S/3216-12 | T494S106(M)006A(2) | 0.6 | 10.0 | 9.0 | 82 | 74 | 33 | 1 |
| 6.3 | 10 | R/2012-12 | T494R106(M)006A(2) | 0.6 | 8.0 | 6.0 | 65 | 59 | 26 | 1 |
| 6.3 | 15 | C/6032-28 | T494C156(1)006A(2) | 0.9 | 6.0 | 0.6 | 428 | 385 | 171 | 1 |
| 6.3 | 15 | B/3528-21 | T494B156(1)006A(2) | 0.9 | 6.0 | 0.7 | 348 | 313 | 139 | 1 |
| 6.3 | 15 | A/3216-18 | T494A156(1)006A(2) | 0.9 | 6.0 | 2.0 | 194 | 175 | 78 | 1 |
| 6.3 | 15 | T/3528-12 | T494T156(1)006A(2) | 0.9 | 6.0 | 2.5 | 167 | 150 | 67 | 1 |
| 6.3 | 15 | S/3216-12 | T494S156(M)006A(2) | 0.9 | 10.0 | 10.0 | 77 | 69 | 31 | 1 |
| 6.3 | 22 | C/6032-28 | T494C226(1)006A(2) | 1.4 | 6.0 | 0.5 | 469 | 422 | 188 | 1 |
| 6.3 | 22 | U/6032-15 | T494U226(1)006A(2) | 1.4 | 6.0 | 0.8 | 335 | 302 | 134 | 1 |
| 6.3 | 22 | B/3528-21 | T494B226(1)006A(2) | 1.4 | 6.0 | 0.6 | 376 | 338 | 150 | 1 |
| 6.3 | 22 | A/3216-18 | T494A226(1)006A(2) | 1.4 | 6.0 | 3.0 | 158 | 142 | 63 | 1 |
| 6.3 | 22 | T/3528-12 | T494T226(M)006A(2) | 1.4 | 8.0 | 3.5 | 141 | 127 | 56 | 1 |
| 6.3 | 33 | C/6032-28 | T494C336(1)006A(2) | 2.1 | 6.0 | 0.3 | 606 | 545 | 242 | 1 |
| 6.3 | 33 | U/6032-15 | T494U336(1)006A(2) | 2.1 | 6.0 | 0.6 | 387 | 348 | 155 | 1 |
| 6.3 | 33 | B/3528-21 | T494B336(1)006A(2) | 2.1 | 6.0 | 0.6 | 376 | 338 | 150 | 1 |
| 6.3 | 33 | A/3216-18 | T494A336(1)006A(2) | 2.1 | 12.0 | 2.0 | 194 | 175 | 78 | 1 |
| 6.3 | 33 | T/3528-12 | T494T336(M)006A(2) | 2.1 | 12.0 | 4.0 | 132 | 119 | 53 | 1 |
| 6.3 | 47 | D/7343-31 | T494D476(1)006A(2) | 3.0 | 6.0 | 0.22 | 826 | 743 | 330 | 1 |
| 6.3 | 47 | C/6032-28 | T494C476(1)006A(2) | 3.0 | 6.0 | 0.25 | 663 | 597 | 265 | 1 |
| 6.3 | 47 | U/6032-15 | T494U476(1)006A(2) | 3.0 | 6.0 | 0.60 | 387 | 348 | 155 | 1 |
| 6.3 | 47 | B/3528-21 | T494B476(1)006A(2) | 3.0 | 6.0 | 0.50 | 412 | 371 | 165 | 1 |
| 6.3 | 47 | A/3216-18 | T494A476(M)006A(2) | 3.0 | 12.0 | 2.50 | 173 | 156 | 69 | 1 |
| 6.3 | 47 | T/3528-12 | T494T476(1)006A(2) | 3.0 | 24.0 | 4.00 | 132 | 119 | 53 | 1 |
| 6.3 | 68 | D/7343-31 | T494D686(1)006A(2) | 4.3 | 6.0 | 0.20 | 866 | 779 | 346 | 1 |
| 6.3 | 68 | C/6032-28 | T494C686(1)006A(2) | 4.3 | 6.0 | 0.20 | 742 | 668 | 297 | 1 |
| 6.3 | 68 | U/6032-15 | T494U686(1)006A(2) | 4.3 | 10.0 | 1.00 | 300 | 270 | 120 | 1 |
| 6.3 | 68 | B/3528-21 | T494B686(M)006A(2) | 4.3 | 8.0 | 0.65 | 362 | 326 | 145 | 1 |
| 6.3 | 68 | A/3216-18 | T494A686(1)006A(2) | 4.3 | 30.0 | 3.00 | 158 | 142 | 63 | 1 |
| 6.3 | 100 | D/7343-31 | T494D107(1)006A(2) | 6.3 | 8.0 | 0.15 | 1000 | 900 | 400 | 1 |
| 6.3 | 100 | V/7343-20 | T494V107(1)006A(2) | 6.3 | 8.0 | 0.20 | 791 | 712 | 316 | 1 |
| 6.3 | 100 | C/6032-28 | T494C107(1)006A(2) | 6.3 | 8.0 | 0.30 | 606 | 545 | 242 | 1 |
| VDC | μF | KEMET/EIA | (See below for part options) | μA @ 20°C Max/5 Min | % @ 20°C 120 Hz Max | Ω @ 20°C 100 kHz Max | (mA) 100 kHz 25°C | (mA) 100 kHz 85°C | (mA) 100 kHz 125°C | Reflow Temp ≤ 260°C |
| Rated Voltage | Rated Cap | Case Code/ Case Size | KEMET Part Number | DC Leakage | DF | ESR | Maximum Allowable Ripple Current | | | Moisture Sensitivity |

(1) To complete KEMET part number, insert M for ±20% or K for ±10%. Designates capacitance tolerance.

(2) To complete KEMET part number, insert T = 100% Matte Tin (Sn) Plated, G = Gold Plated, H = Standard Solder coated (SnPb 5% Pb minimum). Designates termination finish.

Refer to Ordering Information for additional detail.

Higher voltage ratings and tighter tolerance product including ESR may be substituted within the same size at KEMET's option. Voltage substitution will be marked with the higher voltage rating. Substitutions can include better than series.

Table 1 – Ratings & Part Number Reference cont'd

| Rated Voltage | Rated Cap | Case Code/ Case Size | KEMET Part Number | DC Leakage | DF | ESR | Maximum Allowable Ripple Current | | | Moisture Sensitivity |
|---------------|-----------|-------------------------|------------------------------|------------------------|------------------------|-------------------------|----------------------------------|----------------------|-----------------------|------------------------|
| VDC | µF | KEMET/EIA | (See below for part options) | µA @ 20°C Max/5 Min | % @ 20°C 120 Hz Max | Ω @ 20°C 100 kHz Max | (mA) 100 kHz 25°C | (mA) 100 kHz 85°C | (mA) 100 kHz 125°C | Reflow Temp ≤ 260°C |
| 6.3 | 100 | U/6032-15 | T494U107(M)006A(2) | 6.3 | 10.0 | 1.20 | 274 | 247 | 110 | 1 |
| 6.3 | 100 | B/3528-21 | T494B107(1)006A(2) | 6.3 | 15.0 | 1.50 | 238 | 214 | 95 | 1 |
| 6.3 | 150 | B/3528-21 | T494B157M006A(2) | 9.5 | 15.0 | 2.25 | 194 | 175 | 78 | 1 |
| 6.3 | 150 | D/7343-31 | T494D157(1)006A(2) | 9.5 | 8.0 | 0.15 | 1000 | 900 | 400 | 1 |
| 6.3 | 150 | C/6032-28 | T494C157(M)006A(2) | 9.5 | 8.0 | 0.30 | 606 | 545 | 242 | 1 |
| 6.3 | 150 | V/7343-20 | T494V157(1)006A(2) | 9.5 | 8.0 | 0.30 | 645 | 581 | 258 | 1 |
| 6.3 | 220 | X/7343-43 | T494X227(1)006A(2) | 13.9 | 8.0 | 0.15 | 1049 | 944 | 420 | 1 |
| 6.3 | 220 | D/7343-31 | T494D227(1)006A(2) | 13.9 | 8.0 | 0.15 | 1000 | 900 | 400 | 1 |
| 6.3 | 220 | C/6032-28 | T494C227(M)006A(2) | 13.9 | 10.0 | 0.30 | 606 | 545 | 242 | 1 |
| 6.3 | 220 | V/7343-20 | T494V227(M)006A(2) | 13.9 | 12.0 | 0.30 | 645 | 581 | 258 | 1 |
| 6.3 | 330 | X/7343-43 | T494X337(1)006A(2) | 20.8 | 8.0 | 0.15 | 1049 | 944 | 420 | 1 |
| 6.3 | 330 | D/7343-31 | T494D337(1)006A(2) | 20.8 | 8.0 | 0.15 | 1000 | 900 | 400 | 1 |
| 6.3 | 330 | E/7360-38 | T494E337(1)006A(2) | 20.8 | 8.0 | 0.25 | 894 | 805 | 358 | 1 |
| 6.3 | 470 | X/7343-43 | T494X477(1)006A(2) | 29.6 | 10.0 | 0.10 | 1285 | 1157 | 514 | 1 |
| 6.3 | 470 | D/7343-31 | T494D477(M)006A(2) | 29.6 | 12.0 | 0.15 | 1000 | 900 | 400 | 1 |
| 6.3 | 470 | E/7360-38 | T494E477(1)006A(2) | 29.6 | 10.0 | 0.20 | 1000 | 900 | 400 | 1 |
| 6.3 | 680 | E/7360-38 | T494E687(M)006A(2) | 42.8 | 12.0 | 0.10 | 1414 | 1273 | 566 | 1 |
| 6.3 | 680 | X/7343-43 | T494X687(1)006A(2) | 42.8 | 12.0 | 0.10 | 1285 | 1157 | 514 | 1 |
| 10 | 1.5 | A/3216-18 | T494A155(1)010A(2) | 0.5 | 6.0 | 6.0 | 112 | 101 | 45 | 1 |
| 10 | 2.2 | B/3528-21 | T494B225(1)010A(2) | 0.5 | 6.0 | 1.5 | 238 | 214 | 95 | 1 |
| 10 | 2.2 | A/3216-18 | T494A225(1)010A(2) | 0.5 | 6.0 | 6.0 | 112 | 101 | 45 | 1 |
| 10 | 3.3 | A/3216-18 | T494A335(1)010A(2) | 0.5 | 6.0 | 4.0 | 137 | 123 | 55 | 1 |
| 10 | 3.3 | S/3216-12 | T494S335(1)010A(2) | 0.5 | 6.0 | 9.0 | 82 | 74 | 33 | 1 |
| 10 | 3.3 | R/2012-12 | T494R335(1)010A(2) | 0.5 | 8.0 | 10.0 | 50 | 45 | 20 | 1 |
| 10 | 4.7 | B/3528-21 | T494B475(1)010A(2) | 0.5 | 6.0 | 1.5 | 238 | 214 | 95 | 1 |
| 10 | 4.7 | A/3216-18 | T494A475(1)010A(2) | 0.5 | 6.0 | 3.0 | 158 | 142 | 63 | 1 |
| 10 | 4.7 | S/3216-12 | T494S475(1)010A(2) | 0.5 | 6.0 | 9.0 | 82 | 74 | 33 | 1 |
| 10 | 4.7 | R/2012-12 | T494R475(M)010A(2) | 0.5 | 8.0 | 8.0 | 56 | 50 | 22 | 1 |
| 10 | 6.8 | B/3528-21 | T494B685(1)010A(2) | 0.7 | 6.0 | 1.2 | 266 | 239 | 106 | 1 |
| 10 | 6.8 | A/3216-18 | T494A685(1)010A(2) | 0.7 | 6.0 | 3.0 | 158 | 142 | 63 | 1 |
| 10 | 6.8 | T/3528-12 | T494T685(1)010A(2) | 0.7 | 6.0 | 2.0 | 187 | 168 | 75 | 1 |
| 10 | 6.8 | S/3216-12 | T494S685(M)010A(2) | 0.7 | 10.0 | 9.0 | 82 | 74 | 33 | 1 |
| 10 | 10 | C/6032-28 | T494C106(1)010A(2) | 1.0 | 6.0 | 0.6 | 428 | 385 | 171 | 1 |
| 10 | 10 | B/3528-21 | T494B106(1)010A(2) | 1.0 | 6.0 | 0.8 | 326 | 293 | 130 | 1 |
| 10 | 10 | A/3216-18 | T494A106(1)010A(2) | 1.0 | 6.0 | 1.8 | 204 | 184 | 82 | 1 |
| 10 | 10 | T/3528-12 | T494T106(1)010A(2) | 1.0 | 6.0 | 3.5 | 141 | 127 | 56 | 1 |
| 10 | 10 | S/3216-12 | T494S106(M)010A(2) | 1.0 | 10.0 | 12.0 | 71 | 64 | 28 | 1 |
| 10 | 10 | R/2012-12 | T494R106(M)010A(2) | 1.0 | 24.0 | 25.0 | 32 | 29 | 13 | 1 |
| 10 | 15 | C/6032-28 | T494C156(1)010A(2) | 1.5 | 6.0 | 0.5 | 469 | 422 | 188 | 1 |
| 10 | 15 | U/6032-15 | T494U156(1)010A(2) | 1.5 | 6.0 | 0.8 | 335 | 302 | 134 | 1 |
| 10 | 15 | B/3528-21 | T494B156(1)010A(2) | 1.5 | 6.0 | 0.7 | 348 | 313 | 139 | 1 |
| 10 | 15 | A/3216-18 | T494A156(1)010A(2) | 1.5 | 8.0 | 4.0 | 137 | 123 | 55 | 1 |
| 10 | 15 | T/3528-12 | T494T156(M)010A(2) | 1.5 | 8.0 | 3.5 | 141 | 127 | 56 | 1 |
| 10 | 22 | C/6032-28 | T494C226(1)010A(2) | 2.2 | 6.0 | 0.4 | 524 | 472 | 210 | 1 |
| 10 | 22 | U/6032-15 | T494U226(1)010A(2) | 2.2 | 6.0 | 0.8 | 335 | 302 | 134 | 1 |
| 10 | 22 | B/3528-21 | T494B226(1)010A(2) | 2.2 | 6.0 | 0.7 | 348 | 313 | 139 | 1 |
| 10 | 22 | A/3216-18 | T494A226(M)010A(2) | 2.2 | 10.0 | 4.5 | 129 | 116 | 52 | 1 |
| 10 | 22 | T/3528-12 | T494T226(M)010A(2) | 2.2 | 12.0 | 6.0 | 108 | 97 | 43 | 1 |
| 10 | 33 | D/7343-31 | T494D336(1)010A(2) | 3.3 | 6.0 | 0.25 | 775 | 698 | 310 | 1 |
| 10 | 33 | V/7343-20 | T494V336(1)010A(2) | 3.3 | 6.0 | 0.30 | 645 | 581 | 258 | 1 |
| VDC | µF | KEMET/EIA | (See below for part options) | µA @ 20°C Max/5 Min | % @ 20°C 120 Hz Max | Ω @ 20°C 100 kHz Max | (mA) 100 kHz 25°C | (mA) 100 kHz 85°C | (mA) 100 kHz 125°C | Reflow Temp ≤ 260°C |
| Rated Voltage | Rated Cap | Case Code/ Case Size | KEMET Part Number | DC Leakage | DF | ESR | Maximum Allowable Ripple Current | | | Moisture Sensitivity |

(1) To complete KEMET part number, insert M for ±20% or K for ±10%. Designates capacitance tolerance.

(2) To complete KEMET part number, insert T = 100% Matte Tin (Sn) Plated, G = Gold Plated, H = Standard Solder coated (SnPb 5% Pb minimum). Designates termination finish.

Refer to Ordering Information for additional detail.

Higher voltage ratings and tighter tolerance product including ESR may be substituted within the same size at KEMET's option. Voltage substitution will be marked with the higher voltage rating. Substitutions can include better than series.

Table 1 – Ratings & Part Number Reference cont'd

| Rated Voltage | Rated Cap | Case Code/ Case Size | KEMET Part Number | DC Leakage | DF | ESR | Maximum Allowable Ripple Current | | | Moisture Sensitivity |
|---------------|-----------|-------------------------|------------------------------|------------------------|------------------------|-------------------------|----------------------------------|----------------------|-----------------------|------------------------|
| VDC | µF | KEMET/EIA | (See below for part options) | µA @ 20°C Max/5 Min | % @ 20°C 120 Hz Max | Ω @ 20°C 100 kHz Max | (mA) 100 kHz 25°C | (mA) 100 kHz 85°C | (mA) 100 kHz 125°C | Reflow Temp ≤ 260°C |
| 10 | 33 | C/6032-28 | T494C336(1)010A(2) | 3.3 | 6.0 | 0.30 | 606 | 545 | 242 | 1 |
| 10 | 33 | U/6032-15 | T494U336(1)010A(2) | 3.3 | 6.0 | 0.60 | 387 | 348 | 155 | 1 |
| 10 | 33 | T/3528-12 | T494T336(1)010A(2) | 3.3 | 24.0 | 3.75 | 137 | 123 | 55 | 1 |
| 10 | 33 | B/3528-21 | T494B336(1)010A(2) | 3.3 | 6.0 | 1.40 | 246 | 221 | 98 | 1 |
| 10 | 33 | A/3216-18 | T494A336(1)010A(2) | 3.3 | 15.0 | 4.00 | 137 | 123 | 55 | 1 |
| 10 | 47 | D/7343-31 | T494D476(1)010A(2) | 4.7 | 6.0 | 0.22 | 826 | 743 | 330 | 1 |
| 10 | 47 | V/7343-20 | T494V476(1)010A(2) | 4.7 | 6.0 | 0.30 | 645 | 581 | 258 | 1 |
| 10 | 47 | C/6032-28 | T494C476(1)010A(2) | 4.7 | 6.0 | 0.30 | 606 | 545 | 242 | 1 |
| 10 | 47 | U/6032-15 | T494U476(1)010A(2) | 4.7 | 10.0 | 1.20 | 274 | 247 | 110 | 1 |
| 10 | 47 | B/3528-21 | T494B476(M)010A(2) | 4.7 | 8.0 | 0.65 | 362 | 326 | 145 | 1 |
| 10 | 68 | D/7343-31 | T494D686(1)010A(2) | 6.8 | 6.0 | 0.20 | 866 | 779 | 346 | 1 |
| 10 | 68 | C/6032-28 | T494C686(1)010A(2) | 6.8 | 6.0 | 0.30 | 606 | 545 | 242 | 1 |
| 10 | 68 | V/7343-20 | T494V686(1)010A(2) | 6.8 | 6.0 | 0.30 | 645 | 581 | 258 | 1 |
| 10 | 68 | U/6032-15 | T494U686(M)010A(2) | 6.8 | 10.0 | 1.20 | 274 | 247 | 110 | 1 |
| 10 | 68 | B/3528-21 | T494B686(M)010A(2) | 6.8 | 10.0 | 1.50 | 238 | 214 | 95 | 1 |
| 10 | 100 | D/7343-31 | T494D107(1)010A(2) | 10.0 | 8.0 | 0.15 | 1000 | 900 | 400 | 1 |
| 10 | 100 | C/6032-28 | T494C107(1)010A(2) | 10.0 | 8.0 | 0.20 | 742 | 668 | 297 | 1 |
| 10 | 100 | V/7343-20 | T494V107(1)010A(2) | 10.0 | 8.0 | 0.40 | 559 | 503 | 224 | 1 |
| 10 | 150 | X/7343-43 | T494X157(1)010A(2) | 15.0 | 8.0 | 0.15 | 1049 | 944 | 420 | 1 |
| 10 | 150 | D/7343-31 | T494D157(1)010A(2) | 15.0 | 8.0 | 0.15 | 1000 | 900 | 400 | 1 |
| 10 | 150 | C/6032-28 | T494C157(1)010A(2) | 15.0 | 10.0 | 0.70 | 396 | 356 | 158 | 1 |
| 10 | 150 | V/7343-20 | T494V157(M)010A(2) | 15.0 | 8.0 | 0.30 | 645 | 581 | 258 | 1 |
| 10 | 220 | X/7343-43 | T494X227(1)010A(2) | 22.0 | 8.0 | 0.15 | 1049 | 944 | 420 | 1 |
| 10 | 220 | D/7343-31 | T494D227(1)010A(2) | 22.0 | 8.0 | 0.15 | 1000 | 900 | 400 | 1 |
| 10 | 330 | X/7343-43 | T494X337(1)010A(2) | 33.0 | 10.0 | 0.10 | 1285 | 1157 | 514 | 1 |
| 10 | 330 | D/7343-31 | T494D337(M)010A(2) | 33.0 | 10.0 | 0.15 | 1000 | 900 | 400 | 1 |
| 10 | 330 | E/7360-38 | T494E337(1)010A(2) | 33.0 | 10.0 | 0.25 | 894 | 805 | 358 | 1 |
| 10 | 470 | X/7343-43 | T494X477(1)010A(2) | 47.0 | 10.0 | 0.10 | 1285 | 1157 | 514 | 1 |
| 10 | 470 | E/7360-38 | T494E477(M)010A(2) | 47.0 | 12.0 | 0.10 | 1414 | 1273 | 566 | 1 |
| 16 | 1 | A/3216-18 | T494A105(1)016A(2) | 0.5 | 4.0 | 6.0 | 112 | 101 | 45 | 1 |
| 16 | 1.5 | A/3216-18 | T494A155(1)016A(2) | 0.5 | 6.0 | 6.0 | 112 | 101 | 45 | 1 |
| 16 | 2.2 | A/3216-18 | T494A225(1)016A(2) | 0.5 | 6.0 | 4.0 | 137 | 123 | 55 | 1 |
| 16 | 2.2 | S/3216-12 | T494S225(1)016A(2) | 0.5 | 6.0 | 10.0 | 77 | 69 | 31 | 1 |
| 16 | 2.2 | R/2012-12 | T494R225(1)016A(2) | 0.5 | 8.0 | 20.0 | 35 | 32 | 14 | 1 |
| 16 | 3.3 | B/3528-21 | T494B335(1)016A(2) | 0.5 | 6.0 | 2.0 | 206 | 185 | 82 | 1 |
| 16 | 3.3 | A/3216-18 | T494A335(1)016A(2) | 0.5 | 6.0 | 4.0 | 137 | 123 | 55 | 1 |
| 16 | 4.7 | B/3528-21 | T494B475(1)016A(2) | 0.8 | 6.0 | 1.5 | 238 | 214 | 95 | 1 |
| 16 | 4.7 | A/3216-18 | T494A475(1)016A(2) | 0.8 | 6.0 | 3.0 | 158 | 142 | 63 | 1 |
| 16 | 4.7 | T/3528-12 | T494T475(1)016A(2) | 0.8 | 6.0 | 3.0 | 153 | 138 | 61 | 1 |
| 16 | 6.8 | C/6032-28 | T494C685(1)016A(2) | 1.1 | 6.0 | 0.8 | 371 | 334 | 148 | 1 |
| 16 | 6.8 | B/3528-21 | T494B685(1)016A(2) | 1.1 | 6.0 | 1.2 | 266 | 239 | 106 | 1 |
| 16 | 6.8 | A/3216-18 | T494A685(1)016A(2) | 1.1 | 6.0 | 3.0 | 158 | 142 | 63 | 1 |
| 16 | 10 | C/6032-28 | T494C106(1)016A(2) | 1.6 | 6.0 | 0.6 | 428 | 385 | 171 | 1 |
| 16 | 10 | U/6032-15 | T494U106(1)016A(2) | 1.6 | 6.0 | 1.0 | 300 | 270 | 120 | 1 |
| 16 | 10 | B/3528-21 | T494B106(1)016A(2) | 1.6 | 6.0 | 0.8 | 326 | 293 | 130 | 1 |
| 16 | 10 | A/3216-18 | T494A106(1)016A(2) | 1.6 | 8.0 | 3.0 | 158 | 142 | 63 | 1 |
| 16 | 10 | T/3528-12 | T494T106(1)016A(2) | 1.6 | 8.0 | 6.0 | 108 | 97 | 43 | 1 |
| 16 | 15 | C/6032-28 | T494C156(1)016A(2) | 2.4 | 6.0 | 0.4 | 524 | 472 | 210 | 1 |
| 16 | 15 | U/6032-15 | T494U156(1)016A(2) | 2.4 | 6.0 | 0.8 | 335 | 302 | 134 | 1 |
| 16 | 15 | B/3528-21 | T494B156(1)016A(2) | 2.4 | 6.0 | 0.8 | 326 | 293 | 130 | 1 |
| VDC | µF | KEMET/EIA | (See below for part options) | µA @ 20°C Max/5 Min | % @ 20°C 120 Hz Max | Ω @ 20°C 100 kHz Max | (mA) 100 kHz 25°C | (mA) 100 kHz 85°C | (mA) 100 kHz 125°C | Reflow Temp ≤ 260°C |
| Rated Voltage | Rated Cap | Case Code/ Case Size | KEMET Part Number | DC Leakage | DF | ESR | Maximum Allowable Ripple Current | | | Moisture Sensitivity |

(1) To complete KEMET part number, insert M for ±20% or K for ±10%. Designates capacitance tolerance.

(2) To complete KEMET part number, insert T = 100% Matte Tin (Sn) Plated, G = Gold Plated, H = Standard Solder coated (SnPb 5% Pb minimum). Designates termination finish.

Refer to Ordering Information for additional detail.

Higher voltage ratings and tighter tolerance product including ESR may be substituted within the same size at KEMET's option. Voltage substitution will be marked with the higher voltage rating. Substitutions can include better than series.

Table 1 – Ratings & Part Number Reference cont'd

| Rated Voltage | Rated Cap | Case Code/ Case Size | KEMET Part Number | DC Leakage | DF | ESR | Maximum Allowable Ripple Current | | | Moisture Sensitivity |
|---------------|-----------|-------------------------|------------------------------|------------------------|------------------------|-------------------------|----------------------------------|----------------------|-----------------------|------------------------|
| VDC | μF | KEMET/EIA | (See below for part options) | μA @ 20°C Max/5 Min | % @ 20°C 120 Hz Max | Ω @ 20°C 100 kHz Max | (mA) 100 kHz 25°C | (mA) 100 kHz 85°C | (mA) 100 kHz 125°C | Reflow Temp ≤ 260°C |
| 16 | 22 | D/7343-31 | T494D226(1)016A(2) | 3.5 | 6.0 | 0.25 | 775 | 698 | 310 | 1 |
| 16 | 22 | C/6032-28 | T494C226(1)016A(2) | 3.5 | 6.0 | 0.35 | 561 | 505 | 224 | 1 |
| 16 | 22 | U/6032-15 | T494U226(1)016A(2) | 3.5 | 10.0 | 1.80 | 224 | 202 | 90 | 1 |
| 16 | 22 | B/3528-21 | T494B226(1)016A(2) | 3.5 | 6.0 | 1.00 | 292 | 263 | 117 | 1 |
| 16 | 33 | D/7343-31 | T494D336(1)016A(2) | 5.3 | 6.0 | 0.25 | 775 | 698 | 310 | 1 |
| 16 | 33 | C/6032-28 | T494C336(1)016A(2) | 5.3 | 6.0 | 0.30 | 606 | 545 | 242 | 1 |
| 16 | 33 | U/6032-15 | T494U336(1)016A(2) | 5.3 | 12.0 | 2.20 | 202 | 182 | 81 | 1 |
| 16 | 33 | B/3528-21 | T494B336(1)016A(2) | 5.3 | 8.0 | 1.20 | 266 | 239 | 106 | 1 |
| 16 | 47 | D/7343-31 | T494D476(1)016A(2) | 7.5 | 6.0 | 0.2 | 866 | 779 | 346 | 1 |
| 16 | 47 | V/7343-20 | T494V476(1)016A(2) | 7.5 | 6.0 | 0.3 | 645 | 581 | 258 | 1 |
| 16 | 47 | C/6032-28 | T494C476(1)016A(2) | 7.5 | 6.0 | 0.5 | 469 | 422 | 188 | 1 |
| 16 | 68 | D/7343-31 | T494D686(1)016A(2) | 10.9 | 6.0 | 0.15 | 1000 | 900 | 400 | 1 |
| 16 | 68 | V/7343-20 | T494V686(1)016A(2) | 10.9 | 6.0 | 0.5 | 500 | 450 | 200 | 1 |
| 16 | 68 | C/6032-28 | T494C686(1)016A(2) | 10.9 | 12.0 | 1.0 | 332 | 299 | 133 | 1 |
| 16 | 100 | X/7343-43 | T494X107(1)016A(2) | 16.0 | 8.0 | 0.15 | 1049 | 944 | 420 | 1 |
| 16 | 100 | D/7343-31 | T494D107(1)016A(2) | 16.0 | 8.0 | 0.15 | 1000 | 900 | 400 | 1 |
| 16 | 100 | V/7343-20 | T494V107(1)016A(2) | 16.0 | 12.0 | 0.5 | 500 | 450 | 200 | 1 |
| 16 | 150 | X/7343-43 | T494X157(1)016A(2) | 24.0 | 8.0 | 0.15 | 1049 | 944 | 420 | 1 |
| 16 | 150 | D/7343-31 | T494D157(1)016A(2) | 24.0 | 12.0 | 0.4 | 612 | 551 | 245 | 1 |
| 16 | 220 | X/7343-43 | T494X227(1)016A(2) | 35.2 | 10.0 | 0.4 | 642 | 578 | 257 | 1 |
| 16 | 220 | E/7360-38 | T494E227(1)016A(2) | 35.2 | 7.2 | 0.5 | 632 | 569 | 253 | 1 |
| 20 | 0.68 | A/3216-18 | T494A684(1)020A(2) | 0.5 | 4.0 | 8.0 | 97 | 87 | 39 | 1 |
| 20 | 1 | A/3216-18 | T494A105(1)020A(2) | 0.5 | 4.0 | 5.5 | 117 | 105 | 47 | 1 |
| 20 | 1 | S/3216-12 | T494S105(1)020A(2) | 0.5 | 6.0 | 10.0 | 77 | 69 | 31 | 1 |
| 20 | 1 | R/2012-12 | T494R105(1)020A(2) | 0.5 | 6.0 | 15.0 | 41 | 37 | 16 | 1 |
| 20 | 1.5 | A/3216-18 | T494A155(1)020AS(2) | 0.5 | 6.0 | 4.5 | 129 | 116 | 52 | 1 |
| 20 | 1.5 | S/3216-12 | T494S155(1)020A(2) | 0.5 | 6.0 | 9.0 | 82 | 74 | 33 | 1 |
| 20 | 2.2 | B/3528-21 | T494B225(1)020A(2) | 0.5 | 6.0 | 1.5 | 238 | 214 | 95 | 1 |
| 20 | 2.2 | A/3216-18 | T494A225(1)020A(2) | 0.5 | 6.0 | 4.0 | 137 | 123 | 55 | 1 |
| 20 | 2.2 | R/2012-12 | T494R225(1)020A(2) | 0.5 | 8.0 | 6.0 | 65 | 59 | 26 | 1 |
| 20 | 3.3 | B/3528-21 | T494B335(1)020A(2) | 0.7 | 6.0 | 1.3 | 256 | 230 | 102 | 1 |
| 20 | 3.3 | A/3216-18 | T494A335(1)020A(2) | 0.7 | 6.0 | 4.0 | 137 | 123 | 55 | 1 |
| 20 | 3.3 | T/3528-12 | T494T335(1)020A(2) | 0.7 | 6.0 | 4.0 | 132 | 119 | 53 | 1 |
| 20 | 4.7 | C/6032-28 | T494C475(1)020A(2) | 0.9 | 6.0 | 0.6 | 428 | 385 | 171 | 1 |
| 20 | 4.7 | B/3528-21 | T494B475(1)020A(2) | 0.9 | 6.0 | 1.0 | 292 | 263 | 117 | 1 |
| 20 | 4.7 | A/3216-18 | T494A475(1)020A(2) | 0.9 | 6.0 | 3.0 | 158 | 142 | 63 | 1 |
| 20 | 6.8 | C/6032-28 | T494C685(1)020A(2) | 1.4 | 6.0 | 0.6 | 428 | 385 | 171 | 1 |
| 20 | 6.8 | U/6032-15 | T494U685(1)020A(2) | 1.4 | 6.0 | 1.4 | 254 | 229 | 102 | 1 |
| 20 | 6.8 | B/3528-21 | T494B685(1)020A(2) | 1.4 | 6.0 | 1.0 | 292 | 263 | 117 | 1 |
| 20 | 6.8 | A/3216-18 | T494A685(M)020A(2) | 1.4 | 8.0 | 3.0 | 158 | 142 | 63 | 1 |
| 20 | 10 | C/6032-28 | T494C106(1)020A(2) | 2.0 | 6.0 | 0.5 | 469 | 422 | 188 | 1 |
| 20 | 10 | U/6032-15 | T494U106(1)020A(2) | 2.0 | 6.0 | 0.8 | 335 | 302 | 134 | 1 |
| 20 | 10 | B/3528-21 | T494B106(1)020A(2) | 2.0 | 6.0 | 1.0 | 292 | 263 | 117 | 1 |
| 20 | 10 | A/3216-18 | T494A106(M)020A(2) | 2.0 | 10.0 | 3.0 | 158 | 142 | 63 | 1 |
| 20 | 15 | D/7343-31 | T494D156(1)020A(2) | 3.0 | 6.0 | 0.35 | 655 | 590 | 262 | 1 |
| 20 | 15 | C/6032-28 | T494C156(1)020A(2) | 3.0 | 6.0 | 0.40 | 524 | 472 | 210 | 1 |
| 20 | 22 | D/7343-31 | T494D226(1)020A(2) | 4.4 | 6.0 | 0.3 | 707 | 636 | 283 | 1 |
| 20 | 22 | V/7343-20 | T494V226(1)020A(2) | 4.4 | 6.0 | 0.4 | 559 | 503 | 224 | 1 |
| 20 | 22 | C/6032-28 | T494C226(1)020A(2) | 4.4 | 6.0 | 0.4 | 524 | 472 | 210 | 1 |
| 20 | 22 | B/3528-21 | T494B226(1)020A(2) | 4.4 | 8.0 | 3.0 | 168 | 151 | 67 | 1 |
| VDC | μF | KEMET/EIA | (See below for part options) | μA @ 20°C Max/5 Min | % @ 20°C 120 Hz Max | Ω @ 20°C 100 kHz Max | (mA) 100 kHz 25°C | (mA) 100 kHz 85°C | (mA) 100 kHz 125°C | Reflow Temp ≤ 260°C |
| Rated Voltage | Rated Cap | Case Code/ Case Size | KEMET Part Number | DC Leakage | DF | ESR | Maximum Allowable Ripple Current | | | Moisture Sensitivity |

(1) To complete KEMET part number, insert M for ±20% or K for ±10%. Designates capacitance tolerance.

(2) To complete KEMET part number, insert T = 100% Matte Tin (Sn) Plated, G = Gold Plated, H = Standard Solder coated (SnPb 5% Pb minimum). Designates termination finish.

Refer to Ordering Information for additional detail.

Higher voltage ratings and tighter tolerance product including ESR may be substituted within the same size at KEMET's option. Voltage substitution will be marked with the higher voltage rating. Substitutions can include better than series.

Table 1 – Ratings & Part Number Reference cont'd

| Rated Voltage | Rated Cap | Case Code/ Case Size | KEMET Part Number | DC Leakage | DF | ESR | Maximum Allowable Ripple Current | | | Moisture Sensitivity |
|---------------|-----------|-------------------------|------------------------------|------------------------|------------------------|-------------------------|----------------------------------|----------------------|-----------------------|------------------------|
| VDC | µF | KEMET/EIA | (See below for part options) | µA @ 20°C Max/5 Min | % @ 20°C 120 Hz Max | Ω @ 20°C 100 kHz Max | (mA) 100 kHz 25°C | (mA) 100 kHz 85°C | (mA) 100 kHz 125°C | Reflow Temp ≤ 260°C |
| 20 | 33 | D/7343-31 | T494D336(1)020A(2) | 6.6 | 6.0 | 0.25 | 775 | 698 | 310 | 1 |
| 20 | 33 | C/6032-28 | T494C336(M)020A(2) | 6.6 | 6.0 | 0.40 | 524 | 472 | 210 | 1 |
| 20 | 33 | V/7343-20 | T494V336(1)020A(2) | 6.6 | 8.0 | 0.40 | 559 | 503 | 224 | 1 |
| 20 | 33 | B/3528-21 | T494B336(M)020A(2) | 6.6 | 10.0 | 3.00 | 168 | 151 | 67 | 1 |
| 20 | 47 | C/6032-28 | T494C476(M)020A(2) | 9.4 | 10.0 | 0.80 | 371 | 334 | 148 | 1 |
| 20 | 47 | D/7343-31 | T494D476(1)020A(2) | 9.4 | 6.0 | 0.20 | 866 | 779 | 346 | 1 |
| 20 | 68 | X/7343-43 | T494X686(1)020A(2) | 13.6 | 6.0 | 0.20 | 908 | 817 | 363 | 1 |
| 20 | 68 | D/7343-31 | T494D686(1)020A(2) | 13.6 | 8.0 | 0.20 | 866 | 779 | 346 | 1 |
| 20 | 100 | D/7343-31 | T494D107(1)020A(2) | 20.0 | 6.0 | 0.68 | 471 | 424 | 188 | 1 |
| 20 | 100 | X/7343-43 | T494X107(1)020A(2) | 20.0 | 8.0 | 0.15 | 1049 | 944 | 420 | 1 |
| 20 | 100 | E/7360-38 | T494E107(1)020A(2) | 20.0 | 8.0 | 0.30 | 816 | 734 | 326 | 1 |
| 20 | 150 | X/7343-43 | T494X157(1)020A(2) | 30.0 | 10.0 | 0.30 | 742 | 668 | 297 | 1 |
| 25 | 0.33 | A/3216-18 | T494A334(1)025A(2) | 0.5 | 4.0 | 10.0 | 87 | 78 | 35 | 1 |
| 25 | 0.47 | A/3216-18 | T494A474(1)025A(2) | 0.5 | 4.0 | 9.0 | 91 | 82 | 36 | 1 |
| 25 | 0.68 | A/3216-18 | T494A684(1)025A(2) | 0.5 | 4.0 | 6.0 | 112 | 101 | 45 | 1 |
| 25 | 1 | B/3528-21 | T494B105(1)025A(2) | 0.5 | 4.0 | 2.0 | 206 | 185 | 82 | 1 |
| 25 | 1 | A/3216-18 | T494A105(1)025A(2) | 0.5 | 4.0 | 4.0 | 137 | 123 | 55 | 1 |
| 25 | 1.5 | B/3528-21 | T494B155(1)025A(2) | 0.5 | 6.0 | 1.5 | 238 | 214 | 95 | 1 |
| 25 | 1.5 | A/3216-18 | T494A155(1)025A(2) | 0.5 | 6.0 | 3.0 | 158 | 142 | 63 | 1 |
| 25 | 1.5 | R/2012-12 | T494R155(1)025A(2) | 0.5 | 8.0 | 6.0 | 65 | 59 | 26 | 1 |
| 25 | 2.2 | C/6032-28 | T494C225(1)025A(2) | 0.6 | 6.0 | 2.2 | 224 | 202 | 90 | 1 |
| 25 | 2.2 | B/3528-21 | T494B225(1)025A(2) | 0.6 | 6.0 | 1.2 | 266 | 239 | 106 | 1 |
| 25 | 2.2 | A/3216-18 | T494A225(1)025A(2) | 0.6 | 6.0 | 3.0 | 158 | 142 | 63 | 1 |
| 25 | 3.3 | C/6032-28 | T494C335(1)025A(2) | 0.8 | 6.0 | 1.2 | 303 | 273 | 121 | 1 |
| 25 | 3.3 | B/3528-21 | T494B335(1)025A(2) | 0.8 | 6.0 | 2.0 | 206 | 185 | 82 | 1 |
| 25 | 3.3 | A/3216-18 | T494A335(1)025A(2) | 0.8 | 6.0 | 3.0 | 158 | 142 | 63 | 1 |
| 25 | 4.7 | C/6032-28 | T494C475(1)025A(2) | 1.2 | 6.0 | 0.6 | 428 | 385 | 171 | 1 |
| 25 | 4.7 | B/3528-21 | T494B475(1)025A(2) | 1.2 | 6.0 | 1.0 | 292 | 263 | 117 | 1 |
| 25 | 4.7 | A/3216-18 | T494A475(M)025A(2) | 1.2 | 8.0 | 3.0 | 158 | 142 | 63 | 1 |
| 25 | 6.8 | C/6032-28 | T494C685(1)025A(2) | 1.7 | 6.0 | 0.6 | 428 | 385 | 171 | 1 |
| 25 | 6.8 | B/3528-21 | T494B685(1)025A(2) | 1.7 | 8.0 | 2.0 | 206 | 185 | 82 | 1 |
| 25 | 10 | D/7343-31 | T494D106(1)025A(2) | 2.5 | 6.0 | 0.4 | 612 | 551 | 245 | 1 |
| 25 | 10 | C/6032-28 | T494C106(1)025A(2) | 2.5 | 6.0 | 0.6 | 428 | 385 | 171 | 1 |
| 25 | 10 | B/3528-21 | T494B106(1)025A(2) | 2.5 | 8.0 | 3.0 | 168 | 151 | 67 | 1 |
| 25 | 15 | D/7343-31 | T494D156(1)025A(2) | 3.8 | 6.0 | 0.35 | 655 | 590 | 262 | 1 |
| 25 | 15 | C/6032-28 | T494C156(1)025A(2) | 3.8 | 6.0 | 0.90 | 350 | 315 | 140 | 1 |
| 25 | 15 | B/3528-21 | T494B156(1)025A(2) | 3.8 | 8.0 | 3.00 | 168 | 151 | 67 | 1 |
| 25 | 22 | D/7343-31 | T494D226(1)025A(2) | 5.5 | 6.0 | 0.3 | 707 | 636 | 283 | 1 |
| 25 | 22 | C/6032-28 | T494C226(1)025A(2) | 5.5 | 6.0 | 1.0 | 332 | 299 | 133 | 1 |
| 25 | 22 | V/7343-20 | T494V226(1)025A(2) | 5.5 | 6.0 | 0.5 | 500 | 450 | 200 | 1 |
| 25 | 33 | X/7343-43 | T494X336(1)025A(2) | 8.3 | 6.0 | 0.3 | 742 | 668 | 297 | 1 |
| 25 | 33 | D/7343-31 | T494D336(1)025A(2) | 8.3 | 6.0 | 0.4 | 612 | 551 | 245 | 1 |
| 25 | 33 | C/6032-28 | T494C336(1)025A(2) | 8.3 | 10.0 | 1.0 | 332 | 299 | 133 | 1 |
| 25 | 47 | X/7343-43 | T494X476(1)025A(2) | 11.8 | 6.0 | 0.3 | 742 | 668 | 297 | 1 |
| 25 | 47 | D/7343-31 | T494D476(1)025A(2) | 11.8 | 10.0 | 0.2 | 866 | 779 | 346 | 1 |
| 25 | 68 | X/7343-43 | T494X686(M)025A(2) | 17.0 | 8.0 | 0.3 | 742 | 668 | 297 | 1 |
| 25 | 68 | D/7343-31 | T494D686(M)025A(2) | 17.0 | 10.0 | 0.5 | 548 | 493 | 219 | 1 |
| 25 | 100 | X/7343-43 | T494X107(M)025A(2) | 25.0 | 8.0 | 0.25 | 812 | 731 | 325 | 1 |
| 35 | 0.1 | A/3216-18 | T494A104(1)035A(2) | 0.5 | 4.0 | 10.0 | 87 | 78 | 35 | 1 |
| VDC | µF | KEMET/EIA | (See below for part options) | µA @ 20°C Max/5 Min | % @ 20°C 120 Hz Max | Ω @ 20°C 100 kHz Max | (mA) 100 kHz 25°C | (mA) 100 kHz 85°C | (mA) 100 kHz 125°C | Reflow Temp ≤ 260°C |
| Rated Voltage | Rated Cap | Case Code/ Case Size | KEMET Part Number | DC Leakage | DF | ESR | Maximum Allowable Ripple Current | | | Moisture Sensitivity |

(1) To complete KEMET part number, insert M for ±20% or K for ±10%. Designates capacitance tolerance.

(2) To complete KEMET part number, insert T = 100% Matte Tin (Sn) Plated, G = Gold Plated, H = Standard Solder coated (SnPb 5% Pb minimum). Designates termination finish.

Refer to Ordering Information for additional detail.

Higher voltage ratings and tighter tolerance product including ESR may be substituted within the same size at KEMET's option. Voltage substitution will be marked with the higher voltage rating. Substitutions can include better than series.

Table 1 – Ratings & Part Number Reference cont'd

| Rated Voltage | Rated Cap | Case Code/ Case Size | KEMET Part Number | DC Leakage | DF | ESR | Maximum Allowable Ripple Current | | | Moisture Sensitivity |
|---------------|-----------|-------------------------|------------------------------|------------------------|------------------------|-------------------------|----------------------------------|----------------------|-----------------------|------------------------|
| VDC | µF | KEMET/EIA | (See below for part options) | µA @ 20°C Max/5 Min | % @ 20°C 120 Hz Max | Ω @ 20°C 100 kHz Max | (mA) 100 kHz 25°C | (mA) 100 kHz 85°C | (mA) 100 kHz 125°C | Reflow Temp ≤ 260°C |
| 35 | 0.15 | A/3216-18 | T494A154(1)035A(2) | 0.5 | 4.0 | 6.0 | 112 | 101 | 45 | 1 |
| 35 | 0.22 | A/3216-18 | T494A224(1)035A(2) | 0.5 | 4.0 | 6.0 | 112 | 101 | 45 | 1 |
| 35 | 0.33 | A/3216-18 | T494A334(1)035A(2) | 0.5 | 4.0 | 6.0 | 112 | 101 | 45 | 1 |
| 35 | 0.47 | B/3528-21 | T494B474(1)035A(2) | 0.5 | 4.0 | 2.5 | 184 | 166 | 74 | 1 |
| 35 | 0.47 | A/3216-18 | T494A474(1)035A(2) | 0.5 | 4.0 | 4.0 | 137 | 123 | 55 | 1 |
| 35 | 0.68 | B/3528-21 | T494B684(1)035A(2) | 0.5 | 4.0 | 2.5 | 184 | 166 | 74 | 1 |
| 35 | 0.68 | A/3216-18 | T494A684(1)035A(2) | 0.5 | 4.0 | 6.0 | 112 | 101 | 45 | 1 |
| 35 | 1 | B/3528-21 | T494B105(1)035A(2) | 0.5 | 4.0 | 2.0 | 206 | 185 | 82 | 1 |
| 35 | 1 | A/3216-18 | T494A105(1)035A(2) | 0.5 | 4.0 | 6.0 | 112 | 101 | 45 | 1 |
| 35 | 1.5 | A/3216-18 | T494A155(1)035A(2) | 0.5 | 6.0 | 4.0 | 137 | 123 | 55 | 1 |
| 35 | 1.5 | C/6032-28 | T494C155(1)035A(2) | 0.5 | 6.0 | 2.5 | 210 | 189 | 84 | 1 |
| 35 | 1.5 | B/3528-21 | T494B155(1)035A(2) | 0.5 | 6.0 | 3.0 | 168 | 151 | 67 | 1 |
| 35 | 2.2 | A/3216-18 | T494A225(1)035A(2) | 0.8 | 6.0 | 3.0 | 158 | 142 | 63 | 1 |
| 35 | 2.2 | C/6032-28 | T494C225(1)035A(2) | 0.8 | 6.0 | 1.5 | 271 | 244 | 108 | 1 |
| 35 | 2.2 | B/3528-21 | T494B225(1)035A(2) | 0.8 | 6.0 | 2.5 | 184 | 166 | 74 | 1 |
| 35 | 3.3 | C/6032-28 | T494C335(1)035A(2) | 1.2 | 6.0 | 0.8 | 371 | 334 | 148 | 1 |
| 35 | 3.3 | B/3528-21 | T494B335(1)035A(2) | 1.2 | 6.0 | 1.3 | 256 | 230 | 102 | 1 |
| 35 | 4.7 | B/3528-21 | T494B475(1)035A(2) | 1.6 | 6.0 | 1.5 | 238 | 214 | 95 | 1 |
| 35 | 4.7 | D/7343-31 | T494D475(1)035A(2) | 1.6 | 6.0 | 0.7 | 463 | 417 | 185 | 1 |
| 35 | 4.7 | C/6032-28 | T494C475(1)035A(2) | 1.6 | 6.0 | 0.7 | 396 | 356 | 158 | 1 |
| 35 | 6.8 | D/7343-31 | T494D685(1)035A(2) | 2.4 | 6.0 | 0.5 | 548 | 493 | 219 | 1 |
| 35 | 6.8 | C/6032-28 | T494C685(1)035A(2) | 2.4 | 6.0 | 0.9 | 350 | 315 | 140 | 1 |
| 35 | 10 | D/7343-31 | T494D106(1)035A(2) | 3.5 | 6.0 | 0.4 | 612 | 551 | 245 | 1 |
| 35 | 10 | C/6032-28 | T494C106(M)035A(2) | 3.5 | 6.0 | 1.2 | 303 | 273 | 121 | 1 |
| 35 | 10 | V/7343-20 | T494V106(1)035A(2) | 3.5 | 6.0 | 0.8 | 395 | 356 | 158 | 1 |
| 35 | 15 | X/7343-43 | T494X156(1)035A(2) | 5.3 | 6.0 | 0.30 | 742 | 668 | 297 | 1 |
| 35 | 15 | D/7343-31 | T494D156(1)035A(2) | 5.3 | 6.0 | 0.35 | 655 | 590 | 262 | 1 |
| 35 | 22 | X/7343-43 | T494X226(1)035A(2) | 7.7 | 6.0 | 0.3 | 742 | 668 | 297 | 1 |
| 35 | 22 | D/7343-31 | T494D226(1)035A(2) | 7.7 | 6.0 | 0.4 | 612 | 551 | 245 | 1 |
| 35 | 33 | D/7343-31 | T494D336(1)035A(2) | 11.6 | 6.0 | 0.6 | 500 | 450 | 200 | 1 |
| 35 | 33 | X/7343-43 | T494X336(1)035A(2) | 11.6 | 6.0 | 0.3 | 524 | 472 | 210 | 1 |
| 35 | 47 | X/7343-43 | T494X476(1)035A(2) | 16.5 | 8.0 | 0.5 | 574 | 517 | 230 | 1 |
| 35 | 47 | E/7360-38 | T494E476(1)035A(2) | 16.5 | 10.0 | 0.3 | 816 | 734 | 326 | 1 |
| 50 | 0.1 | A/3216-18 | T494A104(1)050A(2) | 0.5 | 4.0 | 10.0 | 87 | 78 | 35 | 1 |
| 50 | 0.15 | B/3528-21 | T494B154(1)050A(2) | 0.5 | 4.0 | 10.0 | 92 | 83 | 37 | 1 |
| 50 | 0.15 | A/3216-18 | T494A154(1)050A(2) | 0.5 | 4.0 | 10.0 | 87 | 78 | 35 | 1 |
| 50 | 0.22 | B/3528-21 | T494B224(1)050A(2) | 0.5 | 4.0 | 10.0 | 92 | 83 | 37 | 1 |
| 50 | 0.33 | B/3528-21 | T494B334(1)050A(2) | 0.5 | 4.0 | 2.5 | 184 | 166 | 74 | 1 |
| 50 | 0.47 | C/6032-28 | T494C474(1)050A(2) | 0.5 | 4.0 | 1.8 | 247 | 222 | 99 | 1 |
| 50 | 0.47 | B/3528-21 | T494B474(1)050A(2) | 0.5 | 4.0 | 2.0 | 206 | 185 | 82 | 1 |
| 50 | 0.68 | C/6032-28 | T494C684(1)050A(2) | 0.5 | 4.0 | 1.6 | 262 | 236 | 105 | 1 |
| 50 | 0.68 | B/3528-21 | T494B684(1)050A(2) | 0.5 | 4.0 | 3.0 | 168 | 151 | 67 | 1 |
| 50 | 1 | A/3216-18 | T494A105(1)050A(2) | 0.5 | 4.0 | 5.0 | 122 | 110 | 49 | 1 |
| 50 | 1 | C/6032-28 | T494C105(1)050A(2) | 0.5 | 4.0 | 1.6 | 262 | 236 | 105 | 1 |
| 50 | 1 | B/3528-21 | T494B105(1)050A(2) | 0.5 | 6.0 | 4.0 | 146 | 131 | 58 | 1 |
| 50 | 1 | V/7343-20 | T494V105(M)050A(2) | 0.5 | 4.0 | 4.0 | 177 | 159 | 71 | 1 |
| 50 | 1.5 | D/7343-31 | T494D155(1)050A(2) | 0.8 | 6.0 | 1.0 | 387 | 348 | 155 | 1 |
| 50 | 1.5 | C/6032-28 | T494C155(1)050A(2) | 0.8 | 6.0 | 1.5 | 271 | 244 | 108 | 1 |
| 50 | 2.2 | D/7343-31 | T494D225(1)050A(2) | 1.1 | 6.0 | 0.8 | 433 | 390 | 173 | 1 |
| 50 | 2.2 | C/6032-28 | T494C225(1)050A(2) | 1.1 | 6.0 | 1.5 | 271 | 244 | 108 | 1 |
| VDC | µF | KEMET/EIA | (See below for part options) | µA @ 20°C Max/5 Min | % @ 20°C 120 Hz Max | Ω @ 20°C 100 kHz Max | (mA) 100 kHz 25°C | (mA) 100 kHz 85°C | (mA) 100 kHz 125°C | Reflow Temp ≤ 260°C |
| Rated Voltage | Rated Cap | Case Code/ Case Size | KEMET Part Number | DC Leakage | DF | ESR | Maximum Allowable Ripple Current | | | Moisture Sensitivity |

(1) To complete KEMET part number, insert M for ±20% or K for ±10%. Designates capacitance tolerance.

(2) To complete KEMET part number, insert T = 100% Matte Tin (Sn) Plated, G = Gold Plated, H = Standard Solder coated (SnPb 5% Pb minimum). Designates termination finish.

Refer to Ordering Information for additional detail.

Higher voltage ratings and tighter tolerance product including ESR may be substituted within the same size at KEMET's option. Voltage substitution will be marked with the higher voltage rating. Substitutions can include better than series.

Table 1 – Ratings & Part Number Reference cont'd

| Rated Voltage | Rated Cap | Case Code/ Case Size | KEMET Part Number | DC Leakage | DF | ESR | Maximum Allowable Ripple Current | | | Moisture Sensitivity |
|---------------|-----------|-------------------------|------------------------------|------------------------|------------------------|-------------------------|----------------------------------|----------------------|-----------------------|------------------------|
| VDC | µF | KEMET/EIA | (See below for part options) | µA @ 20°C Max/5 Min | % @ 20°C 120 Hz Max | Ω @ 20°C 100 kHz Max | (mA) 100 kHz 25°C | (mA) 100 kHz 85°C | (mA) 100 kHz 125°C | Reflow Temp ≤ 260°C |
| 50 | 3.3 | D/7343-31 | T494D335(1)050A(2) | 1.7 | 6.0 | 0.8 | 433 | 390 | 173 | 1 |
| 50 | 4.7 | D/7343-31 | T494D475(1)050A(2) | 2.4 | 6.0 | 0.6 | 500 | 450 | 200 | 1 |
| 50 | 6.8 | X/7343-43 | T494X685(1)050A(2) | 3.4 | 6.0 | 0.5 | 574 | 517 | 230 | 1 |
| 50 | 6.8 | D/7343-31 | T494D685(1)050A(2) | 3.4 | 6.0 | 0.7 | 463 | 417 | 185 | 1 |
| 50 | 10 | X/7343-43 | T494X106(M)050A(2) | 5.0 | 6.0 | 0.4 | 642 | 578 | 257 | 1 |
| 50 | 10 | D/7343-31 | T494D106(1)050A(2) | 5.0 | 6.0 | 0.7 | 463 | 417 | 185 | 1 |
| 50 | 15 | X/7343-43 | T494X156(1)050A(2) | 7.5 | 6.0 | 0.4 | 642 | 578 | 257 | 1 |
| 50 | 22 | X/7343-43 | T494X226(1)050A(2) | 11.0 | 10.0 | 0.5 | 574 | 517 | 230 | 1 |
| VDC | µF | KEMET/EIA | (See below for part options) | µA @ 20°C Max/5 Min | % @ 20°C 120 Hz Max | Ω @ 20°C 100 kHz Max | (mA) 100 kHz 25°C | (mA) 100 kHz 85°C | (mA) 100 kHz 125°C | Reflow Temp ≤ 260°C |
| Rated Voltage | Rated Cap | Case Code/ Case Size | KEMET Part Number | DC Leakage | DF | ESR | Maximum Allowable Ripple Current | | | Moisture Sensitivity |

(1) To complete KEMET part number, insert M for ±20% or K for ±10%. Designates capacitance tolerance.

(2) To complete KEMET part number, insert T = 100% Matte Tin (Sn) Plated, G = Gold Plated, H = Standard Solder coated (SnPb 5% Pb minimum). Designates termination finish.

Refer to Ordering Information for additional detail.

Higher voltage ratings and tighter tolerance product including ESR may be substituted within the same size at KEMET's option. Voltage substitution will be marked with the higher voltage rating. Substitutions can include better than series.

Recommended Voltage Derating Guidelines

| -55°C to 125°C | | |
|---|------------------------|----------------|
| % Change in Working DC Voltage with Temperature | 50% of V _R | V _R |
| Recommended Maximum Application Voltage | 100% of V _R | V _R |



Ripple Current/Ripple Voltage

| KEMET Series and Case Code | EIA Case Code | Maximum Power Dissipation (P max) mWatts @ 25°C w/+20°C Rise |
|----------------------------|---------------|--|
| A | 3216-18 | 75 |
| B | 3528-21 | 85 |
| C | 6032-28 | 110 |
| D | 7343-31 | 150 |
| X | 7343-43 | 165 |
| E | 7360-38 | 200 |
| T428P | 7360-38 | 325 |
| S | 3216-12 | 60 |
| T | 3528-12 | 70 |
| U | 6032-15 | 90 |
| V | 7343-20 | 125 |
| T510X | 7343-43 | 270 |
| T510E | 7360-38 | 285 |

| Temperature Compensation Multipliers for Maximum Power Dissipation | | |
|--|------|-------|
| ≤ 25°C | 85°C | 125°C |
| 1.00 | 0.90 | 0.40 |

T = Environmental Temperature

Using the P max of the device, the maximum allowable rms ripple current or voltage may be determined.

$$I(max) = \sqrt{P_{max}/R}$$

$$E(max) = \sqrt{P_{max} \cdot R}$$

I = rms ripple current (amperes)

E = rms ripple voltage (volts)

P max = maximum power dissipation (watts)

R = ESR at specified frequency (ohms)

Reverse Voltage

Solid tantalum capacitors are polar devices and may be permanently damaged or destroyed if connected with the wrong polarity. The positive terminal is identified on the capacitor body by a stripe plus in some cases a beveled edge. A small degree of transient reverse voltage is permissible for short periods per the table. The capacitors should not be operated continuously in reverse mode, even within these limits.

| Temperature | Permissible Transient Reverse Voltage |
|-------------|---------------------------------------|
| 25°C | 15% of Rated Voltage |
| 85°C | 5% of Rated Voltage |
| 125°C | 1% of Rated Voltage |

Table 2 – Land Dimensions/Courtyard

| KEMET | Metric Size Code | Density Level A: Maximum (Most) Land Protrusion (mm) | | | | | Density Level B: Median (Nominal) Land Protrusion (mm) | | | | | Density Level C: Minimum (Least) Land Protrusion (mm) | | | | |
|----------------|------------------|--|------|------|-------|------|--|------|------|------|------|---|------|------|------|------|
| | | X | Y | C | V1 | V2 | X | Y | C | V1 | V2 | X | Y | C | V1 | V2 |
| Case | EIA | | | | | | | | | | | | | | | |
| A | 3216-18 | 1.35 | 2.15 | 1.45 | 6.10 | 2.80 | 1.25 | 1.75 | 1.35 | 5.00 | 2.30 | 1.15 | 1.35 | 1.25 | 4.10 | 2.00 |
| B | 3528-21 | 2.35 | 2.15 | 1.45 | 6.10 | 4.00 | 2.25 | 1.75 | 1.35 | 5.00 | 3.50 | 2.15 | 1.35 | 1.25 | 4.10 | 3.20 |
| C | 6032-28 | 2.35 | 2.65 | 2.60 | 8.90 | 4.40 | 2.25 | 2.25 | 2.50 | 7.80 | 3.90 | 2.15 | 1.85 | 2.40 | 6.90 | 3.60 |
| D | 7343-31 | 2.55 | 3.75 | 2.70 | 10.20 | 5.50 | 2.45 | 3.35 | 2.60 | 9.10 | 5.00 | 2.35 | 2.95 | 2.50 | 8.20 | 4.70 |
| E ¹ | 7360-38 | 4.25 | 2.65 | 3.20 | 10.10 | 7.20 | 4.15 | 2.25 | 3.30 | 9.40 | 6.70 | 4.05 | 1.85 | 3.00 | 8.10 | 6.40 |
| S | 3216-12 | 1.35 | 2.15 | 1.45 | 6.10 | 2.80 | 1.25 | 1.75 | 1.35 | 5.00 | 2.30 | 1.15 | 1.35 | 1.25 | 4.10 | 2.00 |
| T | 3528-12 | 2.35 | 2.15 | 1.45 | 6.10 | 4.00 | 2.25 | 1.75 | 1.35 | 5.00 | 3.50 | 2.15 | 1.35 | 1.25 | 4.10 | 3.20 |
| U | 6032-15 | 2.35 | 2.65 | 2.60 | 8.90 | 4.40 | 2.25 | 2.25 | 2.50 | 7.80 | 3.90 | 2.15 | 1.85 | 2.40 | 6.90 | 3.60 |
| V | 7343-20 | 2.55 | 3.75 | 2.70 | 10.20 | 5.50 | 2.45 | 3.35 | 2.60 | 9.10 | 5.00 | 2.35 | 2.95 | 2.50 | 8.20 | 4.70 |
| X ¹ | 7343-43 | 2.55 | 3.75 | 2.70 | 10.20 | 5.50 | 2.45 | 3.35 | 2.60 | 9.10 | 5.00 | 2.35 | 2.95 | 2.50 | 8.20 | 4.70 |

Density Level A: For low-density product applications. Recommended for wave solder applications and provides a wider process window for reflow solder processes.

Density Level B: For products with a moderate level of component density. Provides a robust solder attachment condition for reflow solder processes.

Density Level C: For high component density product applications. Before adapting the minimum land pattern variations the user should perform qualification testing based on the conditions outlined in IPC Standard 7351 (IPC-7351).

¹ Height of these chips may create problems in wave soldering.



Soldering Process

KEMET's families of surface mount capacitors are compatible with wave (single or dual), convection, IR, or vapor phase reflow techniques. Preheating of these components is recommended to avoid extreme thermal stress. KEMET's recommended profile conditions for convection and IR reflow reflect the profile conditions of the IPC/J-STD-020D standard for moisture sensitivity testing. The devices can safely withstand a maximum of three reflow passes at these conditions.

Please note that although the X/7343-43 case size can withstand wave soldering, the tall profile (4.3 mm maximum) dictates care in wave process development.

Hand soldering should be performed with care due to the difficulty in process control. If performed, care should be taken to avoid contact of the soldering iron to the molded case. The iron should be used to heat the solder pad, applying solder between the pad and the termination, until reflow occurs. Once reflow occurs, the iron should be removed immediately. "Wiping" the edges of a chip and heating the top surface is not recommended.

During typical reflow operations, a slight darkening of the gold-colored epoxy may be observed. This slight darkening is normal and not harmful to the product. Marking permanency is not affected by this change.

| Profile Feature | SnPb Assembly | Pb-Free Assembly |
|---|---------------------|---------------------|
| Preheat/Soak | | |
| Temperature Minimum (T_{smin}) | 100°C | 150°C |
| Temperature Maximum (T_{smax}) | 150°C | 200°C |
| Time (t_s) from T_{smin} to T_{smax} | 60 – 120 seconds | 60 – 120 seconds |
| Ramp-up Rate (T_L to T_p) | 3°C/seconds maximum | 3°C/seconds maximum |
| Liquidous Temperature (T_L) | 183°C | 217°C |
| Time Above Liquidous (t_L) | 60 – 150 seconds | 60 – 150 seconds |
| Peak Temperature (T_p) | 220°C* 235°C** | 250°C* 260°C** |
| Time within 5°C of Maximum Peak Temperature (t_p) | 20 seconds maximum | 30 seconds maximum |
| Ramp-down Rate (T_p to T_L) | 6°C/seconds maximum | 6°C/seconds maximum |
| Time 25°C to Peak Temperature | 6 minutes maximum | 8 minutes maximum |

Note: All temperatures refer to the center of the package, measured on the package body surface that is facing up during assembly reflow.

*Case Size D, E, P, Y, and X

**Case Size A, B, C, H, I, K, M, R, S, T, U, V, W, and Z



Construction



Capacitor Marking

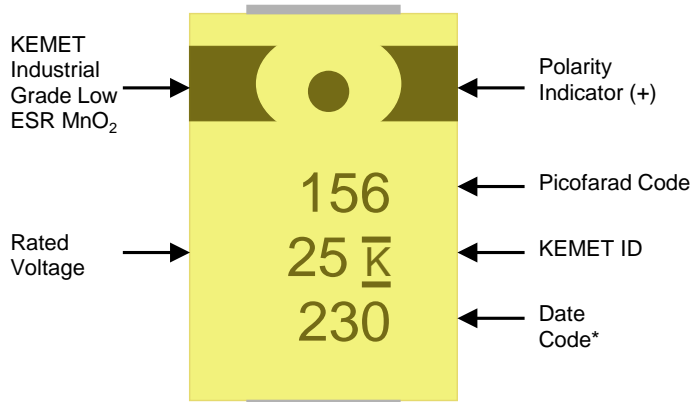

* 230 = 30th week of 2012

| Date Code * | |
|--|--|
| 1 st digit = Last number of Year | 9 = 2009 0 = 2010 1 = 2011 2 = 2012 3 = 2013 4 = 2014 |
| 2 nd and 3 rd digit = Week of the Year | 01 = 1 st week of the Year to 52 = 52 nd week of the Year |

Storage

Tantalum chip capacitors should be stored in normal working environments. While the chips themselves are quite robust in other environments, solderability will be degraded by exposure to high temperatures, high humidity, corrosive atmospheres, and long term storage. In addition, packaging materials will be degraded by high temperature— reels may soften or warp and tape peel force may increase. KEMET recommends that maximum storage temperature not exceed 40°C and maximum storage humidity not exceed 60% relative humidity. Temperature fluctuations should be minimized to avoid condensation on the parts and atmospheres should be free of chlorine and sulphur bearing compounds. For optimized solderability chip stock should be used promptly, preferably within three years of receipt.

Overview

The low ESR, surge-robust T495 Series is designed for demanding applications that require high surge current and high ripple current capability. This series builds upon the proven capabilities of our industrial grade tantalum chip capacitors to offer several advantages such as low ESR, high ripple

current capability, excellent capacitance stability, and improved resistance to high in-rush currents. These benefits are achieved through a combination of proprietary design, materials, and process parameters as well as high-stress, low impedance electrical conditioning performed prior to screening.

Benefits

- Meets or exceeds EIA Standard 535BAAC
- Taped and reeled per EIA 481-1
- High surge current capability
- Optional gold-plated terminations
- High ripple current capability
- 100% surge current test on C, D, E, U, V, X sizes
- 100% steady-state accelerated aging
- Capacitance values of 0.1 μ F to 1,000 μ F
- Tolerances of $\pm 10\%$ and $\pm 20\%$
- Voltage rating of 2.5 – 50 VDC
- Extended range values
- Available tested to DSCC 95158
- RoHS Compliant and lead-free terminations
- Operating temperature range of -55°C to +125°C

Applications

Typical applications include decoupling and filtering in industrial and automotive end applications, such as DC/DC converters, portable electronics, telecommunications, and control units requiring high ripple current capability.



Environmental Compliance

RoHS Compliant (6/6) according to Directive 2002/95/EC when ordered with 100% Sn Solder



RoHS Compliant

SPICE

For a detailed analysis of specific part numbers, please visit www.kemet.com for a free download of KEMET's SPICE software. The KEMET SPICE program is freeware intended to aid design engineers in analyzing the performance of these capacitors over frequency, temperature, ripple, and DC bias conditions.

Ordering Information

| T | 495 | X | 107 | M | 010 | A | T | E045 | |
|-----------------|----------------------|------------------------|--|-----------------------|---|---------------------|---|---|------------------------------------|
| Capacitor Class | Series | Case Size | Capacitance Code (pF) | Capacitance Tolerance | Voltage | Failure Rate/Design | Lead Material | ESR | Packaging (C-Spec) |
| T = Tantalum | Surge Robust Low ESR | A, B, C, D, E, T, V, X | First two digits represent significant figures. Third digit specifies number of zeros. | K = ±10% M = ±20% | 2R5 = 2.5 V 004 = 4 V 006 = 6.3 V 010 = 10 V 016 = 16 V 020 = 20 V 025 = 25 V 035 = 35 V 050 = 50 V | A = N/A | T = 100% Matte Tin (Sn) Plated H = Standard Solder Coated (SnPb 5% Pb minimum) G = Gold Plated (A, B, C, D, X only) | Last three digits specify ESR in mΩ. (45 = 45 mΩ) | Blank = 7" Reel 7280 = 13" Reel |

Performance Characteristics

| Item | Performance Characteristics |
|-------------------------|---|
| Operating Temperature | -55°C to 125°C |
| Rated Capacitance Range | 0.47 – 1,000 μF @ 120 Hz/25°C |
| Capacitance Tolerance | K Tolerance (10%), M Tolerance (20%) |
| Rated Voltage Range | 2.5 – 50 V |
| DF (120 Hz) | Refer to Part Number Electrical Specification Table |
| ESR (100 kHz) | Refer to Part Number Electrical Specification Table |
| Leakage Current | ≤ 0.01 CV (μA) at rated voltage after 5 minutes |

Qualification

| Test | Condition | Characteristics | | | | | |
|----------------------------|--|-----------------|--|-------|-----------------------------|----------|--|
| Endurance | 85°C @ rated voltage, 2,000 hours. 125°C @ 2/3 rated voltage, 2,000 hours. | Δ C/C | Within ±10% of initial value | | | | |
| | | DF | Within initial limits | | | | |
| | | DCL | Within 1.25 x initial limit | | | | |
| | | ESR | Within initial limits | | | | |
| Storage Life | 125°C @ 0 volts, 2,000 hours. | Δ C/C | Within ±10% of initial value | | | | |
| | | DF | Within initial limits | | | | |
| | | DCL | Within 1.25 x initial limit | | | | |
| | | ESR | Within initial limits | | | | |
| Thermal Shock | MIL-STD-202, Method 107, Condition B, mounted, -55°C to 125°C, 1,000 cycles. | Δ C/C | Within ±5% of initial value | | | | |
| | | DF | Within initial limits | | | | |
| | | DCL | Within 1.25 x initial limit | | | | |
| | | ESR | Within initial limits | | | | |
| Temperature Stability | Extreme temperature exposure at a succession of continuous steps at +25°C, -55°C, +25°C, +85°C, +125°C, +25°C. | +25°C | -55°C | +85°C | +125°C | | |
| | | Δ C/C | IL* | ±10% | ±10% | ±20% | |
| | | DF | IL | IL | 1.5 x IL | 1.5 x IL | |
| | | DCL | IL | n/a | 10 x IL | 12 x IL | |
| | | Surge Voltage | 25°C and 85°C, 1.32 x rated voltage 1,000 cycles (125°C, 1.2 x rated voltage). | Δ C/C | Within ±5% of initial value | | |
| | | | | DF | Within initial limits | | |
| DCL | Within initial limits | | | | | | |
| ESR | Within initial limits | | | | | | |
| Mechanical Shock/Vibration | MIL-STD-202, Method 213, Condition I, 100 G peak MIL-STD-202, Method 204, Condition D, 10 Hz to 2,000 Hz, 20 G peak | Δ C/C | Within ±10% of initial value | | | | |
| | | DF | Within initial limits | | | | |
| | | DCL | Within initial limits | | | | |

*IL = Initial limit

Electrical Characteristics

ESR vs. Frequency



Capacitance vs. Frequency

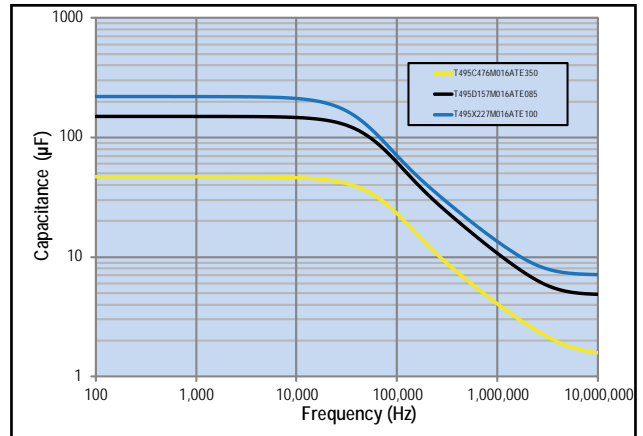

Dimensions – Millimeters (Inches)

Metric will govern



| Case Size | | Component | | | | | | | | | | | | |
|-----------|---------|----------------------------|----------------------------|----------------------------|--------------------|--------------------|-------------------------|------------------------------|------------|------------|-------------|-------------|------------|------------|
| KEMET | EIA | L* | W* | H* | F* ±0.1 ±(.004) | S* ±0.3 ±(.012) | B* ±0.15 (Ref) ±.006 | X (Ref) | P (Ref) | R (Ref) | T (Ref) | A (Min) | G (Ref) | E (Ref) |
| A | 3216-18 | 3.2 ± 0.2 (.126 ± .008) | 1.6 ± 0.2 (.063 ± .008) | 1.6 ± 0.2 (.063 ± .008) | 1.2 (.047) | 0.8 (.031) | 0.4 (.016) | 0.10 ± 0.10 (.004 ± .004) | 0.4 (.016) | 0.4 (.016) | 0.13 (.005) | 0.8 (.31) | 1.1 (.043) | 1.3 (.051) |
| B | 3528-21 | 3.5 ± 0.2 (.138 ± .008) | 2.8 ± 0.2 (.110 ± .008) | 1.9 ± 0.2 (.075 ± .008) | 2.2 (.087) | 0.8 (.031) | 0.4 (.016) | 0.10 ± 0.10 (.004 ± .004) | 0.5 (.020) | 1.0 (.039) | 0.13 (.005) | 1.1 (0.043) | 1.8 (.071) | 2.2 (.087) |
| C | 6032-28 | 6.0 ± 0.3 (.236 ± .03) | 3.2 ± 0.3 (.126 ± .012) | 2.5 ± 0.3 (.098 ± .012) | 2.2 (.087) | 1.3 (.051) | 0.5 (.020) | 0.10 ± 0.10 (.004 ± .004) | 0.9 (.035) | 1.0 (.039) | 0.13 (.005) | 2.5(.098) | 2.8 (.110) | 2.4 (.094) |
| D | 7343-31 | 7.3 ± 0.3 (.287 ± .012) | 4.3 ± 0.3 (.169 ± .012) | 2.8 ± 0.3 (.110 ± .012) | 2.4 (.094) | 1.3 (.051) | 0.5 (.020) | 0.10 ± 0.10 (.004 ± .004) | 0.9 (.035) | 1.0 (.039) | 0.13 (.005) | 3.8 (.150) | 3.5 (.138) | 3.5 (.138) |
| X | 7343-43 | 7.3 ± 0.3 (.287 ± .012) | 4.3 ± 0.3 (.169 ± .012) | 4.0 ± 0.3 (.157 ± .012) | 2.4 (.094) | 1.3 (.051) | 0.5 (.020) | 0.10 ± 0.10 (.004 ± .004) | 1.7 (.067) | 1.0 (.039) | 0.13 (.005) | 3.8 (.150) | 3.5 (.138) | 3.5 (.138) |
| E | 7360-38 | 7.3 ± 0.3 (.287 ± .012) | 6.0 ± 0.3 (.236 ± .012) | 3.6 ± 0.2 (.142 ± .008) | 4.1 (.161) | 1.3 (.051) | 0.5 (.020) | 0.10 ± 0.10 (.004 ± .004) | 0.9 (.035) | 1.0 (.039) | 0.13 (.005) | 3.8 (.150) | 3.5 (.138) | 3.5 (.138) |
| T | 3528-12 | 3.5 ± 0.2 (.138 ± .008) | 2.8 ± 0.2 (.110 ± .008) | 1.2 (.047) | 2.2 (.087) | 0.8 (.031) | N/A | 0.05 (.002) | N/A | N/A | 0.13 (.005) | 1.1 (.043) | 1.8 (.071) | 2.2 (.087) |
| V | 7343-20 | 7.3 ± 0.3 (.287 ± .012) | 4.3 ± 0.3 (.169 ± .012) | 2.0 (.079) | 2.4 (.094) | 1.3 (.051) | N/A | 0.05 (.002) | N/A | N/A | 0.13 (.005) | 3.8 (.150) | 3.5 (.138) | 3.5 (.138) |

Notes: (Ref) – Dimensions provided for reference only. No dimensions provided for B, P or R because low profile cases do not have a bevel or a notch.

* MIL-PRF-55365/8 specified dimensions

Table 1 – Ratings & Part Number Reference

| Rated Voltage | Rated Cap | Case Code/ Case Size | KEMET Part Number | DC Leakage | DF | ESR | Maximum Allowable Ripple Current | | | Moisture Sensitivity |
|---------------|-----------|-------------------------|------------------------------|--------------------------|-------------------------|--------------------------|----------------------------------|-----------------------|------------------------|------------------------|
| VDC | µF | KEMET/EIA | (See below for part options) | µAmps +20°C Max/5 Min | % @ +20°C 120 Hz Max | mΩ @ 20°C 100 kHz Max | (mA) 100 kHz 25°C | (mA) 100 kHz +85°C | (mA) 100 kHz +125°C | Reflow Temp ≤ 260°C |
| 2.5 | 220 | D/7343-31 | T495D227(1)2R5A(2)E045 | 5.5 | 8.0 | 45 | 1826 | 1643 | 730 | 1 |
| 2.5 | 470 | D/7343-31 | T495D477(1)2R5A(2)E035 | 11.8 | 8.0 | 35 | 2070 | 1863 | 828 | 1 |
| 2.5 | 1000 | X/7343-43 | T495X108(1)2R5A(2)E030 | 25.0 | 15.0 | 30 | 2345 | 2111 | 938 | 1 |
| 2.5 | 1000 | X/7343-43 | T495X108(1)2R5A(2)E040 | 25.0 | 15.0 | 40 | 2031 | 1828 | 812 | 1 |
| 4 | 68 | V/7343-20 | T495V686(1)004A(2)E150 | 2.7 | 6.0 | 150 | 913 | 822 | 365 | 1 |
| 4 | 100 | B/3528-21 | T495B107(1)004A(2)E500 | 4.0 | 8.0 | 500 | 412 | 371 | 165 | 1 |
| 4 | 150 | B/3528-21 | T495B157(M)004A(2)E900 | 6.0 | 12.0 | 900 | 307 | 276 | 123 | 1 |
| 4 | 150 | C/6032-28 | T495C157(1)004A(2)E070 | 6.0 | 12.0 | 70 | 1254 | 1129 | 502 | 1 |
| 4 | 150 | C/6032-28 | T495C157(1)004A(2)E250 | 6.0 | 8.0 | 250 | 663 | 597 | 265 | 1 |
| 4 | 220 | D/7343-31 | T495D227(1)004A(2)E040 | 8.8 | 8.0 | 40 | 1936 | 1742 | 774 | 1 |
| 4 | 220 | D/7343-31 | T495D227(1)004A(2)E050 | 8.8 | 8.0 | 50 | 1732 | 1559 | 693 | 1 |
| 4 | 220 | D/7343-31 | T495D227(1)004A(2)E100 | 8.8 | 8.0 | 100 | 1225 | 1103 | 490 | 1 |
| 4 | 330 | C/6032-28 | T495C337(1)004A(2)E300 | 13.2 | 10.0 | 300 | 606 | 545 | 242 | 1 |
| 4 | 330 | C/6032-28 | T495C337(1)004A(2)E700 | 13.2 | 12.0 | 700 | 396 | 356 | 158 | 1 |
| 4 | 330 | D/7343-31 | T495D337(1)004A(2)E030 | 13.2 | 8.0 | 30 | 2236 | 2012 | 894 | 1 |
| 4 | 330 | D/7343-31 | T495D337(1)004A(2)E045 | 13.2 | 8.0 | 45 | 1826 | 1643 | 730 | 1 |
| 4 | 470 | D/7343-31 | T495D477(1)004A(2)E045 | 18.8 | 12.0 | 45 | 1826 | 1643 | 730 | 1 |
| 4 | 470 | D/7343-31 | T495D477(1)004A(2)E100 | 18.8 | 12.0 | 100 | 1225 | 1103 | 490 | 1 |
| 4 | 470 | X/7343-43 | T495X477(1)004A(2)E030 | 18.8 | 8.0 | 30 | 2345 | 2111 | 938 | 1 |
| 4 | 470 | X/7343-43 | T495X477(1)004A(2)E045 | 18.8 | 8.0 | 45 | 1915 | 1724 | 766 | 1 |
| 4 | 470 | X/7343-43 | T495X477(1)004A(2)E100 | 18.8 | 8.0 | 100 | 1285 | 1157 | 514 | 1 |
| 4 | 1000 | X/7343-43 | T495X108(1)004A(2)E030 | 40.0 | 12.0 | 30 | 2345 | 2111 | 938 | 1 |
| 4 | 1000 | X/7343-43 | T495X108(1)004A(2)E040 | 40.0 | 12.0 | 40 | 2031 | 1828 | 812 | 1 |
| 4 | 1000 | X/7343-43 | T495X108(1)004A(2)E060 | 40.0 | 12.0 | 60 | 1658 | 1492 | 663 | 1 |
| 4 | 1000 | X/7343-43 | T495X108(1)004A(2)E070 | 40.0 | 12.0 | 70 | 1535 | 1382 | 614 | 1 |
| 4 | 1000 | X/7343-43 | T495X108(1)004A(2)E090 | 40.0 | 12.0 | 90 | 1354 | 1219 | 542 | 1 |
| 4 | 1000 | E/7360-38 | T495E108(1)004A(2)E035 | 40.0 | 15.0 | 35 | 2390 | 2151 | 956 | 1 |
| 4 | 1000 | E/7360-38 | T495E108(1)004A(2)E050 | 40.0 | 15.0 | 50 | 2000 | 1800 | 800 | 1 |
| 6.3 | 6.8 | A/3216-18 | T495A685(1)006A(2)E2K0 | 0.5 | 6.0 | 2000 | 194 | 175 | 78 | 1 |
| 6.3 | 10 | A/3216-18 | T495A106(1)006A(2)E1K0 | 0.6 | 6.0 | 1000 | 274 | 247 | 110 | 1 |
| 6.3 | 10 | A/3216-18 | T495A106(1)006A(2)E1K5 | 0.6 | 6.0 | 1500 | 224 | 202 | 90 | 1 |
| 6.3 | 10 | A/3216-18 | T495A106(1)006A(2)E2K0 | 0.6 | 6.0 | 2000 | 194 | 175 | 78 | 1 |
| 6.3 | 47 | B/3528-21 | T495B476(1)006A(2)E450 | 3.0 | 6.0 | 450 | 435 | 392 | 174 | 1 |
| 6.3 | 47 | C/6032-28 | T495C476(1)006A(2)E250 | 3.0 | 6.0 | 250 | 663 | 597 | 265 | 1 |
| 6.3 | 47 | V/7343-20 | T495V476(1)006A(2)E150 | 3.0 | 6.0 | 150 | 913 | 822 | 365 | 1 |
| 6.3 | 68 | D/7343-31 | T495D686(1)006A(2)E175 | 4.3 | 4.0 | 175 | 926 | 833 | 370 | 1 |
| 6.3 | 68 | D/7343-31 | T495D686(1)006A(2)4095 | 4.3 | 4.0 | 175 | 926 | 833 | 370 | 1 |
| 6.3 | 100 | B/3528-21 | T495B107(1)006A(2)E400 | 6.3 | 15.0 | 400 | 461 | 415 | 184 | 1 |
| 6.3 | 100 | B/3528-21 | T495B107(M)006A(2)E700 | 6.3 | 15.0 | 700 | 348 | 313 | 139 | 1 |
| 6.3 | 100 | C/6032-28 | T495C107(1)006A(2)E075 | 6.3 | 8.0 | 75 | 1211 | 1090 | 484 | 1 |
| 6.3 | 100 | C/6032-28 | T495C107(1)006A(2)E150 | 6.3 | 8.0 | 150 | 856 | 770 | 342 | 1 |
| 6.3 | 100 | D/7343-31 | T495D107(1)006A(2)E050 | 6.3 | 6.0 | 50 | 1732 | 1559 | 693 | 1 |
| 6.3 | 100 | D/7343-31 | T495D107(1)006A(2)E130 | 6.3 | 6.0 | 130 | 1074 | 967 | 430 | 1 |
| 6.3 | 100 | D/7343-31 | T495D107(1)006A(2)E150 | 6.3 | 8.0 | 150 | 1000 | 900 | 400 | 1 |
| 6.3 | 100 | V/7343-20 | T495V107(1)006A(2)E090 | 6.3 | 8.0 | 90 | 1179 | 1061 | 472 | 1 |
| 6.3 | 100 | V/7343-20 | T495V107(1)006A(2)E150 | 6.3 | 8.0 | 150 | 913 | 822 | 365 | 1 |
| 6.3 | 150 | C/6032-28 | T495C157(1)006A(2)E050 | 9.5 | 8.0 | 50 | 1483 | 1335 | 593 | 1 |
| 6.3 | 150 | C/6032-28 | T495C157(M)006A(2)E200 | 9.5 | 8.0 | 200 | 742 | 668 | 297 | 1 |
| 6.3 | 150 | V/7343-20 | T495V157(1)006A(2)E040 | 9.5 | 8.0 | 40 | 1768 | 1591 | 707 | 1 |
| 6.3 | 150 | V/7343-20 | T495V157(1)006A(2)E070 | 9.5 | 8.0 | 70 | 1336 | 1202 | 534 | 1 |
| VDC | µF | KEMET/EIA | (See below for part options) | µAmps +20°C Max/5 Min | % @ +20°C 120 Hz Max | mΩ @ 20°C 100 kHz Max | (mA) 100 kHz 25°C | (mA) 100 kHz +85°C | (mA) 100 kHz +125°C | Reflow Temp ≤ 260°C |
| Rated Voltage | Rated Cap | Case Code/ Case Size | KEMET Part Number | DC Leakage | DF | ESR | Maximum Allowable Ripple Current | | | Moisture Sensitivity |

(1) To complete KEMET part number, insert M for ±20% or K for ±10%. Designates capacitance tolerance.

(2) To complete KEMET part number, insert T = 100% Matte Tin (Sn) Plated, G = Gold Plated, H = Standard Solder coated (SnPb 5% Pb minimum). Designates termination finish.

Refer to Ordering Information for additional detail.

Higher voltage ratings and tighter tolerance product including ESR may be substituted within the same size at KEMET's option. Voltage substitution will be marked with the higher voltage rating. Substitutions can include better than series.

Table 1 – Ratings & Part Number Reference cont'd

| Rated Voltage | Rated Cap | Case Code/ Case Size | KEMET Part Number | DC Leakage | DF | ESR | Maximum Allowable Ripple Current | | | Moisture Sensitivity |
|---------------|-----------|-------------------------|------------------------------|--------------------------|-------------------------|--------------------------|----------------------------------|-----------------------|------------------------|------------------------|
| VDC | μF | KEMET/EIA | (See below for part options) | μAmps +20°C Max/5 Min | % @ +20°C 120 Hz Max | mΩ @ 20°C 100 kHz Max | (mA) 100 kHz 25°C | (mA) 100 kHz +85°C | (mA) 100 kHz +125°C | Reflow Temp ≤ 260°C |
| 6.3 | 150 | D/7343-31 | T495D157(1)006A(2)E050 | 9.5 | 6.0 | 50 | 1732 | 1559 | 693 | 1 |
| 6.3 | 150 | D/7343-31 | T495D157(1)006A(2)E125 | 9.5 | 6.0 | 125 | 1095 | 986 | 438 | 1 |
| 6.3 | 150 | X/7343-43 | T495X157(1)006A(2)E100 | 9.5 | 6.0 | 100 | 1285 | 1157 | 514 | 1 |
| 6.3 | 150 | X/7343-43 | T495X157(1)006A(2)4095 | 9.5 | 6.0 | 125 | 1149 | 1034 | 460 | 1 |
| 6.3 | 220 | C/6032-28 | T495C227(1)006(2)E225 | 13.9 | 10.0 | 25 | 2098 | 1888 | 839 | 1 |
| 6.3 | 220 | D/7343-31 | T495D227(1)006A(2)E045 | 13.9 | 8.0 | 45 | 1826 | 1643 | 730 | 1 |
| 6.3 | 220 | D/7343-31 | T495D227(1)006A(2)E100 | 13.9 | 8.0 | 100 | 1225 | 1103 | 490 | 1 |
| 6.3 | 220 | D/7343-31 | T495D227(1)006A(2)4095 | 13.9 | 8.0 | 100 | 1225 | 1103 | 490 | 1 |
| 6.3 | 220 | X/7343-43 | T495X227(1)006A(2)E070 | 13.9 | 8.0 | 70 | 1535 | 1382 | 614 | 1 |
| 6.3 | 220 | X/7343-43 | T495X227(1)006A(2)E100 | 13.9 | 8.0 | 100 | 1285 | 1157 | 514 | 1 |
| 6.3 | 220 | V/7343-20 | T495V227(1)006ATE150 | 13.9 | 8.0 | 150 | 913 | 822 | 365 | 1 |
| 6.3 | 220 | X/7343-43 | T495X227(1)006A(2)4095 | 13.9 | 8.0 | 100 | 1285 | 1157 | 514 | 1 |
| 6.3 | 330 | D/7343-31 | T495D337(1)006A(2)E040 | 20.8 | 8.0 | 40 | 1936 | 1742 | 774 | 1 |
| 6.3 | 330 | D/7343-31 | T495D337(1)006A(2)E050 | 20.8 | 8.0 | 50 | 1732 | 1559 | 693 | 1 |
| 6.3 | 330 | D/7343-31 | T495D337(1)006A(2)E070 | 20.8 | 8.0 | 70 | 1464 | 1318 | 586 | 1 |
| 6.3 | 330 | D/7343-31 | T495D337(1)006A(2)E100 | 20.8 | 8.0 | 100 | 1225 | 1103 | 490 | 1 |
| 6.3 | 330 | X/7343-43 | T495X337(1)006A(2)E065 | 20.8 | 8.0 | 65 | 1593 | 1434 | 637 | 1 |
| 6.3 | 330 | X/7343-43 | T495X337(1)006A(2)E045 | 20.8 | 8.0 | 45 | 1915 | 1724 | 766 | 1 |
| 6.3 | 330 | X/7343-43 | T495X337(1)006A(2)E100 | 20.8 | 8.0 | 100 | 1285 | 1157 | 514 | 1 |
| 6.3 | 330 | E/7360-38 | T495E337(1)006A(2)E060 | 20.8 | 8.0 | 60 | 1826 | 1643 | 730 | 1 |
| 6.3 | 330 | E/7360-38 | T495E337(1)006A(2)E100 | 20.8 | 8.0 | 100 | 1414 | 1273 | 566 | 1 |
| 6.3 | 470 | D/7343-31 | T495D477(M)006A(2)E045 | 29.6 | 12.0 | 45 | 1826 | 1643 | 730 | 1 |
| 6.3 | 470 | D/7343-31 | T495D477(1)006A(2)E100 | 29.6 | 12.0 | 100 | 1225 | 1103 | 490 | 1 |
| 6.3 | 470 | D/7343-31 | T495D477(1)006A(2)E125 | 29.6 | 12.0 | 125 | 1095 | 986 | 438 | 1 |
| 6.3 | 470 | X/7343-43 | T495X477(1)006A(2)E030 | 29.6 | 10.0 | 30 | 2345 | 2111 | 938 | 1 |
| 6.3 | 470 | X/7343-43 | T495X477(1)006A(2)E045 | 29.6 | 10.0 | 45 | 1915 | 1724 | 766 | 1 |
| 6.3 | 470 | X/7343-43 | T495X477(1)006A(2)E050 | 29.6 | 10.0 | 50 | 1817 | 1635 | 727 | 1 |
| 6.3 | 470 | X/7343-43 | T495X477(1)006A(2)E065 | 29.6 | 10.0 | 65 | 1593 | 1434 | 637 | 1 |
| 6.3 | 470 | E/7360-38 | T495E477(1)006A(2)E040 | 29.6 | 12.0 | 40 | 2236 | 2012 | 894 | 1 |
| 6.3 | 470 | E/7360-38 | T495E477(1)006A(2)E055 | 29.6 | 10.0 | 55 | 1907 | 1716 | 763 | 1 |
| 6.3 | 470 | E/7360-38 | T495E477(1)006A(2)E100 | 29.6 | 10.0 | 100 | 1414 | 1273 | 566 | 1 |
| 6.3 | 1000 | E/7360-38 | T495E108(1)006A(2)E050 | 63.0 | 15.0 | 50 | 2000 | 1800 | 800 | 1 |
| 10 | 2.2 | A/3216-18 | T495A225(1)010A(2)E1K8 | 0.5 | 6.0 | 1800 | 204 | 184 | 82 | 1 |
| 10 | 4.7 | A/3216-18 | T495A475(1)010A(2)E1K2 | 0.5 | 6.0 | 1200 | 250 | 225 | 100 | 1 |
| 10 | 4.7 | A/3216-18 | T495A475(1)010A(2)E1K3 | 0.5 | 6.0 | 1300 | 240 | 216 | 96 | 1 |
| 10 | 4.7 | A/3216-18 | T495A475(1)010A(2)E1K8 | 0.5 | 6.0 | 1800 | 204 | 184 | 82 | 1 |
| 10 | 4.7 | B/3528-21 | T495B475(1)010A(2)E1K3 | 0.5 | 15.0 | 1300 | 256 | 230 | 102 | 1 |
| 10 | 6.8 | A/3216-18 | T495A685(1)010A(2)E1K8 | 0.7 | 6.0 | 1800 | 204 | 184 | 82 | 1 |
| 10 | 6.8 | B/3528-21 | T495B685(1)010A(2)E900 | 0.7 | 6.0 | 900 | 307 | 276 | 123 | 1 |
| 10 | 10 | A/3216-18 | T495A106(1)010A(2)E1K8 | 1.0 | 6.0 | 1800 | 204 | 184 | 82 | 1 |
| 10 | 10 | A/3216-18 | T495A106(1)010A(2)E2K0 | 1.0 | 6.0 | 2000 | 194 | 175 | 78 | 1 |
| 10 | 10 | B/3528-21 | T495B106(1)010AT E1K2 | 1.0 | 6.0 | 1200 | 266 | 239 | 106 | 1 |
| 10 | 10 | B/3528-21 | T495B106(1)010A(2)E750 | 1.0 | 6.0 | 750 | 337 | 303 | 135 | 1 |
| 10 | 10 | B/3528-21 | T495B106(1)010AT E600 | 1.0 | 6.0 | 600 | 376 | 338 | 150 | 1 |
| 10 | 10 | C/6032-28 | T495C106(1)010AT E400 | 1.0 | 6.0 | 400 | 524 | 472 | 210 | 1 |
| 10 | 10 | T/3528-12 | T495T106(1)010AT E1K5 | 1.0 | 6.0 | 1500 | 216 | 194 | 86 | 1 |
| 10 | 15 | A/3216-18 | T495A156(1)010AT E1K0 | 1.5 | 6.0 | 1000 | 274 | 247 | 110 | 1 |
| 10 | 15 | A/3216-18 | T495A156(1)010AT E1K8 | 1.5 | 6.0 | 1800 | 204 | 184 | 82 | 1 |
| 10 | 15 | B/3528-21 | T495B156(1)010AT E600 | 1.5 | 6.0 | 600 | 376 | 338 | 150 | 1 |
| 10 | 15 | B/3528-21 | T495B156(1)010AT E900 | 1.5 | 6.0 | 900 | 307 | 276 | 123 | 1 |
| 10 | 15 | T/3528-12 | T495T156(1)010AT E1K2 | 1.5 | 6.0 | 1200 | 242 | 218 | 97 | 1 |
| VDC | μF | KEMET/EIA | (See below for part options) | μAmps +20°C Max/5 Min | % @ +20°C 120 Hz Max | mΩ @ 20°C 100 kHz Max | (mA) 100 kHz 25°C | (mA) 100 kHz +85°C | (mA) 100 kHz +125°C | Reflow Temp ≤ 260°C |
| Rated Voltage | Rated Cap | Case Code/ Case Size | KEMET Part Number | DC Leakage | DF | ESR | Maximum Allowable Ripple Current | | | Moisture Sensitivity |

(1) To complete KEMET part number, insert M for ±20% or K for ±10%. Designates capacitance tolerance.

(2) To complete KEMET part number, insert T = 100% Matte Tin (Sn) Plated, G = Gold Plated, H = Standard Solder coated (SnPb 5% Pb minimum). Designates termination finish.

Refer to Ordering Information for additional detail.

Higher voltage ratings and tighter tolerance product including ESR may be substituted within the same size at KEMET's option. Voltage substitution will be marked with the higher voltage rating. Substitutions can include better than series.

Table 1 – Ratings & Part Number Reference cont'd

| Rated Voltage | Rated Cap | Case Code/ Case Size | KEMET Part Number | DC Leakage | DF | ESR | Maximum Allowable Ripple Current | | | Moisture Sensitivity |
|---------------|-----------|-------------------------|------------------------------|--------------------------|-------------------------|--------------------------|----------------------------------|-----------------------|------------------------|------------------------|
| VDC | µF | KEMET/EIA | (See below for part options) | µAmps +20°C Max/5 Min | % @ +20°C 120 Hz Max | mΩ @ 20°C 100 kHz Max | (mA) 100 kHz 25°C | (mA) 100 kHz +85°C | (mA) 100 kHz +125°C | Reflow Temp ≤ 260°C |
| 10 | 15 | B/3528-21 | T495B156(1)010A(2)E500 | 1.5 | 6.0 | 500 | 412 | 371 | 165 | 1 |
| 10 | 15 | C/6032-28 | T495C156(1)010A(2)E375 | 1.5 | 6.0 | 375 | 542 | 488 | 217 | 1 |
| 10 | 15 | C/6032-28 | T495C156(1)010A(2)E400 | 1.5 | 6.0 | 400 | 524 | 472 | 210 | 1 |
| 10 | 15 | C/6032-28 | T495C156(1)010A(2)E475 | 1.5 | 6.0 | 475 | 481 | 433 | 192 | 1 |
| 10 | 22 | A/3216-18 | T495A226(1)010AT E1K2 | 2.2 | 8.0 | 1200 | 250 | 225 | 100 | 1 |
| 10 | 22 | A/3216-18 | T495A226(1)010AT E1K5 | 2.2 | 8.0 | 1500 | 224 | 202 | 90 | 1 |
| 10 | 22 | B/3528-21 | T495B226(1)010AT E400 | 2.2 | 6.0 | 400 | 461 | 415 | 184 | 1 |
| 10 | 22 | B/3528-21 | T495B226(1)010AT E500 | 2.2 | 6.0 | 500 | 412 | 371 | 165 | 1 |
| 10 | 22 | B/3528-21 | T495B226(1)010AT E700 | 2.2 | 6.0 | 700 | 348 | 313 | 139 | 1 |
| 10 | 22 | B/3528-21 | T495B226(1)010AT E800 | 2.2 | 6.0 | 800 | 326 | 293 | 130 | 1 |
| 10 | 22 | C/6032-28 | T495C226(1)010A(2)E200 | 2.2 | 6.0 | 200 | 742 | 668 | 297 | 1 |
| 10 | 22 | C/6032-28 | T495C226(1)010A(2)E245 | 2.2 | 6.0 | 245 | 670 | 603 | 268 | 1 |
| 10 | 22 | C/6032-28 | T495C226(1)010A(2)E290 | 2.2 | 6.0 | 290 | 616 | 554 | 246 | 1 |
| 10 | 22 | C/6032-28 | T495C226(1)010A(2)E345 | 2.2 | 6.0 | 345 | 565 | 509 | 226 | 1 |
| 10 | 33 | B/3528-21 | T495B336(1)010A(2)E450 | 3.3 | 6.0 | 450 | 435 | 392 | 174 | 1 |
| 10 | 33 | V/7343-20 | T495V336(1)010A(2)E100 | 3.3 | 6.0 | 100 | 1118 | 1006 | 447 | 1 |
| 10 | 33 | V/7343-20 | T495V336(1)010A(2)E150 | 3.3 | 6.0 | 150 | 913 | 822 | 365 | 1 |
| 10 | 47 | B/3528-21 | T495B476(1)010A(2)E500 | 4.7 | 6.0 | 500 | 412 | 371 | 165 | 1 |
| 10 | 47 | D/7343-31 | T495D476(1)010A(2)E080 | 4.7 | 4.0 | 80 | 1369 | 1232 | 548 | 1 |
| 10 | 47 | D/7343-31 | T495D476(1)010A(2)E090 | 4.7 | 6.0 | 90 | 1291 | 1162 | 516 | 1 |
| 10 | 47 | D/7343-31 | T495D476(1)010A(2)E200 | 4.7 | 4.0 | 200 | 866 | 779 | 346 | 1 |
| 10 | 47 | D/7343-31 | T495D476(1)010A(2)4095 | 4.7 | 4.0 | 200 | 866 | 779 | 346 | 1 |
| 10 | 68 | B/3528-21 | T495B686(1)010A(2)E600 | 6.8 | 10.0 | 600 | 376 | 338 | 150 | 1 |
| 10 | 68 | B/3528-21 | T495B686(1)010A(2)E750 | 6.8 | 10.0 | 750 | 337 | 303 | 135 | 1 |
| 10 | 68 | B/3528-21 | T495B686(M)010A(2)E900 | 6.8 | 10.0 | 900 | 307 | 276 | 123 | 1 |
| 10 | 68 | C/6032-28 | T495C686(1)010A(2)E080 | 6.8 | 6.0 | 80 | 1173 | 1056 | 469 | 1 |
| 10 | 68 | C/6032-28 | T495C686(1)010A(2)E225 | 6.8 | 6.0 | 225 | 699 | 629 | 280 | 1 |
| 10 | 68 | V/7343-20 | T495V686(1)010A(2)E070 | 6.8 | 6.0 | 70 | 1336 | 1202 | 534 | 1 |
| 10 | 68 | V/7343-20 | T495V686(1)010A(2)E100 | 6.8 | 6.0 | 100 | 1118 | 1006 | 447 | 1 |
| 10 | 68 | V/7343-20 | T495V686(1)010A(2)E140 | 6.8 | 6.0 | 140 | 945 | 851 | 378 | 1 |
| 10 | 68 | D/7343-31 | T495D686(1)010A(2)E070 | 6.8 | 6.0 | 70 | 1464 | 1318 | 586 | 1 |
| 10 | 68 | D/7343-31 | T495D686(1)010A(2)E090 | 6.8 | 6.0 | 90 | 1291 | 1162 | 516 | 1 |
| 10 | 68 | D/7343-31 | T495D686(1)010A(2)E150 | 6.8 | 6.0 | 150 | 1000 | 900 | 400 | 1 |
| 10 | 68 | X/7343-43 | T495X686(1)010A(2)E150 | 6.8 | 4.0 | 150 | 1049 | 944 | 420 | 1 |
| 10 | 68 | X/7343-43 | T495X686(1)010A(2)4095 | 6.8 | 4.0 | 150 | 1049 | 944 | 420 | 1 |
| 10 | 100 | B/3528-21 | T495B107(M)010A(2)E500 | 10.0 | 30.0 | 500 | 412 | 371 | 165 | 1 |
| 10 | 100 | V/7343-20 | T495V107(1)010A(2)E100 | 10.0 | 8.0 | 100 | 1118 | 1006 | 447 | 1 |
| 10 | 100 | V/7343-20 | T495V107(1)010A(2)E150 | 10.0 | 8.0 | 150 | 913 | 822 | 365 | 1 |
| 10 | 100 | D/7343-31 | T495D107(1)010A(2)E050 | 10.0 | 8.0 | 50 | 1732 | 1559 | 693 | 1 |
| 10 | 100 | D/7343-31 | T495D107(1)010A(2)E065 | 10.0 | 8.0 | 65 | 1519 | 1367 | 608 | 1 |
| 10 | 100 | D/7343-31 | T495D107(1)010A(2)E080 | 10.0 | 8.0 | 80 | 1369 | 1232 | 548 | 1 |
| 10 | 100 | D/7343-31 | T495D107(1)010A(2)E100 | 10.0 | 8.0 | 100 | 1225 | 1103 | 490 | 1 |
| 10 | 100 | D/7343-31 | T495D107(1)010A(2)4095 | 10.0 | 8.0 | 100 | 1225 | 1103 | 490 | 1 |
| 10 | 100 | X/7343-43 | T495X107(1)010A(2)E100 | 10.0 | 6.0 | 100 | 1285 | 1157 | 514 | 1 |
| 10 | 100 | X/7343-43 | T495X107(1)010A(2)4095 | 10.0 | 6.0 | 100 | 1285 | 1157 | 514 | 1 |
| 10 | 150 | V/7343-20 | T495V157(1)010A(2)E100 | 15.0 | 8.0 | 100 | 1118 | 1006 | 447 | 1 |
| 10 | 150 | V/7343-20 | T495V157(M)010A(2)E150 | 15.0 | 8.0 | 150 | 913 | 822 | 365 | 1 |
| 10 | 150 | D/7343-31 | T495D157(1)010A(2)E050 | 15.0 | 8.0 | 50 | 1732 | 1559 | 693 | 1 |
| 10 | 150 | D/7343-31 | T495D157(1)010A(2)E060 | 15.0 | 8.0 | 60 | 1581 | 1423 | 632 | 1 |
| 10 | 150 | D/7343-31 | T495D157(1)010A(2)E080 | 15.0 | 8.0 | 80 | 1369 | 1232 | 548 | 1 |
| 10 | 150 | D/7343-31 | T495D157(1)010A(2)E100 | 15.0 | 8.0 | 100 | 1225 | 1103 | 490 | 1 |
| 10 | 150 | D/7343-31 | T495D157(1)010A(2)4095 | 15.0 | 8.0 | 100 | 1225 | 1103 | 490 | 1 |
| VDC | µF | KEMET/EIA | (See below for part options) | µAmps +20°C Max/5 Min | % @ +20°C 120 Hz Max | mΩ @ 20°C 100 kHz Max | (mA) 100 kHz 25°C | (mA) 100 kHz +85°C | (mA) 100 kHz +125°C | Reflow Temp ≤ 260°C |
| Rated Voltage | Rated Cap | Case Code/ Case Size | KEMET Part Number | DC Leakage | DF | ESR | Maximum Allowable Ripple Current | | | Moisture Sensitivity |

(1) To complete KEMET part number, insert M for ±20% or K for ±10%. Designates capacitance tolerance.

(2) To complete KEMET part number, insert T = 100% Matte Tin (Sn) Plated, G = Gold Plated, H = Standard Solder coated (SnPb 5% Pb minimum). Designates termination finish.

Refer to Ordering Information for additional detail.

Higher voltage ratings and tighter tolerance product including ESR may be substituted within the same size at KEMET's option. Voltage substitution will be marked with the higher voltage rating. Substitutions can include better than series.

Table 1 – Ratings & Part Number Reference cont'd

| Rated Voltage | Rated Cap | Case Code/ Case Size | KEMET Part Number | DC Leakage | DF | ESR | Maximum Allowable Ripple Current | | | Moisture Sensitivity |
|---------------|-----------|-------------------------|------------------------------|--------------------------|-------------------------|--------------------------|----------------------------------|-----------------------|------------------------|------------------------|
| VDC | µF | KEMET/EIA | (See below for part options) | µAmps +20°C Max/5 Min | % @ +20°C 120 Hz Max | mΩ @ 20°C 100 kHz Max | (mA) 100 kHz 25°C | (mA) 100 kHz +85°C | (mA) 100 kHz +125°C | Reflow Temp ≤ 260°C |
| 10 | 150 | X/7343-43 | T495X157(1)010A(2)E070 | 15.0 | 8.0 | 70 | 1535 | 1382 | 614 | 1 |
| 10 | 150 | X/7343-43 | T495X157(1)010A(2)E080 | 15.0 | 8.0 | 80 | 1436 | 1292 | 574 | 1 |
| 10 | 150 | X/7343-43 | T495X157(1)010A(2)E085 | 15.0 | 8.0 | 85 | 1393 | 1254 | 557 | 1 |
| 10 | 150 | X/7343-43 | T495X157(1)010A(2)E100 | 15.0 | 8.0 | 100 | 1285 | 1157 | 514 | 1 |
| 10 | 150 | X/7343-43 | T495X157(1)010A(2)4095 | 15.0 | 8.0 | 100 | 1285 | 1157 | 514 | 1 |
| 10 | 220 | D/7343-31 | T495D227(1)010A(2)E045 | 22.0 | 8.0 | 45 | 1826 | 1643 | 730 | 1 |
| 10 | 220 | D/7343-31 | T495D227(1)010A(2)E075 | 22.0 | 8.0 | 75 | 1414 | 1273 | 566 | 1 |
| 10 | 220 | D/7343-31 | T495D227(1)010A(2)E100 | 22.0 | 8.0 | 100 | 1225 | 1103 | 490 | 1 |
| 10 | 220 | D/7343-31 | T495D227(1)010A(2)E125 | 22.0 | 8.0 | 125 | 1095 | 986 | 438 | 1 |
| 10 | 220 | X/7343-43 | T495X227(1)010A(2)E045 | 22.0 | 8.0 | 45 | 1915 | 1724 | 766 | 1 |
| 10 | 220 | X/7343-43 | T495X227(1)010A(2)E050 | 22.0 | 8.0 | 50 | 1817 | 1635 | 727 | 1 |
| 10 | 220 | X/7343-43 | T495X227(1)010A(2)E060 | 22.0 | 8.0 | 60 | 1658 | 1492 | 663 | 1 |
| 10 | 220 | X/7343-43 | T495X227(1)010A(2)E070 | 22.0 | 8.0 | 70 | 1535 | 1382 | 614 | 1 |
| 10 | 220 | X/7343-43 | T495X227(1)010A(2)E100 | 22.0 | 8.0 | 100 | 1285 | 1157 | 514 | 1 |
| 10 | 220 | X/7343-43 | T495X227(1)010A(2)4095 | 22.0 | 8.0 | 100 | 1285 | 1157 | 514 | 1 |
| 10 | 330 | D/7343-31 | T495D337(1)010A(2)E100 | 33.0 | 8.0 | 100 | 1225 | 1103 | 490 | 1 |
| 10 | 330 | D/7343-31 | T495D337(1)010A(2)E125 | 33.0 | 10.0 | 125 | 1095 | 986 | 438 | 1 |
| 10 | 330 | D/7343-31 | T495D337(1)010A(2)E150 | 33.0 | 10.0 | 150 | 1000 | 900 | 400 | 1 |
| 10 | 330 | X/7343-43 | T495X337(1)010A(2)E035 | 33.0 | 10.0 | 35 | 2171 | 1954 | 868 | 1 |
| 10 | 330 | X/7343-43 | T495X337(1)010A(2)E050 | 33.0 | 10.0 | 50 | 1817 | 1635 | 727 | 1 |
| 10 | 330 | X/7343-43 | T495X337(1)010A(2)E060 | 33.0 | 10.0 | 60 | 1658 | 1492 | 663 | 1 |
| 10 | 330 | X/7343-43 | T495X337(1)010A(2)E100 | 33.0 | 10.0 | 100 | 1285 | 1157 | 514 | 1 |
| 10 | 330 | E/7360-38 | T495E337(1)010A(2)E040 | 33.0 | 8.0 | 40 | 2236 | 2012 | 894 | 1 |
| 10 | 330 | E/7360-38 | T495E337(1)010A(2)E060 | 33.0 | 10.0 | 60 | 1826 | 1643 | 730 | 1 |
| 10 | 330 | E/7360-38 | T495E337(1)010A(2)E100 | 33.0 | 10.0 | 100 | 1414 | 1273 | 566 | 1 |
| 10 | 470 | X/7343-43 | T495X477(1)010A(2)E045 | 47.0 | 10.0 | 45 | 1915 | 1724 | 766 | 1 |
| 10 | 470 | X/7343-43 | T495X477(1)010A(2)E050 | 47.0 | 10.0 | 50 | 1817 | 1635 | 727 | 1 |
| 10 | 470 | X/7343-43 | T495X477(M)010A(2)E060 | 47.0 | 10.0 | 60 | 1658 | 1492 | 663 | 1 |
| 10 | 470 | X/7343-43 | T495X477(M)010A(2)E100 | 47.0 | 10.0 | 100 | 1285 | 1157 | 514 | 1 |
| 10 | 470 | X/7343-43 | T495X477(M)010A(2)E200 | 47.0 | 10.0 | 200 | 908 | 817 | 363 | 1 |
| 10 | 470 | E/7360-38 | T495E477(1)010A(2)E040 | 47.0 | 10.0 | 40 | 2236 | 2012 | 894 | 1 |
| 10 | 470 | E/7360-38 | T495E477(1)010A(2)E060 | 47.0 | 10.0 | 60 | 1826 | 1643 | 730 | 1 |
| 10 | 470 | E/7360-38 | T495E477(1)010A(2)E100 | 47.0 | 10.0 | 100 | 1414 | 1273 | 566 | 1 |
| 16 | 3.3 | A/3216-18 | T495A335(1)016A(2)E3K0 | 0.5 | 6.0 | 3000 | 158 | 142 | 63 | 1 |
| 16 | 4.7 | A/3216-18 | T495A475(1)016A(2)E2K0 | 0.8 | 6.0 | 2000 | 194 | 175 | 78 | 1 |
| 16 | 4.7 | B/3528-21 | T495B475(1)016A(2)E700 | 0.8 | 6.0 | 700 | 348 | 313 | 139 | 1 |
| 16 | 6.8 | C/6032-28 | T495C685(1)016A(2)E750 | 1.1 | 6.0 | 750 | 383 | 345 | 153 | 1 |
| 16 | 10 | B/3528-21 | T495B106(1)016A(2)E800 | 1.6 | 6.0 | 800 | 326 | 293 | 130 | 1 |
| 16 | 10 | T/3528-12 | T495T106(M)016A(2)E4K0 | 1.6 | 8.0 | 4000 | 132 | 119 | 53 | 1 |
| 16 | 15 | A/3216-18 | T495A156(1)016A(2)E2K5 | 2.4 | 8.0 | 2500 | 173 | 156 | 69 | 1 |
| 16 | 15 | B/3528-21 | T495B156(1)016A(2)E800 | 2.4 | 6.0 | 800 | 326 | 293 | 130 | 1 |
| 16 | 33 | C/6032-28 | T495C336(1)016A(2)E200 | 5.3 | 6.0 | 200 | 742 | 668 | 297 | 1 |
| 16 | 33 | C/6032-28 | T495C336(1)016A(2)E225 | 5.3 | 6.0 | 225 | 699 | 629 | 280 | 1 |
| 16 | 33 | C/6032-28 | T495C336(1)016A(2)E275 | 5.3 | 6.0 | 275 | 632 | 569 | 253 | 1 |
| 16 | 33 | D/7343-31 | T495D336(1)016A(2)E150 | 5.3 | 6.0 | 150 | 1000 | 900 | 400 | 1 |
| 16 | 33 | D/7343-31 | T495D336(1)016A(2)E175 | 5.3 | 6.0 | 175 | 926 | 833 | 370 | 1 |
| 16 | 33 | D/7343-31 | T495D336(1)016A(2)E225 | 5.3 | 4.0 | 225 | 816 | 734 | 326 | 1 |
| 16 | 33 | D/7343-31 | T495D336(1)016A(2)4095 | 5.3 | 4.0 | 250 | 775 | 698 | 310 | 1 |
| 16 | 47 | C/6032-28 | T495C476(1)016A(2)E350 | 7.5 | 6.0 | 350 | 561 | 505 | 224 | 1 |
| 16 | 47 | D/7343-31 | T495D476(1)016A(2)E080 | 7.5 | 6.0 | 80 | 1369 | 1232 | 548 | 1 |
| 16 | 47 | D/7343-31 | T495D476(1)016A(2)E100 | 7.5 | 6.0 | 100 | 1225 | 1103 | 490 | 1 |
| VDC | µF | KEMET/EIA | (See below for part options) | µAmps +20°C Max/5 Min | % @ +20°C 120 Hz Max | mΩ @ 20°C 100 kHz Max | (mA) 100 kHz 25°C | (mA) 100 kHz +85°C | (mA) 100 kHz +125°C | Reflow Temp ≤ 260°C |
| Rated Voltage | Rated Cap | Case Code/ Case Size | KEMET Part Number | DC Leakage | DF | ESR | Maximum Allowable Ripple Current | | | Moisture Sensitivity |

(1) To complete KEMET part number, insert M for ±20% or K for ±10%. Designates capacitance tolerance.

(2) To complete KEMET part number, insert T = 100% Matte Tin (Sn) Plated, G = Gold Plated, H = Standard Solder coated (SnPb 5% Pb minimum). Designates termination finish.

Refer to Ordering Information for additional detail.

Higher voltage ratings and tighter tolerance product including ESR may be substituted within the same size at KEMET's option. Voltage substitution will be marked with the higher voltage rating. Substitutions can include better than series.

Table 1 – Ratings & Part Number Reference cont'd

| Rated Voltage | Rated Cap | Case Code/ Case Size | KEMET Part Number | DC Leakage | DF | ESR | Maximum Allowable Ripple Current | | | Moisture Sensitivity |
|---------------|-----------|-------------------------|------------------------------|--------------------------|-------------------------|--------------------------|----------------------------------|-----------------------|------------------------|------------------------|
| VDC | μF | KEMET/EIA | (See below for part options) | μAmps +20°C Max/5 Min | % @ +20°C 120 Hz Max | mΩ @ 20°C 100 kHz Max | (mA) 100 kHz 25°C | (mA) 100 kHz +85°C | (mA) 100 kHz +125°C | Reflow Temp ≤ 260°C |
| 16 | 47 | D/7343-31 | T495D476(1)016A(2)E150 | 7.5 | 6.0 | 150 | 1000 | 900 | 400 | 1 |
| 16 | 47 | D/7343-31 | T495D476(1)016A(2)4095 | 7.5 | 6.0 | 200 | 866 | 779 | 346 | 1 |
| 16 | 68 | V/7343-20 | T495V686(1)016A(2)E180 | 10.9 | 6.0 | 180 | 833 | 750 | 333 | 1 |
| 16 | 68 | V/7343-20 | T495V686(1)016A(2)E300 | 10.9 | 6.0 | 300 | 645 | 581 | 258 | 1 |
| 16 | 68 | D/7343-31 | T495D686(1)016A(2)E070 | 10.9 | 6.0 | 70 | 1464 | 1318 | 586 | 1 |
| 16 | 68 | D/7343-31 | T495D686(1)016A(2)E100 | 10.9 | 6.0 | 100 | 1225 | 1103 | 490 | 1 |
| 16 | 68 | D/7343-31 | T495D686(1)016A(2)E150 | 10.9 | 6.0 | 150 | 1000 | 900 | 400 | 1 |
| 16 | 100 | D/7343-31 | T495D107(1)016A(2)E100 | 16.0 | 8.0 | 100 | 1225 | 1103 | 490 | 1 |
| 16 | 100 | D/7343-31 | T495D107(1)016A(2)E125 | 16.0 | 8.0 | 125 | 1095 | 986 | 438 | 1 |
| 16 | 100 | X/7343-43 | T495X107(1)016A(2)E080 | 16.0 | 8.0 | 80 | 1436 | 1292 | 574 | 1 |
| 16 | 100 | X/7343-43 | T495X107(1)016A(2)E100 | 16.0 | 8.0 | 100 | 1285 | 1157 | 514 | 1 |
| 16 | 100 | X/7343-43 | T495X107(1)016A(2)4095 | 16.0 | 8.0 | 125 | 1149 | 1034 | 460 | 1 |
| 16 | 150 | D/7343-31 | T495D157(M)016A(2)E060 | 24.0 | 12.0 | 60 | 1581 | 1423 | 632 | 1 |
| 16 | 150 | D/7343-31 | T495D157(M)016A(2)E085 | 24.0 | 8.0 | 85 | 1328 | 1195 | 531 | 1 |
| 16 | 150 | D/7343-31 | T495D157(M)016A(2)E100 | 24.0 | 8.0 | 100 | 1225 | 1103 | 490 | 1 |
| 16 | 150 | D/7343-31 | T495D157(1)016A(2)E125 | 24.0 | 8.0 | 125 | 1095 | 986 | 438 | 1 |
| 16 | 150 | D/7343-31 | T495D157(1)016A(2)E150 | 24.0 | 8.0 | 150 | 1000 | 900 | 400 | 1 |
| 16 | 150 | X/7343-43 | T495X157(1)016A(2)E075 | 24.0 | 8.0 | 75 | 1483 | 1335 | 593 | 1 |
| 16 | 150 | X/7343-43 | T495X157(1)016A(2)E100 | 24.0 | 8.0 | 100 | 1285 | 1157 | 514 | 1 |
| 16 | 220 | X/7343-43 | T495X227(1)016A(2)E100 | 35.2 | 8.0 | 100 | 1285 | 1157 | 514 | 1 |
| 16 | 220 | E/7360-38 | T495E227(1)016A(2)E050 | 35.2 | 12.0 | 50 | 2000 | 1800 | 800 | 1 |
| 16 | 220 | E/7360-38 | T495E227(1)016A(2)E075 | 35.2 | 8.0 | 75 | 1633 | 1470 | 653 | 1 |
| 16 | 220 | E/7360-38 | T495E227(1)016A(2)E100 | 35.2 | 7.2 | 100 | 1414 | 1273 | 566 | 1 |
| 16 | 220 | E/7360-38 | T495E227(1)016A(2)E150 | 35.2 | 7.2 | 150 | 1155 | 1040 | 462 | 1 |
| 20 | 1 | A/3216-18 | T495A105(1)020A(2)E3K0 | 0.5 | 4.0 | 3000 | 158 | 142 | 63 | 1 |
| 20 | 10 | B/3528-21 | T495B106(1)020A(2)E1K0 | 2.0 | 6.0 | 1000 | 292 | 263 | 117 | 1 |
| 20 | 10 | B/3528-21 | T495B106(1)020A(2)E800 | 2.0 | 6.0 | 800 | 326 | 293 | 130 | 1 |
| 20 | 10 | C/6032-28 | T495C106(1)020A(2)E300 | 2.0 | 6.0 | 300 | 606 | 545 | 242 | 1 |
| 20 | 10 | C/6032-28 | T495C106(1)020A(2)E350 | 2.0 | 6.0 | 350 | 561 | 505 | 224 | 1 |
| 20 | 10 | C/6032-28 | T495C106(1)020A(2)E400 | 2.0 | 6.0 | 400 | 524 | 472 | 210 | 1 |
| 20 | 10 | C/6032-28 | T495C106(1)020A(2)E475 | 2.0 | 6.0 | 475 | 481 | 433 | 192 | 1 |
| 20 | 15 | C/6032-28 | T495C156(1)020A(2)E375 | 3.0 | 6.0 | 375 | 542 | 488 | 217 | 1 |
| 20 | 15 | D/7343-31 | T495D156(1)020A(2)E275 | 3.0 | 4.0 | 275 | 739 | 665 | 296 | 1 |
| 20 | 15 | D/7343-31 | T495D156(1)020A(2)4095 | 3.0 | 4.0 | 275 | 739 | 665 | 296 | 1 |
| 20 | 22 | D/7343-31 | T495D226(1)020A(2)E180 | 4.4 | 4.0 | 180 | 913 | 822 | 365 | 1 |
| 20 | 22 | D/7343-31 | T495D226(1)020A(2)E225 | 4.4 | 4.0 | 225 | 816 | 734 | 326 | 1 |
| 20 | 22 | D/7343-31 | T495D226(1)020A(2)4095 | 4.4 | 4.0 | 275 | 739 | 665 | 296 | 1 |
| 20 | 33 | D/7343-31 | T495D336(1)020A(2)E100 | 6.6 | 6.0 | 100 | 1225 | 1103 | 490 | 1 |
| 20 | 33 | D/7343-31 | T495D336(1)020A(2)E150 | 6.6 | 6.0 | 150 | 1000 | 900 | 400 | 1 |
| 20 | 33 | D/7343-31 | T495D336(1)020A(2)E200 | 6.6 | 6.0 | 200 | 866 | 779 | 346 | 1 |
| 20 | 47 | D/7343-31 | T495D476(1)020A(2)E075 | 9.4 | 6.0 | 75 | 1414 | 1273 | 566 | 1 |
| 20 | 47 | D/7343-31 | T495D476(1)020A(2)E100 | 9.4 | 6.0 | 100 | 1225 | 1103 | 490 | 1 |
| 20 | 47 | D/7343-31 | T495D476(1)020A(2)E175 | 9.4 | 6.0 | 175 | 926 | 833 | 370 | 1 |
| 20 | 47 | X/7343-43 | T495X476(1)020A(2)E065 | 9.4 | 8.0 | 65 | 1593 | 1434 | 637 | 1 |
| 20 | 47 | X/7343-43 | T495X476(1)020A(2)E100 | 9.4 | 6.0 | 100 | 1285 | 1157 | 514 | 1 |
| 20 | 47 | X/7343-43 | T495X476(1)020A(2)E125 | 9.4 | 6.0 | 125 | 1149 | 1034 | 460 | 1 |
| 20 | 47 | X/7343-43 | T495X476(1)020A(2)E150 | 9.4 | 4.0 | 150 | 1049 | 944 | 420 | 1 |
| 20 | 47 | X/7343-43 | T495X476(1)020A(2)4095 | 9.4 | 4.0 | 150 | 1049 | 944 | 420 | 1 |
| 20 | 68 | D/7343-31 | T495D686(1)020A(2)E070 | 13.6 | 8.0 | 70 | 1464 | 1318 | 586 | 1 |
| 20 | 68 | D/7343-31 | T495D686(1)020A(2)E150 | 13.6 | 8.0 | 150 | 1000 | 900 | 400 | 1 |
| 20 | 68 | X/7343-43 | T495X686(1)020A(2)E120 | 13.6 | 6.0 | 120 | 1173 | 1056 | 469 | 1 |
| VDC | μF | KEMET/EIA | (See below for part options) | μAmps +20°C Max/5 Min | % @ +20°C 120 Hz Max | mΩ @ 20°C 100 kHz Max | (mA) 100 kHz 25°C | (mA) 100 kHz +85°C | (mA) 100 kHz +125°C | Reflow Temp ≤ 260°C |
| Rated Voltage | Rated Cap | Case Code/ Case Size | KEMET Part Number | DC Leakage | DF | ESR | Maximum Allowable Ripple Current | | | Moisture Sensitivity |

(1) To complete KEMET part number, insert M for ±20% or K for ±10%. Designates capacitance tolerance.

(2) To complete KEMET part number, insert T = 100% Matte Tin (Sn) Plated, G = Gold Plated, H = Standard Solder coated (SnPb 5% Pb minimum). Designates termination finish.

Refer to Ordering Information for additional detail.

Higher voltage ratings and tighter tolerance product including ESR may be substituted within the same size at KEMET's option. Voltage substitution will be marked with the higher voltage rating. Substitutions can include better than series.

Table 1 – Ratings & Part Number Reference cont'd

| Rated Voltage | Rated Cap | Case Code/ Case Size | KEMET Part Number | DC Leakage | DF | ESR | Maximum Allowable Ripple Current | | | Moisture Sensitivity |
|---------------|-----------|-------------------------|------------------------------|--------------------------|-------------------------|--------------------------|----------------------------------|-----------------------|------------------------|------------------------|
| VDC | µF | KEMET/EIA | (See below for part options) | µAmps +20°C Max/5 Min | % @ +20°C 120 Hz Max | mΩ @ 20°C 100 kHz Max | (mA) 100 kHz 25°C | (mA) 100 kHz +85°C | (mA) 100 kHz +125°C | Reflow Temp ≤ 260°C |
| 20 | 68 | X/7343-43 | T495X686(1)020A(2)E150 | 13.6 | 6.0 | 150 | 1049 | 944 | 420 | 1 |
| 20 | 68 | X/7343-43 | T495X686(1)020A(2)4095 | 13.6 | 6.0 | 150 | 1049 | 944 | 420 | 1 |
| 20 | 100 | X/7343-43 | T495X107(1)020A(2)E100 | 20.0 | 6.0 | 100 | 1285 | 1157 | 514 | 1 |
| 20 | 100 | X/7343-43 | T495X107(1)020A(2)E150 | 20.0 | 8.0 | 150 | 1049 | 944 | 420 | 1 |
| 20 | 100 | E/7360-38 | T495E107(1)020A(2)E060 | 20.0 | 8.0 | 60 | 1826 | 1643 | 730 | 1 |
| 20 | 100 | E/7360-38 | T495E107(1)020A(2)E085 | 20.0 | 8.0 | 85 | 1534 | 1381 | 614 | 1 |
| 20 | 100 | E/7360-38 | T495E107(1)020A(2)E100 | 20.0 | 8.0 | 100 | 1414 | 1273 | 566 | 1 |
| 20 | 100 | E/7360-38 | T495E107(1)020A(2)E200 | 20.0 | 8.0 | 200 | 1000 | 900 | 400 | 1 |
| 20 | 150 | E/7360-38 | T495E157(1)020A(2)E080 | 30.0 | 8.0 | 80 | 1581 | 1423 | 632 | 1 |
| 25 | 0.47 | A/3216-18 | T495A474(1)025A(2)E4K5 | 0.5 | 4.0 | 4500 | 129 | 116 | 52 | 1 |
| 25 | 1 | A/3216-18 | T495A105(1)025A(2)E2K5 | 0.5 | 4.0 | 2500 | 173 | 156 | 69 | 1 |
| 25 | 1 | A/3216-18 | T495A105(1)025A(2)E3K0 | 0.5 | 4.0 | 3000 | 158 | 142 | 63 | 1 |
| 25 | 1 | A/3216-18 | T495A105(1)025A(2)E5K0 | 0.5 | 4.0 | 5000 | 4 | 4 | 2 | 1 |
| 25 | 2.2 | C/6032-28 | T495C225(1)025A(2)E1K3 | 0.6 | 6.0 | 1300 | 291 | 262 | 116 | 1 |
| 25 | 3.3 | C/6032-28 | T495C335(1)025A(2)E750 | 0.8 | 6.0 | 750 | 383 | 345 | 153 | 1 |
| 25 | 4.7 | C/6032-28 | T495C475(1)025A(2)E575 | 1.2 | 6.0 | 575 | 437 | 393 | 175 | 1 |
| 25 | 4.7 | B/3528-21 | T495B475(1)025A(2)E1K0 | 1.2 | 6.0 | 1000 | 292 | 263 | 117 | 1 |
| 25 | 6.8 | B/3528-21 | T495B685(1)025A(2)E1K5 | 1.7 | 6.0 | 1500 | 238 | 214 | 95 | 1 |
| 25 | 6.8 | C/6032-28 | T495C685(1)025A(2)E400 | 1.7 | 6.0 | 400 | 524 | 472 | 210 | 1 |
| 25 | 6.8 | C/6032-28 | T495C685(1)025A(2)E490 | 1.7 | 6.0 | 490 | 474 | 427 | 190 | 1 |
| 25 | 6.8 | C/6032-28 | T495C685(1)025A(2)E500 | 1.7 | 6.0 | 500 | 469 | 422 | 188 | 1 |
| 25 | 10 | C/6032-28 | T495C106(1)025A(2)E275 | 2.5 | 6.0 | 275 | 632 | 569 | 253 | 1 |
| 25 | 10 | C/6032-28 | T495C106(1)025A(2)E300 | 2.5 | 6.0 | 300 | 606 | 545 | 242 | 1 |
| 25 | 10 | C/6032-28 | T495C106(1)025A(2)E450 | 2.5 | 6.0 | 450 | 494 | 445 | 198 | 1 |
| 25 | 15 | D/7343-31 | T495D156(1)025A(2)E100 | 3.8 | 6.0 | 100 | 1225 | 1103 | 490 | 1 |
| 25 | 15 | D/7343-31 | T495D156(1)025A(2)E275 | 3.8 | 6.0 | 275 | 739 | 665 | 296 | 1 |
| 25 | 15 | D/7343-31 | T495D156(1)025A(2)4095 | 3.8 | 6.0 | 275 | 739 | 665 | 296 | 1 |
| 25 | 15 | X/7343-43 | T495X156(1)025A(2)E200 | 3.8 | 4.0 | 200 | 908 | 817 | 363 | 1 |
| 25 | 15 | X/7343-43 | T495X156(1)025A(2)4095 | 3.8 | 4.0 | 200 | 908 | 817 | 363 | 1 |
| 25 | 22 | C/6032-28 | T495C226(1)025A(2)E275 | 5.5 | 6.0 | 275 | 632 | 569 | 253 | 1 |
| 25 | 22 | C/6032-28 | T495C226(1)025A(2)E300 | 5.5 | 8.0 | 300 | 606 | 545 | 242 | 1 |
| 25 | 22 | C/6032-28 | T495C226(1)025A(2)E900 | 5.5 | 6.0 | 900 | 350 | 315 | 140 | 1 |
| 25 | 22 | D/7343-31 | T495D226(1)025A(2)E200 | 5.5 | 6.0 | 200 | 866 | 779 | 346 | 1 |
| 25 | 22 | X/7343-43 | T495X226(1)025A(2)E225 | 5.5 | 4.0 | 225 | 856 | 770 | 342 | 1 |
| 25 | 22 | X/7343-43 | T495X226(1)025A(2)4095 | 5.5 | 4.0 | 225 | 856 | 770 | 342 | 1 |
| 25 | 33 | D/7343-31 | T495D336(1)025A(2)E090 | 8.3 | 6.0 | 90 | 1291 | 1162 | 516 | 1 |
| 25 | 33 | D/7343-31 | T495D336(1)025A(2)E100 | 8.3 | 6.0 | 100 | 1225 | 1103 | 490 | 1 |
| 25 | 33 | D/7343-31 | T495D336(1)025A(2)E225 | 8.3 | 6.0 | 225 | 816 | 734 | 326 | 1 |
| 25 | 33 | D/7343-31 | T495D336(1)025A(2)E300 | 8.3 | 6.0 | 300 | 707 | 636 | 283 | 1 |
| 25 | 33 | X/7343-43 | T495X336(1)025A(2)E100 | 8.3 | 4.0 | 100 | 1285 | 1157 | 514 | 1 |
| 25 | 33 | X/7343-43 | T495X336(1)025A(2)E175 | 8.3 | 4.0 | 175 | 971 | 874 | 388 | 1 |
| 25 | 33 | X/7343-43 | T495X336(1)025A(2)E200 | 8.3 | 4.0 | 200 | 908 | 817 | 363 | 1 |
| 25 | 33 | X/7343-43 | T495X336(1)025A(2)4095 | 8.3 | 4.0 | 175 | 971 | 874 | 388 | 1 |
| 25 | 47 | X/7343-43 | T495X476(M)025A(2)E080 | 11.8 | 8.0 | 80 | 1436 | 1292 | 574 | 1 |
| 25 | 47 | X/7343-43 | T495X476(M)025A(2)E150 | 11.8 | 6.0 | 150 | 1049 | 944 | 420 | 1 |
| 25 | 47 | X/7343-43 | T495X476(M)025A(2)E185 | 11.8 | 8.0 | 185 | 944 | 850 | 378 | 1 |
| 25 | 47 | X/7343-43 | T495X476(M)025A(2)E200 | 11.8 | 6.0 | 200 | 908 | 817 | 363 | 1 |
| 25 | 47 | D/7343-31 | T495D476(M)025A(2)E120 | 11.8 | 10.0 | 120 | 1118 | 1006 | 447 | 1 |
| 25 | 47 | D/7343-31 | T495D476(1)025A(2)E250 | 11.8 | 10.0 | 250 | 775 | 698 | 310 | 1 |
| 25 | 68 | D/7343-31 | T495D686(1)025A(2)E150 | 17.0 | 10.0 | 150 | 1000 | 900 | 400 | 1 |
| 25 | 68 | D/7343-31 | T495D686(1)025A(2)E200 | 17.0 | 10.0 | 200 | 866 | 779 | 346 | 1 |
| VDC | µF | KEMET/EIA | (See below for part options) | µAmps +20°C Max/5 Min | % @ +20°C 120 Hz Max | mΩ @ 20°C 100 kHz Max | (mA) 100 kHz 25°C | (mA) 100 kHz +85°C | (mA) 100 kHz +125°C | Reflow Temp ≤ 260°C |
| Rated Voltage | Rated Cap | Case Code/ Case Size | KEMET Part Number | DC Leakage | DF | ESR | Maximum Allowable Ripple Current | | | Moisture Sensitivity |

(1) To complete KEMET part number, insert M for ±20% or K for ±10%. Designates capacitance tolerance.

(2) To complete KEMET part number, insert T = 100% Matte Tin (Sn) Plated, G = Gold Plated, H = Standard Solder coated (SnPb 5% Pb minimum). Designates termination finish.

Refer to Ordering Information for additional detail.

Higher voltage ratings and tighter tolerance product including ESR may be substituted within the same size at KEMET's option. Voltage substitution will be marked with the higher voltage rating. Substitutions can include better than series.

Table 1 – Ratings & Part Number Reference cont'd

| Rated Voltage | Rated Cap | Case Code/ Case Size | KEMET Part Number | DC Leakage | DF | ESR | Maximum Allowable Ripple Current | | | Moisture Sensitivity |
|---------------|-----------|-------------------------|------------------------------|--------------------------|-------------------------|--------------------------|----------------------------------|-----------------------|------------------------|------------------------|
| VDC | µF | KEMET/EIA | (See below for part options) | µAmps +20°C Max/5 Min | % @ +20°C 120 Hz Max | mΩ @ 20°C 100 kHz Max | (mA) 100 kHz 25°C | (mA) 100 kHz +85°C | (mA) 100 kHz +125°C | Reflow Temp ≤ 260°C |
| 25 | 68 | X/7343-43 | T495X686(1)025A(2)E125 | 17.0 | 8.0 | 125 | 1149 | 1034 | 460 | 1 |
| 25 | 68 | X/7343-43 | T495X686(1)025A(2)E150 | 17.0 | 8.0 | 150 | 1049 | 944 | 420 | 1 |
| 25 | 68 | X/7343-43 | T495X686(1)025A(2)E200 | 17.0 | 8.0 | 200 | 908 | 817 | 363 | 1 |
| 25 | 100 | E/7360-38 | T495E107(1)025A(2)E100 | 25.0 | 8.0 | 100 | 1414 | 1273 | 566 | 1 |
| 35 | 0.47 | B/3528-21 | T495B474(1)035A(2)E1K5 | 0.5 | 4.0 | 1500 | 238 | 214 | 95 | 1 |
| 35 | 0.47 | B/3528-21 | T495B474(1)035A(2)E2K2 | 0.5 | 4.0 | 2200 | 197 | 177 | 79 | 1 |
| 35 | 1 | A/3216-18 | T495A105(1)035A(2)E3K0 | 0.5 | 4.0 | 3000 | 158 | 142 | 63 | 1 |
| 35 | 1 | B/3528-21 | T495B105(1)035A(2)E1K5 | 0.5 | 4.0 | 1500 | 238 | 214 | 95 | 1 |
| 35 | 1 | B/3528-21 | T495B105(1)035A(2)E1K7 | 0.5 | 4.0 | 1700 | 224 | 202 | 90 | 1 |
| 35 | 2.2 | B/3528-21 | T495B225(1)035A(2)E1K5 | 0.8 | 6.0 | 1500 | 238 | 214 | 95 | 1 |
| 35 | 2.2 | C/6032-28 | T495C225(1)035A(2)E750 | 0.8 | 6.0 | 750 | 383 | 345 | 153 | 1 |
| 35 | 3.3 | B/3528-21 | T495B335(1)035A(2)E900 | 1.2 | 6.0 | 900 | 307 | 276 | 123 | 1 |
| 35 | 3.3 | C/6032-28 | T495C335(1)035A(2)E525 | 1.2 | 6.0 | 525 | 458 | 412 | 183 | 1 |
| 35 | 3.3 | C/6032-28 | T495C335(1)035A(2)E550 | 1.2 | 6.0 | 550 | 447 | 402 | 179 | 1 |
| 35 | 3.3 | C/6032-28 | T495C335(1)035A(2)E600 | 1.2 | 6.0 | 600 | 428 | 385 | 171 | 1 |
| 35 | 4.7 | B/3528-21 | T495B475(1)035A(2)E1K0 | 1.6 | 6.0 | 1000 | 292 | 263 | 117 | 1 |
| 35 | 4.7 | C/6032-28 | T495C475(1)035A(2)E450 | 1.6 | 6.0 | 450 | 494 | 445 | 198 | 1 |
| 35 | 4.7 | C/6032-28 | T495C475(1)035A(2)E500 | 1.6 | 6.0 | 500 | 469 | 422 | 188 | 1 |
| 35 | 4.7 | C/6032-28 | T495C475(1)035A(2)E600 | 1.6 | 6.0 | 600 | 428 | 385 | 171 | 1 |
| 35 | 4.7 | C/6032-28 | T495C475(1)035A(2)4095 | 1.6 | 6.0 | 600 | 428 | 385 | 171 | 1 |
| 35 | 6.8 | D/7343-31 | T495D685(1)035A(2)E150 | 2.4 | 6.0 | 150 | 1000 | 900 | 400 | 1 |
| 35 | 6.8 | D/7343-31 | T495D685(1)035A(2)E400 | 2.4 | 6.0 | 400 | 612 | 551 | 245 | 1 |
| 35 | 6.8 | X/7343-43 | T495X685(1)035A(2)E300 | 2.4 | 4.0 | 300 | 742 | 668 | 297 | 1 |
| 35 | 6.8 | X/7343-43 | T495X685(1)035A(2)4095 | 2.4 | 4.0 | 300 | 742 | 668 | 297 | 1 |
| 35 | 10 | D/7343-31 | T495D106(1)035A(2)E125 | 3.5 | 6.0 | 125 | 1095 | 986 | 438 | 1 |
| 35 | 10 | D/7343-31 | T495D106(1)035A(2)E250 | 3.5 | 6.0 | 250 | 775 | 698 | 310 | 1 |
| 35 | 10 | D/7343-31 | T495D106(1)035A(2)E300 | 3.5 | 6.0 | 300 | 707 | 636 | 283 | 1 |
| 35 | 10 | D/7343-31 | T495D106(1)035A(2)4095 | 3.5 | 4.0 | 300 | 707 | 636 | 283 | 1 |
| 35 | 10 | X/7343-43 | T495X106(1)035A(2)E175 | 3.5 | 6.0 | 175 | 971 | 874 | 388 | 1 |
| 35 | 10 | X/7343-43 | T495X106(1)035A(2)E200 | 3.5 | 6.0 | 200 | 908 | 817 | 363 | 1 |
| 35 | 10 | X/7343-43 | T495X106(1)035A(2)E250 | 3.5 | 4.0 | 250 | 812 | 731 | 325 | 1 |
| 35 | 10 | X/7343-43 | T495X106(1)035A(2)4095 | 3.5 | 4.0 | 250 | 812 | 731 | 325 | 1 |
| 35 | 15 | D/7343-31 | T495D156(1)035A(2)E225 | 5.3 | 6.0 | 225 | 816 | 734 | 326 | 1 |
| 35 | 15 | D/7343-31 | T495D156(1)035A(2)E300 | 5.3 | 6.0 | 300 | 707 | 636 | 283 | 1 |
| 35 | 15 | X/7343-43 | T495X156(1)035A(2)E200 | 5.3 | 6.0 | 200 | 908 | 817 | 363 | 1 |
| 35 | 15 | X/7343-43 | T495X156(1)035A(2)E225 | 5.3 | 6.0 | 225 | 856 | 770 | 342 | 1 |
| 35 | 15 | X/7343-43 | T495X156(1)035A(2)4095 | 5.3 | 6.0 | 225 | 856 | 770 | 342 | 1 |
| 35 | 22 | D/7343-31 | T495D226(1)035A(2)E125 | 7.7 | 6.0 | 125 | 1095 | 986 | 438 | 1 |
| 35 | 22 | D/7343-31 | T495D226(1)035A(2)E200 | 7.7 | 6.0 | 200 | 866 | 779 | 346 | 1 |
| 35 | 22 | D/7343-31 | T495D226(1)035A(2)E250 | 7.7 | 6.0 | 250 | 775 | 698 | 310 | 1 |
| 35 | 22 | D/7343-31 | T495D226(1)035A(2)E300 | 7.7 | 6.0 | 300 | 707 | 636 | 283 | 1 |
| 35 | 22 | X/7343-43 | T495X226(1)035A(2)E125 | 7.7 | 6.0 | 125 | 1149 | 1034 | 460 | 1 |
| 35 | 22 | X/7343-43 | T495X226(1)035A(2)E200 | 7.7 | 6.0 | 200 | 908 | 817 | 363 | 1 |
| 35 | 22 | X/7343-43 | T495X226(1)035A(2)E275 | 7.7 | 6.0 | 275 | 775 | 698 | 310 | 1 |
| 35 | 22 | X/7343-43 | T495X226(1)035A(2)4095 | 7.7 | 6.0 | 300 | 742 | 668 | 297 | 1 |
| 35 | 33 | D/7343-31 | T495D336(1)035A(2)E200 | 11.6 | 6.0 | 200 | 866 | 779 | 346 | 1 |
| 35 | 33 | D/7343-31 | T495D336(1)035A(2)E300 | 11.6 | 6.0 | 300 | 707 | 636 | 283 | 1 |
| 35 | 33 | X/7343-43 | T495X336(1)035A(2)E100 | 11.6 | 6.0 | 100 | 1285 | 1157 | 514 | 1 |
| 35 | 33 | X/7343-43 | T495X336(1)035A(2)E175 | 11.6 | 6.0 | 175 | 971 | 874 | 388 | 1 |
| 35 | 33 | X/7343-43 | T495X336(1)035A(2)E250 | 11.6 | 6.0 | 250 | 812 | 731 | 325 | 1 |
| 35 | 33 | E/7360-38 | T495E336(1)035A(2)E200 | 11.6 | 6.0 | 200 | 1000 | 900 | 400 | 1 |
| VDC | µF | KEMET/EIA | (See below for part options) | µAmps +20°C Max/5 Min | % @ +20°C 120 Hz Max | mΩ @ 20°C 100 kHz Max | (mA) 100 kHz 25°C | (mA) 100 kHz +85°C | (mA) 100 kHz +125°C | Reflow Temp ≤ 260°C |
| Rated Voltage | Rated Cap | Case Code/ Case Size | KEMET Part Number | DC Leakage | DF | ESR | Maximum Allowable Ripple Current | | | Moisture Sensitivity |

(1) To complete KEMET part number, insert M for ±20% or K for ±10%. Designates capacitance tolerance.

(2) To complete KEMET part number, insert T = 100% Matte Tin (Sn) Plated, G = Gold Plated, H = Standard Solder coated (SnPb 5% Pb minimum). Designates termination finish.

Refer to Ordering Information for additional detail.

Higher voltage ratings and tighter tolerance product including ESR may be substituted within the same size at KEMET's option. Voltage substitution will be marked with the higher voltage rating. Substitutions can include better than series.

Table 1 – Ratings & Part Number Reference cont'd

| Rated Voltage | Rated Cap | Case Code/ Case Size | KEMET Part Number | DC Leakage | DF | ESR | Maximum Allowable Ripple Current | | | Moisture Sensitivity |
|---------------|-----------|-------------------------|------------------------------|--------------------------|-------------------------|--------------------------|----------------------------------|-----------------------|------------------------|------------------------|
| VDC | μF | KEMET/EIA | (See below for part options) | μAmps +20°C Max/5 Min | % @ +20°C 120 Hz Max | mΩ @ 20°C 100 kHz Max | (mA) 100 kHz 25°C | (mA) 100 kHz +85°C | (mA) 100 kHz +125°C | Reflow Temp ≤ 260°C |
| 35 | 47 | X/7343-43 | T495X476(1)035A(2)E185 | 16.5 | 8.0 | 185 | 944 | 850 | 378 | 1 |
| 35 | 47 | X/7343-43 | T495X476(1)035A(2)E200 | 16.5 | 8.0 | 200 | 908 | 817 | 363 | 1 |
| 35 | 47 | X/7343-43 | T495X476(1)035A(2)E300 | 16.5 | 8.0 | 300 | 742 | 668 | 297 | 1 |
| 50 | 1 | C/6032-28 | T495C105(1)050A(2)E1K3 | 0.5 | 4.0 | 1300 | 291 | 262 | 116 | 1 |
| 50 | 2.2 | D/7343-31 | T495D225(1)050A(2)E600 | 1.1 | 6.0 | 600 | 500 | 450 | 200 | 1 |
| 50 | 3.3 | D/7343-31 | T495D335(1)050A(2)E700 | 1.7 | 6.0 | 700 | 463 | 417 | 185 | 1 |
| 50 | 4.7 | D/7343-31 | T495D475(1)050A(2)E275 | 2.4 | 6.0 | 275 | 739 | 665 | 296 | 1 |
| 50 | 4.7 | D/7343-31 | T495D475(1)050A(2)E300 | 2.4 | 6.0 | 300 | 707 | 636 | 283 | 1 |
| 50 | 4.7 | X/7343-43 | T495X475(1)050A(2)E300 | 2.4 | 4.0 | 300 | 742 | 668 | 297 | 1 |
| 50 | 4.7 | X/7343-43 | T495X475(1)050A(2)4095 | 2.4 | 4.0 | 300 | 742 | 668 | 297 | 1 |
| 50 | 6.8 | D/7343-31 | T495D685(1)050A(2)E190 | 3.4 | 6.0 | 190 | 889 | 800 | 356 | 1 |
| 50 | 6.8 | D/7343-31 | T495D685(1)050A(2)E200 | 3.4 | 6.0 | 200 | 866 | 779 | 346 | 1 |
| 50 | 6.8 | D/7343-31 | T495D685(1)050A(2)E275 | 3.4 | 6.0 | 275 | 739 | 665 | 296 | 1 |
| 50 | 6.8 | D/7343-31 | T495D685(1)050A(2)E300 | 3.4 | 8.0 | 300 | 707 | 636 | 283 | 1 |
| 50 | 10 | X/7343-43 | T495X106(1)050A(2)E250 | 5.0 | 8.0 | 250 | 812 | 731 | 325 | 1 |
| 50 | 10 | X/7343-43 | T495X106(1)050A(2)E260 | 5.0 | 6.0 | 260 | 797 | 717 | 319 | 1 |
| 50 | 10 | X/7343-43 | T495X106(1)050A(2)E300 | 5.0 | 6.0 | 300 | 742 | 668 | 297 | 1 |
| 50 | 15 | X/7343-43 | T495X156(1)050A(2)E200 | 7.5 | 8.0 | 200 | 908 | 817 | 363 | 1 |
| 50 | 15 | X/7343-43 | T495X156(1)050A(2)E300 | 7.5 | 8.0 | 300 | 742 | 668 | 297 | 1 |
| VDC | μF | KEMET/EIA | (See below for part options) | μAmps +20°C Max/5 Min | % @ +20°C 120 Hz Max | mΩ @ 20°C 100 kHz Max | (mA) 100 kHz 25°C | (mA) 100 kHz +85°C | (mA) 100 kHz +125°C | Reflow Temp ≤ 260°C |
| Rated Voltage | Rated Cap | Case Code/ Case Size | KEMET Part Number | DC Leakage | DF | ESR | Maximum Allowable Ripple Current | | | Moisture Sensitivity |

(1) To complete KEMET part number, insert M for ±20% or K for ±10%. Designates capacitance tolerance.

(2) To complete KEMET part number, insert T = 100% Matte Tin (Sn) Plated, G = Gold Plated, H = Standard Solder coated (SnPb 5% Pb minimum). Designates termination finish.

Refer to Ordering Information for additional detail.

Higher voltage ratings and tighter tolerance product including ESR may be substituted within the same size at KEMET's option. Voltage substitution will be marked with the higher voltage rating. Substitutions can include better than series.

Recommended Voltage Derating Guidelines

| -55°C to 125°C | | |
|---|------------------------|----------------|
| % Change in Working DC Voltage with Temperature | 50% of V _R | V _R |
| Recommended Maximum Application Voltage | 100% of V _R | V _R |



Ripple Current/Ripple Voltage

| KEMET Series and Case Code | EIA Case Code | Maximum Power Dissipation (P max) mWatts @ 25°C w/+20°C Rise |
|----------------------------|---------------|--|
| A | 3216-18 | 75 |
| B | 3528-21 | 85 |
| C | 6032-28 | 110 |
| D | 7343-31 | 150 |
| X | 7343-43 | 165 |
| E | 7360-38 | 200 |
| T428P | 7360-38 | 325 |
| S | 3216-12 | 60 |
| T | 3528-12 | 70 |
| U | 6032-15 | 90 |
| V | 7343-20 | 125 |
| T510X | 7343-43 | 270 |
| T510E | 7360-38 | 285 |

| Temperature Compensation Multipliers for Maximum Power Dissipation | | |
|--|------|-------|
| ≤ 25°C | 85°C | 125°C |
| 1.00 | 0.90 | 0.40 |

T = Environmental Temperature

Using the P max of the device, the maximum allowable rms ripple current or voltage may be determined.

$$I(max) = \sqrt{P_{max}/R}$$

$$E(max) = \sqrt{P_{max} \cdot R}$$

I = rms ripple current (amperes)
E = rms ripple voltage (volts)
P max = maximum power dissipation (watts)
R = ESR at specified frequency (ohms)

Reverse Voltage

Solid tantalum capacitors are polar devices and may be permanently damaged or destroyed if connected with the wrong polarity. The positive terminal is identified on the capacitor body by a stripe plus in some cases a beveled edge. A small degree of transient reverse voltage is permissible for short periods per the table. The capacitors should not be operated continuously in reverse mode, even within these limits.

| Temperature | Permissible Transient Reverse Voltage |
|-------------|---------------------------------------|
| 25°C | 15% of Rated Voltage |
| 85°C | 5% of Rated Voltage |
| 125°C | 1% of Rated Voltage |

Table 2 – Land Dimensions/Courtyard

| KEMET | Metric Size Code | Density Level A: Maximum (Most) Land Protrusion (mm) | | | | | Density Level B: Median (Nominal) Land Protrusion (mm) | | | | | Density Level C: Minimum (Least) Land Protrusion (mm) | | | | |
|----------------|------------------|--|------|------|-------|------|--|------|------|------|------|---|------|------|------|------|
| | | X | Y | C | V1 | V2 | X | Y | C | V1 | V2 | X | Y | C | V1 | V2 |
| A | 3216-18 | 1.35 | 2.15 | 1.45 | 6.10 | 2.80 | 1.25 | 1.75 | 1.35 | 5.00 | 2.30 | 1.15 | 1.35 | 1.25 | 4.10 | 2.00 |
| B | 3528-21 | 2.35 | 2.15 | 1.45 | 6.10 | 4.00 | 2.25 | 1.75 | 1.35 | 5.00 | 3.50 | 2.15 | 1.35 | 1.25 | 4.10 | 3.20 |
| C | 6032-28 | 2.35 | 2.65 | 2.60 | 8.90 | 4.40 | 2.25 | 2.25 | 2.50 | 7.80 | 3.90 | 2.15 | 1.85 | 2.40 | 6.90 | 3.60 |
| D | 7343-31 | 2.55 | 3.75 | 2.70 | 10.20 | 5.50 | 2.45 | 3.35 | 2.60 | 9.10 | 5.00 | 2.35 | 2.95 | 2.50 | 8.20 | 4.70 |
| E ¹ | 7360-38 | 4.25 | 2.65 | 3.20 | 10.10 | 7.20 | 4.15 | 2.25 | 3.30 | 9.40 | 6.70 | 4.05 | 1.85 | 3.00 | 8.10 | 6.40 |
| T | 3528-12 | 2.35 | 2.15 | 1.45 | 6.10 | 4.00 | 2.25 | 1.75 | 1.35 | 5.00 | 3.50 | 2.15 | 1.35 | 1.25 | 4.10 | 3.20 |
| V | 7343-20 | 2.55 | 3.75 | 2.70 | 10.20 | 5.50 | 2.45 | 3.35 | 2.60 | 9.10 | 5.00 | 2.35 | 2.95 | 2.50 | 8.20 | 4.70 |
| X ¹ | 7343-43 | 2.55 | 3.75 | 2.70 | 10.20 | 5.50 | 2.45 | 3.35 | 2.60 | 9.10 | 5.00 | 2.35 | 2.95 | 2.50 | 8.20 | 4.70 |

Density Level A: For low-density product applications. Recommended for wave solder applications and provides a wider process window for reflow solder processes.

Density Level B: For products with a moderate level of component density. Provides a robust solder attachment condition for reflow solder processes.

Density Level C: For high component density product applications. Before adapting the minimum land pattern variations the user should perform qualification testing based on the conditions outlined in IPC Standard 7351 (IPC-7351).

¹ Height of these chips may create problems in wave soldering.



Soldering Process

KEMET's families of surface mount capacitors are compatible with wave (single or dual), convection, IR, or vapor phase reflow techniques. Preheating of these components is recommended to avoid extreme thermal stress. KEMET's recommended profile conditions for convection and IR reflow reflect the profile conditions of the IPC/J-STD-020D standard for moisture sensitivity testing. The devices can safely withstand a maximum of three reflow passes at these conditions.

Please note that although the X/7343-43 case size can withstand wave soldering, the tall profile (4.3 mm maximum) dictates care in wave process development.

Hand soldering should be performed with care due to the difficulty in process control. If performed, care should be taken to avoid contact of the soldering iron to the molded case. The iron should be used to heat the solder pad, applying solder between the pad and the termination, until reflow occurs. Once reflow occurs, the iron should be removed immediately. "Wiping" the edges of a chip and heating the top surface is not recommended.

During typical reflow operations, a slight darkening of the gold-colored epoxy may be observed. This slight darkening is normal and not harmful to the product. Marking permanency is not affected by this change.

| Profile Feature | SnPb Assembly | Pb-Free Assembly |
|---|---------------------|---------------------|
| Preheat/Soak | | |
| Temperature Minimum (T_{smin}) | 100°C | 150°C |
| Temperature Maximum (T_{smax}) | 150°C | 200°C |
| Time (t_s) from T_{smin} to T_{smax} | 60 – 120 seconds | 60 – 120 seconds |
| Ramp-up Rate (T_L to T_p) | 3°C/seconds maximum | 3°C/seconds maximum |
| Liquidous Temperature (T_L) | 183°C | 217°C |
| Time Above Liquidous (t_L) | 60 – 150 seconds | 60 – 150 seconds |
| Peak Temperature (T_p) | 220°C* 235°C** | 250°C* 260°C** |
| Time within 5°C of Maximum Peak Temperature (t_p) | 20 seconds maximum | 30 seconds maximum |
| Ramp-down Rate (T_p to T_L) | 6°C/seconds maximum | 6°C/seconds maximum |
| Time 25°C to Peak | 6 minutes maximum | 8 minutes maximum |

Note: All temperatures refer to the center of the package, measured on the package body surface that is facing up during assembly reflow.

*Case Size D, E, P, Y, and X

**Case Size A, B, C, H, I, K, M, R, S, T, U, V, W, and Z

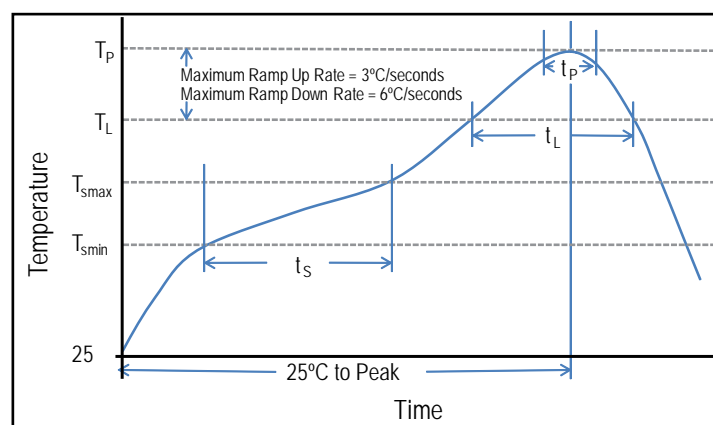

Construction



Capacitor Marking

C, D, X Case Sizes

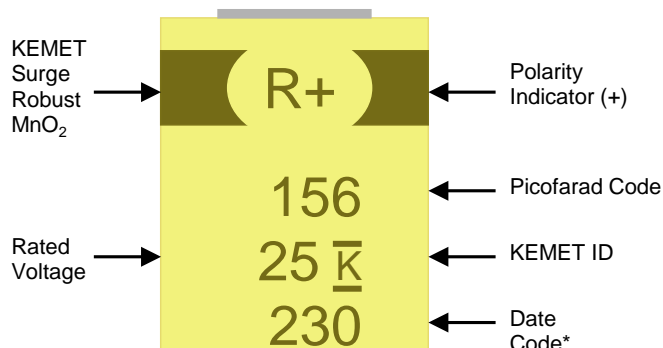

* 230 = 30th week of 2012

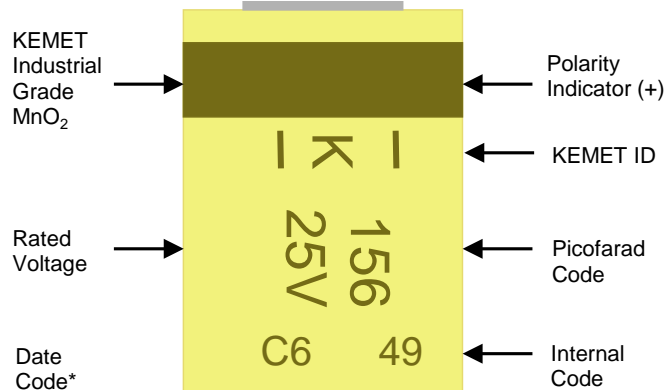

| Date Code * | |
|--|--|
| 1 st digit = Last number of Year | 9 = 2009 0 = 2010 1 = 2011 2 = 2012 |
| 2 nd and 3 rd digit = Week of the Year | 01 = 1 st week of the Year to 52 = 52 nd week of the Year |

| Date Code* | | |
|------------|---------|---------|
| Year | Month | |
| X = 2009 | 1 = Jan | 7 = Jul |
| A = 2010 | 2 = Feb | 8 = Aug |
| B = 2011 | 3 = Mar | 9 = Spt |
| C = 2012 | 4 = Apr | O = Oct |
| D = 2013 | 5 = May | N = Nov |
| E = 2014 | 6 = Jun | D = Dec |

Storage

Tantalum chip capacitors should be stored in normal working environments. While the chips themselves are quite robust in other environments, solderability will be degraded by exposure to high temperatures, high humidity, corrosive atmospheres, and long term storage. In addition, packaging materials will be degraded by high temperature– reels may soften or warp and tape peel force may increase. KEMET recommends that maximum storage temperature not exceed 40°C and maximum storage humidity not exceed 60% relative humidity. Temperature fluctuations should be minimized to avoid condensation on the parts and atmospheres should be free of chlorine and sulphur bearing compounds. For optimized solderability chip stock should be used promptly, preferably within three years of receipt.

Overview

The low ESR, surge-robust T510 Series is designed for demanding applications that require high surge current and high ripple current capability. This series builds upon the proven capabilities of our industrial grade tantalum chip capacitors to offer several advantages such as low ESR, high ripple current

capability, excellent capacitance stability, and improved resistance to high in-rush currents. These benefits are achieved through the utilization of multiple anodes as well as high-stress, low impedance electrical conditioning performed prior to screening.

Benefits

- Meets or exceeds EIA Standard 535BAAC
- Taped and reeled per EIA 481-1
- High surge current capability
- Optional gold-plated terminations
- High ripple current capability
- 100% surge current test
- 100% steady-state accelerated aging
- Capacitance values of 10 μ F to 1,000 μ F
- Tolerances of $\pm 10\%$ and $\pm 20\%$
- Voltage rating of 4 to 50 VDC
- Case sizes E and X
- ESR as low as 18 m Ω
- RoHS Compliant and lead-free terminations
- Operating temperature range of -55°C to +125°C

Applications

Typical applications include decoupling and filtering in industrial and automotive end applications, such as DC/DC converters, portable electronics, telecommunications, and control units requiring high ripple current capability.



Environmental Compliance

RoHS Compliant (6/6) according to Directive 2002/95/EC when ordered with 100% Sn solder.



RoHS Compliant

SPICE

For a detailed analysis of specific part numbers, please visit www.kemet.com for a free download of KEMET's SPICE software. The KEMET SPICE program is freeware intended to aid design engineers in analyzing the performance of these capacitors over frequency, temperature, ripple, and DC bias conditions.

Ordering Information

| T | 510 | X | 477 | M | 006 | A | T | E800 | |
|-----------------|------------------------|-----------|--|-----------------------|--|---------------------|---|--|------------------------------------|
| Capacitor Class | Series | Case Size | Capacitance Code (pF) | Capacitance Tolerance | Voltage | Failure Rate/Design | Lead Material | ESR | Packaging (C-Spec) |
| T = Tantalum | Multiple Anode Low ESR | E, X | First two digits represent significant figures. Third digit specifies number of zeros. | K = ±10% M = ±20% | 004 = 4 V 006 = 6.3 V 010 = 10 V 016 = 16 V 020 = 20 V 025 = 25 V 035 = 35 V 050 = 50 V | A = N/A Z = N/A | T = 100% Matte Tin (Sn) Plated H = Standard Solder Coated (SnPb 5% Pb minimum) G = Gold Plated (A, B, C, D, X only) | Last three digits specify ESR in mΩ. (800 = 800 mΩ) | Blank = 7" Reel 7280 = 13" Reel |

Performance Characteristics

| Item | Performance Characteristics |
|-------------------------|---|
| Operating Temperature | -55°C to 125°C |
| Rated Capacitance Range | 10 – 1,000 μF @ 120 Hz/25°C |
| Capacitance Tolerance | K Tolerance (10%), M Tolerance (20%) |
| Rated Voltage Range | 4 – 50 V |
| DF (120 Hz) | Refer to Part Number Electrical Specification Table |
| ESR (100 kHz) | Refer to Part Number Electrical Specification Table |
| Leakage Current | ≤ 0.01 CV (μA) at rated voltage after 5 minutes |

Qualification

| Test | Condition | Characteristics | | | | | |
|----------------------------|--|-----------------|--|-------|-----------------------------|----------|--|
| Endurance | 85°C @ rated voltage, 2,000 hours 125°C @ 2/3 rated voltage, 2,000 hours | ΔC/C | Within ±10% of initial value | | | | |
| | | DF | Within initial limits | | | | |
| | | DCL | Within 1.25 x initial limit | | | | |
| | | ESR | Within initial limits | | | | |
| Storage Life | 125°C @ 0 volts, 2,000 hours | ΔC/C | Within ±10% of initial value | | | | |
| | | DF | Within initial limits | | | | |
| | | DCL | Within 1.25 x initial limit | | | | |
| | | ESR | Within initial limits | | | | |
| Thermal Shock | MIL-STD-202, Method 107, Condition B, mounted, -55°C to 125°C, 1,000 cycles | ΔC/C | Within ±5% of initial value | | | | |
| | | DF | Within initial limits | | | | |
| | | DCL | Within 1.25 x initial limit | | | | |
| | | ESR | Within initial limits | | | | |
| Temperature Stability | Extreme temperature exposure at a succession of continuous steps at +25°C, -55°C, +25°C, +85°C, +125°C, +25°C | +25°C | -55°C | +85°C | +125°C | | |
| | | ΔC/C | IL* | ±10% | ±10% | ±20% | |
| | | DF | IL | IL | 1.5 x IL | 1.5 x IL | |
| | | DCL | IL | n/a | 10 x IL | 12 x IL | |
| | | Surge Voltage | 25°C and 85°C, 1.32 x rated voltage 1,000 cycles (125°C, 1.2 x rated voltage) | ΔC/C | Within ±5% of initial value | | |
| | | | | DF | Within initial limits | | |
| DCL | Within initial limits | | | | | | |
| ESR | Within initial limits | | | | | | |
| Mechanical Shock/Vibration | MIL-STD-202, Method 213, Condition I, 100 G peak MIL-STD-202, Method 204, Condition D, 10 Hz to 2,000 Hz, 20 G peak | ΔC/C | Within ±10% of initial value | | | | |
| | | DF | Within initial limits | | | | |
| | | DCL | Within initial limits | | | | |

*IL = Initial limit

Electrical Characteristics

Impedance, ESR vs. Frequency



Capacitance vs. Frequency



Dimensions – Millimeters (Inches)

Metric will govern

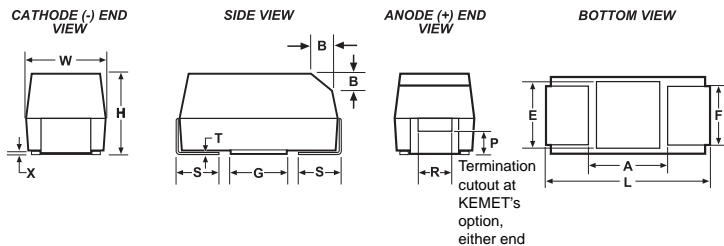

| Case Size | | Component | | | | | | | | | | | | |
|-----------|---------|----------------------------|----------------------------|----------------------------|--------------------|--------------------|-------------------------|------------------------------|------------|------------|-------------|------------|------------|------------|
| KEMET | EIA | L* | W* | H* | F* ±0.1 ±(.004) | S* ±0.3 ±(.012) | B* ±0.15 (Ref) ±.006 | X (Ref) | P (Ref) | R (Ref) | T (Ref) | A (Min) | G (Ref) | E (Ref) |
| X | 7343-43 | 7.3 ±0.3 (0.287 ±0.012) | 4.3 ±0.3 (0.169 ±0.012) | 4.0 ±0.3 (0.157 ±0.012) | 2.4 (.094) | 1.3 (.051) | 0.5 (.020) | 0.10 ± 0.10 (.004 ± .004) | 1.7 (.067) | 1.0 (.039) | 0.13 (.005) | 3.8 (.150) | 3.5 (.138) | 3.5 (.138) |
| E | 7360-38 | 7.3 ±0.3 (0.287 ±0.012) | 6.0 ±0.3 (0.236 ±0.012) | 3.6 ±0.2 (0.142 ±0.008) | 4.1 (.161) | 1.3 (.051) | 0.5 (.020) | 0.10 ± 0.10 (.004 ± .004) | n/a | n/a | 0.13 (.005) | 3.8 (.150) | 3.5 (.138) | 3.5 (.138) |

Notes: (Ref) – Dimensions provided for reference only. No dimensions are provided for B, P or R because low profile cases do not have a bevel or a notch.

* MIL-PRF-55365/8 specified dimensions

Table 1 – Ratings & Part Number Reference

| Rated Voltage | Rated Cap | Case Code/ Case Size | KEMET Part Number | DC Leakage | DF | ESR | Maximum Allowable Ripple Current | | | Moisture Sensitivity |
|---------------|-----------|-------------------------|------------------------------|--------------------------|-------------------------|--------------------------|----------------------------------|-----------------------|------------------------|------------------------|
| | | | | | | | (mA) 100 kHz 25°C | (mA) 100 kHz +85°C | (mA) 100 kHz +125°C | |
| VDC | μF | KEMET/EIA | (See below for part options) | μAmps +20°C Max/5 Min | % @ +20°C 120 Hz Max | mΩ @ 20°C 100 kHz Max | (mA) 100 kHz 25°C | (mA) 100 kHz +85°C | (mA) 100 kHz +125°C | Reflow Temp ≤ 260°C |
| 4 | 680 | X/7343-43 | T510X687(1)004A(2)E030 | 27.2 | 6.0 | 30 | 3000 | 2700 | 1200 | 1 |
| 4 | 1000 | X/7343-43 | T510X108(1)004A(2)E018 | 40.0 | 6.0 | 18 | 3873 | 3486 | 1549 | 1 |
| 4 | 1000 | X/7343-43 | T510X108(1)004A(2)E023 | 40.0 | 6.0 | 23 | 3426 | 3083 | 1370 | 1 |
| 4 | 1000 | E/7360-38 | T510E108(1)004A(2)E018 | 40.0 | 6.0 | 18 | 3979 | 3581 | 1592 | 1 |
| 4 | 1000 | E/7360-38 | T510E108(1)004A(2)E010 | 40.0 | 6.0 | 10 | 5339 | 4805 | 2136 | 1 |
| 6.3 | 470 | X/7343-43 | T510X477(1)006A(2)E030 | 29.6 | 6.0 | 30 | 3000 | 2700 | 1200 | 1 |
| 6.3 | 680 | X/7343-43 | T510X687(1)006A(2)E023 | 42.8 | 6.0 | 23 | 3426 | 3083 | 1370 | 1 |
| 6.3 | 680 | X/7343-43 | T510X687(1)006A(2)E045 | 42.8 | 12.0 | 45 | 2449 | 2204 | 980 | 1 |
| 6.3 | 680 | E/7360-38 | T510E687(1)006A(2)E023 | 42.8 | 6.0 | 23 | 3520 | 3168 | 1408 | 1 |
| 6.3 | 680 | E/7360-38 | T510E687(1)006A(2)E012 | 42.8 | 6.0 | 12 | 4873 | 4386 | 1949 | 1 |
| 10 | 330 | X/7343-43 | T510X337(1)010A(2)E035 | 33.0 | 6.0 | 35 | 2777 | 2499 | 1111 | 1 |
| 16 | 150 | X/7343-43 | T510X157(1)016A(2)E030 | 24.0 | 6.0 | 30 | 3000 | 2700 | 1200 | 1 |
| 16 | 150 | X/7343-43 | T510X157(1)016A(2)E040 | 24.0 | 6.0 | 40 | 2598 | 2338 | 1039 | 1 |
| 16 | 220 | X/7343-43 | T510X227(1)016A(2)E040 | 35.2 | 10.0 | 40 | 2598 | 2338 | 1039 | 1 |
| 16 | 220 | X/7343-43 | T510X227(1)016A(2)E025 | 35.2 | 10.0 | 25 | 3286 | 2957 | 1314 | 1 |
| 20 | 100 | X/7343-43 | T510X107(1)020A(2)E035 | 20.0 | 8.0 | 35 | 2777 | 2499 | 1111 | 1 |
| 20 | 100 | X/7343-43 | T510X107(1)020A(2)E040 | 20.0 | 6.0 | 40 | 2598 | 2338 | 1039 | 1 |
| 20 | 100 | X/7343-43 | T510X107(1)020A(2)E045 | 20.0 | 6.0 | 45 | 2449 | 2204 | 980 | 1 |
| 25 | 68 | X/7343-43 | T510X686(1)025A(2)E045 | 17.0 | 8.0 | 45 | 2449 | 2204 | 980 | 1 |
| 25 | 100 | E/7360-38 | T510E107(1)025A(2)E050 | 25.0 | 8.0 | 50 | 2387 | 2148 | 955 | 1 |
| 35 | 22 | X/7343-43 | T510X226(1)035A(2)E100 | 7.7 | 6.0 | 100 | 1643 | 1479 | 657 | 1 |
| 35 | 22 | X/7343-43 | T510X226(1)035A(2)E080 | 7.7 | 6.0 | 80 | 1837 | 1653 | 735 | 1 |
| 35 | 22 | X/7343-43 | T510X226(1)035A(2)E060 | 7.7 | 6.0 | 60 | 2121 | 1909 | 848 | 1 |
| 35 | 33 | X/7343-43 | T510X336(1)035A(2)E065 | 11.6 | 6.0 | 65 | 2038 | 1834 | 815 | 1 |
| 35 | 33 | X/7343-43 | T510X336(1)035A(2)E050 | 11.6 | 6.0 | 50 | 2324 | 2092 | 930 | 1 |
| 35 | 47 | X/7343-43 | T510X476(1)035A(2)E055 | 16.5 | 8.0 | 55 | 2216 | 1994 | 886 | 1 |
| 35 | 47 | X/7343-43 | T510X476(1)035A(2)E065 | 16.5 | 8.0 | 65 | 2038 | 1834 | 815 | 1 |
| 35 | 47 | E/7360-38 | T510E476(1)035A(2)E050 | 16.5 | 8.0 | 50 | 2387 | 2148 | 955 | 1 |
| 50 | 10 | X/7343-43 | T510X106(1)050A(2)E120 | 5.0 | 8.0 | 120 | 1500 | 1350 | 600 | 1 |
| 50 | 10 | X/7343-43 | T510X106(1)050A(2)E090 | 5.0 | 8.0 | 90 | 1732 | 1559 | 693 | 1 |
| VDC | μF | KEMET/EIA | (See below for part options) | μAmps +20°C Max/5 Min | % @ +20°C 120 Hz Max | mΩ @ 20°C 100 kHz Max | (mA) 100 kHz 25°C | (mA) 100 kHz +85°C | (mA) 100 kHz +125°C | Reflow Temp ≤ 260°C |
| Rated Voltage | Rated Cap | Case Code/ Case Size | KEMET Part Number | DC Leakage | DF | ESR | Maximum Allowable Ripple Current | | | Moisture Sensitivity |

(1) To complete KEMET part number, insert M for ±20% or K for ±10%. Designates Capacitance tolerance.

(2) To complete KEMET part number, insert T = 100% Matte Tin (Sn) Plated, G = Gold Plated, H = Standard Solder coated (SnPb 5% Pb minimum).

Designates Termination Finish.

Refer to Ordering Information for additional detail.

Higher voltage ratings and tighter tolerance product including ESR may be substituted within the same size at KEMET's option. Voltage substitution will be marked with the higher voltage rating. Substitutions can include better than series.

Recommended Voltage Derating Guidelines

| -55°C to 125°C | | |
|---|------------------------|----------------|
| % Change in Working DC Voltage with Temperature | 50% of V _R | V _R |
| Recommended Maximum Application Voltage | 100% of V _R | V _R |



Ripple Current/Ripple Voltage

| KEMET Series and Case Code | EIA Case Code | Maximum Power Dissipation (P max) mWatts @ 25°C w/+20°C Rise |
|----------------------------|---------------|--|
| A | 3216-18 | 75 |
| B | 3528-21 | 85 |
| C | 6032-28 | 110 |
| D | 7343-31 | 150 |
| X | 7343-43 | 165 |
| E | 7360-38 | 200 |
| T428P | 7360-38 | 325 |
| S | 3216-12 | 60 |
| T | 3528-12 | 70 |
| U | 6032-15 | 90 |
| V | 7343-20 | 125 |
| T510X | 7343-43 | 270 |
| T510E | 7360-38 | 285 |

| Temperature Compensation Multipliers for Maximum Power Dissipation | | |
|--|------|-------|
| ≤ 25°C | 85°C | 125°C |
| 1.00 | 0.90 | 0.40 |

T = Environmental Temperature

Using the P max of the device, the maximum allowable rms ripple current or voltage may be determined.

$$I(max) = \sqrt{P_{max}/R}$$

$$E(max) = \sqrt{P_{max} \cdot R}$$

I = rms ripple current (amperes)
 E = rms ripple voltage (volts)
 P max = maximum power dissipation (watts)
 R = ESR at specified frequency (ohms)

Reverse Voltage

Solid tantalum capacitors are polar devices and may be permanently damaged or destroyed if connected with the wrong polarity. The positive terminal is identified on the capacitor body by a stripe plus in some cases a beveled edge. A small degree of transient reverse voltage is permissible for short periods per the table. The capacitors should not be operated continuously in reverse mode, even within these limits.

| Temperature | Permissible Transient Reverse Voltage |
|-------------|---------------------------------------|
| 25°C | 15% of Rated Voltage |
| 85°C | 5% of Rated Voltage |
| 125°C | 1% of Rated Voltage |

Table 2 – Land Dimensions/Courtyard

| KEMET | Metric Size Code | Density Level A: Maximum (Most) Land Protrusion (mm) | | | | | Density Level B: Median (Nominal) Land Protrusion (mm) | | | | | Density Level C: Minimum (Least) Land Protrusion (mm) | | | | | |
|----------------|------------------|--|------|------|------|-------|--|------|------|------|------|---|------|------|------|------|------|
| | | Case | EIA | X | Y | C | V1 | V2 | X | Y | C | V1 | V2 | X | Y | C | V1 |
| E ¹ | 7360–38 | | 4.25 | 2.65 | 3.20 | 10.10 | 7.20 | 4.15 | 2.25 | 3.30 | 9.40 | 6.70 | 4.05 | 1.85 | 3.00 | 8.10 | 6.40 |
| X ¹ | 7343–43 | | 2.55 | 3.75 | 2.70 | 10.20 | 5.50 | 2.45 | 3.35 | 2.60 | 9.10 | 5.00 | 2.35 | 2.95 | 2.50 | 8.20 | 4.70 |

Density Level A: For low-density product applications. Recommended for wave solder applications and provides a wider process window for reflow solder processes.

Density Level B: For products with a moderate level of component density. Provides a robust solder attachment condition for reflow solder processes.

Density Level C: For high component density product applications. Before adapting the minimum land pattern variations the user should perform qualification testing based on the conditions outlined in IPC Standard 7351 (IPC–7351).

¹ Height of these chips may create problems in wave soldering.



Soldering Process

KEMET's families of surface mount capacitors are compatible with wave (single or dual), convection, IR, or vapor phase reflow techniques. Preheating of these components is recommended to avoid extreme thermal stress. KEMET's recommended profile conditions for convection and IR reflow reflect the profile conditions of the IPC/J-STD-020D standard for moisture sensitivity testing. The devices can safely withstand a maximum of three reflow passes at these conditions.

Please note that although the X/7343-43 case size can withstand wave soldering, the tall profile (4.3 mm maximum) dictates care in wave process development.

Hand soldering should be performed with care due to the difficulty in process control. If performed, care should be taken to avoid contact of the soldering iron to the molded case. The iron should be used to heat the solder pad, applying solder between the pad and the termination, until reflow occurs. Once reflow occurs, the iron should be removed immediately. "Wiping" the edges of a chip and heating the top surface is not recommended.

During typical reflow operations, a slight darkening of the gold-colored epoxy may be observed. This slight darkening is normal and not harmful to the product. Marking permanency is not affected by this change.

| Profile Feature | SnPb Assembly | Pb-Free Assembly |
|---|---------------------|---------------------|
| Preheat/Soak | | |
| Temperature Minimum (T_{smin}) | 100°C | 150°C |
| Temperature Maximum (T_{smax}) | 150°C | 200°C |
| Time (t_s) from T_{smin} to T_{smax} | 60 – 120 seconds | 60 – 120 seconds |
| Ramp-up Rate (T_L to T_p) | 3°C/seconds maximum | 3°C/seconds maximum |
| Liquidous Temperature (T_L) | 183°C | 217°C |
| Time Above Liquidous (t_L) | 60 – 150 seconds | 60 – 150 seconds |
| Peak Temperature (T_p) | 220°C* 235°C** | 250°C* 260°C** |
| Time within 5°C of Maximum Peak Temperature (t_p) | 20 seconds maximum | 30 seconds maximum |
| Ramp-down Rate (T_p to T_L) | 6°C/seconds maximum | 6°C/seconds maximum |
| Time 25°C to Peak | 6 minutes maximum | 8 minutes maximum |

Note: All temperatures refer to the center of the package, measured on the package body surface that is facing up during assembly reflow.

*Case Size D, E, P, Y, and X

**Case Size A, B, C, H, I, K, M, R, S, T, U, V, W, and Z



Construction

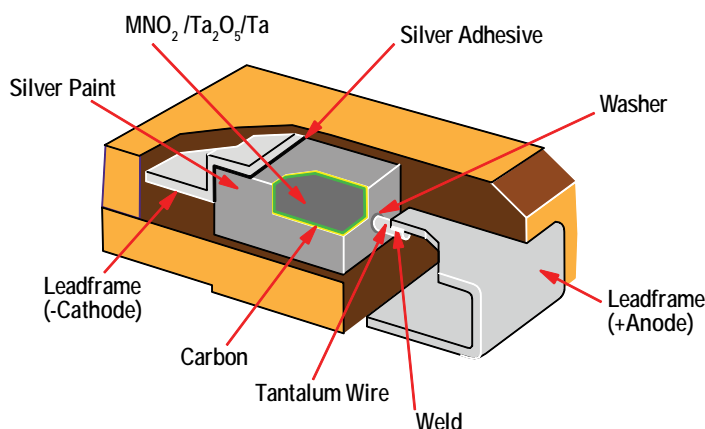

Capacitor Marking



* 230 = 30th week of 2012



| Date Code * | |
|--|--|
| 1 st digit = Last number of Year | 9 = 2009 0 = 2010 1 = 2011 2 = 2012 |
| 2 nd and 3 rd digit = Week of the Year | 01 = 1 st week of the Year to 52 = 52 nd week of the Year |

| Date Code* | | |
|------------|---------|---------|
| Year | Month | |
| X = 2009 | 1 = Jan | 7 = Jul |
| A = 2010 | 2 = Feb | 8 = Aug |
| B = 2011 | 3 = Mar | 9 = Spt |
| C = 2012 | 4 = Apr | O = Oct |
| D = 2013 | 5 = May | N = Nov |
| E = 2014 | 6 = Jun | D = Dec |

Storage

Tantalum chip capacitors should be stored in normal working environments. While the chips themselves are quite robust in other environments, solderability will be degraded by exposure to high temperatures, high humidity, corrosive atmospheres, and long term storage. In addition, packaging materials will be degraded by high temperature—reels may soften or warp and tape peel force may increase. KEMET recommends that maximum storage temperature not exceed 40°C and maximum storage humidity not exceed 60% relative humidity. Temperature fluctuations should be minimized to avoid condensation on the parts and atmospheres should be free of chlorine and sulphur bearing compounds. For optimized solderability chip stock should be used promptly, preferably within three years of receipt.

Overview

The KEMET Tantalum Stacks MnO₂ (TSM) Series is designed to provide the highest capacitance/voltage ratings in surface mount configuration. KEMET's T493 COTS Military/Aerospace capacitors are utilized in stacks of 2,3,4,and 6 components to achieve a broad range of capacitance and voltage ratings. The T493 COTS series offers component level Weibull grading options, surge current testing options and standard, low,

and ultra-low ESR options. All component level lots of this series are conditioned with MIL-PRF-55365 Group A testing. Stacking configurations offer this high reliability product with custom capacitance/voltage solutions and very low ESR options.

Note: Custom stacking solutions are available with other KEMET Tantalum Surface Mount Series. Please contact KEMET Product Management for availability.

Benefits

- High capacitance
- Surface mountable
- Capacitance values of 9.4 μ F to 1980 μ F
- Capacitance can be custom specified
- Voltage ratings of 6 VDC to 50 VDC
- High volumetric efficiency
- Ultra-low ESR
- Surge capability
- Weibull failure options B and C
- Operating temperature range of -55°C to +125°C
- Laser-marked case
- Discrete components EIA standard case sizes (others available)
- High Temperature lead attach material available (> 260°C)

Applications

Typical applications include decoupling and filtering in a variety of market segments. The T493 COTS stack devices can be utilized in military and aerospace applications. Other KEMET series can be utilized in filtering and decoupling applications to service various market segments.



Environmental Compliance

RoHS Compliant (6/6) according to Directive 2002/95/EC when ordered with 100% Sn solder.



RoHS Compliant

SPICE

For a detailed analysis of specific part numbers, please visit www.kemet.com for a free download of KEMET's SPICE software. The KEMET SPICE program is freeware intended to aid design engineers in analyzing the performance of these capacitors over frequency, temperature, ripple, and DC bias conditions.

Ordering Information

| T | SM | 2D | 447 | K | 10 | A | H | 61 | 20 | D493 |
|-----------------|---------------------------------|--|--|-----------------------|---|--|---|--|---|--|
| Capacitor Class | Series | Case Size | Capacitance Code (pF) | Capacitance Tolerance | Voltage | Failure Rate/Design | Lead Material | Surge | ESR | C-Spec 2 |
| T = Tantalum | Stacks MnO ₂ Cathode | 2C, 3C, 4C, 6C, 2D, 3D, 4D, 6D, 2X, 3X, 4X, 6X | First two digits represent significant figures. Third digit specifies number of zeros. | K = ±10% M = ±20% | 006 = 6.3 V 010 = 10 V 016 = 16 V 020 = 20 V 025 = 25 V 035 = 35 V 050 = 50 V | A = N/A B = 0.1%/1,000 hours C = 0.01%/1,000 hours | H = Standard Solder Coated (SnPb 5% Pb minimum) C = Hot Solder Dipped B = Gold Plated T = 100% Tin | 61 = None 62 = 10 Cycles 25°C After Weibull 63 = 10 cycles, -55°C and 85°C After Weibull 64 = 10 cycles, -55°C and 85°C Before Weibull Special CSPEC: CECC | 10 = ESR-Standard 20 = ESR-Low 30 = ESR-Ultra-low | Designates discrete component series. D493 = T493 |

Note: These TSM Stacks are specific to T493 COTS.

Performance Characteristics

| Item | Performance Characteristics |
|-------------------------|---|
| Operating Temperature | -55°C to 125°C |
| Rated Capacitance Range | 9.4 – 1980 µF @ 120 Hz/25°C |
| Capacitance Tolerance | K Tolerance (10%), M Tolerance (20%) |
| Rated Voltage Range | 6 – 50 V |
| DF (120 Hz) | Refer to Part Number Electrical Specification Table |
| ESR (100 kHz) | Refer to Part Number Electrical Specification Table |
| Leakage Current | ≤ 0.01 CV (mA) at rated voltage after 5 minutes |

Qualification

| Test | Condition | Characteristics | |
|----------------------|---|-----------------|------------------------------|
| Endurance | 85°C @ rated voltage, 2,000 hours 125°C @ 2/3 rated voltage, 2,000 hours | Δ C/C | Within ±10% of initial value |
| | | DF | Within initial limits |
| | | DCL | Within 1.25 x initial limit |
| | | ESR | Within initial limits |
| Thermal Shock | KEMET specified test, mounted, -55°C to 125° C, 5 cycles | Δ C/C | Within ±5% of initial value |
| | | DF | Within initial limits |
| | | DCL | Within 1.25 x initial limit |
| | | ESR | Within initial limits |
| Surge Voltage | 85° C, 1.15 x rated voltage 1,000 cycles | Δ C/C | Within ±5% of initial value |
| | | DF | Within initial limits |
| | | DCL | Within initial limits |
| | | ESR | Within initial limits |
| Surge Voltage | 125° C, 0.77 x rated voltage 1,000 cycles | Δ C/C | Within ±5% of initial value |
| | | DF | Within initial limits |
| | | DCL | Within initial limits |
| | | ESR | Within initial limits |
| Mechanical Vibration | MIL-STD-202, Method 204, Condition D, 10 Hz to 2,000 Hz, 20 G peak | Δ C/C | Within ±10% of initial value |
| | | DF | Within initial limits |
| | | DCL | Within initial limits |

Dimensions – Millimeters (Inches)

Metric will govern

TSM2

| KEMET 2 Component Stack Dimensions | | | | | | |
|------------------------------------|-----------------------------|----------------------------|-----------------------------|----------------------------|-----------------------------|-----------------------------|
| Case Code | L | W | H | W2 | H2 | P |
| 2C | 6.5 ± 0.38 (.258 ± .015) | 3.3 ± 0.2 (.130 ± .008) | 5.3 ± 0.38 (.210 ± .015) | 2.5 ± 0.2 (.100 ± .008) | 4.5 ± 0.38 (.176 ± .015) | 1.4 ± 0.38 (.055 ± .015) |
| 2D | 8.0 ± 0.38 (.315 ± .015) | 4.4 ± 0.2 (.174 ± .008) | 6.2 ± 0.38 (.245 ± .015) | 3.0 ± 0.2 (.120 ± .008) | 4.8 ± 0.38 (.192 ± .015) | 1.9 ± 0.38 (.075 ± .015) |
| 2X | 8.0 ± 0.38 (.315 ± .015) | 4.4 ± 0.2 (.174 ± .008) | 8.9 ± 0.38 (.352 ± .015) | 3.0 ± 0.2 (.120 ± .008) | 6.9 ± 0.38 (.272 ± .015) | 1.9 ± 0.38 (.075 ± .015) |



TSM3

| KEMET 3 Component Stack Dimensions | | | | | | |
|------------------------------------|-----------------------------|----------------------------|------------------------------|----------------------------|------------------------------|-----------------------------|
| Case Code | L | W | H | W2 | H2 | P |
| 3C | 6.5 ± 0.38 (.258 ± .015) | 3.3 ± 0.2 (.130 ± .008) | 7.8 ± 0.38 (.310 ± .015) | 2.5 ± 0.2 (.100 ± .008) | 6.4 ± 0.38 (.252 ± .015) | 1.4 ± 0.38 (.055 ± .015) |
| 3D | 8.0 ± 0.38 (.315 ± .015) | 4.4 ± 0.2 (.174 ± .008) | 9.2 ± 0.38 (.365 ± .015) | 3.0 ± 0.2 (.120 ± .008) | 7.7 ± 0.38 (.304 ± .015) | 1.9 ± 0.38 (.075 ± .015) |
| 3X | 8.0 ± 0.38 (.315 ± .015) | 4.4 ± 0.2 (.174 ± .008) | 13.3 ± 0.38 (.525 ± .015) | 3.0 ± 0.2 (.120 ± .008) | 11.0 ± 0.38 (.436 ± .015) | 1.9 ± 0.38 (.075 ± .015) |



TSM4

| KEMET 4 Component Stack Dimensions | | | | | | |
|------------------------------------|-----------------------------|----------------------------|-----------------------------|----------------------------|-----------------------------|-----------------------------|
| Case Code | L | W | H | W2 | H2 | P |
| 4C | 6.5 ± 0.38 (.258 ± .015) | 6.6 ± 0.2 (.262 ± .008) | 5.3 ± 0.38 (.210 ± .015) | 5.8 ± 0.2 (.230 ± .008) | 4.6 ± 0.38 (.180 ± .015) | 1.4 ± 0.38 (.055 ± .015) |
| 4D | 8.0 ± 0.38 (.315 ± .015) | 8.9 ± 0.2 (.350 ± .008) | 6.2 ± 0.38 (.245 ± .015) | 7.4 ± 0.2 (.292 ± .008) | 4.8 ± 0.38 (.192 ± .015) | 1.9 ± 0.38 (.075 ± .015) |
| 4X | 8.0 ± 0.38 (.315 ± .015) | 8.9 ± 0.2 (.350 ± .008) | 8.9 ± 0.38 (.352 ± .015) | 7.4 ± 0.2 (.292 ± .008) | 6.9 ± 0.38 (.272 ± .015) | 1.9 ± 0.38 (.075 ± .015) |



TSM6

| KEMET 6 Component Stack Dimensions | | | | | | |
|------------------------------------|-----------------------------|----------------------------|------------------------------|----------------------------|------------------------------|-----------------------------|
| Case Code | L | W | H | W2 | H2 | P |
| 6C | 6.5 ± 0.38 (.258 ± .015) | 6.6 ± 0.2 (.262 ± .008) | 7.8 ± 0.38 (.310 ± .015) | 5.8 ± 0.2 (.230 ± .008) | 6.6 ± 0.38 (.260 ± .015) | 1.4 ± 0.38 (.055 ± .015) |
| 6D | 8.0 ± 0.38 (.315 ± .015) | 8.9 ± 0.2 (.350 ± .008) | 9.2 ± 0.38 (.365 ± .015) | 7.4 ± 0.2 (.292 ± .008) | 7.7 ± 0.38 (.304 ± .015) | 1.9 ± 0.38 (.075 ± .015) |
| 6X | 8.0 ± 0.38 (.315 ± .015) | 8.9 ± 0.2 (.350 ± .008) | 13.3 ± 0.38 (.525 ± .015) | 7.4 ± 0.2 (.292 ± .008) | 11.0 ± 0.38 (.436 ± .015) | 1.9 ± 0.38 (.075 ± .015) |



Capacitance and Rated Voltage Chart

| Capacitance | | Rated Voltage | | | | | | |
|-------------|------|---------------|--------|------|------|------|------|------|
| μF | Code | 6 V | 10 V | 16 V | 20 V | 25 V | 35 V | 50 V |
| 9.4 | 945 | | | | | | | 2D |
| 14 | 146 | | | | | | | 3D |
| 19 | 196 | | | | | | | 4D |
| 20 | 206 | | | | | | 2C | 2X |
| 28 | 286 | | | | | | | 6D |
| 30 | 306 | | | | | 2C | 3C | 3X |
| 40 | 406 | | | | | | 4C | 4X |
| 44 | 446 | | | | 2C | | 2D | |
| 45 | 456 | | | | | 3C | | |
| 60 | 606 | | | | | 4C | 6C | 6X |
| 66 | 666 | | | | 3C | | 3D | |
| 88 | 886 | | | | 4C | | 4D | |
| 90 | 906 | | | | | 6C | | |
| 94 | 946 | | | 2C | | 2D | | |
| 132 | 137 | | | | 6C | | 6D | |
| 136 | 137 | | | | 2D | | | |
| 141 | 147 | | | 3C | | 3D | | |
| 188 | 197 | | | 4C | | 4D | | |
| 200 | 207 | | 2C | | | | | |
| 204 | 207 | | | | 3D | | | |
| 272 | 277 | | | | 4D | | | |
| 282 | 287 | | | 6C | | 6D | | |
| 300 | 307 | | 3C | 2D | | | | |
| 400 | 407 | | 4C | | | | | |
| 408 | 417 | | | | 6D | | | |
| 440 | 447 | 2C | 2D | | | | | |
| 450 | 457 | | | 3D | | | | |
| 600 | 607 | | 6C | 4D | | | | |
| 660 | 667 | 3C, 2D | 3D, 2X | | | | | |
| 880 | 887 | 4C | 4D | | | | | |
| 900 | 907 | | | 6D | | | | |
| 990 | 997 | 3D | 3X | | | | | |
| 1320 | 138 | 6C, 4D | 6D, 4X | | | | | |
| 1980 | 208 | 6D | 6X | | | | | |

Table 1A – TSM2 Ratings & Part Number Reference

| Rated Voltage | Rated Cap | Case Code/ Case Size | KEMET Part Number | DC Leakage | DF | Standard ESR | Low ESR | Ultra-low ESR | Moisture Sensitivity |
|---------------|-----------|-------------------------|------------------------------|-------------------------|-------------------------|--------------------------|--------------------------|--------------------------|------------------------|
| V | µF | KEMET/EIA | (See below for part options) | µA @ +20°C Max/5 Min | % @ +20°C 120 Hz Max | Ω @ +20°C 100 kHz Max | Ω @ +20°C 100 kHz Max | Ω @ +20°C 100 kHz Max | Temperature ≤ 260°C |
| 6.3 | 440 | 2C | TSM2C447(1)006(2)(3)(4)(5) | 27.8 | 10 | 0.600 | 0.150 | 0.115 | 1 |
| 10 | 200 | 2C | TSM2C207(1)010(2)(3)(4)(5) | 20.0 | 8 | 0.600 | 0.150 | NA | 1 |
| 16 | 94 | 2C | TSM2C946(1)016(2)(3)(4)(5) | 15.0 | 6 | 0.600 | 0.250 | 0.175 | 1 |
| 20 | 44 | 2C | TSM2C446(1)020(2)(3)(4)(5) | 8.8 | 6 | 0.600 | 0.200 | NA | 1 |
| 25 | 30 | 2C | TSM2C306(1)025(2)(3)(4)(5) | 7.6 | 6 | 0.750 | 0.450 | NA | 1 |
| 35 | 20 | 2C | TSM2C206(1)035(2)(3)(4)(5) | 7.0 | 6 | 1.000 | 0.600 | NA | 1 |
| 6.3 | 660 | 2D | TSM2D667(1)006(2)(3)(4)(5) | 41.6 | 8 | 0.250 | 0.075 | 0.050 | 1 |
| 10 | 440 | 2D | TSM2D447(1)010(2)(3)(4)(5) | 44.0 | 8 | 0.250 | 0.100 | 0.040 | 1 |
| 16 | 300 | 2D | TSM2D307(1)016(2)(3)(4)(5) | 48.0 | 8 | 0.350 | 0.200 | 0.075 | 1 |
| 20 | 136 | 2D | TSM2D137(1)020(2)(3)(4)(5) | 27.2 | 8 | 0.350 | 0.100 | 0.075 | 1 |
| 25 | 94 | 2D | TSM2D946(1)025(2)(3)(4)(5) | 23.6 | 10 | 0.350 | 0.100 | 0.060 | 1 |
| 35 | 44 | 2D | TSM2D446(1)035(2)(3)(4)(5) | 15.4 | 6 | 0.350 | 0.200 | 0.100 | 1 |
| 50 | 9.4 | 2D | TSM2D945(1)050(2)(3)(4)(5) | 4.8 | 6 | 0.750 | 0.300 | 0.140 | 1 |
| 10 | 660 | 2X | TSM2X667(1)010(2)(3)(4)(5) | 66.0 | 10 | 0.250 | 0.050 | 0.025 | 1 |
| 50 | 20 | 2X | TSM2X206(1)050(2)(3)(4)(5) | 10.0 | 6 | 0.350 | 0.200 | NA | 1 |
| V | µF | KEMET/EIA | (See below for part options) | µA @ +20°C Max/5 Min | % @ +20°C 120 Hz Max | Ω @ +20°C 100 kHz Max | Ω @ +20°C 100 kHz Max | Ω @ +20°C 100 kHz Max | Temperature ≤ 260°C |
| Rated Voltage | Rated Cap | Case Code/ Case Size | KEMET Part Number | DC Leakage | DF | Standard ESR | Low ESR | Ultra-low ESR | Moisture Sensitivity |

Table 1B – TSM3 Ratings & Part Number Reference

| Rated Voltage | Rated Cap | Case Code/ Case Size | KEMET Part Number | DC Leakage | DF | Standard ESR | Low ESR | Ultra-low ESR | Moisture Sensitivity |
|---------------|-----------|-------------------------|------------------------------|-------------------------|-------------------------|--------------------------|--------------------------|--------------------------|------------------------|
| V | µF | KEMET/EIA | (See below for part options) | µA @ +20°C Max/5 Min | % @ +20°C 120 Hz Max | Ω @ +20°C 100 kHz Max | Ω @ +20°C 100 kHz Max | Ω @ +20°C 100 kHz Max | Temperature ≤ 260°C |
| 6.3 | 660 | 3C | TSM3C667(1)006(2)(3)(4)(5) | 41.7 | 10 | 0.400 | 0.100 | 0.077 | 1 |
| 10 | 300 | 3C | TSM3C307(1)010(2)(3)(4)(5) | 30.0 | 8 | 0.400 | 0.100 | NA | 1 |
| 16 | 141 | 3C | TSM3C147(1)016(2)(3)(4)(5) | 22.5 | 6 | 0.400 | 0.167 | 0.117 | 1 |
| 20 | 66 | 3C | TSM3C666(1)020(2)(3)(4)(5) | 13.2 | 6 | 0.400 | 0.133 | NA | 1 |
| 25 | 45 | 3C | TSM3C456(1)025(2)(3)(4)(5) | 11.4 | 6 | 0.500 | 0.300 | NA | 1 |
| 35 | 30 | 3C | TSM3C306(1)035(2)(3)(4)(5) | 10.5 | 6 | 0.667 | 0.400 | NA | 1 |
| 6.3 | 990 | 3D | TSM3D997(1)006(2)(3)(4)(5) | 62.4 | 8 | 0.167 | 0.050 | 0.033 | 1 |
| 10 | 660 | 3D | TSM3D667(1)010(2)(3)(4)(5) | 66.0 | 8 | 0.167 | 0.067 | 0.027 | 1 |
| 16 | 450 | 3D | TSM3D457(1)016(2)(3)(4)(5) | 72.0 | 8 | 0.233 | 0.133 | 0.050 | 1 |
| 20 | 204 | 3D | TSM3D207(1)020(2)(3)(4)(5) | 40.8 | 8 | 0.233 | 0.067 | 0.050 | 1 |
| 25 | 141 | 3D | TSM3D147(1)025(2)(3)(4)(5) | 35.4 | 10 | 0.233 | 0.067 | 0.040 | 1 |
| 35 | 66 | 3D | TSM3D666(1)035(2)(3)(4)(5) | 23.1 | 6 | 0.233 | 0.133 | 0.067 | 1 |
| 50 | 14 | 3D | TSM3D146(1)050(2)(3)(4)(5) | 7.2 | 6 | 0.500 | 0.200 | 0.093 | 1 |
| 10 | 990 | 3X | TSM3X997(1)010(2)(3)(4)(5) | 99.0 | 10 | 0.167 | 0.033 | 0.017 | 1 |
| 50 | 30 | 3X | TSM3X306(1)050(2)(3)(4)(5) | 15.0 | 6 | 0.233 | 0.133 | NA | 1 |
| V | µF | KEMET/EIA | (See below for part options) | µA @ +20°C Max/5 Min | % @ +20°C 120 Hz Max | Ω @ +20°C 100 kHz Max | Ω @ +20°C 100 kHz Max | Ω @ +20°C 100 kHz Max | Temperature ≤ 260°C |
| Rated Voltage | Rated Cap | Case Code/ Case Size | KEMET Part Number | DC Leakage | DF | Standard ESR | Low ESR | Ultra-low ESR | Moisture Sensitivity |

- (1) To complete KEMET part number, insert M for ± 20%, K for ± 10%. Designates Capacitance tolerance.
 - (2) To complete KEMET part number, insert B (0.1%/1,000 hours), C (0.01%/1,000 hours) or A = N/A. Designates Reliability Level.
 - (3) To complete KEMET part number, insert B = Gold Plated, C = Hot solder dipped, H = Solder Plated, or T = 100% Tin (Sn). Designates Termination Finish.
 - (4) To complete KEMET part number, insert 61 = None, 62 = 10 cycles +25°C, 63 = 10 cycles -55°C +85°C after Weibull or 64 = 10 cycles -55°C +85°C before Weibull. Designates Surge current option.
 - (5) To complete KEMET part number, insert 10 = Standard ESR, 20 = Low ESR or 30 = Ultra Low ESR. Designates ESR option.
- Refer to Ordering Information for additional detail.

Table 1C – TSM4 Ratings & Part Number Reference

| Rated Voltage | Rated Cap | Case Code/ Case Size | KEMET Part Number | DC Leakage | DF | Standard ESR | Low ESR | Ultra-low ESR | Moisture Sensitivity |
|---------------|-----------|-------------------------|------------------------------|-------------------------|-------------------------|--------------------------|--------------------------|--------------------------|------------------------|
| V | µF | KEMET/EIA | (See below for part options) | µA @ +20°C Max/5 Min | % @ +20°C 120 Hz Max | Ω @ +20°C 100 kHz Max | Ω @ +20°C 100 kHz Max | Ω @ +20°C 100 kHz Max | Temperature ≤ 260°C |
| 6.3 | 880 | 4C | TSM4C887(1)006(2)(3)(4)(5) | 55.6 | 10 | 0.300 | 0.075 | 0.058 | 1 |
| 10 | 400 | 4C | TSM4C407(1)010(2)(3)(4)(5) | 40.0 | 8 | 0.300 | 0.075 | NA | 1 |
| 16 | 188 | 4C | TSM4C197(1)016(2)(3)(4)(5) | 30.0 | 6 | 0.300 | 0.125 | 0.088 | 1 |
| 20 | 88 | 4C | TSM4C886(1)020(2)(3)(4)(5) | 17.6 | 6 | 0.300 | 0.100 | NA | 1 |
| 25 | 60 | 4C | TSM4C606(1)025(2)(3)(4)(5) | 15.2 | 6 | 0.375 | 0.225 | NA | 1 |
| 35 | 40 | 4C | TSM4C406(1)035(2)(3)(4)(5) | 14.0 | 6 | 0.500 | 0.300 | NA | 1 |
| 6.3 | 1320 | 4D | TSM4D138(1)006(2)(3)(4)(5) | 83.2 | 8 | 0.125 | 0.038 | 0.025 | 1 |
| 10 | 880 | 4D | TSM4D887(1)010(2)(3)(4)(5) | 88.0 | 8 | 0.125 | 0.050 | 0.020 | 1 |
| 16 | 600 | 4D | TSM4D607(1)016(2)(3)(4)(5) | 96.0 | 8 | 0.175 | 0.100 | 0.038 | 1 |
| 20 | 272 | 4D | TSM4D277(1)020(2)(3)(4)(5) | 54.4 | 8 | 0.175 | 0.050 | 0.038 | 1 |
| 25 | 188 | 4D | TSM4D187(1)025(2)(3)(4)(5) | 47.2 | 10 | 0.175 | 0.050 | 0.030 | 1 |
| 35 | 88 | 4D | TSM4D886(1)035(2)(3)(4)(5) | 30.8 | 6 | 0.175 | 0.100 | 0.050 | 1 |
| 50 | 19 | 4D | TSM4D196(1)050(2)(3)(4)(5) | 9.6 | 6 | 0.375 | 0.150 | 0.070 | 1 |
| 10 | 1320 | 4X | TSM4X138(1)010(2)(3)(4)(5) | 132.0 | 10 | 0.125 | 0.025 | 0.013 | 1 |
| 50 | 40 | 4X | TSM4X406(1)050(2)(3)(4)(5) | 20.0 | 6 | 0.175 | 0.100 | NA | 1 |
| V | µF | KEMET/EIA | (See below for part options) | µA @ +20°C Max/5 Min | % @ +20°C 120 Hz Max | Ω @ +20°C 100 kHz Max | Ω @ +20°C 100 kHz Max | Ω @ +20°C 100 kHz Max | Temperature ≤ 260°C |
| Rated Voltage | Rated Cap | Case Code/ Case Size | KEMET Part Number | DC Leakage | DF | Standard ESR | Low ESR | Ultra-low ESR | Moisture Sensitivity |

Table 1D – TSM6 Ratings & Part Number Reference

| Rated Voltage | Rated Cap | Case Code/ Case Size | KEMET Part Number | DC Leakage | DF | Standard ESR | Low ESR | Ultra-low ESR | Moisture Sensitivity |
|---------------|-----------|-------------------------|------------------------------|-------------------------|-------------------------|--------------------------|--------------------------|--------------------------|------------------------|
| V | µF | KEMET/EIA | (See below for part options) | µA @ +20°C Max/5 Min | % @ +20°C 120 Hz Max | Ω @ +20°C 100 kHz Max | Ω @ +20°C 100 kHz Max | Ω @ +20°C 100 kHz Max | Temperature ≤ 260°C |
| 6.3 | 1320 | 6C | TSM6C138(1)006(2)(3)(4)(5) | 83.4 | 10 | 0.200 | 0.050 | 0.038 | |
| 10 | 600 | 6C | TSM6C607(1)010(2)(3)(4)(5) | 60.0 | 8 | 0.200 | 0.050 | NA | |
| 16 | 282 | 6C | TSM6C287(1)016(2)(3)(4)(5) | 45.0 | 6 | 0.200 | 0.083 | 0.058 | |
| 20 | 132 | 6C | TSM6C137(1)020(2)(3)(4)(5) | 26.4 | 6 | 0.200 | 0.067 | NA | |
| 25 | 90 | 6C | TSM6C906(1)025(2)(3)(4)(5) | 22.8 | 6 | 0.250 | 0.150 | NA | |
| 35 | 60 | 6C | TSM6C606(1)035(2)(3)(4)(5) | 21.0 | 6 | 0.333 | 0.200 | NA | |
| 6.3 | 1980 | 6D | TSM6D208(1)006(2)(3)(4)(5) | 124.8 | 8 | 0.083 | 0.025 | 0.017 | |
| 10 | 1320 | 6D | TSM6D138(1)010(2)(3)(4)(5) | 132.0 | 8 | 0.083 | 0.033 | 0.013 | |
| 16 | 900 | 6D | TSM6D907(1)016(2)(3)(4)(5) | 144.0 | 8 | 0.117 | 0.067 | 0.025 | |
| 20 | 408 | 6D | TSM6D417(1)020(2)(3)(4)(5) | 81.6 | 8 | 0.117 | 0.033 | 0.025 | |
| 25 | 282 | 6D | TSM6D287(1)025(2)(3)(4)(5) | 70.8 | 10 | 0.117 | 0.033 | 0.020 | |
| 35 | 132 | 6D | TSM6D137(1)035(2)(3)(4)(5) | 46.2 | 6 | 0.117 | 0.067 | 0.033 | |
| 50 | 28 | 6D | TSM6D286(1)050(2)(3)(4)(5) | 14.4 | 6 | 0.250 | 0.100 | 0.047 | |
| 10 | 1980 | 6X | TSM6X208(1)010(2)(3)(4)(5) | 198.0 | 10 | 0.083 | 0.017 | 0.008 | |
| 50 | 60 | 6X | TSM6X606(1)050(2)(3)(4)(5) | 30.0 | 6 | 0.117 | 0.067 | NA | |
| V | µF | KEMET/EIA | (See below for part options) | µA @ +20°C Max/5 Min | % @ +20°C 120 Hz Max | Ω @ +20°C 100 kHz Max | Ω @ +20°C 100 kHz Max | Ω @ +20°C 100 kHz Max | Temperature ≤ 260°C |
| Rated Voltage | Rated Cap | Case Code/ Case Size | KEMET Part Number | DC Leakage | DF | Standard ESR | Low ESR | Ultra-low ESR | Moisture Sensitivity |

- 1) To complete KEMET part number, insert M for ± 20%, K for ± 10%. Designates Capacitance tolerance.
 - 2) To complete KEMET part number, insert B (0.1%/1,000 hours), C (0.01%/1,000 hours) or A = N/A. Designates Reliability Level.
 - 3) To complete KEMET part number, insert B = Gold Plated, C = Hot solder dipped, H = Solder Plated, or T = 100% Tin (Sn). Designates Termination Finish.
 - 4) To complete KEMET part number, insert 61 = None, 62 = 10 cycles +25°C, 63 = 10 cycles -55°C +85°C after Weibull or 64 = 10 cycles -55°C +85°C before Weibull. Designates Surge current option.
 - 5) To complete KEMET part number, insert 10 = Standard ESR, 20 = Low ESR or 30 = Ultra Low ESR. Designates ESR option.
- Refer to Ordering Information for additional detail.

Recommended Voltage Derating Guidelines



Reverse Voltage

Solid tantalum capacitors are polar devices and may be permanently damaged or destroyed if connected with the wrong polarity. The positive terminal is identified on the capacitor body by a stripe plus in some cases a beveled edge. A small degree of transient reverse voltage is permissible for short periods per the table. The capacitors should not be operated continuously in reverse mode, even within these limits.

| Temperature | Permissible Transient Reverse Voltage |
|-------------|---------------------------------------|
| 25°C | 15% of Rated Voltage |
| 85°C | 5% of Rated Voltage |
| 125°C | 1% of Rated Voltage |

Soldering Process

KEMET's families of surface mount capacitors are compatible with wave (single or dual), convection, IR, or vapor phase reflow techniques. Preheating of these components is recommended to avoid extreme thermal stress. KEMET's recommended profile conditions for convection and IR reflow reflect the profile conditions of the IPC/J-STD-020D standard for moisture sensitivity testing. The devices can safely withstand a maximum of three reflow passes at these conditions.

Please note that although the X/7343-43 case size can withstand wave soldering, the tall profile (4.3 mm maximum) dictates care in wave process development.

Hand soldering should be performed with care due to the difficulty in process control. If performed, care should be taken to avoid contact of the soldering iron to the molded case. The iron should be used to heat the solder pad, applying solder between the pad and the termination, until reflow occurs. Once reflow occurs, the iron should be removed immediately. "Wiping" the edges of a chip and heating the top surface is not recommended.

During typical reflow operations, a slight darkening of the gold-colored epoxy may be observed. This slight darkening is normal and not harmful to the product. Marking permanency is not affected by this change.

| Profile Feature | SnPb Assembly | Pb-Free Assembly |
|---|---------------------|---------------------|
| Preheat/Soak | | |
| Temperature Minimum (T_{Smin}) | 100°C | 150°C |
| Temperature Maximum (T_{Smax}) | 150°C | 200°C |
| Time (t_s) from T_{Smin} to T_{Smax} | 60 – 120 seconds | 60 – 120 seconds |
| Ramp-up Rate (T_L to T_p) | 3°C/seconds maximum | 3°C/seconds maximum |
| Liquidous Temperature (T_L) | 183°C | 217°C |
| Time Above Liquidous (t_L) | 60 – 150 seconds | 60 – 150 seconds |
| Peak Temperature (T_p) | 220°C* 235°C** | 250°C* 260°C** |
| Time within 5°C of Maximum Peak Temperature (t_p) | 20 seconds maximum | 30 seconds maximum |
| Ramp-down Rate (T_p to T_L) | 6°C/seconds maximum | 6°C/seconds maximum |
| Time 25°C to Peak Temperature | 6 minutes maximum | 8 minutes maximum |

Note: All temperatures refer to the center of the package, measured on the package body surface that is facing up during assembly reflow.

*Case Size D, E, P, Y, and X

**Case Size A, B, C, H, I, K, M, R, S, T, U, V, W, and Z

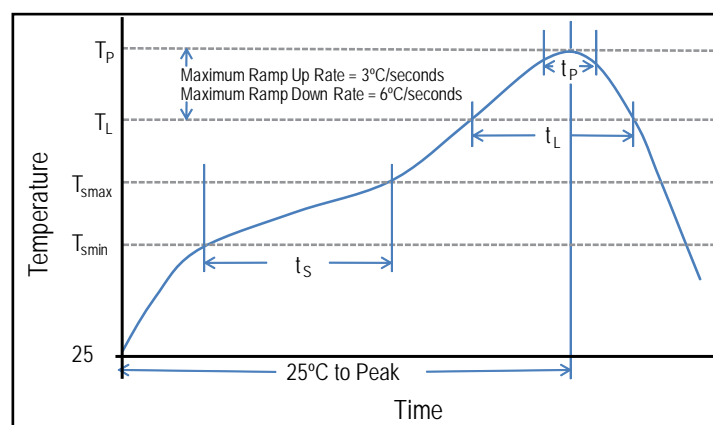

Construction

| Reference | Name | Material |
|-----------|-------------------|-------------------------|
| A | Lead frame | BeCu Alloy 190 |
| B | Lead frame Attach | High Temperature Solder |
| C | Lead Termination | Solder Coated Alloy 752 |



Storage

Tantalum chip capacitors should be stored in normal working environments. While the chips themselves are quite robust in other environments, solderability will be degraded by exposure to high temperatures, high humidity, corrosive atmospheres, and long term storage. In addition, packaging materials will be degraded by high temperature– reels may soften or warp and tape peel force may increase. KEMET recommends that maximum storage temperature not exceed 40°C and maximum storage humidity not exceed 60% relative humidity. Temperature fluctuations should be minimized to avoid condensation on the parts and atmospheres should be free of chlorine and sulphur bearing compounds. For optimized solderability chip stock should be used promptly, preferably within three years of receipt.

Packaging

- Tantalum Stacks Packaging EIA–451 Packaging Material Standards for ESD Sensitive Items
- Antistatic Plastic Trays
- Polyurethane Polyether Foam

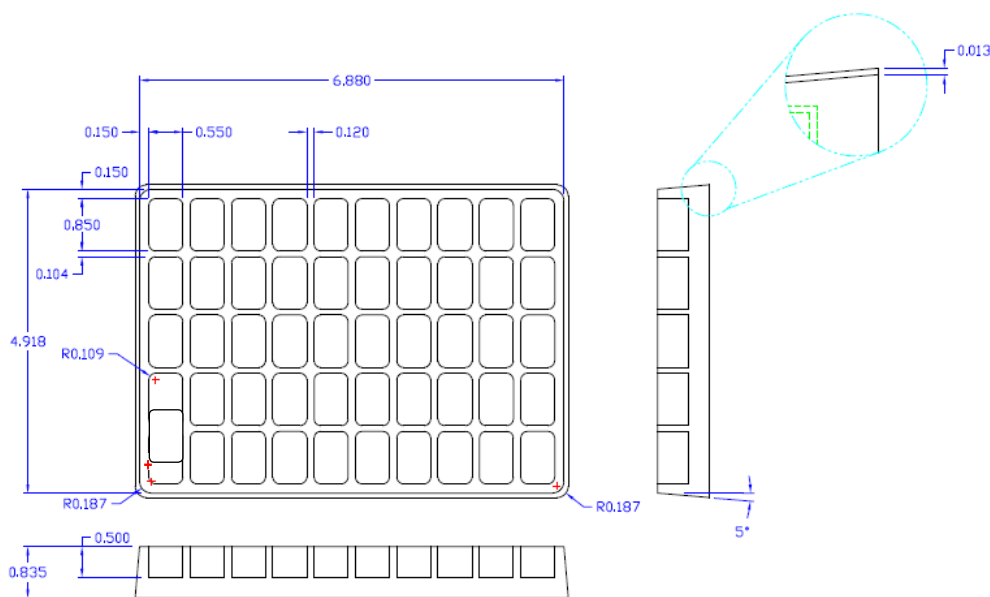

Overview

The KEMET Organic Capacitor (KO-CAP) is a tantalum capacitor with a Ta anode and Ta₂O₅ dielectric. A conductive organic polymer replaces the traditionally used MnO₂ as the cathode plate of the capacitor. This results in very low ESR and improved capacitance retention at high frequency. The KO-CAP also exhibits a benign failure mode which eliminates the ignition failures that can occur in standard MnO₂ tantalum types. KO-CAPs may also be operated at steady state voltages up to 90% of rated voltage for part types with rated voltages of ≤ 10 volts and up to 80% of rated voltage for part types > 10 volts with equivalent or better reliability than traditional MnO₂ tantalum capacitors operated at 50% of rated voltage.

The T520 Series KO-CAP Low ESR Polymer captures the best features of multilayer ceramic (low ESR, high frequency capacitance retention), aluminum electrolytic (higher capacitance, benign failure mode), and proven solid tantalum technology (volumetric efficiency, surface mount capability, extremely long life). The T520 can reduce component counts, eliminate through-hole assembly by replacing cumbersome leaded aluminum capacitors, and offer a cost-effective and space-saving solution.

Benefits

- Extremely low ESR
- -55°C to 105°C operating temperature range
- Polymer cathode technology
- High frequency capacitance retention
- Non-ignition failure mode
- Capacitance up to 1,500 μF
- 100% accelerated steady state aging
- 100% surge current tested
- Taped and reeled per EIA 481-1
- Volumetric efficiency
- Self-healing mechanism
- EIA standard case sizes

Applications

Typical applications include DC/DC converters, notebook PCs, portable electronics, telecommunications (mobile phone and base station), displays, SSD, HDD and USB.



Environmental Compliance

RoHS Compliant (6/6) according to Directive 2002/95/EC when ordered with 100% Sn solder.



RoHS Compliant

SPICE

For a detailed analysis of specific part numbers, please visit www.kemet.com for a free download of KEMET's SPICE software. The KEMET SPICE program is freeware intended to aid design engineers in analyzing the performance of these capacitors over frequency, temperature, ripple, and DC bias conditions.

Ordering Information

| T | 520 | V | 157 | M | 006 | A | T | E045 | |
|-----------------|---------------|---------------------------------------|--|-----------------------|---|---------------------|---|---|------------------------------------|
| Capacitor Class | Series | Case Size | Capacitance Code (pF) | Capacitance Tolerance | Voltage | Failure Rate/Design | Lead Material | ESR Code | Packaging (C-Spec) |
| T = Tantalum | 520 = Polymer | A, B, C, D, H, L, M, T, U, V, W, X, Y | First two digits represent significant figures. Third digit specifies number of zeros. | M = $\pm 20\%$ | 2R5 = 2.5 V 003 = 3 V 004 = 4 V 006 = 6.3 V 008 = 8 V 010 = 10 V 12R = 12.5 V 016 = 16 V 020 = 20 V 025 = 25 V | A = N/A | T = 100% Matte Tin (Sn) Plated H = Tin/Lead (SnPb) Solder Coated (5% Pb minimum) | E = ESR Last three digits specify ESR in m Ω . (045 = 45 m Ω) | Blank = 7" Reel 7280 = 13" Reel |

Performance Characteristics

| Item | Performance Characteristics |
|-------------------------|--|
| Operating Temperature | -55°C to 105°C |
| Rated Capacitance Range | 10 – 1,500 μF @ 120 Hz/25°C |
| Capacitance Tolerance | M Tolerance (20%) |
| Rated Voltage Range | 2.5 – 25 V |
| DF (120 Hz) | $\leq 10\%$ |
| ESR (100 kHz) | Refer to Part Number Electrical Specification Table |
| Leakage Current | ≤ 0.1 CV (μA) at rated voltage after 5 minutes |

Qualification

| Test | Condition | Characteristics | | | | |
|----------------------------|---|-----------------|-----------------------------------|-------|----------|----------|
| Endurance | 105°C @ rated voltage, 2,000 hours | Δ C/C | Within -20%/+10% of initial value | | | |
| | | DF | Within initial limits | | | |
| | | DCL | Within 1.25 x initial limit | | | |
| | | ESR | Within 2.0 x initial limit | | | |
| Storage Life | 105°C @ 0 volts, 2,000 hours | Δ C/C | Within -20%/+10% of initial value | | | |
| | | DF | Within initial limits | | | |
| | | DCL | Within 1.25 x initial limit | | | |
| | | ESR | Within 2.0 x initial limit | | | |
| Humidity | 60°C, 90% RH, 500 hours, rated voltage 60°C, 90% RH, 500 hours, No Load | Δ C/C | Within -5%/+35% of initial value | | | |
| | | DF | Within initial limits | | | |
| | | DCL | Within 5.0 x initial limit | | | |
| | | ESR | Within 2.0 x initial limit | | | |
| Temperature Stability | Extreme temperature exposure at a succession of continuous steps at +25°C, -55°C, +25°C, +85°C, +105°C, +25°C | +25°C | -55°C | +85°C | +105°C | |
| | | Δ C/C | IL* | ±20% | ±20% | ±30% |
| | | DF | IL | IL | 1.2 x IL | 1.5 x IL |
| | | DCL | IL | n/a | 10 x IL | 10 x IL |
| Surge Voltage | 105°C, 1.32 x rated voltage, 1,000 cycles | Δ C/C | Within -20%/+10% of initial value | | | |
| | | DF | Within initial limits | | | |
| | | DCL | Within initial limits | | | |
| | | ESR | Within initial limits | | | |
| Mechanical Shock/Vibration | MIL-STD-202, Method 213, Condition I, 100 G peak. MIL-STD-202, Method 204, Condition D, 10 Hz to 2,000 Hz, 20 G peak | Δ C/C | Within ±10% of initial value | | | |
| | | DF | Within initial limits | | | |
| | | DCL | Within initial limits | | | |

*IL = Initial limit

Electrical Characteristics

ESR vs. Frequency



Capacitance vs. Frequency



Dimensions – Millimeters (Inches)

Metric will govern



| Case Size | | Component | | | | | | | | | | | | | |
|-----------|---------|----------------------------|----------------------------|----------------------------|---------------------|---------------------|--------------------------|----------------------------|------------|------------|-------------|------------|------------|------------|--|
| KEMET | EIA | L* | W* | H* | F* ±0.1 ±(0.004) | S* ±0.3 ±(0.012) | B* ±0.15 (Ref) ±0.006 | X (Ref) | P (Ref) | R (Ref) | T (Ref) | A (Min) | G (Ref) | E (Ref) | |
| A | 3216-18 | 3.2 ±0.2 (0.126 ±0.008) | 1.6 ±0.2 (0.063 ±0.008) | 1.6 ±0.2 (0.063 ±0.008) | 1.2 (.047) | 0.8 (.031) | 0.4 (.016) | 0.10 ±0.10 (.004 ±.004) | 0.4 (.016) | 0.4 (.016) | 0.13 (.005) | 0.8 (.31) | 1.1 (.043) | 1.3 (.051) | |
| B | 3528-21 | 3.5 ±0.2 (0.138 ±0.008) | 2.8 ±0.2 (0.110 ±0.008) | 1.9 ±0.2 (0.075 ±0.008) | 2.2 (.087) | 0.8 (.031) | 0.4 (.016) | 0.10 ±0.10 (.004 ±.004) | 0.5 (.020) | 1.0 (.039) | 0.13 (.005) | 1.1 (.043) | 1.8 (.071) | 2.2 (.087) | |
| C | 6032-28 | 6.0 ±0.3 (0.236 ±0.03) | 3.2 ±0.3 (0.126 ±0.012) | 2.5 ±0.3 (0.098 ±0.012) | 2.2 (.087) | 1.3 (.051) | 0.5 (.020) | 0.10 ±0.10 (.004 ±.004) | 0.9 (.035) | 1.0 (.039) | 0.13 (.005) | 2.5 (.098) | 2.8 (.110) | 2.4 (.094) | |
| D | 7343-31 | 7.3 ±0.3 (0.287 ±0.012) | 4.3 ±0.3 (0.169 ±0.012) | 2.8 ±0.3 (0.110 ±0.012) | 2.4 (.094) | 1.3 (.051) | 0.5 (.020) | 0.10 ±0.10 (.004 ±.004) | 0.9 (.035) | 1.0 (.039) | 0.13 (.005) | 3.8 (.150) | 3.5 (.138) | 3.5 (.138) | |
| H | 7360-20 | 7.3 ±0.3 (0.287 ±0.012) | 6.0 ±0.3 (0.236 ±0.012) | 2.0 (0.078) Maximum | 4.1 (.161) | 1.3 (.051) | n/a | 0.10 ±0.10 (.004 ±.004) | n/a | n/a | 0.13 (.005) | 3.3 (.130) | 3.5 (.138) | 3.5 (.138) | |
| L | 6032-19 | 6.0 ±0.3 (0.236 ±0.012) | 3.2 ±0.2 (0.110 ±0.008) | 1.9 (0.075) | 2.2 (.087) | 1.3 (.051) | n/a | 0.05 (.002) | n/a | n/a | 0.13 (.005) | 2.5 (.098) | 2.8 (.110) | 2.4 (.094) | |
| M | 3528-15 | 3.5 ±0.2 (0.138 ±0.008) | 2.8 ±0.2 (0.110 ±0.008) | 1.5 (0.059) | 2.2 (.087) | 0.8 (.031) | n/a | 0.05 (.002) | n/a | n/a | 0.13 (.005) | 1.1 (.043) | 1.8 (.071) | 2.2 (.087) | |
| T | 3528-12 | 3.5 ±0.2 (0.138 ±0.008) | 2.8 ±0.2 (0.110 ±0.008) | 1.2 (0.047) | 2.2 (.087) | 0.8 (.031) | n/a | 0.05 (.002) | n/a | n/a | 0.13 (.005) | 1.1 (.043) | 1.8 (.071) | 2.2 (.087) | |
| U | 6032-15 | 6.0 ±0.3 (0.236 ±0.012) | 3.2 ±0.2 (0.110 ±0.008) | 1.5 (0.059) | 2.2 (.087) | 1.3 (.051) | n/a | 0.05 (.002) | n/a | n/a | 0.13 (.005) | 2.5 (.098) | 2.8 (.110) | 2.4 (.094) | |
| V | 7343-19 | 7.3 ±0.3 (0.287 ±0.012) | 4.3 ±0.3 (0.169 ±0.012) | 1.9 (0.075) | 2.4 (.094) | 1.3 (.051) | n/a | 0.05 (.002) | n/a | n/a | 0.13 (.005) | 3.8 (.150) | 3.5 (.138) | 3.5 (.138) | |
| W | 7343-15 | 7.3 ±0.3 (0.287 ±0.012) | 4.3 ±0.3 (0.169 ±0.012) | 1.5 (0.059) | 2.4 (.094) | 1.3 (.051) | n/a | 0.05 (.002) | n/a | n/a | 0.13 (.005) | 3.8 (.150) | 3.5 (.138) | 3.5 (.138) | |
| X | 7343-43 | 7.3 ±0.3 (0.287 ±0.012) | 4.3 ±0.3 (0.169 ±0.012) | 4.0 ±0.3 (0.157 ±0.012) | 2.4 (.094) | 1.3 (.051) | 0.5 (.020) | 0.10 ±0.10 (.004 ±.004) | 1.7 (.067) | 1.0 (.039) | 0.13 (.005) | 3.8 (.150) | 3.5 (.138) | 3.5 (.138) | |
| Y | 7343-40 | 7.3 ±0.3 (0.287 ±0.012) | 4.3 ±0.3 (0.169 ±0.012) | 4.0 (0.157) | 2.4 (.094) | 1.3 (.051) | 0.5 (.020) | 0.10 ±0.10 (.004 ±.004) | 1.7 (.067) | 1.0 (.039) | 0.13 (.005) | 3.8 (.150) | 3.5 (.138) | 3.5 (.138) | |

Notes: (Ref) – Dimensions provided for reference only. No dimensions are provided for B, P or R because low profile cases do not have a bevel or a notch.

* MIL-PRF-55365/8 specified dimensions

Table 1 – Ratings & Part Number Reference

| Rated Voltage | Rated Cap | Case Code/ Case Size | KEMET Part Number | DC Leakage | DF | ESR | Maximum Allowable Ripple Current | Moisture Sensitivity | Rated Temp |
|---------------|-----------|-------------------------|------------------------------|-----------------------------------|-------------------------------|---------------------------------|-------------------------------------|-------------------------|------------|
| VDC | µF | KEMET/EIA | (See below for part options) | µA @ 20°C Maximum/5 Minutes | % @ 20°C 120 Hz Maximum | mΩ @ 20°C 100 kHz Maximum | (mA) 45°C 100 kHz | Temperature ≤ 260°C | (°C) |
| 2 | 470 | V/7343-19 | T520V477M002A(1)E040 | 94 | 10 | 40 | 2200 | 3 | 105 |
| 2.5 | 47 | A/3216-18 | T520A476M2R5A(1)E090 | 12 | 8 | 90 | 1100 | 3 | 105 |
| 2.5 | 56 | T/3528-12 | T520T566M2R5A(1)E040 | 14 | 8 | 40 | 1600 | 3 | 105 |
| 2.5 | 56 | T/3528-12 | T520T566M2R5A(1)E070 | 14 | 8 | 70 | 1200 | 3 | 105 |
| 2.5 | 68 | A/3216-18 | T520A686M2R5A(1)E070 | 17 | 8 | 70 | 1300 | 3 | 105 |
| 2.5 | 68 | A/3216-18 | T520A686M2R5A(1)E080 | 17 | 8 | 80 | 1200 | 3 | 105 |
| 2.5 | 100 | T/3528-12 | T520T107M2R5A(1)E040 | 25 | 8 | 40 | 1600 | 3 | 105 |
| 2.5 | 100 | T/3528-12 | T520T107M2R5A(1)E070 | 25 | 8 | 70 | 1200 | 3 | 105 |
| 2.5 | 100 | B/3528-21 | T520B107M2R5A(1)E025 | 25 | 8 | 25 | 2300 | 3 | 105 |
| 2.5 | 100 | B/3528-21 | T520B107M2R5A(1)E035 | 25 | 8 | 35 | 1900 | 3 | 105 |
| 2.5 | 100 | B/3528-21 | T520B107M2R5A(1)E040 | 25 | 8 | 40 | 1800 | 3 | 105 |
| 2.5 | 100 | B/3528-21 | T520B107M2R5A(1)E070 | 25 | 8 | 70 | 1300 | 3 | 105 |
| 2.5 | 150 | U/6032-15 | T520U157M2R5A(1)E055 | 38 | 8 | 55 | 1600 | 3 | 105 |
| 2.5 | 220 | B/3528-21 | T520B227M2R5A(1)E015 | 55 | 8 | 15 | 2900 | 3 | 105 |
| 2.5 | 220 | B/3528-21 | T520B227M2R5A(1)E018 | 55 | 8 | 18 | 2700 | 3 | 105 |
| 2.5 | 220 | B/3528-21 | T520B227M2R5A(1)E021 | 55 | 8 | 21 | 2500 | 3 | 105 |
| 2.5 | 220 | B/3528-21 | T520B227M2R5A(1)E025 | 55 | 8 | 25 | 2300 | 3 | 105 |
| 2.5 | 220 | B/3528-21 | T520B227M2R5A(1)E030 | 55 | 8 | 30 | 2100 | 3 | 105 |
| 2.5 | 220 | B/3528-21 | T520B227M2R5A(1)E035 | 55 | 8 | 35 | 1900 | 3 | 105 |
| 2.5 | 220 | B/3528-21 | T520B227M2R5A(1)E055 | 55 | 8 | 55 | 1500 | 3 | 105 |
| 2.5 | 220 | B/3528-21 | T520B227M2R5A(1)E070 | 55 | 8 | 70 | 1300 | 3 | 105 |
| 2.5 | 220 | U/6032-15 | T520U227M2R5A(1)E055 | 55 | 8 | 55 | 1600 | 3 | 105 |
| 2.5 | 220 | C/6032-28 | T520C227M2R5A(1)E025 | 55 | 8 | 25 | 2600 | 3 | 105 |
| 2.5 | 220 | C/6032-28 | T520C227M2R5A(1)E045 | 55 | 8 | 45 | 1900 | 3 | 105 |
| 2.5 | 220 | W/7343-15 | T520W227M2R5A(1)E025 | 55 | 10 | 25 | 2700 | 3 | 105 |
| 2.5 | 220 | V/7343-19 | T520V227M2R5A(1)E006 | 55 | 10 | 6 | 5600 | 3 | 105 |
| 2.5 | 220 | V/7343-19 | T520V227M2R5A(1)E007 | 55 | 10 | 7 | 5200 | 3 | 105 |
| 2.5 | 220 | V/7343-19 | T520V227M2R5A(1)E009 | 55 | 10 | 9 | 4600 | 3 | 105 |
| 2.5 | 220 | V/7343-19 | T520V227M2R5A(1)E012 | 55 | 10 | 12 | 3900 | 3 | 105 |
| 2.5 | 220 | V/7343-19 | T520V227M2R5A(1)E015 | 55 | 10 | 15 | 3500 | 3 | 105 |
| 2.5 | 220 | V/7343-19 | T520V227M2R5A(1)E025 | 55 | 10 | 25 | 2700 | 3 | 105 |
| 2.5 | 220 | V/7343-19 | T520V227M2R5A(1)E045 | 55 | 10 | 45 | 2000 | 3 | 105 |
| 2.5 | 220 | D/7343-31 | T520D227M2R5A(1)E007 | 55 | 10 | 7 | 5700 | 3 | 105 |
| 2.5 | 220 | D/7343-31 | T520D227M2R5A(1)E040 | 55 | 10 | 40 | 2400 | 3 | 105 |
| 2.5 | 330 | B/3528-21 | T520B337M2R5A(1)E015 | 83 | 8 | 15 | 2900 | 3 | 105 |
| 2.5 | 330 | B/3528-21 | T520B337M2R5A(1)E018 | 83 | 8 | 18 | 2700 | 3 | 105 |
| 2.5 | 330 | B/3528-21 | T520B337M2R5A(1)E035 | 83 | 8 | 35 | 1900 | 3 | 105 |
| 2.5 | 330 | B/3528-21 | T520B337M2R5A(1)E045 | 83 | 8 | 45 | 1700 | 3 | 105 |
| 2.5 | 330 | B/3528-21 | T520B337M2R5A(1)E070 | 83 | 8 | 70 | 1300 | 3 | 105 |
| 2.5 | 330 | C/6032-28 | T520C337M2R5A(1)E015 | 83 | 8 | 15 | 3300 | 3 | 105 |
| 2.5 | 330 | C/6032-28 | T520C337M2R5A(1)E018 | 83 | 8 | 18 | 3000 | 3 | 105 |
| 2.5 | 330 | C/6032-28 | T520C337M2R5A(1)E025 | 83 | 8 | 25 | 2600 | 3 | 105 |
| 2.5 | 330 | C/6032-28 | T520C337M2R5A(1)E045 | 83 | 8 | 45 | 1900 | 3 | 105 |
| 2.5 | 330 | L/6032-19 | T520L337M2R5A(1)E009 | 83 | 8 | 9 | 4100 | 3 | 105 |
| 2.5 | 330 | L/6032-19 | T520L337M2R5A(1)E012 | 83 | 8 | 12 | 3500 | 3 | 105 |
| 2.5 | 330 | L/6032-19 | T520L337M2R5A(1)E025 | 83 | 8 | 25 | 2400 | 3 | 105 |
| 2.5 | 330 | W/7343-15 | T520W337M2R5A(1)E015 | 83 | 10 | 15 | 3500 | 3 | 105 |
| 2.5 | 330 | W/7343-15 | T520W337M2R5A(1)E025 | 83 | 10 | 25 | 2700 | 3 | 105 |
| 2.5 | 330 | W/7343-15 | T520W337M2R5A(1)E040 | 83 | 10 | 40 | 2100 | 3 | 105 |
| 2.5 | 330 | V/7343-19 | T520V337M2R5A(1)E006 | 83 | 10 | 6 | 5600 | 3 | 105 |
| VDC | µF | KEMET/EIA | (See below for part options) | µA @ 20°C Maximum/5 Minutes | % @ 20°C 120 Hz Maximum | mΩ @ 20°C 100 kHz Maximum | (mA) 45°C 100 kHz | Temperature ≤ 260°C | (°C) |
| Rated Voltage | Rated Cap | Case Code/ Case Size | KEMET Part Number | DC Leakage | DF | ESR | Maximum Allowable Ripple Current | Moisture Sensitivity | Rated Temp |

Other part number options:

1- Standard with tin terminations (14th character = T). Tin/lead terminations is also available (14th character = H).

Also available on large (13 inch) reels. Add 7280 to the end of the part number.

Higher voltage ratings and tighter tolerance product including ESR may be substituted within the same size at KEMET's option. Voltage substitutions will be marked with the higher voltage rating. Substitutions can include better than series.

Table 1 – Ratings & Part Number Reference cont'd

| Rated Voltage | Rated Cap | Case Code/ Case Size | KEMET Part Number | DC Leakage | DF | ESR | Maximum Allowable Ripple Current | Moisture Sensitivity | Rated Temp |
|---------------|-----------|-------------------------|------------------------------|-----------------------------------|-------------------------------|---------------------------------|----------------------------------|------------------------|------------|
| VDC | µF | KEMET/EIA | (See below for part options) | µA @ 20°C Maximum/5 Minutes | % @ 20°C 120 Hz Maximum | mΩ @ 20°C 100 kHz Maximum | (mA) 45°C 100 kHz | Temperature ≤ 260°C | (°C) |
| 2.5 | 330 | V/7343-19 | T520V337M2R5A(1)E007 | 83 | 10 | 7 | 5200 | 3 | 105 |
| 2.5 | 330 | V/7343-19 | T520V337M2R5A(1)E009 | 83 | 10 | 9 | 4600 | 3 | 105 |
| 2.5 | 330 | V/7343-19 | T520V337M2R5A(1)E012 | 83 | 10 | 12 | 3900 | 3 | 105 |
| 2.5 | 330 | V/7343-19 | T520V337M2R5A(1)E015 | 83 | 10 | 15 | 3500 | 3 | 105 |
| 2.5 | 330 | V/7343-19 | T520V337M2R5A(1)E018 | 83 | 10 | 18 | 3200 | 3 | 105 |
| 2.5 | 330 | V/7343-19 | T520V337M2R5A(1)E025 | 83 | 10 | 25 | 2700 | 3 | 105 |
| 2.5 | 330 | V/7343-19 | T520V337M2R5A(1)E040 | 83 | 10 | 40 | 2200 | 3 | 105 |
| 2.5 | 330 | D/7343-31 | T520D337M2R5A(1)E006 | 83 | 10 | 6 | 6100 | 3 | 105 |
| 2.5 | 330 | D/7343-31 | T520D337M2R5A(1)E007 | 83 | 10 | 7 | 5700 | 3 | 105 |
| 2.5 | 470 | V/7343-19 | T520V477M2R5A(1)E007 | 118 | 10 | 7 | 5200 | 3 | 105 |
| 2.5 | 470 | V/7343-19 | T520V477M2R5A(1)E009 | 118 | 10 | 9 | 4600 | 3 | 105 |
| 2.5 | 470 | V/7343-19 | T520V477M2R5A(1)E012 | 118 | 10 | 12 | 3900 | 3 | 105 |
| 2.5 | 470 | V/7343-19 | T520V477M2R5A(1)E015 | 118 | 10 | 15 | 3500 | 3 | 105 |
| 2.5 | 470 | V/7343-19 | T520V477M2R5A(1)E018 | 118 | 10 | 18 | 3200 | 3 | 105 |
| 2.5 | 470 | C/6032-28 | T520C477M2R5A(1)E025 | 118 | 8 | 25 | 2600 | 3 | 105 |
| 2.5 | 470 | C/6032-28 | T520C477M2R5A(1)E045 | 118 | 8 | 45 | 1900 | 3 | 105 |
| 2.5 | 470 | D/7343-31 | T520D477M2R5A(1)E006 | 118 | 10 | 6 | 6100 | 3 | 105 |
| 2.5 | 470 | D/7343-31 | T520D477M2R5A(1)E007 | 118 | 10 | 7 | 5700 | 3 | 105 |
| 2.5 | 470 | D/7343-31 | T520D477M2R5A(1)E009 | 118 | 10 | 9 | 5000 | 3 | 105 |
| 2.5 | 680 | D/7343-31 | T520D687M2R5A(1)E010 | 170 | 10 | 10 | 4700 | 3 | 105 |
| 2.5 | 680 | D/7343-31 | T520D687M2R5A(1)E015 | 170 | 10 | 15 | 3900 | 3 | 105 |
| 2.5 | 680 | D/7343-31 | T520D687M2R5A(1)E040 | 170 | 10 | 40 | 2400 | 3 | 105 |
| 2.5 | 680 | Y/7343-40 | T520Y687M2R5A(1)E015 | 170 | 10 | 15 | 4000 | 3 | 105 |
| 2.5 | 680 | Y/7343-40 | T520Y687M2R5A(1)E025 | 170 | 10 | 25 | 3100 | 3 | 105 |
| 2.5 | 1000 | D/7343-31 | T520D108M2R5A(1)E015 | 250 | 10 | 15 | 3900 | 3 | 105 |
| 2.5 | 1000 | D/7343-31 | T520D108M2R5A(1)E030 | 250 | 10 | 30 | 2700 | 3 | 105 |
| 2.5 | 1000 | Y/7343-40 | T520Y108M2R5A(1)E010 | 250 | 10 | 10 | 4900 | 3 | 105 |
| 2.5 | 1000 | Y/7343-40 | T520Y108M2R5A(1)E015 | 250 | 10 | 15 | 4000 | 3 | 105 |
| 2.5 | 1000 | Y/7343-40 | T520Y108M2R5A(1)E025 | 250 | 10 | 25 | 3100 | 3 | 105 |
| 2.5 | 1000 | X/7343-43 | T520X108M2R5A(1)E010 | 250 | 10 | 10 | 5000 | 3 | 105 |
| 3 | 100 | B/3528-21 | T520B107M003A(1)E025 | 30 | 8 | 25 | 2300 | 3 | 105 |
| 3 | 100 | B/3528-21 | T520B107M003A(1)E035 | 30 | 8 | 35 | 1900 | 3 | 105 |
| 3 | 100 | B/3528-21 | T520B107M003A(1)E040 | 30 | 8 | 40 | 1800 | 3 | 105 |
| 3 | 100 | B/3528-21 | T520B107M003A(1)E070 | 30 | 8 | 70 | 1300 | 3 | 105 |
| 3 | 150 | B/3528-21 | T520B157M003A(1)E025 | 45 | 8 | 25 | 2300 | 3 | 105 |
| 3 | 150 | B/3528-21 | T520B157M003A(1)E035 | 45 | 8 | 35 | 1900 | 3 | 105 |
| 3 | 150 | B/3528-21 | T520B157M003A(1)E040 | 45 | 8 | 40 | 1800 | 3 | 105 |
| 3 | 150 | B/3528-21 | T520B157M003A(1)E070 | 45 | 8 | 70 | 1300 | 3 | 105 |
| 3 | 330 | V/7343-19 | T520V337M003A(1)E009 | 99 | 10 | 9 | 4600 | 3 | 105 |
| 3 | 330 | V/7343-19 | T520V337M003A(1)E012 | 99 | 10 | 12 | 3900 | 3 | 105 |
| 3 | 330 | V/7343-19 | T520V337M003A(1)E015 | 99 | 10 | 15 | 3500 | 3 | 105 |
| 3 | 330 | V/7343-19 | T520V337M003A(1)E025 | 99 | 10 | 25 | 2700 | 3 | 105 |
| 3 | 680 | D/7343-31 | T520D687M003A(1)E015 | 204 | 10 | 15 | 3900 | 3 | 105 |
| 3 | 680 | D/7343-31 | T520D687M003A(1)E040 | 204 | 10 | 40 | 2400 | 3 | 105 |
| 3 | 1000 | X/7343-43 | T520X108M003A(1)E015 | 300 | 10 | 15 | 4100 | 3 | 105 |
| 3 | 1000 | X/7343-43 | T520X108M003A(1)E030 | 300 | 10 | 30 | 2900 | 3 | 105 |
| 4 | 15 | T/3528-12 | T520T156M004A(1)E100 | 6 | 8 | 100 | 1000 | 3 | 105 |
| 4 | 33 | A/3216-18 | T520A336M004A(1)E070 | 13 | 8 | 70 | 1300 | 3 | 105 |
| 4 | 33 | A/3216-18 | T520A336M004A(1)E080 | 13 | 8 | 80 | 1200 | 3 | 105 |
| VDC | µF | KEMET/EIA | (See below for part options) | µA @ 20°C Maximum/5 Minutes | % @ 20°C 120 Hz Maximum | mΩ @ 20°C 100 kHz Maximum | (mA) 45°C 100 kHz | Temperature ≤ 260°C | (°C) |
| Rated Voltage | Rated Cap | Case Code/ Case Size | KEMET Part Number | DC Leakage | DF | ESR | Maximum Allowable Ripple Current | Moisture Sensitivity | Rated Temp |

Other part number options:

1- Standard with tin terminations (14th character = T). Tin/lead terminations is also available (14th character = H).

Also available on large (13 inch) reels. Add 7280 to the end of the part number.

Higher voltage ratings and tighter tolerance product including ESR may be substituted within the same size at KEMET's option. Voltage substitutions will be marked with the higher voltage rating. Substitutions can include better than series.

Table 1 – Ratings & Part Number Reference cont'd

| Rated Voltage | Rated Cap | Case Code/ Case Size | KEMET Part Number | DC Leakage | DF | ESR | Maximum Allowable Ripple Current | Moisture Sensitivity | Rated Temp |
|---------------|-----------|-------------------------|------------------------------|-----------------------------------|-------------------------------|---------------------------------|-------------------------------------|-------------------------|------------|
| VDC | µF | KEMET/EIA | (See below for part options) | µA @ 20°C Maximum/5 Minutes | % @ 20°C 120 Hz Maximum | mΩ @ 20°C 100 kHz Maximum | (mA) 45°C 100 kHz | Temperature ≤ 260°C | (°C) |
| 4 | 47 | A/3216-18 | T520A476M004A(1)E070 | 19 | 8 | 70 | 1300 | 3 | 105 |
| 4 | 47 | A/3216-18 | T520A476M004A(1)E080 | 19 | 8 | 80 | 1200 | 3 | 105 |
| 4 | 47 | T/3528-12 | T520T476M004A(1)E070 | 19 | 8 | 70 | 1200 | 3 | 105 |
| 4 | 68 | T/3528-12 | T520T686M004A(1)E070 | 27 | 8 | 70 | 1200 | 3 | 105 |
| 4 | 68 | B/3528-21 | T520B686M004A(1)E025 | 27 | 8 | 25 | 2300 | 3 | 105 |
| 4 | 68 | B/3528-21 | T520B686M004A(1)E035 | 27 | 8 | 35 | 1900 | 3 | 105 |
| 4 | 68 | B/3528-21 | T520B686M004A(1)E040 | 27 | 8 | 40 | 1800 | 3 | 105 |
| 4 | 68 | B/3528-21 | T520B686M004A(1)E070 | 27 | 8 | 70 | 1300 | 3 | 105 |
| 4 | 68 | U/6032-15 | T520U686M004A(1)E055 | 27 | 8 | 55 | 1600 | 3 | 105 |
| 4 | 100 | A/3216-18 | T520A107M004A(1)E150 | 40 | 8 | 150 | 900 | 3 | 105 |
| 4 | 100 | A/3216-18 | T520A107M004A(1)E200 | 40 | 8 | 200 | 700 | 3 | 105 |
| 4 | 100 | T/3528-12 | T520T107M004A(1)E070 | 40 | 8 | 70 | 1200 | 3 | 105 |
| 4 | 100 | T/3528-12 | T520T107M004A(1)E150 | 40 | 8 | 150 | 800 | 3 | 105 |
| 4 | 100 | B/3528-21 | T520B107M004A(1)E025 | 40 | 8 | 25 | 2300 | 3 | 105 |
| 4 | 100 | B/3528-21 | T520B107M004A(1)E035 | 40 | 8 | 35 | 1900 | 3 | 105 |
| 4 | 100 | B/3528-21 | T520B107M004A(1)E040 | 40 | 8 | 40 | 1800 | 3 | 105 |
| 4 | 100 | B/3528-21 | T520B107M004A(1)E070 | 40 | 8 | 70 | 1300 | 3 | 105 |
| 4 | 100 | U/6032-15 | T520U107M004A(1)E055 | 40 | 8 | 55 | 1600 | 3 | 105 |
| 4 | 150 | B/3528-21 | T520B157M004A(1)E015 | 60 | 8 | 15 | 2900 | 3 | 105 |
| 4 | 150 | B/3528-21 | T520B157M004A(1)E018 | 60 | 8 | 18 | 2700 | 3 | 105 |
| 4 | 150 | B/3528-21 | T520B157M004A(1)E025 | 60 | 8 | 25 | 2300 | 3 | 105 |
| 4 | 150 | B/3528-21 | T520B157M004A(1)E030 | 60 | 8 | 30 | 2100 | 3 | 105 |
| 4 | 150 | B/3528-21 | T520B157M004A(1)E035 | 60 | 8 | 35 | 1900 | 3 | 105 |
| 4 | 150 | B/3528-21 | T520B157M004A(1)E040 | 60 | 8 | 40 | 1800 | 3 | 105 |
| 4 | 150 | B/3528-21 | T520B157M004A(1)E070 | 60 | 8 | 70 | 1300 | 3 | 105 |
| 4 | 150 | U/6032-15 | T520U157M004A(1)E055 | 60 | 8 | 55 | 1600 | 3 | 105 |
| 4 | 150 | C/6032-28 | T520C157M004A(1)E015 | 60 | 8 | 15 | 3300 | 3 | 105 |
| 4 | 150 | C/6032-28 | T520C157M004A(1)E025 | 60 | 8 | 25 | 2600 | 3 | 105 |
| 4 | 150 | C/6032-28 | T520C157M004A(1)E045 | 60 | 8 | 45 | 1900 | 3 | 105 |
| 4 | 150 | C/6032-28 | T520C157M004A(1)E100 | 60 | 8 | 100 | 1300 | 3 | 105 |
| 4 | 150 | V/7343-19 | T520V157M004A(1)E007 | 60 | 10 | 7 | 5200 | 3 | 105 |
| 4 | 150 | V/7343-19 | T520V157M004A(1)E009 | 60 | 10 | 9 | 4600 | 3 | 105 |
| 4 | 150 | V/7343-19 | T520V157M004A(1)E012 | 60 | 10 | 12 | 3900 | 3 | 105 |
| 4 | 150 | V/7343-19 | T520V157M004A(1)E015 | 60 | 10 | 15 | 3500 | 3 | 105 |
| 4 | 150 | V/7343-19 | T520V157M004A(1)E025 | 60 | 10 | 25 | 2700 | 3 | 105 |
| 4 | 150 | D/7343-31 | T520D157M004A(1)E007 | 60 | 10 | 7 | 5700 | 3 | 105 |
| 4 | 220 | B/3528-21 | T520B227M004A(1)E035 | 88 | 8 | 35 | 1900 | 3 | 105 |
| 4 | 220 | B/3528-21 | T520B227M004A(1)E045 | 88 | 8 | 45 | 1700 | 3 | 105 |
| 4 | 220 | B/3528-21 | T520B227M004A(1)E070 | 88 | 8 | 70 | 1300 | 3 | 105 |
| 4 | 220 | C/6032-28 | T520C227M004A(1)E015 | 88 | 8 | 15 | 3300 | 3 | 105 |
| 4 | 220 | C/6032-28 | T520C227M004A(1)E018 | 88 | 8 | 18 | 3000 | 3 | 105 |
| 4 | 220 | C/6032-28 | T520C227M004A(1)E025 | 88 | 8 | 25 | 2600 | 3 | 105 |
| 4 | 220 | C/6032-28 | T520C227M004A(1)E045 | 88 | 8 | 45 | 1900 | 3 | 105 |
| 4 | 220 | C/6032-28 | T520C227M004A(1)E055 | 88 | 8 | 55 | 1700 | 3 | 105 |
| 4 | 220 | L/6032-19 | T520L227M004A(1)E012 | 88 | 8 | 12 | 3500 | 3 | 105 |
| 4 | 220 | L/6032-19 | T520L227M004A(1)E025 | 88 | 8 | 25 | 2400 | 3 | 105 |
| 4 | 220 | W/7343-15 | T520W227M004A(1)E025 | 88 | 10 | 25 | 2700 | 3 | 105 |
| 4 | 220 | W/7343-15 | T520W227M004A(1)E040 | 88 | 10 | 40 | 2100 | 3 | 105 |
| 4 | 220 | V/7343-19 | T520V227M004A(1)E006 | 88 | 10 | 6 | 5600 | 3 | 105 |
| 4 | 220 | V/7343-19 | T520V227M004A(1)E007 | 88 | 10 | 7 | 5200 | 3 | 105 |
| 4 | 220 | V/7343-19 | T520V227M004A(1)E009 | 88 | 10 | 9 | 4600 | 3 | 105 |
| VDC | µF | KEMET/EIA | (See below for part options) | µA @ 20°C Maximum/5 Minutes | % @ 20°C 120 Hz Maximum | mΩ @ 20°C 100 kHz Maximum | (mA) 45°C 100 kHz | Temperature ≤ 260°C | (°C) |
| Rated Voltage | Rated Cap | Case Code/ Case Size | KEMET Part Number | DC Leakage | DF | ESR | Maximum Allowable Ripple Current | Moisture Sensitivity | Rated Temp |

Other part number options:

1- Standard with tin terminations (14th character = T). Tin/lead terminations is also available (14th character = H).

Also available on large (13 inch) reels. Add 7280 to the end of the part number.

Higher voltage ratings and tighter tolerance product including ESR may be substituted within the same size at KEMET's option. Voltage substitutions will be marked with the higher voltage rating. Substitutions can include better than series.

Table 1 – Ratings & Part Number Reference cont'd

| Rated Voltage | Rated Cap | Case Code/ Case Size | KEMET Part Number | DC Leakage | DF | ESR | Maximum Allowable Ripple Current | Moisture Sensitivity | Rated Temp |
|---------------|-----------|-------------------------|------------------------------|-----------------------------------|-------------------------------|---------------------------------|-------------------------------------|-------------------------|------------|
| VDC | µF | KEMET/EIA | (See below for part options) | µA @ 20°C Maximum/5 Minutes | % @ 20°C 120 Hz Maximum | mΩ @ 20°C 100 kHz Maximum | (mA) 45°C 100 kHz | Temperature ≤ 260°C | (°C) |
| 4 | 220 | V/7343-19 | T520V227M004A(1)E012 | 88 | 10 | 12 | 3900 | 3 | 105 |
| 4 | 220 | V/7343-19 | T520V227M004A(1)E015 | 88 | 10 | 15 | 3500 | 3 | 105 |
| 4 | 220 | V/7343-19 | T520V227M004A(1)E018 | 88 | 10 | 18 | 3200 | 3 | 105 |
| 4 | 220 | V/7343-19 | T520V227M004A(1)E025 | 88 | 10 | 25 | 2700 | 3 | 105 |
| 4 | 220 | V/7343-19 | T520V227M004A(1)E040 | 88 | 10 | 40 | 2200 | 3 | 105 |
| 4 | 220 | V/7343-19 | T520V227M004A(1)E045 | 88 | 10 | 45 | 2000 | 3 | 105 |
| 4 | 220 | D/7343-31 | T520D227M004A(1)E006 | 88 | 10 | 6 | 6100 | 3 | 105 |
| 4 | 220 | D/7343-31 | T520D227M004A(1)E007 | 88 | 10 | 7 | 5700 | 3 | 105 |
| 4 | 220 | D/7343-31 | T520D227M004A(1)E012 | 88 | 10 | 12 | 4300 | 3 | 105 |
| 4 | 220 | D/7343-31 | T520D227M004A(1)E065 | 88 | 10 | 65 | 1900 | 3 | 105 |
| 4 | 330 | C/6032-28 | T520C337M004A(1)E025 | 132 | 8 | 25 | 2600 | 3 | 105 |
| 4 | 330 | C/6032-28 | T520C337M004A(1)E045 | 132 | 8 | 45 | 1900 | 3 | 105 |
| 4 | 330 | V/7343-19 | T520V337M004A(1)E007 | 132 | 10 | 7 | 5200 | 3 | 105 |
| 4 | 330 | V/7343-19 | T520V337M004A(1)E009 | 132 | 10 | 9 | 4600 | 3 | 105 |
| 4 | 330 | V/7343-19 | T520V337M004A(1)E012 | 132 | 10 | 12 | 3900 | 3 | 105 |
| 4 | 330 | V/7343-19 | T520V337M004A(1)E018 | 132 | 10 | 18 | 3200 | 3 | 105 |
| 4 | 330 | V/7343-19 | T520V337M004A(1)E025 | 132 | 10 | 25 | 2700 | 3 | 105 |
| 4 | 330 | V/7343-19 | T520V337M004A(1)E040 | 132 | 10 | 40 | 2200 | 3 | 105 |
| 4 | 330 | D/7343-31 | T520D337M004A(1)E006 | 132 | 10 | 6 | 6100 | 3 | 105 |
| 4 | 330 | D/7343-31 | T520D337M004A(1)E007 | 132 | 10 | 7 | 5700 | 3 | 105 |
| 4 | 330 | D/7343-31 | T520D337M004A(1)E009 | 132 | 10 | 9 | 5000 | 3 | 105 |
| 4 | 330 | D/7343-31 | T520D337M004A(1)E012 | 132 | 10 | 12 | 4300 | 3 | 105 |
| 4 | 330 | D/7343-31 | T520D337M004A(1)E015 | 132 | 10 | 15 | 3900 | 3 | 105 |
| 4 | 330 | D/7343-31 | T520D337M004A(1)E040 | 132 | 10 | 40 | 2400 | 3 | 105 |
| 4 | 330 | D/7343-31 | T520D337M004A(1)E045 | 132 | 10 | 45 | 2200 | 3 | 105 |
| 4 | 470 | D/7343-31 | T520D477M004A(1)E010 | 188 | 10 | 10 | 4700 | 3 | 105 |
| 4 | 470 | D/7343-31 | T520D477M004A(1)E012 | 188 | 10 | 12 | 4300 | 3 | 105 |
| 4 | 470 | D/7343-31 | T520D477M004A(1)E015 | 188 | 10 | 15 | 3900 | 3 | 105 |
| 4 | 470 | D/7343-31 | T520D477M004A(1)E018 | 188 | 10 | 18 | 3500 | 3 | 105 |
| 4 | 470 | D/7343-31 | T520D477M004A(1)E025 | 188 | 10 | 25 | 3000 | 3 | 105 |
| 4 | 470 | D/7343-31 | T520D477M004A(1)E040 | 188 | 10 | 40 | 2400 | 3 | 105 |
| 4 | 680 | D/7343-31 | T520D687M004A(1)E012 | 272 | 10 | 12 | 4300 | 3 | 105 |
| 4 | 680 | D/7343-31 | T520D687M004A(1)E015 | 272 | 10 | 15 | 3900 | 3 | 105 |
| 4 | 680 | D/7343-31 | T520D687M004A(1)E025 | 272 | 10 | 25 | 3000 | 3 | 105 |
| 4 | 680 | Y/7343-40 | T520Y687M004A(1)E010 | 272 | 10 | 10 | 4900 | 3 | 105 |
| 4 | 680 | Y/7343-40 | T520Y687M004A(1)E015 | 272 | 10 | 15 | 4000 | 3 | 105 |
| 4 | 680 | Y/7343-40 | T520Y687M004A(1)E025 | 272 | 10 | 25 | 3100 | 3 | 105 |
| 4 | 680 | X/7343-43 | T520X687M004A(1)E010 | 272 | 10 | 10 | 5000 | 3 | 105 |
| 4 | 680 | X/7343-43 | T520X687M004A(1)E015 | 272 | 10 | 15 | 4100 | 3 | 105 |
| 4 | 680 | X/7343-43 | T520X687M004A(1)E035 | 272 | 10 | 35 | 2700 | 3 | 105 |
| 6.3 | 15 | T/3528-12 | T520T156M006A(1)E100 | 9 | 8 | 100 | 1000 | 3 | 105 |
| 6.3 | 22 | A/3216-18 | T520A226M006A(1)E090 | 14 | 8 | 90 | 1100 | 3 | 105 |
| 6.3 | 22 | A/3216-18 | T520A226M006A(1)E100 | 14 | 8 | 100 | 1100 | 3 | 105 |
| 6.3 | 33 | A/3216-18 | T520A336M006A(1)E070 | 21 | 8 | 70 | 1300 | 3 | 105 |
| 6.3 | 33 | A/3216-18 | T520A336M006A(1)E080 | 21 | 8 | 80 | 1200 | 3 | 105 |
| 6.3 | 33 | A/3216-18 | T520A336M006A(1)E120 | 21 | 8 | 120 | 1000 | 3 | 105 |
| 6.3 | 33 | T/3528-12 | T520T336M006A(1)E070 | 21 | 8 | 70 | 1200 | 3 | 105 |
| 6.3 | 33 | B/3528-21 | T520B336M006A(1)E025 | 21 | 8 | 25 | 2300 | 3 | 105 |
| 6.3 | 33 | B/3528-21 | T520B336M006A(1)E035 | 21 | 8 | 35 | 1900 | 3 | 105 |
| 6.3 | 33 | B/3528-21 | T520B336M006A(1)E040 | 21 | 8 | 40 | 1800 | 3 | 105 |
| VDC | µF | KEMET/EIA | (See below for part options) | µA @ 20°C Maximum/5 Minutes | % @ 20°C 120 Hz Maximum | mΩ @ 20°C 100 kHz Maximum | (mA) 45°C 100 kHz | Temperature ≤ 260°C | (°C) |
| Rated Voltage | Rated Cap | Case Code/ Case Size | KEMET Part Number | DC Leakage | DF | ESR | Maximum Allowable Ripple Current | Moisture Sensitivity | Rated Temp |

Other part number options:

1- Standard with tin terminations (14th character = T). Tin/lead terminations is also available (14th character = H).

Also available on large (13 inch) reels. Add 7280 to the end of the part number.

Higher voltage ratings and tighter tolerance product including ESR may be substituted within the same size at KEMET's option. Voltage substitutions will be marked with the higher voltage rating. Substitutions can include better than series.

Table 1 – Ratings & Part Number Reference cont'd

| Rated Voltage | Rated Cap | Case Code/ Case Size | KEMET Part Number | DC Leakage | DF | ESR | Maximum Allowable Ripple Current | Moisture Sensitivity | Rated Temp |
|---------------|-----------|-------------------------|------------------------------|-----------------------------------|-------------------------------|---------------------------------|-------------------------------------|-------------------------|------------|
| VDC | µF | KEMET/EIA | (See below for part options) | µA @ 20°C Maximum/5 Minutes | % @ 20°C 120 Hz Maximum | mΩ @ 20°C 100 kHz Maximum | (mA) 45°C 100 kHz | Temperature ≤ 260°C | (°C) |
| 6.3 | 33 | B/3528-21 | T520B336M006A(1)E070 | 21 | 8 | 70 | 1300 | 3 | 105 |
| 6.3 | 33 | C/6032-28 | T520C336M006A(1)E100 | 21 | 8 | 100 | 1300 | 3 | 105 |
| 6.3 | 47 | A/3216-18 | T520A476M006A(1)E150 | 30 | 8 | 150 | 900 | 3 | 105 |
| 6.3 | 47 | T/3528-12 | T520T476M006A(1)E040 | 30 | 8 | 40 | 1600 | 3 | 105 |
| 6.3 | 47 | T/3528-12 | T520T476M006A(1)E070 | 30 | 8 | 70 | 1200 | 3 | 105 |
| 6.3 | 47 | B/3528-21 | T520B476M006A(1)E025 | 30 | 8 | 25 | 2300 | 3 | 105 |
| 6.3 | 47 | B/3528-21 | T520B476M006A(1)E035 | 30 | 8 | 35 | 1900 | 3 | 105 |
| 6.3 | 47 | B/3528-21 | T520B476M006A(1)E040 | 30 | 8 | 40 | 1800 | 3 | 105 |
| 6.3 | 47 | B/3528-21 | T520B476M006A(1)E070 | 30 | 8 | 70 | 1300 | 3 | 105 |
| 6.3 | 68 | A/3216-18 | T520A686M006A(1)E150 | 43 | 8 | 150 | 900 | 3 | 105 |
| 6.3 | 68 | T/3528-12 | T520T686M006A(1)E070 | 43 | 8 | 70 | 1200 | 3 | 105 |
| 6.3 | 68 | T/3528-12 | T520T686M006A(1)E150 | 43 | 8 | 150 | 800 | 3 | 105 |
| 6.3 | 68 | B/3528-21 | T520B686M006A(1)E025 | 43 | 8 | 25 | 2300 | 3 | 105 |
| 6.3 | 68 | B/3528-21 | T520B686M006A(1)E035 | 43 | 8 | 35 | 1900 | 3 | 105 |
| 6.3 | 68 | B/3528-21 | T520B686M006A(1)E040 | 43 | 8 | 40 | 1800 | 3 | 105 |
| 6.3 | 68 | B/3528-21 | T520B686M006A(1)E070 | 43 | 8 | 70 | 1300 | 3 | 105 |
| 6.3 | 68 | U/6032-15 | T520U686M006A(1)E055 | 43 | 8 | 55 | 1600 | 3 | 105 |
| 6.3 | 68 | U/6032-15 | T520U686M006A(1)E070 | 43 | 8 | 70 | 1400 | 3 | 105 |
| 6.3 | 68 | C/6032-28 | T520C686M006A(1)E100 | 43 | 8 | 100 | 1300 | 3 | 105 |
| 6.3 | 100 | T/3528-12 | T520T107M006A(1)E070 | 63 | 8 | 70 | 1200 | 3 | 105 |
| 6.3 | 100 | B/3528-21 | T520B107M006A(1)E015 | 63 | 8 | 15 | 2900 | 3 | 105 |
| 6.3 | 100 | B/3528-21 | T520B107M006A(1)E018 | 63 | 8 | 18 | 2700 | 3 | 105 |
| 6.3 | 100 | B/3528-21 | T520B107M006A(1)E025 | 63 | 8 | 25 | 2300 | 3 | 105 |
| 6.3 | 100 | B/3528-21 | T520B107M006A(1)E035 | 63 | 8 | 35 | 1900 | 3 | 105 |
| 6.3 | 100 | B/3528-21 | T520B107M006A(1)E040 | 63 | 8 | 40 | 1800 | 3 | 105 |
| 6.3 | 100 | B/3528-21 | T520B107M006A(1)E045 | 63 | 8 | 45 | 1700 | 3 | 105 |
| 6.3 | 100 | B/3528-21 | T520B107M006A(1)E070 | 63 | 8 | 70 | 1300 | 3 | 105 |
| 6.3 | 100 | U/6032-15 | T520U107M006A(1)E055 | 63 | 8 | 55 | 1600 | 3 | 105 |
| 6.3 | 100 | W/7343-15 | T520W107M006A(1)E040 | 63 | 10 | 40 | 2100 | 3 | 105 |
| 6.3 | 100 | V/7343-19 | T520V107M006A(1)E009 | 63 | 10 | 9 | 4600 | 3 | 105 |
| 6.3 | 100 | V/7343-19 | T520V107M006A(1)E012 | 63 | 10 | 12 | 3900 | 3 | 105 |
| 6.3 | 100 | V/7343-19 | T520V107M006A(1)E015 | 63 | 10 | 15 | 3500 | 3 | 105 |
| 6.3 | 100 | V/7343-19 | T520V107M006A(1)E045 | 63 | 10 | 45 | 2000 | 3 | 105 |
| 6.3 | 100 | C/6032-28 | T520C107M006A(1)E025 | 63 | 8 | 25 | 2600 | 3 | 105 |
| 6.3 | 100 | C/6032-28 | T520C107M006A(1)E045 | 63 | 8 | 45 | 1900 | 3 | 105 |
| 6.3 | 120 | B/3528-21 | T520B127M006A(1)E035 | 76 | 8 | 35 | 1900 | 3 | 105 |
| 6.3 | 150 | M/3528-15 | T520M157M006A(1)E070 | 95 | 8 | 70 | 1300 | 3 | 105 |
| 6.3 | 150 | M/3528-15 | T520M157M006A(1)E150 | 95 | 8 | 150 | 900 | 3 | 105 |
| 6.3 | 150 | M/3528-15 | T520M157M006A(1)E200 | 95 | 8 | 200 | 800 | 3 | 105 |
| 6.3 | 150 | B/3528-21 | T520B157M006A(1)E025 | 95 | 8 | 25 | 2300 | 3 | 105 |
| 6.3 | 150 | B/3528-21 | T520B157M006A(1)E035 | 95 | 8 | 35 | 1900 | 3 | 105 |
| 6.3 | 150 | B/3528-21 | T520B157M006A(1)E045 | 95 | 8 | 45 | 1700 | 3 | 105 |
| 6.3 | 150 | B/3528-21 | T520B157M006A(1)E070 | 95 | 8 | 70 | 1300 | 3 | 105 |
| 6.3 | 150 | C/6032-28 | T520C157M006A(1)E015 | 95 | 8 | 15 | 3300 | 3 | 105 |
| 6.3 | 150 | C/6032-28 | T520C157M006A(1)E025 | 95 | 8 | 25 | 2600 | 3 | 105 |
| 6.3 | 150 | C/6032-28 | T520C157M006A(1)E045 | 95 | 8 | 45 | 1900 | 3 | 105 |
| 6.3 | 150 | C/6032-28 | T520C157M006A(1)E055 | 95 | 8 | 55 | 1700 | 3 | 105 |
| 6.3 | 150 | U/6032-15 | T520U157M006A(1)E045 | 95 | 8 | 45 | 1700 | 3 | 105 |
| 6.3 | 150 | U/6032-15 | T520U157M006A(1)E055 | 95 | 8 | 55 | 1600 | 3 | 105 |
| 6.3 | 150 | L/6032-19 | T520L157M006A(1)E012 | 95 | 8 | 12 | 3500 | 3 | 105 |
| 6.3 | 150 | L/6032-19 | T520L157M006A(1)E025 | 95 | 8 | 25 | 2400 | 3 | 105 |
| VDC | µF | KEMET/EIA | (See below for part options) | µA @ 20°C Maximum/5 Minutes | % @ 20°C 120 Hz Maximum | mΩ @ 20°C 100 kHz Maximum | (mA) 45°C 100 kHz | Temperature ≤ 260°C | (°C) |
| Rated Voltage | Rated Cap | Case Code/ Case Size | KEMET Part Number | DC Leakage | DF | ESR | Maximum Allowable Ripple Current | Moisture Sensitivity | Rated Temp |

Other part number options:

1- Standard with tin terminations (14th character = T). Tin/lead terminations is also available (14th character = H).

Also available on large (13 inch) reels. Add 7280 to the end of the part number.

Higher voltage ratings and tighter tolerance product including ESR may be substituted within the same size at KEMET's option. Voltage substitutions will be marked with the higher voltage rating. Substitutions can include better than series.

Table 1 – Ratings & Part Number Reference cont'd

| Rated Voltage | Rated Cap | Case Code/ Case Size | KEMET Part Number | DC Leakage | DF | ESR | Maximum Allowable Ripple Current | Moisture Sensitivity | Rated Temp |
|---------------|-----------|-------------------------|------------------------------|-----------------------------------|-------------------------------|---------------------------------|-------------------------------------|-------------------------|------------|
| VDC | µF | KEMET/EIA | (See below for part options) | µA @ 20°C Maximum/5 Minutes | % @ 20°C 120 Hz Maximum | mΩ @ 20°C 100 kHz Maximum | (mA) 45°C 100 kHz | Temperature ≤ 260°C | (°C) |
| 6.3 | 150 | W/7343-15 | T520W157M006A(1)E025 | 95 | 10 | 25 | 2700 | 3 | 105 |
| 6.3 | 150 | W/7343-15 | T520W157M006A(1)E040 | 95 | 10 | 40 | 2100 | 3 | 105 |
| 6.3 | 150 | V/7343-19 | T520V157M006A(1)E006 | 95 | 10 | 6 | 5600 | 3 | 105 |
| 6.3 | 150 | V/7343-19 | T520V157M006A(1)E007 | 95 | 10 | 7 | 5200 | 3 | 105 |
| 6.3 | 150 | V/7343-19 | T520V157M006A(1)E009 | 95 | 10 | 9 | 4600 | 3 | 105 |
| 6.3 | 150 | V/7343-19 | T520V157M006A(1)E012 | 95 | 10 | 12 | 3900 | 3 | 105 |
| 6.3 | 150 | V/7343-19 | T520V157M006A(1)E015 | 95 | 10 | 15 | 3500 | 3 | 105 |
| 6.3 | 150 | V/7343-19 | T520V157M006A(1)E018 | 95 | 10 | 18 | 3200 | 3 | 105 |
| 6.3 | 150 | V/7343-19 | T520V157M006A(1)E025 | 95 | 10 | 25 | 2700 | 3 | 105 |
| 6.3 | 150 | V/7343-19 | T520V157M006A(1)E040 | 95 | 10 | 40 | 2200 | 3 | 105 |
| 6.3 | 150 | V/7343-19 | T520V157M006A(1)E045 | 95 | 10 | 45 | 2000 | 3 | 105 |
| 6.3 | 150 | D/7343-31 | T520D157M006A(1)E006 | 95 | 10 | 6 | 6100 | 3 | 105 |
| 6.3 | 150 | D/7343-31 | T520D157M006A(1)E007 | 95 | 10 | 7 | 5700 | 3 | 105 |
| 6.3 | 150 | D/7343-31 | T520D157M006A(1)E015 | 95 | 10 | 15 | 3900 | 3 | 105 |
| 6.3 | 150 | D/7343-31 | T520D157M006A(1)E025 | 95 | 10 | 25 | 3000 | 3 | 105 |
| 6.3 | 150 | D/7343-31 | T520D157M006A(1)E055 | 95 | 10 | 55 | 2000 | 3 | 105 |
| 6.3 | 220 | B/3528-21 | T520B227M006A(1)E035 | 139 | 8 | 35 | 1900 | 3 | 105 |
| 6.3 | 220 | B/3528-21 | T520B227M006A(1)E045 | 139 | 8 | 45 | 1700 | 3 | 105 |
| 6.3 | 220 | B/3528-21 | T520B227M006A(1)E070 | 139 | 8 | 70 | 1300 | 3 | 105 |
| 6.3 | 220 | C/6032-28 | T520C227M006A(1)E015 | 139 | 8 | 15 | 3300 | 3 | 105 |
| 6.3 | 220 | C/6032-28 | T520C227M006A(1)E018 | 139 | 8 | 18 | 3000 | 3 | 105 |
| 6.3 | 220 | C/6032-28 | T520C227M006A(1)E025 | 139 | 8 | 25 | 2600 | 3 | 105 |
| 6.3 | 220 | C/6032-28 | T520C227M006A(1)E045 | 139 | 8 | 45 | 1900 | 3 | 105 |
| 6.3 | 220 | V/7343-19 | T520V227M006A(1)E007 | 139 | 10 | 7 | 5200 | 3 | 105 |
| 6.3 | 220 | V/7343-19 | T520V227M006A(1)E009 | 139 | 10 | 9 | 4600 | 3 | 105 |
| 6.3 | 220 | V/7343-19 | T520V227M006A(1)E012 | 139 | 10 | 12 | 3900 | 3 | 105 |
| 6.3 | 220 | V/7343-19 | T520V227M006A(1)E015 | 139 | 10 | 15 | 3500 | 3 | 105 |
| 6.3 | 220 | V/7343-19 | T520V227M006A(1)E018 | 139 | 10 | 18 | 3200 | 3 | 105 |
| 6.3 | 220 | V/7343-19 | T520V227M006A(1)E025 | 139 | 10 | 25 | 2700 | 3 | 105 |
| 6.3 | 220 | V/7343-19 | T520V227M006A(1)E040 | 139 | 10 | 40 | 2200 | 3 | 105 |
| 6.3 | 220 | D/7343-31 | T520D227M006A(1)E006 | 139 | 10 | 6 | 6100 | 3 | 105 |
| 6.3 | 220 | D/7343-31 | T520D227M006A(1)E007 | 139 | 10 | 7 | 5700 | 3 | 105 |
| 6.3 | 220 | D/7343-31 | T520D227M006A(1)E009 | 139 | 10 | 9 | 5000 | 3 | 105 |
| 6.3 | 220 | D/7343-31 | T520D227M006A(1)E015 | 139 | 10 | 15 | 3900 | 3 | 105 |
| 6.3 | 220 | D/7343-31 | T520D227M006A(1)E018 | 139 | 10 | 18 | 3500 | 3 | 105 |
| 6.3 | 220 | D/7343-31 | T520D227M006A(1)E025 | 139 | 10 | 25 | 3000 | 3 | 105 |
| 6.3 | 220 | D/7343-31 | T520D227M006A(1)E040 | 139 | 10 | 40 | 2400 | 3 | 105 |
| 6.3 | 220 | D/7343-31 | T520D227M006A(1)E050 | 139 | 10 | 50 | 2100 | 3 | 105 |
| 6.3 | 330 | V/7343-19 | T520V337M006A(1)E015 | 208 | 10 | 15 | 3500 | 3 | 105 |
| 6.3 | 330 | V/7343-19 | T520V337M006A(1)E018 | 208 | 10 | 18 | 3200 | 3 | 105 |
| 6.3 | 330 | V/7343-19 | T520V337M006A(1)E025 | 208 | 10 | 25 | 2700 | 3 | 105 |
| 6.3 | 330 | V/7343-19 | T520V337M006A(1)E040 | 208 | 10 | 40 | 2200 | 3 | 105 |
| 6.3 | 330 | V/7343-19 | T520V337M006A(1)E045 | 208 | 10 | 45 | 2000 | 3 | 105 |
| 6.3 | 330 | D/7343-31 | T520D337M006A(1)E009 | 208 | 10 | 9 | 5000 | 3 | 105 |
| 6.3 | 330 | D/7343-31 | T520D337M006A(1)E010 | 208 | 10 | 10 | 4700 | 3 | 105 |
| 6.3 | 330 | D/7343-31 | T520D337M006A(1)E015 | 208 | 10 | 15 | 3900 | 3 | 105 |
| 6.3 | 330 | D/7343-31 | T520D337M006A(1)E018 | 208 | 10 | 18 | 3500 | 3 | 105 |
| 6.3 | 330 | D/7343-31 | T520D337M006A(1)E025 | 208 | 10 | 25 | 3000 | 3 | 105 |
| 6.3 | 330 | D/7343-31 | T520D337M006A(1)E040 | 208 | 10 | 40 | 2400 | 3 | 105 |
| 6.3 | 330 | D/7343-31 | T520D337M006A(1)E045 | 208 | 10 | 45 | 2200 | 3 | 105 |
| 6.3 | 330 | Y/7343-40 | T520Y337M006A(1)E010 | 208 | 10 | 10 | 4900 | 3 | 105 |
| VDC | µF | KEMET/EIA | (See below for part options) | µA @ 20°C Maximum/5 Minutes | % @ 20°C 120 Hz Maximum | mΩ @ 20°C 100 kHz Maximum | (mA) 45°C 100 kHz | Temperature ≤ 260°C | (°C) |
| Rated Voltage | Rated Cap | Case Code/ Case Size | KEMET Part Number | DC Leakage | DF | ESR | Maximum Allowable Ripple Current | Moisture Sensitivity | Rated Temp |

Other part number options:

1- Standard with tin terminations (14th character = T). Tin/lead terminations is also available (14th character = H).

Also available on large (13 inch) reels. Add 7280 to the end of the part number.

Higher voltage ratings and tighter tolerance product including ESR may be substituted within the same size at KEMET's option. Voltage substitutions will be marked with the higher voltage rating. Substitutions can include better than series.

Table 1 – Ratings & Part Number Reference cont'd

| Rated Voltage | Rated Cap | Case Code/ Case Size | KEMET Part Number | DC Leakage | DF | ESR | Maximum Allowable Ripple Current | Moisture Sensitivity | Rated Temp |
|---------------|-----------|-------------------------|------------------------------|-----------------------------------|-------------------------------|---------------------------------|-------------------------------------|-------------------------|------------|
| VDC | µF | KEMET/EIA | (See below for part options) | µA @ 20°C Maximum/5 Minutes | % @ 20°C 120 Hz Maximum | mΩ @ 20°C 100 kHz Maximum | (mA) 45°C 100 kHz | Temperature ≤ 260°C | (°C) |
| 6.3 | 330 | Y/7343-40 | T520Y337M006A(1)E015 | 208 | 10 | 15 | 4000 | 3 | 105 |
| 6.3 | 330 | Y/7343-40 | T520Y337M006A(1)E025 | 208 | 10 | 25 | 3100 | 3 | 105 |
| 6.3 | 330 | Y/7343-40 | T520Y337M006A(1)E040 | 208 | 10 | 40 | 2500 | 3 | 105 |
| 6.3 | 470 | W/7343-15 | T520W477M006A(1)E055 | 296 | 10 | 55 | 1800 | 3 | 85 |
| 6.3 | 470 | V/7343-19 | T520V477M006A(1)E055 | 296 | 10 | 55 | 1800 | 3 | 85 |
| 6.3 | 470 | Y/7343-40 | T520Y477M006A(1)E010 | 296 | 10 | 10 | 4900 | 3 | 105 |
| 6.3 | 470 | Y/7343-40 | T520Y477M006A(1)E015 | 296 | 10 | 15 | 4000 | 3 | 105 |
| 6.3 | 470 | Y/7343-40 | T520Y477M006A(1)E018 | 296 | 10 | 18 | 3700 | 3 | 105 |
| 6.3 | 470 | Y/7343-40 | T520Y477M006A(1)E025 | 296 | 10 | 25 | 3100 | 3 | 105 |
| 6.3 | 470 | Y/7343-40 | T520Y477M006A(1)E035 | 296 | 10 | 35 | 2600 | 3 | 105 |
| 6.3 | 470 | D/7343-31 | T520D477M006A(1)E015 | 296 | 10 | 15 | 3900 | 3 | 105 |
| 6.3 | 470 | D/7343-31 | T520D477M006A(1)E025 | 296 | 10 | 25 | 3000 | 3 | 105 |
| 6.3 | 470 | D/7343-31 | T520D477M006A(1)E030 | 296 | 10 | 30 | 2700 | 3 | 105 |
| 6.3 | 470 | X/7343-43 | T520X477M006A(1)E010 | 296 | 10 | 10 | 5000 | 3 | 105 |
| 6.3 | 470 | X/7343-43 | T520X477M006A(1)E018 | 296 | 10 | 18 | 3700 | 3 | 105 |
| 6.3 | 470 | X/7343-43 | T520X477M006A(1)E035 | 296 | 10 | 35 | 2700 | 3 | 105 |
| 6.3 | 470 | X/7343-43 | T520X477M006A(1)E040 | 296 | 10 | 40 | 2500 | 3 | 105 |
| 6.3 | 1000 | H/7260-20 | T520H108M006A(1)E055 | 630 | 20 | 55 | 1800 | 4 | 85 |
| 6.3 | 1500 | H/7260-20 | T520H158M006A(1)E055 | 945 | 20 | 55 | 1800 | 4 | 85 |
| 8 | 33 | T/3528-12 | T520T336M008A(1)E070 | 26 | 8 | 70 | 1200 | 3 | 105 |
| 8 | 33 | T/3528-12 | T520T336M008A(1)E080 | 26 | 8 | 80 | 1100 | 3 | 105 |
| 8 | 33 | B/3528-21 | T520B336M008A(1)E025 | 26 | 8 | 25 | 2300 | 3 | 105 |
| 8 | 33 | B/3528-21 | T520B336M008A(1)E035 | 26 | 8 | 35 | 1900 | 3 | 105 |
| 8 | 33 | B/3528-21 | T520B336M008A(1)E040 | 26 | 8 | 40 | 1800 | 3 | 105 |
| 8 | 33 | B/3528-21 | T520B336M008A(1)E070 | 26 | 8 | 70 | 1300 | 3 | 105 |
| 8 | 33 | U/6032-15 | T520U336M008A(1)E070 | 26 | 8 | 70 | 1400 | 3 | 105 |
| 8 | 47 | B/3528-21 | T520B476M008A(1)E035 | 38 | 8 | 35 | 1900 | 3 | 105 |
| 8 | 47 | B/3528-21 | T520B476M008A(1)E070 | 38 | 8 | 70 | 1300 | 3 | 105 |
| 8 | 82 | C/6032-28 | T520C826M008A(1)E025 | 66 | 8 | 25 | 2600 | 3 | 105 |
| 8 | 82 | C/6032-28 | T520C826M008A(1)E045 | 66 | 8 | 45 | 1900 | 3 | 105 |
| 8 | 150 | D/7343-31 | T520D157M008A(1)E025 | 120 | 10 | 25 | 3000 | 3 | 105 |
| 8 | 150 | D/7343-31 | T520D157M008A(1)E040 | 120 | 10 | 40 | 2400 | 3 | 105 |
| 8 | 150 | D/7343-31 | T520D157M008A(1)E055 | 120 | 10 | 55 | 2000 | 3 | 105 |
| 8 | 150 | V/7343-19 | T520V157M008A(1)E040 | 120 | 10 | 40 | 2200 | 3 | 105 |
| 10 | 10 | A/3216-18 | T520A106M010A(1)E080 | 10 | 8 | 80 | 1200 | 3 | 105 |
| 10 | 15 | A/3216-18 | T520A156M010A(1)E080 | 15 | 8 | 80 | 1200 | 3 | 105 |
| 10 | 22 | A/3216-18 | T520A226M010A(1)E080 | 22 | 8 | 80 | 1200 | 3 | 105 |
| 10 | 33 | T/3528-12 | T520T336M010A(1)E040 | 33 | 8 | 40 | 1600 | 3 | 105 |
| 10 | 33 | T/3528-12 | T520T336M010A(1)E070 | 33 | 8 | 70 | 1200 | 3 | 105 |
| 10 | 33 | T/3528-12 | T520T336M010A(1)E080 | 33 | 8 | 80 | 1100 | 3 | 105 |
| 10 | 33 | B/3528-21 | T520B336M010A(1)E025 | 33 | 8 | 25 | 2300 | 3 | 105 |
| 10 | 33 | B/3528-21 | T520B336M010A(1)E035 | 33 | 8 | 35 | 1900 | 3 | 105 |
| 10 | 33 | B/3528-21 | T520B336M010A(1)E040 | 33 | 8 | 40 | 1800 | 3 | 105 |
| 10 | 33 | B/3528-21 | T520B336M010A(1)E070 | 33 | 8 | 70 | 1300 | 3 | 105 |
| 10 | 33 | U/6032-15 | T520U336M010A(1)E070 | 33 | 8 | 70 | 1400 | 3 | 105 |
| 10 | 47 | B/3528-21 | T520B476M010A(1)E035 | 47 | 8 | 35 | 1900 | 3 | 105 |
| 10 | 47 | B/3528-21 | T520B476M010A(1)E070 | 47 | 8 | 70 | 1300 | 3 | 105 |
| 10 | 47 | U/6032-15 | T520U476M010A(1)E055 | 47 | 8 | 55 | 1600 | 3 | 105 |
| 10 | 47 | C/6032-28 | T520C476M010A(1)E100 | 47 | 8 | 100 | 1300 | 3 | 105 |
| VDC | µF | KEMET/EIA | (See below for part options) | µA @ 20°C Maximum/5 Minutes | % @ 20°C 120 Hz Maximum | mΩ @ 20°C 100 kHz Maximum | (mA) 45°C 100 kHz | Temperature ≤ 260°C | (°C) |
| Rated Voltage | Rated Cap | Case Code/ Case Size | KEMET Part Number | DC Leakage | DF | ESR | Maximum Allowable Ripple Current | Moisture Sensitivity | Rated Temp |

Other part number options:

1- Standard with tin terminations (14th character = T). Tin/lead terminations is also available (14th character = H).

Also available on large (13 inch) reels. Add 7280 to the end of the part number.

Higher voltage ratings and tighter tolerance product including ESR may be substituted within the same size at KEMET's option. Voltage substitutions will be marked with the higher voltage rating. Substitutions can include better than series.

Table 1 – Ratings & Part Number Reference cont'd

| Rated Voltage | Rated Cap | Case Code/ Case Size | KEMET Part Number | DC Leakage | DF | ESR | Maximum Allowable Ripple Current | Moisture Sensitivity | Rated Temp |
|---------------|-----------|-------------------------|------------------------------|-----------------------------------|-------------------------------|---------------------------------|----------------------------------|------------------------|------------|
| VDC | µF | KEMET/EIA | (See below for part options) | µA @ 20°C Maximum/5 Minutes | % @ 20°C 120 Hz Maximum | mΩ @ 20°C 100 kHz Maximum | (mA) 45°C 100 kHz | Temperature ≤ 260°C | (°C) |
| 10 | 68 | U/6032-15 | T520U686M010A(1)E055 | 68 | 8 | 55 | 1600 | 3 | 105 |
| 10 | 68 | W/7343-15 | T520W686M010A(1)E025 | 68 | 10 | 25 | 2700 | 3 | 105 |
| 10 | 68 | W/7343-15 | T520W686M010A(1)E040 | 68 | 10 | 40 | 2100 | 3 | 105 |
| 10 | 68 | C/6032-28 | T520C686M010A(1)E045 | 68 | 8 | 45 | 1900 | 3 | 105 |
| 10 | 68 | V/7343-19 | T520V686M010A(1)E025 | 68 | 10 | 25 | 2700 | 3 | 105 |
| 10 | 68 | V/7343-19 | T520V686M010A(1)E040 | 68 | 10 | 40 | 2200 | 3 | 105 |
| 10 | 68 | V/7343-19 | T520V686M010A(1)E045 | 68 | 10 | 45 | 2000 | 3 | 105 |
| 10 | 68 | V/7343-19 | T520V686M010A(1)E060 | 68 | 10 | 60 | 1800 | 3 | 105 |
| 10 | 68 | V/7343-19 | T520V686M010A(1)E100 | 68 | 10 | 100 | 1400 | 3 | 105 |
| 10 | 68 | D/7343-31 | T520D686M010A(1)E100 | 68 | 10 | 100 | 1500 | 3 | 105 |
| 10 | 100 | C/6032-28 | T520C107M010A(1)E025 | 100 | 8 | 25 | 2600 | 3 | 105 |
| 10 | 100 | C/6032-28 | T520C107M010A(1)E045 | 100 | 8 | 45 | 1900 | 3 | 105 |
| 10 | 100 | L/6032-19 | T520L107M010A(1)E025 | 100 | 8 | 25 | 2400 | 3 | 105 |
| 10 | 100 | W/7343-15 | T520W107M010A(1)E040 | 100 | 10 | 40 | 2100 | 3 | 105 |
| 10 | 100 | V/7343-19 | T520V107M010A(1)E018 | 100 | 10 | 18 | 3200 | 3 | 105 |
| 10 | 100 | V/7343-19 | T520V107M010A(1)E025 | 100 | 10 | 25 | 2700 | 3 | 105 |
| 10 | 100 | V/7343-19 | T520V107M010A(1)E045 | 100 | 10 | 45 | 2000 | 3 | 105 |
| 10 | 100 | V/7343-19 | T520V107M010A(1)E050 | 100 | 10 | 50 | 1900 | 3 | 105 |
| 10 | 100 | D/7343-31 | T520D107M010A(1)E018 | 100 | 10 | 18 | 3500 | 3 | 105 |
| 10 | 100 | D/7343-31 | T520D107M010A(1)E055 | 100 | 10 | 55 | 2000 | 3 | 105 |
| 10 | 100 | D/7343-31 | T520D107M010A(1)E080 | 100 | 10 | 80 | 1700 | 3 | 105 |
| 10 | 150 | C/6032-28 | T520C157M010A(1)E055 | 150 | 8 | 55 | 1700 | 3 | 105 |
| 10 | 150 | V/7343-19 | T520V157M010A(1)E018 | 150 | 10 | 18 | 3200 | 3 | 105 |
| 10 | 150 | V/7343-19 | T520V157M010A(1)E025 | 150 | 10 | 25 | 2700 | 3 | 105 |
| 10 | 150 | V/7343-19 | T520V157M010A(1)E040 | 150 | 10 | 40 | 2200 | 3 | 105 |
| 10 | 150 | D/7343-31 | T520D157M010A(1)E015 | 150 | 10 | 15 | 3900 | 3 | 105 |
| 10 | 150 | D/7343-31 | T520D157M010A(1)E018 | 150 | 10 | 18 | 3500 | 3 | 105 |
| 10 | 150 | D/7343-31 | T520D157M010A(1)E025 | 150 | 10 | 25 | 3000 | 3 | 105 |
| 10 | 150 | D/7343-31 | T520D157M010A(1)E040 | 150 | 10 | 40 | 2400 | 3 | 105 |
| 10 | 150 | D/7343-31 | T520D157M010A(1)E055 | 150 | 10 | 55 | 2000 | 3 | 105 |
| 10 | 150 | Y/7343-40 | T520Y157M010A(1)E015 | 150 | 10 | 15 | 4000 | 3 | 105 |
| 10 | 150 | Y/7343-40 | T520Y157M010A(1)E018 | 150 | 10 | 18 | 3700 | 3 | 105 |
| 10 | 150 | Y/7343-40 | T520Y157M010A(1)E025 | 150 | 10 | 25 | 3100 | 3 | 105 |
| 10 | 220 | V/7343-19 | T520V227M010A(1)E045 | 220 | 10 | 45 | 2000 | 3 | 105 |
| 10 | 220 | V/7343-19 | T520V227M010A(1)E025 | 220 | 10 | 25 | 2700 | 3 | 105 |
| 10 | 220 | D/7343-31 | T520D227M010A(1)E018 | 220 | 10 | 18 | 3500 | 3 | 105 |
| 10 | 220 | D/7343-31 | T520D227M010A(1)E025 | 220 | 10 | 25 | 3000 | 3 | 105 |
| 10 | 220 | D/7343-31 | T520D227M010A(1)E040 | 220 | 10 | 40 | 2400 | 3 | 105 |
| 10 | 220 | Y/7343-40 | T520Y227M010A(1)E040 | 220 | 10 | 40 | 2500 | 3 | 105 |
| 10 | 330 | Y/7343-40 | T520Y337M010A(1)E010 | 330 | 10 | 10 | 4900 | 3 | 105 |
| 10 | 330 | Y/7343-40 | T520Y337M010A(1)E015 | 330 | 10 | 15 | 4000 | 3 | 105 |
| 10 | 330 | Y/7343-40 | T520Y337M010A(1)E035 | 330 | 10 | 35 | 2600 | 3 | 105 |
| 10 | 330 | X/7343-43 | T520X337M010A(1)E010 | 330 | 10 | 10 | 5000 | 3 | 105 |
| 10 | 330 | X/7343-43 | T520X337M010A(1)E025 | 330 | 10 | 25 | 3100 | 3 | 105 |
| 10 | 330 | X/7343-43 | T520X337M010A(1)E040 | 330 | 10 | 40 | 2500 | 3 | 105 |
| 12.5 | 10 | T/3528-12 | T520T106M12RA(1)E150 | 13 | 8 | 150 | 800 | 3 | 105 |
| 12.5 | 15 | T/3528-12 | T520T156M12RA(1)E080 | 19 | 8 | 80 | 1100 | 3 | 105 |
| 16 | 10 | B/3528-21 | T520B106M016A(1)E100 | 16 | 8 | 100 | 1100 | 3 | 105 |
| 16 | 22 | C/6032-28 | T520C226M016A(1)E080 | 35 | 8 | 80 | 1400 | 3 | 105 |
| VDC | µF | KEMET/EIA | (See below for part options) | µA @ 20°C Maximum/5 Minutes | % @ 20°C 120 Hz Maximum | mΩ @ 20°C 100 kHz Maximum | (mA) 45°C 100 kHz | Temperature ≤ 260°C | (°C) |
| Rated Voltage | Rated Cap | Case Code/ Case Size | KEMET Part Number | DC Leakage | DF | ESR | Maximum Allowable Ripple Current | Moisture Sensitivity | Rated Temp |

Other part number options:

1- Standard with tin terminations (14th character = T). Tin/lead terminations is also available (14th character = H).

Also available on large (13 inch) reels. Add 7280 to the end of the part number.

Higher voltage ratings and tighter tolerance product including ESR may be substituted within the same size at KEMET's option. Voltage substitutions will be marked with the higher voltage rating. Substitutions can include better than series.

Table 1 – Ratings & Part Number Reference cont'd

| Rated Voltage | Rated Cap | Case Code/ Case Size | KEMET Part Number | DC Leakage | DF | ESR | Maximum Allowable Ripple Current | Moisture Sensitivity | Rated Temp |
|---------------|-----------|-------------------------|------------------------------|-----------------------------------|-------------------------------|---------------------------------|----------------------------------|------------------------|------------|
| VDC | µF | KEMET/EIA | (See below for part options) | µA @ 20°C Maximum/5 Minutes | % @ 20°C 120 Hz Maximum | mΩ @ 20°C 100 kHz Maximum | (mA) 45°C 100 kHz | Temperature ≤ 260°C | (°C) |
| 16 | 22 | C/6032-28 | T520C226M016A(1)E080 | 35 | 8 | 80 | 1400 | 3 | 105 |
| 16 | 33 | W/7343-15 | T520W336M016A(1)E045 | 53 | 10 | 45 | 2000 | 3 | 105 |
| 16 | 33 | V/7343-19 | T520V336M016A(1)E045 | 53 | 10 | 45 | 2000 | 3 | 105 |
| 16 | 33 | V/7343-19 | T520V336M016A(1)E060 | 53 | 10 | 60 | 1800 | 3 | 105 |
| 16 | 33 | V/7343-19 | T520V336M016A(1)E070 | 53 | 10 | 70 | 1600 | 3 | 105 |
| 16 | 47 | W/7343-15 | T520W476M016A(1)E045 | 75 | 10 | 45 | 2000 | 3 | 105 |
| 16 | 47 | V/7343-19 | T520V476M016A(1)E045 | 75 | 10 | 45 | 2000 | 3 | 105 |
| 16 | 47 | V/7343-19 | T520V476M016A(1)E070 | 75 | 10 | 70 | 1600 | 3 | 105 |
| 16 | 47 | D/7343-31 | T520D476M016A(1)E035 | 75 | 10 | 35 | 2500 | 3 | 105 |
| 16 | 47 | D/7343-31 | T520D476M016A(1)E070 | 75 | 10 | 70 | 1800 | 3 | 105 |
| 16 | 68 | D/7343-31 | T520D686M016A(1)E050 | 109 | 10 | 50 | 2100 | 3 | 105 |
| 16 | 150 | X/7343-43 | T520X157M016A(1)E040 | 240 | 10 | 40 | 2500 | 3 | 105 |
| 20 | 22 | V/7343-19 | T520V226M020A(1)E040 | 44 | 10 | 40 | 2200 | 3 | 105 |
| 20 | 22 | V/7343-19 | T520V226M020A(1)E045 | 44 | 10 | 45 | 2000 | 3 | 105 |
| 20 | 22 | V/7343-19 | T520V226M020A(1)E090 | 44 | 10 | 90 | 1400 | 3 | 105 |
| 25 | 15 | V/7343-19 | T520V156M025A(1)E090 | 38 | 10 | 90 | 1400 | 3 | 105 |
| 25 | 15 | D/7343-31 | T520D156M025A(1)E060 | 38 | 10 | 60 | 1900 | 3 | 105 |
| 25 | 15 | D/7343-31 | T520D156M025A(1)E080 | 38 | 10 | 80 | 1700 | 3 | 105 |
| VDC | µF | KEMET/EIA | (See below for part options) | µA @ 20°C Maximum/5 Minutes | % @ 20°C 120 Hz Maximum | mΩ @ 20°C 100 kHz Maximum | (mA) 45°C 100 kHz | Temperature ≤ 260°C | (°C) |
| Rated Voltage | Rated Cap | Case Code/ Case Size | KEMET Part Number | DC Leakage | DF | ESR | Maximum Allowable Ripple Current | Moisture Sensitivity | Rated Temp |

Other part number options:

(1) Standard with tin terminations (14th character = T). Tin/lead terminations is also available (14th character = H).

Also available on large (13 inch) reels. Add 7280 to the end of the part number.

Higher voltage ratings and tighter tolerance product including ESR may be substituted within the same size at KEMET's option. Voltage substitutions will be marked with the higher voltage rating. Substitutions can include better than series.

Derating Guidelines

| Voltage Rating | Maximum Recommended Steady State Voltage | Maximum Recommended Transient Voltage (1 ms – 1 μs) |
|-----------------------------|--|---|
| -55°C to 105°C | | |
| $2. V \leq V_R \leq 10 V$ | 90% of V_R | V_R |
| $12.5 V \leq V_R \leq 25 V$ | 80% of V_R | V_R |

V_R = Rated Voltage

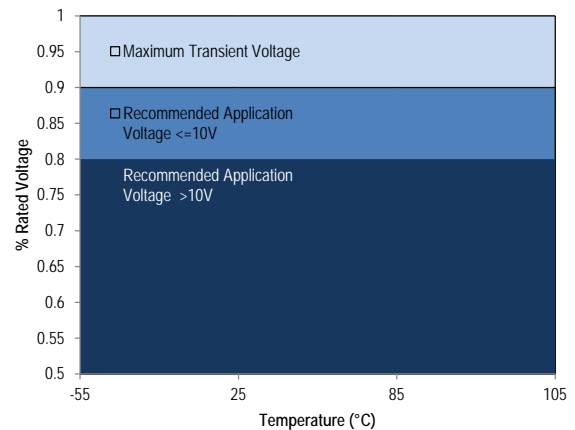

Ripple Current/Ripple Voltage

Permissible AC ripple voltage and current are related to equivalent series resistance (ESR) and the power dissipation capabilities of the device. Permissible AC ripple voltage which may be applied is limited by two criteria:

1. The positive peak AC voltage plus the DC bias voltage, if any, must not exceed the DC voltage rating of the capacitor.
2. The negative peak AC voltage in combination with bias voltage, if any, must not exceed the allowable limits specified for reverse voltage. See the Reverse Voltage section for allowable limits.

The maximum power dissipation by case size can be determined using the table at right. The maximum power dissipation rating stated in the table must be reduced with increasing environmental operating temperatures. Refer to the table below for temperature compensation requirements.

| KEMET Series and Case Code | EIA Case Code | Maximum Power Dissipation (P max) mWatts @ 45°C with +30°C Rise |
|----------------------------|---------------|---|
| T520T | 3528-12 | 105 |
| T520M | 3528-15 | 120 |
| T520A | 3216-18 | 112 |
| T520B | 3528-21 | 127 |
| T520U | 6032-15 | 135 |
| T520L | 3528-19 | 150 |
| T520C | 6032-28 | 165 |
| T520W | 7343-15 | 180 |
| T520V / T522V | 7343-19 | 187 |
| T520D | 7343-31 | 225 |
| T520Y/T522Y | 7343-40 | 241 |
| T520X | 7343-43 | 247 |
| T520H | 7360-20 | 187 |

The maximum power dissipation rating must be reduced with increasing environmental operating temperatures. Refer to the Temperature Compensation Multiplier table for details.

| Temperature Compensation Multipliers for Maximum Power Dissipation | | |
|--|------------------|------------------|
| ≤ 45°C | 45° C < T ≤ 85°C | 85°C < T ≤ 125°C |
| 1.00 | 0.70 | 0.25 |

T = Environmental Temperature

Using the P max of the device, the maximum allowable rms ripple current or voltage may be determined.

$$I(max) = \sqrt{P_{max}/R}$$

$$E(max) = \sqrt{P_{max} \cdot R}$$

I = rms ripple current (amperes)

E = rms ripple voltage (volts)

Reverse Voltage

Polymer tantalum capacitors are polar devices and may be permanently damaged or destroyed if connected in the wrong polarity. These devices will withstand a small degree of transient voltage reversal for short periods as shown in the below table.

| Temperature | Permissible Transient Reverse Voltage |
|-------------|---------------------------------------|
| 25°C | 15% of Rated Voltage |
| 55°C | 10% of Rated Voltage |
| 85°C | 5% of Rated Voltage |
| 105°C | 3% of Rated Voltage |
| 125°C* | 1% of Rated Voltage |

*For series rated to 125°C

Table 2 – Land Dimensions/Courtyard

| KEMET | Metric Size Code | Density Level A: Maximum (Most) Land Protrusion (mm) | | | | | Density Level B: Median (Nominal) Land Protrusion (mm) | | | | | Density Level C: Minimum (Least) Land Protrusion (mm) | | | | |
|----------------|------------------|--|------|------|-------|------|--|------|------|------|------|---|------|------|------|------|
| | | X | Y | C | V1 | V2 | X | Y | C | V1 | V2 | X | Y | C | V1 | V2 |
| Case | EIA | | | | | | | | | | | | | | | |
| A | 3216-18 | 1.35 | 2.15 | 1.45 | 6.10 | 2.80 | 1.25 | 1.75 | 1.35 | 5.00 | 2.30 | 1.15 | 1.35 | 1.25 | 4.10 | 2.00 |
| B | 3528-21 | 2.35 | 2.15 | 1.45 | 6.10 | 4.00 | 2.25 | 1.75 | 1.35 | 5.00 | 3.50 | 2.15 | 1.35 | 1.25 | 4.10 | 3.20 |
| C | 6032-25 | 2.35 | 2.65 | 2.60 | 8.90 | 4.40 | 2.25 | 2.25 | 2.50 | 7.80 | 3.90 | 2.15 | 1.85 | 2.40 | 6.90 | 3.60 |
| D | 7343-31 | 2.55 | 3.75 | 2.70 | 10.20 | 5.50 | 2.45 | 3.35 | 2.60 | 9.10 | 5.00 | 2.35 | 2.95 | 2.50 | 8.20 | 4.70 |
| H | 7360-20 | 4.25 | 2.65 | 3.20 | 10.10 | 7.20 | 4.15 | 2.25 | 3.30 | 9.40 | 6.70 | 4.05 | 1.85 | 3.00 | 8.10 | 6.40 |
| L | 6032-19 | 2.35 | 2.65 | 2.60 | 8.90 | 4.40 | 2.25 | 2.25 | 2.50 | 7.80 | 3.90 | 2.15 | 1.85 | 2.40 | 6.90 | 3.60 |
| M | 3528-15 | 2.35 | 2.15 | 1.45 | 6.10 | 4.00 | 2.25 | 1.75 | 1.35 | 5.00 | 3.70 | 2.15 | 1.35 | 1.25 | 4.10 | 3.40 |
| T | 3528-12 | 2.35 | 2.15 | 1.45 | 6.10 | 4.00 | 2.25 | 1.75 | 1.35 | 5.00 | 3.50 | 2.15 | 1.35 | 1.25 | 4.10 | 3.20 |
| U | 6032-15 | 2.35 | 2.65 | 2.60 | 8.90 | 4.40 | 2.25 | 2.25 | 2.50 | 7.80 | 3.90 | 2.15 | 1.85 | 2.40 | 6.90 | 3.60 |
| V | 7343-19 | 2.55 | 3.75 | 2.70 | 10.20 | 5.50 | 2.45 | 3.35 | 2.60 | 9.10 | 5.00 | 2.35 | 2.95 | 2.50 | 8.20 | 4.70 |
| W | 7343-15 | 2.55 | 3.75 | 2.70 | 10.20 | 5.50 | 2.45 | 3.35 | 2.60 | 9.10 | 5.00 | 2.35 | 2.95 | 2.50 | 8.20 | 4.70 |
| X ¹ | 7343-43 | 2.55 | 3.75 | 2.70 | 10.20 | 5.50 | 2.45 | 3.35 | 2.60 | 9.10 | 5.00 | 2.35 | 2.95 | 2.50 | 8.20 | 4.70 |
| Y ¹ | 7343-40 | 2.55 | 3.75 | 2.70 | 10.20 | 5.50 | 2.45 | 3.35 | 2.60 | 9.10 | 5.00 | 2.35 | 2.95 | 2.50 | 8.20 | 4.70 |

Density Level A: For low-density product applications. Recommended for wave solder applications and provides a wider process window for reflow solder processes.

Density Level B: For products with a moderate level of component density. Provides a robust solder attachment condition for reflow solder processes.

Density Level C: For high component density product applications. Before adapting the minimum land pattern variations the user should perform qualification testing based on the conditions outlined in IPC Standard 7351 (IPC-7351).

¹ Height of these chips may create problems in wave soldering.



Soldering Process

KEMET’s families of surface mount capacitors are compatible with wave (single or dual), convection, IR, or vapor phase reflow techniques. Preheating of these components is recommended to avoid extreme thermal stress. KEMET’s recommended profile conditions for convection and IR reflow reflect the profile conditions of the IPC/J–STD–020D standard for moisture sensitivity testing. The devices can safely withstand a maximum of three reflow passes at these conditions.

Please note that although the X/7343–43 case size can withstand wave soldering, the tall profile (4.3 mm maximum) dictates care in wave process development.

Hand soldering should be performed with care due to the difficulty in process control. If performed, care should be taken to avoid contact of the soldering iron to the molded case. The iron should be used to heat the solder pad, applying solder between the pad and the termination, until reflow occurs. Once reflow occurs, the iron should be removed immediately. “Wiping” the edges of a chip and heating the top surface is not recommended.

During typical reflow operations, a slight darkening of the gold-colored epoxy may be observed. This slight darkening is normal and not harmful to the product. Marking permanency is not affected by this change.

| Profile Feature | SnPb Assembly | Pb-Free Assembly |
|---|---------------------|---------------------|
| Preheat/Soak | | |
| Temperature Minimum (T_{smin}) | 100°C | 150°C |
| Temperature Maximum (T_{smax}) | 150°C | 200°C |
| Time (t_s) from T_{smin} to T_{smax} | 60 – 120 seconds | 60 – 120 seconds |
| Ramp-up Rate (T_L to T_p) | 3°C/seconds maximum | 3°C/seconds maximum |
| Liquidous Temperature (T_L) | 183°C | 217°C |
| Time Above Liquidous (t_L) | 60 – 150 seconds | 60 – 150 seconds |
| Peak Temperature (T_p) | 220°C* 235°C** | 250°C* 260°C** |
| Time within 5°C of Maximum Peak Temperature (t_p) | 20 seconds maximum | 30 seconds maximum |
| Ramp-down Rate (T_p to T_L) | 6°C/seconds maximum | 6°C/seconds maximum |
| Time 25°C to Peak Temperature | 6 minutes maximum | 8 minutes maximum |

Note: All temperatures refer to the center of the package, measured on the package body surface that is facing up during assembly reflow.

*Case Size D, E, P, Y, and X

**Case Size A, B, C, H, I, K, M, R, S, T, U, V, W, and Z



Construction

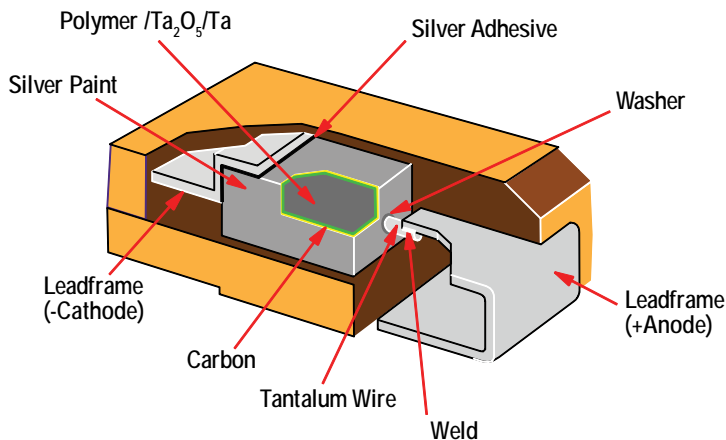

Capacitor Marking



| Date Code * | |
|--|---|
| 1 st digit = Last number of Year | 9 = 2009 0 = 2010 1 = 2011 2 = 2012 3 = 2013 |
| 2 nd and 3 rd digit = Week of the Year | 01 = 1 st week of the Year to 52 = 52 nd week of the Year |

| Date Code* | | |
|------------|---------|---------|
| Year | Month | |
| X = 2009 | 1 = Jan | 7 = Jul |
| A = 2010 | 2 = Feb | 8 = Aug |
| B = 2011 | 3 = Mar | 9 = Spt |
| C = 2012 | 4 = Apr | O = Oct |
| D = 2013 | 5 = May | N = Nov |
| E = 2014 | 6 = Jun | D = Dec |

Storage

All KO-CAP Series are shipped in moisture barrier bags with a desiccant and moisture indicator card. These series are classified as MSL3 (Moisture Sensitivity Level 3). Product contained within the moisture barrier bags should be stored in normal working environments with temperatures not to exceed 40°C and humidity not in excess of 60% RH.

Overview

The KEMET Organic Capacitor (KO-CAP) is a tantalum capacitor with a Ta anode and Ta₂O₅ dielectric. A conductive organic polymer replaces the traditionally used MnO₂ as the cathode plate of the capacitor. This results in very low ESR and improved capacitance retention at high frequency. The KO-CAP also exhibits a benign failure mode which eliminates the ignition failures that can occur in standard MnO₂ tantalum types. KO-CAPs may also be operated at voltages up to 90% of rated voltage for part types with rated voltages of ≤ 10 volts and up to 80% of rated voltage for part types > 10 volts with equivalent or better reliability than traditional MnO₂ tantalum capacitors operated at 50% of rated voltage.

The T521 Series High Voltage Polymer Tantalum is designed for higher application voltages such as 12 V, 24 V, 28 V, and 48 V input rails. This series demonstrates excellent high voltage handling capabilities and reliability and is commonly selected as a replacement for other high capacitance dielectrics such as MnO₂ tantalum and aluminum electrolytic capacitors. The T521 Series can be safely operated at 80% of the rated voltages and can withstand transient conditions up to the rated voltage of the component. This series offers higher capacitance for a given application voltage when compared to multilayer ceramic and tantalum MnO₂ devices. The T521 Series also offers superior ESR performance over tantalum MnO₂ and aluminum electrolytic capacitors and a much lower profile than aluminum polymer and aluminum electrolytic capacitors.

Benefits

- Voltage ratings to 63 V
- Volumetric efficiency
- Stable temperature characteristics
- Up to 330 µF capacitance value
- High ripple current capability
- Low ESR
- High reliability
- Low profile design
- Benign failure mode
- Pb Free when ordered with 100% Sn termination
- RoHS Compliant and Halogen Free

Applications

Typical applications include DC/DC converters, power supply input and higher voltage applications such as 12 V to 50 V power input rails in the military/aerospace and industrial markets.



Environmental Compliance

RoHS Compliant (6/6) according to Directive 2002/95/EC when ordered with 100% Sn solder.



RoHS Compliant

SPICE

For a detailed analysis of specific part numbers, please visit www.kemet.com for a free download of KEMET's SPICE software. The KEMET SPICE program is freeware intended to aid design engineers in analyzing the performance of these capacitors over frequency, temperature, ripple, and DC bias conditions.

Ordering Information

| T | 521 | V | 226 | M | 025 | A | T | E060 | |
|-----------------|----------------------------|------------|--|-----------------------|--|---------------------|---|---|------------------------------------|
| Capacitor Class | Series | Case Size | Capacitance Code (pF) | Capacitance Tolerance | Voltage | Failure Rate/Design | Lead Material | ESR Code | Packaging (C-Spec) |
| T = Tantalum | 521 = High Voltage Polymer | D, V, W, X | First two digits represent significant figures. Third digit specifies number of zeros. | M = $\pm 20\%$ | 016 = 16 V 020 = 20 V 025 = 25 V 035 = 35 V 050 = 50 V 063 = 63 V | A = N/A | T = 100% Matte Tin (Sn) Plated H = Tin/Lead (SnPb) Solder Coated (5% Pb minimum) | E = ESR Last three digits specify ESR in m Ω . (060 = 60 m Ω) | Blank = 7" Reel 7280 = 13" Reel |

Performance Characteristics

| Item | Performance Characteristics |
|-------------------------|--|
| Operating Temperature | -55°C to 105°C/125°C (Refer to part number for maximum temperature rating) |
| Rated Capacitance Range | 15 – 330 μ F @ 120 Hz/25°C |
| Capacitance Tolerance | M Tolerance (20%) |
| Rated Voltage Range | 16 – 63 V |
| DF (120 Hz) | $\leq 10\%$ - Refer to Part Number Electrical Specification Table |
| ESR (100 kHz) | Refer to Part Number Electrical Specification Table |
| Leakage Current | ≤ 0.1 CV (mA) at rated voltage after 5 minutes |

Qualification

| Test | Condition | Characteristics | | | | |
|----------------------------|---|-----------------|-----------------------------------|-------|----------|-------------|
| Endurance | 105°C @ rated voltage, 2,000 hours 125°C @ 2/3 rated voltage, 2,000 hours** | Δ C/C | Within -20%/+10% of initial value | | | |
| | | DF | Within initial limits | | | |
| | | DCL | IL @ 105°C, 2 x IL @ 125°C | | | |
| | | ESR | 2 x Initial Limit | | | |
| Storage Life | 105°C @ 0 volts, 2,000 hours 125°C @ 0 voltage, 2,000 hours** | Δ C/C | Within -20%/+10% of initial value | | | |
| | | DF | Within initial limits | | | |
| | | DCL | IL @ 105°C, 2 x IL @ 125°C | | | |
| | | ESR | 2 x Initial Limit | | | |
| Humidity | 60° C, 90% RH, 500 hours, rated voltage 60° C, 90% RH, 500 hours, No Load | Δ C/C | Within -5%/+35% of initial value | | | |
| | | DF | Within initial limits | | | |
| | | DCL | Within 3.0 x initial limit | | | |
| Temperature Stability | Extreme temperature exposure at a succession of continuous steps at +25°C, -55°C, +25°C, +85°C, +105°/125°C, +25°C | | +25°C | -55°C | +85°C | +105°/125°C |
| | | Δ C/C | IL* | ±20% | ±20% | ±30% |
| | | DF | IL | IL | 1.2 x IL | 1.5 x IL |
| Surge Voltage | 105°C, 1.32 x rated voltage, 33 Ω Resistance, 1,000 cycles | DCL | 10 x IL | | | |
| | | ESR | n/a | | | |
| | | IL | 10 x IL | | | |
| Mechanical Shock/Vibration | MIL-STD-202, Method 213, Condition I, 100 G peak. MIL-STD-202, Method 204, Condition D, 10 Hz to 2,000 Hz, 20 G peak | Δ C/C | Within ±10% of initial value | | | |
| | | DF | Within initial limits | | | |
| | | DCL | Within initial limits | | | |

*IL = Initial limit

**Refer to part number specifications for individual temperature classification.

Electrical Characteristics

ESR vs. Frequency



Capacitance vs. Frequency



Dimensions – Millimeters (Inches)

Metric will govern



| Case Size | | Component | | | | | | | | | | | | |
|-----------|---------|----------------------------|--------------------------|--------------------------|--------------------|--------------------|-------------------------|------------------------------|------------|------------|-------------|------------|------------|------------|
| KEMET | EIA | L* | W* | H* | F* ±0.1 ±(.004) | S* ±0.3 ±(.012) | B* ±0.15 (Ref) ±.006 | X (Ref) | P (Ref) | R (Ref) | T (Ref) | A (Min) | G (Ref) | E (Ref) |
| D | 7343-31 | 7.3 ±0.3 (0.287 ±0.012) | 4.3 ±0.3 (.169 ±.012) | 2.8 ±0.3 (.110 ±.012) | 2.4 (.094) | 1.3 (.051) | 0.5 (.020) | 0.10 ± 0.10 (.004 ± .004) | 0.9 (.035) | 1.0 (.039) | 0.13 (.005) | 3.8 (.150) | 3.5 (.138) | 3.5 (.138) |
| V | 7343-20 | 7.3 ±0.3 (0.287 ±0.012) | 4.3 ±0.3 (.169 ±.012) | 2.0 Maximum | 2.4 (.094) | 1.3 (.051) | n/a | 0.05 (.002) | n/a | n/a | 0.13 (.005) | 3.8 (.150) | 3.5 (.138) | 3.5 (.138) |
| W | 7343-15 | 7.3 ±0.3 (0.287 ±0.012) | 4.3 ±0.3 (.169 ±.012) | 1.5 (.059) | 2.4 (.094) | 1.3 (.051) | n/a | 0.05 (.002) | n/a | n/a | 0.13 (.005) | 3.8 (.150) | 3.5 (.138) | 3.5 (.138) |
| X | 7343-43 | 7.3 ±0.3 (0.287 ±0.012) | 4.3 ±0.3 (.169 ±.012) | 4.0 ±0.3 (.157 ±.012) | 2.4 (.094) | 1.3 (.051) | 0.5 (.020) | 0.10 ± 0.10 (.004 ± .004) | 1.7 (.067) | 1.0 (.039) | 0.13 (.005) | 3.8 (.150) | 3.5 (.138) | 3.5 (.138) |

Notes: (Ref) – Dimensions provided for reference only. No dimensions are provided for B, P or R because low profile cases do not have a bevel or a notch.

* MIL-PRF-55365/8 specified dimensions

Table 1 – Ratings & Part Number Reference

| Rated Voltage | Rated Cap | Case Code/ Case Size | KEMET Part Number | DC Leakage | DF | ESR | Maximum Allowable Ripple Current | Moisture Sensitivity | Rated Temp |
|---------------|-----------|-------------------------|------------------------------|---------------------|--------------------|-----------------------|----------------------------------|----------------------|------------|
| VDC | µF | KEMET/EIA | (See below for part options) | µA @ 20°C Max/5 Min | %@ 20°C 120 Hz Max | mΩ @ 20°C 100 kHz Max | (mA) +45°C 100 kHz | Temp ≤ 260°C | (°C) |
| 16 | 47 | V/7343-20 | T521V476M016A(1)E080 | 75.2 | 10 | 80 | 1500.0 | 3 | 105 |
| 16 | 47 | D/7343-31 | T521D476M016A(1)E045 | 75.2 | 10 | 45 | 2200.0 | 3 | 105 |
| 16 | 47 | D/7343-31 | T521D476M016A(1)E055 | 75.2 | 10 | 55 | 2000.0 | 3 | 105 |
| 16 | 47 | D/7343-31 | T521D476M016A(1)E070 | 75.2 | 10 | 70 | 1800.0 | 3 | 105 |
| 16 | 47 | D/7343-31 | T521D476M016A(1)E090 | 75.2 | 10 | 90 | 1600.0 | 3 | 105 |
| 16 | 68 | V/7343-20 | T521V686M016A(1)E050 | 108.8 | 10 | 50 | 1900.0 | 3 | 105 |
| 16 | 68 | V/7343-20 | T521V686M016A(1)E090 | 108.8 | 10 | 90 | 1400.0 | 3 | 105 |
| 16 | 100 | V/7343-20 | T521V107M016A(1)E050 | 160.0 | 10 | 50 | 1900.0 | 3 | 125 |
| 16 | 100 | D/7343-31 | T521D107M016A(1)E050 | 160.0 | 10 | 50 | 2100.0 | 3 | 105 |
| 16 | 150 | X/7343-43 | T521X157M016A(1)E080 | 240.0 | 10 | 80 | 1800.0 | 3 | 105 |
| 16 | 220 | X/7343-43 | T521X227M016A(1)E035 | 352.0 | 10 | 35 | 2700.0 | 3 | 125 |
| 16 | 220 | X/7343-43 | T521X227M016A(1)E050 | 352.0 | 10 | 50 | 2200.0 | 3 | 125 |
| 16 | 330 | X/7343-43 | T521X337M016A(1)E025 | 528.0 | 10 | 25 | 3100.0 | 3 | 125 |
| 16 | 330 | X/7343-43 | T521X337M016A(1)E050 | 528.0 | 10 | 50 | 2200.0 | 3 | 125 |
| 20 | 47 | V/7343-20 | T521V476M020A(1)E090 | 94.0 | 10 | 90 | 1400.0 | 3 | 125 |
| 20 | 47 | V/7343-20 | T521V476M020A(1)E055 | 94.0 | 10 | 55 | 1800.0 | 3 | 125 |
| 20 | 47 | D/7343-31 | T521D476M020A(1)E055 | 94.0 | 10 | 55 | 2000.0 | 3 | 125 |
| 25 | 15 | V/7343-20 | T521V156M025A(1)E090 | 37.5 | 10 | 90 | 1400.0 | 3 | 105 |
| 25 | 22 | V/7343-20 | T521V226M025A(1)E060 | 55.0 | 10 | 60 | 1800.0 | 3 | 105 |
| 25 | 22 | V/7343-20 | T521V226M025A(1)E090 | 55.0 | 10 | 90 | 1400.0 | 3 | 105 |
| 25 | 33 | V/7343-20 | T521V336M025A(1)E060 | 82.5 | 10 | 60 | 1800.0 | 3 | 105 |
| 25 | 33 | D/7343-31 | T521D336M025A(1)E060 | 82.5 | 10 | 60 | 1900.0 | 3 | 105 |
| 25 | 100 | X/7343-43 | T521X107M025A(1)E060 | 250.0 | 10 | 60 | 2000.0 | 3 | 105 |
| 35 | 15 | V/7343-20 | T521V156M035A(1)E100 | 52.5 | 10 | 100 | 1400.0 | 3 | 125 |
| 35 | 15 | V/7343-20 | T521V156M035A(1)E125 | 52.5 | 10 | 125 | 1200.0 | 3 | 125 |
| 35 | 33 | D/7343-31 | T521D336M035A(1)E065 | 115.5 | 10 | 65 | 1900.0 | 3 | 125 |
| 35 | 47 | X/7343-43 | T521X476M035A(1)E030 | 164.5 | 10 | 30 | 2900.0 | 3 | 125 |
| 35 | 47 | X/7343-43 | T521X476M035A(1)E070 | 164.5 | 10 | 70 | 1900.0 | 3 | 125 |
| 50 | 6.8 | D/7343-31 | T521D685M050A(1)E070 | 34.0 | 10 | 70 | 1800.0 | 3 | 125 |
| 50 | 6.8 | D/7343-31 | T521D685M050A(1)E090 | 34.0 | 10 | 90 | 1600.0 | 3 | 125 |
| 50 | 10 | D/7343-31 | T521D106M050A(1)E090 | 50.0 | 10 | 90 | 1600.0 | 3 | 125 |
| 50 | 10 | D/7343-31 | T521D106M050A(1)E120 | 50.0 | 10 | 120 | 1369.0 | 3 | 125 |
| 50 | 18 | X/7343-43 | T521X186M050A(1)E070 | 90.0 | 10 | 70 | 1900.0 | 3 | 125 |
| 63 | 4.7 | D/7343-31 | T521D475M063A(1)E300 | 29.6 | 10 | 300 | 900.0 | 3 | 125 |
| 63 | 4.7 | D/7343-31 | T521D475M063A(1)E075 | 29.6 | 10 | 75 | 1700.0 | 3 | 125 |
| 63 | 10 | X/7343-43 | T521X106M063A(1)E050 | 35.0 | 10 | 50 | 2200.0 | 3 | 125 |
| 63 | 15 | X/7343-43 | T521X156M063A(1)E035 | 52.5 | 10 | 35 | 2600.0 | 3 | 125 |
| 63 | 15 | X/7343-43 | T521X156M063A(1)E150 | 94.5 | 10 | 150 | 1300.0 | 3 | 125 |
| VDC | µF | KEMET/EIA | (See below for part options) | µA @ 20°C Max/5 Min | %@ 20°C 120 Hz Max | mΩ @ 20°C 100 kHz Max | (mA) +45°C 100 kHz | Temp ≤ 260°C | (°C) |
| Rated Voltage | Rated Cap | Case Code/ Case Size | KEMET Part Number | DC Leakage | DF | ESR | Maximum Allowable Ripple Current | Moisture Sensitivity | Rated Temp |

Other part number options:

1- Standard with tin terminations (14th character = T). Tin/lead terminations is also available (14th character = H).

Also available on large (13 inch) reels. Add 7280 to the end of the part number.

Higher voltage ratings and tighter tolerance product including ESR may be substituted within the same size at KEMET's option. Voltage substitutions will be marked with the higher voltage rating. Substitutions can include better than series.

*Under development

Derating Guidelines

| Voltage Rating | Maximum Recommended Steady State Voltage | Maximum Recommended Transient Voltage (1 ms – 1 μs) |
|------------------------------|--|---|
| -55°C to 105°C | | |
| 16 V ≤ V _R ≤ 63 V | 80% of V _R | V _R |
| 105°C to 125°C | | |
| 16 V ≤ V _R ≤ 63 V | 54% of V _R | 67% of V _R |

V_R = Rated Voltage

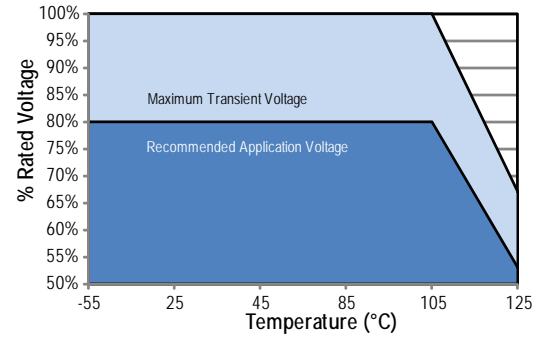

Ripple Current/Ripple Voltage

Permissible AC ripple voltage and current are related to equivalent series resistance (ESR) and the power dissipation capabilities of the device. Permissible AC ripple voltage which may be applied is limited by two criteria:

1. The positive peak AC voltage plus the DC bias voltage, if any, must not exceed the DC voltage rating of the capacitor.
2. The negative peak AC voltage in combination with bias voltage, if any, must not exceed the allowable limits specified for reverse voltage. See the Reverse Voltage section for allowable limits.

The maximum power dissipation by case size can be determined using the table at right. The maximum power dissipation rating stated in the table must be reduced with increasing environmental operating temperatures. Refer to the table below for temperature compensation requirements.

| Temperature Compensation Multipliers for Maximum Power Dissipation | | |
|--|------------------|------------------|
| ≤ 45°C | 45° C < T ≤ 85°C | 85°C < T ≤ 125°C |
| 1.00 | 0.70 | 0.25 |

T = Environmental Temperature

Using the P max of the device, the maximum allowable rms ripple current or voltage may be determined.

$$I(max) = \sqrt{P_{max}/R}$$

$$E(max) = \sqrt{P_{max} \cdot R}$$

I = rms ripple current (amperes)

E = rms ripple voltage (volts)

P max = maximum power dissipation (watts)

R = ESR at specified frequency (ohms)

| Case Code | EIA Case Code | Maximum Power Dissipation (P max) mWatts @ 45°C with +30°C Rise |
|-----------|---------------|---|
| T | 3528-12 | 105 |
| M | 3528-15 | 120 |
| A | 3216-18 | 112 |
| B | 3528-21 | 127 |
| U | 6032-15 | 135 |
| L | 3528-19 | 150 |
| C | 6032-28 | 165 |
| W | 7343-15 | 180 |
| V | 7343-20 | 187 |
| D | 7343-31 | 225 |
| Y | 7343-40 | 241 |
| X | 7343-43 | 247 |
| H | 7360-20 | 187 |
| I | 3216-10 | 95 |

The maximum power dissipation rating must be reduced with increasing environmental operating temperatures. Refer to the Temperature Compensation Multiplier table for details.

Reverse Voltage

Polymer tantalum capacitors are polar devices and may be permanently damaged or destroyed if connected in the wrong polarity. These devices will withstand a small degree of transient voltage reversal for short periods as shown in the below table.

| Temperature | Permissible Transient Reverse Voltage |
|-------------|---------------------------------------|
| 25°C | 15% of Rated Voltage |
| 55°C | 10% of Rated Voltage |
| 85°C | 5% of Rated Voltage |
| 105°C | 3% of Rated Voltage |
| 125°C* | 1% of Rated Voltage |

*For series rated to 125°C

Table 2 – Land Dimensions/Courtyard

| KEMET | Metric Size Code | Density Level A: Maximum (Most) Land Protrusion (mm) | | | | | Density Level B: Median (Nominal) Land Protrusion (mm) | | | | | Density Level C: Minimum (Least) Land Protrusion (mm) | | | | |
|----------------|------------------|--|------|------|-------|------|--|------|------|------|------|---|------|------|------|------|
| | | X | Y | C | V1 | V2 | X | Y | C | V1 | V2 | X | Y | C | V1 | V2 |
| D | 7343-31 | 2.55 | 3.75 | 2.70 | 10.20 | 5.50 | 2.45 | 3.35 | 2.60 | 9.10 | 5.00 | 2.35 | 2.95 | 2.50 | 8.20 | 4.70 |
| V | 7343-20 | 2.55 | 3.75 | 2.70 | 10.20 | 5.50 | 2.45 | 3.35 | 2.60 | 9.10 | 5.00 | 2.35 | 2.95 | 2.50 | 8.20 | 4.70 |
| W | 7343-15 | 2.55 | 3.75 | 2.70 | 10.20 | 5.50 | 2.45 | 3.35 | 2.60 | 9.10 | 5.00 | 2.35 | 2.95 | 2.50 | 8.20 | 4.70 |
| X ¹ | 7343-43 | 2.55 | 3.75 | 2.70 | 10.20 | 5.50 | 2.45 | 3.35 | 2.60 | 9.10 | 5.00 | 2.35 | 2.95 | 2.50 | 8.20 | 4.70 |

Density Level A: For low-density product applications. Recommended for wave solder applications and provides a wider process window for reflow solder processes.

Density Level B: For products with a moderate level of component density. Provides a robust solder attachment condition for reflow solder processes.

Density Level C: For high component density product applications. Before adapting the minimum land pattern variations the user should perform qualification testing based on the conditions outlined in IPC Standard 7351 (IPC-7351).

¹ Height of these chips may create problems in wave soldering.

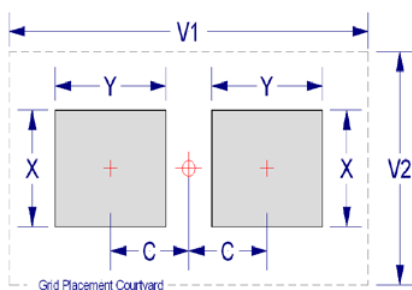

Soldering Process

KEMET’s families of surface mount capacitors are compatible with wave (single or dual), convection, IR, or vapor phase reflow techniques. Preheating of these components is recommended to avoid extreme thermal stress. KEMET’s recommended profile conditions for convection and IR reflow reflect the profile conditions of the IPC/J–STD–020D standard for moisture sensitivity testing. The devices can safely withstand a maximum of three reflow passes at these conditions.

Please note that although the X/7343–43 case size can withstand wave soldering, the tall profile (4.3 mm maximum) dictates care in wave process development.

Hand soldering should be performed with care due to the difficulty in process control. If performed, care should be taken to avoid contact of the soldering iron to the molded case. The iron should be used to heat the solder pad, applying solder between the pad and the termination, until reflow occurs. Once reflow occurs, the iron should be removed immediately. “Wiping” the edges of a chip and heating the top surface is not recommended.

During typical reflow operations, a slight darkening of the gold-colored epoxy may be observed. This slight darkening is normal and not harmful to the product. Marking permanency is not affected by this change.

| Profile Feature | SnPb Assembly | Pb-Free Assembly |
|---|---------------------|---------------------|
| Preheat/Soak | | |
| Temperature Minimum (T_{smin}) | 100°C | 150°C |
| Temperature Maximum (T_{smax}) | 150°C | 200°C |
| Time (t_s) from T_{smin} to T_{smax} | 60 – 120 seconds | 60 – 120 seconds |
| Ramp-up Rate (T_L to T_p) | 3°C/seconds maximum | 3°C/seconds maximum |
| Liquidous Temperature (T_L) | 183°C | 217°C |
| Time Above Liquidous (t_L) | 60 – 150 seconds | 60 – 150 seconds |
| Peak Temperature (T_p) | 220°C* 235°C** | 250°C* 260°C** |
| Time within 5°C of Maximum Peak Temperature (t_p) | 20 seconds maximum | 30 seconds maximum |
| Ramp-down Rate (T_p to T_L) | 6°C/seconds maximum | 6°C/seconds maximum |
| Time 25°C to Peak Temperature | 6 minutes maximum | 8 minutes maximum |

Note: All temperatures refer to the center of the package, measured on the package body surface that is facing up during assembly reflow.

*Case Size D, E, P, Y, and X

**Case Size A, B, C, H, I, K, M, R, S, T, U, V, W, and Z

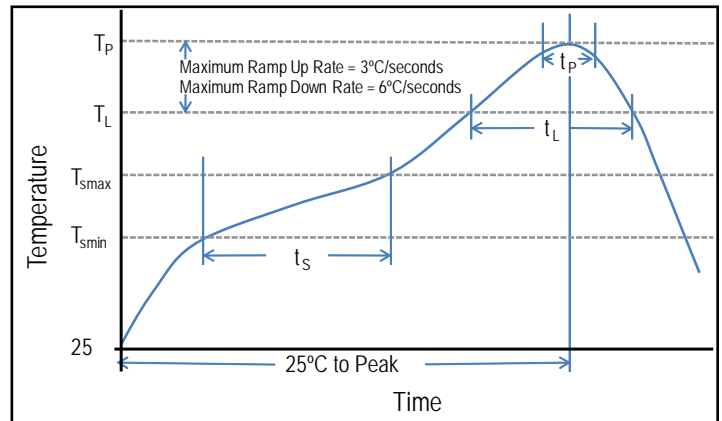

Construction



Capacitor Marking



* 230 = 30th week of 2012

| Date Code * | |
|--|--|
| 1 st digit = Last number of Year | 9 = 2009 0 = 2010 1 = 2011 2 = 2012 3 = 2013 4 = 2014 |
| 2 nd and 3 rd digit = Week of the Year | 01 = 1 st week of the Year to 52 = 52 nd week of the Year |

Storage

All KO-CAP series are shipped in moisture barrier bags with a desiccant and moisture indicator card. These series are classified as MSL3 (Moisture Sensitivity Level 3). Product contained within the moisture barrier bags should be stored in normal working environments with temperatures not to exceed 40°C and humidity not in excess of 60% RH.

Overview

The KEMET Organic Capacitor (KO-CAP) is a tantalum capacitor with a Ta anode and Ta₂O₅ dielectric. A conductive organic polymer replaces the traditionally used MnO₂ as the cathode plate of the capacitor. This results in very low ESR and improved capacitance retention at high frequency. The KO-CAP also exhibits a benign failure mode which eliminates the ignition failures that can occur in standard MnO₂ tantalum types. KO-CAPs may also be operated at steady state voltages up to

90% of rated voltage for part types with rated voltages of ≤ 10.

The T522 Reduced Leakage Polymer Tantalum Series is designed to meet the needs of leakage-sensitive applications such as battery supported circuits. The T522 Series offers the lowest leakage values available in polymer tantalum capacitors with upper leakage limits that are up to 70% lower than other polymer series.

Benefits

- ESR: 25 to 40 mΩ
- -55°C to 105°C operating temperature range
- Polymer cathode technology
- High frequency capacitance retention
- Non-ignition failure mode
- Capacitance: 150 to 470 μF
- Voltage: 6.3 V
- 100% accelerated steady state aging
- 100% surge current tested
- Low profile designs
- Volumetric efficiency
- Self-healing mechanism
- EIA standard case sizes

Applications

Typical applications include battery-dependent applications such as handheld consumer electronics, global tracking systems, energy harvesting, wireless sensors and other applications that seek high capacitance, low profile, safety and low power consumption.



Environmental Compliance

RoHS Compliant (6/6) according to Directive 2002/95/EC when ordered with 100% Sn solder.



RoHS Compliant

SPICE

For a detailed analysis of specific part numbers, please visit www.kemet.com for a free download of KEMET's SPICE software. The KEMET SPICE program is freeware intended to aid design engineers in analyzing the performance of these capacitors over frequency, temperature, ripple, and DC bias conditions.

Ordering Information

| T | 522 | V | 157 | M | 006 | A | T | E025 | |
|-----------------|-------------------------------|-----------|--|-----------------------|-------------|---------------------|---|---|------------------------------------|
| Capacitor Class | Series | Case Size | Capacitance Code (pF) | Capacitance Tolerance | Voltage | Failure Rate/Design | Lead Material | ESR Code | Packaging (C-Spec) |
| T = Tantalum | 520 = Reduced Leakage Polymer | V, Y | First two digits represent significant figures. Third digit specifies number of zeros. | M = ±20% | 006 = 6.3 V | A = N/A | T = 100% Matte Tin (Sn) Plated H = Tin/Lead (SnPb) Solder Coated (5% Pb minimum) | E = ESR Last three digits specify ESR in mΩ. (025 = 25 mΩ) | Blank = 7" Reel 7280 = 13" Reel |

Performance Characteristics

| Item | Performance Characteristics |
|-------------------------|---|
| Operating Temperature | -55°C to 105°C |
| Rated Capacitance Range | 150 – 470 uF @ 120 Hz/25°C |
| Capacitance Tolerance | M Tolerance (20%) |
| Rated Voltage Range | 6.3 V |
| DF (120 Hz) | ≤ 10% |
| ESR (100 kHz) | Refer to Part Number Electrical Specification Table 1 |
| Leakage Current | ≤ 0.03 CV (μA) at rated voltage after 10 minutes |

Qualification

| Test | Condition | Characteristics | | | | |
|----------------------------|---|-----------------|-----------------------------------|-------|----------|----------|
| Endurance | 105°C @ rated voltage, 2,000 hours | Δ C/C | Within -20/+10% of initial value | | | |
| | | DF | Within initial limits | | | |
| | | DCL | Within 1.5 x initial limit | | | |
| | | ESR | Within 2.0 x initial limit | | | |
| Storage Life | 105°C @ 0 volts, 2,000 hours | Δ C/C | Within -20/+10% of initial value | | | |
| | | DF | Within initial limits | | | |
| | | DCL | Within 1.5 x initial limit | | | |
| | | ESR | Within 2.0 x initial limit | | | |
| Humidity | 60° C, 90% RH, 500 hours, rated voltage | Δ C/C | Within -5%/+35% of initial value | | | |
| | | DF | Within initial limits | | | |
| | | DCL | Within 5.0 x initial limit | | | |
| | | ESR | Within 2.0 x initial limit | | | |
| Temperature Stability | Extreme temperature exposure at a succession of continuous steps at +25°C, -55°C, +25°C, +85°C, +105°/125°C, +25°C | +25°C | -55°C | +85°C | +105°C | |
| | | Δ C/C | IL* | ±20% | ±20% | ±30% |
| | | DF | IL | IL | 1.2 x IL | 1.5 x IL |
| | | DCL | IL | n/a | 10 x IL | 10 x IL |
| Surge Voltage | 105°C, 1.32 x rated voltage, 33 Ω Resistance, 1,000 cycles | Δ C/C | Within -20%/+10% of initial value | | | |
| | | DF | Within initial limits | | | |
| | | DCL | Within initial limits | | | |
| | | ESR | Within initial limits | | | |
| Mechanical Shock/Vibration | MIL-STD-202, Method 213, Condition I, 100 G peak. MIL-STD-202, Method 204, Condition D, 10 Hz to 2,000 Hz, 20 G peak | Δ C/C | Within ±10% of initial value | | | |
| | | DF | Within initial limits | | | |
| | | DCL | Within initial limits | | | |

*IL = Initial limit

Electrical Characteristics

Impedance & ESR vs. Frequency



Capacitance vs. Frequency



Dimensions – Millimeters (Inches)

Metric will govern



| Case Size | | Component | | | | | | | | | | | | |
|-----------|---------|------------------------------|------------------------------|-----------------------|----------------------|----------------------|---------------------------|------------------------------|------------|------------|-------------|------------|------------|------------|
| KEMET | EIA | L* | W* | H* | F* ± 0.1 ± (.004) | S* ± 0.3 ± (.012) | B* ± 0.15 (Ref) ± .006 | X (Ref) | P (Ref) | R (Ref) | T (Ref) | A (Min) | G (Ref) | E (Ref) |
| V | 7343-19 | 7.3 ± 0.3 (0.287 ± 0.012) | 4.3 ± 0.3 (0.169 ± 0.012) | 1.9 (.075) | 2.4 (.094) | 1.3 (.051) | n/a | 0.05 (.002) | n/a | n/a | 0.13 (.005) | 3.8 (.150) | 3.5 (.138) | 3.5 (.138) |
| Y | 7343-40 | 7.3 ± 0.3 (0.287 ± 0.012) | 4.3 ± 0.3 (0.169 ± 0.012) | 4.0 (.157) maximum | 2.4 (.094) | 1.3 (.051) | 0.5 (.020) | 0.10 ± 0.10 (.004 ± .004) | 1.7 (.067) | 1.0 (.039) | 0.13 (.005) | 3.8 (.150) | 3.5 (.138) | 3.5 (.138) |

Notes: (Ref) – Dimensions provided for reference only. No dimensions are provided for B, P or R because low profile cases do not have a bevel or a notch.

* MIL-REF-55365/8 specified dimensions

Table 1 – Ratings & Part Number Reference

| Rated Voltage | Rated Cap | Case Code/ Case Size | KEMET Part Number | DC Leakage | DF | ESR | Maximum Allowable Ripple Current | Moisture Sensitivity | Rated Temp |
|---------------|-----------|-------------------------|------------------------------|------------------------|----------------------|------------------------|----------------------------------|----------------------|------------|
| VDC | μF | KEMET/EIA | (See below for part options) | μA @ +20°C Max/10 Min. | % @ +20°C 120 Hz Max | mΩ @ +20°C 100 kHz Max | (mA) +45°C 100 kHz | Temperature ≤ 260°C | (°C) |
| 6.3 | 150 | V/7343-19 | T522V157M006A(1)E025 | 28 | 10 | 25 | 2700 | 3 | 105 |
| 6.3 | 150 | V/7343-19 | T522V157M006A(1)E040 | 28 | 10 | 40 | 2200 | 3 | 105 |
| 6.3 | 220 | V/7343-19 | T522V227M006A(1)E025 | 42 | 10 | 25 | 2700 | 3 | 105 |
| 6.3 | 220 | V/7343-19 | T522V227M006A(1)E040 | 42 | 10 | 40 | 2200 | 3 | 105 |
| 6.3 | 330 | V/7343-19 | T522V337M006A(1)E040 | 62 | 10 | 40 | 2200 | 3 | 105 |
| 6.3 | 470 | Y/7343-40 | T522Y477M006A(1)E035 | 89 | 10 | 35 | 2600 | 3 | 105 |
| VDC | μF | KEMET/EIA | (See below for part options) | μA @ +20°C Max/10 Min. | % @ +20°C 120 Hz Max | mΩ @ +20°C 100 kHz Max | (mA) +45°C 100 kHz | Temperature ≤ 260°C | (°C) |
| Rated Voltage | Rated Cap | Case Code/ Case Size | KEMET Part Number | DC Leakage | DF | ESR | Maximum Allowable Ripple Current | Moisture Sensitivity | Rated Temp |

Other part number options:

(1) Standard with tin terminations (14th character = T). Tin/lead terminations is also available (14th character = H).

Also available on large (13 inch) reels. Add 7280 to the end of the part number.

Higher voltage ratings and tighter tolerance product including ESR may be substituted within the same size at KEMET's option. Voltage substitutions will be marked with the higher voltage rating. Substitutions can include better than series.

Derating Guidelines

| Voltage Rating | Maximum Recommended Steady State Voltage | Maximum Recommended Transient Voltage (1 ms – 1 μs) |
|----------------|--|---|
| -55°C to 105°C | | |
| 6.3 V | 90% of V_R | V_R |

V_R = Rated Voltage



Ripple Current/Ripple Voltage

Permissible AC ripple voltage and current are related to equivalent series resistance (ESR) and the power dissipation capabilities of the device. Permissible AC ripple voltage which may be applied is limited by two criteria:

1. The positive peak AC voltage plus the DC bias voltage, if any, must not exceed the DC voltage rating of the capacitor.
2. The negative peak AC voltage in combination with bias voltage, if any, must not exceed the allowable limits specified for reverse voltage. See the Reverse Voltage section for allowable limits.

The maximum power dissipation by case size can be determined using the table at right. The maximum power dissipation rating stated in the table must be reduced with increasing environmental operating temperatures. Refer to the table below for temperature compensation requirements.

| KEMET Series and Case Code | EIA Case Code | Maximum Power Dissipation (P max) mWatts @ 45°C with +30°C Rise |
|----------------------------|---------------|---|
| T520T | 3528-12 | 105 |
| T520M | 3528-15 | 120 |
| T520A | 3216-18 | 112 |
| T520B | 3528-21 | 127 |
| T520U | 6032-15 | 135 |
| T520L | 3528-19 | 150 |
| T520C | 6032-28 | 165 |
| T520W | 7343-15 | 180 |
| T520V / T522V | 7343-19 | 187 |
| T520D | 7343-31 | 225 |
| T520Y/T522Y | 7343-40 | 241 |
| T520X | 7343-43 | 247 |
| T520H | 7360-20 | 187 |

The maximum power dissipation rating must be reduced with increasing environmental operating temperatures. Refer to the Temperature Compensation Multiplier table for details.

| Temperature Compensation Multipliers for Maximum Power Dissipation | | |
|--|------------------|------------------|
| ≤ 45°C | 45° C < T ≤ 85°C | 85°C < T ≤ 125°C |
| 1.00 | 0.70 | 0.25 |

T = Environmental Temperature

Using the P max of the device, the maximum allowable rms ripple current or voltage may be determined.

$$I(max) = \sqrt{P_{max}/R}$$

$$E(max) = \sqrt{P_{max} \cdot R}$$

I = rms ripple current (amperes)

E = rms ripple voltage (volts)

Reverse Voltage

Polymer tantalum capacitors are polar devices and may be permanently damaged or destroyed if connected in the wrong polarity. These devices will withstand a small degree of transient voltage reversal for short periods as shown in the below table.

| Temperature | Permissible Transient Reverse Voltage |
|-------------|---------------------------------------|
| 25°C | 15% of Rated Voltage |
| 55°C | 10% of Rated Voltage |
| 85°C | 5% of Rated Voltage |
| 105°C | 3% of Rated Voltage |
| 125°C* | 1% of Rated Voltage |

*For series rated to 125°C

Table 2 – Land Dimensions/Courtyard

| KEMET | Metric Size Code | Density Level A: Maximum (Most) Land Protrusion (mm) | | | | | Density Level B: Median (Nominal) Land Protrusion (mm) | | | | | Density Level C: Minimum (Least) Land Protrusion (mm) | | | | |
|----------------|------------------|--|------|------|-------|------|--|------|------|------|------|---|------|------|------|------|
| | | X | Y | C | V1 | V2 | X | Y | C | V1 | V2 | X | Y | C | V1 | V2 |
| V | 7343-19 | 2.55 | 3.75 | 2.70 | 10.20 | 5.50 | 2.45 | 3.35 | 2.60 | 9.10 | 5.00 | 2.35 | 2.95 | 2.50 | 8.20 | 4.70 |
| Y ¹ | 7343-40 | 2.55 | 3.75 | 2.70 | 10.20 | 5.50 | 2.45 | 3.35 | 2.60 | 9.10 | 5.00 | 2.35 | 2.95 | 2.50 | 8.20 | 4.70 |

Density Level A: For low-density product applications. Recommended for wave solder applications and provides a wider process window for reflow solder processes.

Density Level B: For products with a moderate level of component density. Provides a robust solder attachment condition for reflow solder processes.

Density Level C: For high component density product applications. Before adapting the minimum land pattern variations the user should perform qualification testing based on the conditions outlined in IPC Standard 7351 (IPC-7351).

¹ Height of these chips may create problems in wave soldering.



Soldering Process

KEMET's families of surface mount capacitors are compatible with wave (single or dual), convection, IR, or vapor phase reflow techniques. Preheating of these components is recommended to avoid extreme thermal stress. KEMET's recommended profile conditions for convection and IR reflow reflect the profile conditions of the IPC/J-STD-020D standard for moisture sensitivity testing. The devices can safely withstand a maximum of three reflow passes at these conditions.

Please note that although the X/7343-43 case size can withstand wave soldering, the tall profile (4.3 mm maximum) dictates care in wave process development.

Hand soldering should be performed with care due to the difficulty in process control. If performed, care should be taken to avoid contact of the soldering iron to the molded case. The iron should be used to heat the solder pad, applying solder between the pad and the termination, until reflow occurs. Once reflow occurs, the iron should be removed immediately. "Wiping" the edges of a chip and heating the top surface is not recommended.

During typical reflow operations, a slight darkening of the gold-colored epoxy may be observed. This slight darkening is normal and not harmful to the product. Marking permanency is not affected by this change.

| Profile Feature | SnPb Assembly | Pb-Free Assembly |
|---|---------------------|---------------------|
| Preheat/Soak | | |
| Temperature Minimum (T_{Smin}) | 100°C | 150°C |
| Temperature Maximum (T_{Smax}) | 150°C | 200°C |
| Time (t_s) from T_{Smin} to T_{Smax} | 60 – 120 seconds | 60 – 120 seconds |
| Ramp-up Rate (T_L to T_p) | 3°C/seconds maximum | 3°C/seconds maximum |
| Liquidous Temperature (T_L) | 183°C | 217°C |
| Time Above Liquidous (t_L) | 60 – 150 seconds | 60 – 150 seconds |
| Peak Temperature (T_p) | 220°C* 235°C** | 250°C* 260°C** |
| Time within 5°C of Maximum Peak Temperature (t_p) | 20 seconds maximum | 30 seconds maximum |
| Ramp-down Rate (T_p to T_L) | 6°C/seconds maximum | 6°C/seconds maximum |
| Time 25°C to Peak Temperature | 6 minutes maximum | 8 minutes maximum |

Note: All temperatures refer to the center of the package, measured on the package body surface that is facing up during assembly reflow.

*Case Size D, E, P, Y and X

**Case Size A, B, C, H, I, K, M, R, S, T, U, V, W and Z

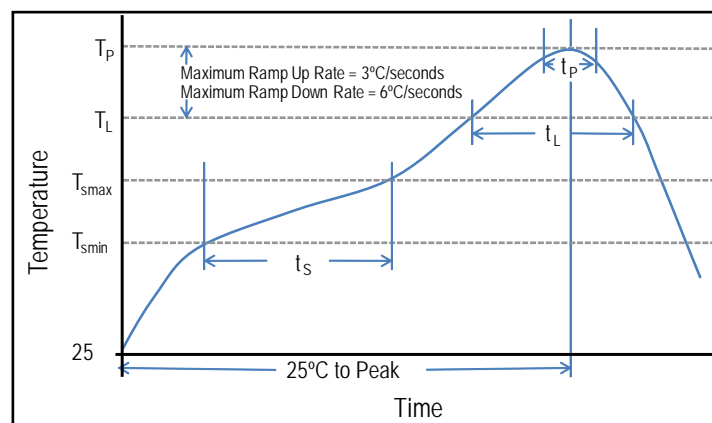

Construction



Capacitor Marking



* 242 = 42nd week of 2012

| Date Code * | |
|--|--|
| 1 st digit = Last number of Year | 9 = 2009 0 = 2010 1 = 2011 2 = 2012 3 = 2013 4 = 2014 |
| 2 nd and 3 rd digit = Week of the Year | 01 = 1 st week of the Year to 52 = 52 nd week of the Year |

Storage

All KO-CAP Series are shipped in moisture barrier bags with a desiccant and moisture indicator card. This series is classified as MSL3 (Moisture Sensitivity Level 3). Product contained within the moisture barrier bags should be stored in normal working environments with temperatures not to exceed 40°C and humidity not in excess of 60% RH.

Overview

The KEMET Organic Capacitor (KO-CAP) is a tantalum capacitor with a Ta anode and Ta₂O₅ dielectric. A conductive organic polymer replaces the traditionally used MnO₂ as the cathode plate of the capacitor. This results in very low ESR and improved capacitance retention at high frequency. The KO-CAP also exhibits a benign failure mode which eliminates the ignition failures that can occur in standard MnO₂ tantalum types. KO-CAPs may also be operated at steady state voltages up to 90% of rated voltage for part types with rated voltages of

≤ 10 volts and up to 80% of rated voltage for part types > 10 volts with equivalent or better reliability than traditional MnO₂ tantalum capacitors operated at 50% of rated voltage. The T525 Series KO-CAP Low ESR Polymer is KEMET's 125°C rated tantalum polymer capacitor. This part offers the same advantages as the T520 Series such as low ESR, high frequency capacitance retention and a benign failure mode. The T525 Series is often the series of choice when considering automotive or industrial type applications.

Benefits

- Polymer cathode technology
- 125°C maximum operating temperature
- High frequency capacitance retention
- Non-ignition failure mode
- Capacitance: 33 µF to 680 µF
- Voltage: 2.5 V to 16 V
- Use up to 90% of rated voltage (10% derating) for part types ≤ 10 V
- Use up to 80% of rated voltage (20% derating) for part types > 10 V
- 100% surge current tested
- Self-healing mechanism
- Volumetrically efficient
- EIA standard case sizes
- RoHS Compliant and Halogen Free

Applications

Typical applications include automotive, industrial and military as per DSCC 04051.



Environmental Compliance

RoHS Compliant (6/6) according to Directive 2002/95/EC when ordered with 100% Sn solder.



RoHS Compliant

SPICE

For a detailed analysis of specific part numbers, please visit www.kemet.com for a free download of KEMET's SPICE software. The KEMET SPICE program is freeware intended to aid design engineers in analyzing the performance of these capacitors over frequency, temperature, ripple, and DC bias conditions.

Ordering Information

| T | 525 | D | 337 | M | 006 | A | T | E800 | |
|-----------------|---------------------------|---------------|--|-----------------------|--|---------------------|---|---|------------------------------------|
| Capacitor Class | Series | Case Size | Capacitance Code (pF) | Capacitance Tolerance | Voltage | Failure Rate/Design | Lead Material | ESR | Packaging (C-Spec) |
| T = Tantalum | 525 = 125°C Rated Polymer | B, D, T, V, Y | First two digits represent significant figures. Third digit specifies number of zeros. | M = ±20% | 2R5 = 2.5 V 003 = 3 V 004 = 4 V 006 = 6.3 V 010 = 10 V 016 = 16 V | A = N/A | T = 100% Matte Tin (Sn) Plated H = Tin/Lead (SnPb) Solder Coated (5% Pb minimum) | Last three digits specify ESR in mΩ. (800 = 800 mΩ) | Blank = 7" Reel 7280 = 13" Reel |

Performance Characteristics

| Item | Performance Characteristics |
|-------------------------|---|
| Operating Temperature | -55°C to 125°C |
| Rated Capacitance Range | 22 – 680 μF @ 120 Hz/25°C |
| Capacitance Tolerance | M Tolerance (20%) |
| Rated Voltage Range | 2.5 – 16 V |
| DF (120 Hz) | ≤ 10% |
| ESR (100 kHz) | Refer to Part Number Electrical Specification Table |
| Leakage Current | ≤ 0.1 CV (μA) at rated voltage after 5 minutes |

Qualification

| Test | Condition | Characteristics | | | | |
|----------------------------|---|-----------------|-----------------------------------|-------|----------|----------|
| Endurance | 125°C @ 2/3 rated voltage, 2,000 hours | Δ C/C | Within -20%/+10% of initial value | | | |
| | | DF | ≤ Initial Limit | | | |
| | | DCL | 2 x IL @ 125°C | | | |
| | | ESR | 2 x Initial Limit | | | |
| Storage Life | 125°C @ 0 volts, 2,000 hours | Δ C/C | Within -20%/+10% of initial value | | | |
| | | DF | Within initial limits | | | |
| | | DCL | Within 2.0 x initial limit | | | |
| | | ESR | Within initial limit | | | |
| Humidity | 60°C, 90% RH, 1,000 hours, No Load | Δ C/C | Within -5%/+35% of initial value | | | |
| | | DF | ≤ Initial Limit | | | |
| | | DCL | Within 3.0 x initial limit | | | |
| Temperature Stability | Extreme temperature exposure at a succession of continuous steps at +25°C, -55°C, +25°C, +85°C, +125°C, +25°C | | +25°C | -55°C | +85°C | +125°C |
| | | Δ C/C | IL* | ±20% | ±20% | ±30% |
| | | DF | IL | IL | 1.2 x IL | 1.5 x IL |
| | | DCL | IL | n/a | 10 x IL | 10 x IL |
| Surge Voltage | 105°C, 1.32 x rated voltage, 33 Ω Resistance, 1,000 cycles | Δ C/C | Within -20%/+10% of initial value | | | |
| | | DF | Within initial limits | | | |
| | | DCL | Within initial limits | | | |
| | | ESR | Within initial limits | | | |
| Mechanical Shock/Vibration | MIL-STD-202, Method 213, Condition I, 100 G peak. MIL-STD-202, Method 204, Condition D, 10 Hz to 2,000 Hz, 20 G peak | Δ C/C | Within ±10% of initial value | | | |
| | | DF | Within initial limits | | | |
| | | DCL | Within initial limits | | | |

*IL = Initial Limit

Electrical Characteristics

ESR vs. Frequency

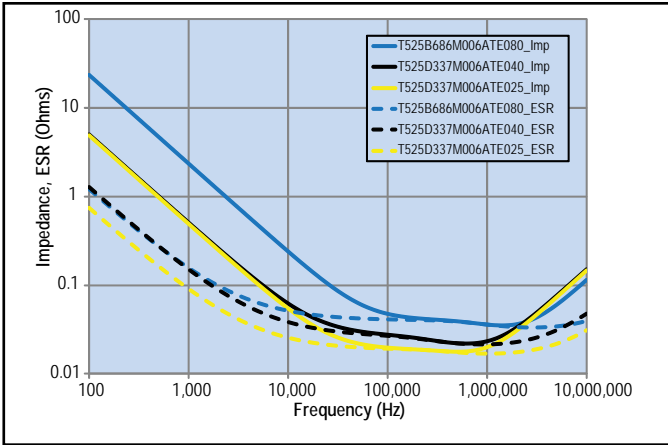

Capacitance vs. Frequency

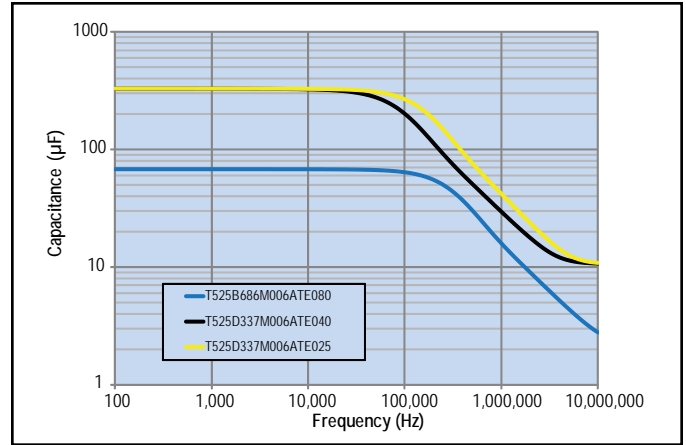

Dimensions – Millimeters (Inches)

Metric will govern



| Case Size | | Component | | | | | | | | | | | | |
|-----------|---------|----------------------------|----------------------------|----------------------------|--------------------|--------------------|-------------------------|------------------------------|------------|------------|-------------|------------|------------|------------|
| KEMET | EIA | L* | W* | H* | F* ±0.1 ±(.004) | S* ±0.3 ±(.012) | B* ±0.15 (Ref) ±.006 | X (Ref) | P (Ref) | R (Ref) | T (Ref) | A (Min) | G (Ref) | E (Ref) |
| B | 3528-21 | 3.5 ±0.2 (0.138 ±0.008) | 2.8 ±0.2 (0.110 ±0.008) | 1.9 ±0.2 (0.075 ±0.008) | 2.2 (.087) | 0.8 (.031) | 0.4 (.016) | 0.10 ± 0.10 (.004 ± .004) | 0.5 (.020) | 1.0 (.039) | 0.13 (.005) | 1.1 (.043) | 1.8 (.071) | 2.2 (.087) |
| D | 7343-31 | 7.3 ±0.3 (0.287 ±0.012) | 4.3 ±0.3 (0.169 ±0.012) | 2.8 ±0.3 (0.110 ±0.012) | 2.4 (.094) | 1.3 (.051) | 0.5 (.020) | 0.10 ± 0.10 (.004 ± .004) | 0.9 (.035) | 1.0 (.039) | 0.13 (.005) | 3.8 (.150) | 3.5 (.138) | 3.5 (.138) |
| T | 3528-12 | 3.5 ±0.2 (0.138 ±0.008) | 2.8 ±0.2 (0.110 ±0.008) | 1.2 (.047) | 2.2 (.087) | 0.8 (.031) | n/a | 0.05 (.002) | n/a | n/a | 0.13 (.005) | 1.1 (.043) | 1.8 (.071) | 2.2 (.087) |
| V | 7343-20 | 7.3 ±0.3 (0.287 ±0.012) | 4.3 ±0.3 (.169 ± .012) | 2.0 Maximum | 2.4 (.094) | 1.3 (.051) | n/a | 0.05 (.002) | n/a | n/a | 0.13 (.005) | 3.8 (.150) | 3.5 (.138) | 3.5 (.138) |
| Y | 7343-40 | 7.3 ±0.3 (0.287 ±0.012) | 4.3 ±0.3 (0.169 ±0.012) | 4.0 (.157) | 2.4 (.094) | 1.3 (.051) | 0.5 (.020) | 0.10 ± 0.10 (.004 ± .004) | 1.7 (.067) | 1.0 (.039) | 0.13 (.005) | 3.8 (.150) | 3.5 (.138) | 3.5 (.138) |

Notes: (Ref) – Dimensions provided for reference only. No dimensions are provided for B, P or R because low profile cases do not have a bevel or a notch.

* MIL-PRF-55365/8 specified dimensions

Table 1 – Ratings & Part Number Reference

| Rated Voltage | Rated Cap | Case Code/ Case Size | KEMET Part Number | DC Leakage | DF | ESR | Maximum Allowable Ripple Current | Moisture Sensitivity | Rated Temp |
|---------------|-----------|-------------------------|------------------------------|----------------------|----------------------|------------------------|----------------------------------|----------------------|------------|
| VDC | µF | KEMET/EIA | (See below for part options) | µA @ +20°C Max/5 Min | % @ +20°C 120 Hz Max | mΩ @ +20°C 100 kHz Max | (mA) 100 kHz +45°C | Temp ≤ 260°C | (°C) |
| 2.5 | 100 | T/3528-12 | T525T107M2R5A(1)E080 | 25.0 | 10 | 80 | 1100.0 | 3 | 125 |
| 2.5 | 330 | D/7343-31 | T525D337M2R5A(1)E025 | 82.5 | 10 | 25 | 3000.0 | 3 | 125 |
| 2.5 | 470 | D/7343-31 | T525D477M2R5A(1)E025 | 117.5 | 10 | 25 | 3000.0 | 3 | 125 |
| 2.5 | 680 | D/7343-31 | T525D687M2R5A(1)E025 | 170.0 | 10 | 25 | 3000.0 | 3 | 125 |
| 3 | 100 | B/3528-21 | T525B107M003A(1)E080 | 30.0 | 8 | 80 | 1300.0 | 3 | 125 |
| 3 | 150 | B/3528-21 | T525B157M003A(1)E080 | 45.0 | 8 | 80 | 1300.0 | 3 | 125 |
| 3 | 330 | D/7343-31 | T525D337M003A(1)E025 | 99.0 | 10 | 25 | 3000.0 | 3 | 125 |
| 3 | 470 | D/7343-31 | T525D477M003A(1)E025 | 141.0 | 10 | 25 | 3000.0 | 3 | 125 |
| 3 | 680 | D/7343-31 | T525D687M003A(1)E025 | 204.0 | 10 | 25 | 3000.0 | 3 | 125 |
| 4 | 68 | T/3528-12 | T525T686M004A(1)E080 | 27.2 | 8 | 80 | 1100.0 | 3 | 125 |
| 4 | 68 | B/3528-21 | T525B686M004A(1)E080 | 27.2 | 8 | 80 | 1300.0 | 3 | 125 |
| 4 | 100 | B/3528-21 | T525B107M004A(1)E080 | 40.0 | 8 | 80 | 1300.0 | 3 | 125 |
| 4 | 220 | D/7343-31 | T525D227M004A(1)E025 | 88.0 | 10 | 25 | 3000.0 | 3 | 125 |
| 4 | 330 | D/7343-31 | T525D337M004A(1)E025 | 132.0 | 10 | 25 | 3000.0 | 3 | 125 |
| 4 | 470 | D/7343-31 | T525D477M004A(1)E025 | 188.0 | 10 | 25 | 3000.0 | 3 | 125 |
| 4 | 470 | D/7343-31 | T525D477M004A(1)E040 | 188.0 | 10 | 40 | 2400.0 | 3 | 125 |
| 6.3 | 33 | B/3528-21 | T525B336M006A(1)E080 | 20.8 | 8 | 80 | 1300.0 | 3 | 125 |
| 6.3 | 47 | T/3528-12 | T525T476M006A(1)E080 | 29.6 | 8 | 80 | 1100.0 | 3 | 125 |
| 6.3 | 47 | B/3528-21 | T525B476M006A(1)E070 | 29.6 | 8 | 70 | 1300.0 | 3 | 125 |
| 6.3 | 47 | B/3528-21 | T525B476M006A(1)E080 | 29.6 | 8 | 80 | 1300.0 | 3 | 125 |
| 6.3 | 68 | B/3528-21 | T525B686M006A(1)E080 | 42.8 | 8 | 80 | 1300.0 | 3 | 125 |
| 6.3 | 150 | D/7343-31 | T525D157M006A(1)E025 | 94.5 | 10 | 25 | 3000.0 | 3 | 125 |
| 6.3 | 220 | D/7343-31 | T525D227M006A(1)E025 | 138.6 | 10 | 25 | 3000.0 | 3 | 125 |
| 6.3 | 330 | D/7343-31 | T525D337M006A(1)E025 | 207.9 | 10 | 25 | 3000.0 | 3 | 125 |
| 6.3 | 330 | D/7343-31 | T525D337M006A(1)E040 | 207.9 | 10 | 40 | 2400.0 | 3 | 125 |
| 6.3 | 470 | Y/7343-40 | T525Y477M006A(1)E035 | 296.1 | 10 | 35 | 2600.0 | 3 | 125 |
| 8 | 33 | T/3528-12 | T525T336M008A(1)E080 | 26.4 | 8 | 80 | 1100.0 | 3 | 125 |
| 10 | 22 | B/3528-21 | T525B226M010A(1)E080 | 22.0 | 8 | 80 | 1300.0 | 3 | 125 |
| 10 | 33 | T/3528-12 | T525T336M010A(1)E080 | 33.0 | 8 | 80 | 1100.0 | 3 | 125 |
| 10 | 33 | B/3528-21 | T525B336M010A(1)E080 | 33.0 | 8 | 80 | 1300.0 | 3 | 125 |
| 10 | 100 | D/7343-31 | T525D107M010A(1)E025 | 100.0 | 10 | 25 | 3000.0 | 3 | 125 |
| 10 | 100 | D/7343-31 | T525D107M010A(1)E055 | 100.0 | 10 | 55 | 2000.0 | 3 | 125 |
| 10 | 150 | D/7343-31 | T525D157M010A(1)E025 | 150.0 | 10 | 25 | 3000.0 | 3 | 125 |
| 10 | 150 | D/7343-31 | T525D157M010A(1)E055 | 150.0 | 10 | 55 | 2000.0 | 3 | 125 |
| 10 | 220 | D/7343-31 | T525D227M010A(1)E025 | 220.0 | 10 | 25 | 3000.0 | 3 | 125 |
| 10 | 330 | Y/7343-40 | T525Y337M010A(1)E035 | 330.0 | 10 | 35 | 2600.0 | 3 | 125 |
| 16 | 47 | D/7343-31 | T525D476M016A(1)E035 | 75.2 | 10 | 35 | 2500.0 | 3 | 125 |
| 16 | 47 | D/7343-31 | T525D476M016A(1)E065 | 75.2 | 10 | 65 | 1900.0 | 3 | 125 |
| VDC | µF | KEMET/EIA | (See below for part options) | µA @ +20°C Max/5 Min | % @ +20°C 120 Hz Max | mΩ @ +20°C 100 kHz Max | (mA) 100 kHz +45°C | Temp ≤ 260°C | (°C) |
| Rated Voltage | Rated Cap | Case Code/ Case Size | KEMET Part Number | DC Leakage | DF | ESR | Maximum Allowable Ripple Current | Moisture Sensitivity | Rated Temp |

Other part number options:

(1) Standard with tin terminations (14th character = T). Tin/lead terminations is also available (14th character = H).

Also available on large (13 inch) reels. Add 7280 to the end of the part number.

Higher voltage ratings and tighter tolerance product including ESR may be substituted within the same size at KEMET's option. Voltage substitutions will be marked with the higher voltage rating. Substitutions can include better than series.

Derating Guidelines

| Voltage Rating | Maximum Recommended Steady State Voltage | Maximum Recommended Transient Voltage (1ms – 1μs) |
|--------------------------------|--|---|
| -55°C to 105°C | | |
| 2.5 V ≤ V _R ≤ 10 V | 90% of V _R | V _R |
| 12.5 V ≤ V _R ≤ 16 V | 80% of V _R | V _R |
| 105°C to 125°C | | |
| 2.5 V ≤ V _R ≤ 10 V | 60% of V _R | 67% of V _R |
| 12.5 V ≤ V _R ≤ 16 V | 54% of V _R | 67% of V _R |

V_R = Rated Voltage

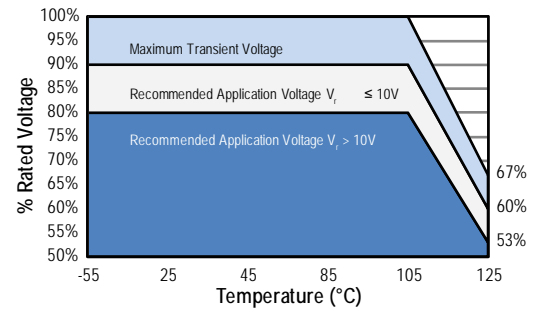

Ripple Current/Ripple Voltage

Permissible AC ripple voltage and current are related to equivalent series resistance (ESR) and the power dissipation capabilities of the device. Permissible AC ripple voltage which may be applied is limited by two criteria:

1. The positive peak AC voltage plus the DC bias voltage, if any, must not exceed the DC voltage rating of the capacitor.
2. The negative peak AC voltage in combination with bias voltage, if any, must not exceed the allowable limits specified for reverse voltage. See the Reverse Voltage section for allowable limits.

The maximum power dissipation by case size can be determined using the table at right. The maximum power dissipation rating stated in the table must be reduced with increasing environmental operating temperatures. Refer to the table below for temperature compensation requirements.

| Temperature Compensation Multipliers for Maximum Power Dissipation | | |
|--|------------------|------------------|
| ≤ 45°C | 45° C < T ≤ 85°C | 85°C < T ≤ 125°C |
| 1.00 | 0.70 | 0.25 |

T = Environmental Temperature

| Case Code | EIA Case Code | Maximum Power Dissipation (P max) mWatts @ 45°C with +30°C Rise |
|-----------|---------------|---|
| T | 3528-12 | 105 |
| M | 3528-15 | 120 |
| A | 3216-18 | 112 |
| B | 3528-21 | 127 |
| U | 6032-15 | 135 |
| L | 3528-19 | 150 |
| C | 6032-28 | 165 |
| W | 7343-15 | 180 |
| V | 7343-20 | 187 |
| D | 7343-31 | 225 |
| Y | 7343-40 | 241 |
| X | 7343-43 | 247 |
| H | 7360-20 | 187 |
| I | 3216-10 | 95 |

The maximum power dissipation rating must be reduced with increasing environmental operating temperatures. Refer to the Temperature Compensation Multiplier table for details.

Using the P max of the device, the maximum allowable rms ripple current or voltage may be determined.

$$I(max) = \sqrt{P_{max}/R}$$

$$E(max) = \sqrt{P_{max} \cdot R}$$

I = rms ripple current (amperes)

E = rms ripple voltage (volts)

P max = maximum power dissipation (watts)

R = ESR at specified frequency (ohms)

Reverse Voltage

Polymer tantalum capacitors are polar devices and may be permanently damaged or destroyed if connected in the wrong polarity. These devices will withstand a small degree of transient voltage reversal for short periods as shown in the below table.

| Temperature | Permissible Transient Reverse Voltage |
|-------------|---------------------------------------|
| 25°C | 15% of Rated Voltage |
| 55°C | 10% of Rated Voltage |
| 85°C | 5% of Rated Voltage |
| 105°C | 3% of Rated Voltage |
| 125°C* | 1% of Rated Voltage |

*For series rated to 125°C

Table 2 – Land Dimensions/Courtyard

| KEMET | Metric Size Code | Density Level A: Maximum (Most) Land Protrusion (mm) | | | | | Density Level B: Median (Nominal) Land Protrusion (mm) | | | | | Density Level C: Minimum (Least) Land Protrusion (mm) | | | | |
|----------------|------------------|--|------|------|-------|------|--|------|------|------|------|---|------|------|------|------|
| | | X | Y | C | V1 | V2 | X | Y | C | V1 | V2 | X | Y | C | V1 | V2 |
| B | 3528-21 | 2.35 | 2.15 | 1.45 | 6.10 | 4.00 | 2.25 | 1.75 | 1.35 | 5.00 | 3.50 | 2.15 | 1.35 | 1.25 | 4.10 | 3.20 |
| D | 7343-31 | 2.55 | 3.75 | 2.70 | 10.20 | 5.50 | 2.45 | 3.35 | 2.60 | 9.10 | 5.00 | 2.35 | 2.95 | 2.50 | 8.20 | 4.70 |
| T | 3528-12 | 2.35 | 2.15 | 1.45 | 6.10 | 4.00 | 2.25 | 1.75 | 1.35 | 5.00 | 3.50 | 2.15 | 1.35 | 1.25 | 4.10 | 3.20 |
| V | 7343-20 | 2.55 | 3.75 | 2.70 | 10.20 | 5.50 | 2.45 | 3.35 | 2.60 | 9.10 | 5.00 | 2.35 | 2.95 | 2.50 | 8.20 | 4.70 |
| Y ¹ | 7343-40 | 2.55 | 3.75 | 2.70 | 10.20 | 5.50 | 2.45 | 3.35 | 2.60 | 9.10 | 5.00 | 2.35 | 2.95 | 2.50 | 8.20 | 4.70 |

Density Level A: For low-density product applications. Recommended for wave solder applications and provides a wider process window for reflow solder processes.

Density Level B: For products with a moderate level of component density. Provides a robust solder attachment condition for reflow solder processes.

Density Level C: For high component density product applications. Before adapting the minimum land pattern variations the user should perform qualification testing based on the conditions outlined in IPC Standard 7351 (IPC-7351).

¹ Height of these chips may create problems in wave soldering.



Soldering Process

KEMET’s families of surface mount capacitors are compatible with wave (single or dual), convection, IR, or vapor phase reflow techniques. Preheating of these components is recommended to avoid extreme thermal stress. KEMET’s recommended profile conditions for convection and IR reflow reflect the profile conditions of the IPC/J–STD–020D standard for moisture sensitivity testing. The devices can safely withstand a maximum of three reflow passes at these conditions.

Please note that although the X/7343–43 case size can withstand wave soldering, the tall profile (4.3 mm maximum) dictates care in wave process development.

Hand soldering should be performed with care due to the difficulty in process control. If performed, care should be taken to avoid contact of the soldering iron to the molded case. The iron should be used to heat the solder pad, applying solder between the pad and the termination, until reflow occurs. Once reflow occurs, the iron should be removed immediately. “Wiping” the edges of a chip and heating the top surface is not recommended.

During typical reflow operations, a slight darkening of the gold-colored epoxy may be observed. This slight darkening is normal and not harmful to the product. Marking permanency is not affected by this change.

| Profile Feature | SnPb Assembly | Pb-Free Assembly |
|---|---------------------|---------------------|
| Preheat/Soak | | |
| Temperature Minimum (T_{smin}) | 100°C | 150°C |
| Temperature Maximum (T_{smax}) | 150°C | 200°C |
| Time (t_s) from T_{smin} to T_{smax} | 60 – 120 seconds | 60 – 120 seconds |
| Ramp-up Rate (T_L to T_p) | 3°C/seconds maximum | 3°C/seconds maximum |
| Liquidous Temperature (T_L) | 183°C | 217°C |
| Time Above Liquidous (t_L) | 60 – 150 seconds | 60 – 150 seconds |
| Peak Temperature (T_p) | 220°C* 235°C** | 250°C* 260°C** |
| Time within 5°C of Maximum Peak Temperature (t_p) | 20 seconds maximum | 30 seconds maximum |
| Ramp-down Rate (T_p to T_L) | 6°C/seconds maximum | 6°C/seconds maximum |
| Time 25°C to Peak Temperature | 6 minutes maximum | 8 minutes maximum |

Note: All temperatures refer to the center of the package, measured on the package body surface that is facing up during assembly reflow.

*Case Size D, E, P, Y, and X

**Case Size A, B, C, H, I, K, M, R, S, T, U, V, W, and Z

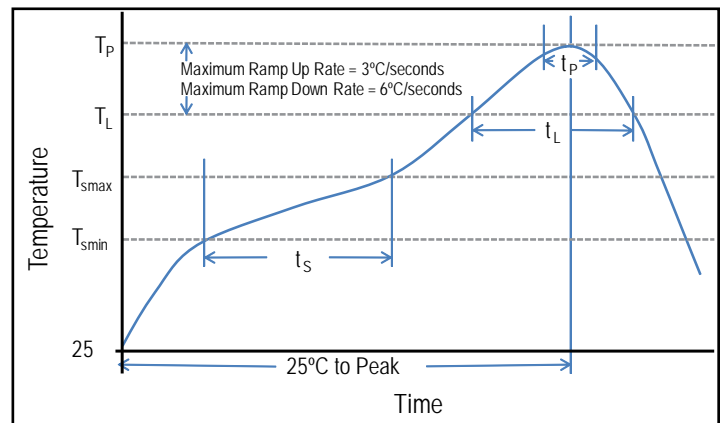

Construction

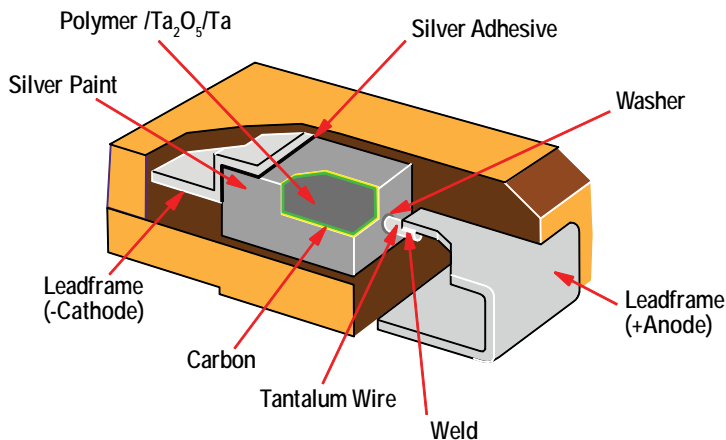

Capacitor Marking

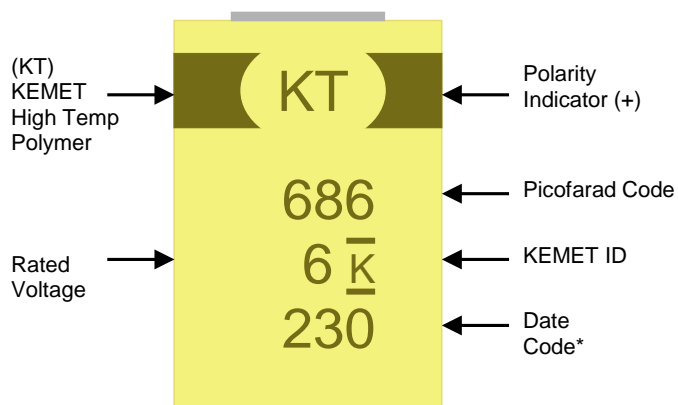

* 230 = 30th week of 2012

| Date Code * | |
|--|--|
| 1 st digit = Last number of Year | 9 = 2009 0 = 2010 1 = 2011 2 = 2012 3 = 2013 4 = 2014 |
| 2 nd and 3 rd digit = Week of the Year | 01 = 1 st week of the Year to 52 = 52 nd week of the Year |

Storage

All KO-CAP series are shipped in moisture barrier bags with a desiccant and moisture indicator card. These series are classified as MSL3 (Moisture Sensitivity Level 3). Product contained within the moisture barrier bags should be stored in normal working environments with temperatures not to exceed 40°C and humidity not in excess of 60% RH.

Overview

The KEMET Organic Capacitor (KO-CAP) is a tantalum capacitor with a Ta anode and Ta₂O₅ dielectric. A conductive organic polymer replaces the traditionally used MnO₂ as the cathode plate of the capacitor. This results in very low ESR and improved capacitance retention at high frequency. The KO-CAP also exhibits a benign failure mode which eliminates the ignition failures that can occur in standard MnO₂ tantalum types. KO-CAPs may also be operated at steady state voltages up to 90% of rated voltage for part types with rated voltages of ≤ 10 volts and up to 80% of rated voltage for part types > 10 volts with equivalent or better reliability than traditional MnO₂ tantalum capacitors operated at 50% of rated voltage.

The T528 Series KO-CAP combines ultra-low ESR and high capacitance in a package design that offers the lowest ESL in the market for this type of product. This series offers exceptional performance for high-speed server and microprocessor decoupling – designs that are driving the demand for low inductance chips. The T528 uses a different termination design that allows for a reduction in the inductance loop area and comes in a low profile 1.7 mm case height. These product features offer the advantage of improved capacitance retention at frequencies of up to 1 MHz.

Benefits

- Polymer cathode technology
- 100% accelerated steady state aging
- Low ESL <0.7 nH @ 20 MHz
- 100% surge current tested
- High frequency capacitance retention
- Non-ignition failure mode
- Improved volumetric efficiency
- Self-healing mechanism
- Capacitance: 33 μF to 470 μF
- Use up to 90% of rated voltage (10% derating)
- Voltage: 2.5 V to 10 V
- RoHS compliant and Halogen Free
- 105°C maximum temperature capability
- Lead free 260°C reflow capable

Applications

Typical applications include high speed server, microprocessor decoupling and high ripple current applications.



Environmental Compliance

RoHS Compliant (6/6) according to Directive 2002/95/EC when ordered with 100% Sn Solder



RoHS Compliant

SPICE

For a detailed analysis of specific part numbers, please visit www.kemet.com for a free download of KEMET's SPICE software. The KEMET SPICE program is freeware intended to aid design engineers in analyzing the performance of these capacitors over frequency, temperature, ripple, and DC bias conditions.

Ordering Information

| T | 528 | Z | 337 | M | 2R5 | A | T | E009 | |
|-----------------|---|------------|--|-----------------------|--|---------------------|--------------------------------|--|------------------------------------|
| Capacitor Class | Series | Case Size | Capacitance Code (pF) | Capacitance Tolerance | Voltage | Failure Rate/Design | Lead Material | ESR Code | Packaging (C-Spec) |
| T = Tantalum | 528 = Low ESL Facedown Terminal Polymer | I, K, W, Z | First two digits represent significant figures. Third digit specifies number of zeros. | M = $\pm 20\%$ | 2R5 = 2.5 V 003 = 3 V 004 = 4 V 006 = 6.3 V 010 = 10 V | A = N/A | T = 100% Matte Tin (Sn) Plated | E = ESR Last three digits specify ESR in m Ω (009 = 9 m Ω) | Blank = 7" Reel 7280 = 13" Reel |

Performance Characteristics

| Item | Performance Characteristics |
|-------------------------|--|
| Operating Temperature | -55°C to 105°C |
| Rated Capacitance Range | 33 – 470 μF @ 120 Hz/25°C |
| Capacitance Tolerance | M Tolerance (20%) |
| Rated Voltage Range | 2.5 – 10 V |
| DF (120 Hz) | $\leq 10\%$ |
| ESR (100 kHz) | Refer to Part Number Electrical Specification Table |
| Leakage Current | $\leq 0.1 \text{ CV}$ (μA) at rated voltage after 5 minutes |

Qualification

| Test | Condition | Characteristics | | | | | |
|----------------------------|--|-----------------|--|-------|-----------------------------|----------|--|
| Endurance | 85°C @ rated voltage, 2,000 hours 125°C @ 2/3 rated voltage, 2,000 hours | Δ C/C | Within ±10% of initial value | | | | |
| | | DF | Within initial limits | | | | |
| | | DCL | Within 1.25 x initial limit | | | | |
| | | ESR | Within initial limits | | | | |
| Storage Life | 125°C @ 0 volts, 2,000 hours | Δ C/C | Within ±10% of initial value | | | | |
| | | DF | Within initial limits | | | | |
| | | DCL | Within 1.25 x initial limit | | | | |
| | | ESR | Within initial limits | | | | |
| Thermal Shock | MIL-STD-202, Method 107, Condition B, mounted, -55°C to 125°C, 1,000 cycles | Δ C/C | Within ±5% of initial value | | | | |
| | | DF | Within initial limits | | | | |
| | | DCL | Within 1.25 x initial limit | | | | |
| | | ESR | Within initial limits | | | | |
| Temperature Stability | Extreme temperature exposure at a succession of continuous steps at +25°C, -55°C, +25°C, +85°C, +125°C, +25°C | +25°C | -55°C | +85°C | +125°C | | |
| | | Δ C/C | IL* | ±10% | ±10% | ±20% | |
| | | DF | IL | IL | 1.5 x IL | 1.5 x IL | |
| | | DCL | IL | n/a | 10 x IL | 12 x IL | |
| | | Surge Voltage | 25°C and 85°C, 1.32 x rated voltage 1,000 cycles (125°C, 1.2 x rated voltage) | Δ C/C | Within ±5% of initial value | | |
| | | | | DF | Within initial limits | | |
| DCL | Within initial limits | | | | | | |
| ESR | Within initial limits | | | | | | |
| Mechanical Shock/Vibration | MIL-STD-202, Method 213, Condition I, 100 G peak MIL-STD-202, Method 204, Condition D, 10 Hz to 2,000 Hz, 20 G peak | Δ C/C | Within ±10 of initial value | | | | |
| | | DF | Within initial limits | | | | |
| | | DCL | Within initial limits | | | | |

*IL = Initial limit

Electrical Characteristics

ESR vs. Frequency



Capacitance vs. Frequency



Dimensions – Millimeters



| Case Size | | Component | | | | | |
|-----------|---------|-----------|----------|-------------|--------|---------|---------|
| KEMET | EIA | L | W | H | F ±0.2 | S1 ±0.2 | S2 ±0.2 |
| I | 3216-10 | 3.2 ±0.2 | 1.6 ±0.2 | 1.0 Maximum | 1.2 | 1.0 | 0.7 |
| K | 3528-10 | 3.5 ±0.3 | 2.8 ±0.3 | 1.0 Maximum | 2 | 1.2 | 0.6 |
| W | 7343-15 | 7.3 ±0.4 | 4.3 ±0.3 | 1.5 Maximum | 2.8 | 5.1 | 1.3 |
| Z | 7343-17 | 7.3 ±0.4 | 4.3 ±0.3 | 1.7 Maximum | 2.8 | 5.1 | 1.3 |

Table 1 – Ratings & Part Number Reference

| Rated Voltage | Rated Capacitance | Case Code/ Case Size | KEMET Part Number | DC Leakage | DF | ESR | Maximum Allowable Ripple Current | Moisture Sensitivity |
|---------------|-------------------|-------------------------|------------------------------|-------------------------------------|--------------------------------|----------------------------------|----------------------------------|----------------------|
| VDC | µF | KEMET/EIA | (See below for part options) | µA @ +20°C Maximum/ 5 Minutes | % @ +20°C 120 Hz Maximum | mΩ @ +20°C 100 kHz Maximum | (mA) +45°C 100 kHz | Temp ≤ 260°C |
| 2.5 | 220 | Z/7343-18 | T528Z227M2R5ATE006 | 55.0 | 10 | 6 | 7400 | 3 |
| 2.5 | 330 | W/7343-15 | T528W337M2R5ATE009 | 82.5 | 10 | 9 | 6000 | 3 |
| 2.5 | 330 | Z/7343-18 | T528Z337M2R5ATE005 | 82.5 | 10 | 5 | 8100 | 3 |
| 2.5 | 330 | Z/7343-18 | T528Z337M2R5ATE006 | 82.5 | 10 | 6 | 7400 | 3 |
| 2.5 | 330 | Z/7343-18 | T528Z337M2R5ATE007 | 82.5 | 10 | 7 | 6800 | 3 |
| 2.5 | 330 | Z/7343-18 | T528Z337M2R5ATE008 | 82.5 | 10 | 8 | 6400 | 3 |
| 2.5 | 330 | Z/7343-18 | T528Z337M2R5ATE009 | 82.5 | 10 | 9 | 6000 | 3 |
| 2.5 | 330 | Z/7343-18 | T528Z337M2R5ATE012 | 82.5 | 10 | 12 | 5200 | 3 |
| 2.5 | 470 | Z/7343-18 | T528Z477M2R5ATE005 | 117.5 | 10 | 5 | 8100 | 3 |
| 2.5 | 470 | Z/7343-18 | T528Z477M2R5ATE006 | 117.5 | 10 | 6 | 7400 | 3 |
| 2.5 | 470 | Z/7343-18 | T528Z477M2R5ATE008 | 117.5 | 10 | 8 | 6400 | 3 |
| 2.5 | 470 | Z/7343-18 | T528Z477M2R5ATE009 | 117.5 | 10 | 9 | 6000 | 3 |
| 2.5 | 470 | Z/7343-18 | T528Z477M2R5ATE012 | 117.5 | 10 | 12 | 5200 | 3 |
| 3 | 100 | I/3216-10 | T528I107M003ATE150 | 30.0 | 10 | 150 | 800 | 3 |
| 3 | 100 | I/3216-10 | T528I107M003ATE200 | 30.0 | 10 | 200 | 700 | 3 |
| 4 | 68 | I/3216-10 | T528I686M004ATE150 | 27.2 | 10 | 150 | 800 | 3 |
| 4 | 68 | I/3216-10 | T528I686M004ATE200 | 27.2 | 10 | 200 | 700 | 3 |
| 4 | 220 | K/3528-10 | T528K227M004ATE100 | 88.0 | 10 | 100 | 1200 | 3 |
| 4 | 220 | Z/7343-18 | T528Z227M004ATE007 | 88.0 | 10 | 7 | 6800 | 3 |
| 4 | 220 | Z/7343-18 | T528Z227M004ATE008 | 88.0 | 10 | 8 | 6400 | 3 |
| 4 | 220 | Z/7343-18 | T528Z227M004ATE009 | 88.0 | 10 | 9 | 6000 | 3 |
| 4 | 220 | Z/7343-18 | T528Z227M004ATE012 | 88.0 | 10 | 12 | 5200 | 3 |
| 4 | 330 | Z/7343-18 | T528Z337M004ATE009 | 132.0 | 10 | 9 | 6000 | 3 |
| 4 | 330 | Z/7343-18 | T528Z337M004ATE012 | 132.0 | 10 | 12 | 5200 | 3 |
| 6.3 | 47 | I/3216-10 | T528I476M006ATE150 | 29.6 | 10 | 150 | 800 | 3 |
| 6.3 | 47 | I/3216-10 | T528I476M006ATE200 | 29.6 | 10 | 200 | 700 | 3 |
| 6.3 | 150 | K/3528-10 | T528K157M006ATE200 | 94.5 | 10 | 200 | 900 | 3 |
| 6.3 | 150 | K/3528-10 | T528K157M006ATE100 | 94.5 | 10 | 100 | 1200 | 3 |
| 6.3 | 150 | K/3528-10 | T528K157M006ATE200 | 94.5 | 10 | 200 | 900 | 3 |
| 6.3 | 150 | Z/7343-18 | T528Z157M006ATE007 | 94.5 | 10 | 7 | 6800 | 3 |
| 6.3 | 150 | Z/7343-18 | T528Z157M006ATE008 | 94.5 | 10 | 8 | 6400 | 3 |
| 6.3 | 150 | Z/7343-18 | T528Z157M006ATE009 | 94.5 | 10 | 9 | 6000 | 3 |
| 6.3 | 150 | Z/7343-18 | T528Z157M006ATE012 | 94.5 | 10 | 12 | 5200 | 3 |
| 6.3 | 220 | Z/7343-18 | T528Z227M006ATE009 | 138.6 | 10 | 9 | 6000 | 3 |
| 6.3 | 220 | Z/7343-18 | T528Z227M006ATE012 | 138.6 | 10 | 12 | 5200 | 3 |
| 10 | 33 | I/3216-10 | T528I336M010ATE150 | 33.0 | 10 | 150 | 800 | 3 |
| 10 | 33 | I/3216-10 | T528I336M010ATE200 | 33.0 | 10 | 200 | 700 | 3 |
| VDC | µF | KEMET/EIA | (See below for part options) | µA @ +20°C Maximum/ 5 Minutes | % @ +20°C 120 Hz Maximum | mΩ @ +20°C 100 kHz Maximum | (mA) +45°C 100 kHz | Temp ≤ 260°C |
| Rated Voltage | Rated Capacitance | Case Code/ Case Size | KEMET Part Number | DC Leakage | DF | ESR | Maximum Allowable Ripple Current | Moisture Sensitivity |

Other part number options:

1- Standard with tin terminations (14th character = T). Tin/lead terminations is also available (14th character = H).

Also available on large (13 inch) reels. Add 7280 to the end of the part number.

Higher voltage ratings and tighter tolerance product including ESR may be substituted within the same size at KEMET's option. Voltage substitutions will be marked with the higher voltage rating. Substitutions can include better than series.

Derating Guidelines

| Voltage Rating | Maximum Recommended Steady State Voltage | Maximum Recommended Transient Voltage (1 ms – 1 μs) |
|----------------------------|--|---|
| -55°C to 105°C | | |
| $2.5 V \leq V_R \leq 10 V$ | 90% of V_R | V_R |

V_R = Rated Voltage



Ripple Current/Ripple Voltage

Permissible AC ripple voltage and current are related to equivalent series resistance (ESR) and the power dissipation capabilities of the device. Permissible AC ripple voltage which may be applied is limited by two criteria:

1. The positive peak AC voltage plus the DC bias voltage, if any, must not exceed the DC voltage rating of the capacitor.
2. The negative peak AC voltage in combination with bias voltage, if any, must not exceed the allowable limits specified for reverse voltage. See the Reverse Voltage section for allowable limits.

The maximum power dissipation by case size can be determined using the table at right. The maximum power dissipation rating stated in the table must be reduced with increasing environmental operating temperatures. Refer to the table below for temperature compensation requirements.

| Case Code | EIA Case Code | Maximum Power Dissipation (P max) mWatts @ 45°C with +30°C Rise |
|-----------|---------------|---|
| W | 7343-15 | 325 |
| Z | 7343-17 | 325 |
| D | 7343-31 | 255 |
| Y | 7343-40 | 263 |
| X | 7443-43 | 270 |

The maximum power dissipation rating must be reduced with increasing environmental operating temperatures. Refer to the Temperature Compensation Multiplier table for details.

| Temperature Compensation Multipliers for Maximum Power Dissipation | | |
|--|------------------|------------------|
| ≤ 45°C | 45° C < T ≤ 85°C | 85°C < T ≤ 125°C |
| 1.00 | 0.70 | 0.25 |

T = Environmental Temperature

Using the P max of the device, the maximum allowable rms ripple current or voltage may be determined.

$$I(max) = \sqrt{P_{max}/R}$$

$$E(max) = \sqrt{P_{max} \cdot R}$$

I = rms ripple current (amperes)

E = rms ripple voltage (volts)

P max = maximum power dissipation (watts)

R = ESR at specified frequency (ohms)

Reverse Voltage

Polymer tantalum capacitors are polar devices and may be permanently damaged or destroyed if connected in the wrong polarity. These devices will withstand a small degree of transient voltage reversal for short periods as shown in the below table.

| Temperature | Permissible Transient Reverse Voltage |
|-------------|---------------------------------------|
| 25°C | 15% of Rated Voltage |
| 55°C | 10% of Rated Voltage |
| 85°C | 5% of Rated Voltage |
| 105°C | 3% of Rated Voltage |
| 125°C* | 1% of Rated Voltage |

*For Series Rated to 125°C

Table 2 – Land Dimensions/Courtyard



Soldering Process

KEMET’s families of surface mount capacitors are compatible with wave (single or dual), convection, IR, or vapor phase reflow techniques. Preheating of these components is recommended to avoid extreme thermal stress. KEMET’s recommended profile conditions for convection and IR reflow reflect the profile conditions of the IPC/J–STD–020D standard for moisture sensitivity testing. The devices can safely withstand a maximum of three reflow passes at these conditions.

Please note that although the X/7343–43 case size can withstand wave soldering, the tall profile (4.3 mm maximum) dictates care in wave process development.

Hand soldering should be performed with care due to the difficulty in process control. If performed, care should be taken to avoid contact of the soldering iron to the molded case. The iron should be used to heat the solder pad, applying solder between the pad and the termination, until reflow occurs. Once reflow occurs, the iron should be removed immediately. “Wiping” the edges of a chip and heating the top surface is not recommended.

During typical reflow operations, a slight darkening of the gold-colored epoxy may be observed. This slight darkening is normal and not harmful to the product. Marking permanency is not affected by this change.

| Profile Feature | SnPb Assembly | Pb-Free Assembly |
|---|---------------------|---------------------|
| Preheat/Soak | | |
| Temperature Minimum (T_{smin}) | 100°C | 150°C |
| Temperature Maximum (T_{smax}) | 150°C | 200°C |
| Time (t_s) from T_{smin} to T_{smax} | 60 – 120 seconds | 60 – 120 seconds |
| Ramp-up Rate (T_L to T_p) | 3°C/seconds maximum | 3°C/seconds maximum |
| Liquidous Temperature (T_L) | 183°C | 217°C |
| Time Above Liquidous (t_L) | 60 – 150 seconds | 60 – 150 seconds |
| Peak Temperature (T_p) | 220°C* 235°C** | 250°C* 260°C** |
| Time within 5°C of Maximum Peak Temperature (t_p) | 20 seconds maximum | 30 seconds maximum |
| Ramp-down Rate (T_p to T_L) | 6°C/seconds maximum | 6°C/seconds maximum |
| Time 25°C to Peak Temperature | 6 minutes maximum | 8 minutes maximum |

Note: All temperatures refer to the center of the package, measured on the package body surface that is facing up during assembly reflow.

*Case Size D, E, P, Y, and X

**Case Size A, B, C, H, I, K, M, R, S, T, U, V, W, and Z



Construction



Capacitor Marking



* 230 = 30th week of 2012

| Date Code * | |
|--|--|
| 1 st digit = Last number of Year | 9 = 2009 0 = 2010 1 = 2011 2 = 2012 3 = 2013 4 = 2014 |
| 2 nd and 3 rd digit = Week of the Year | 01 = 1 st week of the Year to 52 = 52 nd week of the Year |

Storage

All KO-CAP series are shipped in moisture barrier bags with a desiccant and moisture indicator card. These series are classified as MSL3 (Moisture Sensitivity Level 3). Product contained within the moisture barrier bags should be stored in normal working environments with temperatures not to exceed 40°C and humidity not in excess of 60% RH.

Overview

The KEMET Organic Capacitor (KO-CAP) is a tantalum capacitor with a Ta anode and Ta₂O₅ dielectric. A conductive organic polymer replaces the traditionally used MnO₂ as the cathode plate of the capacitor. This results in very low ESR and improved capacitance retention at high frequency. The KO-CAP also exhibits a benign failure mode which eliminates the ignition failures that can occur in standard MnO₂ tantalum types. KO-CAPs may also be operated at steady state voltages up to 90% of rated voltage for part types with rated voltages of ≤10 volts and up to 80% of rated voltage for part types >10 volts with equivalent or better reliability than traditional MnO₂ tantalum capacitors operated at 50% of rated voltage.

The T530 Series KO-CAP offers the same advantages as the T520 Series but also has the added advantages of higher capacitance, 125°C performance capability, higher ripple current handling capability and a lower ESR range. Packaged as multiple anodes to reduce the depth that the signal must penetrate, this parallel arrangement reduces the ESR further still to achieve the highest capacitance and lowest ESR of any other type of surface mount capacitor with typical ESR values as low as 4 mΩ. With reduced ESR, the enhanced capacitance retention at higher frequencies provides the lowest total capacitance and most economical solution for high power applications.

Benefits

- ESR: 4 mΩ to 40 mΩ
- 125°C maximum operating temperature
- Polymer cathode technology
- High frequency capacitance retention
- Non-ignition failure mode
- Capacitance: 150 μF to 1,500 μF
- 100% accelerated steady state aging
- 100% surge current tested
- Utilizes multiple tantalum anode technology
- Volumetric efficiency
- Use up to 90% of rated voltage (10% derating) for part types ≤ 10 V
- Use up to 80% of rated voltage (20% derating) for part types > 10 V
- Self-healing mechanism
- EIA standard case sizes

Applications

Typical applications include high speed server, microprocessor decoupling and high ripple current applications.



Environmental Compliance

RoHS Compliant (6/6) according to Directive 2002/95/EC when ordered with 100% Sn Solder



RoHS Compliant

SPICE

For a detailed analysis of specific part numbers, please visit www.kemet.com for a free download of KEMET's SPICE software. The KEMET SPICE program is freeware intended to aid design engineers in analyzing the performance of these capacitors over frequency, temperature, ripple, and DC bias conditions.

Ordering Information

| T | 530 | X | 337 | M | 010 | A | T | E005 | |
|-----------------|--|-----------|--|-----------------------|--|---------------------|--|--|------------------------------------|
| Capacitor Class | Series | Case Size | Capacitance Code (pF) | Capacitance Tolerance | Voltage | Failure Rate/Design | Lead Material | ESR Code | Packaging (C-Spec) |
| T = Tantalum | 530 = High Capacitance 125°C Rated Polymer | D, X, Y | First two digits represent significant figures. Third digit specifies number of zeros. | M = ±20% | 2R5 = 2.5 V 003 = 3 V 004 = 4 V 006 = 6.3 V 010 = 10 V 016 = 16 V | A = N/A | T = 100% Matte Tin (Sn) Plated H = Tin/Lead (SnPb) Solder Coated (5% Pb minimum) G = Gold Plated | E = ESR Last three digits specify ESR in mΩ (005 = 5 mΩ) | Blank = 7" Reel 7280 = 13" Reel |

Performance Characteristics

| Item | Performance Characteristics |
|-------------------------|---|
| Operating Temperature | -55°C to 125°C |
| Rated Capacitance Range | 150 – 1,500 μF @ 120 Hz/25°C |
| Capacitance Tolerance | M Tolerance (20%) |
| Rated Voltage Range | 2.5 – 16 V |
| DF (120 Hz) | 8% |
| ESR (100 kHz) | Refer to Part Number Electrical Specification Table |
| Leakage Current | ≤ 0.1 CV (μA) at rated voltage after 5 minutes |

Qualification

| Test | Condition | Characteristics | | | | |
|----------------------------|--|-----------------|-----------------------------------|-------|----------|----------|
| Endurance | 105°C @ rated voltage, 2,000 hours 125°C @ 2/3 rated voltage, 2,000 hours | Δ C/C | Within -20%/+10% of initial value | | | |
| | | DF | ≤ initial limit | | | |
| | | DCL | 2 x initial limit @ 125°C | | | |
| | | ESR | 2 x initial limit | | | |
| Storage Life | 125°C @ 0 volts, 2,000 hours | Δ C/C | Within -20%/+10% of initial value | | | |
| | | DF | Within initial limits | | | |
| | | DCL | Within 2.0 x initial limit | | | |
| | | ESR | Within 2.0 x initial limit | | | |
| Humidity | 60°C, 90% RH, 1,000 hours, No Load | Δ C/C | Within -5%/+35% of initial value | | | |
| | | DF | ≤ initial limit | | | |
| | | DCL | Within 3.0 x initial limit | | | |
| Temperature Stability | Extreme temperature exposure at a succession of continuous steps at +25°C, -55°C, +25°C, +85°C, +105°C, +25°C | | +25°C | -55°C | +85°C | +125°C |
| | | Δ C/C | IL* | ±20% | ±20% | ±30% |
| | | DF | IL | IL | 1.2 x IL | 1.5 x IL |
| Surge Voltage | 105°C, 1.32 x rated voltage, 33Ω Resistance, 1,000 cycles | Δ C/C | Within -20%/+10% of initial value | | | |
| | | DF | Within initial limits | | | |
| | | DCL | Within initial limits | | | |
| | | ESR | Within initial limits | | | |
| Mechanical Shock/Vibration | MIL-STD-202, Method 213, Condition I, 100 G peak MIL-STD-202, Method 204, Condition D, 10 Hz to 2,000 Hz, 20 G peak | Δ C/C | Within ±10% of initial value | | | |
| | | DF | Within initial limits | | | |
| | | DCL | Within initial limits | | | |

*IL = Initial limit

Certification

DSCC Drawing 04052

Electrical Characteristics

ESR vs. Frequency



Capacitance vs. Frequency



Dimensions – Millimeters (Inches)

Metric will govern



| Case Size | | Component | | | | | | | | | | | | |
|-----------|---------|----------------------------|----------------------------|----------------------------|--------------------|--------------------|-------------------------|------------------------------|------------|------------|-------------|------------|------------|------------|
| KEMET | EIA | L* | W* | H* | F* ±0.1 ±(.004) | S* ±0.3 ±(.012) | B* ±0.15 (Ref) ±.006 | X (Ref) | P (Ref) | R (Ref) | T (Ref) | A (Min) | G (Ref) | E (Ref) |
| D | 7343-31 | 7.3 ±0.3 (0.287 ±0.012) | 4.3 ±0.3 (0.169 ±0.012) | 2.8 ±0.3 (0.110 ±0.012) | 2.4 (.094) | 1.3 (.051) | 0.5 (.020) | 0.10 ± 0.10 (.004 ± .004) | 0.9 (.035) | 1.0 (.039) | 0.13 (.005) | 3.8 (.150) | 3.5 (.138) | 3.5 (.138) |
| X | 7343-43 | 7.3 ±0.3 (0.287 ±0.012) | 4.3 ±0.3 (0.169 ±0.012) | 4.3 ±0.3 (0.157 ±0.012) | 2.4 (.094) | 1.3 (.051) | 0.5 (.020) | 0.10 ± 0.10 (.004 ± .004) | 1.7 (.067) | 1.0 (.039) | 0.13 (.005) | 3.8 (.150) | 3.5 (.138) | 3.5 (.138) |
| Y | 7343-40 | 7.3 ±0.3 (0.287 ±0.012) | 4.3 ±0.3 (0.169 ±0.012) | 4.0 (0.157) | 2.4 (.094) | 1.3 (.051) | 0.5 (.020) | 0.10 ± 0.10 (.004 ± .004) | 1.7 (.067) | 1.0 (.039) | 0.13 (.005) | 3.8 (.150) | 3.5 (.138) | 3.5 (.138) |

Notes: (Ref) – Dimensions provided for reference only. No dimensions are provided for B, P or R because low profile cases do not have a bevel or a notch.

* MIL-PRF-55365/8 specified dimensions

Table 1 – Ratings & Part Number Reference

| Rated Voltage | Rated Cap | Case Code/ Case Size | KEMET Part Number | DC Leakage | DF | ESR | Maximum Allowable Ripple Current | Moisture Sensitivity | Rated Temp |
|---------------|-----------|-------------------------|------------------------------|----------------------------------|--------------------------|----------------------------|----------------------------------|----------------------|------------|
| VDC | µF | KEMET/EIA | (See below for part options) | µA @ +20°C Maximum/ 5 Minutes | % @ +20°C 120 Hz Maximum | mΩ @ +20°C 100 kHz Maximum | (mA) +45°C 100 kHz | Temperature ≤ 260°C | (°C) |
| 2.5 | 470 | D/7343-31 | T530D477M2R5A(1)E005 | 118 | 8 | 5 | 7100 | 3 | 125 |
| 2.5 | 470 | D/7343-31 | T530D477M2R5A(1)E006 | 118 | 8 | 6 | 6500 | 3 | 125 |
| 2.5 | 470 | D/7343-31 | T530D477M2R5A(1)E010 | 118 | 8 | 10 | 5000 | 3 | 125 |
| 2.5 | 560 | D/7343-31 | T530D567M2R5A(1)E005 | 140 | 8 | 5 | 7100 | 3 | 125 |
| 2.5 | 680 | Y/7343-40 | T530Y687M2R5A(1)E005 | 170 | 8 | 5 | 7300 | 3 | 125 |
| 2.5 | 680 | Y/7343-40 | T530Y687M2R5A(1)E006 | 170 | 8 | 6 | 6600 | 3 | 125 |
| 2.5 | 680 | Y/7343-40 | T530Y687M2R5(1)E007 | 170 | 8 | 7 | 6100 | 3 | 125 |
| 2.5 | 680 | D/7343-31 | T530D687M2R5A(1)E006 | 170 | 8 | 6 | 6500 | 3 | 125 |
| 2.5 | 680 | D/7343-31 | T530D687M2R5A(1)E010 | 170 | 8 | 10 | 5000 | 3 | 125 |
| 2.5 | 680 | D/7343-31 | T530D687M2R5(1)E007 | 170 | 8 | 7 | 6000 | 3 | 125 |
| 2.5 | 680 | X/7343-43 | T530X687M2R5A(1)E006 | 170 | 8 | 6 | 6700 | 3 | 125 |
| 2.5 | 1000 | Y/7343-40 | T530Y108M2R5A(1)E005 | 250 | 8 | 5 | 7300 | 3 | 125 |
| 2.5 | 1000 | Y/7343-40 | T530Y108M2R5A(1)E006 | 250 | 8 | 6 | 6600 | 3 | 125 |
| 2.5 | 1000 | X/7343-43 | T530X108M2R5A(1)E004 | 250 | 8 | 4 | 8200 | 3 | 125 |
| 2.5 | 1000 | X/7343-43 | T530X108M2R5A(1)E005 | 250 | 8 | 5 | 7300 | 3 | 125 |
| 2.5 | 1000 | X/7343-43 | T530X108M2R5A(1)E006 | 250 | 8 | 6 | 6700 | 3 | 125 |
| 2.5 | 1500 | X/7343-43 | T530X158M2R5A(1)E005 | 375 | 8 | 5 | 7300 | 3 | 125 |
| 3 | 470 | D/7343-31 | T530D477M003A(1)E010 | 141 | 8 | 10 | 5000 | 3 | 125 |
| 3 | 680 | D/7343-31 | T530D687M003A(1)E010 | 204 | 8 | 10 | 5000 | 3 | 125 |
| 3 | 1000 | X/7343-43 | T530X108M003A(1)E010 | 300 | 8 | 10 | 5200 | 3 | 125 |
| 3 | 1500 | X/7343-43 | T530X158M003A(1)E008 | 450 | 8 | 8 | 5800 | 3 | 125 |
| 4 | 330 | D/7343-31 | T530D337M004A(1)E005 | 132 | 8 | 5 | 7100 | 3 | 125 |
| 4 | 330 | D/7343-31 | T530D337M004A(1)E006 | 132 | 8 | 6 | 6500 | 3 | 125 |
| 4 | 470 | D/7343-31 | T530D477M004A(1)E006 | 188 | 8 | 6 | 6500 | 3 | 125 |
| 4 | 470 | D/7343-31 | T530D477M004A(1)E010 | 188 | 8 | 10 | 5000 | 3 | 125 |
| 4 | 470 | Y/7343-40 | T530Y477M004A(1)E005 | 188 | 8 | 5 | 7300 | 3 | 125 |
| 4 | 470 | Y/7343-40 | T530Y477M004A(1)E006 | 188 | 8 | 6 | 6600 | 3 | 125 |
| 4 | 680 | Y/7343-40 | T530Y687M004A(1)E005 | 272 | 8 | 5 | 7300 | 3 | 125 |
| 4 | 680 | X/7343-43 | T530X687M004A(1)E004 | 272 | 8 | 4 | 8200 | 3 | 125 |
| 4 | 680 | X/7343-43 | T530X687M004A(1)E005 | 272 | 8 | 5 | 7300 | 3 | 125 |
| 4 | 680 | X/7343-43 | T530X687M004A(1)E006 | 272 | 8 | 6 | 6700 | 3 | 125 |
| 4 | 680 | X/7343-43 | T530X687M004A(1)E010 | 272 | 8 | 10 | 5200 | 3 | 125 |
| 4 | 1000 | X/7343-43 | T530X108M004A(1)E006 | 400 | 8 | 6 | 6700 | 3 | 125 |
| 6.3 | 220 | D/7343-31 | T530D227M006A(1)E005 | 139 | 8 | 5 | 7100 | 3 | 125 |
| 6.3 | 220 | D/7343-31 | T530D227M006A(1)E006 | 139 | 8 | 6 | 6500 | 3 | 125 |
| 6.3 | 330 | D/7343-31 | T530D337M006A(1)E006 | 208 | 8 | 6 | 6500 | 3 | 125 |
| 6.3 | 330 | D/7343-31 | T530D337M006A(1)E010 | 208 | 8 | 10 | 5000 | 3 | 125 |
| 6.3 | 330 | Y/7343-40 | T530Y337M006A(1)E005 | 208 | 8 | 5 | 7300 | 3 | 125 |
| 6.3 | 330 | Y/7343-40 | T530Y337M006A(1)E006 | 208 | 8 | 6 | 6600 | 3 | 125 |
| 6.3 | 330 | Y/7343-40 | T530Y337M006A(1)E010 | 208 | 8 | 10 | 5100 | 3 | 125 |
| 6.3 | 470 | Y/7343-40 | T530Y477M006A(1)E005 | 296 | 8 | 5 | 7300 | 3 | 125 |
| 6.3 | 470 | X/7343-43 | T530X477M006A(1)E004 | 296 | 8 | 4 | 8200 | 3 | 125 |
| 6.3 | 470 | X/7343-43 | T530X477M006A(1)E005 | 296 | 8 | 5 | 7300 | 3 | 125 |
| 6.3 | 470 | X/7343-43 | T530X477M006A(1)E006 | 296 | 8 | 6 | 6700 | 3 | 125 |
| 6.3 | 470 | X/7343-43 | T530X477M006A(1)E010 | 296 | 8 | 10 | 5200 | 3 | 125 |
| 6.3 | 680 | X/7343-43 | T530X687M006A(1)E010 | 428 | 8 | 10 | 5200 | 3 | 125 |
| VDC | µF | KEMET/EIA | (See below for part options) | µA @ +20°C Maximum/ 5 Minutes | % @ +20°C 120 Hz Maximum | mΩ @ +20°C 100 kHz Maximum | (mA) +45°C 100 kHz | Temperature ≤ 260°C | (°C) |
| Rated Voltage | Rated Cap | Case Code/ Case Size | KEMET Part Number | DC Leakage | DF | ESR | Maximum Allowable Ripple Current | Moisture Sensitivity | Rated Temp |

Other part number options:

(1) Standard with tin terminations (14th character = T). Tin/lead terminations is also available (14th character = H).

Also available on large (13 inch) reels. Add 7280 to the end of the part number.

Higher voltage ratings and tighter tolerance product including ESR may be substituted within the same size at KEMET's option. Voltage substitutions will be marked with the higher voltage rating. Substitutions can include better than series.

Table 1 – Ratings & Part Number Reference cont'd

| Rated Voltage | Rated Cap | Case Code/ Case Size | KEMET Part Number | DC Leakage | DF | ESR | Maximum Allowable Ripple Current | Moisture Sensitivity | Rated Temp |
|---------------|-----------|-------------------------|------------------------------|----------------------------------|--------------------------|----------------------------|----------------------------------|----------------------|------------|
| VDC | µF | KEMET/EIA | (See below for part options) | µA @ +20°C Maximum/ 5 Minutes | % @ +20°C 120 Hz Maximum | mΩ @ +20°C 100 kHz Maximum | (mA) +45°C 100 kHz | Temperature ≤ 260°C | (°C) |
| 6.3 | 680 | X/7343-43 | T530X687M006A(1)E018 | 428 | 8 | 18 | 3900 | 3 | 125 |
| 10 | 150 | D/7343-31 | T530D157M010A(1)E005 | 150 | 8 | 5 | 7100 | 3 | 125 |
| 10 | 150 | D/7343-31 | T530D157M010A(1)E006 | 150 | 8 | 6 | 6500 | 3 | 125 |
| 10 | 150 | D/7343-31 | T530D157M010A(1)E010 | 150 | 8 | 10 | 5000 | 3 | 125 |
| 10 | 220 | D/7343-31 | T530D227M010A(1)E006 | 220 | 8 | 6 | 6500 | 3 | 125 |
| 10 | 220 | D/7343-31 | T530D227M010A(1)E010 | 220 | 8 | 10 | 5000 | 3 | 125 |
| 10 | 220 | Y/7343-40 | T530Y227M010A(1)E006 | 220 | 8 | 6 | 6600 | 3 | 125 |
| 10 | 330 | X/7343-43 | T530X337M010A(1)E004 | 330 | 8 | 4 | 8200 | 3 | 125 |
| 10 | 330 | X/7343-43 | T530X337M010A(1)E005 | 330 | 8 | 5 | 7300 | 3 | 125 |
| 10 | 330 | X/7343-43 | T530X337M010A(1)E006 | 330 | 8 | 6 | 6700 | 3 | 125 |
| 10 | 330 | X/7343-43 | T530X337M010A(1)E010 | 330 | 8 | 10 | 5200 | 3 | 125 |
| 16 | 150 | X/7343-43 | T530X157M016A(1)E015 | 240 | 8 | 15 | 4200 | 3 | 125 |
| 16 | 150 | X/7343-43 | T530X157M016A(1)E025 | 240 | 8 | 25 | 3300 | 3 | 125 |
| 16 | 150 | X/7343-43 | T530X157M016A(1)E040 | 240 | 8 | 40 | 2600 | 3 | 125 |
| VDC | µF | KEMET/EIA | (See below for part options) | µA @ +20°C Maximum/ 5 Minutes | % @ +20°C 120 Hz Maximum | mΩ @ +20°C 100 kHz Maximum | (mA) +45°C 100 kHz | Temperature ≤ 260°C | (°C) |
| Rated Voltage | Rated Cap | Case Code/ Case Size | KEMET Part Number | DC Leakage | DF | ESR | Maximum Allowable Ripple Current | Moisture Sensitivity | Rated Temp |

Other part number options:

(1) Standard with tin terminations (14th character = T). Tin/lead terminations is also available (14th character = H).

Also available on large (13 inch) reels. Add 7280 to the end of the part number.

Higher voltage ratings and tighter tolerance product including ESR may be substituted within the same size at KEMET's option. Voltage substitutions will be marked with the higher voltage rating. Substitutions can include better than series.

Derating Guidelines

| Voltage Rating | Maximum Recommended Steady State Voltage | Maximum Recommended Transient Voltage (1 ms – 1 μs) |
|--|--|---|
| -55°C to 105°C | | |
| $2.5\text{ V} \leq V_R \leq 10\text{ V}$ | 90% of V_R | V_R |
| $V_R = 16\text{ V}$ | 80% of V_R | V_R |
| 105°C to 125°C | | |
| $2.5\text{ V} \leq V_R \leq 10\text{ V}$ | 60% of V_R | 67% of V_R |
| $V_R = 16\text{ V}$ | 54% of V_R | 67% of V_R |

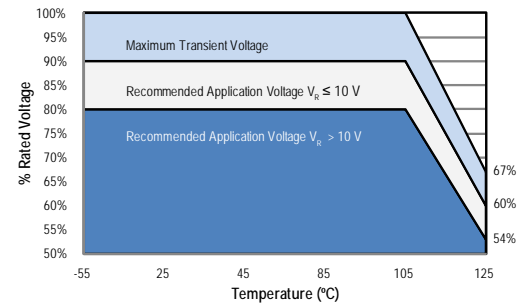

V_R = Rated Voltage

Ripple Current/Ripple Voltage

Permissible AC ripple voltage and current are related to equivalent series resistance (ESR) and the power dissipation capabilities of the device. Permissible AC ripple voltage which may be applied is limited by two criteria:

1. The positive peak AC voltage plus the DC bias voltage, if any, must not exceed the DC voltage rating of the capacitor.
2. The negative peak AC voltage in combination with bias voltage, if any, must not exceed the allowable limits specified for reverse voltage. See the Reverse Voltage section for allowable limits.

The maximum power dissipation by case size can be determined using the table at right. The maximum power dissipation rating stated in the table must be reduced with increasing environmental operating temperatures. Refer to the table below for temperature compensation requirements.

| Case Code | EIA Case Code | Maximum Power Dissipation (P max) mWatts @ 45°C with +30°C Rise |
|-----------|---------------|---|
| W | 7343-15 | 325 |
| Z | 7343-17 | 325 |
| D | 7343-31 | 255 |
| Y | 7343-40 | 263 |
| X | 7443-43 | 270 |

The maximum power dissipation rating must be reduced with increasing environmental operating temperatures. Refer to the Temperature Compensation Multiplier table for details.

| Temperature Compensation Multipliers for Maximum Power Dissipation | | |
|--|--|---|
| $\leq 45^\circ\text{C}$ | $45^\circ\text{C} < T \leq 85^\circ\text{C}$ | $85^\circ\text{C} < T \leq 125^\circ\text{C}$ |
| 1.00 | 0.70 | 0.25 |

T = Environmental Temperature

Using the P max of the device, the maximum allowable rms ripple current or voltage may be determined.

$$I(\text{max}) = \sqrt{P \text{ max}/R}$$

$$E(\text{max}) = \sqrt{P \text{ max} \cdot R}$$

I = rms ripple current (amperes)

E = rms ripple voltage (volts)

$P \text{ max}$ = maximum power dissipation (watts)

R = ESR at specified frequency (ohms)

Reverse Voltage

Polymer tantalum capacitors are polar devices and may be permanently damaged or destroyed if connected in the wrong polarity. These devices will withstand a small degree of transient voltage reversal for short periods as shown in the below table.

| Temperature | Permissible Transient Reverse Voltage |
|-------------|---------------------------------------|
| 25°C | 15% of Rated Voltage |
| 55°C | 10% of Rated Voltage |
| 85°C | 5% of Rated Voltage |
| 105°C | 3% of Rated Voltage |
| 125°C* | 1% of Rated Voltage |

*For series rated to 125°C

Table 2 – Land Dimensions/Courtyard

| KEMET | Metric Size Code | Density Level A: Maximum (Most) Land Protrusion (mm) | | | | | Density Level B: Median (Nominal) Land Protrusion (mm) | | | | | Density Level C: Minimum (Least) Land Protrusion (mm) | | | | |
|----------------|------------------|--|------|------|-------|------|--|------|------|------|------|---|------|------|------|------|
| | | X | Y | C | V1 | V2 | X | Y | C | V1 | V2 | X | Y | C | V1 | V2 |
| Case | EIA | | | | | | | | | | | | | | | |
| D | 7343-31 | 2.55 | 3.75 | 2.70 | 10.20 | 5.50 | 2.45 | 3.35 | 2.60 | 9.10 | 5.00 | 2.35 | 2.95 | 2.50 | 8.20 | 4.70 |
| X ¹ | 7343-43 | 2.55 | 3.75 | 2.70 | 10.20 | 5.50 | 2.45 | 3.35 | 2.60 | 9.10 | 5.00 | 2.35 | 2.95 | 2.50 | 8.20 | 4.70 |
| Y ¹ | 7343-40 | 2.55 | 3.75 | 2.70 | 10.20 | 5.50 | 2.45 | 3.35 | 2.60 | 9.10 | 5.00 | 2.35 | 2.95 | 2.50 | 8.20 | 4.70 |

Density Level A: For low-density product applications. Recommended for wave solder applications and provides a wider process window for reflow solder processes.

Density Level B: For products with a moderate level of component density. Provides a robust solder attachment condition for reflow solder processes.

Density Level C: For high component density product applications. Before adapting the minimum land pattern variations the user should perform qualification testing based on the conditions outlined in IPC Standard 7351 (IPC-7351).

¹ Height of these chips may create problems in wave soldering.



Soldering Process

KEMET's families of surface mount capacitors are compatible with wave (single or dual), convection, IR, or vapor phase reflow techniques. Preheating of these components is recommended to avoid extreme thermal stress. KEMET's recommended profile conditions for convection and IR reflow reflect the profile conditions of the IPC/J-STD-020D standard for moisture sensitivity testing. The devices can safely withstand a maximum of three reflow passes at these conditions.

Please note that although the X/7343-43 case size can withstand wave soldering, the tall profile (4.3 mm maximum) dictates care in wave process development.

Hand soldering should be performed with care due to the difficulty in process control. If performed, care should be taken to avoid contact of the soldering iron to the molded case. The iron should be used to heat the solder pad, applying solder between the pad and the termination, until reflow occurs. Once reflow occurs, the iron should be removed immediately. "Wiping" the edges of a chip and heating the top surface is not recommended.

During typical reflow operations, a slight darkening of the gold-colored epoxy may be observed. This slight darkening is normal and not harmful to the product. Marking permanency is not affected by this change.

| Profile Feature | SnPb Assembly | Pb-Free Assembly |
|---|---------------------|---------------------|
| Preheat/Soak | | |
| Temperature Minimum (T_{smin}) | 100°C | 150°C |
| Temperature Maximum (T_{smax}) | 150°C | 200°C |
| Time (t_s) from T_{smin} to T_{smax} | 60 – 120 seconds | 60 – 120 seconds |
| Ramp-up Rate (T_L to T_p) | 3°C/seconds maximum | 3°C/seconds maximum |
| Liquidous Temperature (T_L) | 183°C | 217°C |
| Time Above Liquidous (t_L) | 60 – 150 seconds | 60 – 150 seconds |
| Peak Temperature (T_p) | 220°C* 235°C** | 250°C* 260°C** |
| Time within 5°C of Maximum Peak Temperature (t_p) | 20 seconds maximum | 30 seconds maximum |
| Ramp-down Rate (T_p to T_L) | 6°C/seconds maximum | 6°C/seconds maximum |
| Time 25°C to Peak Temperature | 6 minutes maximum | 8 minutes maximum |

Note: All temperatures refer to the center of the package, measured on the package body surface that is facing up during assembly reflow.

*Case Size D, E, P, Y, and X

**Case Size A, B, C, H, I, K, M, R, S, T, U, V, W, and Z



Construction



Capacitor Marking



* 230 = 30th week of 2012

| Date Code * | |
|--|--|
| 1 st digit = Last number of Year | 9 = 2009 0 = 2010 1 = 2011 2 = 2012 3 = 2013 4 = 2014 |
| 2 nd and 3 rd digit = Week of the Year | 01 = 1 st week of the Year to 52 = 52 nd week of the Year |

Storage

All KO-CAP series are shipped in moisture barrier bags with a desiccant and moisture indicator card. These series are classified as MSL3 (Moisture Sensitivity Level 3). Product contained within the moisture barrier bags should be stored in normal working environments with temperatures not to exceed 40°C and humidity not in excess of 60% RH.

Overview

The KEMET Organic Capacitor is a tantalum capacitor with a Ta anode and Ta₂O₅ dielectric. A conductive organic polymer replaces the traditionally used MnO₂ as the cathode plate of the capacitor. This results in very low ESR, improved capacitance retention at high frequency and improved ripple current handling capability. The polymer technology also exhibits a benign failure mode which eliminates the ignition failures. Tantalum polymers may also be operated at voltages up to 90% of rated voltage for part types with rated voltages of ≤ 10 volts and up to 80% of rated voltage for part types > 10 volts with equivalent or better reliability than traditional MnO₂ tantalum capacitors operated at 50% of rated voltage.

The T543 Series Polymer Tantalum COTS is an upscreened version of KEMET's commercial polymer product offering and captures the best features of multilayer ceramic capacitors (low ESR, high frequency capacitance retention), aluminum electrolytic capacitors (higher capacitance, benign failure mode), and proven solid tantalum technology (volumetric efficiency, surface mount capability, extremely long life). The T543 also offers an option for surge current testing (10 cycles at +25°C and 10 cycles at -55°C/+85°C) and termination finish (SnPb and 100% Sn).

Benefits

- Extremely low ESR
- -55°C to 105°C operating temperature range
- Polymer cathode technology
- High frequency capacitance retention
- Non-ignition failure mode
- Capacitance up to 1,500 µF
- Enhanced derating
- 100% accelerated steady state aging
- 100% surge current tested
- Taped and reeled per EIA 481-1
- Volumetric efficiency and self-healing mechanism
- Termination options (SnPb and 100% Sn)
- Surge options at 25°C and -55°C/85°C
- EIA standard case sizes

Applications

Typical applications include DC/DC converters, switch mode and point of load power supply, radar pulse capacitor and telecommunications (mobile phone and base station). Other general applications include decoupling and filtering in applications requiring low ESR or a benign failure mode.



Environmental Compliance

RoHS Compliant (6/6) according to Directive 2002/95/EC when ordered with 100% Sn solder.



RoHS Compliant

SPICE

For a detailed analysis of specific part numbers, please visit www.kemet.com for a free download of KEMET's SPICE software. The KEMET SPICE program is freeware intended to aid design engineers in analyzing the performance of these capacitors over frequency, temperature, ripple, and DC bias conditions.

Ordering Information

| T | 543 | D | 156 | K | 035 | A | H | E | 100 |
|-----------------|-----------------------|---------------------------------------|--|----------------------------------|--|---------------------|--|--|-----------|
| Capacitor Class | Series | Case Size | Capacitance Code (pF) | Capacitance Tolerance | Voltage | Failure Rate/Design | Lead Material | Surge | ESR |
| T = Tantalum | Polymer Tantalum COTS | A, B, C, D, H, L, M, T, U, V, W, X, Y | First two digits represent significant figures. Third digit specifies number of zeros. | K = $\pm 10\%$ M = $\pm 20\%$ | 2R5 = 2.5 V 003 = 3 V 004 = 4 V 006 = 6.3 V 010 = 10 V 12R = 12.5 V 016 = 16 V 020 = 20 V 025 = 25 V 035 = 35 V 050 = 50 V 063 = 63 V | A = N/A | H = Standard Solder Coated (SnPb 5% Pb minimum) T = 100% Tin (Sn) | E = None S = 10 cycles 25°C W = 10 cycles -55°C and 85°C | ESR in mΩ |

Performance Characteristics

| Item | Performance Characteristics |
|-------------------------|--|
| Operating Temperature | -55°C to 105°C |
| Rated Capacitance Range | 5.6 – 1,500 μF @ 120 Hz/25°C |
| Capacitance Tolerance | K Tolerance (10%), M Tolerance (20%) |
| Rated Voltage Range | 2.5 – 63 V |
| DF (120 Hz) | Refer to Part Number Electrical Specification Table |
| ESR (100 kHz) | Refer to Part Number Electrical Specification Table |
| Leakage Current | $\leq 0.1 \text{ CV}$ (μA) at rated voltage after 5 minutes |

Qualification

| Test | Condition | Characteristics | | | | |
|----------------------------|--|-----------------|----------------------------------|--------|----------|----------|
| Endurance | 105°C @ rated voltage, 2,000 hours | Δ C/C | Within -20/+10 of initial value | | | |
| | | DF | Within initial limits | | | |
| | | DCL | Within 1.25 x initial limit | | | |
| | | ESR | Within 2.0 x initial limit | | | |
| Storage Life | 105°C @ 0 volts, 2,000 hours | Δ C/C | Within -20/+10 of initial value | | | |
| | | DF | Within initial limits | | | |
| | | DCL | Within 1.25 x initial limit | | | |
| | | ESR | Within 2.0 x initial limit | | | |
| Humidity | 60°C, 90% RH, 500 hours | Δ C/C | Within -5%/+35% of initial value | | | |
| | | DF | Within initial limits | | | |
| | | DCL | Within 5.0 x initial limit | | | |
| | | ESR | Within 2.0 x initial limit | | | |
| Temperature Stability | Extreme temperature exposure at a succession of continuous steps at +25°C, -55°C, +25°C, +85°C, +105°C, +25° C | +25°C | -55°C | +85°C | +105°C | |
| | | Δ C/C | IL* | +/-20% | +/-20% | +/-30% |
| | | DF | IL | IL | 1.2 x IL | 1.5 x IL |
| | | DCL | IL | n/a | 10 x IL | 10 x IL |
| Surge Voltage | 105°C, 1.32 x rated voltage, 1,000 cycles | Δ C/C | Within -20/+10 of initial value | | | |
| | | DF | Within initial limits | | | |
| | | DCL | Within initial limits | | | |
| | | ESR | Within initial limits | | | |
| Mechanical Shock/Vibration | MIL-STD-202, Method 213, Condition I, 100 G peak MIL-STD-202, Method 204, Condition D, 10 Hz to 2,000 Hz, 20 G peak | Δ C/C | Within ±10 of initial value | | | |
| | | DF | Within initial limits | | | |
| | | DCL | Within initial limits | | | |

*IL = Initial limit

Electrical Characteristics

ESR vs. Frequency

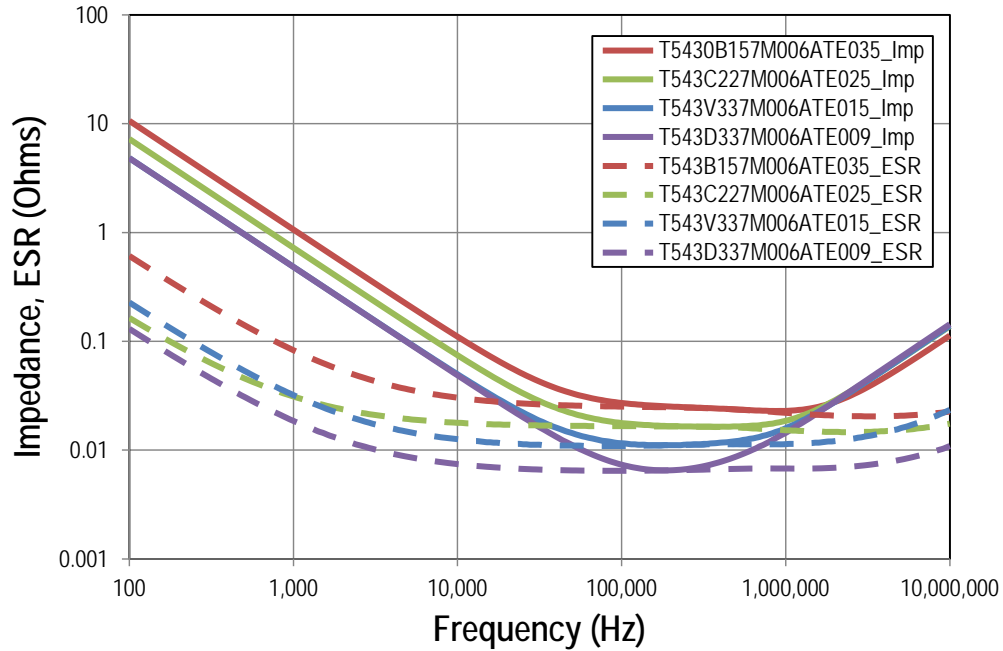

Capacitance vs. Frequency

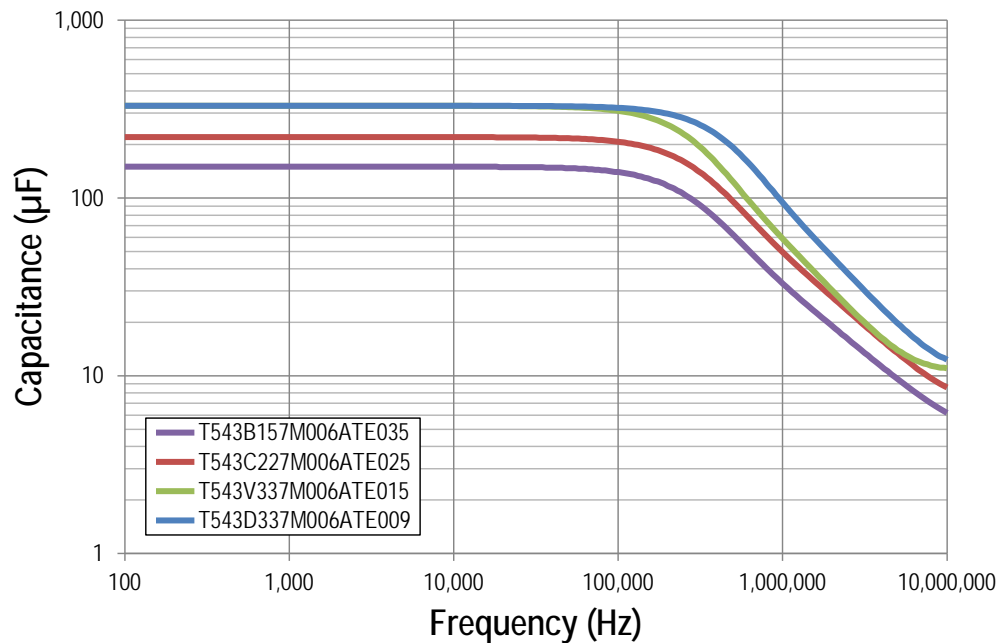

Dimensions – Millimeters



| Case Size | | Component | | | | | | | | | | | | |
|-----------|---------|----------------------------|----------------------------|----------------------------|---------------------|---------------------|--------------------------|------------------------------|-------------|-------------|--------------|-------------|-------------|-------------|
| KEMET | EIA | L* | W* | H* | F* ±0.1 ±(0.004) | S* ±0.3 ±(0.012) | B* ±0.15 (Ref) ±0.006 | X (Ref) | P (Ref) | R (Ref) | T (Ref) | A (Min) | G (Ref) | E (Ref) |
| A | 3216-18 | 3.2 ±0.2 (0.126 ±0.008) | 1.6 ±0.2 (0.063 ±0.008) | 1.6 ±0.2 (0.063 ±0.008) | 1.2 (0.047) | 0.8 (0.031) | 0.4 (0.016) | 0.10 ±0.10 (0.004 ±0.004) | 0.4 (.016) | 0.4 (0.016) | 0.13 (0.005) | 0.8 (.31) | 1.1 (0.043) | 1.3 (0.051) |
| B | 3528-21 | 3.5 ±0.2 (0.138 ±0.008) | 2.8 ±0.2 (0.110 ±0.008) | 1.9 ±0.2 (0.075 ±0.008) | 2.2 (0.087) | 0.8 (0.031) | 0.4 (0.016) | 0.10 ±0.10 (0.004 ±0.004) | 0.5 (.020) | 1.0 (0.039) | 0.13 (0.005) | 1.1 (0.043) | 1.8 (0.071) | 2.2 (0.087) |
| C | 6032-28 | 6.0 ±0.3 (0.236 ±0.03) | 3.2 ±0.3 (0.126 ±0.012) | 2.5 ±0.3 (0.098 ±0.012) | 2.2 (0.087) | 1.3 (0.051) | 0.5 (0.020) | 0.10 ±0.10 (0.004 ±0.004) | 0.9 (.035) | 1.0 (0.039) | 0.13 (0.005) | 2.5 (.098) | 2.8 (0.110) | 2.4 (0.094) |
| D | 7343-31 | 7.3 ±0.3 (0.287 ±0.012) | 4.3 ±0.3 (0.169 ±0.012) | 2.8 ±0.3 (0.110 ±0.012) | 2.4 (0.094) | 1.3 (0.051) | 0.5 (0.020) | 0.10 ±0.10 (0.004 ±0.004) | 0.9 (0.035) | 1.0 (0.039) | 0.13 (0.005) | 3.8 (.150) | 3.5 (0.138) | 3.5 (0.138) |
| H | 7360-20 | 7.3 ±0.3 (0.287 ±0.012) | 6.0 ±0.3 (0.236 ±0.012) | 2.0 (0.078) Maximum | 4.1 (0.161) | 1.3 (0.051) | n/a | 0.10 ±0.10 (0.004 ±0.004) | n/a | n/a | 0.13 (0.005) | 3.3 (.130) | 3.5 (0.138) | 3.5 (0.138) |
| L | 6032-19 | 6.0 ±0.3 (0.236 ±0.012) | 3.2 ±0.2 (0.110 ±0.008) | 1.9 (0.075) | 2.2 (0.087) | 1.3 (0.051) | n/a | 0.05 (0.002) | n/a | n/a | 0.13 (0.005) | 2.5 (.098) | 2.8 (0.110) | 2.4 (0.094) |
| M | 3528-15 | 3.5 ±0.2 (0.138 ±0.008) | 2.8 ±0.2 (0.110 ±0.008) | 1.5 (0.059) | 2.2 (0.087) | 0.8 (0.031) | n/a | 0.05 (0.002) | n/a | n/a | 0.13 (0.005) | 1.1 (.043) | 1.8 (0.071) | 2.2 (0.087) |
| T | 3528-12 | 3.5 ±0.2 (0.138 ±0.008) | 2.8 ±0.2 (0.110 ±0.008) | 1.2 (0.047) | 2.2 (0.087) | 0.8 (0.031) | n/a | 0.05 (0.002) | n/a | n/a | 0.13 (0.005) | 1.1 (.043) | 1.8 (0.071) | 2.2 (0.087) |
| U | 6032-15 | 6.0 ±0.3 (0.236 ±0.012) | 3.2 ±0.2 (0.110 ±0.008) | 1.5 (0.059) | 2.2 (0.087) | 1.3 (0.051) | n/a | 0.05 (0.002) | n/a | n/a | 0.13 (0.005) | 2.5 (.098) | 2.8 (0.110) | 2.4 (0.094) |
| V | 7343-20 | 7.3 ±0.3 (0.287 ±0.012) | 4.3 ±0.3 (0.169 ±0.012) | 2.0 (0.079) | 2.4 (0.094) | 1.3 (0.051) | n/a | 0.05 (0.002) | n/a | n/a | 0.13 (0.005) | 3.8 (0.150) | 3.5 (0.138) | 3.5 (0.138) |
| W | 7343-15 | 7.3 ±0.3 (0.287 ±0.012) | 4.3 ±0.3 (0.169 ±0.012) | 1.5 (0.059) | 2.4 (0.094) | 1.3 (0.051) | n/a | 0.05 (0.002) | n/a | n/a | 0.13 (0.005) | 3.8 (0.150) | 3.5 (0.138) | 3.5 (0.138) |
| X | 7343-43 | 7.3 ±0.3 (0.287 ±0.012) | 4.3 ±0.3 (0.169 ±0.012) | 4.0 ±0.3 (0.157 ±0.012) | 2.4 (0.094) | 1.3 (0.051) | 0.5 (0.020) | 0.10 ±0.10 (0.004 ±0.004) | 1.7 (0.067) | 1.0 (0.039) | 0.13 (0.005) | 3.8 (0.150) | 3.5 (0.138) | 3.5 (0.138) |
| Y | 7343-40 | 7.3 ±0.3 (0.287 ±0.012) | 4.3 ±0.3 (0.169 ±0.012) | 4.0 (0.157) | 2.4 (0.094) | 1.3 (0.051) | 0.5 (0.020) | 0.10 ±0.10 (0.004 ±0.004) | 1.7 (0.067) | 1.0 (0.039) | 0.13 (0.005) | 3.8 (0.150) | 3.5 (0.138) | 3.5 (0.138) |

Notes: (Ref) – Dimensions provided for reference only. No dimensions are provided for B, P or R because low profile cases do not have a bevel or a notch.

* MIL-PRF-55365/8 specified dimensions

Table 1 – Ratings & Part Number Reference

| Rated Voltage | Rated Cap | Case Code/ Case Size | KEMET Part Number | DC Leakage | DF | ESR | Maximum Allowable Ripple Current | Rated Temp | Moisture Sensitivity |
|---------------|-------------------|-------------------------|------------------------------|---|-------------------------------|-----------------------------------|-------------------------------------|-------------------|------------------------|
| V | μF | KEMET/EIA | (See below for part options) | (μA) @ V _R , 20°C Maximum/ 5 Minutes | % @ 20°C 120 Hz Maximum | (mΩ) @ 20°C 100 kHz Maximum | (mA) 45°C 100 kHz | (°C) | Temperature ≤ 260°C |
| 2.5 | 47 | A/3216-18 | T543A476(1)2R5A(2)(3)(4) | 12 | 8 | 90 | 1116 | 105 | 3 |
| 2.5 | 56 | T/3528-12 | T543T566(1)2R5A(2)(3)(4) | 14 | 8 | 40 | 1620 | 105 | 3 |
| 2.5 | 56 | T/3528-12 | T543T566(1)2R5A(2)(3)(4) | 14 | 8 | 70 | 1225 | 105 | 3 |
| 2.5 | 68 | A/3216-18 | T543A686(1)2R5A(2)(3)(4) | 17 | 8 | 70 | 1265 | 105 | 3 |
| 2.5 | 68 | A/3216-18 | T543A686(1)2R5A(2)(3)(4) | 17 | 8 | 80 | 1183 | 105 | 3 |
| 2.5 | 100 | T/3528-12 | T543T107(1)2R5A(2)(3)(4) | 25 | 8 | 40 | 1620 | 105 | 3 |
| 2.5 | 100 | T/3528-12 | T543T107(1)2R5A(2)(3)(4) | 25 | 8 | 70 | 1225 | 105 | 3 |
| 2.5 | 100 | T/3528-12 | T543T107(1)2R5A(2)(3)(4) | 25 | 8 | 80 | 1146 | 105 | 3 |
| 2.5 | 100 | B/3528-21 | T543B107(1)2R5A(2)(3)(4) | 25 | 8 | 25 | 2254 | 105 | 3 |
| 2.5 | 100 | B/3528-21 | T543B107(1)2R5A(2)(3)(4) | 25 | 8 | 35 | 1905 | 105 | 3 |
| 2.5 | 100 | B/3528-21 | T543B107(1)2R5A(2)(3)(4) | 25 | 8 | 40 | 1782 | 105 | 3 |
| 2.5 | 100 | B/3528-21 | T543B107(1)2R5A(2)(3)(4) | 25 | 8 | 70 | 1347 | 105 | 3 |
| 2.5 | 150 | U/6032-15 | T543U157(1)2R5A(2)(3)(4) | 38 | 8 | 55 | 1567 | 105 | 3 |
| 2.5 | 220 | B/3528-21 | T543B227(1)2R5A(2)(3)(4) | 55 | 8 | 25 | 2254 | 105 | 3 |
| 2.5 | 220 | B/3528-21 | T543B227(1)2R5A(2)(3)(4) | 55 | 8 | 30 | 2058 | 105 | 3 |
| 2.5 | 220 | B/3528-21 | T543B227(1)2R5A(2)(3)(4) | 55 | 8 | 35 | 1905 | 105 | 3 |
| 2.5 | 220 | B/3528-21 | T543B227(1)2R5A(2)(3)(4) | 55 | 8 | 55 | 1520 | 105 | 3 |
| 2.5 | 220 | B/3528-21 | T543B227(1)2R5A(2)(3)(4) | 55 | 8 | 70 | 1347 | 105 | 3 |
| 2.5 | 220 | U/6032-15 | T543U227(1)2R5A(2)(3)(4) | 55 | 8 | 55 | 1567 | 105 | 3 |
| 2.5 | 220 | C/6032-28 | T543C227(1)2R5A(2)(3)(4) | 55 | 8 | 25 | 2569 | 105 | 3 |
| 2.5 | 220 | C/6032-28 | T543C227(1)2R5A(2)(3)(4) | 55 | 8 | 45 | 1915 | 105 | 3 |
| 2.5 | 220 | W/7343-15 | T543W227(1)2R5A(2)(3)(4) | 55 | 10 | 25 | 2683 | 105 | 3 |
| 2.5 | 220 | V/7343-20 | T543V227(1)2R5A(2)(3)(4) | 55 | 10 | 15 | 3531 | 105 | 3 |
| 2.5 | 220 | V/7343-20 | T543V227(1)2R5A(2)(3)(4) | 55 | 10 | 25 | 2735 | 105 | 3 |
| 2.5 | 220 | V/7343-20 | T543V227(1)2R5A(2)(3)(4) | 55 | 10 | 45 | 2039 | 105 | 3 |
| 2.5 | 220 | D/7343-31 | T543D227(1)2R5A(2)(3)(4) | 55 | 10 | 40 | 2372 | 105 | 3 |
| 2.5 | 330 | B/3528-21 | T543B337(1)2R5A(2)(3)(4) | 83 | 8 | 35 | 1905 | 105 | 3 |
| 2.5 | 330 | B/3528-21 | T543B337(1)2R5A(2)(3)(4) | 83 | 8 | 45 | 1680 | 105 | 3 |
| 2.5 | 330 | B/3528-21 | T543B337(1)2R5A(2)(3)(4) | 83 | 8 | 70 | 1347 | 105 | 3 |
| 2.5 | 330 | L/6032-19 | T543L337(1)2R5A(2)(3)(4) | 83 | 8 | 12 | 3536 | 105 | 3 |
| 2.5 | 330 | L/6032-19 | T543L337(1)2R5A(2)(3)(4) | 83 | 8 | 25 | 2449 | 105 | 3 |
| 2.5 | 330 | C/6032-28 | T543C337(1)2R5A(2)(3)(4) | 83 | 8 | 15 | 3317 | 105 | 3 |
| 2.5 | 330 | C/6032-28 | T543C337(1)2R5A(2)(3)(4) | 83 | 8 | 18 | 3028 | 105 | 3 |
| 2.5 | 330 | C/6032-28 | T543C337(1)2R5A(2)(3)(4) | 83 | 8 | 25 | 2569 | 105 | 3 |
| 2.5 | 330 | C/6032-28 | T543C337(1)2R5A(2)(3)(4) | 83 | 8 | 45 | 1915 | 105 | 3 |
| 2.5 | 330 | W/7343-15 | T543W337(1)2R5A(2)(3)(4) | 83 | 10 | 15 | 3464 | 105 | 3 |
| 2.5 | 330 | W/7343-15 | T543W337(1)2R5A(2)(3)(4) | 83 | 10 | 25 | 2683 | 105 | 3 |
| 2.5 | 330 | W/7343-15 | T543W337(1)2R5A(2)(3)(4) | 83 | 10 | 40 | 2121 | 105 | 3 |
| 2.5 | 330 | V/7343-20 | T543V337(1)2R5A(2)(3)(4) | 83 | 10 | 15 | 3531 | 105 | 3 |
| 2.5 | 330 | V/7343-20 | T543V337(1)2R5A(2)(3)(4) | 83 | 10 | 18 | 3223 | 105 | 3 |
| 2.5 | 330 | V/7343-20 | T543V337(1)2R5A(2)(3)(4) | 83 | 10 | 25 | 2735 | 105 | 3 |
| 2.5 | 330 | V/7343-20 | T543V337(1)2R5A(2)(3)(4) | 83 | 10 | 40 | 2162 | 105 | 3 |
| 2.5 | 330 | D/7343-31 | T543D337(1)2R5A(2)(3)(4) | 83 | 10 | 6 | 6124 | 105 | 3 |
| 2.5 | 330 | D/7343-31 | T543D337(1)2R5A(2)(3)(4) | 83 | 10 | 7 | 5669 | 105 | 3 |
| 2.5 | 330 | D/7343-31 | T543D337(1)2R5A(2)(3)(4) | 83 | 10 | 25 | 3000 | 105 | 3 |
| 2.5 | 470 | C/6032-28 | T543C477(1)2R5A(2)(3)(4) | 118 | 8 | 25 | 2569 | 105 | 3 |
| 2.5 | 470 | C/6032-28 | T543C477(1)2R5A(2)(3)(4) | 118 | 8 | 45 | 1915 | 105 | 3 |
| 2.5 | 470 | V/7343-20 | T543V477(1)2R5A(2)(3)(4) | 118 | 10 | 18 | 3223 | 105 | 3 |
| 2.5 | 470 | D/7343-31 | T543D477(1)2R5A(2)(3)(4) | 118 | 10 | 5 | 6708 | 105 | 3 |
| 2.5 | 470 | D/7343-31 | T543D477(1)2R5A(2)(3)(4) | 118 | 10 | 6 | 6124 | 105 | 3 |
| 2.5 | 470 | D/7343-31 | T543D477(1)2R5A(2)(3)(4) | 118 | 10 | 7 | 5669 | 105 | 3 |
| V | μF | KEMET/EIA | (See below for part options) | (μA) @ V _R , 20°C Maximum/ 5 Minutes | % @ 20°C 120 Hz Maximum | (mΩ) @ 20°C 100 kHz Maximum | (mA) 45°C 100 kHz | (°C) | Temperature ≤ 260°C |
| Rated Voltage | Rated Capacitance | Case Code/ Case Size | KEMET Part Number | DC Leakage | DF | ESR | Maximum Allowable Ripple Current | Rated Temperature | Moisture Sensitivity |

(1) To complete KEMET part number, insert M for ±20%, K for ±10%. Designates capacitance tolerance.
 (2) To complete KEMET part number, H = Solder Plated, T = 100% Tin (Sn). Designates termination finish.
 (3) To complete KEMET part number, insert E = None, S = 10 cycles +25°C, W = 10 cycles -55°C +85°C. Designates surge current option.
 (4) To complete KEMET part number, insert the ESR in mΩ, for example 50 mΩ = 050. Designates ESR option.
 Refer to Ordering Information for additional detail.

Table 1 – Ratings & Part Number Reference cont'd

| Rated Voltage | Rated Cap | Case Code/ Case Size | KEMET Part Number | DC Leakage | DF | ESR | Maximum Allowable Ripple Current | Rated Temp | Moisture Sensitivity |
|---------------|-------------------|-------------------------|------------------------------|---|-------------------------------|-----------------------------------|-------------------------------------|-------------------|------------------------|
| V | μF | KEMET/EIA | (See below for part options) | (μA) @ V _R , 20°C Maximum/ 5 Minutes | % @ 20°C 120 Hz Maximum | (mΩ) @ 20°C 100 kHz Maximum | (mA) 45°C 100 kHz | (°C) | Temperature ≤ 260°C |
| 2.5 | 470 | D/7343-31 | T543D477(1)2R5A(2)(3)(4) | 118 | 10 | 9 | 5000 | 105 | 3 |
| 2.5 | 470 | D/7343-31 | T543D477(1)2R5A(2)(3)(4) | 118 | 10 | 10 | 4743 | 105 | 3 |
| 2.5 | 470 | D/7343-31 | T543D477(1)2R5A(2)(3)(4) | 118 | 10 | 25 | 3000 | 105 | 3 |
| 2.5 | 560 | D/7343-31 | T543D567(1)2R5A(2)(3)(4) | 140 | 10 | 5 | 6708 | 105 | 3 |
| 2.5 | 680 | D/7343-31 | T543D687(1)2R5A(2)(3)(4) | 170 | 10 | 6 | 6124 | 105 | 3 |
| 2.5 | 680 | D/7343-31 | T543D687(1)2R5A(2)(3)(4) | 170 | 10 | 10 | 4743 | 105 | 3 |
| 2.5 | 680 | D/7343-31 | T543D687(1)2R5A(2)(3)(4) | 170 | 10 | 15 | 3873 | 105 | 3 |
| 2.5 | 680 | D/7343-31 | T543D687(1)2R5A(2)(3)(4) | 170 | 10 | 40 | 2372 | 105 | 3 |
| 2.5 | 680 | X/7343-43 | T543Y687(1)2R5A(2)(3)(4) | 170 | 10 | 5 | 6943 | 105 | 3 |
| 2.5 | 680 | X/7343-43 | T543Y687(1)2R5A(2)(3)(4) | 170 | 10 | 6 | 6338 | 105 | 3 |
| 2.5 | 680 | X/7343-43 | T543Y687(1)2R5A(2)(3)(4) | 170 | 10 | 10 | 4909 | 105 | 3 |
| 2.5 | 680 | X/7343-43 | T543Y687(1)2R5A(2)(3)(4) | 170 | 10 | 15 | 4008 | 105 | 3 |
| 2.5 | 680 | X/7343-43 | T543Y687(1)2R5A(2)(3)(4) | 170 | 10 | 25 | 3105 | 105 | 3 |
| 2.5 | 680 | X/7343-43 | T543X687(1)2R5A(2)(3)(4) | 170 | 10 | 6 | 6416 | 105 | 3 |
| 2.5 | 1000 | X/7343-43 | T543Y108(1)2R5A(2)(3)(4) | 250 | 10 | 5 | 6943 | 105 | 3 |
| 2.5 | 1000 | X/7343-43 | T543Y108(1)2R5A(2)(3)(4) | 250 | 10 | 6 | 6338 | 105 | 3 |
| 2.5 | 1000 | X/7343-43 | T543Y108(1)2R5A(2)(3)(4) | 250 | 10 | 10 | 4909 | 105 | 3 |
| 2.5 | 1000 | X/7343-43 | T543Y108(1)2R5A(2)(3)(4) | 250 | 10 | 15 | 4008 | 105 | 3 |
| 2.5 | 1000 | X/7343-43 | T543Y108(1)2R5A(2)(3)(4) | 250 | 10 | 25 | 3105 | 105 | 3 |
| 2.5 | 1000 | X/7343-43 | T543X108(1)2R5A(2)(3)(4) | 250 | 10 | 5 | 7029 | 105 | 3 |
| 2.5 | 1000 | X/7343-43 | T543X108(1)2R5A(2)(3)(4) | 250 | 10 | 6 | 6416 | 105 | 3 |
| 2.5 | 1000 | X/7343-43 | T543X108(1)2R5A(2)(3)(4) | 250 | 10 | 10 | 4970 | 105 | 3 |
| 2.5 | 1500 | X/7343-43 | T543X158(1)2R5A(2)(3)(4) | 375 | 10 | 5 | 7029 | 105 | 3 |
| 2.5 | 1500 | X/7343-43 | T543X158(1)2R5A(2)(3)(4) | 375 | 10 | 10 | 4970 | 105 | 3 |
| 3 | 100 | B/3528-21 | T543B107(1)003A(2)(3)(4) | 30 | 8 | 35 | 1905 | 105 | 3 |
| 3 | 100 | B/3528-21 | T543B107(1)003A(2)(3)(4) | 30 | 8 | 40 | 1782 | 105 | 3 |
| 3 | 100 | B/3528-21 | T543B107(1)003A(2)(3)(4) | 30 | 8 | 70 | 1347 | 105 | 3 |
| 3 | 100 | B/3528-21 | T543B107(1)003A(2)(3)(4) | 30 | 8 | 80 | 1260 | 105 | 3 |
| 3 | 150 | B/3528-21 | T543B157(1)003A(2)(3)(4) | 45 | 8 | 35 | 1905 | 105 | 3 |
| 3 | 150 | B/3528-21 | T543B157(1)003A(2)(3)(4) | 45 | 8 | 40 | 1782 | 105 | 3 |
| 3 | 150 | B/3528-21 | T543B157(1)003A(2)(3)(4) | 45 | 8 | 70 | 1347 | 105 | 3 |
| 3 | 150 | B/3528-21 | T543B157(1)003A(2)(3)(4) | 45 | 8 | 80 | 1260 | 105 | 3 |
| 3 | 330 | V/7343-20 | T543V337(1)003A(2)(3)(4) | 99 | 10 | 15 | 3531 | 105 | 3 |
| 3 | 330 | V/7343-20 | T543V337(1)003A(2)(3)(4) | 99 | 10 | 25 | 2735 | 105 | 3 |
| 3 | 330 | D/7343-31 | T543D337(1)003A(2)(3)(4) | 99 | 10 | 25 | 3000 | 105 | 3 |
| 3 | 470 | D/7343-31 | T543D477(1)003A(2)(3)(4) | 141 | 10 | 10 | 4743 | 105 | 3 |
| 3 | 470 | D/7343-31 | T543D477(1)003A(2)(3)(4) | 141 | 10 | 25 | 3000 | 105 | 3 |
| 3 | 680 | D/7343-31 | T543D687(1)003A(2)(3)(4) | 204 | 10 | 10 | 4743 | 105 | 3 |
| 3 | 680 | D/7343-31 | T543D687(1)003A(2)(3)(4) | 204 | 10 | 15 | 3873 | 105 | 3 |
| 3 | 680 | D/7343-31 | T543D687(1)003A(2)(3)(4) | 204 | 10 | 25 | 3000 | 105 | 3 |
| 3 | 680 | D/7343-31 | T543D687(1)003A(2)(3)(4) | 204 | 10 | 40 | 2372 | 105 | 3 |
| 3 | 1000 | X/7343-43 | T543X108(1)003A(2)(3)(4) | 300 | 10 | 10 | 4970 | 105 | 3 |
| 3 | 1000 | X/7343-43 | T543X108(1)003A(2)(3)(4) | 300 | 10 | 15 | 4058 | 105 | 3 |
| 3 | 1000 | X/7343-43 | T543X108(1)003A(2)(3)(4) | 300 | 10 | 30 | 2869 | 105 | 3 |
| 3 | 1500 | X/7343-43 | T543X158(1)003A(2)(3)(4) | 450 | 10 | 8 | 5557 | 105 | 3 |
| 4 | 15 | T/3528-12 | T543T156(1)004A(2)(3)(4) | 6 | 8 | 100 | 1025 | 105 | 3 |
| 4 | 33 | A/3216-18 | T543A336(1)004A(2)(3)(4) | 13 | 8 | 70 | 1265 | 105 | 3 |
| 4 | 33 | A/3216-18 | T543A336(1)004A(2)(3)(4) | 13 | 8 | 80 | 1183 | 105 | 3 |
| 4 | 47 | A/3216-18 | T543A476(1)004A(2)(3)(4) | 19 | 8 | 70 | 1265 | 105 | 3 |
| 4 | 47 | A/3216-18 | T543A476(1)004A(2)(3)(4) | 19 | 8 | 80 | 1183 | 105 | 3 |
| 4 | 47 | T/3528-12 | T543T476(1)004A(2)(3)(4) | 19 | 8 | 70 | 1225 | 105 | 3 |
| V | μF | KEMET/EIA | (See below for part options) | (μA) @ V _R , 20°C Maximum/ 5 Minutes | % @ 20°C 120 Hz Maximum | (mΩ) @ 20°C 100 kHz Maximum | (mA) 45°C 100 kHz | (°C) | Temperature ≤ 260°C |
| Rated Voltage | Rated Capacitance | Case Code/ Case Size | KEMET Part Number | DC Leakage | DF | ESR | Maximum Allowable Ripple Current | Rated Temperature | Moisture Sensitivity |

(1) To complete KEMET part number, insert M for ±20%, K for ±10%. Designates capacitance tolerance.
 (2) To complete KEMET part number, H = Solder Plated, T = 100% Tin (Sn). Designates termination finish.
 (3) To complete KEMET part number, insert E = None, S = 10 cycles +25°C, W = 10 cycles -55°C +85°C. Designates surge current option.
 (4) To complete KEMET part number, insert the ESR in mΩ, for example 50 mΩ = 050. Designates ESR option.
 Refer to Ordering Information for additional detail.

Table 1 – Ratings & Part Number Reference cont'd

| Rated Voltage | Rated Cap | Case Code/ Case Size | KEMET Part Number | DC Leakage | DF | ESR | Maximum Allowable Ripple Current | Rated Temp | Moisture Sensitivity |
|---------------|-------------------|-------------------------|------------------------------|---|-------------------------------|-----------------------------------|----------------------------------|-------------------|------------------------|
| V | μF | KEMET/EIA | (See below for part options) | (μA) @ V _R , 20°C Maximum/ 5 Minutes | % @ 20°C 120 Hz Maximum | (mΩ) @ 20°C 100 kHz Maximum | (mA) 45°C 100 kHz | (°C) | Temperature ≤ 260°C |
| 4 | 68 | T/3528-12 | T543T686(1)004A(2)(3)(4) | 27 | 8 | 70 | 1225 | 105 | 3 |
| 4 | 68 | T/3528-12 | T543T686(1)004A(2)(3)(4) | 27 | 8 | 80 | 1146 | 105 | 3 |
| 4 | 68 | B/3528-21 | T543B686(1)004A(2)(3)(4) | 27 | 8 | 35 | 1905 | 105 | 3 |
| 4 | 68 | B/3528-21 | T543B686(1)004A(2)(3)(4) | 27 | 8 | 40 | 1782 | 105 | 3 |
| 4 | 68 | B/3528-21 | T543B686(1)004A(2)(3)(4) | 27 | 8 | 70 | 1347 | 105 | 3 |
| 4 | 68 | B/3528-21 | T543B686(1)004A(2)(3)(4) | 27 | 8 | 80 | 1260 | 105 | 3 |
| 4 | 68 | U/6032-15 | T543U686(1)004A(2)(3)(4) | 27 | 8 | 55 | 1567 | 105 | 3 |
| 4 | 100 | A/3216-18 | T543A107(1)004A(2)(3)(4) | 40 | 8 | 150 | 864 | 105 | 3 |
| 4 | 100 | A/3216-18 | T543A107(1)004A(2)(3)(4) | 40 | 8 | 200 | 748 | 105 | 3 |
| 4 | 100 | T/3528-12 | T543T107(1)004A(2)(3)(4) | 40 | 8 | 70 | 1225 | 105 | 3 |
| 4 | 100 | T/3528-12 | T543T107(1)004A(2)(3)(4) | 40 | 8 | 150 | 837 | 105 | 3 |
| 4 | 100 | B/3528-21 | T543B107(1)004A(2)(3)(4) | 40 | 8 | 35 | 1905 | 105 | 3 |
| 4 | 100 | B/3528-21 | T543B107(1)004A(2)(3)(4) | 40 | 8 | 40 | 1782 | 105 | 3 |
| 4 | 100 | B/3528-21 | T543B107(1)004A(2)(3)(4) | 40 | 8 | 70 | 1347 | 105 | 3 |
| 4 | 100 | B/3528-21 | T543B107(1)004A(2)(3)(4) | 40 | 8 | 80 | 1260 | 105 | 3 |
| 4 | 100 | U/6032-15 | T543U107(1)004A(2)(3)(4) | 40 | 8 | 55 | 1567 | 105 | 3 |
| 4 | 150 | B/3528-21 | T543B157(1)004A(2)(3)(4) | 60 | 8 | 35 | 1905 | 105 | 3 |
| 4 | 150 | B/3528-21 | T543B157(1)004A(2)(3)(4) | 60 | 8 | 40 | 1782 | 105 | 3 |
| 4 | 150 | B/3528-21 | T543B157(1)004A(2)(3)(4) | 60 | 8 | 70 | 1347 | 105 | 3 |
| 4 | 150 | U/6032-15 | T543U157(1)004A(2)(3)(4) | 60 | 8 | 55 | 1567 | 105 | 3 |
| 4 | 150 | C/6032-28 | T543C157(1)004A(2)(3)(4) | 60 | 8 | 15 | 3317 | 105 | 3 |
| 4 | 150 | C/6032-28 | T543C157(1)004A(2)(3)(4) | 60 | 8 | 25 | 2569 | 105 | 3 |
| 4 | 150 | C/6032-28 | T543C157(1)004A(2)(3)(4) | 60 | 8 | 45 | 1915 | 105 | 3 |
| 4 | 150 | C/6032-28 | T543C157(1)004A(2)(3)(4) | 60 | 8 | 100 | 1285 | 105 | 3 |
| 4 | 150 | V/7343-20 | T543V157(1)004A(2)(3)(4) | 60 | 10 | 15 | 3531 | 105 | 3 |
| 4 | 150 | V/7343-20 | T543V157(1)004A(2)(3)(4) | 60 | 10 | 25 | 2735 | 105 | 3 |
| 4 | 220 | B/3528-21 | T543B227(1)004A(2)(3)(4) | 88 | 8 | 35 | 1905 | 105 | 3 |
| 4 | 220 | B/3528-21 | T543B227(1)004A(2)(3)(4) | 88 | 8 | 45 | 1680 | 105 | 3 |
| 4 | 220 | B/3528-21 | T543B227(1)004A(2)(3)(4) | 88 | 8 | 70 | 1347 | 105 | 3 |
| 4 | 220 | L/6032-19 | T543L227(1)004A(2)(3)(4) | 88 | 8 | 12 | 3536 | 105 | 3 |
| 4 | 220 | L/6032-19 | T543L227(1)004A(2)(3)(4) | 88 | 8 | 25 | 2449 | 105 | 3 |
| 4 | 220 | C/6032-28 | T543C227(1)004A(2)(3)(4) | 88 | 8 | 15 | 3317 | 105 | 3 |
| 4 | 220 | C/6032-28 | T543C227(1)004A(2)(3)(4) | 88 | 8 | 18 | 3028 | 105 | 3 |
| 4 | 220 | C/6032-28 | T543C227(1)004A(2)(3)(4) | 88 | 8 | 25 | 2569 | 105 | 3 |
| 4 | 220 | C/6032-28 | T543C227(1)004A(2)(3)(4) | 88 | 8 | 45 | 1915 | 105 | 3 |
| 4 | 220 | C/6032-28 | T543C227(1)004A(2)(3)(4) | 88 | 8 | 55 | 1732 | 105 | 3 |
| 4 | 220 | W/7343-15 | T543W227(1)004A(2)(3)(4) | 88 | 10 | 25 | 2683 | 105 | 3 |
| 4 | 220 | W/7343-15 | T543W227(1)004A(2)(3)(4) | 88 | 10 | 40 | 2121 | 105 | 3 |
| 4 | 220 | V/7343-20 | T543V227(1)004A(2)(3)(4) | 88 | 10 | 15 | 3531 | 105 | 3 |
| 4 | 220 | V/7343-20 | T543V227(1)004A(2)(3)(4) | 88 | 10 | 18 | 3223 | 105 | 3 |
| 4 | 220 | V/7343-20 | T543V227(1)004A(2)(3)(4) | 88 | 10 | 25 | 2735 | 105 | 3 |
| 4 | 220 | V/7343-20 | T543V227(1)004A(2)(3)(4) | 88 | 10 | 40 | 2162 | 105 | 3 |
| 4 | 220 | V/7343-20 | T543V227(1)004A(2)(3)(4) | 88 | 10 | 45 | 2039 | 105 | 3 |
| 4 | 220 | D/7343-31 | T543D227(1)004A(2)(3)(4) | 88 | 10 | 25 | 3000 | 105 | 3 |
| 4 | 220 | D/7343-31 | T543D227(1)004A(2)(3)(4) | 88 | 10 | 65 | 1861 | 105 | 3 |
| 4 | 330 | C/6032-28 | T543C337(1)004A(2)(3)(4) | 132 | 8 | 25 | 2569 | 105 | 3 |
| 4 | 330 | C/6032-28 | T543C337(1)004A(2)(3)(4) | 132 | 8 | 45 | 1915 | 105 | 3 |
| 4 | 330 | V/7343-20 | T543V337(1)004A(2)(3)(4) | 132 | 10 | 18 | 3223 | 105 | 3 |
| 4 | 330 | V/7343-20 | T543V337(1)004A(2)(3)(4) | 132 | 10 | 25 | 2735 | 105 | 3 |
| 4 | 330 | V/7343-20 | T543V337(1)004A(2)(3)(4) | 132 | 10 | 40 | 2162 | 105 | 3 |
| 4 | 330 | D/7343-31 | T543D337(1)004A(2)(3)(4) | 132 | 10 | 5 | 6708 | 105 | 3 |
| Rated Voltage | Rated Capacitance | Case Code/ Case Size | KEMET Part Number | DC Leakage | DF | ESR | Maximum Allowable Ripple Current | Rated Temperature | Moisture Sensitivity |

(1) To complete KEMET part number, insert M for ±20%, K for ±10%. Designates capacitance tolerance.
 (2) To complete KEMET part number, H = Solder Plated, T = 100% Tin (Sn). Designates termination finish.
 (3) To complete KEMET part number, insert E = None, S = 10 cycles +25°C, W = 10 cycles -55°C +85°C. Designates surge current option.
 (4) To complete KEMET part number, insert the ESR in mΩ, for example 50 mΩ = 050. Designates ESR option.
 Refer to Ordering Information for additional detail.

Table 1 – Ratings & Part Number Reference cont'd

| Rated Voltage | Rated Cap | Case Code/ Case Size | KEMET Part Number | DC Leakage | DF | ESR | Maximum Allowable Ripple Current | Rated Temp | Moisture Sensitivity |
|---------------|-------------------|-------------------------|------------------------------|---|-------------------------------|-----------------------------------|-------------------------------------|-------------------|------------------------|
| V | μF | KEMET/EIA | (See below for part options) | (μA) @ V _R , 20°C Maximum/ 5 Minutes | % @ 20°C 120 Hz Maximum | (mΩ) @ 20°C 100 kHz Maximum | (mA) 45°C 100 kHz | (°C) | Temperature ≤ 260°C |
| 4 | 330 | D/7343-31 | T543D337(1)004A(2)(3)(4) | 132 | 10 | 6 | 6124 | 105 | 3 |
| 4 | 330 | D/7343-31 | T543D337(1)004A(2)(3)(4) | 132 | 10 | 7 | 5669 | 105 | 3 |
| 4 | 330 | D/7343-31 | T543D337(1)004A(2)(3)(4) | 132 | 10 | 9 | 5000 | 105 | 3 |
| 4 | 330 | D/7343-31 | T543D337(1)004A(2)(3)(4) | 132 | 10 | 10 | 4743 | 105 | 3 |
| 4 | 330 | D/7343-31 | T543D337(1)004A(2)(3)(4) | 132 | 10 | 12 | 4330 | 105 | 3 |
| 4 | 330 | D/7343-31 | T543D337(1)004A(2)(3)(4) | 132 | 10 | 15 | 3873 | 105 | 3 |
| 4 | 330 | D/7343-31 | T543D337(1)004A(2)(3)(4) | 132 | 10 | 25 | 3000 | 105 | 3 |
| 4 | 330 | D/7343-31 | T543D337(1)004A(2)(3)(4) | 132 | 10 | 40 | 2372 | 105 | 3 |
| 4 | 330 | D/7343-31 | T543D337(1)004A(2)(3)(4) | 132 | 10 | 45 | 2236 | 105 | 3 |
| 4 | 470 | D/7343-31 | T543D477(1)004A(2)(3)(4) | 188 | 10 | 6 | 6124 | 105 | 3 |
| 4 | 470 | D/7343-31 | T543D477(1)004A(2)(3)(4) | 188 | 10 | 10 | 4743 | 105 | 3 |
| 4 | 470 | D/7343-31 | T543D477(1)004A(2)(3)(4) | 188 | 10 | 12 | 4330 | 105 | 3 |
| 4 | 470 | D/7343-31 | T543D477(1)004A(2)(3)(4) | 188 | 10 | 15 | 3873 | 105 | 3 |
| 4 | 470 | D/7343-31 | T543D477(1)004A(2)(3)(4) | 188 | 10 | 18 | 3536 | 105 | 3 |
| 4 | 470 | D/7343-31 | T543D477(1)004A(2)(3)(4) | 188 | 10 | 25 | 3000 | 105 | 3 |
| 4 | 470 | D/7343-31 | T543D477(1)004A(2)(3)(4) | 188 | 10 | 40 | 2372 | 105 | 3 |
| 4 | 470 | X/7343-43 | T543Y477(1)004A(2)(3)(4) | 188 | 10 | 5 | 6943 | 105 | 3 |
| 4 | 470 | X/7343-43 | T543Y477(1)004A(2)(3)(4) | 188 | 10 | 6 | 6338 | 105 | 3 |
| 4 | 470 | X/7343-43 | T543Y477(1)004A(2)(3)(4) | 188 | 10 | 10 | 4909 | 105 | 3 |
| 4 | 470 | X/7343-43 | T543Y477(1)004A(2)(3)(4) | 188 | 10 | 25 | 3105 | 105 | 3 |
| 4 | 470 | X/7343-43 | T543Y477(1)004A(2)(3)(4) | 188 | 10 | 40 | 2455 | 105 | 3 |
| 4 | 680 | D/7343-31 | T543D687(1)004A(2)(3)(4) | 272 | 10 | 25 | 3000 | 105 | 3 |
| 4 | 680 | X/7343-43 | T543Y687(1)004A(2)(3)(4) | 272 | 10 | 5 | 6943 | 105 | 3 |
| 4 | 680 | X/7343-43 | T543Y687(1)004A(2)(3)(4) | 272 | 10 | 10 | 4909 | 105 | 3 |
| 4 | 680 | X/7343-43 | T543Y687(1)004A(2)(3)(4) | 272 | 10 | 15 | 4008 | 105 | 3 |
| 4 | 680 | X/7343-43 | T543Y687(1)004A(2)(3)(4) | 272 | 10 | 25 | 3105 | 105 | 3 |
| 4 | 680 | X/7343-43 | T543X687(1)004A(2)(3)(4) | 272 | 10 | 5 | 7029 | 105 | 3 |
| 4 | 680 | X/7343-43 | T543X687(1)004A(2)(3)(4) | 272 | 10 | 6 | 6416 | 105 | 3 |
| 4 | 680 | X/7343-43 | T543X687(1)004A(2)(3)(4) | 272 | 10 | 10 | 4970 | 105 | 3 |
| 4 | 680 | X/7343-43 | T543X687(1)004A(2)(3)(4) | 272 | 10 | 15 | 4058 | 105 | 3 |
| 4 | 680 | X/7343-43 | T543X687(1)004A(2)(3)(4) | 272 | 10 | 35 | 2657 | 105 | 3 |
| 4 | 1000 | X/7343-43 | T543X108(1)004A(2)(3)(4) | 400 | 10 | 6 | 6416 | 105 | 3 |
| 4 | 1000 | X/7343-43 | T543X108(1)004A(2)(3)(4) | 400 | 10 | 10 | 4970 | 105 | 3 |
| 6.3 | 15 | T/3528-12 | T543T156(1)006A(2)(3)(4) | 9 | 8 | 100 | 1025 | 105 | 3 |
| 6.3 | 22 | A/3216-18 | T543A226(1)006A(2)(3)(4) | 14 | 8 | 90 | 1116 | 105 | 3 |
| 6.3 | 22 | A/3216-18 | T543A226(1)006A(2)(3)(4) | 14 | 8 | 100 | 1058 | 105 | 3 |
| 6.3 | 33 | A/3216-18 | T543A336(1)006A(2)(3)(4) | 21 | 8 | 70 | 1265 | 105 | 3 |
| 6.3 | 33 | A/3216-18 | T543A336(1)006A(2)(3)(4) | 21 | 8 | 80 | 1183 | 105 | 3 |
| 6.3 | 33 | A/3216-18 | T543A336(1)006A(2)(3)(4) | 21 | 8 | 120 | 966 | 105 | 3 |
| 6.3 | 33 | T/3528-12 | T543T336(1)006A(2)(3)(4) | 21 | 8 | 70 | 1225 | 105 | 3 |
| 6.3 | 33 | B/3528-21 | T543B336(1)006A(2)(3)(4) | 21 | 8 | 25 | 2254 | 105 | 3 |
| 6.3 | 33 | B/3528-21 | T543B336(1)006A(2)(3)(4) | 21 | 8 | 35 | 1905 | 105 | 3 |
| 6.3 | 33 | B/3528-21 | T543B336(1)006A(2)(3)(4) | 21 | 8 | 40 | 1782 | 105 | 3 |
| 6.3 | 33 | B/3528-21 | T543B336(1)006A(2)(3)(4) | 21 | 8 | 70 | 1347 | 105 | 3 |
| 6.3 | 33 | B/3528-21 | T543B336(1)006A(2)(3)(4) | 21 | 8 | 80 | 1260 | 105 | 3 |
| 6.3 | 33 | C/6032-28 | T543C336(1)006A(2)(3)(4) | 21 | 8 | 100 | 1285 | 105 | 3 |
| 6.3 | 47 | A/3216-18 | T543A476(1)006A(2)(3)(4) | 30 | 8 | 150 | 864 | 105 | 3 |
| 6.3 | 47 | T/3528-12 | T543T476(1)006A(2)(3)(4) | 30 | 8 | 70 | 1225 | 105 | 3 |
| 6.3 | 47 | T/3528-12 | T543T476(1)006A(2)(3)(4) | 30 | 8 | 80 | 1146 | 105 | 3 |
| 6.3 | 47 | B/3528-21 | T543B476(1)006A(2)(3)(4) | 30 | 8 | 25 | 2254 | 105 | 3 |
| 6.3 | 47 | B/3528-21 | T543B476(1)006A(2)(3)(4) | 30 | 8 | 35 | 1905 | 105 | 3 |
| V | μF | KEMET/EIA | (See below for part options) | (μA) @ V _R , 20°C Maximum/ 5 Minutes | % @ 20°C 120 Hz Maximum | (mΩ) @ 20°C 100 kHz Maximum | (mA) 45°C 100 kHz | (°C) | Temperature ≤ 260°C |
| Rated Voltage | Rated Capacitance | Case Code/ Case Size | KEMET Part Number | DC Leakage | DF | ESR | Maximum Allowable Ripple Current | Rated Temperature | Moisture Sensitivity |

(1) To complete KEMET part number, insert M for ±20%, K for ±10%. Designates capacitance tolerance.
 (2) To complete KEMET part number, H = Solder Plated, T = 100% Tin (Sn). Designates termination finish.
 (3) To complete KEMET part number, insert E = None, S = 10 cycles +25°C, W = 10 cycles -55°C +85°C. Designates surge current option.
 (4) To complete KEMET part number, insert the ESR in mΩ, for example 50 mΩ = 050. Designates ESR option.
 Refer to Ordering Information for additional detail.

Table 1 – Ratings & Part Number Reference cont'd

| Rated Voltage | Rated Cap | Case Code/ Case Size | KEMET Part Number | DC Leakage | DF | ESR | Maximum Allowable Ripple Current | Rated Temp | Moisture Sensitivity |
|---------------|-------------------|-------------------------|------------------------------|---|-------------------------------|-----------------------------------|-------------------------------------|-------------------|------------------------|
| V | μF | KEMET/EIA | (See below for part options) | (μA) @ V _R , 20°C Maximum/ 5 Minutes | % @ 20°C 120 Hz Maximum | (mΩ) @ 20°C 100 kHz Maximum | (mA) 45°C 100 kHz | (°C) | Temperature ≤ 260°C |
| 6.3 | 47 | B/3528-21 | T543B476(1)006A(2)(3)(4) | 30 | 8 | 40 | 1782 | 105 | 3 |
| 6.3 | 47 | B/3528-21 | T543B476(1)006A(2)(3)(4) | 30 | 8 | 70 | 1347 | 105 | 3 |
| 6.3 | 47 | B/3528-21 | T543B476(1)006A(2)(3)(4) | 30 | 8 | 80 | 1260 | 105 | 3 |
| 6.3 | 68 | A/3216-18 | T543A686(1)006A(2)(3)(4) | 43 | 8 | 150 | 864 | 105 | 3 |
| 6.3 | 68 | T/3528-12 | T543T686(1)006A(2)(3)(4) | 43 | 8 | 70 | 1225 | 105 | 3 |
| 6.3 | 68 | T/3528-12 | T543T686(1)006A(2)(3)(4) | 43 | 8 | 150 | 837 | 105 | 3 |
| 6.3 | 68 | B/3528-21 | T543B686(1)006A(2)(3)(4) | 43 | 8 | 25 | 2254 | 105 | 3 |
| 6.3 | 68 | B/3528-21 | T543B686(1)006A(2)(3)(4) | 43 | 8 | 35 | 1905 | 105 | 3 |
| 6.3 | 68 | B/3528-21 | T543B686(1)006A(2)(3)(4) | 43 | 8 | 40 | 1782 | 105 | 3 |
| 6.3 | 68 | B/3528-21 | T543B686(1)006A(2)(3)(4) | 43 | 8 | 70 | 1347 | 105 | 3 |
| 6.3 | 68 | B/3528-21 | T543B686(1)006A(2)(3)(4) | 43 | 8 | 80 | 1260 | 105 | 3 |
| 6.3 | 68 | U/6032-15 | T543U686(1)006A(2)(3)(4) | 43 | 8 | 55 | 1567 | 105 | 3 |
| 6.3 | 68 | U/6032-15 | T543U686(1)006A(2)(3)(4) | 43 | 8 | 70 | 1389 | 105 | 3 |
| 6.3 | 68 | C/6032-28 | T543C686(1)006A(2)(3)(4) | 43 | 8 | 100 | 1285 | 105 | 3 |
| 6.3 | 100 | T/3528-12 | T543T107(1)006A(2)(3)(4) | 63 | 8 | 70 | 1225 | 105 | 3 |
| 6.3 | 100 | B/3528-21 | T543B107(1)006A(2)(3)(4) | 63 | 8 | 25 | 2254 | 105 | 3 |
| 6.3 | 100 | B/3528-21 | T543B107(1)006A(2)(3)(4) | 63 | 8 | 35 | 1905 | 105 | 3 |
| 6.3 | 100 | B/3528-21 | T543B107(1)006A(2)(3)(4) | 63 | 8 | 40 | 1782 | 105 | 3 |
| 6.3 | 100 | B/3528-21 | T543B107(1)006A(2)(3)(4) | 63 | 8 | 45 | 1680 | 105 | 3 |
| 6.3 | 100 | B/3528-21 | T543B107(1)006A(2)(3)(4) | 63 | 8 | 70 | 1347 | 105 | 3 |
| 6.3 | 100 | U/6032-15 | T543U107(1)006A(2)(3)(4) | 63 | 8 | 55 | 1567 | 105 | 3 |
| 6.3 | 100 | C/6032-28 | T543C107(1)006A(2)(3)(4) | 63 | 8 | 25 | 2569 | 105 | 3 |
| 6.3 | 100 | C/6032-28 | T543C107(1)006A(2)(3)(4) | 63 | 8 | 45 | 1915 | 105 | 3 |
| 6.3 | 100 | W/7343-15 | T543W107(1)006A(2)(3)(4) | 63 | 10 | 40 | 2121 | 105 | 3 |
| 6.3 | 100 | V/7343-20 | T543V107(1)006A(2)(3)(4) | 63 | 10 | 15 | 3531 | 105 | 3 |
| 6.3 | 100 | V/7343-20 | T543V107(1)006A(2)(3)(4) | 63 | 10 | 45 | 2039 | 105 | 3 |
| 6.3 | 120 | B/3528-21 | T543B127(1)006A(2)(3)(4) | 76 | 8 | 35 | 1905 | 105 | 3 |
| 6.3 | 150 | M/3528-15 | T543M157(1)006A(2)(3)(4) | 95 | 8 | 70 | 1309 | 105 | 3 |
| 6.3 | 150 | M/3528-15 | T543M157(1)006A(2)(3)(4) | 95 | 8 | 150 | 894 | 105 | 3 |
| 6.3 | 150 | B/3528-21 | T543B157(1)006A(2)(3)(4) | 95 | 8 | 25 | 2254 | 105 | 3 |
| 6.3 | 150 | B/3528-21 | T543B157(1)006A(2)(3)(4) | 95 | 8 | 35 | 1905 | 105 | 3 |
| 6.3 | 150 | B/3528-21 | T543B157(1)006A(2)(3)(4) | 95 | 8 | 45 | 1680 | 105 | 3 |
| 6.3 | 150 | B/3528-21 | T543B157(1)006A(2)(3)(4) | 95 | 8 | 70 | 1347 | 105 | 3 |
| 6.3 | 150 | U/6032-15 | T543U157(1)006A(2)(3)(4) | 95 | 8 | 45 | 1732 | 105 | 3 |
| 6.3 | 150 | U/6032-15 | T543U157(1)006A(2)(3)(4) | 95 | 8 | 55 | 1567 | 105 | 3 |
| 6.3 | 150 | L/6032-19 | T543L157(1)006A(2)(3)(4) | 95 | 8 | 12 | 3536 | 105 | 3 |
| 6.3 | 150 | L/6032-19 | T543L157(1)006A(2)(3)(4) | 95 | 8 | 25 | 2449 | 105 | 3 |
| 6.3 | 150 | C/6032-28 | T543C157(1)006A(2)(3)(4) | 95 | 8 | 15 | 3317 | 105 | 3 |
| 6.3 | 150 | C/6032-28 | T543C157(1)006A(2)(3)(4) | 95 | 8 | 25 | 2569 | 105 | 3 |
| 6.3 | 150 | C/6032-28 | T543C157(1)006A(2)(3)(4) | 95 | 8 | 45 | 1915 | 105 | 3 |
| 6.3 | 150 | C/6032-28 | T543C157(1)006A(2)(3)(4) | 95 | 8 | 55 | 1732 | 105 | 3 |
| 6.3 | 150 | W/7343-15 | T543W157(1)006A(2)(3)(4) | 95 | 10 | 25 | 2683 | 105 | 3 |
| 6.3 | 150 | W/7343-15 | T543W157(1)006A(2)(3)(4) | 95 | 10 | 40 | 2121 | 105 | 3 |
| 6.3 | 150 | V/7343-20 | T543V157(1)006A(2)(3)(4) | 95 | 10 | 15 | 3531 | 105 | 3 |
| 6.3 | 150 | V/7343-20 | T543V157(1)006A(2)(3)(4) | 95 | 10 | 18 | 3223 | 105 | 3 |
| 6.3 | 150 | V/7343-20 | T543V157(1)006A(2)(3)(4) | 95 | 10 | 25 | 2735 | 105 | 3 |
| 6.3 | 150 | V/7343-20 | T543V157(1)006A(2)(3)(4) | 95 | 10 | 40 | 2162 | 105 | 3 |
| 6.3 | 150 | V/7343-20 | T543V157(1)006A(2)(3)(4) | 95 | 10 | 45 | 2039 | 105 | 3 |
| 6.3 | 150 | D/7343-31 | T543D157(1)006A(2)(3)(4) | 95 | 10 | 15 | 3873 | 105 | 3 |
| 6.3 | 150 | D/7343-31 | T543D157(1)006A(2)(3)(4) | 95 | 10 | 25 | 3000 | 105 | 3 |
| 6.3 | 150 | D/7343-31 | T543D157(1)006A(2)(3)(4) | 95 | 10 | 55 | 2023 | 105 | 3 |
| V | μF | KEMET/EIA | (See below for part options) | (μA) @ V _R , 20°C Maximum/ 5 Minutes | % @ 20°C 120 Hz Maximum | (mΩ) @ 20°C 100 kHz Maximum | (mA) 45°C 100 kHz | (°C) | Temperature ≤ 260°C |
| Rated Voltage | Rated Capacitance | Case Code/ Case Size | KEMET Part Number | DC Leakage | DF | ESR | Maximum Allowable Ripple Current | Rated Temperature | Moisture Sensitivity |

(1) To complete KEMET part number, insert M for ±20%, K for ±10%. Designates capacitance tolerance.
 (2) To complete KEMET part number, H = Solder Plated, T = 100% Tin (Sn). Designates termination finish.
 (3) To complete KEMET part number, insert E = None, S = 10 cycles +25°C, W = 10 cycles -55°C +85°C. Designates surge current option.
 (4) To complete KEMET part number, insert the ESR in mΩ, for example 50 mΩ = 050. Designates ESR option.
 Refer to Ordering Information for additional detail.

Table 1 – Ratings & Part Number Reference cont'd

| Rated Voltage | Rated Cap | Case Code/ Case Size | KEMET Part Number | DC Leakage | DF | ESR | Maximum Allowable Ripple Current | Rated Temp | Moisture Sensitivity |
|---------------|-------------------|-------------------------|------------------------------|---|-------------------------------|-----------------------------------|-------------------------------------|-------------------|------------------------|
| V | μF | KEMET/EIA | (See below for part options) | (μA) @ V _R , 20°C Maximum/ 5 Minutes | % @ 20°C 120 Hz Maximum | (mΩ) @ 20°C 100 kHz Maximum | (mA) 45°C 100 kHz | (°C) | Temperature ≤ 260°C |
| 6.3 | 220 | B/3528-21 | T543B227(1)006A(2)(3)(4) | 139 | 8 | 35 | 1905 | 105 | 3 |
| 6.3 | 220 | B/3528-21 | T543B227(1)006A(2)(3)(4) | 139 | 8 | 45 | 1680 | 105 | 3 |
| 6.3 | 220 | B/3528-21 | T543B227(1)006A(2)(3)(4) | 139 | 8 | 70 | 1347 | 105 | 3 |
| 6.3 | 220 | C/6032-28 | T543C227(1)006A(2)(3)(4) | 139 | 8 | 15 | 3317 | 105 | 3 |
| 6.3 | 220 | C/6032-28 | T543C227(1)006A(2)(3)(4) | 139 | 8 | 18 | 3028 | 105 | 3 |
| 6.3 | 220 | C/6032-28 | T543C227(1)006A(2)(3)(4) | 139 | 8 | 25 | 2569 | 105 | 3 |
| 6.3 | 220 | C/6032-28 | T543C227(1)006A(2)(3)(4) | 139 | 8 | 45 | 1915 | 105 | 3 |
| 6.3 | 220 | V/7343-20 | T543V227(1)006A(2)(3)(4) | 139 | 10 | 18 | 3223 | 105 | 3 |
| 6.3 | 220 | V/7343-20 | T543V227(1)006A(2)(3)(4) | 139 | 10 | 25 | 2735 | 105 | 3 |
| 6.3 | 220 | V/7343-20 | T543V227(1)006A(2)(3)(4) | 139 | 10 | 40 | 2162 | 105 | 3 |
| 6.3 | 220 | D/7343-31 | T543D227(1)006A(2)(3)(4) | 139 | 10 | 5 | 6708 | 105 | 3 |
| 6.3 | 220 | D/7343-31 | T543D227(1)006A(2)(3)(4) | 139 | 10 | 6 | 6124 | 105 | 3 |
| 6.3 | 220 | D/7343-31 | T543D227(1)006A(2)(3)(4) | 139 | 10 | 7 | 5669 | 105 | 3 |
| 6.3 | 220 | D/7343-31 | T543D227(1)006A(2)(3)(4) | 139 | 10 | 9 | 5000 | 105 | 3 |
| 6.3 | 220 | D/7343-31 | T543D227(1)006A(2)(3)(4) | 139 | 10 | 10 | 4743 | 105 | 3 |
| 6.3 | 220 | D/7343-31 | T543D227(1)006A(2)(3)(4) | 139 | 10 | 15 | 3873 | 105 | 3 |
| 6.3 | 220 | D/7343-31 | T543D227(1)006A(2)(3)(4) | 139 | 10 | 18 | 3536 | 105 | 3 |
| 6.3 | 220 | D/7343-31 | T543D227(1)006A(2)(3)(4) | 139 | 10 | 25 | 3000 | 105 | 3 |
| 6.3 | 220 | D/7343-31 | T543D227(1)006A(2)(3)(4) | 139 | 10 | 40 | 2372 | 105 | 3 |
| 6.3 | 220 | D/7343-31 | T543D227(1)006A(2)(3)(4) | 139 | 10 | 50 | 2121 | 105 | 3 |
| 6.3 | 330 | V/7343-20 | T543V337(1)006A(2)(3)(4) | 208 | 10 | 15 | 3531 | 105 | 3 |
| 6.3 | 330 | V/7343-20 | T543V337(1)006A(2)(3)(4) | 208 | 10 | 18 | 3223 | 105 | 3 |
| 6.3 | 330 | V/7343-20 | T543V337(1)006A(2)(3)(4) | 208 | 10 | 25 | 2735 | 105 | 3 |
| 6.3 | 330 | V/7343-20 | T543V337(1)006A(2)(3)(4) | 208 | 10 | 40 | 2162 | 105 | 3 |
| 6.3 | 330 | V/7343-20 | T543V337(1)006A(2)(3)(4) | 208 | 10 | 45 | 2039 | 105 | 3 |
| 6.3 | 330 | D/7343-31 | T543D337(1)006A(2)(3)(4) | 208 | 10 | 6 | 6124 | 105 | 3 |
| 6.3 | 330 | D/7343-31 | T543D337(1)006A(2)(3)(4) | 208 | 10 | 9 | 5000 | 105 | 3 |
| 6.3 | 330 | D/7343-31 | T543D337(1)006A(2)(3)(4) | 208 | 10 | 10 | 4743 | 105 | 3 |
| 6.3 | 330 | D/7343-31 | T543D337(1)006A(2)(3)(4) | 208 | 10 | 15 | 3873 | 105 | 3 |
| 6.3 | 330 | D/7343-31 | T543D337(1)006A(2)(3)(4) | 208 | 10 | 18 | 3536 | 105 | 3 |
| 6.3 | 330 | D/7343-31 | T543D337(1)006A(2)(3)(4) | 208 | 10 | 25 | 3000 | 105 | 3 |
| 6.3 | 330 | D/7343-31 | T543D337(1)006A(2)(3)(4) | 208 | 10 | 40 | 2372 | 105 | 3 |
| 6.3 | 330 | D/7343-31 | T543D337(1)006A(2)(3)(4) | 208 | 10 | 45 | 2236 | 105 | 3 |
| 6.3 | 330 | X/7343-43 | T543Y337(1)006A(2)(3)(4) | 208 | 10 | 5 | 6943 | 105 | 3 |
| 6.3 | 330 | X/7343-43 | T543Y337(1)006A(2)(3)(4) | 208 | 10 | 6 | 6338 | 105 | 3 |
| 6.3 | 330 | X/7343-43 | T543Y337(1)006A(2)(3)(4) | 208 | 10 | 10 | 4909 | 105 | 3 |
| 6.3 | 330 | X/7343-43 | T543Y337(1)006A(2)(3)(4) | 208 | 10 | 15 | 4008 | 105 | 3 |
| 6.3 | 330 | X/7343-43 | T543Y337(1)006A(2)(3)(4) | 208 | 10 | 25 | 3105 | 105 | 3 |
| 6.3 | 330 | X/7343-43 | T543Y337(1)006A(2)(3)(4) | 208 | 10 | 40 | 2455 | 105 | 3 |
| 6.3 | 470 | W/7343-15 | T543W477(1)006A(2)(3)(4) | 296 | 10 | 55 | 1809 | 85 | 3 |
| 6.3 | 470 | V/7343-20 | T543V477(1)006A(2)(3)(4) | 296 | 10 | 55 | 1844 | 85 | 3 |
| 6.3 | 470 | D/7343-31 | T543D477(1)006A(2)(3)(4) | 296 | 10 | 15 | 3873 | 105 | 3 |
| 6.3 | 470 | D/7343-31 | T543D477(1)006A(2)(3)(4) | 296 | 10 | 25 | 3000 | 105 | 3 |
| 6.3 | 470 | D/7343-31 | T543D477(1)006A(2)(3)(4) | 296 | 10 | 30 | 2739 | 105 | 3 |
| 6.3 | 470 | X/7343-43 | T543Y477(1)006A(2)(3)(4) | 296 | 10 | 5 | 6943 | 105 | 3 |
| 6.3 | 470 | X/7343-43 | T543Y477(1)006A(2)(3)(4) | 296 | 10 | 10 | 4909 | 105 | 3 |
| 6.3 | 470 | X/7343-43 | T543Y477(1)006A(2)(3)(4) | 296 | 10 | 15 | 4008 | 105 | 3 |
| 6.3 | 470 | X/7343-43 | T543Y477(1)006A(2)(3)(4) | 296 | 10 | 18 | 3659 | 105 | 3 |
| 6.3 | 470 | X/7343-43 | T543Y477(1)006A(2)(3)(4) | 296 | 10 | 25 | 3105 | 105 | 3 |
| 6.3 | 470 | X/7343-43 | T543Y477(1)006A(2)(3)(4) | 296 | 10 | 35 | 2624 | 105 | 3 |
| 6.3 | 470 | X/7343-43 | T543X477(1)006A(2)(3)(4) | 296 | 10 | 5 | 7029 | 105 | 3 |
| V | μF | KEMET/EIA | (See below for part options) | (μA) @ V _R , 20°C Maximum/ 5 Minutes | % @ 20°C 120 Hz Maximum | (mΩ) @ 20°C 100 kHz Maximum | (mA) 45°C 100 kHz | (°C) | Temperature ≤ 260°C |
| Rated Voltage | Rated Capacitance | Case Code/ Case Size | KEMET Part Number | DC Leakage | DF | ESR | Maximum Allowable Ripple Current | Rated Temperature | Moisture Sensitivity |

- (1) To complete KEMET part number, insert M for ±20%, K for ±10%. Designates capacitance tolerance.
 (2) To complete KEMET part number, H = Solder Plated, T = 100% Tin (Sn). Designates termination finish.
 (3) To complete KEMET part number, insert E = None, S = 10 cycles +25°C, W = 10 cycles -55°C +85°C. Designates surge current option.
 (4) To complete KEMET part number, insert the ESR in mΩ, for example 50 mΩ = 050. Designates ESR option.
 Refer to Ordering Information for additional detail.

Table 1 – Ratings & Part Number Reference cont'd

| Rated Voltage | Rated Cap | Case Code/ Case Size | KEMET Part Number | DC Leakage | DF | ESR | Maximum Allowable Ripple Current | Rated Temp | Moisture Sensitivity |
|---------------|-------------------|-------------------------|------------------------------|---|-------------------------------|-----------------------------------|-------------------------------------|-------------------|------------------------|
| V | μF | KEMET/EIA | (See below for part options) | (μA) @ V _R , 20°C Maximum/ 5 Minutes | % @ 20°C 120 Hz Maximum | (mΩ) @ 20°C 100 kHz Maximum | (mA) 45°C 100 kHz | (°C) | Temperature ≤ 260°C |
| 6.3 | 470 | X/7343-43 | T543X477(1)006A(2)(3)(4) | 296 | 10 | 6 | 6416 | 105 | 3 |
| 6.3 | 470 | X/7343-43 | T543X477(1)006A(2)(3)(4) | 296 | 10 | 10 | 4970 | 105 | 3 |
| 6.3 | 470 | X/7343-43 | T543X477(1)006A(2)(3)(4) | 296 | 10 | 18 | 3704 | 105 | 3 |
| 6.3 | 470 | X/7343-43 | T543X477(1)006A(2)(3)(4) | 296 | 10 | 35 | 2657 | 105 | 3 |
| 6.3 | 470 | X/7343-43 | T543X477(1)006A(2)(3)(4) | 296 | 10 | 40 | 2485 | 105 | 3 |
| 6.3 | 680 | X/7343-43 | T543X687(1)006A(2)(3)(4) | 428 | 10 | 10 | 4970 | 105 | 3 |
| 6.3 | 680 | X/7343-43 | T543X687(1)006A(2)(3)(4) | 428 | 10 | 18 | 3704 | 105 | 3 |
| 6.3 | 1000 | D/7343-31 | T543H108(1)006A(2)(3)(4) | 630 | 20 | 55 | 1844 | 85 | 4 |
| 6.3 | 1500 | D/7343-31 | T543H158(1)006A(2)(3)(4) | 945 | 20 | 55 | 1844 | 85 | 4 |
| 8 | 33 | T/3528-12 | T543T336(1)008A(2)(3)(4) | 26 | 8 | 70 | 1225 | 105 | 3 |
| 8 | 33 | T/3528-12 | T543T336(1)008A(2)(3)(4) | 26 | 8 | 80 | 1146 | 105 | 3 |
| 8 | 33 | B/3528-21 | T543B336(1)008A(2)(3)(4) | 26 | 8 | 25 | 2254 | 105 | 3 |
| 8 | 33 | B/3528-21 | T543B336(1)008A(2)(3)(4) | 26 | 8 | 35 | 1905 | 105 | 3 |
| 8 | 33 | B/3528-21 | T543B336(1)008A(2)(3)(4) | 26 | 8 | 40 | 1782 | 105 | 3 |
| 8 | 33 | B/3528-21 | T543B336(1)008A(2)(3)(4) | 26 | 8 | 70 | 1347 | 105 | 3 |
| 8 | 33 | U/6032-15 | T543U336(1)008A(2)(3)(4) | 26 | 8 | 70 | 1389 | 105 | 3 |
| 8 | 47 | B/3528-21 | T543B476(1)008A(2)(3)(4) | 38 | 8 | 35 | 1905 | 105 | 3 |
| 8 | 47 | B/3528-21 | T543B476(1)008A(2)(3)(4) | 38 | 8 | 70 | 1347 | 105 | 3 |
| 8 | 150 | V/7343-20 | T543V157(1)008A(2)(3)(4) | 120 | 10 | 40 | 2162 | 105 | 3 |
| 8 | 150 | D/7343-31 | T543D157(1)008A(2)(3)(4) | 120 | 10 | 25 | 3000 | 105 | 3 |
| 8 | 150 | D/7343-31 | T543D157(1)008A(2)(3)(4) | 120 | 10 | 40 | 2372 | 105 | 3 |
| 8 | 150 | D/7343-31 | T543D157(1)008A(2)(3)(4) | 120 | 10 | 55 | 2023 | 105 | 3 |
| 10 | 10 | A/3216-18 | T543A106(1)010A(2)(3)(4) | 10 | 8 | 80 | 1183 | 105 | 3 |
| 10 | 15 | A/3216-18 | T543A156(1)010A(2)(3)(4) | 15 | 8 | 80 | 1183 | 105 | 3 |
| 10 | 22 | A/3216-18 | T543A226(1)010A(2)(3)(4) | 22 | 8 | 80 | 1183 | 105 | 3 |
| 10 | 22 | B/3528-21 | T543B226(1)010A(2)(3)(4) | 22 | 8 | 80 | 1260 | 105 | 3 |
| 10 | 33 | T/3528-12 | T543T336(1)010A(2)(3)(4) | 33 | 8 | 70 | 1225 | 105 | 3 |
| 10 | 33 | T/3528-12 | T543T336(1)010A(2)(3)(4) | 33 | 8 | 80 | 1146 | 105 | 3 |
| 10 | 33 | B/3528-21 | T543B336(1)010A(2)(3)(4) | 33 | 8 | 25 | 2254 | 105 | 3 |
| 10 | 33 | B/3528-21 | T543B336(1)010A(2)(3)(4) | 33 | 8 | 35 | 1905 | 105 | 3 |
| 10 | 33 | B/3528-21 | T543B336(1)010A(2)(3)(4) | 33 | 8 | 40 | 1782 | 105 | 3 |
| 10 | 33 | B/3528-21 | T543B336(1)010A(2)(3)(4) | 33 | 8 | 70 | 1347 | 105 | 3 |
| 10 | 33 | B/3528-21 | T543B336(1)010A(2)(3)(4) | 33 | 8 | 80 | 1260 | 105 | 3 |
| 10 | 33 | U/6032-15 | T543U336(1)010A(2)(3)(4) | 33 | 8 | 70 | 1389 | 105 | 3 |
| 10 | 47 | B/3528-21 | T543B476(1)010A(2)(3)(4) | 47 | 8 | 35 | 1905 | 105 | 3 |
| 10 | 47 | B/3528-21 | T543B476(1)010A(2)(3)(4) | 47 | 8 | 70 | 1347 | 105 | 3 |
| 10 | 47 | U/6032-15 | T543U476(1)010A(2)(3)(4) | 47 | 8 | 55 | 1567 | 105 | 3 |
| 10 | 47 | C/6032-28 | T543C476(1)010A(2)(3)(4) | 47 | 8 | 100 | 1285 | 105 | 3 |
| 10 | 68 | U/6032-15 | T543U686(1)010A(2)(3)(4) | 68 | 8 | 55 | 1567 | 105 | 3 |
| 10 | 68 | C/6032-28 | T543C686(1)010A(2)(3)(4) | 68 | 8 | 45 | 1915 | 105 | 3 |
| 10 | 68 | W/7343-15 | T543W686(1)010A(2)(3)(4) | 68 | 10 | 25 | 2683 | 105 | 3 |
| 10 | 68 | W/7343-15 | T543W686(1)010A(2)(3)(4) | 68 | 10 | 40 | 2121 | 105 | 3 |
| 10 | 68 | V/7343-20 | T543V686(1)010A(2)(3)(4) | 68 | 10 | 25 | 2735 | 105 | 3 |
| 10 | 68 | V/7343-20 | T543V686(1)010A(2)(3)(4) | 68 | 10 | 40 | 2162 | 105 | 3 |
| 10 | 68 | V/7343-20 | T543V686(1)010A(2)(3)(4) | 68 | 10 | 45 | 2039 | 105 | 3 |
| 10 | 68 | V/7343-20 | T543V686(1)010A(2)(3)(4) | 68 | 10 | 60 | 1765 | 105 | 3 |
| 10 | 68 | V/7343-20 | T543V686(1)010A(2)(3)(4) | 68 | 10 | 100 | 1367 | 105 | 3 |
| 10 | 68 | D/7343-31 | T543D686(1)010A(2)(3)(4) | 68 | 10 | 100 | 1500 | 105 | 3 |
| 10 | 100 | L/6032-19 | T543L107(1)010A(2)(3)(4) | 100 | 8 | 25 | 2449 | 105 | 3 |
| 10 | 100 | C/6032-28 | T543C107(1)010A(2)(3)(4) | 100 | 8 | 25 | 2569 | 105 | 3 |
| 10 | 100 | C/6032-28 | T543C107(1)010A(2)(3)(4) | 100 | 8 | 45 | 1915 | 105 | 3 |
| V | μF | KEMET/EIA | (See below for part options) | (μA) @ V _R , 20°C Maximum/ 5 Minutes | % @ 20°C 120 Hz Maximum | (mΩ) @ 20°C 100 kHz Maximum | (mA) 45°C 100 kHz | (°C) | Temperature ≤ 260°C |
| Rated Voltage | Rated Capacitance | Case Code/ Case Size | KEMET Part Number | DC Leakage | DF | ESR | Maximum Allowable Ripple Current | Rated Temperature | Moisture Sensitivity |

(1) To complete KEMET part number, insert M for ±20%, K for ±10%. Designates capacitance tolerance.
 (2) To complete KEMET part number, H = Solder Plated, T = 100% Tin (Sn). Designates termination finish.
 (3) To complete KEMET part number, insert E = None, S = 10 cycles +25°C, W = 10 cycles -55°C +85°C. Designates surge current option.
 (4) To complete KEMET part number, insert the ESR in mΩ, for example 50 mΩ = 050. Designates ESR option.
 Refer to Ordering Information for additional detail.

Table 1 – Ratings & Part Number Reference cont'd

| Rated Voltage | Rated Cap | Case Code/ Case Size | KEMET Part Number | DC Leakage | DF | ESR | Maximum Allowable Ripple Current | Rated Temp | Moisture Sensitivity |
|---------------|-------------------|-------------------------|------------------------------|---|-------------------------------|-----------------------------------|-------------------------------------|-------------------|------------------------|
| V | μF | KEMET/EIA | (See below for part options) | (μA) @ V _R , 20°C Maximum/ 5 Minutes | % @ 20°C 120 Hz Maximum | (mΩ) @ 20°C 100 kHz Maximum | (mA) 45°C 100 kHz | (°C) | Temperature ≤ 260°C |
| 10 | 100 | W/7343-15 | T543W107(1)010A(2)(3)(4) | 100 | 10 | 40 | 2121 | 105 | 3 |
| 10 | 100 | V/7343-20 | T543V107(1)010A(2)(3)(4) | 100 | 10 | 18 | 3223 | 105 | 3 |
| 10 | 100 | V/7343-20 | T543V107(1)010A(2)(3)(4) | 100 | 10 | 25 | 2735 | 105 | 3 |
| 10 | 100 | V/7343-20 | T543V107(1)010A(2)(3)(4) | 100 | 10 | 45 | 2039 | 105 | 3 |
| 10 | 100 | V/7343-20 | T543V107(1)010A(2)(3)(4) | 100 | 10 | 50 | 1934 | 105 | 3 |
| 10 | 100 | D/7343-31 | T543D107(1)010A(2)(3)(4) | 100 | 10 | 18 | 3536 | 105 | 3 |
| 10 | 100 | D/7343-31 | T543D107(1)010A(2)(3)(4) | 100 | 10 | 25 | 3000 | 105 | 3 |
| 10 | 100 | D/7343-31 | T543D107(1)010A(2)(3)(4) | 100 | 10 | 55 | 2023 | 105 | 3 |
| 10 | 100 | D/7343-31 | T543D107(1)010A(2)(3)(4) | 100 | 10 | 80 | 1677 | 105 | 3 |
| 10 | 150 | C/6032-28 | T543C157(1)010A(2)(3)(4) | 150 | 8 | 55 | 1732 | 105 | 3 |
| 10 | 150 | V/7343-20 | T543V157(1)010A(2)(3)(4) | 150 | 10 | 25 | 2735 | 105 | 3 |
| 10 | 150 | V/7343-20 | T543V157(1)010A(2)(3)(4) | 150 | 10 | 40 | 2162 | 105 | 3 |
| 10 | 150 | D/7343-31 | T543D157(1)010A(2)(3)(4) | 150 | 10 | 5 | 6708 | 105 | 3 |
| 10 | 150 | D/7343-31 | T543D157(1)010A(2)(3)(4) | 150 | 10 | 6 | 6124 | 105 | 3 |
| 10 | 150 | D/7343-31 | T543D157(1)010A(2)(3)(4) | 150 | 10 | 10 | 4743 | 105 | 3 |
| 10 | 150 | D/7343-31 | T543D157(1)010A(2)(3)(4) | 150 | 10 | 15 | 3873 | 105 | 3 |
| 10 | 150 | D/7343-31 | T543D157(1)010A(2)(3)(4) | 150 | 10 | 18 | 3536 | 105 | 3 |
| 10 | 150 | D/7343-31 | T543D157(1)010A(2)(3)(4) | 150 | 10 | 25 | 3000 | 105 | 3 |
| 10 | 150 | D/7343-31 | T543D157(1)010A(2)(3)(4) | 150 | 10 | 40 | 2372 | 105 | 3 |
| 10 | 150 | D/7343-31 | T543D157(1)010A(2)(3)(4) | 150 | 10 | 55 | 2023 | 105 | 3 |
| 10 | 150 | X/7343-43 | T543Y157(1)010A(2)(3)(4) | 150 | 10 | 25 | 3105 | 105 | 3 |
| 10 | 150 | X/7343-43 | T543Y157(1)010A(2)(3)(4) | 150 | 10 | 18 | 3659 | 105 | 3 |
| 10 | 150 | X/7343-43 | T543Y157(1)010A(2)(3)(4) | 150 | 10 | 25 | 3105 | 105 | 3 |
| 10 | 220 | V/7343-20 | T543V227(1)010A(2)(3)(4) | 220 | 10 | 25 | 2735 | 105 | 3 |
| 10 | 220 | V/7343-20 | T543V227(1)010A(2)(3)(4) | 220 | 10 | 45 | 2039 | 105 | 3 |
| 10 | 220 | D/7343-31 | T543D227(1)010A(2)(3)(4) | 220 | 10 | 6 | 6124 | 105 | 3 |
| 10 | 220 | D/7343-31 | T543D227(1)010A(2)(3)(4) | 220 | 10 | 10 | 4743 | 105 | 3 |
| 10 | 220 | D/7343-31 | T543D227(1)010A(2)(3)(4) | 220 | 10 | 18 | 3536 | 105 | 3 |
| 10 | 220 | D/7343-31 | T543D227(1)010A(2)(3)(4) | 220 | 10 | 25 | 3000 | 105 | 3 |
| 10 | 220 | D/7343-31 | T543D227(1)010A(2)(3)(4) | 220 | 10 | 40 | 2372 | 105 | 3 |
| 10 | 220 | X/7343-43 | T543Y227(1)010A(2)(3)(4) | 220 | 10 | 6 | 6338 | 105 | 3 |
| 10 | 220 | X/7343-43 | T543Y227(1)010A(2)(3)(4) | 220 | 10 | 10 | 4909 | 105 | 3 |
| 10 | 220 | X/7343-43 | T543Y227(1)010A(2)(3)(4) | 220 | 10 | 40 | 2455 | 105 | 3 |
| 10 | 330 | X/7343-43 | T543Y337(1)010A(2)(3)(4) | 330 | 10 | 15 | 4008 | 105 | 3 |
| 10 | 330 | X/7343-43 | T543Y337(1)010A(2)(3)(4) | 330 | 10 | 35 | 2624 | 105 | 3 |
| 10 | 330 | X/7343-43 | T543X337(1)010A(2)(3)(4) | 330 | 10 | 5 | 7029 | 105 | 3 |
| 10 | 330 | X/7343-43 | T543X337(1)010A(2)(3)(4) | 330 | 10 | 6 | 6416 | 105 | 3 |
| 10 | 330 | X/7343-43 | T543X337(1)010A(2)(3)(4) | 330 | 10 | 10 | 4970 | 105 | 3 |
| 10 | 330 | X/7343-43 | T543X337(1)010A(2)(3)(4) | 330 | 10 | 25 | 3143 | 105 | 3 |
| 10 | 330 | X/7343-43 | T543X337(1)010A(2)(3)(4) | 330 | 10 | 40 | 2485 | 105 | 3 |
| 12.5 | 10 | T/3528-12 | T543T106(1)12RA(2)(3)(4) | 13 | 8 | 150 | 837 | 105 | 3 |
| 12.5 | 15 | T/3528-12 | T543T156(1)12RA(2)(3)(4) | 19 | 8 | 80 | 1146 | 105 | 3 |
| 12.5 | 330 | X/7343-43 | T543X337(1)12RA(2)(3)(4) | 413 | 10 | 15 | 4058 | 105 | 3 |
| 16 | 10 | B/3528-21 | T543B106(1)016A(2)(3)(4) | 16 | 8 | 100 | 1127 | 105 | 3 |
| 16 | 22 | C/6032-28 | T543C226(1)016A(2)(3)(4) | 35 | 8 | 80 | 1436 | 105 | 3 |
| 16 | 33 | W/7343-15 | T543W336(1)016A(2)(3)(4) | 53 | 10 | 45 | 2000 | 105 | 3 |
| 16 | 33 | V/7343-20 | T543V336(1)016A(2)(3)(4) | 53 | 10 | 45 | 2039 | 105 | 3 |
| 16 | 33 | V/7343-20 | T543V336(1)016A(2)(3)(4) | 53 | 10 | 60 | 1765 | 105 | 3 |
| 16 | 33 | V/7343-20 | T543V336(1)016A(2)(3)(4) | 53 | 10 | 70 | 1634 | 105 | 3 |
| 16 | 47 | W/7343-15 | T543W476(1)016A(2)(3)(4) | 75 | 10 | 45 | 2000 | 105 | 3 |
| 16 | 47 | V/7343-20 | T543V476(1)016A(2)(3)(4) | 75 | 10 | 45 | 2039 | 105 | 3 |
| V | μF | KEMET/EIA | (See below for part options) | (μA) @ V _R , 20°C Maximum/ 5 Minutes | % @ 20°C 120 Hz Maximum | (mΩ) @ 20°C 100 kHz Maximum | (mA) 45°C 100 kHz | (°C) | Temperature ≤ 260°C |
| Rated Voltage | Rated Capacitance | Case Code/ Case Size | KEMET Part Number | DC Leakage | DF | ESR | Maximum Allowable Ripple Current | Rated Temperature | Moisture Sensitivity |

(1) To complete KEMET part number, insert M for ±20%, K for ±10%. Designates capacitance tolerance.
 (2) To complete KEMET part number, H = Solder Plated, T = 100% Tin (Sn). Designates termination finish.
 (3) To complete KEMET part number, insert E = None, S = 10 cycles +25°C, W = 10 cycles -55°C +85°C. Designates surge current option.
 (4) To complete KEMET part number, insert the ESR in mΩ, for example 50 mΩ = 050. Designates ESR option.
 Refer to Ordering Information for additional detail.

Table 1 – Ratings & Part Number Reference cont'd

| Rated Voltage | Rated Cap | Case Code/ Case Size | KEMET Part Number | DC Leakage | DF | ESR | Maximum Allowable Ripple Current | Rated Temp | Moisture Sensitivity |
|---------------|-------------------|-------------------------|------------------------------|---|-------------------------------|-----------------------------------|-------------------------------------|-------------------|------------------------|
| V | μF | KEMET/EIA | (See below for part options) | (μA) @ V _R , 20°C Maximum/ 5 Minutes | % @ 20°C 120 Hz Maximum | (mΩ) @ 20°C 100 kHz Maximum | (mA) 45°C 100 kHz | (°C) | Temperature ≤ 260°C |
| 16 | 47 | V/7343-20 | T543V476(1)016A(2)(3)(4) | 75 | 10 | 70 | 1634 | 105 | 3 |
| 16 | 47 | V/7343-20 | T543V476(1)016A(2)(3)(4) | 75 | 10 | 80 | 1529 | 105 | 3 |
| 16 | 47 | D/7343-31 | T543D476(1)016A(2)(3)(4) | 75 | 10 | 35 | 2535 | 105 | 3 |
| 16 | 47 | D/7343-31 | T543D476(1)016A(2)(3)(4) | 75 | 10 | 65 | 1861 | 105 | 3 |
| 16 | 47 | D/7343-31 | T543D476(1)016A(2)(3)(4) | 75 | 10 | 70 | 1793 | 105 | 3 |
| 16 | 68 | V/7343-20 | T543V686(1)016A(2)(3)(4) | 109 | 10 | 50 | 1934 | 105 | 3 |
| 16 | 68 | V/7343-20 | T543V686(1)016A(2)(3)(4) | 109 | 10 | 90 | 1441 | 105 | 3 |
| 16 | 100 | V/7343-20 | T543V107(1)016A(2)(3)(4) | 160 | 10 | 50 | 1934 | 105 | 3 |
| 16 | 100 | D/7343-31 | T543D107(1)016A(2)(3)(4) | 160 | 10 | 35 | 2535 | 105 | 3 |
| 16 | 100 | D/7343-31 | T543D107(1)016A(2)(3)(4) | 160 | 10 | 50 | 2121 | 105 | 3 |
| 16 | 150 | X/7343-43 | T543X157(1)016A(2)(3)(4) | 240 | 10 | 15 | 4058 | 105 | 3 |
| 16 | 150 | X/7343-43 | T543X157(1)016A(2)(3)(4) | 240 | 10 | 25 | 3143 | 105 | 3 |
| 16 | 150 | X/7343-43 | T543X157(1)016A(2)(3)(4) | 240 | 10 | 40 | 2485 | 105 | 3 |
| 16 | 150 | X/7343-43 | T543X157(1)016A(2)(3)(4) | 240 | 10 | 80 | 1757 | 105 | 3 |
| 16 | 220 | X/7343-43 | T543X227(1)016A(2)(3)(4) | 352 | 10 | 35 | 2657 | 105 | 3 |
| 16 | 220 | X/7343-43 | T543X227(1)016A(2)(3)(4) | 352 | 10 | 80 | 1757 | 105 | 3 |
| 16 | 330 | X/7343-43 | T543X337(1)016A(2)(3)(4) | 528 | 10 | 25 | 3143 | 105 | 3 |
| 16 | 330 | X/7343-43 | T543X337(1)016A(2)(3)(4) | 528 | 10 | 50 | 2223 | 105 | 3 |
| 20 | 22 | V/7343-20 | T543V226(1)020A(2)(3)(4) | 44 | 10 | 40 | 2162 | 105 | 3 |
| 20 | 22 | V/7343-20 | T543V226(1)020A(2)(3)(4) | 44 | 10 | 45 | 2039 | 105 | 3 |
| 20 | 22 | V/7343-20 | T543V226(1)020A(2)(3)(4) | 44 | 10 | 90 | 1441 | 105 | 3 |
| 20 | 22 | D/7343-31 | T543D226(1)020A(2)(3)(4) | 44 | 10 | 40 | 2372 | 105 | 3 |
| 20 | 22 | D/7343-31 | T543D226(1)020A(2)(3)(4) | 44 | 10 | 45 | 2236 | 105 | 3 |
| 20 | 22 | D/7343-31 | T543D226(1)020A(2)(3)(4) | 44 | 10 | 90 | 1581 | 105 | 3 |
| 20 | 33 | D/7343-31 | T543D336(1)020A(2)(3)(4) | 66 | 10 | 60 | 1936 | 105 | 3 |
| 20 | 47 | V/7343-20 | T543V476(1)020A(2)(3)(4) | 94 | 10 | 55 | 1844 | 105 | 3 |
| 20 | 47 | V/7343-20 | T543V476(1)020A(2)(3)(4) | 94 | 10 | 90 | 1441 | 105 | 3 |
| 20 | 47 | D/7343-31 | T543D476(1)020A(2)(3)(4) | 94 | 10 | 55 | 2023 | 105 | 3 |
| 20 | 100 | X/7343-43 | T543X107(1)020A(2)(3)(4) | 200 | 10 | 35 | 2657 | 105 | 3 |
| 20 | 100 | X/7343-43 | T543X107(1)020A(2)(3)(4) | 200 | 10 | 50 | 2223 | 105 | 3 |
| 25 | 15 | V/7343-20 | T543V156(1)025A(2)(3)(4) | 38 | 10 | 90 | 1441 | 105 | 3 |
| 25 | 15 | D/7343-31 | T543D156(1)025A(2)(3)(4) | 38 | 10 | 60 | 1936 | 105 | 3 |
| 25 | 15 | D/7343-31 | T543D156(1)025A(2)(3)(4) | 38 | 10 | 80 | 1677 | 105 | 3 |
| 25 | 22 | V/7343-20 | T543V226(1)025A(2)(3)(4) | 55 | 10 | 60 | 1765 | 105 | 3 |
| 25 | 22 | V/7343-20 | T543V226(1)025A(2)(3)(4) | 55 | 10 | 90 | 1441 | 105 | 3 |
| 25 | 33 | V/7343-20 | T543V336(1)025A(2)(3)(4) | 83 | 10 | 60 | 1765 | 105 | 3 |
| 25 | 33 | D/7343-31 | T543D336(1)025A(2)(3)(4) | 83 | 10 | 60 | 1936 | 105 | 3 |
| 25 | 68 | X/7343-43 | T543X686(1)025A(2)(3)(4) | 170 | 10 | 35 | 2657 | 105 | 3 |
| 25 | 68 | X/7343-43 | T543X686(1)025A(2)(3)(4) | 170 | 10 | 50 | 2223 | 105 | 3 |
| 25 | 100 | X/7343-43 | T543X107(1)025A(2)(3)(4) | 250 | 10 | 60 | 2029 | 105 | 3 |
| 35 | 15 | V/7343-20 | T543V156(1)035A(2)(3)(4) | 53 | 10 | 100 | 1367 | 105 | 3 |
| 35 | 15 | V/7343-20 | T543V156(1)035A(2)(3)(4) | 53 | 10 | 125 | 1223 | 105 | 3 |
| 35 | 15 | D/7343-31 | T543D156(1)035A(2)(3)(4) | 53 | 10 | 100 | 1500 | 105 | 3 |
| 35 | 15 | D/7343-31 | T543D156(1)035A(2)(3)(4) | 53 | 10 | 125 | 1342 | 105 | 3 |
| 35 | 33 | X/7343-43 | T543X336(1)035A(2)(3)(4) | 116 | 10 | 65 | 1949 | 105 | 3 |
| 35 | 47 | X/7343-43 | T543X476(1)035A(2)(3)(4) | 165 | 10 | 30 | 2869 | 105 | 3 |
| 35 | 47 | X/7343-43 | T543X476(1)035A(2)(3)(4) | 165 | 10 | 60 | 2029 | 105 | 3 |
| 50 | 5.6 | D/7343-31 | T543D565(1)050A(2)(3)(4) | 28 | 10 | 70 | 1793 | 105 | 3 |
| 50 | 5.6 | D/7343-31 | T543D565(1)050A(2)(3)(4) | 28 | 10 | 90 | 1581 | 105 | 3 |
| 50 | 10 | D/7343-31 | T543D106(1)050A(2)(3)(4) | 50 | 10 | 90 | 1581 | 105 | 3 |
| 50 | 12 | X/7343-43 | T543X126(1)050A(2)(3)(4) | 60 | 10 | 45 | 2343 | 105 | 3 |
| V | μF | KEMET/EIA | (See below for part options) | (μA) @ V _R , 20°C Maximum/ 5 Minutes | % @ 20°C 120 Hz Maximum | (mΩ) @ 20°C 100 kHz Maximum | (mA) 45°C 100 kHz | (°C) | Temperature ≤ 260°C |
| Rated Voltage | Rated Capacitance | Case Code/ Case Size | KEMET Part Number | DC Leakage | DF | ESR | Maximum Allowable Ripple Current | Rated Temperature | Moisture Sensitivity |

(1) To complete KEMET part number, insert M for ±20%, K for ±10%. Designates capacitance tolerance.
 (2) To complete KEMET part number, H = Solder Plated, T = 100% Tin (Sn). Designates termination finish.
 (3) To complete KEMET part number, insert E = None, S = 10 cycles +25°C, W = 10 cycles -55°C +85°C. Designates surge current option.
 (4) To complete KEMET part number, insert the ESR in mΩ, for example 50 mΩ = 050. Designates ESR option.
 Refer to Ordering Information for additional detail.

Table 1 – Ratings & Part Number Reference cont'd

| Rated Voltage | Rated Cap | Case Code/ Case Size | KEMET Part Number | DC Leakage | DF | ESR | Maximum Allowable Ripple Current | Rated Temp | Moisture Sensitivity |
|---------------|-------------------|-------------------------|------------------------------|---|-------------------------------|-----------------------------------|-------------------------------------|-------------------|------------------------|
| V | μF | KEMET/EIA | (See below for part options) | (μA) @ V _R , 20°C Maximum/ 5 Minutes | % @ 20°C 120 Hz Maximum | (mΩ) @ 20°C 100 kHz Maximum | (mA) 45°C 100 kHz | (°C) | Temperature ≤ 260°C |
| 50 | 12 | X/7343-43 | T543X126(1)050A(2)(3)(4) | 60 | 10 | 70 | 1878 | 105 | 3 |
| 50 | 18 | X/7343-43 | T543X186(1)050A(2)(3)(4) | 90 | 10 | 35 | 2657 | 105 | 3 |
| 50 | 18 | X/7343-43 | T543X186(1)050A(2)(3)(4) | 90 | 10 | 70 | 1878 | 105 | 3 |
| 50 | 22 | X/7343-43 | T543X226(1)050A(2)(3)(4) | 110 | 10 | 40 | 2485 | 105 | 3 |
| 50 | 22 | X/7343-43 | T543X226(1)050A(2)(3)(4) | 110 | 10 | 75 | 1815 | 105 | 3 |
| 50 | 33 | X/7343-43 | T543X336(1)050A(2)(3)(4) | 165 | 10 | 40 | 2485 | 105 | 3 |
| 50 | 33 | X/7343-43 | T543X336(1)050A(2)(3)(4) | 165 | 10 | 75 | 1815 | 105 | 3 |
| 50 | 10 | D/7343-31 | T543D106(1)050A(2)(3)(4) | 50 | 10 | 100 | 1572 | 105 | 3 |
| 50 | 10 | D/7343-31 | T543D106(1)050A(2)(3)(4) | 50 | 10 | 120 | 1435 | 105 | 3 |
| 50 | 18 | X/7343-43 | T543X186(1)050A(2)(3)(4) | 90 | 10 | 70 | 1878 | 105 | 3 |
| 63 | 4.7 | D/7343-31 | T543D475(1)063A(2)(3)(4) | 30 | 10 | 100 | 1572 | 105 | 3 |
| 63 | 4.7 | D/7343-31 | T543D475(1)063A(2)(3)(4) | 30 | 10 | 120 | 1435 | 105 | 3 |
| 63 | 10 | X/7343-43 | T543X106(1)063A(2)(3)(4) | 63 | 10 | 75 | 1815 | 105 | 3 |
| 63 | 10 | X/7343-43 | T543X106(1)063A(2)(3)(4) | 63 | 10 | 100 | 1572 | 105 | 3 |
| 63 | 10 | X/7343-43 | T543X106(1)063A(2)(3)(4) | 63 | 10 | 150 | 1283 | 105 | 3 |
| 63 | 15 | X/7343-43 | T543X156(1)063A(2)(3)(4) | 95 | 10 | 50 | 2223 | 105 | 3 |
| V | μF | KEMET/EIA | (See below for part options) | (μA) @ V _R , 20°C Maximum/ 5 Minutes | % @ 20°C 120 Hz Maximum | (mΩ) @ 20°C 100 kHz Maximum | (mA) 45°C 100 kHz | (°C) | Temperature ≤ 260°C |
| Rated Voltage | Rated Capacitance | Case Code/ Case Size | KEMET Part Number | DC Leakage | DF | ESR | Maximum Allowable Ripple Current | Rated Temperature | Moisture Sensitivity |

- (1) To complete KEMET part number, insert M for ±20%, K for ±10%. Designates capacitance tolerance.
 (2) To complete KEMET part number, H = Solder Plated, T = 100% Tin (Sn). Designates termination finish.
 (3) To complete KEMET part number, insert E = None, S = 10 cycles +25°C, W = 10 cycles -55°C +85°C. Designates surge current option.
 (4) To complete KEMET part number, insert the ESR in mΩ, for example 50 mΩ = 050. Designates ESR option.
 Refer to Ordering Information for additional detail.

Derating Guidelines

| Voltage Rating | Maximum Recommended Steady State Voltage | Maximum Recommended Transient Voltage (1 ms – 1 μs) |
|---|--|---|
| -55°C to 105°C | | |
| $2.5\text{ V} \leq V_R \leq 10\text{ V}$ | 90% of V_R | V_R |
| $12.5\text{ V} \leq V_R \leq 63\text{ V}$ | 80% of V_R | V_R |

V_R = Rated Voltage

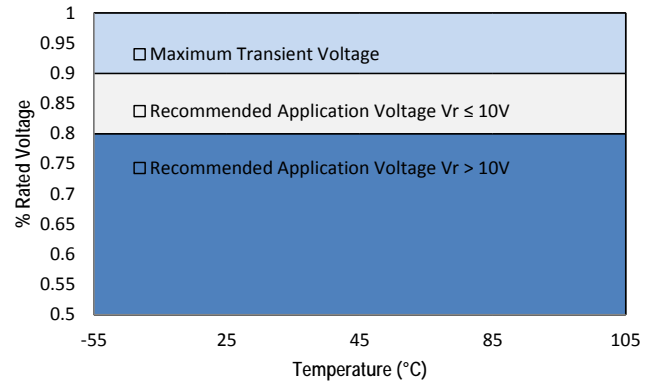

Ripple Current/Ripple Voltage

Permissible AC ripple voltage and current are related to equivalent series resistance (ESR) and the power dissipation capabilities of the device. Permissible AC ripple voltage which may be applied is limited by two criteria:

1. The positive peak AC voltage plus the DC bias voltage, if any, must not exceed the DC voltage rating of the capacitor.
2. The negative peak AC voltage in combination with bias voltage, if any, must not exceed the allowable limits specified for reverse voltage. See the Reverse Voltage section for allowable limits.

The maximum power dissipation by case size can be determined using the table at right. The maximum power dissipation rating stated in the table must be reduced with increasing environmental operating temperatures. Refer to the table below for temperature compensation requirements.

| Temperature Compensation Multipliers for Maximum Power Dissipation | | |
|--|--|---|
| $\leq 45^\circ\text{C}$ | $45^\circ\text{C} < T \leq 85^\circ\text{C}$ | $85^\circ\text{C} < T \leq 125^\circ\text{C}$ |
| 1.00 | 0.70 | 0.25 |

T = Environmental Temperature

Using the P_{max} of the device, the maximum allowable rms ripple current or voltage may be determined.

$$I(max) = \sqrt{P_{max}/R}$$

$$E(max) = \sqrt{P_{max} \cdot R}$$

I = rms ripple current (amperes)

E = rms ripple voltage (volts)

P_{max} = maximum power dissipation (watts)

R = ESR at specified frequency (ohms)

| Case Code | EIA Case Code | Maximum Power Dissipation (P_{max}) mWatts @ 45°C with +30°C Rise |
|-----------|---------------|---|
| T | 3528-12 | 105 |
| M | 3528-15 | 120 |
| A | 3216-18 | 112 |
| B | 3528-21 | 127 |
| U | 6032-15 | 135 |
| L | 3528-19 | 150 |
| C | 6032-28 | 165 |
| W | 7343-15 | 180 |
| V | 7343-20 | 187 |
| D | 7343-31 | 225 |
| Y | 7343-40 | 241 |
| X | 7343-43 | 247 |
| H | 7360-20 | 187 |
| I | 3216-10 | 95 |

The maximum power dissipation rating must be reduced with increasing environmental operating temperatures. Refer to the Temperature Compensation Multiplier table for details.

Reverse Voltage

Polymer tantalum capacitors are polar devices and may be permanently damaged or destroyed if connected in the wrong polarity. These devices will withstand a small degree of transient voltage reversal for short periods as shown in the below table.

| Temperature | Permissible Transient Reverse Voltage |
|-------------|---------------------------------------|
| 25°C | 15% of Rated Voltage |
| 55°C | 10% of Rated Voltage |
| 85°C | 5% of Rated Voltage |
| 105°C | 3% of Rated Voltage |
| 125°C* | 1% of Rated Voltage |

*For series rated to 125°C

Table 2 – Land Dimensions/Courtyard

| KEMET Case | Metric Size Code EIA | Density Level A: Maximum (Most) Land Protrusion (mm) | | | | | Density Level B: Median (Nominal) Land Protrusion (mm) | | | | | Density Level C: Minimum (Least) Land Protrusion (mm) | | | | |
|----------------|-------------------------------|--|------|------|-------|------|--|------|------|------|------|---|------|------|------|------|
| | | X | Y | C | V1 | V2 | X | Y | C | V1 | V2 | X | Y | C | V1 | V2 |
| A | 3216-18 | 1.35 | 2.15 | 1.45 | 6.10 | 2.80 | 1.25 | 1.75 | 1.35 | 5.00 | 2.30 | 1.15 | 1.35 | 1.25 | 4.10 | 2.00 |
| B | 3528-21 | 2.35 | 2.15 | 1.45 | 6.10 | 4.00 | 2.25 | 1.75 | 1.35 | 5.00 | 3.50 | 2.15 | 1.35 | 1.25 | 4.10 | 3.20 |
| C | 6032-25 | 2.35 | 2.65 | 2.60 | 8.90 | 4.40 | 2.25 | 2.25 | 2.50 | 7.80 | 3.90 | 2.15 | 1.85 | 2.40 | 6.90 | 3.60 |
| D | 7343-31 | 2.55 | 3.75 | 2.70 | 10.20 | 5.50 | 2.45 | 3.35 | 2.60 | 9.10 | 5.00 | 2.35 | 2.95 | 2.50 | 8.20 | 4.70 |
| H | 7360-20 | 4.25 | 2.65 | 3.20 | 10.10 | 7.20 | 4.15 | 2.25 | 3.30 | 9.40 | 6.70 | 4.05 | 1.85 | 3.00 | 8.10 | 6.40 |
| L | 6032-19 | 2.35 | 2.65 | 2.60 | 8.90 | 4.40 | 2.25 | 2.25 | 2.50 | 7.80 | 3.90 | 2.15 | 1.85 | 2.40 | 6.90 | 3.60 |
| M | 3528-15 | 2.35 | 2.15 | 1.45 | 6.10 | 4.00 | 2.25 | 1.75 | 1.35 | 5.00 | 3.70 | 2.15 | 1.35 | 1.25 | 4.10 | 3.40 |
| T | 3528-12 | 2.35 | 2.15 | 1.45 | 6.10 | 4.00 | 2.25 | 1.75 | 1.35 | 5.00 | 3.50 | 2.15 | 1.35 | 1.25 | 4.10 | 3.20 |
| U | 6032-15 | 2.35 | 2.65 | 2.60 | 8.90 | 4.40 | 2.25 | 2.25 | 2.50 | 7.80 | 3.90 | 2.15 | 1.85 | 2.40 | 6.90 | 3.60 |
| V | 7343-20 | 2.55 | 3.75 | 2.70 | 10.20 | 5.50 | 2.45 | 3.35 | 2.60 | 9.10 | 5.00 | 2.35 | 2.95 | 2.50 | 8.20 | 4.70 |
| W | 7343-15 | 2.55 | 3.75 | 2.70 | 10.20 | 5.50 | 2.45 | 3.35 | 2.60 | 9.10 | 5.00 | 2.35 | 2.95 | 2.50 | 8.20 | 4.70 |
| X ¹ | 7343-43 | 2.55 | 3.75 | 2.70 | 10.20 | 5.50 | 2.45 | 3.35 | 2.60 | 9.10 | 5.00 | 2.35 | 2.95 | 2.50 | 8.20 | 4.70 |
| Y ¹ | 7343-40 | 2.55 | 3.75 | 2.70 | 10.20 | 5.50 | 2.45 | 3.35 | 2.60 | 9.10 | 5.00 | 2.35 | 2.95 | 2.50 | 8.20 | 4.70 |

Density Level A: For low-density product applications. Recommended for wave solder applications and provides a wider process window for reflow solder processes.

Density Level B: For products with a moderate level of component density. Provides a robust solder attachment condition for reflow solder processes.

Density Level C: For high component density product applications. Before adapting the minimum land pattern variations the user should perform qualification testing based on the conditions outlined in IPC Standard 7351 (IPC-7351).

¹ Height of these chips may create problems in wave soldering.



Soldering Process

KEMET's families of surface mount capacitors are compatible with wave (single or dual), convection, IR, or vapor phase reflow techniques. Preheating of these components is recommended to avoid extreme thermal stress. KEMET's recommended profile conditions for convection and IR reflow reflect the profile conditions of the IPC/J-STD-020D standard for moisture sensitivity testing. The devices can safely withstand a maximum of three reflow passes at these conditions.

Please note that although the X/7343-43 case size can withstand wave soldering, the tall profile (4.3 mm maximum) dictates care in wave process development.

Hand soldering should be performed with care due to the difficulty in process control. If performed, care should be taken to avoid contact of the soldering iron to the molded case. The iron should be used to heat the solder pad, applying solder between the pad and the termination, until reflow occurs. Once reflow occurs, the iron should be removed immediately. "Wiping" the edges of a chip and heating the top surface is not recommended.

During typical reflow operations, a slight darkening of the gold-colored epoxy may be observed. This slight darkening is normal and not harmful to the product. Marking permanency is not affected by this change.

| Profile Feature | SnPb Assembly | Pb-Free Assembly |
|---|---------------------|---------------------|
| Preheat/Soak | | |
| Temperature Minimum (T_{Smin}) | 100°C | 150°C |
| Temperature Maximum (T_{Smax}) | 150°C | 200°C |
| Time (t_s) from T_{Smin} to T_{Smax} | 60 – 120 seconds | 60 – 120 seconds |
| Ramp-up Rate (T_L to T_P) | 3°C/seconds maximum | 3°C/seconds maximum |
| Liquidous Temperature (T_L) | 183°C | 217°C |
| Time Above Liquidous (t_L) | 60 – 150 seconds | 60 – 150 seconds |
| Peak Temperature (T_P) | 220°C* 235°C** | 250°C* 260°C** |
| Time within 5°C of Maximum Peak Temperature (t_p) | 20 seconds maximum | 30 seconds maximum |
| Ramp-down Rate (T_P to T_L) | 6°C/seconds maximum | 6°C/seconds maximum |
| Time 25°C to Peak Temperature | 6 minutes maximum | 8 minutes maximum |

Note: All temperatures refer to the center of the package, measured on the package body surface that is facing up during assembly reflow.

*Case Size D, E, P, Y, and X

**Case Size A, B, C, H, I, K, M, R, S, T, U, V, W, and Z



Construction



Capacitor Marking

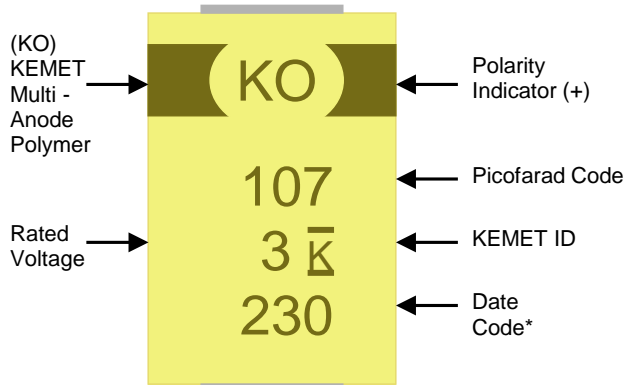

* 230 = 30th week of 2012

| Date Code * | |
|--|--|
| 1 st digit = Last number of Year | 9 = 2009 0 = 2010 1 = 2011 2 = 2012 3 = 2013 4 = 2014 |
| 2 nd and 3 rd digit = Week of the Year | 01 = 1 st week of the Year to 52 = 52 nd week of the Year |

Storage

All KO-CAP Series are shipped in moisture barrier bags with a desiccant and moisture indicator card. These series are classified as MSL3 (Moisture Sensitivity Level 3). Product contained within the moisture barrier bags should be stored in normal working environments with temperatures not to exceed 40°C and humidity not in excess of 60% RH.

Overview

The KEMET Organic Capacitor is a tantalum capacitor with a Ta anode and Ta₂O₅ dielectric. A conductive organic polymer replaces the traditionally used MnO₂ as the cathode plate of the capacitor. This results in very low ESR and improved capacitance retention at high frequency. The polymer technology also exhibits a benign failure mode which eliminates the ignition failures that can occur in standard MnO₂ tantalum types. Ta polymers may be operated at voltages up to 90% of rated voltage for part types with rated voltages of ≤ 10 volts and up to 80% of rated voltage for part types > 10 volts with equivalent or better reliability than traditional MnO₂ tantalum capacitors operated at 50% of rated voltage.

The T545 Series was developed to deliver the highest energy per CC of any tantalum surface mount device (SMD). This capability makes this capacitor an excellent solution for designs requiring high energy at relatively low voltages, such as data hardening or data vaulting for solid state drives (SSD's). The T545 Series High Energy Polymer Tantalum Surface Mount Capacitor captures the best features of multilayer ceramic capacitors (low ESR and high frequency capacitance retention), aluminum electrolytic capacitors (higher capacitance and benign failure mode) and proven solid tantalum technology (volumetric efficiency, surface mount capability and extremely long life). In addition, this series is subjected to 100% thermal shock and voltage aging to insure long term reliability.

Benefits

- Extremely low ESR
- High energy delivery capability
- -55°C to 125°C operating temperature range
- Polymer cathode technology
- High frequency capacitance retention
- Non-ignition failure mode
- Capacitance up to 1,500 µF
- Voltage: 6.3 – 16 V
- 100% accelerated steady state aging
- 100% surge current tested
- 100% thermal shock
- Volumetric efficiency, very high capacitance
- Self-healing mechanism
- Taped and reeled per EIA 481-1, EIA standard case sizes

Applications

Typical applications include hold-up, data hardening or vaulting for enterprise and military SSDs, and high end desktop modems.



Environmental Compliance

RoHS Compliant (6/6) according to Directive 2002/95/EC when ordered with 100% Sn solder.



RoHS Compliant

SPICE

For a detailed analysis of specific part numbers, please visit www.kemet.com for a free download of KEMET's SPICE software. The KEMET SPICE program is freeware intended to aid design engineers in analyzing the performance of these capacitors over frequency, temperature, ripple, and DC bias conditions.

Ordering Information

| T | 545 | H | 108 | M | 006 | A | T | E055 |
|-----------------|------------------------------|------------------|--|-----------------------|---|---------------------|-------------------|-------------------|
| Capacitor Class | Series | Case Size | Capacitance Code (pF) | Capacitance Tolerance | Voltage | Failure Rate/Design | Lead Material | ESR |
| T = Tantalum | High Energy Polymer Tantalum | D, H, V, W, X, Y | First two digits represent significant figures. Third digit specifies number of zeros. | M = $\pm 20\%$ | 006 = 6.3 V 010 = 10 V 016 = 16 V | A = N/A | T = 100% Tin (Sn) | ESR in m Ω |

Performance Characteristics

| Item | Performance Characteristics |
|-------------------------|--|
| Operating Temperature | -55°C to 125°C |
| Rated Capacitance Range | 47 μF – 1,500 μF @ 120 Hz/25°C |
| Capacitance Tolerance | M Tolerance (20%) |
| Rated Voltage Range | 6.3 – 16 V |
| DF (120 Hz) | Refer to Part Number Electrical Specification Table |
| ESR (100 kHz) | Refer to Part Number Electrical Specification Table |
| Leakage Current | $\leq 0.1 \text{ CV}$ (μA) at rated voltage after 5 minutes |

Qualification

| Test | Condition | Characteristics | | | | |
|----------------------------|--|-----------------|--|--------|---------------------------------|--|
| Endurance | 85°C @ rated voltage, 2,000 hours** | Δ C/C | Within -20/+10 of initial value | | | |
| | | DF | Within initial limits | | | |
| | | DCL | Within 1.25 x initial limit | | | |
| | | ESR | Within 2.0 x initial limit | | | |
| Storage Life | 85°C @ 0 volts, 2,000 hours** | Δ C/C | Within -20/+10 of initial value | | | |
| | | DF | Within initial limits | | | |
| | | DCL | Within 1.25 x initial limit | | | |
| | | ESR | Within 2.0 x initial limit | | | |
| Humidity | 60°C, 90% RH, 500 hours | Δ C/C | Within -5%/+35% of initial value | | | |
| | | DF | Within initial limits | | | |
| | | DCL | Within 5.0 x initial limit | | | |
| | | ESR | Within 2.0 x initial limit | | | |
| Temperature Stability | Extreme temperature exposure at a succession of continuous steps at +25°C, -55°C, +25°C, +85°C, +25° C | +25°C | -55°C | +85°C | | |
| | | Δ C/C | IL* | +/-20% | +/-20% | |
| | | DF | IL | IL | 1.2 x IL | |
| | | DCL | IL | n/a | 10 x IL | |
| | | Surge Voltage | 85°C, 1.32 x rated voltage, 1,000 cycles | Δ C/C | Within -20/+10 of initial value | |
| | | | | DF | Within initial limits | |
| DCL | Within initial limits | | | | | |
| ESR | Within initial limits | | | | | |
| Mechanical Shock/Vibration | MIL-STD-202, Method 213, Condition I, 100 G peak MIL-STD-202, Method 204, Condition D, 10 Hz to 2,000 Hz, 20 G peak | Δ C/C | Within ±10 of initial value | | | |
| | | DF | Within initial limits | | | |
| | | DCL | Within initial limits | | | |

*IL = Initial limit

**Minimum temperature test condition 85°C

Electrical Characteristics

ESR vs. Frequency



Capacitance vs. Frequency



Dimensions – Millimeters



| Case Size | | Component | | | | | | | | | | | | |
|-----------|---------|----------------------------|----------------------------|----------------------------|---------------------|---------------------|--------------------------|------------------------------|------------|------------|-------------|------------|------------|------------|
| KEMET | EIA | L* | W* | H* | F* ±0.1 ±(0.004) | S* ±0.3 ±(0.012) | B* ±0.15 (Ref) ±0.006 | X (Ref) | P (Ref) | R (Ref) | T (Ref) | A (Min) | G (Ref) | E (Ref) |
| D | 7343-31 | 7.3 ±0.3 (0.287 ±0.012) | 4.3 ±0.3 (0.169 ±0.012) | 2.8 ±0.3 (0.110 ±0.012) | 2.4 (.094) | 1.3 (.051) | 0.5 (.020) | 0.10 ± 0.10 (.004 ± .004) | 0.9 (.035) | 1.0 (.039) | 0.13 (.005) | 3.8 (.150) | 3.5 (.138) | 3.5 (.138) |
| H | 7360-20 | 7.3 ±0.3 (0.287 ±0.012) | 6.0 ±0.3 (0.236 ±0.012) | 2.0 (0.078) Maximum | 4.1 (.161) | 1.3 (.051) | n/a | 0.10 ± 0.10 (.004 ± .004) | n/a | n/a | 0.13 (.005) | 3.3 (.130) | 3.5 (.138) | 3.5 (.138) |
| V | 7343-20 | 7.3 ±0.3 (0.287 ±0.012) | 4.3 ±0.3 (0.169 ±0.012) | 2.0 (0.079) | 2.4 (.094) | 1.3 (.051) | n/a | 0.05 (.002) | n/a | n/a | 0.13 (.005) | 3.8 (.150) | 3.5 (.138) | 3.5 (.138) |
| W | 7343-15 | 7.3 ±0.3 (0.287 ±0.012) | 4.3 ±0.3 (0.169 ±0.012) | 1.5 (0.059) | 2.4 (.094) | 1.3 (.051) | n/a | 0.05 (.002) | n/a | n/a | 0.13 (.005) | 3.8 (.150) | 3.5 (.138) | 3.5 (.138) |
| X | 7343-43 | 7.3 ±0.3 (0.287 ±0.012) | 4.3 ±0.3 (0.169 ±0.012) | 4.0 ±0.3 (0.157 ±0.012) | 2.4 (.094) | 1.3 (.051) | 0.5 (.020) | 0.10 ± 0.10 (.004 ± .004) | 1.7 (.067) | 1.0 (.039) | 0.13 (.005) | 3.8 (.150) | 3.5 (.138) | 3.5 (.138) |
| Y | 7343-40 | 7.3 ±0.3 (0.287 ±0.012) | 4.3 ±0.3 (0.169 ±0.012) | 4.0 (0.157) | 2.4 (.094) | 1.3 (.051) | 0.5 (.020) | 0.10 ± 0.10 (.004 ± .004) | 1.7 (.067) | 1.0 (.039) | 0.13 (.005) | 3.8 (.150) | 3.5 (.138) | 3.5 (.138) |

Notes: (Ref) – Dimensions provided for reference only. No dimensions are provided for B, P or R because low profile cases do not have a bevel or a notch.

* MIL-PRF-55365/8 specified dimensions

Table 1 – Ratings & Part Number Reference

| Rated Voltage | Rated Capacitance | Case Code/ Case Size | KEMET Part Number | DC Leakage | DF | ESR | Maximum Allowable Ripple Current | MSL | Rated Temperature | Energy (mJ) |
|---------------|-------------------|-------------------------|--------------------|---|-------------------------------|-----------------------------------|----------------------------------|----------------------------------|-------------------|--|
| V | µF | KEMET/EIA | | (µA) @ V _R , 20°C Maximum/ 5 Minutes | % @ 20°C 120 Hz Maximum | (mΩ) @ 20°C 100 kHz Maximum | (mA) 45°C 100 kHz | Reflow Temperature ≤ 260°C | (°C) | (½CVa²) - (½CVd²) Va = Voltage Applied Vd = Voltage Drop |
| 6.3 | 1000 | H/7360-20 | T545H108M006ATE055 | 630.0 | 20 | 55 | 1850.0 | 4 | 85 | 11.57 |
| 6.3 | 1500 | H/7360-20 | T545H158M006ATE035 | 945.0 | 20 | 35 | 2300.0 | 4 | 85 | 17.36 |
| 6.3 | 1500 | H/7360-20 | T545H158M006ATE055 | 945.0 | 20 | 55 | 1850.0 | 4 | 85 | 17.36 |
| 6.3 | 470 | W/7343-15 | T545W477M006ATE035 | 296.0 | 10 | 35 | 2300.0 | 4 | 105 | 5.44 |
| 6.3 | 470 | W/7343-15 | T545W477M006ATE055 | 296.0 | 10 | 55 | 1800.0 | 4 | 105 | 5.44 |
| 6.3 | 470 | Y/7343-40 | T545Y477M006ATE025 | 296.0 | 10 | 25 | 3100.0 | 3 | 105 | 5.44 |
| 6.3 | 470 | X/7343-43 | T545X477M006ATE006 | 296.0 | 10 | 6 | 6700.0 | 3 | 125 | 5.44 |
| 10 | 100 | W/7343-15 | T545W107M010ATE040 | 100.0 | 10 | 40 | 2100.0 | 4 | 105 | 3.60 |
| 10 | 330 | Y/7343-40 | T545Y337M010ATE035 | 330.0 | 10 | 35 | 2600.0 | 3 | 105 | 11.88 |
| 10 | 330 | X/7343-43 | T545X337M010ATE006 | 330.0 | 10 | 6 | 6700.0 | 3 | 125 | 11.88 |
| 16 | 47 | W/7343-15 | T545W476M016ATE045 | 75.0 | 10 | 45 | 2000.0 | 3 | 105 | 3.64 |
| 16 | 220 | X/7343-43 | T545X227M016ATE035 | 352.0 | 10 | 35 | 2700.0 | 3 | 125 | 17.03 |
| 16 | 330 | X/7343-43 | T545X337M016ATE025 | 528.0 | 10 | 25 | 3300.0 | 3 | 125 | 25.55 |
| 16 | 100 | V/7343-20 | T545V107M016ATE055 | 160.0 | 10 | 55 | 1850.0 | 3 | 105 | 7.74 |
| 16 | 100 | D/7343-31 | T545D107M016ATE055 | 160.0 | 10 | 55 | 2050.0 | 3 | 105 | 7.74 |
| V | µF | KEMET/EIA | | (µA) @ V _R , 20°C Maximum/ 5 Minutes | % @ 20°C 120 Hz Maximum | (mΩ) @ 20°C 100 kHz Maximum | (mA) 45°C 100 kHz | Reflow Temperature ≤ 260°C | (°C) | (½CVa²) - (½CVd²) Va = Voltage Applied Vd = Voltage Drop |
| Rated Voltage | Rated Capacitance | Case Code/ Case Size | KEMET Part Number | DC Leakage | DF | ESR | Maximum Allowable Ripple Current | MSL | Rated Temperature | Energy (mJ) |

Derating Guidelines



| Voltage Rating | Maximum Recommended Steady State Voltage | Maximum Recommended Transient Voltage (1 ms – 1 μs) | Maximum Recommended Steady State Voltage | Maximum Recommended Transient Voltage (1 ms – 1 μs) |
|--|--|---|--|---|
| | -55°C to 105°C | | 105°C to 125°C | |
| $6.3 \text{ V} \leq V_R \leq 10 \text{ V}$ | 90% of V_R | V_R | 60% of V_R | V_R |
| $V_R \leq 16 \text{ V}$ | 80% of V_R | V_R | 54% of V_R | V_R |

V_R = Rated Voltage

Ripple Current/Ripple Voltage

Permissible AC ripple voltage and current are related to equivalent series resistance (ESR) and the power dissipation capabilities of the device. Permissible AC ripple voltage which may be applied is limited by two criteria:

1. The positive peak AC voltage plus the DC bias voltage, if any, must not exceed the DC voltage rating of the capacitor.
2. The negative peak AC voltage in combination with bias voltage, if any, must not exceed the allowable limits specified for reverse voltage. See the Reverse Voltage section for allowable limits.

The maximum power dissipation by case size can be determined using the table at right. The maximum power dissipation rating stated in the table must be reduced with increasing environmental operating temperatures. Refer to the table below for temperature compensation requirements.

| Temperature Compensation Multipliers for Maximum Power Dissipation | | |
|---|------------------|------------------|
| ≤ 45°C | 45° C < T ≤ 85°C | 85°C < T ≤ 125°C |
| 1.00 | 0.70 | 0.25 |

T= Environmental Temperature

Using the P max of the device, the maximum allowable rms ripple current or voltage may be determined.

$$I(max) = \sqrt{P_{max}/R}$$

$$E(max) = \sqrt{P_{max} \cdot R}$$

I = rms ripple current (amperes)

E = rms ripple voltage (volts)

P max = maximum power dissipation (watts)

R = ESR at specified frequency (ohms)

| Case Code | EIA Case Code | Maximum Power Dissipation (P max) mWatts @ 45°C with +30°C Rise |
|-----------|---------------|---|
| T | 3528-12 | 105 |
| M | 3528-15 | 120 |
| A | 3216-18 | 112 |
| B | 3528-21 | 127 |
| U | 6032-15 | 135 |
| L | 3528-19 | 150 |
| C | 6032-28 | 165 |
| W | 7343-15 | 180 |
| V | 7343-20 | 187 |
| D | 7343-31 | 225 |
| Y | 7343-40 | 241 |
| X | 7343-43 | 247 |
| H | 7360-20 | 187 |
| I | 3216-10 | 95 |

The maximum power dissipation rating must be reduced with increasing environmental operating temperatures. Refer to the Temperature Compensation Multiplier table for details.

Reverse Voltage

Polymer tantalum capacitors are polar devices and may be permanently damaged or destroyed if connected in the wrong polarity. These devices will withstand a small degree of transient voltage reversal for short periods as shown in the below table.

| Temperature | Permissible Transient Reverse Voltage |
|-------------|---------------------------------------|
| 25°C | 15% of Rated Voltage |
| 55°C | 10% of Rated Voltage |
| 85°C | 5% of Rated Voltage |

Table 2 – Land Dimensions/Courtyard

| KEMET | Metric Size Code | Density Level A: Maximum (Most) Land Protrusion (mm) | | | | | Density Level B: Median (Nominal) Land Protrusion (mm) | | | | | Density Level C: Minimum (Least) Land Protrusion (mm) | | | | | |
|----------------|------------------|--|------|------|------|-------|--|------|------|------|------|---|------|------|------|------|------|
| | | Case | EIA | X | Y | C | V1 | V2 | X | Y | C | V1 | V2 | X | Y | C | V1 |
| D | 7343-31 | | 2.55 | 3.75 | 2.70 | 10.20 | 5.50 | 2.45 | 3.35 | 2.60 | 9.10 | 5.00 | 2.35 | 2.95 | 2.50 | 8.20 | 4.70 |
| H | 7360-20 | | 4.25 | 2.65 | 3.20 | 10.10 | 7.20 | 4.15 | 2.25 | 3.30 | 9.40 | 6.70 | 4.05 | 1.85 | 3.00 | 8.10 | 6.40 |
| V | 7343-20 | | 2.55 | 3.75 | 2.70 | 10.20 | 5.50 | 2.45 | 3.35 | 2.60 | 9.10 | 5.00 | 2.35 | 2.95 | 2.50 | 8.20 | 4.70 |
| W | 7343-15 | | 2.55 | 3.75 | 2.70 | 10.20 | 5.50 | 2.45 | 3.35 | 2.60 | 9.10 | 5.00 | 2.35 | 2.95 | 2.50 | 8.20 | 4.70 |
| X ¹ | 7343-43 | | 2.55 | 3.75 | 2.70 | 10.20 | 5.50 | 2.45 | 3.35 | 2.60 | 9.10 | 5.00 | 2.35 | 2.95 | 2.50 | 8.20 | 4.70 |
| Y ¹ | 7343-40 | | 2.55 | 3.75 | 2.70 | 10.20 | 5.50 | 2.45 | 3.35 | 2.60 | 9.10 | 5.00 | 2.35 | 2.95 | 2.50 | 8.20 | 4.70 |

Density Level A: For low-density product applications. Recommended for wave solder applications and provides a wider process window for reflow solder processes.

Density Level B: For products with a moderate level of component density. Provides a robust solder attachment condition for reflow solder processes.

Density Level C: For high component density product applications. Before adapting the minimum land pattern variations the user should perform qualification testing based on the conditions outlined in IPC Standard 7351 (IPC-7351).

¹ Height of these chips may create problems in wave soldering.



Soldering Process

KEMET's families of surface mount capacitors are compatible with wave (single or dual), convection, IR, or vapor phase reflow techniques. Preheating of these components is recommended to avoid extreme thermal stress. KEMET's recommended profile conditions for convection and IR reflow reflect the profile conditions of the IPC/J-STD-020D standard for moisture sensitivity testing. The devices can safely withstand a maximum of three reflow passes at these conditions.

Please note that although the X/7343-43 case size can withstand wave soldering, the tall profile (4.3 mm maximum) dictates care in wave process development.

Hand soldering should be performed with care due to the difficulty in process control. If performed, care should be taken to avoid contact of the soldering iron to the molded case. The iron should be used to heat the solder pad, applying solder between the pad and the termination, until reflow occurs. Once reflow occurs, the iron should be removed immediately. "Wiping" the edges of a chip and heating the top surface is not recommended.

During typical reflow operations, a slight darkening of the gold-colored epoxy may be observed. This slight darkening is normal and not harmful to the product. Marking permanency is not affected by this change.

| Profile Feature | SnPb Assembly | Pb-Free Assembly |
|---|---------------------|---------------------|
| Preheat/Soak | | |
| Temperature Minimum (T_{smin}) | 100°C | 150°C |
| Temperature Maximum (T_{smax}) | 150°C | 200°C |
| Time (t_s) from T_{smin} to T_{smax} | 60 – 120 seconds | 60 – 120 seconds |
| Ramp-up Rate (T_L to T_P) | 3°C/seconds maximum | 3°C/seconds maximum |
| Liquidous Temperature (T_L) | 183°C | 217°C |
| Time Above Liquidous (t_L) | 60 – 150 seconds | 60 – 150 seconds |
| Peak Temperature (T_P) | 220°C* 235°C** | 250°C* 260°C** |
| Time within 5°C of Maximum Peak Temperature (t_p) | 20 seconds maximum | 30 seconds maximum |
| Ramp-down Rate (T_P to T_L) | 6°C/seconds maximum | 6°C/seconds maximum |
| Time 25°C to Peak Temperature | 6 minutes maximum | 8 minutes maximum |

Note: All temperatures refer to the center of the package, measured on the package body surface that is facing up during assembly reflow.

*Case Size D, E, P, Y, and X

**Case Size A, B, C, H, I, K, M, R, S, T, U, V, W, and Z



Construction



Overview

The KEMET Tantalum Stack Polymer (TSP) Series is designed to provide the highest capacitance/voltage ratings in surface mount configuration. KEMET's T540 Polymer COTS capacitors are utilized in stacks of 2,3,4 and 6 components to achieve a broad range of capacitance and voltage ratings. The T540 COTS series offers component level surge current testing options and standard and low ESR options. As with other KEMET Polymer product, this series may be operated at steady state voltages

up to 90% of rated voltage for part types with rated voltages of \leq 10 volts and up to 80% of rated voltage for part types $>$ 10 volts. Stacking configurations offer this Polymer COTS product with custom capacitance/voltage solutions and very low ESR options.

Note: Custom stacking solutions are available with other KEMET Tantalum Surface Mount Series. Please contact KEMET Product Management for availability.

Benefits

- Polymer cathode technology
- High capacitance
- Surface mountable
- Capacitance values of 66 μ F to 4080 μ F
- Capacitance can be custom specified
- Voltage ratings of 3 VDC to 16 VDC
- High volumetric efficiency
- Ultra low ESR
- Surge capability
- Operating temperature range of -55°C to +125°C
- Laser-marked case
- Use up to 90% of rated voltage for part types \leq 10 volts
- Use up to 80% of rated voltage for part types $>$ 10 volts

Applications

Typical applications include decoupling and filtering in a variety of market segments. The T540 Polymer COTS stack devices can be utilized in military and aerospace applications. Other KEMET series can be utilized in filtering and decoupling applications to service various market segments.



Environmental Compliance

RoHS Compliant (6/6) according to Directive 2002/95/EC when ordered with 100% Sn solder.



RoHS Compliant

SPICE

For a detailed analysis of specific part numbers, please visit www.kemet.com for a free download of KEMET's SPICE software. The KEMET SPICE program is freeware intended to aid design engineers in analyzing the performance of these capacitors over frequency, temperature, ripple, and DC bias conditions.

Ordering Information

| T | SP | 2D | 207 | M | 010 | A | H | 65 | 20 | D540 |
|-----------------|------------------------|--------------------------------|--|-----------------------|---|---------------------|---|---|-------------------------------------|---|
| Capacitor Class | Series | Case Size | Capacitance Code (pF) | Capacitance Tolerance | Voltage | Failure Rate/Design | Lead Material | Surge | ESR | C-Spec 2 |
| T = Tantalum | Stacks Polymer Cathode | 2B, 3B, 4B, 6B, 2D, 3D, 4D, 6D | First two digits represent significant figures. Third digit specifies number of zeros. | M = ±20% | 003 = 3 V 004 = 4 V 006 = 6.3 V 010 = 10 V 016 = 16 V | A = N/A | H = Standard Solder Coated (SnPb 5% Pb minimum) | 65 = No Surge 66 = 10 cycles @ 25°C 67 = 10 cycles -55°C and 85°C | 10 = ESR - Standard 20 = ESR-Low | Designates discrete component series. D540 = T540 |

Note: These TSP Stacks are specific to T540 COTS.

Performance Characteristics

| Item | Performance Characteristics |
|-------------------------|---|
| Operating Temperature | -55°C to 125°C |
| Rated Capacitance Range | 66 – 4080 µF @ 120 Hz/25° C |
| Capacitance Tolerance | M Tolerance (20%) |
| Rated Voltage Range | 3 – 16 V |
| DF (120 Hz) | Refer to Part Number Electrical Specification Table |
| ESR (100 kHz) | Refer to Part Number Electrical Specification Table |
| Leakage Current | ≤ 0.1 CV (mA) at rated voltage after 5 minutes |

Qualification

| Test | Condition | Characteristics | |
|----------------------|--|-----------------|----------------------------------|
| Endurance | 105°C @ rated voltage, 2,000 hours 125°C @ 2/3 rated voltage, 2,000 hours | Δ C/C | Within -20/+10% of initial value |
| | | DF | ≤ initial limit |
| | | DCL | 1.25 x IL @125° C |
| | | ESR | 2 x initial limit |
| Thermal Shock | KEMET specified test, mounted, -55°C to 125° C, 5 cycles | Δ C/C | Within ±5% of initial value |
| | | DF | Within initial limits |
| | | DCL | Within 1.25 x initial limit |
| | | ESR | Within initial limits |
| Surge Voltage | 85° C, 1.15 x rated voltage 1,000 cycles | Δ C/C | Within ±5% of initial value |
| | | DF | Within initial limits |
| | | DCL | Within initial limits |
| | | ESR | Within initial limits |
| Surge Voltage | 125°C, 0.77 x rated voltage 1,000 cycles | Δ C/C | Within ±5% of initial value |
| | | DF | Within initial limits |
| | | DCL | Within initial limits |
| | | ESR | Within initial limits |
| Mechanical Vibration | MIL-STD-202, Method 204, Condition D, 10 Hz to 2,000 Hz, 20 G peak | Δ C/C | Within ±10 of initial value |
| | | DF | Within initial limits |
| | | DCL | Within initial limits |

Dimensions – Millimeters (Inches)

Metric will govern

TSP2

| KEMET 2 Component Stack Dimensions | | | | | | |
|------------------------------------|-----------------------------|----------------------------|-----------------------------|----------------------------|-----------------------------|------------------------------|
| Case Code | L | W | H | W2 | H2 | P |
| 2B | 4.1 ± 0.38 (.162 ± .015) | 3.1 ± 0.2 (.122 ± .008) | 4.3 ± 0.38 (.170 ± .015) | 2.3 ± 0.2 (.090 ± .008) | 3.1 ± 0.38 (.124 ± .015) | 0.76 ± 0.38 (.030 ± .015) |
| 2D | 8.0 ± 0.38 (.315 ± .015) | 4.4 ± 0.2 (.174 ± .008) | 6.2 ± 0.38 (.245 ± .015) | 3.0 ± 0.2 (.120 ± .008) | 4.8 ± 0.38 (.192 ± .015) | 1.9 ± 0.38 (.075 ± .015) |



TSP3

| KEMET 3 Component Stack Dimensions | | | | | | |
|------------------------------------|-----------------------------|----------------------------|-----------------------------|----------------------------|-----------------------------|------------------------------|
| Case Code | L | W | H | W2 | H2 | P |
| 3B | 4.1 ± 0.38 (.162 ± .015) | 3.1 ± 0.2 (.122 ± .008) | 6.3 ± 0.38 (.248 ± .015) | 2.3 ± 0.2 (.090 ± .008) | 5.3 ± 0.38 (.210 ± .015) | 0.76 ± 0.38 (.030 ± .015) |
| 3D | 8.0 ± 0.38 (.315 ± .015) | 4.4 ± 0.2 (.174 ± .008) | 9.2 ± 0.38 (.365 ± .015) | 3.0 ± 0.2 (.120 ± .008) | 7.7 ± 0.38 (.304 ± .015) | 1.9 ± 0.38 (.075 ± .015) |

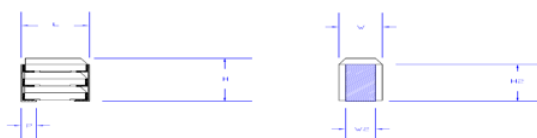

TSP4

| KEMET 4 Component Stack Dimensions | | | | | | |
|------------------------------------|-----------------------------|----------------------------|-----------------------------|----------------------------|-----------------------------|------------------------------|
| Case Code | L | W | H | W2 | H2 | P |
| 4B | 4.1 ± 0.38 (.162 ± .015) | 6.1 ± 0.2 (.242 ± .008) | 4.3 ± 0.38 (.170 ± .015) | 5.3 ± 0.2 (.210 ± .008) | 3.1 ± 0.38 (.124 ± .015) | 0.76 ± 0.38 (.030 ± .015) |
| 4D | 8.0 ± 0.38 (.315 ± .015) | 8.9 ± 0.2 (.350 ± .008) | 6.2 ± 0.38 (.245 ± .015) | 7.4 ± 0.2 (.292 ± .008) | 4.8 ± 0.38 (.192 ± .015) | 1.9 ± 0.38 (.075 ± .015) |

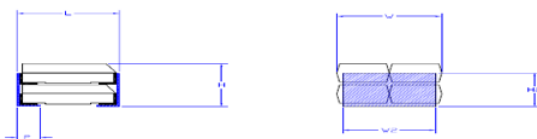

TSP6

| KEMET 6 Component Stack Dimensions | | | | | | |
|------------------------------------|-----------------------------|----------------------------|-----------------------------|----------------------------|-----------------------------|------------------------------|
| Case Code | L | W | H | W2 | H2 | P |
| 6B | 4.1 ± 0.38 (.162 ± .015) | 6.1 ± 0.2 (.242 ± .008) | 6.3 ± 0.38 (.248 ± .015) | 5.3 ± 0.2 (.210 ± .008) | 5.3 ± 0.38 (.210 ± .015) | 0.76 ± 0.38 (.030 ± .015) |
| 6D | 8.0 ± 0.38 (.315 ± .015) | 8.9 ± 0.2 (.350 ± .008) | 9.2 ± 0.38 (.365 ± .015) | 7.4 ± 0.2 (.292 ± .008) | 7.7 ± 0.38 (.304 ± .015) | 1.9 ± 0.38 (.075 ± .015) |



Capacitance and Rated Voltage Chart

| Capacitance | | Rated Voltage | | | | |
|---------------|------|---------------|----|-----|----|----|
| μF | Code | 3 | 4 | 6.3 | 10 | 16 |
| 66 | 666 | | | | 2B | |
| 94 | 946 | | | | | 2D |
| 99 | 996 | | | | 3B | |
| 132 | 137 | | | | 4B | |
| 136 | 137 | | | 2B | | |
| 141 | 147 | | | | | 3D |
| 188 | 197 | | | | | 4D |
| 198 | 207 | | | | 6B | |
| 200 | 207 | | 2B | | 2D | |
| 204 | 207 | | | 3B | | |
| 272 | 277 | | | 4B | | |
| 282 | 287 | | | | | 6D |
| 300 | 307 | | 3B | | 2D | |
| 400 | 407 | | 4B | | 4D | |
| 408 | 407 | | | 6B | | |
| 440 | 447 | | 2D | | 2D | |
| 450 | 457 | 3B | | | | |
| 600 | 607 | 4B | 6B | | | |
| 660 | 667 | 2D | | 2D | 3D | |
| 880 | 887 | | 4D | | 4D | |
| 900 | 907 | 6B | | | 6D | |
| 940 | 947 | | 2D | | | |
| 990 | 997 | | | 3D | | |
| 1320 | 138 | | | 4D | 6D | |
| 1360 | 148 | 2D | | | | |
| 1410 | 148 | | 3D | | | |
| 1880 | 198 | | 4D | | | |
| 1980 | 208 | | | 6D | | |
| 2040 | 208 | 3D | | | | |
| 2720 | 278 | 4D | | | | |
| 2820 | 288 | | 6D | | | |
| 4080 | 418 | 6D | | | | |

Table 1A – TSP2 Ratings & Part Number Reference

| Rated Voltage | Rated Capacitance | Case Code/ Case Size | KEMET Part Number | DC Leakage | DF | Standard ESR | Low ESR |
|---------------|-------------------|-------------------------|------------------------------|-------------------------|-------------------------|-------------------------|-------------------------|
| V | µF | KEMET/EIA | (See below for part options) | µA @ +20°C Max/5 Min | % @ +20°C 120 Hz Max | mΩ +25°C 100 kHz Max | mΩ +25°C 100 kHz Max |
| 4 | 200 | 2B | TSP2B207M004AH(1)(2)D540 | 80 | 8 | 40.0 | N/A |
| 6.3 | 136 | 2B | TSP2B137M006AH(1)(2)D540 | 86 | 8 | 40.0 | N/A |
| 10 | 66 | 2B | TSP2B666M010AH(1)(2)D540 | 66 | 8 | 40.0 | N/A |
| 3 | 660 | 2D | TSP2D667M003AH(1)(2)D540 | 198 | 10 | 12.5 | N/A |
| 3 | 1360 | 2D | TSP2D148M003AH(1)(2)D540 | 408 | 10 | 12.5 | N/A |
| 4 | 440 | 2D | TSP2D447M004AH(1)(2)D540 | 176 | 10 | 12.5 | N/A |
| 4 | 940 | 2D | TSP2D947M004AH(1)(2)D540 | 376 | 10 | 20 | 12.5 |
| 6.3 | 660 | 2D | TSP2D667M006AH(1)(2)D540 | 416 | 10 | 20 | 12.5 |
| 10 | 200 | 2D | TSP2D207M010AH(1)(2)D540 | 200 | 10 | 27.5 | 12.5 |
| 10 | 300 | 2D | TSP2D307M010AH(1)(2)D540 | 300 | 10 | 27.5 | 12.5 |
| 10 | 440 | 2D | TSP2D447M010AH(1)(2)D540 | 440 | 10 | 12.5 | N/A |
| 16 | 94 | 2D | TSP2D946M016AH(1)(2)D540 | 152 | 10 | 32.5 | 17.5 |
| V | µF | KEMET/EIA | (See below for part options) | µA @ +20°C Max/5 Min | % @ +20°C 120 Hz Max | mΩ +25°C 100 kHz Max | mΩ +25°C 100 kHz Max |
| Rated Voltage | Rated Capacitance | Case Code/ Case Size | KEMET Part Number | DC Leakage | DF | Standard ESR | Low ESR |

Table 1B – TSP3 Ratings & Part Number Reference

| Rated Voltage | Rated Capacitance | Case Code/ Case Size | KEMET Part Number | DC Leakage | DF | Standard ESR | Low ESR |
|---------------|-------------------|-------------------------|------------------------------|-------------------------|-------------------------|-------------------------|-------------------------|
| V | µF | KEMET/EIA | (See below for part options) | µA @ +20°C Max/5 Min | % @ +20°C 120 Hz Max | mΩ +25°C 100 kHz Max | mΩ +25°C 100 kHz Max |
| 3 | 450 | 3B | TSP3B457M003AH(1)(2)D540 | 135 | 8 | 26.7 | N/A |
| 4 | 300 | 3B | TSP3B307M004AH(1)(2)D540 | 120 | 8 | 26.7 | N/A |
| 6.3 | 204 | 3B | TSP3B207M006AH(1)(2)D540 | 129 | 8 | 26.7 | N/A |
| 10 | 99 | 3B | TSP3B996M010AH(1)(2)D540 | 99 | 8 | 26.7 | N/A |
| 3 | 2040 | 3D | TSP3D208M003AH(1)(2)D540 | 612 | 10 | 8.3 | N/A |
| 4 | 1410 | 3D | TSP3D148M004AH(1)(2)D540 | 564 | 10 | 13.3 | 8.3 |
| 6.3 | 990 | 3D | TSP3D997M006AH(1)(2)D540 | 624 | 10 | 13.3 | 8.3 |
| 10 | 660 | 3D | TSP3D667M010AH(1)(2)D540 | 660 | 10 | 8.3 | N/A |
| 16 | 141 | 3D | TSP3D147M016AH(1)(2)D540 | 226 | 10 | 21.7 | 11.7 |
| V | µF | KEMET/EIA | (See below for part options) | µA @ +20°C Max/5 Min | % @ +20°C 120 Hz Max | mΩ +25°C 100 kHz Max | mΩ +25°C 100 kHz Max |
| Rated Voltage | Rated Capacitance | Case Code/ Case Size | KEMET Part Number | DC Leakage | DF | Standard ESR | Low ESR |

(1) To complete KEMET part number, insert 65 = None, 66 = 10 cycles +25°C, 67 = 10 cycles -55°C +85°C. Designates surge current option.

(2) To complete KEMET part number, insert 10 = Standard ESR, 20 = Low ESR. Designates ESR option.

Refer to Ordering Information for additional detail.

Table 1C – TSP4 Ratings & Part Number Reference

| Rated Voltage | Rated Capacitance | Case Code/ Case Size | KEMET Part Number | DC Leakage | DF | Standard ESR | Low ESR |
|---------------|-------------------|-------------------------|------------------------------|-------------------------|-------------------------|-------------------------|-------------------------|
| V | μF | KEMET/EIA | (See below for part options) | μA @ +20°C Max/5 Min | % @ +20°C 120 Hz Max | mΩ +25°C 100 kHz Max | mΩ +25°C 100 kHz Max |
| 3 | 600 | 4B | TSP4B607M003AH(1)(2)D540 | 180 | 8 | 20.0 | N/A |
| 4 | 400 | 4B | TSP4B407M004AH(1)(2)D540 | 160 | 8 | 20.0 | N/A |
| 6.3 | 272 | 4B | TSP4B277M006AH(1)(2)D540 | 172 | 8 | 20.0 | N/A |
| 10 | 132 | 4B | TSP4B137M010AH(1)(2)D540 | 132 | 8 | 20.0 | N/A |
| 3 | 2720 | 4D | TSP4D278M003AH(1)(2)D540 | 816 | 10 | 6.25 | N/A |
| 4 | 880 | 4D | TSP4D887M004AH(1)(2)D540 | 352 | 10 | 6.25 | N/A |
| 4 | 1880 | 4D | TSP4D198M004AH(1)(2)D540 | 752 | 10 | 10 | 6.25 |
| 6.3 | 1320 | 4D | TSP4D138M006AH(1)(2)D540 | 832 | 10 | 10 | 6.25 |
| 10 | 400 | 4D | TSP4D407M010AH(1)(2)D540 | 400 | 10 | 13.75 | 6.25 |
| 10 | 880 | 4D | TSP4D887M010AH(1)(2)D540 | 880 | 10 | 6.25 | N/A |
| 16 | 188 | 4D | TSP4D197M016AH(1)(2)D540 | 301 | 10 | 16.25 | 8.75 |
| V | μF | KEMET/EIA | (See below for part options) | μA @ +20°C Max/5 Min | % @ +20°C 120 Hz Max | mΩ +25°C 100 kHz Max | mΩ +25°C 100 kHz Max |
| Rated Voltage | Rated Capacitance | Case Code/ Case Size | KEMET Part Number | DC Leakage | DF | Standard ESR | Low ESR |

Table 1D – TSP6 Ratings & Part Number Reference

| Rated Voltage | Rated Capacitance | Case Code/ Case Size | KEMET Part Number | DC Leakage | DF | Standard ESR | Low ESR |
|---------------|-------------------|-------------------------|------------------------------|-------------------------|-------------------------|-------------------------|-------------------------|
| V | μF | KEMET/EIA | (See below for part options) | μA @ +20°C Max/5 Min | % @ +20°C 120 Hz Max | mΩ +25°C 100 kHz Max | mΩ +25°C 100 kHz Max |
| 3 | 900 | 6B | TSP6B907M003AH(1)(2)D540 | 270 | 8 | 13.3 | N/A |
| 4 | 600 | 6B | TSP6B607M004AH(1)(2)D540 | 240 | 8 | 13.3 | N/A |
| 6.3 | 408 | 6B | TSP6B407M006AH(1)(2)D540 | 258 | 8 | 13.3 | N/A |
| 10 | 198 | 6B | TSP6B207M010AH(1)(2)D540 | 198 | 8 | 13.3 | N/A |
| 3 | 4080 | 6D | TSP6D418M003AH(1)(2)D540 | 1224 | 10 | 4.2 | N/A |
| 4 | 2820 | 6D | TSP6D288M004AH(1)(2)D540 | 1128 | 10 | 6.7 | 4.2 |
| 6.3 | 1980 | 6D | TSP6D208M006AH(1)(2)D540 | 1248 | 10 | 6.7 | 4.2 |
| 10 | 900 | 6D | TSP6D907M010AH(1)(2)D540 | 900 | 10 | 9.2 | 4.2 |
| 10 | 1320 | 6D | TSP6D138M010AH(1)(2)D540 | 1320 | 10 | 4.2 | N/A |
| 16 | 282 | 6D | TSP6D287M016AH(1)(2)D540 | 452 | 10 | 10.8 | 5.8 |
| V | μF | KEMET/EIA | (See below for part options) | μA @ +20°C Max/5 Min | % @ +20°C 120 Hz Max | mΩ +25°C 100 kHz Max | mΩ +25°C 100 kHz Max |
| Rated Voltage | Rated Capacitance | Case Code/ Case Size | KEMET Part Number | DC Leakage | DF | Standard ESR | Low ESR |

(1) To complete KEMET part number, insert 65 = None, 66 = 10 cycles +25°C, 67 = 10 cycles -55°C +85°C. Designates surge current option.

(2) To complete KEMET part number, insert 10 = Standard ESR, 20 = Low ESR. Designates ESR option.

Refer to Ordering Information for additional detail.

Derating Guidelines

| Voltage Rating | Maximum Recommended Steady State Voltage | Maximum Recommended Transient Voltage (1 ms – 1 μ s) |
|-----------------|--|--|
| -55°C to 105°C | | |
| $10 V \leq V_R$ | 90% of V_R | V_R |
| $V_R > 10$ | 80% of V_R | V_R |

V_R = Rated Voltage



Reverse Voltage

Solid tantalum capacitors are polar devices and may be permanently damaged or destroyed if connected with the wrong polarity. The positive terminal is identified on the capacitor body by a stripe plus in some cases a beveled edge. A small degree of transient reverse voltage is permissible for short periods per the table. The capacitors should not be operated continuously in reverse mode, even within these limits.

| Temperature | Permissible Transient Reverse Voltage |
|-------------|---------------------------------------|
| 25°C | 15% of Rated Voltage |
| 85°C | 5% of Rated Voltage |
| 125°C | 1% of Rated Voltage |

Soldering Process

KEMET’s families of surface mount capacitors are compatible with wave (single or dual), convection, IR, or vapor phase reflow techniques. Preheating of these components is recommended to avoid extreme thermal stress. KEMET’s recommended profile conditions for convection and IR reflow reflect the profile conditions of the IPC/J–STD–020D standard for moisture sensitivity testing. The devices can safely withstand a maximum of three reflow passes at these conditions.

Please note that although the X/7343–43 case size can withstand wave soldering, the tall profile (4.3 mm maximum) dictates care in wave process development.

Hand soldering should be performed with care due to the difficulty in process control. If performed, care should be taken to avoid contact of the soldering iron to the molded case. The iron should be used to heat the solder pad, applying solder between the pad and the termination, until reflow occurs. Once reflow occurs, the iron should be removed immediately. “Wiping” the edges of a chip and heating the top surface is not recommended.

During typical reflow operations, a slight darkening of the gold-colored epoxy may be observed. This slight darkening is normal and not harmful to the product. Marking permanency is not affected by this change.

| Profile Feature | SnPb Assembly | Pb-Free Assembly |
|---|---------------------|---------------------|
| Preheat/Soak | | |
| Temperature Minimum (T_{smin}) | 100°C | 150°C |
| Temperature Maximum (T_{smax}) | 150°C | 200°C |
| Time (t_s) from T_{smin} to T_{smax} | 60 – 120 seconds | 60 – 120 seconds |
| Ramp-up Rate (T_L to T_p) | 3°C/seconds maximum | 3°C/seconds maximum |
| Liquidous Temperature (T_L) | 183°C | 217°C |
| Time Above Liquidous (t_L) | 60 – 150 seconds | 60 – 150 seconds |
| Peak Temperature (T_p) | 220°C* 235°C** | 250°C* 260°C** |
| Time within 5°C of Maximum Peak Temperature (t_p) | 20 seconds maximum | 30 seconds maximum |
| Ramp-down Rate (T_p to T_L) | 6°C/seconds maximum | 6°C/seconds maximum |
| Time 25°C to Peak Temperature | 6 minutes maximum | 8 minutes maximum |

Note: All temperatures refer to the center of the package, measured on the package body surface that is facing up during assembly reflow.

*Case Size D, E, P, Y, and X

**Case Size A, B, C, H, I, K, M, R, S, T, U, V, W, and Z



Construction

| Reference | Name | Material |
|-----------|------------------|-------------------------|
| A | Leadframe | BeCu Alloy 190 |
| B | Leadframe Attach | High Temp Solder |
| C | Lead Termination | Solder Coated Alloy 752 |



Storage and Handling

Tantalum chip capacitors should be stored in normal working environments. While the chips themselves are quite robust in other environments, solderability will be degraded by exposure to high temperatures, high humidity, corrosive atmospheres, and long term storage. In addition, packaging materials will be degraded by high temperature– reels may soften or warp and tape peel force may increase. KEMET recommends that maximum storage temperature not exceed 40°C and maximum storage humidity not exceed 70% relative humidity. Temperature fluctuations should be minimized to avoid condensation on the parts and atmospheres should be free of chlorine and sulfur bearing compounds. For optimized solderability chip stock should be used promptly, preferably within 1.5 years of receipt.

Packaging

- Tantalum Stacks Packaging EIA-451 Packaging Material Standards for ESD Sensitive Items
- Antistatic Plastic Trays
- Polyurethane Polyether Foam



Overview

The KEMET Aluminum Organic Capacitor (AO-CAP) is a solid state aluminum capacitor with an aluminum oxide dielectric and conductive polymer cathode. The use of the conductive polymer cathode results in very low ESR and improved capacitance retention at high frequency. AO-CAP's may be operated at steady state voltages up to 100% of rated voltage (no derating) with equivalent or better reliability than tantalum capacitors operating at the recommended derated voltage.

The A700 Series AO-CAP offers the same advantages as the

polymer tantalum capacitors but also has the added advantages of 125°C performance capability, higher ripple current handling capability and a lower ESR range. Packaged with multiple anodes/elements to reduce the depth that the signal must penetrate, this parallel arrangement reduces the ESR further still to achieve lower ESR than other types of surface mount capacitors with similar capacitance ranges. With reduced ESR, the enhanced capacitance retention at higher frequencies provides the lowest total capacitance and an economical solution for power applications.

Benefits

- ESR: 6 mΩ to 70 mΩ
- Voltage: 2 V to 16 V
- Capacitance: 6.8 μF to 470 μF
- Operating Temperature: -55°C to 125°C
- Polymer cathode technology
- High frequency capacitance retention
- Non-ignition failure mode
- 100% accelerated steady state aging
- 100% surge current tested
- Volumetric efficiency
- Self-healing mechanism
- EIA standard case sizes

Applications

Typical applications include DC/DC converters, notebook PCs, telecommunications, displays, and industrial applications.



Environmental Compliance

RoHS Compliant (6/6) according to Directive 2002/95/EC when ordered with 100% Sn solder.



RoHS Compliant

SPICE

For a detailed analysis of specific part numbers, please visit www.kemet.com for a free download of KEMET's SPICE software. The KEMET SPICE program is freeware intended to aid design engineers in analyzing the performance of these capacitors over frequency, temperature, ripple, and DC bias conditions.

Ordering Information

| A | 700 | V | 476 | M | 006 | A | T | E018 | |
|-----------------|------------------------|------------|--|-----------------------|---|---------------------|--------------------------------|--|------------------------------------|
| Capacitor Class | Series | Case Size | Capacitance Code (pF) | Capacitance Tolerance | Voltage | Failure Rate/Design | Lead Material | ESR Code | Packaging (C-Spec) |
| A = Aluminum | 700 = Aluminum Polymer | D, V, W, X | First two digits represent significant figures. Third digit specifies number of zeros. | M = ±20% | 002 = 2 V 2R5 = 2.5 V 004 = 4 V 006 = 6.3 V 008 = 8 V 010 = 10 V 12R = 12.5 V 016 = 16 V | A = N/A | T = 100% Matte Tin (Sn) Plated | E = ESR Last three digits specify ESR in mΩ (018 = 18 mΩ) | Blank = 7" Reel 7280 = 13" Reel |

Performance Characteristics

| Item | Performance Characteristics |
|-------------------------|--|
| Operating Temperature | -55°C to 125°C |
| Rated Capacitance Range | 6.8 – 470 μF @ 120 Hz/25°C |
| Capacitance Tolerance | M Tolerance (20%) |
| Rated Voltage Range | 2 – 16 V |
| DF (120 Hz) | 6% |
| ESR (100 kHz) | Refer to Part Number Electrical Specification Table |
| Leakage Current | ≤ 4 V Rating: ≤ 0.06 CV (μA) at rated voltage after 5 minutes > 4 V Rating: ≤ 0.04 CV (μA) at rated voltage after 5 minutes |

Qualification

| Test | Condition | Characteristics | | | | |
|----------------------------|--|-----------------|----------------------------------|---------|----------|----------|
| Endurance | 125°C @ rated voltage, 2,000 hours | Δ C/C | Within ±10% of initial value | | | |
| | | DF | ≤ initial limit | | | |
| | | DCL | Within 1.25 x initial limit | | | |
| | | ESR | Within 2.0 x initial limit | | | |
| Storage Life | 125°C @ 0 volts, 2,000 hours | Δ C/C | Within ±10% of initial value | | | |
| | | DF | Within initial limits | | | |
| | | DCL | Within 1.25 x initial limit | | | |
| | | ESR | Within 2.0 x initial limit | | | |
| Humidity | 60°C, 90% RH, 1,000 hours, rated voltage 60°C, 90% RH, 500 hours, No Load | Δ C/C | Within -5%/+30% of initial value | | | |
| | | DF | ≤ initial limit | | | |
| | | DCL | Within 5.0 x initial limit | | | |
| Temperature Stability | Extreme temperature exposure at a succession of continuous steps at +25°C, -55°C, +25°C, +85°C, +125°C, +25°C | +25°C | -55°C | +85°C | +125°C | |
| | | Δ C/C | IL* | ±15% | ±15% | ±20% |
| | | DF | IL | IL | 1.2 x IL | 1.5 x IL |
| DCL | | IL | n/a | 10 x IL | 10 x IL | |
| | | Δ C/C | Within ±10% of initial value | | | |
| | | DF | Within initial limits | | | |
| Surge Voltage | 125°C, 1.32 x rated voltage, 33 W Resistance, 1,000 cycles | DCL | Within initial limits | | | |
| | | ESR | Within initial limits | | | |
| | | Δ C/C | Within ±10% of initial value | | | |
| Mechanical Shock/Vibration | MIL-STD-202, Method 213, Condition I, 100 G peak MIL-STD-202, Method 204, Condition D, 10 Hz to 2,000 Hz, 20 G peak | DF | Within initial limits | | | |
| | | DCL | Within initial limits | | | |
| | | Δ C/C | Within ±10% of initial value | | | |

*IL = Initial Limit

Electrical Characteristics

ESR vs. Frequency



Capacitance vs. Frequency

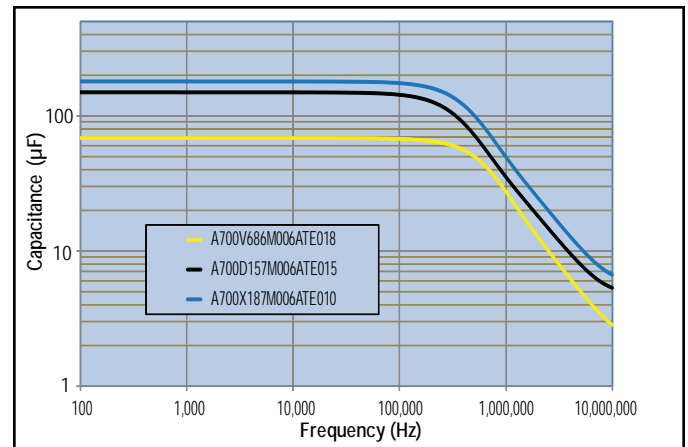

Dimensions – Millimeters (Inches)

Metric will govern



| Case Size | | Component | | | | |
|-----------|---------|----------------------------|----------------------------|----------------------------|--------------------|--------------------|
| KEMET | EIA | L* | W* | H* | F* ±0.1 ±(.004) | S* ±0.3 ±(.012) |
| D | 7343-31 | 7.3 ±0.3 (0.287 ±0.012) | 4.3 ±0.3 (0.169 ±0.012) | 2.8 ±0.3 (0.098 ±0.012) | 2.4 (.094) | 1.3 (.051) |
| V | 7343-20 | 7.3 ±0.3 (0.287 ±0.012) | 4.3 ±0.3 (0.169 ±0.012) | 2.0 (0.079) Maximum | 2.4 (.094) | 1.3 (.051) |
| W | 7343-15 | 7.3 ±0.3 (0.287 ±0.012) | 4.3 ±0.3 (0.169 ±0.012) | 1.5 (0.059) Maximum | 2.4 (.094) | 1.3 (.051) |
| X | 7343-43 | 7.3 ±0.3 (0.287 ±0.012) | 4.3 ±0.3 (0.169 ±0.012) | 4.0 ±0.3 (0.157 ±0.012) | 2.4 (.094) | 1.3 (.051) |

Table 1 – Ratings & Part Number Reference

| Rated Voltage | Rated Cap | Case Code/ Case Size | KEMET Part Number | DC Leakage | DF | ESR | Ripple Current | Moisture Sensitivity | Rated Temp |
|---------------|-----------|-------------------------|------------------------------|------------------------------------|--------------------------------|---------------------------------|--|----------------------------------|------------|
| VDC | µF | KEMET/EIA | (See below for part options) | µA @ +20°C Maximum/5 Minutes | % @ +20°C 120 Hz Maximum | mΩ @ 20°C 100 kHz Maximum | (mA) @ 100 kHz with/T = +20°C @ -55°C to 125°C | Reflow Temperature ≤ 260°C | (°C) |
| 2 | 100 | W/7343-15 | A700W107M002ATE009 | 12 | 6 | 9 | 5300 | 3 | 125 |
| 2 | 100 | W/7343-15 | A700W107M002ATE016 | 12 | 6 | 16 | 4000 | 3 | 125 |
| 2 | 100 | V/7343-20 | A700V107M002ATE018 | 12 | 6 | 18 | 3900 | 3 | 125 |
| 2 | 100 | V/7343-20 | A700V107M002ATE025 | 12 | 6 | 25 | 3300 | 3 | 125 |
| 2 | 100 | V/7343-20 | A700V107M002ATE028 | 12 | 6 | 28 | 3100 | 3 | 125 |
| 2 | 120 | V/7343-20 | A700V127M002ATE018 | 14 | 6 | 18 | 3900 | 3 | 125 |
| 2 | 120 | V/7343-20 | A700V127M002ATE025 | 14 | 6 | 25 | 3300 | 3 | 125 |
| 2 | 120 | V/7343-20 | A700V127M002ATE028 | 14 | 6 | 28 | 3100 | 3 | 125 |
| 2 | 150 | V/7343-20 | A700V157M002ATE009 | 18 | 6 | 9 | 5500 | 3 | 125 |
| 2 | 150 | V/7343-20 | A700V157M002ATE015 | 18 | 6 | 15 | 4200 | 3 | 125 |
| 2 | 150 | V/7343-20 | A700V157M002ATE018 | 18 | 6 | 18 | 3900 | 3 | 125 |
| 2 | 150 | V/7343-20 | A700V157M002ATE025 | 18 | 6 | 25 | 3300 | 3 | 125 |
| 2 | 150 | V/7343-20 | A700V157M002ATE028 | 18 | 6 | 28 | 3100 | 3 | 125 |
| 2 | 180 | D/7343-31 | A700D187M002ATE015 | 22 | 6 | 15 | 4100 | 3 | 125 |
| 2 | 180 | D/7343-31 | A700D187M002ATE018 | 22 | 6 | 18 | 3700 | 3 | 125 |
| 2 | 220 | V/7343-20 | A700V227M002ATE009 | 26 | 6 | 9 | 5500 | 3 | 125 |
| 2 | 220 | V/7343-20 | A700V227M002ATE015 | 26 | 6 | 15 | 4200 | 3 | 125 |
| 2 | 220 | V/7343-20 | A700V227M002ATE018 | 26 | 6 | 18 | 3900 | 3 | 125 |
| 2 | 220 | D/7343-31 | A700D227M002ATE009 | 26 | 6 | 9 | 5300 | 3 | 125 |
| 2 | 220 | D/7343-31 | A700D227M002ATE015 | 26 | 6 | 15 | 4100 | 3 | 125 |
| 2 | 220 | D/7343-31 | A700D227M002ATE018 | 26 | 6 | 18 | 3700 | 3 | 125 |
| 2 | 270 | D/7343-31 | A700D277M002ATE012 | 32 | 6 | 12 | 4600 | 3 | 125 |
| 2 | 270 | X/7343-43 | A700X277M002ATE010 | 32 | 6 | 10 | 4700 | 3 | 125 |
| 2 | 270 | X/7343-43 | A700X277M002ATE012 | 32 | 6 | 12 | 4300 | 3 | 125 |
| 2 | 270 | X/7343-43 | A700X277M002ATE015 | 32 | 6 | 15 | 3900 | 3 | 125 |
| 2 | 330 | V/7343-20 | A700V337M002ATE009 | 40 | 6 | 9 | 5500 | 3 | 125 |
| 2 | 330 | D/7343-31 | A700D337M002ATE006 | 40 | 6 | 6 | 6500 | 3 | 125 |
| 2 | 330 | D/7343-31 | A700D337M002ATE007 | 40 | 6 | 7 | 6000 | 3 | 125 |
| 2 | 330 | D/7343-31 | A700D337M002ATE009 | 40 | 6 | 9 | 5300 | 3 | 125 |
| 2 | 330 | D/7343-31 | A700D337M002ATE012 | 40 | 6 | 12 | 4600 | 3 | 125 |
| 2 | 330 | X/7343-43 | A700X337M002ATE010 | 40 | 6 | 10 | 4700 | 3 | 125 |
| 2 | 330 | X/7343-43 | A700X337M002ATE015 | 40 | 6 | 15 | 3900 | 3 | 125 |
| 2 | 390 | X/7343-43 | A700X397M002ATE010 | 47 | 6 | 10 | 4700 | 3 | 125 |
| 2 | 390 | X/7343-43 | A700X397M002ATE015 | 47 | 6 | 15 | 3900 | 3 | 125 |
| 2 | 470 | D/7343-31 | A700D477M002ATE005 | 56 | 6 | 5 | 7100 | 3 | 125 |
| 2 | 470 | X/7343-43 | A700X477M002ATE007 | 56 | 6 | 7 | 5700 | 3 | 125 |
| 2 | 470 | X/7343-43 | A700X477M002ATE010 | 56 | 6 | 10 | 4700 | 3 | 125 |
| 2 | 470 | X/7343-43 | A700X477M002ATE015 | 56 | 6 | 15 | 3900 | 3 | 125 |
| 2 | 560 | X/7343-43 | A700X567M002ATE005 | 67 | 6 | 5 | 6700 | 3 | 125 |
| 2.5 | 82 | V/7343-20 | A700V826M2R5ATE018 | 12 | 6 | 18 | 3900 | 3 | 125 |
| 2.5 | 82 | V/7343-20 | A700V826M2R5ATE025 | 12 | 6 | 25 | 3300 | 3 | 125 |
| 2.5 | 82 | V/7343-20 | A700V826M2R5ATE028 | 12 | 6 | 28 | 3100 | 3 | 125 |
| 2.5 | 150 | D/7343-31 | A700D157M2R5ATE015 | 23 | 6 | 15 | 4100 | 3 | 125 |
| 2.5 | 150 | D/7343-31 | A700D157M2R5ATE018 | 23 | 6 | 18 | 3700 | 3 | 125 |
| 2.5 | 180 | D/7343-31 | A700D187M2R5ATE015 | 27 | 6 | 15 | 4100 | 3 | 125 |
| 2.5 | 180 | D/7343-31 | A700D187M2R5ATE018 | 27 | 6 | 18 | 3700 | 3 | 125 |
| 2.5 | 220 | X/7343-43 | A700X227M2R5ATE010 | 33 | 6 | 10 | 4700 | 3 | 125 |
| 2.5 | 220 | X/7343-43 | A700X227M2R5ATE015 | 33 | 6 | 15 | 3900 | 3 | 125 |
| 2.5 | 330 | X/7343-43 | A700X337M2R5ATE010 | 50 | 6 | 10 | 4700 | 3 | 125 |
| 2.5 | 330 | X/7343-43 | A700X337M2R5ATE015 | 50 | 6 | 15 | 3900 | 3 | 125 |
| 4 | 68 | V/7343-20 | A700V686M004ATE020 | 16 | 6 | 20 | 3700 | 3 | 125 |
| VDC | µF | KEMET/EIA | (See below for part options) | µA @ +20°C Maximum/5 Minutes | % @ +20°C 120 Hz Maximum | mΩ @ 20°C 100 kHz Maximum | (mA) @ 100 kHz with/T = +20°C @ -55°C to 125°C | Reflow Temperature ≤ 260°C | (°C) |
| Rated Voltage | Rated Cap | Case Code/ Case Size | KEMET Part Number | DC Leakage | DF | ESR | Ripple Current | Moisture Sensitivity | Rated Temp |

Other part number options:

Also available on large (13 inch) reels. Add 7280 to the end of the part number.

Higher voltage ratings and tighter tolerance product including ESR may be substituted within the same size at KEMET's option. Voltage substitutions will be marked with the higher voltage rating. Substitutions can include better than series.

Table 1 – Ratings & Part Number Reference cont'd

| Rated Voltage | Rated Cap | Case Code/ Case Size | KEMET Part Number | DC Leakage | DF | ESR | Ripple Current | Moisture Sensitivity | Rated Temp |
|---------------|-----------|-------------------------|------------------------------|------------------------------------|--------------------------------|---------------------------------|--|----------------------------------|------------|
| VDC | µF | KEMET/EIA | (See below for part options) | µA @ +20°C Maximum/5 Minutes | % @ +20°C 120 Hz Maximum | mΩ @ 20°C 100 kHz Maximum | (mA) @ 100 kHz with/T = +20°C @ -55°C to 125°C | Reflow Temperature ≤ 260°C | (°C) |
| 4 | 68 | V/7343-20 | A700V686M004ATE028 | 16 | 6 | 28 | 3100 | 3 | 125 |
| 4 | 82 | V/7343-20 | A700V826M004ATE025 | 20 | 6 | 25 | 3300 | 3 | 125 |
| 4 | 82 | V/7343-20 | A700V826M004ATE028 | 20 | 6 | 28 | 3100 | 3 | 125 |
| 4 | 120 | D/7343-31 | A700D127M004ATE015 | 29 | 6 | 15 | 4100 | 3 | 125 |
| 4 | 120 | D/7343-31 | A700D127M004ATE018 | 29 | 6 | 18 | 3700 | 3 | 125 |
| 4 | 150 | D/7343-31 | A700D157M004ATE015 | 36 | 6 | 15 | 4100 | 3 | 125 |
| 4 | 150 | D/7343-31 | A700D157M004ATE018 | 36 | 6 | 18 | 3700 | 3 | 125 |
| 4 | 180 | D/7343-31 | A700D187M004ATE015 | 43 | 6 | 15 | 4100 | 3 | 125 |
| 4 | 180 | D/7343-31 | A700D187M004ATE018 | 43 | 6 | 18 | 3700 | 3 | 125 |
| 4 | 180 | X/7343-43 | A700X187M004ATE010 | 43 | 6 | 10 | 4700 | 3 | 125 |
| 4 | 180 | X/7343-43 | A700X187M004ATE015 | 43 | 6 | 15 | 3900 | 3 | 125 |
| 4 | 180 | X/7343-43 | A700X187M004ATE018 | 43 | 6 | 18 | 3500 | 3 | 125 |
| 4 | 220 | D/7343-31 | A700D227M004ATE009 | 53 | 6 | 9 | 5300 | 3 | 125 |
| 4 | 220 | D/7343-31 | A700D227M004ATE010 | 53 | 6 | 10 | 5000 | 3 | 125 |
| 4 | 220 | D/7343-31 | A700D227M004ATE015 | 53 | 6 | 15 | 4100 | 3 | 125 |
| 4 | 220 | X/7343-43 | A700X227M004ATE010 | 53 | 6 | 10 | 4700 | 3 | 125 |
| 4 | 220 | X/7343-43 | A700X227M004ATE015 | 53 | 6 | 15 | 3900 | 3 | 125 |
| 4 | 270 | X/7343-43 | A700X277M004ATE010 | 65 | 6 | 10 | 4700 | 3 | 125 |
| 4 | 270 | X/7343-43 | A700X277M004ATE015 | 65 | 6 | 15 | 3900 | 3 | 125 |
| 4 | 330 | X/7343-43 | A700X337M004ATE010 | 79 | 6 | 10 | 4700 | 3 | 125 |
| 4 | 330 | X/7343-43 | A700X337M004ATE015 | 79 | 6 | 15 | 3900 | 3 | 125 |
| 6.3 | 10 | V/7343-20 | A700V106M006ATE055 | 3 | 6 | 55 | 2200 | 3 | 125 |
| 6.3 | 22 | V/7343-20 | A700V226M006ATE028 | 6 | 6 | 28 | 3100 | 3 | 125 |
| 6.3 | 22 | V/7343-20 | A700V226M006ATE045 | 6 | 6 | 45 | 2400 | 3 | 125 |
| 6.3 | 33 | V/7343-20 | A700V336M006ATE018 | 8 | 6 | 18 | 3900 | 3 | 125 |
| 6.3 | 33 | V/7343-20 | A700V336M006ATE025 | 8 | 6 | 25 | 3300 | 3 | 125 |
| 6.3 | 33 | V/7343-20 | A700V336M006ATE028 | 8 | 6 | 28 | 3100 | 3 | 125 |
| 6.3 | 47 | V/7343-20 | A700V476M006ATE018 | 12 | 6 | 18 | 3900 | 3 | 125 |
| 6.3 | 47 | V/7343-20 | A700V476M006ATE025 | 12 | 6 | 25 | 3300 | 3 | 125 |
| 6.3 | 47 | V/7343-20 | A700V476M006ATE028 | 12 | 6 | 28 | 3100 | 3 | 125 |
| 6.3 | 56 | V/7343-20 | A700V566M006ATE018 | 14 | 6 | 18 | 3900 | 3 | 125 |
| 6.3 | 56 | V/7343-20 | A700V566M006ATE025 | 14 | 6 | 25 | 3300 | 3 | 125 |
| 6.3 | 56 | V/7343-20 | A700V566M006ATE028 | 14 | 6 | 28 | 3100 | 3 | 125 |
| 6.3 | 68 | V/7343-20 | A700V686M006ATE018 | 17 | 6 | 18 | 3900 | 3 | 125 |
| 6.3 | 68 | V/7343-20 | A700V686M006ATE025 | 17 | 6 | 25 | 3300 | 3 | 125 |
| 6.3 | 68 | V/7343-20 | A700V686M006ATE028 | 17 | 6 | 28 | 3100 | 3 | 125 |
| 6.3 | 82 | V/7343-20 | A700V826M006ATE018 | 21 | 6 | 18 | 3900 | 3 | 125 |
| 6.3 | 82 | V/7343-20 | A700V826M006ATE025 | 21 | 6 | 25 | 3300 | 3 | 125 |
| 6.3 | 82 | V/7343-20 | A700V826M006ATE028 | 21 | 6 | 28 | 3100 | 3 | 125 |
| 6.3 | 100 | V/7343-20 | A700V107M006ATE015 | 25 | 6 | 15 | 4200 | 3 | 125 |
| 6.3 | 100 | V/7343-20 | A700V107M006ATE018 | 25 | 6 | 18 | 3900 | 3 | 125 |
| 6.3 | 100 | V/7343-20 | A700V107M006ATE025 | 25 | 6 | 25 | 3300 | 3 | 125 |
| 6.3 | 100 | D/7343-31 | A700D107M006ATE015 | 25 | 6 | 15 | 4100 | 3 | 125 |
| 6.3 | 100 | D/7343-31 | A700D107M006ATE018 | 25 | 6 | 18 | 3700 | 3 | 125 |
| 6.3 | 120 | D/7343-31 | A700D127M006ATE012 | 30 | 6 | 12 | 4600 | 3 | 125 |
| 6.3 | 120 | D/7343-31 | A700D127M006ATE015 | 30 | 6 | 15 | 4100 | 3 | 125 |
| 6.3 | 120 | D/7343-31 | A700D127M006ATE018 | 30 | 6 | 18 | 3700 | 3 | 125 |
| 6.3 | 150 | D/7343-31 | A700D157M006ATE010 | 38 | 6 | 10 | 5000 | 3 | 125 |
| 6.3 | 150 | D/7343-31 | A700D157M006ATE012 | 38 | 6 | 12 | 4600 | 3 | 125 |
| 6.3 | 150 | D/7343-31 | A700D157M006ATE015 | 38 | 6 | 15 | 4100 | 3 | 125 |
| 6.3 | 150 | X/7343-43 | A700X157M006ATE010 | 38 | 6 | 10 | 4700 | 3 | 125 |
| 6.3 | 150 | X/7343-43 | A700X157M006ATE012 | 38 | 6 | 12 | 4300 | 3 | 125 |
| VDC | µF | KEMET/EIA | (See below for part options) | µA @ +20°C Maximum/5 Minutes | % @ +20°C 120 Hz Maximum | mΩ @ 20°C 100 kHz Maximum | (mA) @ 100 kHz with/T = +20°C @ -55°C to 125°C | Reflow Temperature ≤ 260°C | (°C) |
| Rated Voltage | Rated Cap | Case Code/ Case Size | KEMET Part Number | DC Leakage | DF | ESR | Ripple Current | Moisture Sensitivity | Rated Temp |

Other part number options:

Also available on large (13 inch) reels. Add 7280 to the end of the part number.

Higher voltage ratings and tighter tolerance product including ESR may be substituted within the same size at KEMET's option. Voltage substitutions will be marked with the higher voltage rating. Substitutions can include better than series.

Table 1 – Ratings & Part Number Reference cont'd

| Rated Voltage | Rated Cap | Case Code/ Case Size | KEMET Part Number | DC Leakage | DF | ESR | Ripple Current | Moisture Sensitivity | Rated Temp |
|---------------|-----------|-------------------------|------------------------------|------------------------------------|--------------------------------|---------------------------------|--|----------------------------------|------------|
| VDC | µF | KEMET/EIA | (See below for part options) | µA @ +20°C Maximum/5 Minutes | % @ +20°C 120 Hz Maximum | mΩ @ 20°C 100 kHz Maximum | (mA) @ 100 kHz with/T = +20°C @ -55°C to 125°C | Reflow Temperature ≤ 260°C | (°C) |
| 6.3 | 150 | X/7343-43 | A700X157M006ATE015 | 38 | 6 | 15 | 3900 | 3 | 125 |
| 6.3 | 180 | X/7343-43 | A700X187M006ATE010 | 45 | 6 | 10 | 4700 | 3 | 125 |
| 6.3 | 180 | X/7343-43 | A700X187M006ATE015 | 45 | 6 | 15 | 3900 | 3 | 125 |
| 6.3 | 220 | X/7343-43 | A700X227M006ATE015 | 55 | 6 | 15 | 3900 | 3 | 125 |
| 8 | 10 | V/7343-20 | A700V106M008ATE055 | 3 | 6 | 55 | 2200 | 3 | 125 |
| 8 | 22 | V/7343-20 | A700V226M008ATE028 | 7 | 6 | 28 | 3100 | 3 | 125 |
| 8 | 22 | V/7343-20 | A700V226M008ATE045 | 7 | 6 | 45 | 2400 | 3 | 125 |
| 8 | 33 | V/7343-20 | A700V336M008ATE018 | 11 | 6 | 18 | 3900 | 3 | 125 |
| 8 | 33 | V/7343-20 | A700V336M008ATE025 | 11 | 6 | 25 | 3300 | 3 | 125 |
| 8 | 33 | V/7343-20 | A700V336M008ATE028 | 11 | 6 | 28 | 3100 | 3 | 125 |
| 8 | 56 | D/7343-31 | A700D566M008ATE015 | 18 | 6 | 15 | 4100 | 3 | 125 |
| 8 | 56 | D/7343-31 | A700D566M008ATE018 | 18 | 6 | 18 | 3700 | 3 | 125 |
| 8 | 68 | D/7343-31 | A700D686M008ATE015 | 22 | 6 | 15 | 4100 | 3 | 125 |
| 8 | 68 | D/7343-31 | A700D686M008ATE018 | 22 | 6 | 18 | 3700 | 3 | 125 |
| 8 | 100 | X/7343-43 | A700X107M008ATE010 | 32 | 6 | 10 | 4700 | 3 | 125 |
| 8 | 100 | X/7343-43 | A700X107M008ATE012 | 32 | 6 | 12 | 4300 | 3 | 125 |
| 8 | 100 | X/7343-43 | A700X107M008ATE015 | 32 | 6 | 15 | 3900 | 3 | 125 |
| 10 | 10 | V/7343-20 | A700V106M010ATE055 | 4 | 6 | 55 | 2200 | 3 | 125 |
| 10 | 22 | V/7343-20 | A700V226M010ATE028 | 9 | 6 | 28 | 3100 | 3 | 125 |
| 10 | 33 | V/7343-20 | A700V336M010ATE018 | 13 | 6 | 18 | 3900 | 3 | 125 |
| 10 | 33 | V/7343-20 | A700V336M010ATE025 | 13 | 6 | 25 | 3300 | 3 | 125 |
| 10 | 33 | V/7343-20 | A700V336M010ATE028 | 13 | 6 | 28 | 3100 | 3 | 125 |
| 10 | 47 | V/7343-20 | A700V476M010ATE028 | 19 | 6 | 28 | 3100 | 3 | 125 |
| 10 | 56 | D/7343-31 | A700D566M010ATE015 | 22 | 6 | 15 | 4100 | 3 | 125 |
| 10 | 56 | D/7343-31 | A700D566M010ATE018 | 22 | 6 | 18 | 3700 | 3 | 125 |
| 10 | 68 | D/7343-31 | A700D686M010ATE015 | 27 | 6 | 15 | 4100 | 3 | 125 |
| 10 | 68 | D/7343-31 | A700D686M010ATE018 | 27 | 6 | 18 | 3700 | 3 | 125 |
| 10 | 100 | X/7343-43 | A700X107M010ATE010 | 40 | 6 | 10 | 4700 | 3 | 125 |
| 10 | 100 | X/7343-43 | A700X107M010ATE015 | 40 | 6 | 15 | 3900 | 3 | 125 |
| 10 | 120 | X/7343-43 | A700X127M010ATE010 | 48 | 6 | 10 | 4700 | 3 | 125 |
| 10 | 120 | X/7343-43 | A700X127M010ATE015 | 48 | 6 | 15 | 3900 | 3 | 125 |
| 10 | 150 | X/7343-43 | A700X157M010ATE010 | 60 | 6 | 10 | 4700 | 3 | 125 |
| 10 | 150 | X/7343-43 | A700X157M010ATE015 | 60 | 6 | 15 | 3900 | 3 | 125 |
| 12.5 | 10 | V/7343-20 | A700V106M12RATE040 | 5 | 6 | 40 | 2600 | 3 | 125 |
| 12.5 | 10 | V/7343-20 | A700V106M12RATE060 | 5 | 6 | 60 | 2100 | 3 | 125 |
| 12.5 | 15 | V/7343-20 | A700V156M12RATE040 | 8 | 6 | 40 | 2600 | 3 | 125 |
| 12.5 | 22 | V/7343-20 | A700V226M12RATE030 | 11 | 6 | 30 | 3000 | 3 | 125 |
| 12.5 | 47 | D/7343-31 | A700D476M12RATE020 | 24 | 6 | 20 | 3500 | 3 | 125 |
| 12.5 | 47 | D/7343-31 | A700D476M12RATE025 | 24 | 6 | 25 | 3200 | 3 | 125 |
| 12.5 | 100 | X/7343-43 | A700X107M12RATE015 | 50 | 6 | 15 | 3900 | 3 | 125 |
| 16 | 6.8 | V/7343-20 | A700V685M016ATE070 | 4 | 6 | 70 | 2000 | 3 | 125 |
| 16 | 8.2 | V/7343-20 | A700V825M016ATE045 | 5 | 6 | 45 | 2400 | 3 | 125 |
| 16 | 10 | V/7343-20 | A700V106M016ATE045 | 6 | 6 | 45 | 2400 | 3 | 125 |
| 16 | 10 | V/7343-20 | A700V106M016ATE060 | 6 | 6 | 60 | 2100 | 3 | 125 |
| 16 | 15 | V/7343-20 | A700V156M016ATE040 | 10 | 6 | 40 | 2600 | 3 | 125 |
| 16 | 22 | D/7343-31 | A700D226M016ATE018 | 14 | 6 | 18 | 3700 | 3 | 125 |
| 16 | 22 | D/7343-31 | A700D226M016ATE025 | 14 | 6 | 25 | 3200 | 3 | 125 |
| 16 | 22 | D/7343-31 | A700D226M016ATE030 | 14 | 6 | 30 | 2900 | 3 | 125 |
| VDC | µF | KEMET/EIA | (See below for part options) | µA @ +20°C Maximum/5 Minutes | % @ +20°C 120 Hz Maximum | mΩ @ 20°C 100 kHz Maximum | (mA) @ 100 kHz with/T = +20°C @ -55°C to 125°C | Reflow Temperature ≤ 260°C | (°C) |
| Rated Voltage | Rated Cap | Case Code/ Case Size | KEMET Part Number | DC Leakage | DF | ESR | Ripple Current | Moisture Sensitivity | Rated Temp |

Other part number options:

Also available on large (13 inch) reels. Add 7280 to the end of the part number.

Higher voltage ratings and tighter tolerance product including ESR may be substituted within the same size at KEMET's option. Voltage substitutions will be marked with the higher voltage rating. Substitutions can include better than series.

Derating Guidelines

| Voltage Rating | Maximum Recommended Steady State Voltage | Maximum Recommended Transient Voltage (1 ms – 1 μs) |
|--------------------------|--|---|
| -55°C to 125°C | | |
| $2 V \leq V_R \leq 16 V$ | V_R | V_R |

V_R = Rated Voltage

Ripple Current/Ripple Voltage

Permissible AC ripple voltage and current are related to equivalent series resistance (ESR) and the power dissipation capabilities of the device. Permissible AC ripple voltage which may be applied is limited by two criteria

1. The positive peak AC voltage plus the DC bias voltage, if any, must not exceed the DC voltage rating of the capacitor.
2. The negative peak AC voltage, in combination with bias voltage, if any, must not exceed the allowable limits specified for reverse voltage. See the Reverse Voltage section for allowable limits

Power capability is determined based on a 20°C temperature rise. A higher temperature rise and therefore higher power capability is allowable as long as the ambient temperature plus temperature rise due to ripple current does not exceed the rated temperature of the part.

The maximum power dissipation by case size can be determined using the below table.

| KEMET Series and Case Code | EIA Case Code | Maximum Power Dissipation (P max) mWatts @ 25°C with +20°C Rise |
|----------------------------|---------------|---|
| A700W | 7343-15 | 290 |
| A700V | 7343-20 | 270 |
| A700D | 7343-31 | 250 |
| A700X | 7343-43 | 225 |

Using the P max of the device, the maximum allowable rms ripple current or voltage may be determined.

$$I(max) = \sqrt{P_{max}/R}$$

$$E(max) = \sqrt{P_{max} \cdot R}$$

I = rms ripple current (amperes)

E = rms ripple voltage (volts)

P_{max} = maximum power dissipation(watts)

R = ESR at specified frequency (ohms)

Refer to part number listings for permissible Arms limits.

Reverse Voltage

Polymer aluminum capacitors are polar devices and may be permanently damaged or destroyed if connected in the wrong polarity. These devices will withstand a certain degree of transient voltage reversal for short periods as shown in the below table. Please note that these parts may not be operated continuously in reverse, even within these limits.

| Temperature | Permissible Transient Reverse Voltage |
|-------------|---------------------------------------|
| 25°C | 60% of Rated Voltage |
| 55°C | 50% of Rated Voltage |
| 85°C | 40% of Rated Voltage |
| 125°C | 30% of Rated Voltage |

Table 2 – Land Dimensions/Courtyard

| KEMET | Metric Size Code | Density Level A: Maximum (Most) Land Protrusion (mm) | | | | | Density Level B: Median (Nominal) Land Protrusion (mm) | | | | | Density Level C: Minimum (Least) Land Protrusion (mm) | | | | |
|----------------|------------------|--|------|------|-------|------|--|------|------|------|------|---|------|------|------|------|
| | | X | Y | C | V1 | V2 | X | Y | C | V1 | V2 | X | Y | C | V1 | V2 |
| D | 7343-31 | 2.55 | 3.75 | 2.70 | 10.20 | 5.50 | 2.45 | 3.35 | 2.60 | 9.10 | 5.00 | 2.35 | 2.95 | 2.50 | 8.20 | 4.70 |
| V | 7343-20 | 2.55 | 3.75 | 2.70 | 10.20 | 5.50 | 2.45 | 3.35 | 2.60 | 9.10 | 5.00 | 2.35 | 2.95 | 2.50 | 8.20 | 4.70 |
| W | 7343-15 | 2.55 | 3.75 | 2.70 | 10.20 | 5.50 | 2.45 | 3.35 | 2.60 | 9.10 | 5.00 | 2.35 | 2.95 | 2.50 | 8.20 | 4.70 |
| X ¹ | 7343-43 | 2.55 | 3.75 | 2.70 | 10.20 | 5.50 | 2.45 | 3.35 | 2.60 | 9.10 | 5.00 | 2.35 | 2.95 | 2.50 | 8.20 | 4.70 |

Density Level A: For low-density product applications. Recommended for wave solder applications and provides a wider process window for reflow solder processes.

Density Level B: For products with a moderate level of component density. Provides a robust solder attachment condition for reflow solder processes.

Density Level C: For high component density product applications. Before adapting the minimum land pattern variations the user should perform qualification testing based on the conditions outlined in IPC Standard 7351 (IPC-7351).

¹ Height of these chips may create problems in wave soldering.



Soldering Process

KEMET's families of surface mount capacitors are compatible with wave (single or dual), convection, IR, or vapor phase reflow techniques. Preheating of these components is recommended to avoid extreme thermal stress. KEMET's recommended profile conditions for convection and IR reflow reflect the profile conditions of the IPC/J-STD-020D standard for moisture sensitivity testing. The devices can safely withstand a maximum of three reflow passes at these conditions.

Please note that although the X/7343-43 case size can withstand wave soldering, the tall profile (4.3 mm maximum) dictates care in wave process development.

Hand soldering should be performed with care due to the difficulty in process control. If performed, care should be taken to avoid contact of the soldering iron to the molded case. The iron should be used to heat the solder pad, applying solder between the pad and the termination, until reflow occurs. Once reflow occurs, the iron should be removed immediately. "Wiping" the edges of a chip and heating the top surface is not recommended.

During typical reflow operations, a slight darkening of the gold-colored epoxy may be observed. This slight darkening is normal and not harmful to the product. Marking permanency is not affected by this change.

| Profile Feature | SnPb Assembly | Pb-Free Assembly |
|---|---------------------|---------------------|
| Preheat/Soak | | |
| Temperature Minimum (T_{smin}) | 100°C | 150°C |
| Temperature Maximum (T_{smax}) | 150°C | 200°C |
| Time (t_s) from T_{smin} to T_{smax} | 60 – 120 seconds | 60 – 120 seconds |
| Ramp-up Rate (T_L to T_p) | 3°C/seconds maximum | 3°C/seconds maximum |
| Liquidous Temperature (T_L) | 183°C | 217°C |
| Time Above Liquidous (t_L) | 60 – 150 seconds | 60 – 150 seconds |
| Peak Temperature (T_p) | 220°C* 235°C** | 250°C* 260°C** |
| Time within 5°C of Maximum Peak Temperature (t_p) | 20 seconds maximum | 30 seconds maximum |
| Ramp-down Rate (T_p to T_L) | 6°C/seconds maximum | 6°C/seconds maximum |
| Time 25°C to Peak Temperature | 6 minutes maximum | 8 minutes maximum |

Note: All temperatures refer to the center of the package, measured on the package body surface that is facing up during assembly reflow.

*Case Size D, E, P, Y, and X

**Case Size A, B, C, H, I, K, M, R, S, T, U, V, W, and Z



Capacitor Marking



* 035 = 35th week of 2010

| Date Code * | |
|--|--|
| 1 st digit = Last number of Year | 9 = 2009 0 = 2010 1 = 2011 2 = 2012 3 = 2013 4 = 2014 |
| 2 nd and 3 rd digit = Week of the Year | 01 = 1 st week of the Year to 52 = 52 nd week of the Year |

Storage

All AO-CAP series are shipped in moisture barrier bags with a desiccant and moisture indicator card. These series are classified as MSL3 (Moisture Sensitivity Level 3). Product contained within the moisture barrier bags should be stored in normal working environments with temperatures not to exceed 40°C and humidity not in excess of 60% RH.

Tape & Reel Packaging Information

KEMET's molded tantalum and aluminum chip capacitor families are packaged in 8 and 12 mm plastic tape on 7" and 13" reels in accordance with *EIA Standard 481-1: Embossed Carrier Taping of Surface Mount Components for Automatic Handling*. This packaging system is compatible with all tape-fed automatic pick-and-place systems.

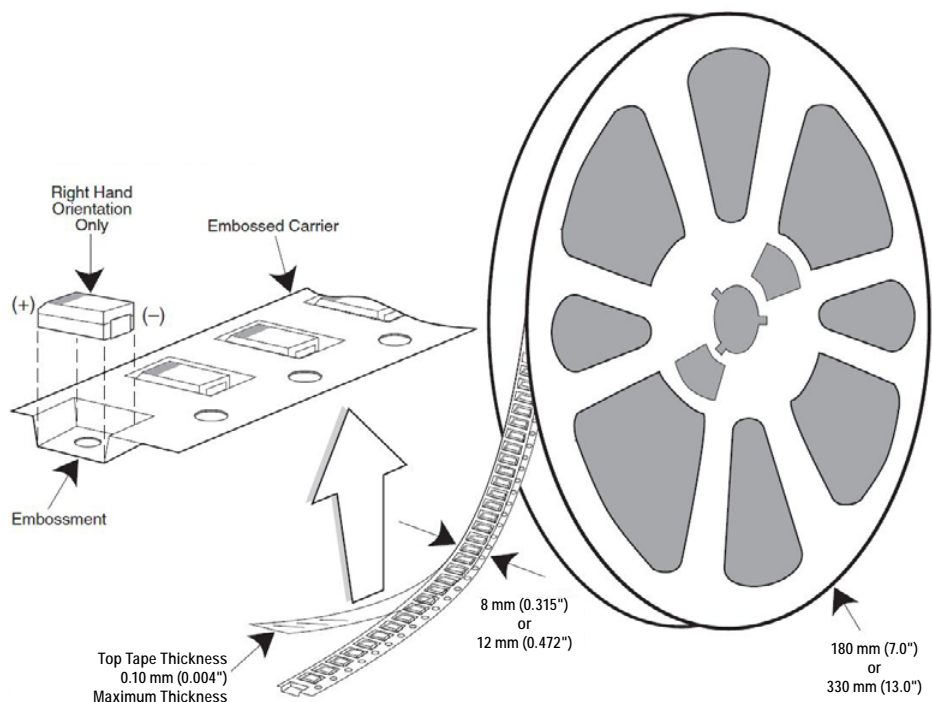

Table 3 – Packaging Quantity

| Case Code | | Tape Width (mm) | 7" Reel* | 13" Reel* |
|-----------|---------|-----------------|----------|-----------|
| KEMET | EIA | | | |
| I | 3216-10 | 8 | 3,000 | 12,000 |
| S | 3216-12 | 8 | 2,500 | 10,000 |
| T | 3528-12 | 8 | 2,500 | 10,000 |
| M | 3528-15 | 8 | 2,000 | 8,000 |
| U | 6032-15 | 12 | 1,000 | 5,000 |
| L | 6032-19 | 12 | 1,000 | 5,000 |
| W | 7343-15 | 12 | 1,000 | 3,000 |
| Z | 7343-17 | 12 | 1,000 | 3,000 |
| V | 7343-20 | 12 | 1,000 | 3,000 |
| A | 3216-18 | 8 | 2,000 | 9,000 |
| B | 3528-21 | 8 | 2,000 | 8,000 |
| C | 6032-28 | 12 | 500 | 3,000 |
| D | 7343-31 | 12 | 500 | 2,500 |
| Y | 7343-40 | 12 | 500 | 2,000 |
| X | 7343-43 | 12 | 500 | 2,000 |
| E/T428P | 7360-38 | 12 | 500 | 2,000 |
| H | 7360-20 | 12 | 1,000 | 2,500 |

* No C-Spec required for 7" reel packaging. C-7280 required for 13" reel packaging.

Figure 1 – Embossed (Plastic) Carrier Tape Dimensions



Table 4 – Embossed (Plastic) Carrier Tape Dimensions

Metric will govern

| Constant Dimensions — Millimeters (Inches) | | | | | | | | | |
|--|---------------------------------------|----------------------------------|------------------------------|-----------------------------|-----------------------------|------------------------|----------------------------------|--|------------------------|
| Tape Size | D ₀ | D ₁ Minimum Note 1 | E ₁ | P ₀ | P ₂ | R Reference Note 2 | S ₁ Minimum Note 3 | T Maximum | T ₁ Maximum |
| 8 mm | 1.5 +0.10/-0.0 (0.059 +0.004/-0.0) | 1.0 (0.039) | 1.75 ±0.10 (0.069 ±0.004) | 4.0 ±0.10 (0.157 ±0.004) | 2.0 ±0.05 (0.079 ±0.002) | 25.0 (0.984) | 0.600 (0.024) | 0.600 (0.024) | 0.100 (0.004) |
| 12 mm | | 1.5 (0.059) | | | | 30 (1.181) | | | |
| 16 mm | | | | | | | | | |
| Variable Dimensions — Millimeters (Inches) | | | | | | | | | |
| Tape Size | Pitch | B ₁ Maximum Note 4 | E ₂ Minimum | F | P ₁ | T ₂ Maximum | W Maximum | A ₀ , B ₀ & K ₀ | |
| 8 mm | Single (4 mm) | 4.35 (0.171) | 6.25 (0.246) | 3.5 ±0.05 (0.138 ±0.002) | 4.0 ±0.10 (0.157 ±0.004) | 2.5 (0.098) | 8.3 (0.327) | Note 5 | |
| 12 mm | Single (4 mm) & Double (8 mm) | 8.2 (0.323) | 10.25 (0.404) | 5.5 ±0.05 (0.217 ±0.002) | 8.0 ±0.10 (0.315 ±0.004) | 4.6 (0.181) | 12.3 (0.484) | | |
| 16 mm | Triple (12 mm) | 12.1 (0.476) | 14.25 (0.561) | 5.5 ±0.05 (0.217 ±0.002) | 8.0 ±0.10 (0.315 ±0.004) | 4.6 (0.181) | 16.3 (0.642) | | |

- The embossment hole location shall be measured from the sprocket hole controlling the location of the embossment. Dimensions of embossment location and hole location shall be applied independent of each other.
- The tape, with or without components, shall pass around R without damage (see Figure 5).
- If S₁ < 1.0 mm, there may not be enough area for cover tape to be properly applied (see EIA Standard 481–D, paragraph 4.3, section b).
- B₁ dimension is a reference dimension for tape feeder clearance only.
- The cavity defined by A₀, B₀ and K₀ shall surround the component with sufficient clearance that:
 - the component does not protrude above the top surface of the carrier tape.
 - the component can be removed from the cavity in a vertical direction without mechanical restriction, after the top cover tape has been removed.
 - rotation of the component is limited to 20° maximum for 8 and 12 mm tapes and 10° maximum for 16 mm tapes (see Figure 2).
 - lateral movement of the component is restricted to 0.5 mm maximum for 8 mm and 12 mm wide tape and to 1.0 mm maximum for 16 mm tape (see Figure 3).
 - see Addendum in EIA Standard 481–D for standards relating to more precise taping requirements.

Packaging Information Performance Notes

1. Cover Tape Break Force: 1.0 Kg minimum.
2. Cover Tape Peel Strength: The total peel strength of the cover tape from the carrier tape shall be:

| Tape Width | Peel Strength |
|--------------|----------------------------------|
| 8 mm | 0.1 to 1.0 Newton (10 to 100 gf) |
| 12 and 16 mm | 0.1 to 1.3 Newton (10 to 130 gf) |

The direction of the pull shall be opposite the direction of the carrier tape travel. The pull angle of the carrier tape shall be 165° to 180° from the plane of the carrier tape. During peeling, the carrier and/or cover tape shall be pulled at a velocity of 300 ±10 mm/minute.

3. Labeling: Bar code labeling (standard or custom) shall be on the side of the reel opposite the sprocket holes. Refer to EIA Standards 556 and 624.

Figure 2 – Maximum Component Rotation

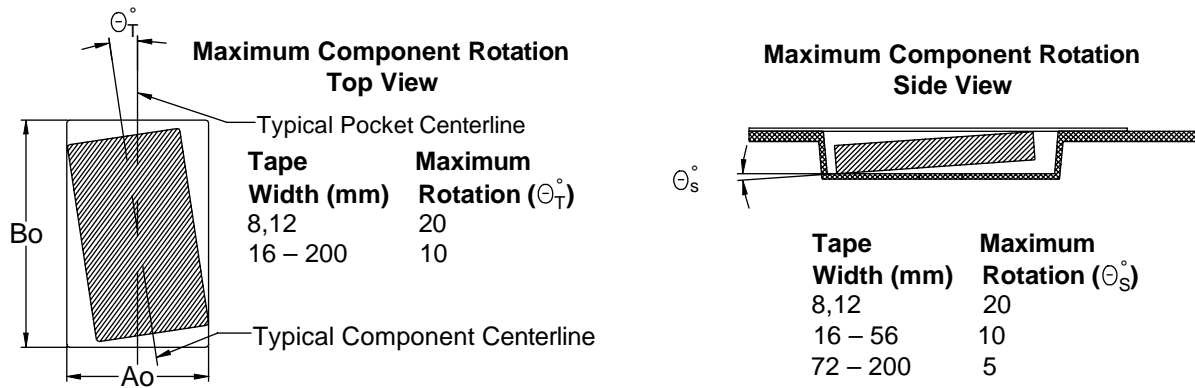

Figure 3 – Maximum Lateral Movement



Figure 4 – Bending Radius



Figure 5 – Reel Dimensions



Note: Drive spokes optional; if used, dimensions B and D shall apply.

Table 5 – Reel Dimensions

Metric will govern

| Constant Dimensions – Millimeters (Inches) | | | | |
|--|---|---------------------------------------|--|---|
| Tape Size | A | B Minimum | C | D Minimum |
| 8 mm | 178 ±0.20 (7.008 ±0.008) or 330 ±0.20 (13.000 ±0.008) | 1.5 (0.059) | 13.0 +0.5/-0.2 (0.521 +0.02/-0.008) | 20.2 (0.795) |
| 12 mm | | | | |
| 16 mm | | | | |
| Variable Dimensions – Millimeters (Inches) | | | | |
| Tape Size | N Minimum | W ₁ | W ₂ Maximum | W ₃ |
| 8 mm | 50 (1.969) | 8.4 +1.5/-0.0 (0.331 +0.059/-0.0) | 14.4 (0.567) | Shall accommodate tape width without interference |
| 12 mm | | 12.4 +2.0/-0.0 (0.488 +0.078/-0.0) | 18.4 (0.724) | |
| 16 mm | | 16.4 +2.0/-0.0 (0.646 +0.078/-0.0) | 22.4 (0.882) | |

Figure 6 – Tape Leader & Trailer Dimensions



Figure 7 – Maximum Camber



Tape & Reel Packaging Information

KEMET's molded tantalum and aluminum chip capacitor families are packaged in 8 and 12 mm plastic tape on 7" and 13" reels in accordance with *EIA Standard 481-1: Embossed Carrier Taping of Surface Mount Components for Automatic Handling*. This packaging system is compatible with all tape-fed automatic pick-and-place systems.



Table 3 – Packaging Quantity

| Case Code | | Tape Width (mm) | 7" Reel* | 13" Reel* |
|-----------|---------|-----------------|----------|-----------|
| KEMET | EIA | | | |
| R | 2012-12 | 8 | 2,500 | 10,000 |
| I | 3216-10 | 8 | 3,000 | 12,000 |
| S | 3216-12 | 8 | 2,500 | 10,000 |
| T | 3528-12 | 8 | 2,500 | 10,000 |
| M | 3528-15 | 8 | 2,000 | 8,000 |
| U | 6032-15 | 12 | 1,000 | 5,000 |
| L | 6032-19 | 12 | 1,000 | 5,000 |
| W | 7343-15 | 12 | 1,000 | 3,000 |
| Z | 7343-17 | 12 | 1,000 | 3,000 |
| V | 7343-19 | 12 | 1,000 | 3,000 |
| A | 3216-18 | 8 | 2,000 | 9,000 |
| B | 3528-21 | 8 | 2,000 | 8,000 |
| C | 6032-28 | 12 | 500 | 3,000 |
| D | 7343-31 | 12 | 500 | 2,500 |
| Y | 7343-40 | 12 | 500 | 2,000 |
| X | 7343-43 | 12 | 500 | 2,000 |
| E/T428P | 7360-38 | 12 | 500 | 2,000 |
| H | 7360-20 | 12 | 1,000 | 2,500 |

* No C-Spec required for 7" reel packaging. C-7280 required for 13" reel packaging.

Figure 1 – Embossed (Plastic) Carrier Tape Dimensions



Table 4 – Embossed (Plastic) Carrier Tape Dimensions

Metric will govern

| Constant Dimensions — Millimeters (Inches) | | | | | | | | | |
|--|---|-------------------------|------------------------------------|-----------------------------------|-----------------------------------|-----------------------|-------------------------|--------------------|------------------|
| Tape Size | D_0 | D_1 Minimum Note 1 | E_1 | P_0 | P_2 | R Reference Note 2 | S_1 Minimum Note 3 | T Maximum | T_1 Maximum |
| 8 mm | $1.5 +0.10/-0.0$ (0.059 +0.004/-0.0) | 1.0 (0.039) | 1.75 ± 0.10 (0.069 ± 0.004) | 4.0 ± 0.10 (0.157 ± 0.004) | 2.0 ± 0.05 (0.079 ± 0.002) | 25.0 (0.984) | 0.600 (0.024) | 0.600 (0.024) | 0.100 (0.004) |
| 12 mm | | 1.5 (0.059) | | | | 30 (1.181) | | | |
| 16 mm | | | | | | | | | |
| Variable Dimensions — Millimeters (Inches) | | | | | | | | | |
| Tape Size | Pitch | B_1 Maximum Note 4 | E_2 Minimum | F | P_1 | T_2 Maximum | W Maximum | A_0, B_0 & K_0 | |
| 8 mm | Single (4 mm) | 4.35 (0.171) | 6.25 (0.246) | 3.5 ± 0.05 (0.138 ± 0.002) | 4.0 ± 0.10 (0.157 ± 0.004) | 2.5 (0.098) | 8.3 (0.327) | Note 5 | |
| 12 mm | Single (4 mm) & Double (8 mm) | 8.2 (0.323) | 10.25 (0.404) | 5.5 ± 0.05 (0.217 ± 0.002) | 8.0 ± 0.10 (0.315 ± 0.004) | 4.6 (0.181) | 12.3 (0.484) | | |
| 16 mm | Triple (12 mm) | 12.1 (0.476) | 14.25 (0.561) | 5.5 ± 0.05 (0.217 ± 0.002) | 8.0 ± 0.10 (0.315 ± 0.004) | 4.6 (0.181) | 16.3 (0.642) | | |

- The embossment hole location shall be measured from the sprocket hole controlling the location of the embossment. Dimensions of embossment location and hole location shall be applied independent of each other.
- The tape, with or without components, shall pass around R without damage (see Figure 5).
- If $S_1 < 1.0$ mm, there may not be enough area for cover tape to be properly applied (see EIA Standard 481-1, paragraph 4.3, section b).
- B_1 dimension is a reference dimension for tape feeder clearance only.
- The cavity defined by A_0 , B_0 and K_0 shall surround the component with sufficient clearance that:
 - the component does not protrude above the top surface of the carrier tape.
 - the component can be removed from the cavity in a vertical direction without mechanical restriction, after the top cover tape has been removed.
 - rotation of the component is limited to 20° maximum for 8 and 12 mm tapes and 10° maximum for 16 mm tapes (see Figure 2).
 - lateral movement of the component is restricted to 0.5 mm maximum for 8 mm and 12 mm wide tape and to 1.0 mm maximum for 16 mm tape (see Figure 3).
 - see Addendum in EIA Standard 481-1 for standards relating to more precise taping requirements.

Packaging Information Performance Notes

1. Cover Tape Break Force: 1.0 Kg minimum.
2. Cover Tape Peel Strength: The total peel strength of the cover tape from the carrier tape shall be:

| Tape Width | Peel Strength |
|--------------|----------------------------------|
| 8 mm | 0.1 to 1.0 Newton (10 to 100 gf) |
| 12 and 16 mm | 0.1 to 1.3 Newton (10 to 130 gf) |

The direction of the pull shall be opposite the direction of the carrier tape travel. The pull angle of the carrier tape shall be 165° to 180° from the plane of the carrier tape. During peeling, the carrier and/or cover tape shall be pulled at a velocity of 300 ±10 mm/minute.

3. Labeling: Bar code labeling (standard or custom) shall be on the side of the reel opposite the sprocket holes. Refer to EIA Standards 556 and 624.

Figure 2 – Maximum Component Rotation



Figure 3 – Maximum Lateral Movement



Figure 4 – Bending Radius



Figure 5 – Reel Dimensions



Note: Drive spokes optional; if used, dimensions B and D shall apply.

Table 5 – Reel Dimensions

Metric will govern

| Constant Dimensions – Millimeters (Inches) | | | | |
|--|---|---------------------------------------|--|---|
| Tape Size | A | B Minimum | C | D Minimum |
| 8 mm | 178 ±0.20 (7.008 ±0.008) or 330 ±0.20 (13.000 ±0.008) | 1.5 (0.059) | 13.0 +0.5/-0.2 (0.521 +0.02/-0.008) | 20.2 (0.795) |
| 12 mm | | | | |
| 16 mm | | | | |
| Variable Dimensions – Millimeters (Inches) | | | | |
| Tape Size | N Minimum | W ₁ | W ₂ Maximum | W ₃ |
| 8 mm | 50 (1.969) | 8.4 +1.5/-0.0 (0.331 +0.059/-0.0) | 14.4 (0.567) | Shall accommodate tape width without interference |
| 12 mm | | 12.4 +2.0/-0.0 (0.488 +0.078/-0.0) | 18.4 (0.724) | |
| 16 mm | | 16.4 +2.0/-0.0 (0.646 +0.078/-0.0) | 22.4 (0.882) | |

Figure 6 – Tape Leader & Trailer Dimensions



Figure 7 – Maximum Camber



KEMET Corporation World Headquarters

2835 KEMET Way
Simpsonville, SC 29681

Mailing Address:
P.O. Box 5928
Greenville, SC 29606

www.kemet.com
Tel: 864-963-6300
Fax: 864-963-6521

Corporate Offices
Fort Lauderdale, FL
Tel: 954-766-2800

North America

Southeast
Lake Mary, FL
Tel: 407-855-8886

Northeast
Wilmington, MA
Tel: 978-658-1663

Central
Novi, MI
Tel: 248-994-1030

West
Milpitas, CA
Tel: 408-433-9950

Mexico
Guadalajara, Jalisco
Tel: 52-33-3123-2141

Europe

Southern Europe
Paris, France
Tel: 33-1-4646-1006

Sasso Marconi, Italy
Tel: 39-051-939111

Central Europe
Landsberg, Germany
Tel: 49-8191-3350800

Kamen, Germany
Tel: 49-2307-438110

Northern Europe
Bishop's Stortford, United Kingdom
Tel: 44-1279-460122

Espoo, Finland
Tel: 358-9-5406-5000

Asia

Northeast Asia
Hong Kong
Tel: 852-2305-1168

Shenzhen, China
Tel: 86-755-2518-1306

Beijing, China
Tel: 86-10-5829-1711

Shanghai, China
Tel: 86-21-6447-0707

Taipei, Taiwan
Tel: 886-2-27528585

Southeast Asia
Singapore
Tel: 65-6586-1900

Penang, Malaysia
Tel: 60-4-6430200

Bangalore, India
Tel: 91-806-53-76817

Note: KEMET reserves the right to modify minor details of internal and external construction at any time in the interest of product improvement. KEMET does not assume any responsibility for infringement that might result from the use of KEMET Capacitors in potential circuit designs. KEMET is a registered trademark of KEMET Electronics Corporation.

Other KEMET Resources

| Tools | |
|--------------------------------|---|
| Resource | Location |
| Configure A Part: CapEdge | http://capacitoredge.kemet.com |
| SPICE & FIT Software | http://www.kemet.com/spice |
| Search Our FAQs: KnowledgeEdge | http://www.kemet.com/keask |
| Electrolytic LifeCalculator | http://www.kemet.com:8080/elc |

| Product Information | |
|--|---|
| Resource | Location |
| Products | http://www.kemet.com/products |
| Technical Resources (Including Soldering Techniques) | http://www.kemet.com/technicalpapers |
| RoHS Statement | http://www.kemet.com/rohs |
| Quality Documents | http://www.kemet.com/qualitydocuments |

| Product Request | |
|-------------------------|---|
| Resource | Location |
| Sample Request | http://www.kemet.com/sample |
| Engineering Kit Request | http://www.kemet.com/kits |

| Contact | |
|--------------------|---|
| Resource | Location |
| Website | www.kemet.com |
| Contact Us | http://www.kemet.com/contact |
| Investor Relations | http://www.kemet.com/ir |
| Call Us | 1-877-MyKEMET |
| Twitter | http://twitter.com/kemetcapacitors |

Disclaimer

All product specifications, statements, information and data (collectively, the "Information") are subject to change without notice.

All Information given herein is believed to be accurate and reliable, but is presented without guarantee, warranty, or responsibility of any kind, expressed or implied.

Statements of suitability for certain applications are based on our knowledge of typical operating conditions for such applications, but are not intended to constitute – and we specifically disclaim – any warranty concerning suitability for a specific customer application or use. This Information is intended for use only by customers who have the requisite experience and capability to determine the correct products for their application. Any technical advice inferred from this Information or otherwise provided by us with reference to the use of our products is given gratis, and we assume no obligation or liability for the advice given or results obtained.

Although we design and manufacture our products to the most stringent quality and safety standards, given the current state of the art, isolated component failures may still occur. Accordingly, customer applications which require a high degree of reliability or safety should employ suitable designs or other safeguards (such as installation of protective circuitry or redundancies) in order to ensure that the failure of an electrical component does not result in a risk of personal injury or property damage.

Although all product-related warnings, cautions and notes must be observed, the customer should not assume that all safety measures are indicated or that other measures may not be required.

Product & Process Design

Sales & Marketing

Supplier

Material Management

Quality

Manufacturing

Logistics & Distribution

People: Leadership
& Development

KEMET Production System

Corporate Offices

KEMET Corporation
2835 KEMET Way
Simpsonville, SC 29681
USA
Tel: 864.963.6300
Fax: 864.963.6521

KEMET Electronics S.A.
15bis chemin des Mines
1202 Geneva
Switzerland
Tel: 41.22.715.0100
Fax: 41.22.715.0170

KEMET Electronics Marketing (S) Pte Ltd.
73 Bukit Timah Road
#05-01 Rex House
Singapore 229832
Tel: 65.6586.1900
Fax: 65.6586.1901

www.kemet.com

The Capacitance Company
KEMET
CHARGED®



Стандарт Электрон Связь

Мы молодая и активно развивающаяся компания в области поставок электронных компонентов. Мы поставляем электронные компоненты отечественного и импортного производства напрямую от производителей и с крупнейших складов мира.

Благодаря сотрудничеству с мировыми поставщиками мы осуществляем комплексные и плановые поставки широчайшего спектра электронных компонентов.

Собственная эффективная логистика и склад в обеспечивает надежную поставку продукции в точно указанные сроки по всей России.

Мы осуществляем техническую поддержку нашим клиентам и предпродажную проверку качества продукции. На все поставляемые продукты мы предоставляем гарантию .

Осуществляем поставки продукции под контролем ВП МО РФ на предприятия военно-промышленного комплекса России , а также работаем в рамках 275 ФЗ с открытием отдельных счетов в уполномоченном банке. Система менеджмента качества компании соответствует требованиям ГОСТ ISO 9001.

Минимальные сроки поставки, гибкие цены, неограниченный ассортимент и индивидуальный подход к клиентам являются основой для выстраивания долгосрочного и эффективного сотрудничества с предприятиями радиоэлектронной промышленности, предприятиями ВПК и научно-исследовательскими институтами России.

С нами вы становитесь еще успешнее!

Наши контакты:

Телефон: +7 812 627 14 35

Электронная почта: sales@st-electron.ru

Адрес: 198099, Санкт-Петербург,
Промышленная ул, дом № 19, литера Н,
помещение 100-Н Офис 331