

Tantalum & Aluminum Surface Mount Capacitors

Low ESR



One world. One KEMET.

The Capacitance Company
KEMET
CHARGED.®

Table of Contents	Page
Why Choose KEMET	3
MnO₂	
T494 Industrial Grade Low ESR MnO ₂ Series.....	9
T495 Surge Robust Low ESR MnO ₂ Series	25
T510 Multiple Anode Low ESR MnO ₂ Series.....	41
Tantalum Stack MnO ₂ (TSM) Series	50
Polymer	
T520 Series Polymer Tantalum	60
T521 High Voltage Polymer Tantalum	77
T522 Reduced Leakage Polymer Tantalum	86
T525 125°C Rated Polymer Tantalum	95
T528 Low ESL/Facedown Terminal Polymer Tantalum	104
T530 High Capacitance/125°C Rated Polymer Tantalum.....	113
T543 Series Polymer Tantalum COTS	123
T545 Series High Energy Polymer Tantalum	142
Tantalum Stack Polymer (TSP) Series	151
KEMET Organic Capacitor (AO-CAP)	
A700 Series Polymer Aluminum.....	161
Packaging Information.....	172
Packaging Information for T520 and T522	177
KEMET Corporation Sales Offices	182
Other KEMET Resources.....	183



One world. One source. One KEMET.

No bouncing from supplier to supplier to find what you need. No multiple web sites and phone calls to get answers.

When you partner with KEMET, our entire global organization seamlessly provides you with the coordinated action and service you need. We're your single, integrated source for capacitance solutions worldwide, offering 95% of possible dielectric solutions, to cover practically any application. With new, innovative products year after year after year. Global availability. Full design collaboration, with fast custom design and prototyping to give your new products a competitive edge. Plus consistent quality, reliability and on-time delivery.

All from one company that's easy to work with and totally dedicated to your success. For anything to do with capacitance, call *The Capacitance Company* – KEMET.



Looking for a hassle-free source for 95% of possible dielectric solutions?

KEMET is the place for one-stop dielectric shopping. We offer our customers the broadest selection of capacitor technologies in the industry, including tantalum, ceramic, aluminum, electrolytic, film and paper.

But the range of products is only the beginning. You simply won't find an electronic components manufacturer more determined to find new technological solutions to customer problems, or more committed to product quality and on-time delivery – in every case, lowering your total cost of ownership as much as we possibly can. It's how we've helped customers succeed for more than 90 years. And it's how we're helping them succeed today.



We're everywhere you need us to be.

AMERICA

Canada
Mexico
USA

EMEA

Bulgaria
Finland
France
Germany
Italy
Portugal
Sweden
Switzerland
United Kingdom

ASIA-PACIFIC

China
Hong Kong
India
Indonesia
Japan
Malaysia
Singapore
Taiwan

The next time you board an airplane, boot up your computer or read about a breakthrough medical device, a piece of our technology is likely involved. KEMET customers include nearly all of the world's major electronics original equipment manufacturers, manufacturing services companies and electronics distributors. High Reliability versions of our capacitors are even in outer space, part of every important military and aerospace effort of the past 60 years, from the first Telstar satellite and Apollo 11 to the Patriot missile, International Space Station and Mars Pathfinder.

Our sales offices can't be quite as ubiquitous as our products, but we do pride ourselves on being where you need us. This map shows you our sales offices around the world.

As you can see, we're not only easy to work with, we're easy to find. And we're more than ready to be your single source capacitance solutions supplier.

One world. One source. One KEMET.



Why The Capacitance Company is also the “Easy-To-Buy-From” company.

When you choose KEMET, you’ll enjoy a level of responsiveness you just won’t get from any other component manufacturer. You simply won’t find an electronic components manufacturer more passionate about customer service. Our innovative service offerings and superior localized support are known throughout the industry, powered by our global, customer-focused sales organization and worldwide logistics capabilities. We’re 100% committed to serving any customer, anywhere, and meeting customer needs when they need to be met.

Whether you need rush samples, technical assistance, in-person consultations or accelerated custom design, design collaboration and prototype services, we have a solution. If it’s anything to do with capacitance, we can help – and help fast.



Working to make a better world.

At KEMET, we're proud to work with customers to develop products that truly make the world a better, safer, more connected place to live – from hand-held devices to automotive systems to the greenest energy technology.

As a company, KEMET is dedicated to economically, environmentally and socially sustainable development. We've adopted the Electronic Industry Code of Conduct (EICC), addressing all aspects of corporate responsibility. All of our commercial-grade products are available in RoHS-compliant versions with Pb-free terminations. Our manufacturing facilities have won numerous environmental excellence awards and recognitions. And our supply chain is certified to be sourced from areas that are neither environmentally protected nor under conflict.

After all, we believe that doing the right thing is in everyone's interest.



Which capacitor is right for you?

As The Capacitance Company, we make over 95% of possible dielectric solutions – the broadest selection of capacitor technologies in the industry. By offering a wide variety of dielectrics, dimensions, voltages, temperature characteristics and terminations, KEMET capacitors satisfy an expansive range of customer requirements and applications.

In fact, if the capacitor you need hasn't been invented, it's only because you haven't asked. We can quickly develop custom products and carry out early-stage manufacturing through our accelerated collaboration services. Available through our global innovation and manufacturing centers around the world, accelerated collaboration brings together the necessary people, equipment and facilities together to get the job done, on time and in budget.

Of course, when you're under pressure to design smaller and smaller products with greater and greater functionality, there's no time for the traditional back-and-forth with your suppliers. With KEMET, you get direct contact to the engineers and other professionals who can help you successfully solve your design problems, and in record time. We deal personally with customers to ascertain the new part types needed for their next-generation products. In many cases, we can go from start to samples in only four months.

We've helped some of the world's most prominent electronics companies slash time to market and gain significant windows of competitive advantage. We can do the same for you, too.

Overview

The KEMET T494 Series is a lower ESR version of the popular T491 Series, designed specifically for today's highly automated surface mount processes and equipment. The T494 combines KEMET's proven solid tantalum technology, acclaimed and respected throughout the world, with the latest in materials, processes and automation, resulting in unsurpassed total performance and value. This product meets or exceeds the requirements of EIA Standard 535BAAC. The T494 standard terminations are available in 100% matte tin and provide

excellent wetting characteristics and compatibility with today's surface mount solder systems. Tin/lead (Sn/Pb) terminations are available upon request for any part number. Gold-plated terminations are also available for use with conductive epoxy attachment processes.

Standard packaging of these devices is tape and reel in accordance with EIA 481-1. This system provides perfect compatibility with all tape-fed placement units.

Benefits

- Meets or exceeds EIA Standard 535BAAC
- Taped and reeled per EIA 481-1
- Symmetrical, compliant terminations
- Optional gold-plated terminations
- Laser-marked case
- 100% surge current test on C, D, E, U, V, X sizes
- Halogen-free epoxy
- Capacitance values of 0.1 μ F to 1,000 μ F
- Tolerances of $\pm 10\%$ and $\pm 20\%$
- Voltage rating of 2.5 – 50 VDC
- Extended range values
- Low profile case sizes
- RoHS Compliant and lead-free terminations
- Operating temperature range of -55°C to +125°C

Applications

Typical applications include decoupling and filtering in industrial and automotive end applications, such as DC/DC converters, portable electronics, telecommunications, and control units.



Environmental Compliance

RoHS Compliant (6/6) according to Directive 2002/95/EC when ordered with 100% Sn Solder



RoHS Compliant

SPICE

For a detailed analysis of specific part numbers, please visit www.kemet.com for a free download of KEMET's SPICE software. The KEMET SPICE program is freeware intended to aid design engineers in analyzing the performance of these capacitors over frequency, temperature, ripple, and DC bias conditions.

Ordering Information

T	494	T	336	M	004	A	T	
Capacitor Class	Series	Case Size	Capacitance Code (pF)	Capacitance Tolerance	Voltage	Failure Rate/Design	Lead Material	Packaging (C-Spec)
T = Tantalum	Industrial - Low ESR	A, B, C, D, E, S, T, U, V, X	First two digits represent significant figures. Third digit specifies number of zeros.	K = ±10% M = ±20%	2R5 = 2.5 V 003 = 3 V 004 = 4 V 006 = 6.3 V 010 = 10 V 016 = 16 V 020 = 20 V 025 = 25 V 035 = 35 V 050 = 50 V	A = N/A	T = 100% Matte Tin (Sn) Plated H = Standard Solder Coated (SnPb 5% Pb minimum) G = Gold Plated (A, B, C, D, X only)	Blank = 7" Reel 7280 = 13" Reel

Performance Characteristics

Item	Performance Characteristics
Operating Temperature	-55°C to 125°C
Rated Capacitance Range	0.1 – 1,000 µF @ 120 Hz/25°C
Capacitance Tolerance	K Tolerance (10%), M Tolerance (20%)
Rated Voltage Range	2.5 – 50 V
DF (120 Hz)	Refer to Part Number Electrical Specification Table
ESR (100 kHz)	Refer to Part Number Electrical Specification Table
Leakage Current	≤ 0.01 CV (µA) at rated voltage after 5 minutes

Qualification

Test	Condition	Characteristics					
Endurance	85°C @ rated voltage, 2,000 hours 125°C @ 2/3 rated voltage, 2,000 hours	Δ C/C	Within ±10% of initial value				
		DF	Within initial limits				
		DCL	Within 1.25 x initial limit				
		ESR	Within initial limits				
Storage Life	125°C @ 0 volts, 2,000 hours	Δ C/C	Within ±10% of initial value				
		DF	Within initial limits				
		DCL	Within 1.25 x initial limit				
		ESR	Within initial limits				
Thermal Shock	MIL-STD-202, Method 107, Condition B, mounted, -55°C to 125°C, 1,000 cycles	Δ C/C	Within ±5% of initial value				
		DF	Within initial limits				
		DCL	Within 1.25 x initial limit				
		ESR	Within initial limits				
Temperature Stability	Extreme temperature exposure at a succession of continuous steps at +25°C, -55°C, +25°C, +85°C, +125°C, +25°C.	+25°C	-55°C	+85°C	+125°C		
		Δ C/C	IL*	±10%	±10%	±20%	
		DF	IL	IL	1.5 x IL	1.5 x IL	
		DCL	IL	n/a	10 x IL	12 x IL	
		Surge Voltage	25°C and 85°C, 1.32 x rated voltage 1,000 cycles (125°C, 1.2 x rated voltage).	Δ C/C	Within ±5% of initial value		
				DF	Within initial limits		
DCL	Within initial limits						
ESR	Within initial limits						
Mechanical Shock/Vibration	MIL-STD-202, Method 213, Condition I, 100 G peak MIL-STD-202, Method 204, Condition D, 10 Hz to 2,000 Hz, 20 G peak	Δ C/C	Within ±10% of initial value				
		DF	Within initial limits				
		DCL	Within initial limits				

*IL = Initial limit

Electrical Characteristics

ESR vs. Frequency

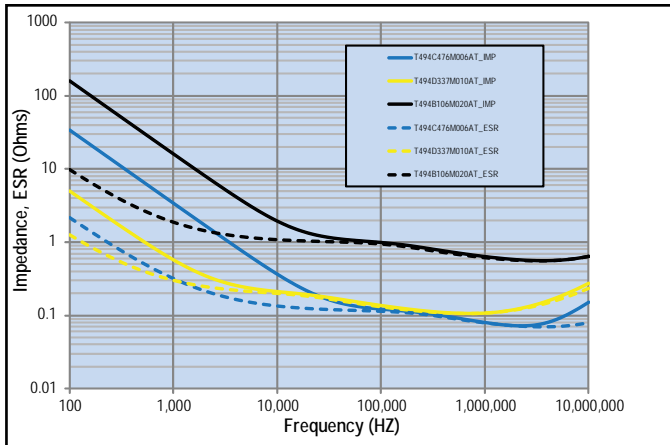

Capacitance vs. Frequency

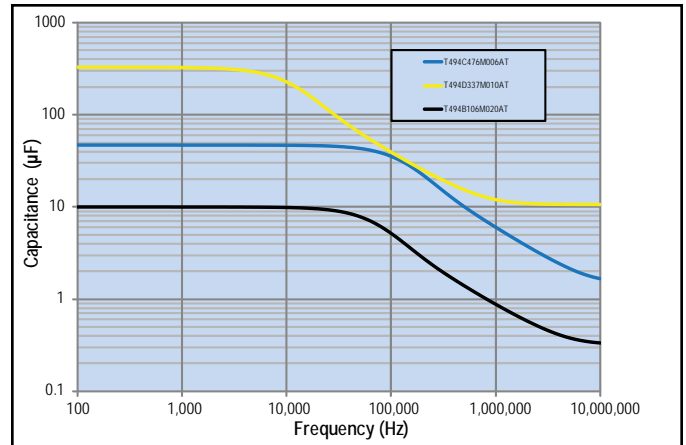

Dimensions – Millimeters (Inches)

Metric will govern

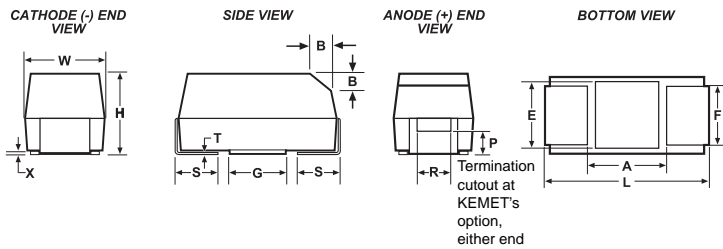

Case Size		Component													
KEMET	EIA	L*	W*	H*	F* ±0.1 ±(.004)	S* ±0.3 ±(.012)	B* ±0.15 (Ref) ±.006	X (Ref)	P (Ref)	R (Ref)	T (Ref)	A (Min)	G (Ref)	E (Ref)	
A	3216-18	3.2 ±0.2 (0.126 ±0.008)	1.6 ±0.2 (0.063 ±0.008)	1.6 ±0.2 (0.063 ±0.008)	1.2 (.047)	0.8 (.031)	0.4 (.016)	0.10 ±0.10 (0.004 ±0.004)	0.4 (.016)	0.4 (.016)	0.13 (.005)	0.8 (.31)	1.1 (.043)	1.3 (.051)	
B	3528-21	3.5 ±0.2 (0.138 ±0.008)	2.8 ±0.2 (0.110 ±0.008)	1.9 ±0.2 (0.075 ±0.008)	2.2 (.087)	0.8 (.031)	0.4 (.016)	0.10 ±0.10 (0.004 ±0.004)	0.5 (.020)	1.0 (.039)	0.13 (.005)	1.1 (0.043)	1.8 (.071)	2.2 (.087)	
C	6032-28	6.0 ±0.3 (0.236 ±0.03)	3.2 ±0.3 (0.126 ±0.012)	2.5 ±0.3 (0.098 ±0.012)	2.2 (.087)	1.3 (.051)	0.5 (.020)	0.10 ±0.10 (0.004 ±0.004)	0.9 (.035)	1.0 (.039)	0.13 (.005)	2.5(.098)	2.8 (.110)	2.4 (.094)	
D	7343-31	7.3 ±0.3 (0.287 ±0.012)	4.3 ±0.3 (0.169 ±0.012)	2.8 ±0.3 (0.110 ±0.012)	2.4 (.094)	1.3 (.051)	0.5 (.020)	0.10 ±0.10 (0.004 ±0.004)	0.9 (.035)	1.0 (.039)	0.13 (.005)	3.8 (.150)	3.5 (.138)	3.5 (.138)	
X	7343-43	7.3 ±0.3 (0.287 ±0.012)	4.3 ±0.3 (0.169 ±0.012)	4.0 ±0.3 (0.157 ±0.012)	2.4 (.094)	1.3 (.051)	0.5 (.020)	0.10 ±0.10 (0.004 ±0.004)	1.7 (.067)	1.0 (.039)	0.13 (.005)	3.8 (.150)	3.5 (.138)	3.5 (.138)	
E	7360-38	7.3 ±0.3 (0.287 ±0.012)	6.0 ±0.3 (0.236 ±0.012)	3.6 ±0.2 (0.142 ±0.008)	4.1 (.161)	1.3 (.051)	0.5 (.020)	0.10 ±0.10 (0.004 ±0.004)	n/a	n/a	0.13 (.005)	3.8 (.150)	3.5 (.138)	3.5 (.138)	
S	3216-12	3.2 ±0.2 (0.126 ±0.008)	1.6 ±0.2 (0.063 ±0.008)	1.2 (.047)	1.2 (.047)	0.8 (.031)	n/a	0.05 (.002)	n/a	n/a	0.13 (.005)	0.8 (.031)	1.1 (.043)	1.3 (.051)	
T	3528-12	3.5 ±0.2 (0.138 ±0.008)	2.8 ±0.2 (0.110 ±0.008)	1.2 (.047)	2.2 (.087)	0.8 (.031)	n/a	0.05 (.002)	n/a	n/a	0.13 (.005)	1.1 (.043)	1.8 (.071)	2.2 (.087)	
U	6032-15	6.0 ±0.3 (0.236 ±0.012)	3.2 ±0.2 (0.110 ±0.008)	1.5 (.059)	2.2 (.087)	1.3 (.051)	n/a	0.05 (.002)	n/a	n/a	0.13 (.005)	2.5(.098)	2.8 (.110)	2.4 (.094)	
V	7343-20	7.3 ±0.3 (0.287 ±0.012)	4.3 ±0.3 (0.169 ±0.012)	2.0 (.079)	2.4 (.094)	1.3 (.051)	n/a	0.05 (.002)	n/a	n/a	0.13 (.005)	3.8 (.150)	3.5 (.138)	3.5 (.138)	

Notes: (Ref) – Dimensions provided for reference only. No dimensions provided for B, P or R because low profile cases do not have a bevel or a notch.

* MIL-PRF-55365/8 specified dimensions

Table 1 – Ratings & Part Number Reference

Rated Voltage	Rated Cap	Case Code/ Case Size	KEMET Part Number	DC Leakage	DF	ESR	Maximum Allowable Ripple Current			Moisture Sensitivity
VDC	µF	KEMET/EIA	(See below for part options)	µA @ 20°C Max/5 Min	% @ 20°C 120 Hz Max	Ω @ 20°C 100 kHz Max	(mA) 100 kHz 25°C	(mA) 100 kHz 85°C	(mA) 100 kHz 125°C	Reflow Temp ≤ 260°C
2.5	100	T/3528-12	T494T107(1)2R5A(2)	2.5	24.0	3.5	141	127	56	1
2.5	220	D/7343-31	T494D227(1)2R5A(2)	5.5	8.0	0.2	866	779	346	1
3	33	A/3216-18	T494A336(1)003A(2)	1.0	6.0	2.0	194	175	78	1
4	3.3	A/3216-18	T494A335(1)004A(2)	0.5	6.0	4.0	137	123	55	1
4	4.7	A/3216-18	T494A475(1)004A(2)	0.5	6.0	3.5	146	131	58	1
4	6.8	A/3216-18	T494A685(1)004A(2)	0.5	6.0	3.0	158	142	63	1
4	6.8	S/3216-12	T494S685(1)004A(2)	0.5	6.0	7.0	93	84	37	1
4	10	B/3528-21	T494B106(1)004A(2)	0.5	6.0	1.2	266	239	106	1
4	10	A/3216-18	T494A106(1)004A(2)	0.5	6.0	2.0	194	175	78	1
4	10	S/3216-12	T494S106(1)004A(2)	0.5	6.0	9.0	82	74	33	1
4	10	R/2012-12	T494R106(M)004A(2)	0.5	8.0	6.0	65	59	26	1
4	15	B/3528-21	T494B156(1)004A(2)	0.6	6.0	1.2	266	239	106	1
4	15	A/3216-18	T494A156(1)004A(2)	0.6	6.0	1.5	224	202	90	1
4	15	T/3528-12	T494T156(1)004A(2)	0.6	6.0	2.0	187	168	75	1
4	15	S/3216-12	T494S156(M)004A(2)	0.6	10.0	9.0	82	74	33	1
4	22	C/6032-28	T494C226(1)004A(2)	0.9	6.0	0.5	469	422	188	1
4	22	B/3528-21	T494B226(1)004A(2)	0.9	6.0	0.6	376	338	150	1
4	22	A/3216-18	T494A226(1)004A(2)	0.9	6.0	1.5	224	202	90	1
4	22	S/3216-12	T494S226(M)004A(2)	0.9	10.0	8.0	87	78	35	1
4	22	T/3528-12	T494T226(1)004A(2)	0.9	6.0	2.5	167	150	67	1
4	33	C/6032-28	T494C336(1)004A(2)	1.3	6.0	0.5	469	422	188	1
4	33	U/6032-15	T494U336(1)004A(2)	1.3	6.0	0.6	387	348	155	1
4	33	B/3528-21	T494B336(1)004A(2)	1.3	6.0	0.5	412	371	165	1
4	33	A/3216-18	T494A336(1)004A(2)	1.3	6.0	3.0	158	142	63	1
4	33	T/3528-12	T494T336(M)004A(2)	1.3	8.0	3.5	141	127	56	1
4	47	C/6032-28	T494C476(1)004A(2)	1.9	6.0	0.5	469	422	188	1
4	47	U/6032-15	T494U476(1)004A(2)	1.9	6.0	0.6	387	348	155	1
4	47	B/3528-21	T494B476(1)004A(2)	1.9	6.0	0.5	412	371	165	1
4	47	A/3216-18	T494A476(M)004A(2)	1.9	12.0	2.0	194	175	78	1
4	47	T/3528-12	T494T476(M)004A(2)	1.9	12.0	4.0	132	119	53	1
4	68	D/7343-31	T494D686(1)004A(2)	2.7	6.0	0.20	866	779	346	1
4	68	C/6032-28	T494C686(1)004A(2)	2.7	6.0	0.25	663	597	265	1
4	68	U/6032-15	T494U686(1)004A(2)	2.7	6.0	0.60	387	348	155	1
4	68	B/3528-21	T494B686(1)004A(2)	2.7	6.0	2.00	206	185	82	1
4	68	A/3216-18	T494A686(1)004A(2)	2.7	30.0	3.00	158	142	63	1
4	100	D/7343-31	T494D107(1)004A(2)	4.0	8.0	0.20	866	779	346	1
4	100	C/6032-28	T494C107(1)004A(2)	4.0	8.0	0.20	742	668	297	1
4	100	U/6032-15	T494U107(1)004A(2)	4.0	10.0	1.00	300	270	120	1
4	100	B/3528-21	T494B107(M)004A(2)	4.0	8.0	0.65	362	326	145	1
4	100	A/3216-18	T494A107(M)004A(2)	4.0	30.0	3.00	158	142	63	1
4	100	T/3528-12	T494T107(M)004A(2)	4.0	30.0	4.50	125	113	50	1
4	150	D/7343-31	T494D157(1)004A(2)	6.0	8.0	0.15	1000	900	400	1
4	150	V/7343-20	T494V157(1)004A(2)	6.0	8.0	0.20	791	712	316	1
4	150	C/6032-28	T494C157(1)004A(2)	6.0	8.0	0.30	606	545	242	1
4	150	B/3528-21	T494B157(M)004A(2)	6.0	12.0	1.00	292	263	117	1
4	220	V/7343-20	T494V227(1)004A(2)	8.8	8.0	0.30	645	581	258	1
4	220	B/3528-21	T494B227(M)004A(2)	8.8	8.0	0.40	461	415	184	1
4	330	D/7343-31	T494D337(1)004A(2)	13.2	8.0	0.15	1000	900	400	1
4	330	C/6032-28	T494C337(1)004A(2)	13.2	10.0	0.09	1106	995	442	1
VDC	µF	KEMET/EIA	(See below for part options)	µA @ 20°C Max/5 Min	% @ 20°C 120 Hz Max	Ω @ 20°C 100 kHz Max	(mA) 100 kHz 25°C	(mA) 100 kHz 85°C	(mA) 100 kHz 125°C	Reflow Temp ≤ 260°C
Rated Voltage	Rated Cap	Case Code/ Case Size	KEMET Part Number	DC Leakage	DF	ESR	Maximum Allowable Ripple Current			Moisture Sensitivity

(1) To complete KEMET part number, insert M for ±20% or K for ±10%. Designates capacitance tolerance.

(2) To complete KEMET part number, insert T = 100% Matte Tin (Sn) Plated, G = Gold Plated, H = Standard Solder coated (SnPb 5% Pb minimum). Designates termination finish.

Refer to Ordering Information for additional detail.

Higher voltage ratings and tighter tolerance product including ESR may be substituted within the same size at KEMET's option. Voltage substitution will be marked with the higher voltage rating. Substitutions can include better than series.

Table 1 – Ratings & Part Number Reference cont'd

Rated Voltage	Rated Cap	Case Code/ Case Size	KEMET Part Number	DC Leakage	DF	ESR	Maximum Allowable Ripple Current			Moisture Sensitivity
VDC	μF	KEMET/EIA	(See below for part options)	μA @ 20°C Max/5 Min	% @ 20°C 120 Hz Max	Ω @ 20°C 100 kHz Max	(mA) 100 kHz 25°C	(mA) 100 kHz 85°C	(mA) 100 kHz 125°C	Reflow Temp ≤ 260°C
4	330	V/7343-20	T494V337(1)004A(2)	13.2	12.0	0.30	645	581	258	1
4	470	X/7343-43	T494X477(1)004A(2)	18.8	8.0	0.15	1049	944	420	1
4	470	D/7343-31	T494D477(1)004A(2)	18.8	8.0	0.15	1000	900	400	1
4	680	X/7343-43	T494X687(M)004A(2)	27.2	12.0	0.10	1285	1157	514	1
4	680	D/7343-31	T494D687(M)004A(2)	27.2	12.0	0.15	1000	900	400	1
4	1000	X/7343-43	T494X108(1)004A(2)	40.0	12.0	0.10	1285	1157	514	1
4	1000	E/7360-38	T494E108(M)004A(2)	40.0	15.0	0.08	1581	1423	632	1
6.3	2.2	R/2012-12	T494R225(1)006A(2)	0.5	6.0	20.0	35	32	14	1
6.3	2.2	A/3216-18	T494A225(1)006A(2)	0.5	6.0	6.0	112	101	45	1
6.3	3.3	A/3216-18	T494A335(1)006A(2)	0.5	6.0	6.0	112	101	45	1
6.3	4.7	A/3216-18	T494A475(1)006A(2)	0.5	6.0	3.5	146	131	58	1
6.3	4.7	S/3216-12	T494S475(1)006A(2)	0.5	6.0	8.0	87	78	35	1
6.3	6.8	B/3528-21	T494B685(1)006A(2)	0.5	6.0	1.2	266	239	106	1
6.3	6.8	A/3216-18	T494A685(1)006A(2)	0.5	6.0	2.0	194	175	78	1
6.3	6.8	S/3216-12	T494S685(1)006A(2)	0.5	6.0	9.0	82	74	33	1
6.3	6.8	R/2012-12	T494R685(1)006A(2)	0.5	8.0	10.0	50	45	20	1
6.3	10	B/3528-21	T494B106(1)006A(2)	0.6	6.0	1.0	292	263	117	1
6.3	10	A/3216-18	T494A106(1)006A(2)	0.6	6.0	2.0	194	175	78	1
6.3	10	T/3528-12	T494T106(1)006A(2)	0.6	6.0	1.2	242	218	97	1
6.3	10	S/3216-12	T494S106(M)006A(2)	0.6	10.0	9.0	82	74	33	1
6.3	10	R/2012-12	T494R106(M)006A(2)	0.6	8.0	6.0	65	59	26	1
6.3	15	C/6032-28	T494C156(1)006A(2)	0.9	6.0	0.6	428	385	171	1
6.3	15	B/3528-21	T494B156(1)006A(2)	0.9	6.0	0.7	348	313	139	1
6.3	15	A/3216-18	T494A156(1)006A(2)	0.9	6.0	2.0	194	175	78	1
6.3	15	T/3528-12	T494T156(1)006A(2)	0.9	6.0	2.5	167	150	67	1
6.3	15	S/3216-12	T494S156(M)006A(2)	0.9	10.0	10.0	77	69	31	1
6.3	22	C/6032-28	T494C226(1)006A(2)	1.4	6.0	0.5	469	422	188	1
6.3	22	U/6032-15	T494U226(1)006A(2)	1.4	6.0	0.8	335	302	134	1
6.3	22	B/3528-21	T494B226(1)006A(2)	1.4	6.0	0.6	376	338	150	1
6.3	22	A/3216-18	T494A226(1)006A(2)	1.4	6.0	3.0	158	142	63	1
6.3	22	T/3528-12	T494T226(M)006A(2)	1.4	8.0	3.5	141	127	56	1
6.3	33	C/6032-28	T494C336(1)006A(2)	2.1	6.0	0.3	606	545	242	1
6.3	33	U/6032-15	T494U336(1)006A(2)	2.1	6.0	0.6	387	348	155	1
6.3	33	B/3528-21	T494B336(1)006A(2)	2.1	6.0	0.6	376	338	150	1
6.3	33	A/3216-18	T494A336(1)006A(2)	2.1	12.0	2.0	194	175	78	1
6.3	33	T/3528-12	T494T336(M)006A(2)	2.1	12.0	4.0	132	119	53	1
6.3	47	D/7343-31	T494D476(1)006A(2)	3.0	6.0	0.22	826	743	330	1
6.3	47	C/6032-28	T494C476(1)006A(2)	3.0	6.0	0.25	663	597	265	1
6.3	47	U/6032-15	T494U476(1)006A(2)	3.0	6.0	0.60	387	348	155	1
6.3	47	B/3528-21	T494B476(1)006A(2)	3.0	6.0	0.50	412	371	165	1
6.3	47	A/3216-18	T494A476(M)006A(2)	3.0	12.0	2.50	173	156	69	1
6.3	47	T/3528-12	T494T476(1)006A(2)	3.0	24.0	4.00	132	119	53	1
6.3	68	D/7343-31	T494D686(1)006A(2)	4.3	6.0	0.20	866	779	346	1
6.3	68	C/6032-28	T494C686(1)006A(2)	4.3	6.0	0.20	742	668	297	1
6.3	68	U/6032-15	T494U686(1)006A(2)	4.3	10.0	1.00	300	270	120	1
6.3	68	B/3528-21	T494B686(M)006A(2)	4.3	8.0	0.65	362	326	145	1
6.3	68	A/3216-18	T494A686(1)006A(2)	4.3	30.0	3.00	158	142	63	1
6.3	100	D/7343-31	T494D107(1)006A(2)	6.3	8.0	0.15	1000	900	400	1
6.3	100	V/7343-20	T494V107(1)006A(2)	6.3	8.0	0.20	791	712	316	1
6.3	100	C/6032-28	T494C107(1)006A(2)	6.3	8.0	0.30	606	545	242	1
VDC	μF	KEMET/EIA	(See below for part options)	μA @ 20°C Max/5 Min	% @ 20°C 120 Hz Max	Ω @ 20°C 100 kHz Max	(mA) 100 kHz 25°C	(mA) 100 kHz 85°C	(mA) 100 kHz 125°C	Reflow Temp ≤ 260°C
Rated Voltage	Rated Cap	Case Code/ Case Size	KEMET Part Number	DC Leakage	DF	ESR	Maximum Allowable Ripple Current			Moisture Sensitivity

(1) To complete KEMET part number, insert M for ±20% or K for ±10%. Designates capacitance tolerance.

(2) To complete KEMET part number, insert T = 100% Matte Tin (Sn) Plated, G = Gold Plated, H = Standard Solder coated (SnPb 5% Pb minimum). Designates termination finish.

Refer to Ordering Information for additional detail.

Higher voltage ratings and tighter tolerance product including ESR may be substituted within the same size at KEMET's option. Voltage substitution will be marked with the higher voltage rating. Substitutions can include better than series.

Table 1 – Ratings & Part Number Reference cont'd

Rated Voltage	Rated Cap	Case Code/ Case Size	KEMET Part Number	DC Leakage	DF	ESR	Maximum Allowable Ripple Current			Moisture Sensitivity
VDC	μF	KEMET/EIA	(See below for part options)	μA @ 20°C Max/5 Min	% @ 20°C 120 Hz Max	Ω @ 20°C 100 kHz Max	(mA) 100 kHz 25°C	(mA) 100 kHz 85°C	(mA) 100 kHz 125°C	Reflow Temp ≤ 260°C
6.3	100	U/6032-15	T494U107(M)006A(2)	6.3	10.0	1.20	274	247	110	1
6.3	100	B/3528-21	T494B107(1)006A(2)	6.3	15.0	1.50	238	214	95	1
6.3	150	B/3528-21	T494B157M006A(2)	9.5	15.0	2.25	194	175	78	1
6.3	150	D/7343-31	T494D157(1)006A(2)	9.5	8.0	0.15	1000	900	400	1
6.3	150	C/6032-28	T494C157(M)006A(2)	9.5	8.0	0.30	606	545	242	1
6.3	150	V/7343-20	T494V157(1)006A(2)	9.5	8.0	0.30	645	581	258	1
6.3	220	X/7343-43	T494X227(1)006A(2)	13.9	8.0	0.15	1049	944	420	1
6.3	220	D/7343-31	T494D227(1)006A(2)	13.9	8.0	0.15	1000	900	400	1
6.3	220	C/6032-28	T494C227(M)006A(2)	13.9	10.0	0.30	606	545	242	1
6.3	220	V/7343-20	T494V227(M)006A(2)	13.9	12.0	0.30	645	581	258	1
6.3	330	X/7343-43	T494X337(1)006A(2)	20.8	8.0	0.15	1049	944	420	1
6.3	330	D/7343-31	T494D337(1)006A(2)	20.8	8.0	0.15	1000	900	400	1
6.3	330	E/7360-38	T494E337(1)006A(2)	20.8	8.0	0.25	894	805	358	1
6.3	470	X/7343-43	T494X477(1)006A(2)	29.6	10.0	0.10	1285	1157	514	1
6.3	470	D/7343-31	T494D477(M)006A(2)	29.6	12.0	0.15	1000	900	400	1
6.3	470	E/7360-38	T494E477(1)006A(2)	29.6	10.0	0.20	1000	900	400	1
6.3	680	E/7360-38	T494E687(M)006A(2)	42.8	12.0	0.10	1414	1273	566	1
6.3	680	X/7343-43	T494X687(1)006A(2)	42.8	12.0	0.10	1285	1157	514	1
10	1.5	A/3216-18	T494A155(1)010A(2)	0.5	6.0	6.0	112	101	45	1
10	2.2	B/3528-21	T494B225(1)010A(2)	0.5	6.0	1.5	238	214	95	1
10	2.2	A/3216-18	T494A225(1)010A(2)	0.5	6.0	6.0	112	101	45	1
10	3.3	A/3216-18	T494A335(1)010A(2)	0.5	6.0	4.0	137	123	55	1
10	3.3	S/3216-12	T494S335(1)010A(2)	0.5	6.0	9.0	82	74	33	1
10	3.3	R/2012-12	T494R335(1)010A(2)	0.5	8.0	10.0	50	45	20	1
10	4.7	B/3528-21	T494B475(1)010A(2)	0.5	6.0	1.5	238	214	95	1
10	4.7	A/3216-18	T494A475(1)010A(2)	0.5	6.0	3.0	158	142	63	1
10	4.7	S/3216-12	T494S475(1)010A(2)	0.5	6.0	9.0	82	74	33	1
10	4.7	R/2012-12	T494R475(M)010A(2)	0.5	8.0	8.0	56	50	22	1
10	6.8	B/3528-21	T494B685(1)010A(2)	0.7	6.0	1.2	266	239	106	1
10	6.8	A/3216-18	T494A685(1)010A(2)	0.7	6.0	3.0	158	142	63	1
10	6.8	T/3528-12	T494T685(1)010A(2)	0.7	6.0	2.0	187	168	75	1
10	6.8	S/3216-12	T494S685(M)010A(2)	0.7	10.0	9.0	82	74	33	1
10	10	C/6032-28	T494C106(1)010A(2)	1.0	6.0	0.6	428	385	171	1
10	10	B/3528-21	T494B106(1)010A(2)	1.0	6.0	0.8	326	293	130	1
10	10	A/3216-18	T494A106(1)010A(2)	1.0	6.0	1.8	204	184	82	1
10	10	T/3528-12	T494T106(1)010A(2)	1.0	6.0	3.5	141	127	56	1
10	10	S/3216-12	T494S106(M)010A(2)	1.0	10.0	12.0	71	64	28	1
10	10	R/2012-12	T494R106(M)010A(2)	1.0	24.0	25.0	32	29	13	1
10	15	C/6032-28	T494C156(1)010A(2)	1.5	6.0	0.5	469	422	188	1
10	15	U/6032-15	T494U156(1)010A(2)	1.5	6.0	0.8	335	302	134	1
10	15	B/3528-21	T494B156(1)010A(2)	1.5	6.0	0.7	348	313	139	1
10	15	A/3216-18	T494A156(1)010A(2)	1.5	8.0	4.0	137	123	55	1
10	15	T/3528-12	T494T156(M)010A(2)	1.5	8.0	3.5	141	127	56	1
10	22	C/6032-28	T494C226(1)010A(2)	2.2	6.0	0.4	524	472	210	1
10	22	U/6032-15	T494U226(1)010A(2)	2.2	6.0	0.8	335	302	134	1
10	22	B/3528-21	T494B226(1)010A(2)	2.2	6.0	0.7	348	313	139	1
10	22	A/3216-18	T494A226(M)010A(2)	2.2	10.0	4.5	129	116	52	1
10	22	T/3528-12	T494T226(M)010A(2)	2.2	12.0	6.0	108	97	43	1
10	33	D/7343-31	T494D336(1)010A(2)	3.3	6.0	0.25	775	698	310	1
10	33	V/7343-20	T494V336(1)010A(2)	3.3	6.0	0.30	645	581	258	1
VDC	μF	KEMET/EIA	(See below for part options)	μA @ 20°C Max/5 Min	% @ 20°C 120 Hz Max	Ω @ 20°C 100 kHz Max	(mA) 100 kHz 25°C	(mA) 100 kHz 85°C	(mA) 100 kHz 125°C	Reflow Temp ≤ 260°C
Rated Voltage	Rated Cap	Case Code/ Case Size	KEMET Part Number	DC Leakage	DF	ESR	Maximum Allowable Ripple Current			Moisture Sensitivity

(1) To complete KEMET part number, insert M for ±20% or K for ±10%. Designates capacitance tolerance.

(2) To complete KEMET part number, insert T = 100% Matte Tin (Sn) Plated, G = Gold Plated, H = Standard Solder coated (SnPb 5% Pb minimum). Designates termination finish.

Refer to Ordering Information for additional detail.

Higher voltage ratings and tighter tolerance product including ESR may be substituted within the same size at KEMET's option. Voltage substitution will be marked with the higher voltage rating. Substitutions can include better than series.

Table 1 – Ratings & Part Number Reference cont'd

Rated Voltage	Rated Cap	Case Code/ Case Size	KEMET Part Number	DC Leakage	DF	ESR	Maximum Allowable Ripple Current			Moisture Sensitivity
VDC	µF	KEMET/EIA	(See below for part options)	µA @ 20°C Max/5 Min	% @ 20°C 120 Hz Max	Ω @ 20°C 100 kHz Max	(mA) 100 kHz 25°C	(mA) 100 kHz 85°C	(mA) 100 kHz 125°C	Reflow Temp ≤ 260°C
10	33	C/6032-28	T494C336(1)010A(2)	3.3	6.0	0.30	606	545	242	1
10	33	U/6032-15	T494U336(1)010A(2)	3.3	6.0	0.60	387	348	155	1
10	33	T/3528-12	T494T336(1)010A(2)	3.3	24.0	3.75	137	123	55	1
10	33	B/3528-21	T494B336(1)010A(2)	3.3	6.0	1.40	246	221	98	1
10	33	A/3216-18	T494A336(1)010A(2)	3.3	15.0	4.00	137	123	55	1
10	47	D/7343-31	T494D476(1)010A(2)	4.7	6.0	0.22	826	743	330	1
10	47	V/7343-20	T494V476(1)010A(2)	4.7	6.0	0.30	645	581	258	1
10	47	C/6032-28	T494C476(1)010A(2)	4.7	6.0	0.30	606	545	242	1
10	47	U/6032-15	T494U476(1)010A(2)	4.7	10.0	1.20	274	247	110	1
10	47	B/3528-21	T494B476(M)010A(2)	4.7	8.0	0.65	362	326	145	1
10	68	D/7343-31	T494D686(1)010A(2)	6.8	6.0	0.20	866	779	346	1
10	68	C/6032-28	T494C686(1)010A(2)	6.8	6.0	0.30	606	545	242	1
10	68	V/7343-20	T494V686(1)010A(2)	6.8	6.0	0.30	645	581	258	1
10	68	U/6032-15	T494U686(M)010A(2)	6.8	10.0	1.20	274	247	110	1
10	68	B/3528-21	T494B686(M)010A(2)	6.8	10.0	1.50	238	214	95	1
10	100	D/7343-31	T494D107(1)010A(2)	10.0	8.0	0.15	1000	900	400	1
10	100	C/6032-28	T494C107(1)010A(2)	10.0	8.0	0.20	742	668	297	1
10	100	V/7343-20	T494V107(1)010A(2)	10.0	8.0	0.40	559	503	224	1
10	150	X/7343-43	T494X157(1)010A(2)	15.0	8.0	0.15	1049	944	420	1
10	150	D/7343-31	T494D157(1)010A(2)	15.0	8.0	0.15	1000	900	400	1
10	150	C/6032-28	T494C157(1)010A(2)	15.0	10.0	0.70	396	356	158	1
10	150	V/7343-20	T494V157(M)010A(2)	15.0	8.0	0.30	645	581	258	1
10	220	X/7343-43	T494X227(1)010A(2)	22.0	8.0	0.15	1049	944	420	1
10	220	D/7343-31	T494D227(1)010A(2)	22.0	8.0	0.15	1000	900	400	1
10	330	X/7343-43	T494X337(1)010A(2)	33.0	10.0	0.10	1285	1157	514	1
10	330	D/7343-31	T494D337(M)010A(2)	33.0	10.0	0.15	1000	900	400	1
10	330	E/7360-38	T494E337(1)010A(2)	33.0	10.0	0.25	894	805	358	1
10	470	X/7343-43	T494X477(1)010A(2)	47.0	10.0	0.10	1285	1157	514	1
10	470	E/7360-38	T494E477(M)010A(2)	47.0	12.0	0.10	1414	1273	566	1
16	1	A/3216-18	T494A105(1)016A(2)	0.5	4.0	6.0	112	101	45	1
16	1.5	A/3216-18	T494A155(1)016A(2)	0.5	6.0	6.0	112	101	45	1
16	2.2	A/3216-18	T494A225(1)016A(2)	0.5	6.0	4.0	137	123	55	1
16	2.2	S/3216-12	T494S225(1)016A(2)	0.5	6.0	10.0	77	69	31	1
16	2.2	R/2012-12	T494R225(1)016A(2)	0.5	8.0	20.0	35	32	14	1
16	3.3	B/3528-21	T494B335(1)016A(2)	0.5	6.0	2.0	206	185	82	1
16	3.3	A/3216-18	T494A335(1)016A(2)	0.5	6.0	4.0	137	123	55	1
16	4.7	B/3528-21	T494B475(1)016A(2)	0.8	6.0	1.5	238	214	95	1
16	4.7	A/3216-18	T494A475(1)016A(2)	0.8	6.0	3.0	158	142	63	1
16	4.7	T/3528-12	T494T475(1)016A(2)	0.8	6.0	3.0	153	138	61	1
16	6.8	C/6032-28	T494C685(1)016A(2)	1.1	6.0	0.8	371	334	148	1
16	6.8	B/3528-21	T494B685(1)016A(2)	1.1	6.0	1.2	266	239	106	1
16	6.8	A/3216-18	T494A685(1)016A(2)	1.1	6.0	3.0	158	142	63	1
16	10	C/6032-28	T494C106(1)016A(2)	1.6	6.0	0.6	428	385	171	1
16	10	U/6032-15	T494U106(1)016A(2)	1.6	6.0	1.0	300	270	120	1
16	10	B/3528-21	T494B106(1)016A(2)	1.6	6.0	0.8	326	293	130	1
16	10	A/3216-18	T494A106(1)016A(2)	1.6	8.0	3.0	158	142	63	1
16	10	T/3528-12	T494T106(1)016A(2)	1.6	8.0	6.0	108	97	43	1
16	15	C/6032-28	T494C156(1)016A(2)	2.4	6.0	0.4	524	472	210	1
16	15	U/6032-15	T494U156(1)016A(2)	2.4	6.0	0.8	335	302	134	1
16	15	B/3528-21	T494B156(1)016A(2)	2.4	6.0	0.8	326	293	130	1
VDC	µF	KEMET/EIA	(See below for part options)	µA @ 20°C Max/5 Min	% @ 20°C 120 Hz Max	Ω @ 20°C 100 kHz Max	(mA) 100 kHz 25°C	(mA) 100 kHz 85°C	(mA) 100 kHz 125°C	Reflow Temp ≤ 260°C
Rated Voltage	Rated Cap	Case Code/ Case Size	KEMET Part Number	DC Leakage	DF	ESR	Maximum Allowable Ripple Current			Moisture Sensitivity

(1) To complete KEMET part number, insert M for ±20% or K for ±10%. Designates capacitance tolerance.

(2) To complete KEMET part number, insert T = 100% Matte Tin (Sn) Plated, G = Gold Plated, H = Standard Solder coated (SnPb 5% Pb minimum). Designates termination finish.

Refer to Ordering Information for additional detail.

Higher voltage ratings and tighter tolerance product including ESR may be substituted within the same size at KEMET's option. Voltage substitution will be marked with the higher voltage rating. Substitutions can include better than series.

Table 1 – Ratings & Part Number Reference cont'd

Rated Voltage	Rated Cap	Case Code/ Case Size	KEMET Part Number	DC Leakage	DF	ESR	Maximum Allowable Ripple Current			Moisture Sensitivity
VDC	μF	KEMET/EIA	(See below for part options)	μA @ 20°C Max/5 Min	% @ 20°C 120 Hz Max	Ω @ 20°C 100 kHz Max	(mA) 100 kHz 25°C	(mA) 100 kHz 85°C	(mA) 100 kHz 125°C	Reflow Temp ≤ 260°C
16	22	D/7343-31	T494D226(1)016A(2)	3.5	6.0	0.25	775	698	310	1
16	22	C/6032-28	T494C226(1)016A(2)	3.5	6.0	0.35	561	505	224	1
16	22	U/6032-15	T494U226(1)016A(2)	3.5	10.0	1.80	224	202	90	1
16	22	B/3528-21	T494B226(1)016A(2)	3.5	6.0	1.00	292	263	117	1
16	33	D/7343-31	T494D336(1)016A(2)	5.3	6.0	0.25	775	698	310	1
16	33	C/6032-28	T494C336(1)016A(2)	5.3	6.0	0.30	606	545	242	1
16	33	U/6032-15	T494U336(1)016A(2)	5.3	12.0	2.20	202	182	81	1
16	33	B/3528-21	T494B336(1)016A(2)	5.3	8.0	1.20	266	239	106	1
16	47	D/7343-31	T494D476(1)016A(2)	7.5	6.0	0.2	866	779	346	1
16	47	V/7343-20	T494V476(1)016A(2)	7.5	6.0	0.3	645	581	258	1
16	47	C/6032-28	T494C476(1)016A(2)	7.5	6.0	0.5	469	422	188	1
16	68	D/7343-31	T494D686(1)016A(2)	10.9	6.0	0.15	1000	900	400	1
16	68	V/7343-20	T494V686(1)016A(2)	10.9	6.0	0.5	500	450	200	1
16	68	C/6032-28	T494C686(1)016A(2)	10.9	12.0	1.0	332	299	133	1
16	100	X/7343-43	T494X107(1)016A(2)	16.0	8.0	0.15	1049	944	420	1
16	100	D/7343-31	T494D107(1)016A(2)	16.0	8.0	0.15	1000	900	400	1
16	100	V/7343-20	T494V107(1)016A(2)	16.0	12.0	0.5	500	450	200	1
16	150	X/7343-43	T494X157(1)016A(2)	24.0	8.0	0.15	1049	944	420	1
16	150	D/7343-31	T494D157(1)016A(2)	24.0	12.0	0.4	612	551	245	1
16	220	X/7343-43	T494X227(1)016A(2)	35.2	10.0	0.4	642	578	257	1
16	220	E/7360-38	T494E227(1)016A(2)	35.2	7.2	0.5	632	569	253	1
20	0.68	A/3216-18	T494A684(1)020A(2)	0.5	4.0	8.0	97	87	39	1
20	1	A/3216-18	T494A105(1)020A(2)	0.5	4.0	5.5	117	105	47	1
20	1	S/3216-12	T494S105(1)020A(2)	0.5	6.0	10.0	77	69	31	1
20	1	R/2012-12	T494R105(1)020A(2)	0.5	6.0	15.0	41	37	16	1
20	1.5	A/3216-18	T494A155(1)020AS(2)	0.5	6.0	4.5	129	116	52	1
20	1.5	S/3216-12	T494S155(1)020A(2)	0.5	6.0	9.0	82	74	33	1
20	2.2	B/3528-21	T494B225(1)020A(2)	0.5	6.0	1.5	238	214	95	1
20	2.2	A/3216-18	T494A225(1)020A(2)	0.5	6.0	4.0	137	123	55	1
20	2.2	R/2012-12	T494R225(1)020A(2)	0.5	8.0	6.0	65	59	26	1
20	3.3	B/3528-21	T494B335(1)020A(2)	0.7	6.0	1.3	256	230	102	1
20	3.3	A/3216-18	T494A335(1)020A(2)	0.7	6.0	4.0	137	123	55	1
20	3.3	T/3528-12	T494T335(1)020A(2)	0.7	6.0	4.0	132	119	53	1
20	4.7	C/6032-28	T494C475(1)020A(2)	0.9	6.0	0.6	428	385	171	1
20	4.7	B/3528-21	T494B475(1)020A(2)	0.9	6.0	1.0	292	263	117	1
20	4.7	A/3216-18	T494A475(1)020A(2)	0.9	6.0	3.0	158	142	63	1
20	6.8	C/6032-28	T494C685(1)020A(2)	1.4	6.0	0.6	428	385	171	1
20	6.8	U/6032-15	T494U685(1)020A(2)	1.4	6.0	1.4	254	229	102	1
20	6.8	B/3528-21	T494B685(1)020A(2)	1.4	6.0	1.0	292	263	117	1
20	6.8	A/3216-18	T494A685(M)020A(2)	1.4	8.0	3.0	158	142	63	1
20	10	C/6032-28	T494C106(1)020A(2)	2.0	6.0	0.5	469	422	188	1
20	10	U/6032-15	T494U106(1)020A(2)	2.0	6.0	0.8	335	302	134	1
20	10	B/3528-21	T494B106(1)020A(2)	2.0	6.0	1.0	292	263	117	1
20	10	A/3216-18	T494A106(M)020A(2)	2.0	10.0	3.0	158	142	63	1
20	15	D/7343-31	T494D156(1)020A(2)	3.0	6.0	0.35	655	590	262	1
20	15	C/6032-28	T494C156(1)020A(2)	3.0	6.0	0.40	524	472	210	1
20	22	D/7343-31	T494D226(1)020A(2)	4.4	6.0	0.3	707	636	283	1
20	22	V/7343-20	T494V226(1)020A(2)	4.4	6.0	0.4	559	503	224	1
20	22	C/6032-28	T494C226(1)020A(2)	4.4	6.0	0.4	524	472	210	1
20	22	B/3528-21	T494B226(1)020A(2)	4.4	8.0	3.0	168	151	67	1
VDC	μF	KEMET/EIA	(See below for part options)	μA @ 20°C Max/5 Min	% @ 20°C 120 Hz Max	Ω @ 20°C 100 kHz Max	(mA) 100 kHz 25°C	(mA) 100 kHz 85°C	(mA) 100 kHz 125°C	Reflow Temp ≤ 260°C
Rated Voltage	Rated Cap	Case Code/ Case Size	KEMET Part Number	DC Leakage	DF	ESR	Maximum Allowable Ripple Current			Moisture Sensitivity

(1) To complete KEMET part number, insert M for ±20% or K for ±10%. Designates capacitance tolerance.

(2) To complete KEMET part number, insert T = 100% Matte Tin (Sn) Plated, G = Gold Plated, H = Standard Solder coated (SnPb 5% Pb minimum). Designates termination finish.

Refer to Ordering Information for additional detail.

Higher voltage ratings and tighter tolerance product including ESR may be substituted within the same size at KEMET's option. Voltage substitution will be marked with the higher voltage rating. Substitutions can include better than series.

Table 1 – Ratings & Part Number Reference cont'd

Rated Voltage	Rated Cap	Case Code/ Case Size	KEMET Part Number	DC Leakage	DF	ESR	Maximum Allowable Ripple Current			Moisture Sensitivity
VDC	µF	KEMET/EIA	(See below for part options)	µA @ 20°C Max/5 Min	% @ 20°C 120 Hz Max	Ω @ 20°C 100 kHz Max	(mA) 100 kHz 25°C	(mA) 100 kHz 85°C	(mA) 100 kHz 125°C	Reflow Temp ≤ 260°C
20	33	D/7343-31	T494D336(1)020A(2)	6.6	6.0	0.25	775	698	310	1
20	33	C/6032-28	T494C336(M)020A(2)	6.6	6.0	0.40	524	472	210	1
20	33	V/7343-20	T494V336(1)020A(2)	6.6	8.0	0.40	559	503	224	1
20	33	B/3528-21	T494B336(M)020A(2)	6.6	10.0	3.00	168	151	67	1
20	47	C/6032-28	T494C476(M)020A(2)	9.4	10.0	0.80	371	334	148	1
20	47	D/7343-31	T494D476(1)020A(2)	9.4	6.0	0.20	866	779	346	1
20	68	X/7343-43	T494X686(1)020A(2)	13.6	6.0	0.20	908	817	363	1
20	68	D/7343-31	T494D686(1)020A(2)	13.6	8.0	0.20	866	779	346	1
20	100	D/7343-31	T494D107(1)020A(2)	20.0	6.0	0.68	471	424	188	1
20	100	X/7343-43	T494X107(1)020A(2)	20.0	8.0	0.15	1049	944	420	1
20	100	E/7360-38	T494E107(1)020A(2)	20.0	8.0	0.30	816	734	326	1
20	150	X/7343-43	T494X157(1)020A(2)	30.0	10.0	0.30	742	668	297	1
25	0.33	A/3216-18	T494A334(1)025A(2)	0.5	4.0	10.0	87	78	35	1
25	0.47	A/3216-18	T494A474(1)025A(2)	0.5	4.0	9.0	91	82	36	1
25	0.68	A/3216-18	T494A684(1)025A(2)	0.5	4.0	6.0	112	101	45	1
25	1	B/3528-21	T494B105(1)025A(2)	0.5	4.0	2.0	206	185	82	1
25	1	A/3216-18	T494A105(1)025A(2)	0.5	4.0	4.0	137	123	55	1
25	1.5	B/3528-21	T494B155(1)025A(2)	0.5	6.0	1.5	238	214	95	1
25	1.5	A/3216-18	T494A155(1)025A(2)	0.5	6.0	3.0	158	142	63	1
25	1.5	R/2012-12	T494R155(1)025A(2)	0.5	8.0	6.0	65	59	26	1
25	2.2	C/6032-28	T494C225(1)025A(2)	0.6	6.0	2.2	224	202	90	1
25	2.2	B/3528-21	T494B225(1)025A(2)	0.6	6.0	1.2	266	239	106	1
25	2.2	A/3216-18	T494A225(1)025A(2)	0.6	6.0	3.0	158	142	63	1
25	3.3	C/6032-28	T494C335(1)025A(2)	0.8	6.0	1.2	303	273	121	1
25	3.3	B/3528-21	T494B335(1)025A(2)	0.8	6.0	2.0	206	185	82	1
25	3.3	A/3216-18	T494A335(1)025A(2)	0.8	6.0	3.0	158	142	63	1
25	4.7	C/6032-28	T494C475(1)025A(2)	1.2	6.0	0.6	428	385	171	1
25	4.7	B/3528-21	T494B475(1)025A(2)	1.2	6.0	1.0	292	263	117	1
25	4.7	A/3216-18	T494A475(M)025A(2)	1.2	8.0	3.0	158	142	63	1
25	6.8	C/6032-28	T494C685(1)025A(2)	1.7	6.0	0.6	428	385	171	1
25	6.8	B/3528-21	T494B685(1)025A(2)	1.7	8.0	2.0	206	185	82	1
25	10	D/7343-31	T494D106(1)025A(2)	2.5	6.0	0.4	612	551	245	1
25	10	C/6032-28	T494C106(1)025A(2)	2.5	6.0	0.6	428	385	171	1
25	10	B/3528-21	T494B106(1)025A(2)	2.5	8.0	3.0	168	151	67	1
25	15	D/7343-31	T494D156(1)025A(2)	3.8	6.0	0.35	655	590	262	1
25	15	C/6032-28	T494C156(1)025A(2)	3.8	6.0	0.90	350	315	140	1
25	15	B/3528-21	T494B156(1)025A(2)	3.8	8.0	3.00	168	151	67	1
25	22	D/7343-31	T494D226(1)025A(2)	5.5	6.0	0.3	707	636	283	1
25	22	C/6032-28	T494C226(1)025A(2)	5.5	6.0	1.0	332	299	133	1
25	22	V/7343-20	T494V226(1)025A(2)	5.5	6.0	0.5	500	450	200	1
25	33	X/7343-43	T494X336(1)025A(2)	8.3	6.0	0.3	742	668	297	1
25	33	D/7343-31	T494D336(1)025A(2)	8.3	6.0	0.4	612	551	245	1
25	33	C/6032-28	T494C336(1)025A(2)	8.3	10.0	1.0	332	299	133	1
25	47	X/7343-43	T494X476(1)025A(2)	11.8	6.0	0.3	742	668	297	1
25	47	D/7343-31	T494D476(1)025A(2)	11.8	10.0	0.2	866	779	346	1
25	68	X/7343-43	T494X686(M)025A(2)	17.0	8.0	0.3	742	668	297	1
25	68	D/7343-31	T494D686(M)025A(2)	17.0	10.0	0.5	548	493	219	1
25	100	X/7343-43	T494X107(M)025A(2)	25.0	8.0	0.25	812	731	325	1
35	0.1	A/3216-18	T494A104(1)035A(2)	0.5	4.0	10.0	87	78	35	1
VDC	µF	KEMET/EIA	(See below for part options)	µA @ 20°C Max/5 Min	% @ 20°C 120 Hz Max	Ω @ 20°C 100 kHz Max	(mA) 100 kHz 25°C	(mA) 100 kHz 85°C	(mA) 100 kHz 125°C	Reflow Temp ≤ 260°C
Rated Voltage	Rated Cap	Case Code/ Case Size	KEMET Part Number	DC Leakage	DF	ESR	Maximum Allowable Ripple Current			Moisture Sensitivity

(1) To complete KEMET part number, insert M for ±20% or K for ±10%. Designates capacitance tolerance.

(2) To complete KEMET part number, insert T = 100% Matte Tin (Sn) Plated, G = Gold Plated, H = Standard Solder coated (SnPb 5% Pb minimum). Designates termination finish.

Refer to Ordering Information for additional detail.

Higher voltage ratings and tighter tolerance product including ESR may be substituted within the same size at KEMET's option. Voltage substitution will be marked with the higher voltage rating. Substitutions can include better than series.

Table 1 – Ratings & Part Number Reference cont'd

Rated Voltage	Rated Cap	Case Code/ Case Size	KEMET Part Number	DC Leakage	DF	ESR	Maximum Allowable Ripple Current			Moisture Sensitivity
VDC	µF	KEMET/EIA	(See below for part options)	µA @ 20°C Max/5 Min	% @ 20°C 120 Hz Max	Ω @ 20°C 100 kHz Max	(mA) 100 kHz 25°C	(mA) 100 kHz 85°C	(mA) 100 kHz 125°C	Reflow Temp ≤ 260°C
35	0.15	A/3216-18	T494A154(1)035A(2)	0.5	4.0	6.0	112	101	45	1
35	0.22	A/3216-18	T494A224(1)035A(2)	0.5	4.0	6.0	112	101	45	1
35	0.33	A/3216-18	T494A334(1)035A(2)	0.5	4.0	6.0	112	101	45	1
35	0.47	B/3528-21	T494B474(1)035A(2)	0.5	4.0	2.5	184	166	74	1
35	0.47	A/3216-18	T494A474(1)035A(2)	0.5	4.0	4.0	137	123	55	1
35	0.68	B/3528-21	T494B684(1)035A(2)	0.5	4.0	2.5	184	166	74	1
35	0.68	A/3216-18	T494A684(1)035A(2)	0.5	4.0	6.0	112	101	45	1
35	1	B/3528-21	T494B105(1)035A(2)	0.5	4.0	2.0	206	185	82	1
35	1	A/3216-18	T494A105(1)035A(2)	0.5	4.0	6.0	112	101	45	1
35	1.5	A/3216-18	T494A155(1)035A(2)	0.5	6.0	4.0	137	123	55	1
35	1.5	C/6032-28	T494C155(1)035A(2)	0.5	6.0	2.5	210	189	84	1
35	1.5	B/3528-21	T494B155(1)035A(2)	0.5	6.0	3.0	168	151	67	1
35	2.2	A/3216-18	T494A225(1)035A(2)	0.8	6.0	3.0	158	142	63	1
35	2.2	C/6032-28	T494C225(1)035A(2)	0.8	6.0	1.5	271	244	108	1
35	2.2	B/3528-21	T494B225(1)035A(2)	0.8	6.0	2.5	184	166	74	1
35	3.3	C/6032-28	T494C335(1)035A(2)	1.2	6.0	0.8	371	334	148	1
35	3.3	B/3528-21	T494B335(1)035A(2)	1.2	6.0	1.3	256	230	102	1
35	4.7	B/3528-21	T494B475(1)035A(2)	1.6	6.0	1.5	238	214	95	1
35	4.7	D/7343-31	T494D475(1)035A(2)	1.6	6.0	0.7	463	417	185	1
35	4.7	C/6032-28	T494C475(1)035A(2)	1.6	6.0	0.7	396	356	158	1
35	6.8	D/7343-31	T494D685(1)035A(2)	2.4	6.0	0.5	548	493	219	1
35	6.8	C/6032-28	T494C685(1)035A(2)	2.4	6.0	0.9	350	315	140	1
35	10	D/7343-31	T494D106(1)035A(2)	3.5	6.0	0.4	612	551	245	1
35	10	C/6032-28	T494C106(M)035A(2)	3.5	6.0	1.2	303	273	121	1
35	10	V/7343-20	T494V106(1)035A(2)	3.5	6.0	0.8	395	356	158	1
35	15	X/7343-43	T494X156(1)035A(2)	5.3	6.0	0.30	742	668	297	1
35	15	D/7343-31	T494D156(1)035A(2)	5.3	6.0	0.35	655	590	262	1
35	22	X/7343-43	T494X226(1)035A(2)	7.7	6.0	0.3	742	668	297	1
35	22	D/7343-31	T494D226(1)035A(2)	7.7	6.0	0.4	612	551	245	1
35	33	D/7343-31	T494D336(1)035A(2)	11.6	6.0	0.6	500	450	200	1
35	33	X/7343-43	T494X336(1)035A(2)	11.6	6.0	0.3	524	472	210	1
35	47	X/7343-43	T494X476(1)035A(2)	16.5	8.0	0.5	574	517	230	1
35	47	E/7360-38	T494E476(1)035A(2)	16.5	10.0	0.3	816	734	326	1
50	0.1	A/3216-18	T494A104(1)050A(2)	0.5	4.0	10.0	87	78	35	1
50	0.15	B/3528-21	T494B154(1)050A(2)	0.5	4.0	10.0	92	83	37	1
50	0.15	A/3216-18	T494A154(1)050A(2)	0.5	4.0	10.0	87	78	35	1
50	0.22	B/3528-21	T494B224(1)050A(2)	0.5	4.0	10.0	92	83	37	1
50	0.33	B/3528-21	T494B334(1)050A(2)	0.5	4.0	2.5	184	166	74	1
50	0.47	C/6032-28	T494C474(1)050A(2)	0.5	4.0	1.8	247	222	99	1
50	0.47	B/3528-21	T494B474(1)050A(2)	0.5	4.0	2.0	206	185	82	1
50	0.68	C/6032-28	T494C684(1)050A(2)	0.5	4.0	1.6	262	236	105	1
50	0.68	B/3528-21	T494B684(1)050A(2)	0.5	4.0	3.0	168	151	67	1
50	1	A/3216-18	T494A105(1)050A(2)	0.5	4.0	5.0	122	110	49	1
50	1	C/6032-28	T494C105(1)050A(2)	0.5	4.0	1.6	262	236	105	1
50	1	B/3528-21	T494B105(1)050A(2)	0.5	6.0	4.0	146	131	58	1
50	1	V/7343-20	T494V105(M)050A(2)	0.5	4.0	4.0	177	159	71	1
50	1.5	D/7343-31	T494D155(1)050A(2)	0.8	6.0	1.0	387	348	155	1
50	1.5	C/6032-28	T494C155(1)050A(2)	0.8	6.0	1.5	271	244	108	1
50	2.2	D/7343-31	T494D225(1)050A(2)	1.1	6.0	0.8	433	390	173	1
50	2.2	C/6032-28	T494C225(1)050A(2)	1.1	6.0	1.5	271	244	108	1
VDC	µF	KEMET/EIA	(See below for part options)	µA @ 20°C Max/5 Min	% @ 20°C 120 Hz Max	Ω @ 20°C 100 kHz Max	(mA) 100 kHz 25°C	(mA) 100 kHz 85°C	(mA) 100 kHz 125°C	Reflow Temp ≤ 260°C
Rated Voltage	Rated Cap	Case Code/ Case Size	KEMET Part Number	DC Leakage	DF	ESR	Maximum Allowable Ripple Current			Moisture Sensitivity

(1) To complete KEMET part number, insert M for ±20% or K for ±10%. Designates capacitance tolerance.

(2) To complete KEMET part number, insert T = 100% Matte Tin (Sn) Plated, G = Gold Plated, H = Standard Solder coated (SnPb 5% Pb minimum). Designates termination finish.

Refer to Ordering Information for additional detail.

Higher voltage ratings and tighter tolerance product including ESR may be substituted within the same size at KEMET's option. Voltage substitution will be marked with the higher voltage rating. Substitutions can include better than series.

Table 1 – Ratings & Part Number Reference cont'd

Rated Voltage	Rated Cap	Case Code/ Case Size	KEMET Part Number	DC Leakage	DF	ESR	Maximum Allowable Ripple Current			Moisture Sensitivity
VDC	µF	KEMET/EIA	(See below for part options)	µA @ 20°C Max/5 Min	% @ 20°C 120 Hz Max	Ω @ 20°C 100 kHz Max	(mA) 100 kHz 25°C	(mA) 100 kHz 85°C	(mA) 100 kHz 125°C	Reflow Temp ≤ 260°C
50	3.3	D/7343-31	T494D335(1)050A(2)	1.7	6.0	0.8	433	390	173	1
50	4.7	D/7343-31	T494D475(1)050A(2)	2.4	6.0	0.6	500	450	200	1
50	6.8	X/7343-43	T494X685(1)050A(2)	3.4	6.0	0.5	574	517	230	1
50	6.8	D/7343-31	T494D685(1)050A(2)	3.4	6.0	0.7	463	417	185	1
50	10	X/7343-43	T494X106(M)050A(2)	5.0	6.0	0.4	642	578	257	1
50	10	D/7343-31	T494D106(1)050A(2)	5.0	6.0	0.7	463	417	185	1
50	15	X/7343-43	T494X156(1)050A(2)	7.5	6.0	0.4	642	578	257	1
50	22	X/7343-43	T494X226(1)050A(2)	11.0	10.0	0.5	574	517	230	1
VDC	µF	KEMET/EIA	(See below for part options)	µA @ 20°C Max/5 Min	% @ 20°C 120 Hz Max	Ω @ 20°C 100 kHz Max	(mA) 100 kHz 25°C	(mA) 100 kHz 85°C	(mA) 100 kHz 125°C	Reflow Temp ≤ 260°C
Rated Voltage	Rated Cap	Case Code/ Case Size	KEMET Part Number	DC Leakage	DF	ESR	Maximum Allowable Ripple Current			Moisture Sensitivity

(1) To complete KEMET part number, insert M for ±20% or K for ±10%. Designates capacitance tolerance.

(2) To complete KEMET part number, insert T = 100% Matte Tin (Sn) Plated, G = Gold Plated, H = Standard Solder coated (SnPb 5% Pb minimum). Designates termination finish.

Refer to Ordering Information for additional detail.

Higher voltage ratings and tighter tolerance product including ESR may be substituted within the same size at KEMET's option. Voltage substitution will be marked with the higher voltage rating. Substitutions can include better than series.

Recommended Voltage Derating Guidelines

-55°C to 125°C		
% Change in Working DC Voltage with Temperature	50% of V _R	V _R
Recommended Maximum Application Voltage	100% of V _R	V _R



Ripple Current/Ripple Voltage

KEMET Series and Case Code	EIA Case Code	Maximum Power Dissipation (P max) mWatts @ 25°C w/+20°C Rise
A	3216-18	75
B	3528-21	85
C	6032-28	110
D	7343-31	150
X	7343-43	165
E	7360-38	200
T428P	7360-38	325
S	3216-12	60
T	3528-12	70
U	6032-15	90
V	7343-20	125
T510X	7343-43	270
T510E	7360-38	285

Temperature Compensation Multipliers for Maximum Power Dissipation		
≤ 25°C	85°C	125°C
1.00	0.90	0.40

T = Environmental Temperature

Using the P max of the device, the maximum allowable rms ripple current or voltage may be determined.

$$I(max) = \sqrt{P_{max}/R}$$

$$E(max) = \sqrt{P_{max} \cdot R}$$

I = rms ripple current (amperes)

E = rms ripple voltage (volts)

P max = maximum power dissipation (watts)

R = ESR at specified frequency (ohms)

Reverse Voltage

Solid tantalum capacitors are polar devices and may be permanently damaged or destroyed if connected with the wrong polarity. The positive terminal is identified on the capacitor body by a stripe plus in some cases a beveled edge. A small degree of transient reverse voltage is permissible for short periods per the table. The capacitors should not be operated continuously in reverse mode, even within these limits.

Temperature	Permissible Transient Reverse Voltage
25°C	15% of Rated Voltage
85°C	5% of Rated Voltage
125°C	1% of Rated Voltage

Table 2 – Land Dimensions/Courtyard

KEMET	Metric Size Code	Density Level A: Maximum (Most) Land Protrusion (mm)					Density Level B: Median (Nominal) Land Protrusion (mm)					Density Level C: Minimum (Least) Land Protrusion (mm)				
		X	Y	C	V1	V2	X	Y	C	V1	V2	X	Y	C	V1	V2
Case	EIA															
A	3216-18	1.35	2.15	1.45	6.10	2.80	1.25	1.75	1.35	5.00	2.30	1.15	1.35	1.25	4.10	2.00
B	3528-21	2.35	2.15	1.45	6.10	4.00	2.25	1.75	1.35	5.00	3.50	2.15	1.35	1.25	4.10	3.20
C	6032-28	2.35	2.65	2.60	8.90	4.40	2.25	2.25	2.50	7.80	3.90	2.15	1.85	2.40	6.90	3.60
D	7343-31	2.55	3.75	2.70	10.20	5.50	2.45	3.35	2.60	9.10	5.00	2.35	2.95	2.50	8.20	4.70
E ¹	7360-38	4.25	2.65	3.20	10.10	7.20	4.15	2.25	3.30	9.40	6.70	4.05	1.85	3.00	8.10	6.40
S	3216-12	1.35	2.15	1.45	6.10	2.80	1.25	1.75	1.35	5.00	2.30	1.15	1.35	1.25	4.10	2.00
T	3528-12	2.35	2.15	1.45	6.10	4.00	2.25	1.75	1.35	5.00	3.50	2.15	1.35	1.25	4.10	3.20
U	6032-15	2.35	2.65	2.60	8.90	4.40	2.25	2.25	2.50	7.80	3.90	2.15	1.85	2.40	6.90	3.60
V	7343-20	2.55	3.75	2.70	10.20	5.50	2.45	3.35	2.60	9.10	5.00	2.35	2.95	2.50	8.20	4.70
X ¹	7343-43	2.55	3.75	2.70	10.20	5.50	2.45	3.35	2.60	9.10	5.00	2.35	2.95	2.50	8.20	4.70

Density Level A: For low-density product applications. Recommended for wave solder applications and provides a wider process window for reflow solder processes.

Density Level B: For products with a moderate level of component density. Provides a robust solder attachment condition for reflow solder processes.

Density Level C: For high component density product applications. Before adapting the minimum land pattern variations the user should perform qualification testing based on the conditions outlined in IPC Standard 7351 (IPC-7351).

¹ Height of these chips may create problems in wave soldering.

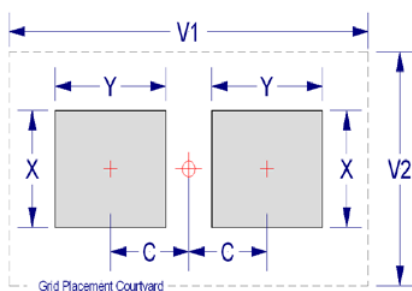

Soldering Process

KEMET's families of surface mount capacitors are compatible with wave (single or dual), convection, IR, or vapor phase reflow techniques. Preheating of these components is recommended to avoid extreme thermal stress. KEMET's recommended profile conditions for convection and IR reflow reflect the profile conditions of the IPC/J-STD-020D standard for moisture sensitivity testing. The devices can safely withstand a maximum of three reflow passes at these conditions.

Please note that although the X/7343-43 case size can withstand wave soldering, the tall profile (4.3 mm maximum) dictates care in wave process development.

Hand soldering should be performed with care due to the difficulty in process control. If performed, care should be taken to avoid contact of the soldering iron to the molded case. The iron should be used to heat the solder pad, applying solder between the pad and the termination, until reflow occurs. Once reflow occurs, the iron should be removed immediately. "Wiping" the edges of a chip and heating the top surface is not recommended.

During typical reflow operations, a slight darkening of the gold-colored epoxy may be observed. This slight darkening is normal and not harmful to the product. Marking permanency is not affected by this change.

Profile Feature	SnPb Assembly	Pb-Free Assembly
Preheat/Soak		
Temperature Minimum (T_{Smin})	100°C	150°C
Temperature Maximum (T_{Smax})	150°C	200°C
Time (t_s) from T_{Smin} to T_{Smax}	60 – 120 seconds	60 – 120 seconds
Ramp-up Rate (T_L to T_p)	3°C/seconds maximum	3°C/seconds maximum
Liquidous Temperature (T_L)	183°C	217°C
Time Above Liquidous (t_L)	60 – 150 seconds	60 – 150 seconds
Peak Temperature (T_p)	220°C* 235°C**	250°C* 260°C**
Time within 5°C of Maximum Peak Temperature (t_p)	20 seconds maximum	30 seconds maximum
Ramp-down Rate (T_p to T_L)	6°C/seconds maximum	6°C/seconds maximum
Time 25°C to Peak Temperature	6 minutes maximum	8 minutes maximum

Note: All temperatures refer to the center of the package, measured on the package body surface that is facing up during assembly reflow.

*Case Size D, E, P, Y, and X

**Case Size A, B, C, H, I, K, M, R, S, T, U, V, W, and Z

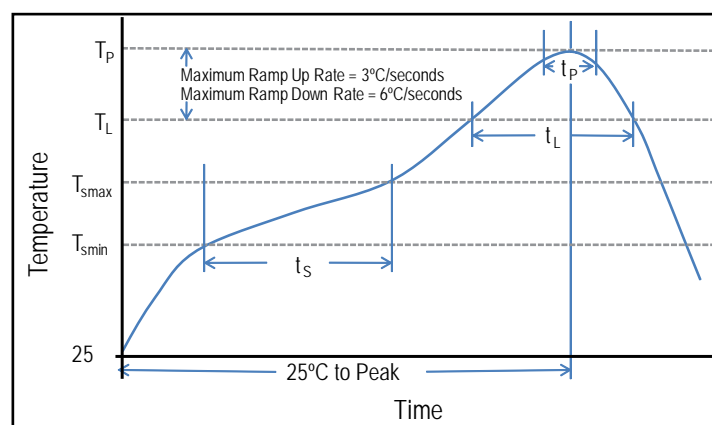

Construction

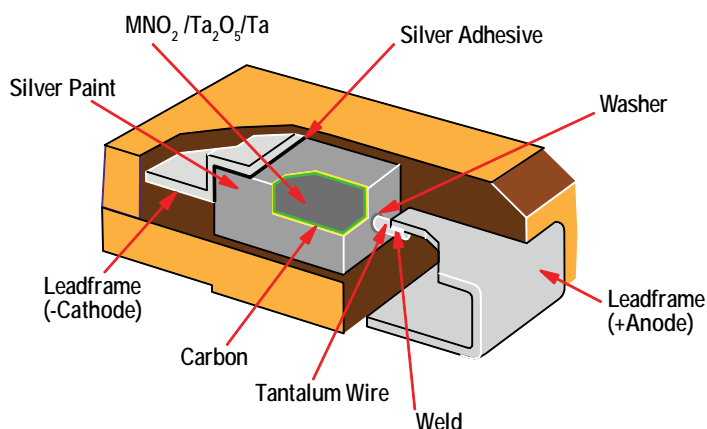

Capacitor Marking



* 230 = 30th week of 2012

Date Code *	
1 st digit = Last number of Year	9 = 2009 0 = 2010 1 = 2011 2 = 2012 3 = 2013 4 = 2014
2 nd and 3 rd digit = Week of the Year	01 = 1 st week of the Year to 52 = 52 nd week of the Year

Storage

Tantalum chip capacitors should be stored in normal working environments. While the chips themselves are quite robust in other environments, solderability will be degraded by exposure to high temperatures, high humidity, corrosive atmospheres, and long term storage. In addition, packaging materials will be degraded by high temperature— reels may soften or warp and tape peel force may increase. KEMET recommends that maximum storage temperature not exceed 40°C and maximum storage humidity not exceed 60% relative humidity. Temperature fluctuations should be minimized to avoid condensation on the parts and atmospheres should be free of chlorine and sulphur bearing compounds. For optimized solderability chip stock should be used promptly, preferably within three years of receipt.

Overview

The low ESR, surge-robust T495 Series is designed for demanding applications that require high surge current and high ripple current capability. This series builds upon the proven capabilities of our industrial grade tantalum chip capacitors to offer several advantages such as low ESR, high ripple

current capability, excellent capacitance stability, and improved resistance to high in-rush currents. These benefits are achieved through a combination of proprietary design, materials, and process parameters as well as high-stress, low impedance electrical conditioning performed prior to screening.

Benefits

- Meets or exceeds EIA Standard 535BAAC
- Taped and reeled per EIA 481-1
- High surge current capability
- Optional gold-plated terminations
- High ripple current capability
- 100% surge current test on C, D, E, U, V, X sizes
- 100% steady-state accelerated aging
- Capacitance values of 0.1 μF to 1,000 μF
- Tolerances of $\pm 10\%$ and $\pm 20\%$
- Voltage rating of 2.5 – 50 VDC
- Extended range values
- Available tested to DSCC 95158
- RoHS Compliant and lead-free terminations
- Operating temperature range of -55°C to $+125^{\circ}\text{C}$

Applications

Typical applications include decoupling and filtering in industrial and automotive end applications, such as DC/DC converters, portable electronics, telecommunications, and control units requiring high ripple current capability.



Environmental Compliance

RoHS Compliant (6/6) according to Directive 2002/95/EC when ordered with 100% Sn Solder



RoHS Compliant

SPICE

For a detailed analysis of specific part numbers, please visit www.kemet.com for a free download of KEMET's SPICE software. The KEMET SPICE program is freeware intended to aid design engineers in analyzing the performance of these capacitors over frequency, temperature, ripple, and DC bias conditions.

Ordering Information

T	495	X	107	M	010	A	T	E045	
Capacitor Class	Series	Case Size	Capacitance Code (pF)	Capacitance Tolerance	Voltage	Failure Rate/Design	Lead Material	ESR	Packaging (C-Spec)
T = Tantalum	Surge Robust Low ESR	A, B, C, D, E, T, V, X	First two digits represent significant figures. Third digit specifies number of zeros.	K = ±10% M = ±20%	2R5 = 2.5 V 004 = 4 V 006 = 6.3 V 010 = 10 V 016 = 16 V 020 = 20 V 025 = 25 V 035 = 35 V 050 = 50 V	A = N/A	T = 100% Matte Tin (Sn) Plated H = Standard Solder Coated (SnPb 5% Pb minimum) G = Gold Plated (A, B, C, D, X only)	Last three digits specify ESR in mΩ. (45 = 45 mΩ)	Blank = 7" Reel 7280 = 13" Reel

Performance Characteristics

Item	Performance Characteristics
Operating Temperature	-55°C to 125°C
Rated Capacitance Range	0.47 – 1,000 μF @ 120 Hz/25°C
Capacitance Tolerance	K Tolerance (10%), M Tolerance (20%)
Rated Voltage Range	2.5 – 50 V
DF (120 Hz)	Refer to Part Number Electrical Specification Table
ESR (100 kHz)	Refer to Part Number Electrical Specification Table
Leakage Current	≤ 0.01 CV (μA) at rated voltage after 5 minutes

Qualification

Test	Condition	Characteristics				
Endurance	85°C @ rated voltage, 2,000 hours. 125°C @ 2/3 rated voltage, 2,000 hours.	Δ C/C	Within ±10% of initial value			
		DF	Within initial limits			
		DCL	Within 1.25 x initial limit			
		ESR	Within initial limits			
Storage Life	125°C @ 0 volts, 2,000 hours.	Δ C/C	Within ±10% of initial value			
		DF	Within initial limits			
		DCL	Within 1.25 x initial limit			
		ESR	Within initial limits			
Thermal Shock	MIL-STD-202, Method 107, Condition B, mounted, -55°C to 125°C, 1,000 cycles.	Δ C/C	Within ±5% of initial value			
		DF	Within initial limits			
		DCL	Within 1.25 x initial limit			
		ESR	Within initial limits			
Temperature Stability	Extreme temperature exposure at a succession of continuous steps at +25°C, -55°C, +25°C, +85°C, +125°C, +25°C.	+25°C	-55°C	+85°C	+125°C	
		Δ C/C	IL*	±10%	±10%	±20%
		DF	IL	IL	1.5 x IL	1.5 x IL
Surge Voltage	25°C and 85°C, 1.32 x rated voltage 1,000 cycles (125°C, 1.2 x rated voltage).	DCL	10 x IL			
		ESR	12 x IL			
		ESR	Within initial limits			
Mechanical Shock/Vibration	MIL-STD-202, Method 213, Condition I, 100 G peak MIL-STD-202, Method 204, Condition D, 10 Hz to 2,000 Hz, 20 G peak	Δ C/C	Within ±10% of initial value			
		DF	Within initial limits			
		DCL	Within initial limits			

*IL = Initial limit

Electrical Characteristics

ESR vs. Frequency

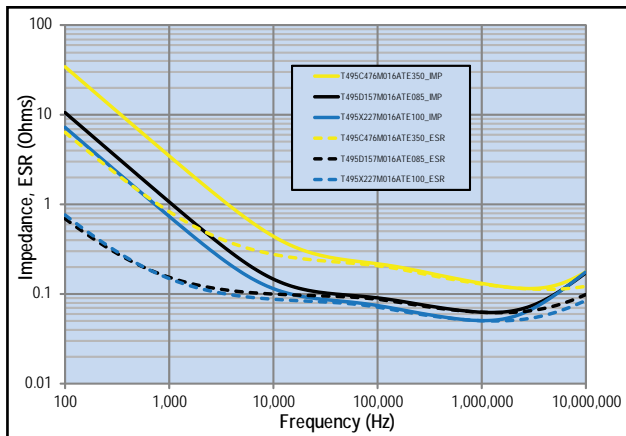

Capacitance vs. Frequency

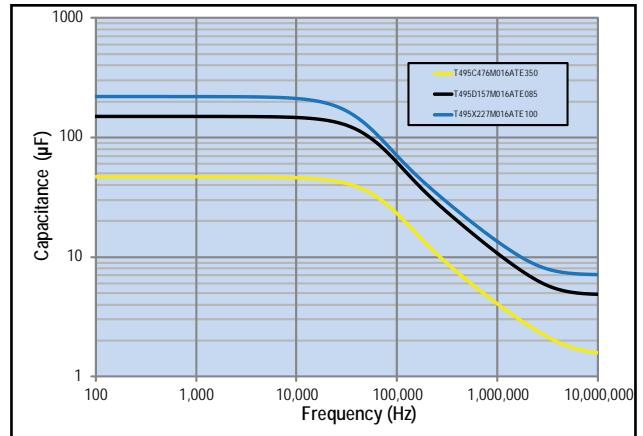

Dimensions – Millimeters (Inches)

Metric will govern



Case Size		Component												
KEMET	EIA	L*	W*	H*	F* ±0.1 ±(.004)	S* ±0.3 ±(.012)	B* ±0.15 (Ref) ±.006	X (Ref)	P (Ref)	R (Ref)	T (Ref)	A (Min)	G (Ref)	E (Ref)
A	3216-18	3.2 ± 0.2 (.126 ± .008)	1.6 ± 0.2 (.063 ± .008)	1.6 ± 0.2 (.063 ± .008)	1.2 (.047)	0.8 (.031)	0.4 (.016)	0.10 ± 0.10 (.004 ± .004)	0.4 (.016)	0.4 (.016)	0.13 (.005)	0.8 (.31)	1.1 (.043)	1.3 (.051)
B	3528-21	3.5 ± 0.2 (.138 ± .008)	2.8 ± 0.2 (.110 ± .008)	1.9 ± 0.2 (.075 ± .008)	2.2 (.087)	0.8 (.031)	0.4 (.016)	0.10 ± 0.10 (.004 ± .004)	0.5 (.020)	1.0 (.039)	0.13 (.005)	1.1 (0.043)	1.8 (.071)	2.2 (.087)
C	6032-28	6.0 ± 0.3 (.236 ± .03)	3.2 ± 0.3 (.126 ± .012)	2.5 ± 0.3 (.098 ± .012)	2.2 (.087)	1.3 (.051)	0.5 (.020)	0.10 ± 0.10 (.004 ± .004)	0.9 (.035)	1.0 (.039)	0.13 (.005)	2.5(.098)	2.8 (.110)	2.4 (.094)
D	7343-31	7.3 ± 0.3 (.287 ± .012)	4.3 ± 0.3 (.169 ± .012)	2.8 ± 0.3 (.110 ± .012)	2.4 (.094)	1.3 (.051)	0.5 (.020)	0.10 ± 0.10 (.004 ± .004)	0.9 (.035)	1.0 (.039)	0.13 (.005)	3.8 (.150)	3.5 (.138)	3.5 (.138)
X	7343-43	7.3 ± 0.3 (.287 ± .012)	4.3 ± 0.3 (.169 ± .012)	4.0 ± 0.3 (.157 ± .012)	2.4 (.094)	1.3 (.051)	0.5 (.020)	0.10 ± 0.10 (.004 ± .004)	1.7 (.067)	1.0 (.039)	0.13 (.005)	3.8 (.150)	3.5 (.138)	3.5 (.138)
E	7360-38	7.3 ± 0.3 (.287 ± .012)	6.0 ± 0.3 (.236 ± .012)	3.6 ± 0.2 (.142 ± .008)	4.1 (.161)	1.3 (.051)	0.5 (.020)	0.10 ± 0.10 (.004 ± .004)	0.9 (.035)	1.0 (.039)	0.13 (.005)	3.8 (.150)	3.5 (.138)	3.5 (.138)
T	3528-12	3.5 ± 0.2 (.138 ± .008)	2.8 ± 0.2 (.110 ± .008)	1.2 (.047)	2.2 (.087)	0.8 (.031)	N/A	0.05 (.002)	N/A	N/A	0.13 (.005)	1.1 (.043)	1.8 (.071)	2.2 (.087)
V	7343-20	7.3 ± 0.3 (.287 ± .012)	4.3 ± 0.3 (.169 ± .012)	2.0 (.079)	2.4 (.094)	1.3 (.051)	N/A	0.05 (.002)	N/A	N/A	0.13 (.005)	3.8 (.150)	3.5 (.138)	3.5 (.138)

Notes: (Ref) – Dimensions provided for reference only. No dimensions provided for B, P or R because low profile cases do not have a bevel or a notch.

* MIL-PRF-55365/8 specified dimensions

Table 1 – Ratings & Part Number Reference

Rated Voltage	Rated Cap	Case Code/ Case Size	KEMET Part Number	DC Leakage	DF	ESR	Maximum Allowable Ripple Current			Moisture Sensitivity
VDC	µF	KEMET/EIA	(See below for part options)	µAmps +20°C Max/5 Min	% @ +20°C 120 Hz Max	mΩ @ 20°C 100 kHz Max	(mA) 100 kHz 25°C	(mA) 100 kHz +85°C	(mA) 100 kHz +125°C	Reflow Temp ≤ 260°C
2.5	220	D/7343-31	T495D227(1)2R5A(2)E045	5.5	8.0	45	1826	1643	730	1
2.5	470	D/7343-31	T495D477(1)2R5A(2)E035	11.8	8.0	35	2070	1863	828	1
2.5	1000	X/7343-43	T495X108(1)2R5A(2)E030	25.0	15.0	30	2345	2111	938	1
2.5	1000	X/7343-43	T495X108(1)2R5A(2)E040	25.0	15.0	40	2031	1828	812	1
4	68	V/7343-20	T495V686(1)004A(2)E150	2.7	6.0	150	913	822	365	1
4	100	B/3528-21	T495B107(1)004A(2)E500	4.0	8.0	500	412	371	165	1
4	150	B/3528-21	T495B157(M)004A(2)E900	6.0	12.0	900	307	276	123	1
4	150	C/6032-28	T495C157(1)004A(2)E070	6.0	12.0	70	1254	1129	502	1
4	150	C/6032-28	T495C157(1)004A(2)E250	6.0	8.0	250	663	597	265	1
4	220	D/7343-31	T495D227(1)004A(2)E040	8.8	8.0	40	1936	1742	774	1
4	220	D/7343-31	T495D227(1)004A(2)E050	8.8	8.0	50	1732	1559	693	1
4	220	D/7343-31	T495D227(1)004A(2)E100	8.8	8.0	100	1225	1103	490	1
4	330	C/6032-28	T495C337(1)004A(2)E300	13.2	10.0	300	606	545	242	1
4	330	C/6032-28	T495C337(1)004A(2)E700	13.2	12.0	700	396	356	158	1
4	330	D/7343-31	T495D337(1)004A(2)E030	13.2	8.0	30	2236	2012	894	1
4	330	D/7343-31	T495D337(1)004A(2)E045	13.2	8.0	45	1826	1643	730	1
4	470	D/7343-31	T495D477(1)004A(2)E045	18.8	12.0	45	1826	1643	730	1
4	470	D/7343-31	T495D477(1)004A(2)E100	18.8	12.0	100	1225	1103	490	1
4	470	X/7343-43	T495X477(1)004A(2)E030	18.8	8.0	30	2345	2111	938	1
4	470	X/7343-43	T495X477(1)004A(2)E045	18.8	8.0	45	1915	1724	766	1
4	470	X/7343-43	T495X477(1)004A(2)E100	18.8	8.0	100	1285	1157	514	1
4	1000	X/7343-43	T495X108(1)004A(2)E030	40.0	12.0	30	2345	2111	938	1
4	1000	X/7343-43	T495X108(1)004A(2)E040	40.0	12.0	40	2031	1828	812	1
4	1000	X/7343-43	T495X108(1)004A(2)E060	40.0	12.0	60	1658	1492	663	1
4	1000	X/7343-43	T495X108(1)004A(2)E070	40.0	12.0	70	1535	1382	614	1
4	1000	X/7343-43	T495X108(1)004A(2)E090	40.0	12.0	90	1354	1219	542	1
4	1000	E/7360-38	T495E108(1)004A(2)E035	40.0	15.0	35	2390	2151	956	1
4	1000	E/7360-38	T495E108(1)004A(2)E050	40.0	15.0	50	2000	1800	800	1
6.3	6.8	A/3216-18	T495A685(1)006A(2)E2K0	0.5	6.0	2000	194	175	78	1
6.3	10	A/3216-18	T495A106(1)006A(2)E1K0	0.6	6.0	1000	274	247	110	1
6.3	10	A/3216-18	T495A106(1)006A(2)E1K5	0.6	6.0	1500	224	202	90	1
6.3	10	A/3216-18	T495A106(1)006A(2)E2K0	0.6	6.0	2000	194	175	78	1
6.3	47	B/3528-21	T495B476(1)006A(2)E450	3.0	6.0	450	435	392	174	1
6.3	47	C/6032-28	T495C476(1)006A(2)E250	3.0	6.0	250	663	597	265	1
6.3	47	V/7343-20	T495V476(1)006A(2)E150	3.0	6.0	150	913	822	365	1
6.3	68	D/7343-31	T495D686(1)006A(2)E175	4.3	4.0	175	926	833	370	1
6.3	68	D/7343-31	T495D686(1)006A(2)4095	4.3	4.0	175	926	833	370	1
6.3	100	B/3528-21	T495B107(1)006A(2)E400	6.3	15.0	400	461	415	184	1
6.3	100	B/3528-21	T495B107(M)006A(2)E700	6.3	15.0	700	348	313	139	1
6.3	100	C/6032-28	T495C107(1)006A(2)E075	6.3	8.0	75	1211	1090	484	1
6.3	100	C/6032-28	T495C107(1)006A(2)E150	6.3	8.0	150	856	770	342	1
6.3	100	D/7343-31	T495D107(1)006A(2)E050	6.3	6.0	50	1732	1559	693	1
6.3	100	D/7343-31	T495D107(1)006A(2)E130	6.3	6.0	130	1074	967	430	1
6.3	100	D/7343-31	T495D107(1)006A(2)E150	6.3	8.0	150	1000	900	400	1
6.3	100	V/7343-20	T495V107(1)006A(2)E090	6.3	8.0	90	1179	1061	472	1
6.3	100	V/7343-20	T495V107(1)006A(2)E150	6.3	8.0	150	913	822	365	1
6.3	150	C/6032-28	T495C157(1)006A(2)E050	9.5	8.0	50	1483	1335	593	1
6.3	150	C/6032-28	T495C157(M)006A(2)E200	9.5	8.0	200	742	668	297	1
6.3	150	V/7343-20	T495V157(1)006A(2)E040	9.5	8.0	40	1768	1591	707	1
6.3	150	V/7343-20	T495V157(1)006A(2)E070	9.5	8.0	70	1336	1202	534	1
VDC	µF	KEMET/EIA	(See below for part options)	µAmps +20°C Max/5 Min	% @ +20°C 120 Hz Max	mΩ @ 20°C 100 kHz Max	(mA) 100 kHz 25°C	(mA) 100 kHz +85°C	(mA) 100 kHz +125°C	Reflow Temp ≤ 260°C
Rated Voltage	Rated Cap	Case Code/ Case Size	KEMET Part Number	DC Leakage	DF	ESR	Maximum Allowable Ripple Current			Moisture Sensitivity

(1) To complete KEMET part number, insert M for ±20% or K for ±10%. Designates capacitance tolerance.

(2) To complete KEMET part number, insert T = 100% Matte Tin (Sn) Plated, G = Gold Plated, H = Standard Solder coated (SnPb 5% Pb minimum). Designates termination finish.

Refer to Ordering Information for additional detail.

Higher voltage ratings and tighter tolerance product including ESR may be substituted within the same size at KEMET's option. Voltage substitution will be marked with the higher voltage rating. Substitutions can include better than series.

Table 1 – Ratings & Part Number Reference cont'd

Rated Voltage	Rated Cap	Case Code/ Case Size	KEMET Part Number	DC Leakage	DF	ESR	Maximum Allowable Ripple Current			Moisture Sensitivity
VDC	μF	KEMET/EIA	(See below for part options)	μAmps +20°C Max/5 Min	% @ +20°C 120 Hz Max	mΩ @ 20°C 100 kHz Max	(mA) 100 kHz 25°C	(mA) 100 kHz +85°C	(mA) 100 kHz +125°C	Reflow Temp ≤ 260°C
6.3	150	D/7343-31	T495D157(1)006A(2)E050	9.5	6.0	50	1732	1559	693	1
6.3	150	D/7343-31	T495D157(1)006A(2)E125	9.5	6.0	125	1095	986	438	1
6.3	150	X/7343-43	T495X157(1)006A(2)E100	9.5	6.0	100	1285	1157	514	1
6.3	150	X/7343-43	T495X157(1)006A(2)4095	9.5	6.0	125	1149	1034	460	1
6.3	220	C/6032-28	T495C227(1)006(2)E225	13.9	10.0	25	2098	1888	839	1
6.3	220	D/7343-31	T495D227(1)006A(2)E045	13.9	8.0	45	1826	1643	730	1
6.3	220	D/7343-31	T495D227(1)006A(2)E100	13.9	8.0	100	1225	1103	490	1
6.3	220	D/7343-31	T495D227(1)006A(2)4095	13.9	8.0	100	1225	1103	490	1
6.3	220	X/7343-43	T495X227(1)006A(2)E070	13.9	8.0	70	1535	1382	614	1
6.3	220	X/7343-43	T495X227(1)006A(2)E100	13.9	8.0	100	1285	1157	514	1
6.3	220	V/7343-20	T495V227(1)006ATE150	13.9	8.0	150	913	822	365	1
6.3	220	X/7343-43	T495X227(1)006A(2)4095	13.9	8.0	100	1285	1157	514	1
6.3	330	D/7343-31	T495D337(1)006A(2)E040	20.8	8.0	40	1936	1742	774	1
6.3	330	D/7343-31	T495D337(1)006A(2)E050	20.8	8.0	50	1732	1559	693	1
6.3	330	D/7343-31	T495D337(1)006A(2)E070	20.8	8.0	70	1464	1318	586	1
6.3	330	D/7343-31	T495D337(1)006A(2)E100	20.8	8.0	100	1225	1103	490	1
6.3	330	X/7343-43	T495X337(1)006A(2)E065	20.8	8.0	65	1593	1434	637	1
6.3	330	X/7343-43	T495X337(1)006A(2)E045	20.8	8.0	45	1915	1724	766	1
6.3	330	X/7343-43	T495X337(1)006A(2)E100	20.8	8.0	100	1285	1157	514	1
6.3	330	E/7360-38	T495E337(1)006A(2)E060	20.8	8.0	60	1826	1643	730	1
6.3	330	E/7360-38	T495E337(1)006A(2)E100	20.8	8.0	100	1414	1273	566	1
6.3	470	D/7343-31	T495D477(M)006A(2)E045	29.6	12.0	45	1826	1643	730	1
6.3	470	D/7343-31	T495D477(1)006A(2)E100	29.6	12.0	100	1225	1103	490	1
6.3	470	D/7343-31	T495D477(1)006A(2)E125	29.6	12.0	125	1095	986	438	1
6.3	470	X/7343-43	T495X477(1)006A(2)E030	29.6	10.0	30	2345	2111	938	1
6.3	470	X/7343-43	T495X477(1)006A(2)E045	29.6	10.0	45	1915	1724	766	1
6.3	470	X/7343-43	T495X477(1)006A(2)E050	29.6	10.0	50	1817	1635	727	1
6.3	470	X/7343-43	T495X477(1)006A(2)E065	29.6	10.0	65	1593	1434	637	1
6.3	470	E/7360-38	T495E477(1)006A(2)E040	29.6	12.0	40	2236	2012	894	1
6.3	470	E/7360-38	T495E477(1)006A(2)E055	29.6	10.0	55	1907	1716	763	1
6.3	470	E/7360-38	T495E477(1)006A(2)E100	29.6	10.0	100	1414	1273	566	1
6.3	1000	E/7360-38	T495E108(1)006A(2)E050	63.0	15.0	50	2000	1800	800	1
10	2.2	A/3216-18	T495A225(1)010A(2)E1K8	0.5	6.0	1800	204	184	82	1
10	4.7	A/3216-18	T495A475(1)010A(2)E1K2	0.5	6.0	1200	250	225	100	1
10	4.7	A/3216-18	T495A475(1)010A(2)E1K3	0.5	6.0	1300	240	216	96	1
10	4.7	A/3216-18	T495A475(1)010A(2)E1K8	0.5	6.0	1800	204	184	82	1
10	4.7	B/3528-21	T495B475(1)010A(2)E1K3	0.5	15.0	1300	256	230	102	1
10	6.8	A/3216-18	T495A685(1)010A(2)E1K8	0.7	6.0	1800	204	184	82	1
10	6.8	B/3528-21	T495B685(1)010A(2)E900	0.7	6.0	900	307	276	123	1
10	10	A/3216-18	T495A106(1)010A(2)E1K8	1.0	6.0	1800	204	184	82	1
10	10	A/3216-18	T495A106(1)010A(2)E2K0	1.0	6.0	2000	194	175	78	1
10	10	B/3528-21	T495B106(1)010AT E1K2	1.0	6.0	1200	266	239	106	1
10	10	B/3528-21	T495B106(1)010A(2)E750	1.0	6.0	750	337	303	135	1
10	10	B/3528-21	T495B106(1)010AT E600	1.0	6.0	600	376	338	150	1
10	10	C/6032-28	T495C106(1)010AT E400	1.0	6.0	400	524	472	210	1
10	10	T/3528-12	T495T106(1)010AT E1K5	1.0	6.0	1500	216	194	86	1
10	15	A/3216-18	T495A156(1)010AT E1K0	1.5	6.0	1000	274	247	110	1
10	15	A/3216-18	T495A156(1)010AT E1K8	1.5	6.0	1800	204	184	82	1
10	15	B/3528-21	T495B156(1)010AT E600	1.5	6.0	600	376	338	150	1
10	15	B/3528-21	T495B156(1)010AT E900	1.5	6.0	900	307	276	123	1
10	15	T/3528-12	T495T156(1)010AT E1K2	1.5	6.0	1200	242	218	97	1
VDC	μF	KEMET/EIA	(See below for part options)	μAmps +20°C Max/5 Min	% @ +20°C 120 Hz Max	mΩ @ 20°C 100 kHz Max	(mA) 100 kHz 25°C	(mA) 100 kHz +85°C	(mA) 100 kHz +125°C	Reflow Temp ≤ 260°C
Rated Voltage	Rated Cap	Case Code/ Case Size	KEMET Part Number	DC Leakage	DF	ESR	Maximum Allowable Ripple Current			Moisture Sensitivity

(1) To complete KEMET part number, insert M for ±20% or K for ±10%. Designates capacitance tolerance.

(2) To complete KEMET part number, insert T = 100% Matte Tin (Sn) Plated, G = Gold Plated, H = Standard Solder coated (SnPb 5% Pb minimum). Designates termination finish.

Refer to Ordering Information for additional detail.

Higher voltage ratings and tighter tolerance product including ESR may be substituted within the same size at KEMET's option. Voltage substitution will be marked with the higher voltage rating. Substitutions can include better than series.

Table 1 – Ratings & Part Number Reference cont'd

Rated Voltage	Rated Cap	Case Code/ Case Size	KEMET Part Number	DC Leakage	DF	ESR	Maximum Allowable Ripple Current			Moisture Sensitivity
VDC	μF	KEMET/EIA	(See below for part options)	μAmps +20°C Max/5 Min	% @ +20°C 120 Hz Max	mΩ @ 20°C 100 kHz Max	(mA) 100 kHz 25°C	(mA) 100 kHz +85°C	(mA) 100 kHz +125°C	Reflow Temp ≤ 260°C
10	15	B/3528-21	T495B156(1)010A(2)E500	1.5	6.0	500	412	371	165	1
10	15	C/6032-28	T495C156(1)010A(2)E375	1.5	6.0	375	542	488	217	1
10	15	C/6032-28	T495C156(1)010A(2)E400	1.5	6.0	400	524	472	210	1
10	15	C/6032-28	T495C156(1)010A(2)E475	1.5	6.0	475	481	433	192	1
10	22	A/3216-18	T495A226(1)010AT E1K2	2.2	8.0	1200	250	225	100	1
10	22	A/3216-18	T495A226(1)010AT E1K5	2.2	8.0	1500	224	202	90	1
10	22	B/3528-21	T495B226(1)010AT E400	2.2	6.0	400	461	415	184	1
10	22	B/3528-21	T495B226(1)010AT E500	2.2	6.0	500	412	371	165	1
10	22	B/3528-21	T495B226(1)010AT E700	2.2	6.0	700	348	313	139	1
10	22	B/3528-21	T495B226(1)010AT E800	2.2	6.0	800	326	293	130	1
10	22	C/6032-28	T495C226(1)010A(2)E200	2.2	6.0	200	742	668	297	1
10	22	C/6032-28	T495C226(1)010A(2)E245	2.2	6.0	245	670	603	268	1
10	22	C/6032-28	T495C226(1)010A(2)E290	2.2	6.0	290	616	554	246	1
10	22	C/6032-28	T495C226(1)010A(2)E345	2.2	6.0	345	565	509	226	1
10	33	B/3528-21	T495B336(1)010A(2)E450	3.3	6.0	450	435	392	174	1
10	33	V/7343-20	T495V336(1)010A(2)E100	3.3	6.0	100	1118	1006	447	1
10	33	V/7343-20	T495V336(1)010A(2)E150	3.3	6.0	150	913	822	365	1
10	47	B/3528-21	T495B476(1)010A(2)E500	4.7	6.0	500	412	371	165	1
10	47	D/7343-31	T495D476(1)010A(2)E080	4.7	4.0	80	1369	1232	548	1
10	47	D/7343-31	T495D476(1)010A(2)E090	4.7	6.0	90	1291	1162	516	1
10	47	D/7343-31	T495D476(1)010A(2)E200	4.7	4.0	200	866	779	346	1
10	47	D/7343-31	T495D476(1)010A(2)4095	4.7	4.0	200	866	779	346	1
10	68	B/3528-21	T495B686(1)010A(2)E600	6.8	10.0	600	376	338	150	1
10	68	B/3528-21	T495B686(1)010A(2)E750	6.8	10.0	750	337	303	135	1
10	68	B/3528-21	T495B686(M)010A(2)E900	6.8	10.0	900	307	276	123	1
10	68	C/6032-28	T495C686(1)010A(2)E080	6.8	6.0	80	1173	1056	469	1
10	68	C/6032-28	T495C686(1)010A(2)E225	6.8	6.0	225	699	629	280	1
10	68	V/7343-20	T495V686(1)010A(2)E070	6.8	6.0	70	1336	1202	534	1
10	68	V/7343-20	T495V686(1)010A(2)E100	6.8	6.0	100	1118	1006	447	1
10	68	V/7343-20	T495V686(1)010A(2)E140	6.8	6.0	140	945	851	378	1
10	68	D/7343-31	T495D686(1)010A(2)E070	6.8	6.0	70	1464	1318	586	1
10	68	D/7343-31	T495D686(1)010A(2)E090	6.8	6.0	90	1291	1162	516	1
10	68	D/7343-31	T495D686(1)010A(2)E150	6.8	6.0	150	1000	900	400	1
10	68	X/7343-43	T495X686(1)010A(2)E150	6.8	4.0	150	1049	944	420	1
10	68	X/7343-43	T495X686(1)010A(2)4095	6.8	4.0	150	1049	944	420	1
10	100	B/3528-21	T495B107(M)010A(2)E500	10.0	30.0	500	412	371	165	1
10	100	V/7343-20	T495V107(1)010A(2)E100	10.0	8.0	100	1118	1006	447	1
10	100	V/7343-20	T495V107(1)010A(2)E150	10.0	8.0	150	913	822	365	1
10	100	D/7343-31	T495D107(1)010A(2)E050	10.0	8.0	50	1732	1559	693	1
10	100	D/7343-31	T495D107(1)010A(2)E065	10.0	8.0	65	1519	1367	608	1
10	100	D/7343-31	T495D107(1)010A(2)E080	10.0	8.0	80	1369	1232	548	1
10	100	D/7343-31	T495D107(1)010A(2)E100	10.0	8.0	100	1225	1103	490	1
10	100	D/7343-31	T495D107(1)010A(2)4095	10.0	8.0	100	1225	1103	490	1
10	100	X/7343-43	T495X107(1)010A(2)E100	10.0	6.0	100	1285	1157	514	1
10	100	X/7343-43	T495X107(1)010A(2)4095	10.0	6.0	100	1285	1157	514	1
10	150	V/7343-20	T495V157(1)010A(2)E100	15.0	8.0	100	1118	1006	447	1
10	150	V/7343-20	T495V157(M)010A(2)E150	15.0	8.0	150	913	822	365	1
10	150	D/7343-31	T495D157(1)010A(2)E050	15.0	8.0	50	1732	1559	693	1
10	150	D/7343-31	T495D157(1)010A(2)E060	15.0	8.0	60	1581	1423	632	1
10	150	D/7343-31	T495D157(1)010A(2)E080	15.0	8.0	80	1369	1232	548	1
10	150	D/7343-31	T495D157(1)010A(2)E100	15.0	8.0	100	1225	1103	490	1
10	150	D/7343-31	T495D157(1)010A(2)4095	15.0	8.0	100	1225	1103	490	1
VDC	μF	KEMET/EIA	(See below for part options)	μAmps +20°C Max/5 Min	% @ +20°C 120 Hz Max	mΩ @ 20°C 100 kHz Max	(mA) 100 kHz 25°C	(mA) 100 kHz +85°C	(mA) 100 kHz +125°C	Reflow Temp ≤ 260°C
Rated Voltage	Rated Cap	Case Code/ Case Size	KEMET Part Number	DC Leakage	DF	ESR	Maximum Allowable Ripple Current			Moisture Sensitivity

(1) To complete KEMET part number, insert M for ±20% or K for ±10%. Designates capacitance tolerance.

(2) To complete KEMET part number, insert T = 100% Matte Tin (Sn) Plated, G = Gold Plated, H = Standard Solder coated (SnPb 5% Pb minimum). Designates termination finish.

Refer to Ordering Information for additional detail.

Higher voltage ratings and tighter tolerance product including ESR may be substituted within the same size at KEMET's option. Voltage substitution will be marked with the higher voltage rating. Substitutions can include better than series.

Table 1 – Ratings & Part Number Reference cont'd

Rated Voltage	Rated Cap	Case Code/ Case Size	KEMET Part Number	DC Leakage	DF	ESR	Maximum Allowable Ripple Current			Moisture Sensitivity
VDC	μF	KEMET/EIA	(See below for part options)	μAmps +20°C Max/5 Min	% @ +20°C 120 Hz Max	mΩ @ 20°C 100 kHz Max	(mA) 100 kHz 25°C	(mA) 100 kHz +85°C	(mA) 100 kHz +125°C	Reflow Temp ≤ 260°C
10	150	X/7343-43	T495X157(1)010A(2)E070	15.0	8.0	70	1535	1382	614	1
10	150	X/7343-43	T495X157(1)010A(2)E080	15.0	8.0	80	1436	1292	574	1
10	150	X/7343-43	T495X157(1)010A(2)E085	15.0	8.0	85	1393	1254	557	1
10	150	X/7343-43	T495X157(1)010A(2)E100	15.0	8.0	100	1285	1157	514	1
10	150	X/7343-43	T495X157(1)010A(2)4095	15.0	8.0	100	1285	1157	514	1
10	220	D/7343-31	T495D227(1)010A(2)E045	22.0	8.0	45	1826	1643	730	1
10	220	D/7343-31	T495D227(1)010A(2)E075	22.0	8.0	75	1414	1273	566	1
10	220	D/7343-31	T495D227(1)010A(2)E100	22.0	8.0	100	1225	1103	490	1
10	220	D/7343-31	T495D227(1)010A(2)E125	22.0	8.0	125	1095	986	438	1
10	220	X/7343-43	T495X227(1)010A(2)E045	22.0	8.0	45	1915	1724	766	1
10	220	X/7343-43	T495X227(1)010A(2)E050	22.0	8.0	50	1817	1635	727	1
10	220	X/7343-43	T495X227(1)010A(2)E060	22.0	8.0	60	1658	1492	663	1
10	220	X/7343-43	T495X227(1)010A(2)E070	22.0	8.0	70	1535	1382	614	1
10	220	X/7343-43	T495X227(1)010A(2)E100	22.0	8.0	100	1285	1157	514	1
10	220	X/7343-43	T495X227(1)010A(2)4095	22.0	8.0	100	1285	1157	514	1
10	330	D/7343-31	T495D337(1)010A(2)E100	33.0	8.0	100	1225	1103	490	1
10	330	D/7343-31	T495D337(1)010A(2)E125	33.0	10.0	125	1095	986	438	1
10	330	D/7343-31	T495D337(1)010A(2)E150	33.0	10.0	150	1000	900	400	1
10	330	X/7343-43	T495X337(1)010A(2)E035	33.0	10.0	35	2171	1954	868	1
10	330	X/7343-43	T495X337(1)010A(2)E050	33.0	10.0	50	1817	1635	727	1
10	330	X/7343-43	T495X337(1)010A(2)E060	33.0	10.0	60	1658	1492	663	1
10	330	X/7343-43	T495X337(1)010A(2)E100	33.0	10.0	100	1285	1157	514	1
10	330	E/7360-38	T495E337(1)010A(2)E040	33.0	8.0	40	2236	2012	894	1
10	330	E/7360-38	T495E337(1)010A(2)E060	33.0	10.0	60	1826	1643	730	1
10	330	E/7360-38	T495E337(1)010A(2)E100	33.0	10.0	100	1414	1273	566	1
10	470	X/7343-43	T495X477(1)010A(2)E045	47.0	10.0	45	1915	1724	766	1
10	470	X/7343-43	T495X477(1)010A(2)E050	47.0	10.0	50	1817	1635	727	1
10	470	X/7343-43	T495X477(M)010A(2)E060	47.0	10.0	60	1658	1492	663	1
10	470	X/7343-43	T495X477(M)010A(2)E100	47.0	10.0	100	1285	1157	514	1
10	470	X/7343-43	T495X477(M)010A(2)E200	47.0	10.0	200	908	817	363	1
10	470	E/7360-38	T495E477(1)010A(2)E040	47.0	10.0	40	2236	2012	894	1
10	470	E/7360-38	T495E477(1)010A(2)E060	47.0	10.0	60	1826	1643	730	1
10	470	E/7360-38	T495E477(1)010A(2)E100	47.0	10.0	100	1414	1273	566	1
16	3.3	A/3216-18	T495A335(1)016A(2)E3K0	0.5	6.0	3000	158	142	63	1
16	4.7	A/3216-18	T495A475(1)016A(2)E2K0	0.8	6.0	2000	194	175	78	1
16	4.7	B/3528-21	T495B475(1)016A(2)E700	0.8	6.0	700	348	313	139	1
16	6.8	C/6032-28	T495C685(1)016A(2)E750	1.1	6.0	750	383	345	153	1
16	10	B/3528-21	T495B106(1)016A(2)E800	1.6	6.0	800	326	293	130	1
16	10	T/3528-12	T495T106(M)016A(2)E4K0	1.6	8.0	4000	132	119	53	1
16	15	A/3216-18	T495A156(1)016A(2)E2K5	2.4	8.0	2500	173	156	69	1
16	15	B/3528-21	T495B156(1)016A(2)E800	2.4	6.0	800	326	293	130	1
16	33	C/6032-28	T495C336(1)016A(2)E200	5.3	6.0	200	742	668	297	1
16	33	C/6032-28	T495C336(1)016A(2)E225	5.3	6.0	225	699	629	280	1
16	33	C/6032-28	T495C336(1)016A(2)E275	5.3	6.0	275	632	569	253	1
16	33	D/7343-31	T495D336(1)016A(2)E150	5.3	6.0	150	1000	900	400	1
16	33	D/7343-31	T495D336(1)016A(2)E175	5.3	6.0	175	926	833	370	1
16	33	D/7343-31	T495D336(1)016A(2)E225	5.3	4.0	225	816	734	326	1
16	33	D/7343-31	T495D336(1)016A(2)4095	5.3	4.0	250	775	698	310	1
16	47	C/6032-28	T495C476(1)016A(2)E350	7.5	6.0	350	561	505	224	1
16	47	D/7343-31	T495D476(1)016A(2)E080	7.5	6.0	80	1369	1232	548	1
16	47	D/7343-31	T495D476(1)016A(2)E100	7.5	6.0	100	1225	1103	490	1
VDC	μF	KEMET/EIA	(See below for part options)	μAmps +20°C Max/5 Min	% @ +20°C 120 Hz Max	mΩ @ 20°C 100 kHz Max	(mA) 100 kHz 25°C	(mA) 100 kHz +85°C	(mA) 100 kHz +125°C	Reflow Temp ≤ 260°C
Rated Voltage	Rated Cap	Case Code/ Case Size	KEMET Part Number	DC Leakage	DF	ESR	Maximum Allowable Ripple Current			Moisture Sensitivity

(1) To complete KEMET part number, insert M for ±20% or K for ±10%. Designates capacitance tolerance.

(2) To complete KEMET part number, insert T = 100% Matte Tin (Sn) Plated, G = Gold Plated, H = Standard Solder coated (SnPb 5% Pb minimum). Designates termination finish.

Refer to Ordering Information for additional detail.

Higher voltage ratings and tighter tolerance product including ESR may be substituted within the same size at KEMET's option. Voltage substitution will be marked with the higher voltage rating. Substitutions can include better than series.

Table 1 – Ratings & Part Number Reference cont'd

Rated Voltage	Rated Cap	Case Code/ Case Size	KEMET Part Number	DC Leakage	DF	ESR	Maximum Allowable Ripple Current			Moisture Sensitivity
VDC	μF	KEMET/EIA	(See below for part options)	μAmps +20°C Max/5 Min	% @ +20°C 120 Hz Max	mΩ @ 20°C 100 kHz Max	(mA) 100 kHz 25°C	(mA) 100 kHz +85°C	(mA) 100 kHz +125°C	Reflow Temp ≤ 260°C
16	47	D/7343-31	T495D476(1)016A(2)E150	7.5	6.0	150	1000	900	400	1
16	47	D/7343-31	T495D476(1)016A(2)4095	7.5	6.0	200	866	779	346	1
16	68	V/7343-20	T495V686(1)016A(2)E180	10.9	6.0	180	833	750	333	1
16	68	V/7343-20	T495V686(1)016A(2)E300	10.9	6.0	300	645	581	258	1
16	68	D/7343-31	T495D686(1)016A(2)E070	10.9	6.0	70	1464	1318	586	1
16	68	D/7343-31	T495D686(1)016A(2)E100	10.9	6.0	100	1225	1103	490	1
16	68	D/7343-31	T495D686(1)016A(2)E150	10.9	6.0	150	1000	900	400	1
16	100	D/7343-31	T495D107(1)016A(2)E100	16.0	8.0	100	1225	1103	490	1
16	100	D/7343-31	T495D107(1)016A(2)E125	16.0	8.0	125	1095	986	438	1
16	100	X/7343-43	T495X107(1)016A(2)E080	16.0	8.0	80	1436	1292	574	1
16	100	X/7343-43	T495X107(1)016A(2)E100	16.0	8.0	100	1285	1157	514	1
16	100	X/7343-43	T495X107(1)016A(2)4095	16.0	8.0	125	1149	1034	460	1
16	150	D/7343-31	T495D157(M)016A(2)E060	24.0	12.0	60	1581	1423	632	1
16	150	D/7343-31	T495D157(M)016A(2)E085	24.0	8.0	85	1328	1195	531	1
16	150	D/7343-31	T495D157(M)016A(2)E100	24.0	8.0	100	1225	1103	490	1
16	150	D/7343-31	T495D157(1)016A(2)E125	24.0	8.0	125	1095	986	438	1
16	150	D/7343-31	T495D157(1)016A(2)E150	24.0	8.0	150	1000	900	400	1
16	150	X/7343-43	T495X157(1)016A(2)E075	24.0	8.0	75	1483	1335	593	1
16	150	X/7343-43	T495X157(1)016A(2)E100	24.0	8.0	100	1285	1157	514	1
16	220	X/7343-43	T495X227(1)016A(2)E100	35.2	8.0	100	1285	1157	514	1
16	220	E/7360-38	T495E227(1)016A(2)E050	35.2	12.0	50	2000	1800	800	1
16	220	E/7360-38	T495E227(1)016A(2)E075	35.2	8.0	75	1633	1470	653	1
16	220	E/7360-38	T495E227(1)016A(2)E100	35.2	7.2	100	1414	1273	566	1
16	220	E/7360-38	T495E227(1)016A(2)E150	35.2	7.2	150	1155	1040	462	1
20	1	A/3216-18	T495A105(1)020A(2)E3K0	0.5	4.0	3000	158	142	63	1
20	10	B/3528-21	T495B106(1)020A(2)E1K0	2.0	6.0	1000	292	263	117	1
20	10	B/3528-21	T495B106(1)020A(2)E800	2.0	6.0	800	326	293	130	1
20	10	C/6032-28	T495C106(1)020A(2)E300	2.0	6.0	300	606	545	242	1
20	10	C/6032-28	T495C106(1)020A(2)E350	2.0	6.0	350	561	505	224	1
20	10	C/6032-28	T495C106(1)020A(2)E400	2.0	6.0	400	524	472	210	1
20	10	C/6032-28	T495C106(1)020A(2)E475	2.0	6.0	475	481	433	192	1
20	15	C/6032-28	T495C156(1)020A(2)E375	3.0	6.0	375	542	488	217	1
20	15	D/7343-31	T495D156(1)020A(2)E275	3.0	4.0	275	739	665	296	1
20	15	D/7343-31	T495D156(1)020A(2)4095	3.0	4.0	275	739	665	296	1
20	22	D/7343-31	T495D226(1)020A(2)E180	4.4	4.0	180	913	822	365	1
20	22	D/7343-31	T495D226(1)020A(2)E225	4.4	4.0	225	816	734	326	1
20	22	D/7343-31	T495D226(1)020A(2)4095	4.4	4.0	275	739	665	296	1
20	33	D/7343-31	T495D336(1)020A(2)E100	6.6	6.0	100	1225	1103	490	1
20	33	D/7343-31	T495D336(1)020A(2)E150	6.6	6.0	150	1000	900	400	1
20	33	D/7343-31	T495D336(1)020A(2)E200	6.6	6.0	200	866	779	346	1
20	47	D/7343-31	T495D476(1)020A(2)E075	9.4	6.0	75	1414	1273	566	1
20	47	D/7343-31	T495D476(1)020A(2)E100	9.4	6.0	100	1225	1103	490	1
20	47	D/7343-31	T495D476(1)020A(2)E175	9.4	6.0	175	926	833	370	1
20	47	X/7343-43	T495X476(1)020A(2)E065	9.4	8.0	65	1593	1434	637	1
20	47	X/7343-43	T495X476(1)020A(2)E100	9.4	6.0	100	1285	1157	514	1
20	47	X/7343-43	T495X476(1)020A(2)E125	9.4	6.0	125	1149	1034	460	1
20	47	X/7343-43	T495X476(1)020A(2)E150	9.4	4.0	150	1049	944	420	1
20	47	X/7343-43	T495X476(1)020A(2)4095	9.4	4.0	150	1049	944	420	1
20	68	D/7343-31	T495D686(1)020A(2)E070	13.6	8.0	70	1464	1318	586	1
20	68	D/7343-31	T495D686(1)020A(2)E150	13.6	8.0	150	1000	900	400	1
20	68	X/7343-43	T495X686(1)020A(2)E120	13.6	6.0	120	1173	1056	469	1
VDC	μF	KEMET/EIA	(See below for part options)	μAmps +20°C Max/5 Min	% @ +20°C 120 Hz Max	mΩ @ 20°C 100 kHz Max	(mA) 100 kHz 25°C	(mA) 100 kHz +85°C	(mA) 100 kHz +125°C	Reflow Temp ≤ 260°C
Rated Voltage	Rated Cap	Case Code/ Case Size	KEMET Part Number	DC Leakage	DF	ESR	Maximum Allowable Ripple Current			Moisture Sensitivity

(1) To complete KEMET part number, insert M for ±20% or K for ±10%. Designates capacitance tolerance.

(2) To complete KEMET part number, insert T = 100% Matte Tin (Sn) Plated, G = Gold Plated, H = Standard Solder coated (SnPb 5% Pb minimum). Designates termination finish.

Refer to Ordering Information for additional detail.

Higher voltage ratings and tighter tolerance product including ESR may be substituted within the same size at KEMET's option. Voltage substitution will be marked with the higher voltage rating. Substitutions can include better than series.

Table 1 – Ratings & Part Number Reference cont'd

Rated Voltage	Rated Cap	Case Code/ Case Size	KEMET Part Number	DC Leakage	DF	ESR	Maximum Allowable Ripple Current			Moisture Sensitivity
VDC	µF	KEMET/EIA	(See below for part options)	µAmps +20°C Max/5 Min	% @ +20°C 120 Hz Max	mΩ @ 20°C 100 kHz Max	(mA) 100 kHz 25°C	(mA) 100 kHz +85°C	(mA) 100 kHz +125°C	Reflow Temp ≤ 260°C
20	68	X/7343-43	T495X686(1)020A(2)E150	13.6	6.0	150	1049	944	420	1
20	68	X/7343-43	T495X686(1)020A(2)4095	13.6	6.0	150	1049	944	420	1
20	100	X/7343-43	T495X107(1)020A(2)E100	20.0	6.0	100	1285	1157	514	1
20	100	X/7343-43	T495X107(1)020A(2)E150	20.0	8.0	150	1049	944	420	1
20	100	E/7360-38	T495E107(1)020A(2)E060	20.0	8.0	60	1826	1643	730	1
20	100	E/7360-38	T495E107(1)020A(2)E085	20.0	8.0	85	1534	1381	614	1
20	100	E/7360-38	T495E107(1)020A(2)E100	20.0	8.0	100	1414	1273	566	1
20	100	E/7360-38	T495E107(1)020A(2)E200	20.0	8.0	200	1000	900	400	1
20	150	E/7360-38	T495E157(1)020A(2)E080	30.0	8.0	80	1581	1423	632	1
25	0.47	A/3216-18	T495A474(1)025A(2)E4K5	0.5	4.0	4500	129	116	52	1
25	1	A/3216-18	T495A105(1)025A(2)E2K5	0.5	4.0	2500	173	156	69	1
25	1	A/3216-18	T495A105(1)025A(2)E3K0	0.5	4.0	3000	158	142	63	1
25	1	A/3216-18	T495A105(1)025A(2)E5K0	0.5	4.0	5000	4	4	2	1
25	2.2	C/6032-28	T495C225(1)025A(2)E1K3	0.6	6.0	1300	291	262	116	1
25	3.3	C/6032-28	T495C335(1)025A(2)E750	0.8	6.0	750	383	345	153	1
25	4.7	C/6032-28	T495C475(1)025A(2)E575	1.2	6.0	575	437	393	175	1
25	4.7	B/3528-21	T495B475(1)025A(2)E1K0	1.2	6.0	1000	292	263	117	1
25	6.8	B/3528-21	T495B685(1)025A(2)E1K5	1.7	6.0	1500	238	214	95	1
25	6.8	C/6032-28	T495C685(1)025A(2)E400	1.7	6.0	400	524	472	210	1
25	6.8	C/6032-28	T495C685(1)025A(2)E490	1.7	6.0	490	474	427	190	1
25	6.8	C/6032-28	T495C685(1)025A(2)E500	1.7	6.0	500	469	422	188	1
25	10	C/6032-28	T495C106(1)025A(2)E275	2.5	6.0	275	632	569	253	1
25	10	C/6032-28	T495C106(1)025A(2)E300	2.5	6.0	300	606	545	242	1
25	10	C/6032-28	T495C106(1)025A(2)E450	2.5	6.0	450	494	445	198	1
25	15	D/7343-31	T495D156(1)025A(2)E100	3.8	6.0	100	1225	1103	490	1
25	15	D/7343-31	T495D156(1)025A(2)E275	3.8	6.0	275	739	665	296	1
25	15	D/7343-31	T495D156(1)025A(2)4095	3.8	6.0	275	739	665	296	1
25	15	X/7343-43	T495X156(1)025A(2)E200	3.8	4.0	200	908	817	363	1
25	15	X/7343-43	T495X156(1)025A(2)4095	3.8	4.0	200	908	817	363	1
25	22	C/6032-28	T495C226(1)025A(2)E275	5.5	6.0	275	632	569	253	1
25	22	C/6032-28	T495C226(1)025A(2)E300	5.5	8.0	300	606	545	242	1
25	22	C/6032-28	T495C226(1)025A(2)E900	5.5	6.0	900	350	315	140	1
25	22	D/7343-31	T495D226(1)025A(2)E200	5.5	6.0	200	866	779	346	1
25	22	X/7343-43	T495X226(1)025A(2)E225	5.5	4.0	225	856	770	342	1
25	22	X/7343-43	T495X226(1)025A(2)4095	5.5	4.0	225	856	770	342	1
25	33	D/7343-31	T495D336(1)025A(2)E090	8.3	6.0	90	1291	1162	516	1
25	33	D/7343-31	T495D336(1)025A(2)E100	8.3	6.0	100	1225	1103	490	1
25	33	D/7343-31	T495D336(1)025A(2)E225	8.3	6.0	225	816	734	326	1
25	33	D/7343-31	T495D336(1)025A(2)E300	8.3	6.0	300	707	636	283	1
25	33	X/7343-43	T495X336(1)025A(2)E100	8.3	4.0	100	1285	1157	514	1
25	33	X/7343-43	T495X336(1)025A(2)E175	8.3	4.0	175	971	874	388	1
25	33	X/7343-43	T495X336(1)025A(2)E200	8.3	4.0	200	908	817	363	1
25	33	X/7343-43	T495X336(1)025A(2)4095	8.3	4.0	175	971	874	388	1
25	47	X/7343-43	T495X476(M)025A(2)E080	11.8	8.0	80	1436	1292	574	1
25	47	X/7343-43	T495X476(M)025A(2)E150	11.8	6.0	150	1049	944	420	1
25	47	X/7343-43	T495X476(M)025A(2)E185	11.8	8.0	185	944	850	378	1
25	47	X/7343-43	T495X476(M)025A(2)E200	11.8	6.0	200	908	817	363	1
25	47	D/7343-31	T495D476(M)025A(2)E120	11.8	10.0	120	1118	1006	447	1
25	47	D/7343-31	T495D476(1)025A(2)E250	11.8	10.0	250	775	698	310	1
25	68	D/7343-31	T495D686(1)025A(2)E150	17.0	10.0	150	1000	900	400	1
25	68	D/7343-31	T495D686(1)025A(2)E200	17.0	10.0	200	866	779	346	1
VDC	µF	KEMET/EIA	(See below for part options)	µAmps +20°C Max/5 Min	% @ +20°C 120 Hz Max	mΩ @ 20°C 100 kHz Max	(mA) 100 kHz 25°C	(mA) 100 kHz +85°C	(mA) 100 kHz +125°C	Reflow Temp ≤ 260°C
Rated Voltage	Rated Cap	Case Code/ Case Size	KEMET Part Number	DC Leakage	DF	ESR	Maximum Allowable Ripple Current			Moisture Sensitivity

(1) To complete KEMET part number, insert M for ±20% or K for ±10%. Designates capacitance tolerance.

(2) To complete KEMET part number, insert T = 100% Matte Tin (Sn) Plated, G = Gold Plated, H = Standard Solder coated (SnPb 5% Pb minimum). Designates termination finish.

Refer to Ordering Information for additional detail.

Higher voltage ratings and tighter tolerance product including ESR may be substituted within the same size at KEMET's option. Voltage substitution will be marked with the higher voltage rating. Substitutions can include better than series.

Table 1 – Ratings & Part Number Reference cont'd

Rated Voltage	Rated Cap	Case Code/ Case Size	KEMET Part Number	DC Leakage	DF	ESR	Maximum Allowable Ripple Current			Moisture Sensitivity
VDC	μF	KEMET/EIA	(See below for part options)	μAmps +20°C Max/5 Min	% @ +20°C 120 Hz Max	mΩ @ 20°C 100 kHz Max	(mA) 100 kHz 25°C	(mA) 100 kHz +85°C	(mA) 100 kHz +125°C	Reflow Temp ≤ 260°C
25	68	X/7343-43	T495X686(1)025A(2)E125	17.0	8.0	125	1149	1034	460	1
25	68	X/7343-43	T495X686(1)025A(2)E150	17.0	8.0	150	1049	944	420	1
25	68	X/7343-43	T495X686(1)025A(2)E200	17.0	8.0	200	908	817	363	1
25	100	E/7360-38	T495E107(1)025A(2)E100	25.0	8.0	100	1414	1273	566	1
35	0.47	B/3528-21	T495B474(1)035A(2)E1K5	0.5	4.0	1500	238	214	95	1
35	0.47	B/3528-21	T495B474(1)035A(2)E2K2	0.5	4.0	2200	197	177	79	1
35	1	A/3216-18	T495A105(1)035A(2)E3K0	0.5	4.0	3000	158	142	63	1
35	1	B/3528-21	T495B105(1)035A(2)E1K5	0.5	4.0	1500	238	214	95	1
35	1	B/3528-21	T495B105(1)035A(2)E1K7	0.5	4.0	1700	224	202	90	1
35	2.2	B/3528-21	T495B225(1)035A(2)E1K5	0.8	6.0	1500	238	214	95	1
35	2.2	C/6032-28	T495C225(1)035A(2)E750	0.8	6.0	750	383	345	153	1
35	3.3	B/3528-21	T495B335(1)035A(2)E900	1.2	6.0	900	307	276	123	1
35	3.3	C/6032-28	T495C335(1)035A(2)E525	1.2	6.0	525	458	412	183	1
35	3.3	C/6032-28	T495C335(1)035A(2)E550	1.2	6.0	550	447	402	179	1
35	3.3	C/6032-28	T495C335(1)035A(2)E600	1.2	6.0	600	428	385	171	1
35	4.7	B/3528-21	T495B475(1)035A(2)E1K0	1.6	6.0	1000	292	263	117	1
35	4.7	C/6032-28	T495C475(1)035A(2)E450	1.6	6.0	450	494	445	198	1
35	4.7	C/6032-28	T495C475(1)035A(2)E500	1.6	6.0	500	469	422	188	1
35	4.7	C/6032-28	T495C475(1)035A(2)E600	1.6	6.0	600	428	385	171	1
35	4.7	C/6032-28	T495C475(1)035A(2)4095	1.6	6.0	600	428	385	171	1
35	6.8	D/7343-31	T495D685(1)035A(2)E150	2.4	6.0	150	1000	900	400	1
35	6.8	D/7343-31	T495D685(1)035A(2)E400	2.4	6.0	400	612	551	245	1
35	6.8	X/7343-43	T495X685(1)035A(2)E300	2.4	4.0	300	742	668	297	1
35	6.8	X/7343-43	T495X685(1)035A(2)4095	2.4	4.0	300	742	668	297	1
35	10	D/7343-31	T495D106(1)035A(2)E125	3.5	6.0	125	1095	986	438	1
35	10	D/7343-31	T495D106(1)035A(2)E250	3.5	6.0	250	775	698	310	1
35	10	D/7343-31	T495D106(1)035A(2)E300	3.5	6.0	300	707	636	283	1
35	10	D/7343-31	T495D106(1)035A(2)4095	3.5	4.0	300	707	636	283	1
35	10	X/7343-43	T495X106(1)035A(2)E175	3.5	6.0	175	971	874	388	1
35	10	X/7343-43	T495X106(1)035A(2)E200	3.5	6.0	200	908	817	363	1
35	10	X/7343-43	T495X106(1)035A(2)E250	3.5	4.0	250	812	731	325	1
35	10	X/7343-43	T495X106(1)035A(2)4095	3.5	4.0	250	812	731	325	1
35	15	D/7343-31	T495D156(1)035A(2)E225	5.3	6.0	225	816	734	326	1
35	15	D/7343-31	T495D156(1)035A(2)E300	5.3	6.0	300	707	636	283	1
35	15	X/7343-43	T495X156(1)035A(2)E200	5.3	6.0	200	908	817	363	1
35	15	X/7343-43	T495X156(1)035A(2)E225	5.3	6.0	225	856	770	342	1
35	15	X/7343-43	T495X156(1)035A(2)4095	5.3	6.0	225	856	770	342	1
35	22	D/7343-31	T495D226(1)035A(2)E125	7.7	6.0	125	1095	986	438	1
35	22	D/7343-31	T495D226(1)035A(2)E200	7.7	6.0	200	866	779	346	1
35	22	D/7343-31	T495D226(1)035A(2)E250	7.7	6.0	250	775	698	310	1
35	22	D/7343-31	T495D226(1)035A(2)E300	7.7	6.0	300	707	636	283	1
35	22	X/7343-43	T495X226(1)035A(2)E125	7.7	6.0	125	1149	1034	460	1
35	22	X/7343-43	T495X226(1)035A(2)E200	7.7	6.0	200	908	817	363	1
35	22	X/7343-43	T495X226(1)035A(2)E275	7.7	6.0	275	775	698	310	1
35	22	X/7343-43	T495X226(1)035A(2)4095	7.7	6.0	300	742	668	297	1
35	33	D/7343-31	T495D336(1)035A(2)E200	11.6	6.0	200	866	779	346	1
35	33	D/7343-31	T495D336(1)035A(2)E300	11.6	6.0	300	707	636	283	1
35	33	X/7343-43	T495X336(1)035A(2)E100	11.6	6.0	100	1285	1157	514	1
35	33	X/7343-43	T495X336(1)035A(2)E175	11.6	6.0	175	971	874	388	1
35	33	X/7343-43	T495X336(1)035A(2)E250	11.6	6.0	250	812	731	325	1
35	33	E/7360-38	T495E336(1)035A(2)E200	11.6	6.0	200	1000	900	400	1
VDC	μF	KEMET/EIA	(See below for part options)	μAmps +20°C Max/5 Min	% @ +20°C 120 Hz Max	mΩ @ 20°C 100 kHz Max	(mA) 100 kHz 25°C	(mA) 100 kHz +85°C	(mA) 100 kHz +125°C	Reflow Temp ≤ 260°C
Rated Voltage	Rated Cap	Case Code/ Case Size	KEMET Part Number	DC Leakage	DF	ESR	Maximum Allowable Ripple Current			Moisture Sensitivity

(1) To complete KEMET part number, insert M for ±20% or K for ±10%. Designates capacitance tolerance.

(2) To complete KEMET part number, insert T = 100% Matte Tin (Sn) Plated, G = Gold Plated, H = Standard Solder coated (SnPb 5% Pb minimum). Designates termination finish.

Refer to Ordering Information for additional detail.

Higher voltage ratings and tighter tolerance product including ESR may be substituted within the same size at KEMET's option. Voltage substitution will be marked with the higher voltage rating. Substitutions can include better than series.

Table 1 – Ratings & Part Number Reference cont'd

Rated Voltage	Rated Cap	Case Code/ Case Size	KEMET Part Number	DC Leakage	DF	ESR	Maximum Allowable Ripple Current			Moisture Sensitivity
VDC	μF	KEMET/EIA	(See below for part options)	μAmps +20°C Max/5 Min	% @ +20°C 120 Hz Max	mΩ @ 20°C 100 kHz Max	(mA) 100 kHz 25°C	(mA) 100 kHz +85°C	(mA) 100 kHz +125°C	Reflow Temp ≤ 260°C
35	47	X/7343-43	T495X476(1)035A(2)E185	16.5	8.0	185	944	850	378	1
35	47	X/7343-43	T495X476(1)035A(2)E200	16.5	8.0	200	908	817	363	1
35	47	X/7343-43	T495X476(1)035A(2)E300	16.5	8.0	300	742	668	297	1
50	1	C/6032-28	T495C105(1)050A(2)E1K3	0.5	4.0	1300	291	262	116	1
50	2.2	D/7343-31	T495D225(1)050A(2)E600	1.1	6.0	600	500	450	200	1
50	3.3	D/7343-31	T495D335(1)050A(2)E700	1.7	6.0	700	463	417	185	1
50	4.7	D/7343-31	T495D475(1)050A(2)E275	2.4	6.0	275	739	665	296	1
50	4.7	D/7343-31	T495D475(1)050A(2)E300	2.4	6.0	300	707	636	283	1
50	4.7	X/7343-43	T495X475(1)050A(2)E300	2.4	4.0	300	742	668	297	1
50	4.7	X/7343-43	T495X475(1)050A(2)4095	2.4	4.0	300	742	668	297	1
50	6.8	D/7343-31	T495D685(1)050A(2)E190	3.4	6.0	190	889	800	356	1
50	6.8	D/7343-31	T495D685(1)050A(2)E200	3.4	6.0	200	866	779	346	1
50	6.8	D/7343-31	T495D685(1)050A(2)E275	3.4	6.0	275	739	665	296	1
50	6.8	D/7343-31	T495D685(1)050A(2)E300	3.4	8.0	300	707	636	283	1
50	10	X/7343-43	T495X106(1)050A(2)E250	5.0	8.0	250	812	731	325	1
50	10	X/7343-43	T495X106(1)050A(2)E260	5.0	6.0	260	797	717	319	1
50	10	X/7343-43	T495X106(1)050A(2)E300	5.0	6.0	300	742	668	297	1
50	15	X/7343-43	T495X156(1)050A(2)E200	7.5	8.0	200	908	817	363	1
50	15	X/7343-43	T495X156(1)050A(2)E300	7.5	8.0	300	742	668	297	1
Rated Voltage	Rated Cap	Case Code/ Case Size	KEMET Part Number	DC Leakage	DF	ESR	Maximum Allowable Ripple Current			Moisture Sensitivity

(1) To complete KEMET part number, insert M for ±20% or K for ±10%. Designates capacitance tolerance.

(2) To complete KEMET part number, insert T = 100% Matte Tin (Sn) Plated, G = Gold Plated, H = Standard Solder coated (SnPb 5% Pb minimum). Designates termination finish.

Refer to Ordering Information for additional detail.

Higher voltage ratings and tighter tolerance product including ESR may be substituted within the same size at KEMET's option. Voltage substitution will be marked with the higher voltage rating. Substitutions can include better than series.

Recommended Voltage Derating Guidelines

-55°C to 125°C		
% Change in Working DC Voltage with Temperature	50% of V _R	V _R
Recommended Maximum Application Voltage	100% of V _R	V _R



Ripple Current/Ripple Voltage

KEMET Series and Case Code	EIA Case Code	Maximum Power Dissipation (P max) mWatts @ 25°C w/+20°C Rise
A	3216-18	75
B	3528-21	85
C	6032-28	110
D	7343-31	150
X	7343-43	165
E	7360-38	200
T428P	7360-38	325
S	3216-12	60
T	3528-12	70
U	6032-15	90
V	7343-20	125
T510X	7343-43	270
T510E	7360-38	285

Temperature Compensation Multipliers for Maximum Power Dissipation		
≤ 25°C	85°C	125°C
1.00	0.90	0.40

T = Environmental Temperature

Using the P max of the device, the maximum allowable rms ripple current or voltage may be determined.

$$I(max) = \sqrt{P_{max}/R}$$

$$E(max) = \sqrt{P_{max} \cdot R}$$

I = rms ripple current (amperes)

E = rms ripple voltage (volts)

P max = maximum power dissipation (watts)

R = ESR at specified frequency (ohms)

Reverse Voltage

Solid tantalum capacitors are polar devices and may be permanently damaged or destroyed if connected with the wrong polarity. The positive terminal is identified on the capacitor body by a stripe plus in some cases a beveled edge. A small degree of transient reverse voltage is permissible for short periods per the table. The capacitors should not be operated continuously in reverse mode, even within these limits.

Temperature	Permissible Transient Reverse Voltage
25°C	15% of Rated Voltage
85°C	5% of Rated Voltage
125°C	1% of Rated Voltage

Table 2 – Land Dimensions/Courtyard

KEMET	Metric Size Code	Density Level A: Maximum (Most) Land Protrusion (mm)					Density Level B: Median (Nominal) Land Protrusion (mm)					Density Level C: Minimum (Least) Land Protrusion (mm)				
		X	Y	C	V1	V2	X	Y	C	V1	V2	X	Y	C	V1	V2
A	3216-18	1.35	2.15	1.45	6.10	2.80	1.25	1.75	1.35	5.00	2.30	1.15	1.35	1.25	4.10	2.00
B	3528-21	2.35	2.15	1.45	6.10	4.00	2.25	1.75	1.35	5.00	3.50	2.15	1.35	1.25	4.10	3.20
C	6032-28	2.35	2.65	2.60	8.90	4.40	2.25	2.25	2.50	7.80	3.90	2.15	1.85	2.40	6.90	3.60
D	7343-31	2.55	3.75	2.70	10.20	5.50	2.45	3.35	2.60	9.10	5.00	2.35	2.95	2.50	8.20	4.70
E ¹	7360-38	4.25	2.65	3.20	10.10	7.20	4.15	2.25	3.30	9.40	6.70	4.05	1.85	3.00	8.10	6.40
T	3528-12	2.35	2.15	1.45	6.10	4.00	2.25	1.75	1.35	5.00	3.50	2.15	1.35	1.25	4.10	3.20
V	7343-20	2.55	3.75	2.70	10.20	5.50	2.45	3.35	2.60	9.10	5.00	2.35	2.95	2.50	8.20	4.70
X ¹	7343-43	2.55	3.75	2.70	10.20	5.50	2.45	3.35	2.60	9.10	5.00	2.35	2.95	2.50	8.20	4.70

Density Level A: For low-density product applications. Recommended for wave solder applications and provides a wider process window for reflow solder processes.

Density Level B: For products with a moderate level of component density. Provides a robust solder attachment condition for reflow solder processes.

Density Level C: For high component density product applications. Before adapting the minimum land pattern variations the user should perform qualification testing based on the conditions outlined in IPC Standard 7351 (IPC-7351).

¹ Height of these chips may create problems in wave soldering.



Soldering Process

KEMET's families of surface mount capacitors are compatible with wave (single or dual), convection, IR, or vapor phase reflow techniques. Preheating of these components is recommended to avoid extreme thermal stress. KEMET's recommended profile conditions for convection and IR reflow reflect the profile conditions of the IPC/J-STD-020D standard for moisture sensitivity testing. The devices can safely withstand a maximum of three reflow passes at these conditions.

Please note that although the X/7343-43 case size can withstand wave soldering, the tall profile (4.3 mm maximum) dictates care in wave process development.

Hand soldering should be performed with care due to the difficulty in process control. If performed, care should be taken to avoid contact of the soldering iron to the molded case. The iron should be used to heat the solder pad, applying solder between the pad and the termination, until reflow occurs. Once reflow occurs, the iron should be removed immediately. "Wiping" the edges of a chip and heating the top surface is not recommended.

During typical reflow operations, a slight darkening of the gold-colored epoxy may be observed. This slight darkening is normal and not harmful to the product. Marking permanency is not affected by this change.

Profile Feature	SnPb Assembly	Pb-Free Assembly
Preheat/Soak		
Temperature Minimum (T_{smin})	100°C	150°C
Temperature Maximum (T_{smax})	150°C	200°C
Time (t_s) from T_{smin} to T_{smax}	60 – 120 seconds	60 – 120 seconds
Ramp-up Rate (T_L to T_p)	3°C/seconds maximum	3°C/seconds maximum
Liquidous Temperature (T_L)	183°C	217°C
Time Above Liquidous (t_L)	60 – 150 seconds	60 – 150 seconds
Peak Temperature (T_p)	220°C* 235°C**	250°C* 260°C**
Time within 5°C of Maximum Peak Temperature (t_p)	20 seconds maximum	30 seconds maximum
Ramp-down Rate (T_p to T_L)	6°C/seconds maximum	6°C/seconds maximum
Time 25°C to Peak	6 minutes maximum	8 minutes maximum

Note: All temperatures refer to the center of the package, measured on the package body surface that is facing up during assembly reflow.

*Case Size D, E, P, Y, and X

**Case Size A, B, C, H, I, K, M, R, S, T, U, V, W, and Z

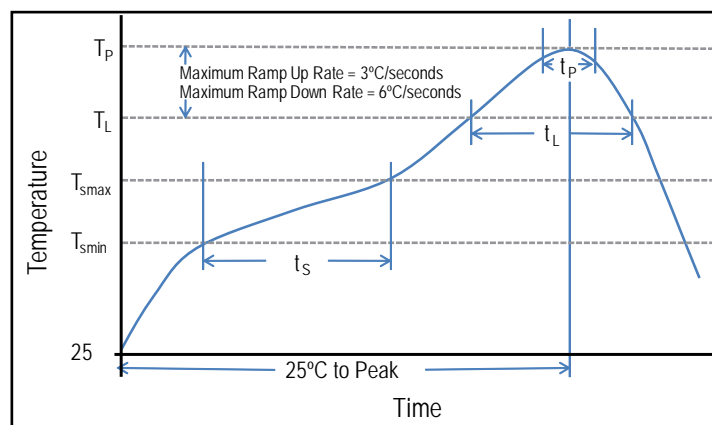

Construction

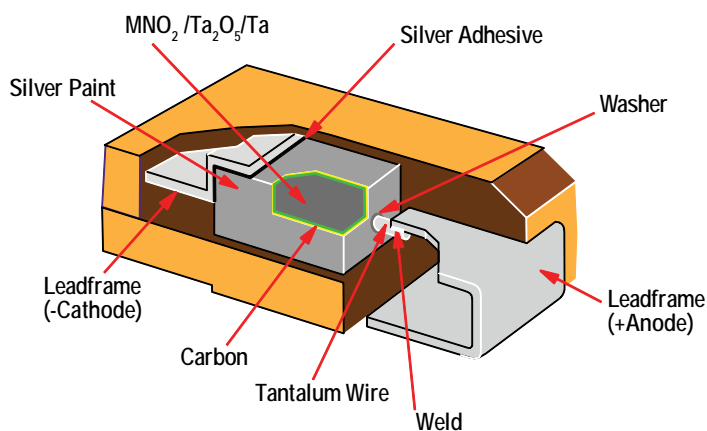

Capacitor Marking

C, D, X Case Sizes



* 230 = 30th week of 2012

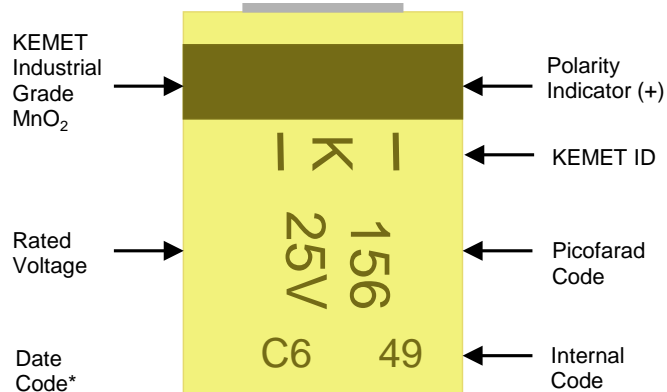

Date Code *	
1 st digit = Last number of Year	9 = 2009 0 = 2010 1 = 2011 2 = 2012
2 nd and 3 rd digit = Week of the Year	01 = 1 st week of the Year to 52 = 52 nd week of the Year

Date Code*		
Year	Month	
X = 2009	1 = Jan	7 = Jul
A = 2010	2 = Feb	8 = Aug
B = 2011	3 = Mar	9 = Spt
C = 2012	4 = Apr	0 = Oct
D = 2013	5 = May	N = Nov
E = 2014	6 = Jun	D = Dec

Storage

Tantalum chip capacitors should be stored in normal working environments. While the chips themselves are quite robust in other environments, solderability will be degraded by exposure to high temperatures, high humidity, corrosive atmospheres, and long term storage. In addition, packaging materials will be degraded by high temperature– reels may soften or warp and tape peel force may increase. KEMET recommends that maximum storage temperature not exceed 40°C and maximum storage humidity not exceed 60% relative humidity. Temperature fluctuations should be minimized to avoid condensation on the parts and atmospheres should be free of chlorine and sulphur bearing compounds. For optimized solderability chip stock should be used promptly, preferably within three years of receipt.

Overview

The low ESR, surge-robust T510 Series is designed for demanding applications that require high surge current and high ripple current capability. This series builds upon the proven capabilities of our industrial grade tantalum chip capacitors to offer several advantages such as low ESR, high ripple current

capability, excellent capacitance stability, and improved resistance to high in-rush currents. These benefits are achieved through the utilization of multiple anodes as well as high-stress, low impedance electrical conditioning performed prior to screening.

Benefits

- Meets or exceeds EIA Standard 535BAAC
- Taped and reeled per EIA 481-1
- High surge current capability
- Optional gold-plated terminations
- High ripple current capability
- 100% surge current test
- 100% steady-state accelerated aging
- Capacitance values of 10 μF to 1,000 μF
- Tolerances of $\pm 10\%$ and $\pm 20\%$
- Voltage rating of 4 to 50 VDC
- Case sizes E and X
- ESR as low as 18 m Ω
- RoHS Compliant and lead-free terminations
- Operating temperature range of -55°C to +125°C

Applications

Typical applications include decoupling and filtering in industrial and automotive end applications, such as DC/DC converters, portable electronics, telecommunications, and control units requiring high ripple current capability.

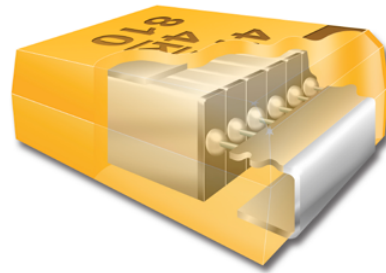

Environmental Compliance

RoHS Compliant (6/6) according to Directive 2002/95/EC when ordered with 100% Sn solder.



RoHS Compliant

SPICE

For a detailed analysis of specific part numbers, please visit www.kemet.com for a free download of KEMET's SPICE software. The KEMET SPICE program is freeware intended to aid design engineers in analyzing the performance of these capacitors over frequency, temperature, ripple, and DC bias conditions.

Ordering Information

T	510	X	477	M	006	A	T	E800	
Capacitor Class	Series	Case Size	Capacitance Code (pF)	Capacitance Tolerance	Voltage	Failure Rate/Design	Lead Material	ESR	Packaging (C-Spec)
T = Tantalum	Multiple Anode Low ESR	E, X	First two digits represent significant figures. Third digit specifies number of zeros.	K = ±10% M = ±20%	004 = 4 V 006 = 6.3 V 010 = 10 V 016 = 16 V 020 = 20 V 025 = 25 V 035 = 35 V 050 = 50 V	A = N/A Z = N/A	T = 100% Matte Tin (Sn) Plated H = Standard Solder Coated (SnPb 5% Pb minimum) G = Gold Plated (A, B, C, D, X only)	Last three digits specify ESR in mΩ. (800 = 800 mΩ)	Blank = 7" Reel 7280 = 13" Reel

Performance Characteristics

Item	Performance Characteristics
Operating Temperature	-55°C to 125°C
Rated Capacitance Range	10 – 1,000 μF @ 120 Hz/25°C
Capacitance Tolerance	K Tolerance (10%), M Tolerance (20%)
Rated Voltage Range	4 – 50 V
DF (120 Hz)	Refer to Part Number Electrical Specification Table
ESR (100 kHz)	Refer to Part Number Electrical Specification Table
Leakage Current	≤ 0.01 CV (μA) at rated voltage after 5 minutes

Qualification

Test	Condition	Characteristics					
Endurance	85°C @ rated voltage, 2,000 hours 125°C @ 2/3 rated voltage, 2,000 hours	ΔC/C	Within ±10% of initial value				
		DF	Within initial limits				
		DCL	Within 1.25 x initial limit				
		ESR	Within initial limits				
Storage Life	125°C @ 0 volts, 2,000 hours	ΔC/C	Within ±10% of initial value				
		DF	Within initial limits				
		DCL	Within 1.25 x initial limit				
		ESR	Within initial limits				
Thermal Shock	MIL-STD-202, Method 107, Condition B, mounted, -55°C to 125°C, 1,000 cycles	ΔC/C	Within ±5% of initial value				
		DF	Within initial limits				
		DCL	Within 1.25 x initial limit				
		ESR	Within initial limits				
Temperature Stability	Extreme temperature exposure at a succession of continuous steps at +25°C, -55°C, +25°C, +85°C, +125°C, +25°C	+25°C	-55°C	+85°C	+125°C		
		ΔC/C	IL*	±10%	±10%	±20%	
		DF	IL	IL	1.5 x IL	1.5 x IL	
		DCL	IL	n/a	10 x IL	12 x IL	
		Surge Voltage	25°C and 85°C, 1.32 x rated voltage 1,000 cycles (125°C, 1.2 x rated voltage)	ΔC/C	Within ±5% of initial value		
				DF	Within initial limits		
DCL	Within initial limits						
ESR	Within initial limits						
Mechanical Shock/Vibration	MIL-STD-202, Method 213, Condition I, 100 G peak MIL-STD-202, Method 204, Condition D, 10 Hz to 2,000 Hz, 20 G peak	ΔC/C	Within ±10% of initial value				
		DF	Within initial limits				
		DCL	Within initial limits				

*IL = Initial limit

Electrical Characteristics

Impedance, ESR vs. Frequency

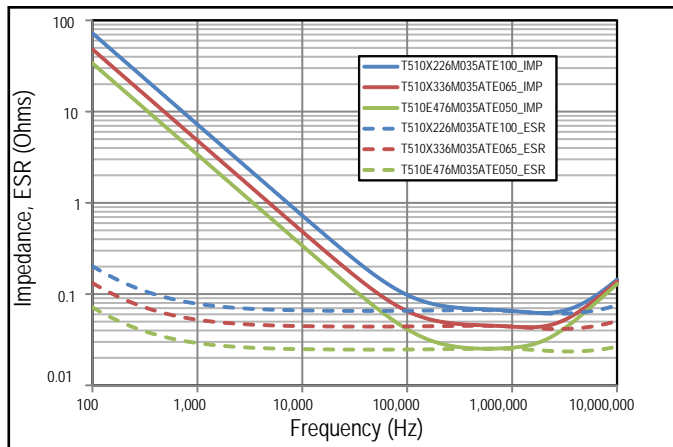

Capacitance vs. Frequency



Dimensions – Millimeters (Inches)

Metric will govern

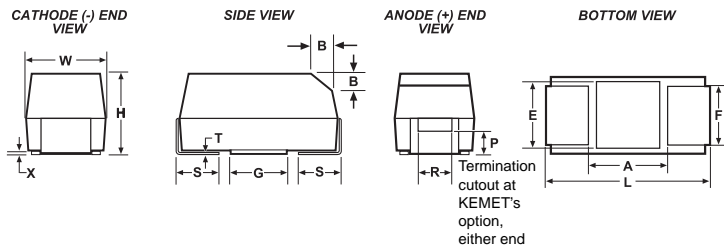

Case Size		Component												
KEMET	EIA	L*	W*	H*	F* ±0.1 ±(.004)	S* ±0.3 ±(.012)	B* ±0.15 (Ref) ±.006	X (Ref)	P (Ref)	R (Ref)	T (Ref)	A (Min)	G (Ref)	E (Ref)
X	7343-43	7.3 ±0.3 (0.287 ±0.012)	4.3 ±0.3 (0.169 ±0.012)	4.0 ±0.3 (0.157 ±0.012)	2.4 (.094)	1.3 (.051)	0.5 (.020)	0.10 ± 0.10 (.004 ± .004)	1.7 (.067)	1.0 (.039)	0.13 (.005)	3.8 (.150)	3.5 (.138)	3.5 (.138)
E	7360-38	7.3 ±0.3 (0.287 ±0.012)	6.0 ±0.3 (0.236 ±0.012)	3.6 ±0.2 (0.142 ±0.008)	4.1 (.161)	1.3 (.051)	0.5 (.020)	0.10 ± 0.10 (.004 ± .004)	n/a	n/a	0.13 (.005)	3.8 (.150)	3.5 (.138)	3.5 (.138)

Notes: (Ref) – Dimensions provided for reference only. No dimensions are provided for B, P or R because low profile cases do not have a bevel or a notch.

* MIL-PRF-55365/8 specified dimensions

Table 1 – Ratings & Part Number Reference

Rated Voltage	Rated Cap	Case Code/ Case Size	KEMET Part Number	DC Leakage	DF	ESR	Maximum Allowable Ripple Current			Moisture Sensitivity
							(mA) 100 kHz 25°C	(mA) 100 kHz +85°C	(mA) 100 kHz +125°C	
VDC	μF	KEMET/EIA	(See below for part options)	μAmps +20°C Max/5 Min	% @ +20°C 120 Hz Max	mΩ @ 20°C 100 kHz Max	(mA) 100 kHz 25°C	(mA) 100 kHz +85°C	(mA) 100 kHz +125°C	Reflow Temp ≤ 260°C
4	680	X/7343-43	T510X687(1)004A(2)E030	27.2	6.0	30	3000	2700	1200	1
4	1000	X/7343-43	T510X108(1)004A(2)E018	40.0	6.0	18	3873	3486	1549	1
4	1000	X/7343-43	T510X108(1)004A(2)E023	40.0	6.0	23	3426	3083	1370	1
4	1000	E/7360-38	T510E108(1)004A(2)E018	40.0	6.0	18	3979	3581	1592	1
4	1000	E/7360-38	T510E108(1)004A(2)E010	40.0	6.0	10	5339	4805	2136	1
6.3	470	X/7343-43	T510X477(1)006A(2)E030	29.6	6.0	30	3000	2700	1200	1
6.3	680	X/7343-43	T510X687(1)006A(2)E023	42.8	6.0	23	3426	3083	1370	1
6.3	680	X/7343-43	T510X687(1)006A(2)E045	42.8	12.0	45	2449	2204	980	1
6.3	680	E/7360-38	T510E687(1)006A(2)E023	42.8	6.0	23	3520	3168	1408	1
6.3	680	E/7360-38	T510E687(1)006A(2)E012	42.8	6.0	12	4873	4386	1949	1
10	330	X/7343-43	T510X337(1)010A(2)E035	33.0	6.0	35	2777	2499	1111	1
16	150	X/7343-43	T510X157(1)016A(2)E030	24.0	6.0	30	3000	2700	1200	1
16	150	X/7343-43	T510X157(1)016A(2)E040	24.0	6.0	40	2598	2338	1039	1
16	220	X/7343-43	T510X227(1)016A(2)E040	35.2	10.0	40	2598	2338	1039	1
16	220	X/7343-43	T510X227(1)016A(2)E025	35.2	10.0	25	3286	2957	1314	1
20	100	X/7343-43	T510X107(1)020A(2)E035	20.0	8.0	35	2777	2499	1111	1
20	100	X/7343-43	T510X107(1)020A(2)E040	20.0	6.0	40	2598	2338	1039	1
20	100	X/7343-43	T510X107(1)020A(2)E045	20.0	6.0	45	2449	2204	980	1
25	68	X/7343-43	T510X686(1)025A(2)E045	17.0	8.0	45	2449	2204	980	1
25	100	E/7360-38	T510E107(1)025A(2)E050	25.0	8.0	50	2387	2148	955	1
35	22	X/7343-43	T510X226(1)035A(2)E100	7.7	6.0	100	1643	1479	657	1
35	22	X/7343-43	T510X226(1)035A(2)E080	7.7	6.0	80	1837	1653	735	1
35	22	X/7343-43	T510X226(1)035A(2)E060	7.7	6.0	60	2121	1909	848	1
35	33	X/7343-43	T510X336(1)035A(2)E065	11.6	6.0	65	2038	1834	815	1
35	33	X/7343-43	T510X336(1)035A(2)E050	11.6	6.0	50	2324	2092	930	1
35	47	X/7343-43	T510X476(1)035A(2)E055	16.5	8.0	55	2216	1994	886	1
35	47	X/7343-43	T510X476(1)035A(2)E065	16.5	8.0	65	2038	1834	815	1
35	47	E/7360-38	T510E476(1)035A(2)E050	16.5	8.0	50	2387	2148	955	1
50	10	X/7343-43	T510X106(1)050A(2)E120	5.0	8.0	120	1500	1350	600	1
50	10	X/7343-43	T510X106(1)050A(2)E090	5.0	8.0	90	1732	1559	693	1
VDC	μF	KEMET/EIA	(See below for part options)	μAmps +20°C Max/5 Min	% @ +20°C 120 Hz Max	mΩ @ 20°C 100 kHz Max	(mA) 100 kHz 25°C	(mA) 100 kHz +85°C	(mA) 100 kHz +125°C	Reflow Temp ≤ 260°C
Rated Voltage	Rated Cap	Case Code/ Case Size	KEMET Part Number	DC Leakage	DF	ESR	Maximum Allowable Ripple Current			Moisture Sensitivity

(1) To complete KEMET part number, insert M for ±20% or K for ±10%. Designates Capacitance tolerance.

(2) To complete KEMET part number, insert T = 100% Matte Tin (Sn) Plated, G = Gold Plated, H = Standard Solder coated (SnPb 5% Pb minimum).

Designates Termination Finish.

Refer to Ordering Information for additional detail.

Higher voltage ratings and tighter tolerance product including ESR may be substituted within the same size at KEMET's option. Voltage substitution will be marked with the higher voltage rating. Substitutions can include better than series.

Recommended Voltage Derating Guidelines

-55°C to 125°C		
% Change in Working DC Voltage with Temperature	50% of V _R	V _R
Recommended Maximum Application Voltage	100% of V _R	V _R



Ripple Current/Ripple Voltage

KEMET Series and Case Code	EIA Case Code	Maximum Power Dissipation (P max) mWatts @ 25°C w/+20°C Rise
A	3216-18	75
B	3528-21	85
C	6032-28	110
D	7343-31	150
X	7343-43	165
E	7360-38	200
T428P	7360-38	325
S	3216-12	60
T	3528-12	70
U	6032-15	90
V	7343-20	125
T510X	7343-43	270
T510E	7360-38	285

Temperature Compensation Multipliers for Maximum Power Dissipation		
≤ 25°C	85°C	125°C
1.00	0.90	0.40

T = Environmental Temperature

Using the P max of the device, the maximum allowable rms ripple current or voltage may be determined.

$$I(max) = \sqrt{P_{max}/R}$$

$$E(max) = \sqrt{P_{max} \cdot R}$$

I = rms ripple current (amperes)

E = rms ripple voltage (volts)

P max = maximum power dissipation (watts)

R = ESR at specified frequency (ohms)

Reverse Voltage

Solid tantalum capacitors are polar devices and may be permanently damaged or destroyed if connected with the wrong polarity. The positive terminal is identified on the capacitor body by a stripe plus in some cases a beveled edge. A small degree of transient reverse voltage is permissible for short periods per the table. The capacitors should not be operated continuously in reverse mode, even within these limits.

Temperature	Permissible Transient Reverse Voltage
25°C	15% of Rated Voltage
85°C	5% of Rated Voltage
125°C	1% of Rated Voltage

Table 2 – Land Dimensions/Courtyard

KEMET	Metric Size Code	Density Level A: Maximum (Most) Land Protrusion (mm)					Density Level B: Median (Nominal) Land Protrusion (mm)					Density Level C: Minimum (Least) Land Protrusion (mm)					
		Case	EIA	X	Y	C	V1	V2	X	Y	C	V1	V2	X	Y	C	V1
E ¹	7360–38		4.25	2.65	3.20	10.10	7.20	4.15	2.25	3.30	9.40	6.70	4.05	1.85	3.00	8.10	6.40
X ¹	7343–43		2.55	3.75	2.70	10.20	5.50	2.45	3.35	2.60	9.10	5.00	2.35	2.95	2.50	8.20	4.70

Density Level A: For low-density product applications. Recommended for wave solder applications and provides a wider process window for reflow solder processes.

Density Level B: For products with a moderate level of component density. Provides a robust solder attachment condition for reflow solder processes.

Density Level C: For high component density product applications. Before adapting the minimum land pattern variations the user should perform qualification testing based on the conditions outlined in IPC Standard 7351 (IPC–7351).

¹ Height of these chips may create problems in wave soldering.

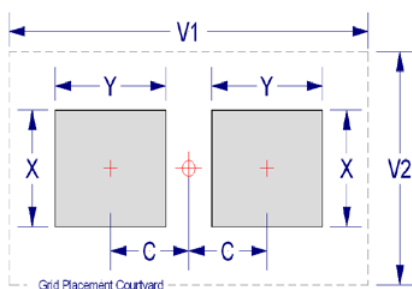

Soldering Process

KEMET's families of surface mount capacitors are compatible with wave (single or dual), convection, IR, or vapor phase reflow techniques. Preheating of these components is recommended to avoid extreme thermal stress. KEMET's recommended profile conditions for convection and IR reflow reflect the profile conditions of the IPC/J-STD-020D standard for moisture sensitivity testing. The devices can safely withstand a maximum of three reflow passes at these conditions.

Please note that although the X/7343-43 case size can withstand wave soldering, the tall profile (4.3 mm maximum) dictates care in wave process development.

Hand soldering should be performed with care due to the difficulty in process control. If performed, care should be taken to avoid contact of the soldering iron to the molded case. The iron should be used to heat the solder pad, applying solder between the pad and the termination, until reflow occurs. Once reflow occurs, the iron should be removed immediately. "Wiping" the edges of a chip and heating the top surface is not recommended.

During typical reflow operations, a slight darkening of the gold-colored epoxy may be observed. This slight darkening is normal and not harmful to the product. Marking permanency is not affected by this change.

Profile Feature	SnPb Assembly	Pb-Free Assembly
Preheat/Soak		
Temperature Minimum (T_{smin})	100°C	150°C
Temperature Maximum (T_{smax})	150°C	200°C
Time (t_s) from T_{smin} to T_{smax}	60 – 120 seconds	60 – 120 seconds
Ramp-up Rate (T_L to T_p)	3°C/seconds maximum	3°C/seconds maximum
Liquidous Temperature (T_L)	183°C	217°C
Time Above Liquidous (t_L)	60 – 150 seconds	60 – 150 seconds
Peak Temperature (T_p)	220°C* 235°C**	250°C* 260°C**
Time within 5°C of Maximum Peak Temperature (t_p)	20 seconds maximum	30 seconds maximum
Ramp-down Rate (T_p to T_L)	6°C/seconds maximum	6°C/seconds maximum
Time 25°C to Peak Temperature	6 minutes maximum	8 minutes maximum

Note: All temperatures refer to the center of the package, measured on the package body surface that is facing up during assembly reflow.

*Case Size D, E, P, Y, and X

**Case Size A, B, C, H, I, K, M, R, S, T, U, V, W, and Z

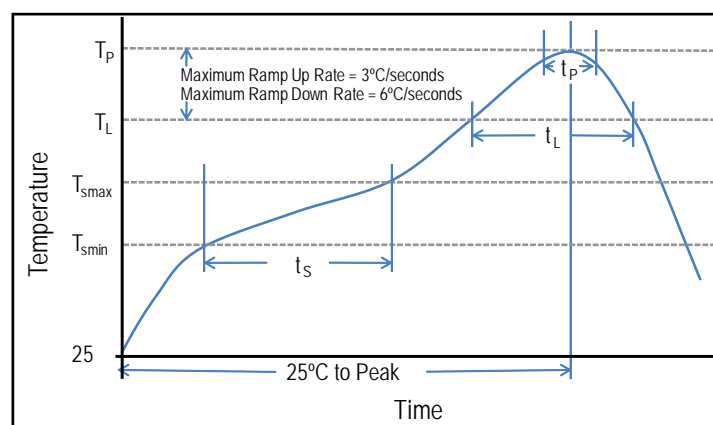

Construction

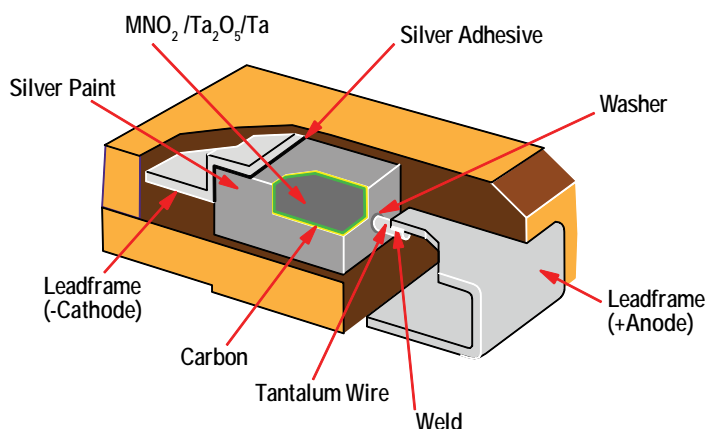

Capacitor Marking

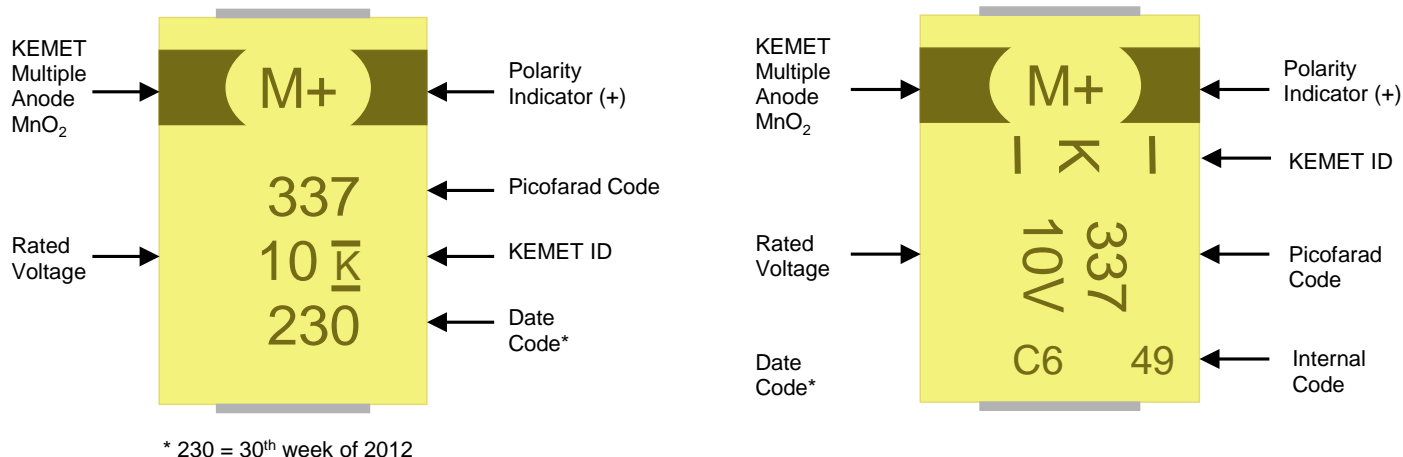

Date Code *	
1 st digit = Last number of Year	9 = 2009 0 = 2010 1 = 2011 2 = 2012
2 nd and 3 rd digit = Week of the Year	01 = 1 st week of the Year to 52 = 52 nd week of the Year

Date Code*		
Year	Month	
X = 2009	1 = Jan	7 = Jul
A = 2010	2 = Feb	8 = Aug
B = 2011	3 = Mar	9 = Spt
C = 2012	4 = Apr	O = Oct
D = 2013	5 = May	N = Nov
E = 2014	6 = Jun	D = Dec

Storage

Tantalum chip capacitors should be stored in normal working environments. While the chips themselves are quite robust in other environments, solderability will be degraded by exposure to high temperatures, high humidity, corrosive atmospheres, and long term storage. In addition, packaging materials will be degraded by high temperature—reels may soften or warp and tape peel force may increase. KEMET recommends that maximum storage temperature not exceed 40°C and maximum storage humidity not exceed 60% relative humidity. Temperature fluctuations should be minimized to avoid condensation on the parts and atmospheres should be free of chlorine and sulphur bearing compounds. For optimized solderability chip stock should be used promptly, preferably within three years of receipt.

Overview

The KEMET Tantalum Stacks MnO₂ (TSM) Series is designed to provide the highest capacitance/voltage ratings in surface mount configuration. KEMET's T493 COTS Military/Aerospace capacitors are utilized in stacks of 2,3,4,and 6 components to achieve a broad range of capacitance and voltage ratings. The T493 COTS series offers component level Weibull grading options, surge current testing options and standard, low,

and ultra-low ESR options. All component level lots of this series are conditioned with MIL-PRF-55365 Group A testing. Stacking configurations offer this high reliability product with custom capacitance/voltage solutions and very low ESR options.

Note: Custom stacking solutions are available with other KEMET Tantalum Surface Mount Series. Please contact KEMET Product Management for availability.

Benefits

- High capacitance
- Surface mountable
- Capacitance values of 9.4 μF to 1980 μF
- Capacitance can be custom specified
- Voltage ratings of 6 VDC to 50 VDC
- High volumetric efficiency
- Ultra-low ESR
- Surge capability
- Weibull failure options B and C
- Operating temperature range of -55°C to +125°C
- Laser-marked case
- Discrete components EIA standard case sizes (others available)
- High Temperature lead attach material available (> 260°C)

Applications

Typical applications include decoupling and filtering in a variety of market segments. The T493 COTS stack devices can be utilized in military and aerospace applications. Other KEMET series can be utilized in filtering and decoupling applications to service various market segments.



Environmental Compliance

RoHS Compliant (6/6) according to Directive 2002/95/EC when ordered with 100% Sn solder.



RoHS Compliant

SPICE

For a detailed analysis of specific part numbers, please visit www.kemet.com for a free download of KEMET's SPICE software. The KEMET SPICE program is freeware intended to aid design engineers in analyzing the performance of these capacitors over frequency, temperature, ripple, and DC bias conditions.

Ordering Information

T	SM	2D	447	K	10	A	H	61	20	D493
Capacitor Class	Series	Case Size	Capacitance Code (pF)	Capacitance Tolerance	Voltage	Failure Rate/Design	Lead Material	Surge	ESR	C-Spec 2
T = Tantalum	Stacks MnO ₂ Cathode	2C, 3C, 4C, 6C, 2D, 3D, 4D, 6D, 2X, 3X, 4X, 6X	First two digits represent significant figures. Third digit specifies number of zeros.	K = ±10% M = ±20%	006 = 6.3 V 010 = 10 V 016 = 16 V 020 = 20 V 025 = 25 V 035 = 35 V 050 = 50 V	A = N/A B = 0.1%/1,000 hours C = 0.01%/1,000 hours	H = Standard Solder Coated (SnPb 5% Pb minimum) C = Hot Solder Dipped B = Gold Plated T = 100% Tin	61 = None 62 = 10 Cycles 25°C After Weibull 63 = 10 cycles, -55°C and 85°C After Weibull 64 = 10 cycles, -55°C and 85°C Before Weibull Special CSPEC: CECC	10 = ESR-Standard 20 = ESR-Low 30 = ESR-Ultra-low	Designates discrete component series. D493 = T493

Note: These TSM Stacks are specific to T493 COTS.

Performance Characteristics

Item	Performance Characteristics
Operating Temperature	-55°C to 125°C
Rated Capacitance Range	9.4 – 1980 µF @ 120 Hz/25°C
Capacitance Tolerance	K Tolerance (10%), M Tolerance (20%)
Rated Voltage Range	6 – 50 V
DF (120 Hz)	Refer to Part Number Electrical Specification Table
ESR (100 kHz)	Refer to Part Number Electrical Specification Table
Leakage Current	≤ 0.01 CV (mA) at rated voltage after 5 minutes

Qualification

Test	Condition	Characteristics	
Endurance	85°C @ rated voltage, 2,000 hours 125°C @ 2/3 rated voltage, 2,000 hours	Δ C/C	Within ±10% of initial value
		DF	Within initial limits
		DCL	Within 1.25 x initial limit
		ESR	Within initial limits
Thermal Shock	KEMET specified test, mounted, -55°C to 125° C, 5 cycles	Δ C/C	Within ±5% of initial value
		DF	Within initial limits
		DCL	Within 1.25 x initial limit
		ESR	Within initial limits
Surge Voltage	85° C, 1.15 x rated voltage 1,000 cycles	Δ C/C	Within ±5% of initial value
		DF	Within initial limits
		DCL	Within initial limits
		ESR	Within initial limits
Surge Voltage	125° C, 0.77 x rated voltage 1,000 cycles	Δ C/C	Within ±5% of initial value
		DF	Within initial limits
		DCL	Within initial limits
		ESR	Within initial limits
Mechanical Vibration	MIL-STD-202, Method 204, Condition D, 10 Hz to 2,000 Hz, 20 G peak	Δ C/C	Within ±10% of initial value
		DF	Within initial limits
		DCL	Within initial limits

Dimensions – Millimeters (Inches)

Metric will govern

TSM2

KEMET 2 Component Stack Dimensions						
Case Code	L	W	H	W2	H2	P
2C	6.5 ± 0.38 (.258 ± .015)	3.3 ± 0.2 (.130 ± .008)	5.3 ± 0.38 (.210 ± .015)	2.5 ± 0.2 (.100 ± .008)	4.5 ± 0.38 (.176 ± .015)	1.4 ± 0.38 (.055 ± .015)
2D	8.0 ± 0.38 (.315 ± .015)	4.4 ± 0.2 (.174 ± .008)	6.2 ± 0.38 (.245 ± .015)	3.0 ± 0.2 (.120 ± .008)	4.8 ± 0.38 (.192 ± .015)	1.9 ± 0.38 (.075 ± .015)
2X	8.0 ± 0.38 (.315 ± .015)	4.4 ± 0.2 (.174 ± .008)	8.9 ± 0.38 (.352 ± .015)	3.0 ± 0.2 (.120 ± .008)	6.9 ± 0.38 (.272 ± .015)	1.9 ± 0.38 (.075 ± .015)



TSM3

KEMET 3 Component Stack Dimensions						
Case Code	L	W	H	W2	H2	P
3C	6.5 ± 0.38 (.258 ± .015)	3.3 ± 0.2 (.130 ± .008)	7.8 ± 0.38 (.310 ± .015)	2.5 ± 0.2 (.100 ± .008)	6.4 ± 0.38 (.252 ± .015)	1.4 ± 0.38 (.055 ± .015)
3D	8.0 ± 0.38 (.315 ± .015)	4.4 ± 0.2 (.174 ± .008)	9.2 ± 0.38 (.365 ± .015)	3.0 ± 0.2 (.120 ± .008)	7.7 ± 0.38 (.304 ± .015)	1.9 ± 0.38 (.075 ± .015)
3X	8.0 ± 0.38 (.315 ± .015)	4.4 ± 0.2 (.174 ± .008)	13.3 ± 0.38 (.525 ± .015)	3.0 ± 0.2 (.120 ± .008)	11.0 ± 0.38 (.436 ± .015)	1.9 ± 0.38 (.075 ± .015)



TSM4

KEMET 4 Component Stack Dimensions						
Case Code	L	W	H	W2	H2	P
4C	6.5 ± 0.38 (.258 ± .015)	6.6 ± 0.2 (.262 ± .008)	5.3 ± 0.38 (.210 ± .015)	5.8 ± 0.2 (.230 ± .008)	4.6 ± 0.38 (.180 ± .015)	1.4 ± 0.38 (.055 ± .015)
4D	8.0 ± 0.38 (.315 ± .015)	8.9 ± 0.2 (.350 ± .008)	6.2 ± 0.38 (.245 ± .015)	7.4 ± 0.2 (.292 ± .008)	4.8 ± 0.38 (.192 ± .015)	1.9 ± 0.38 (.075 ± .015)
4X	8.0 ± 0.38 (.315 ± .015)	8.9 ± 0.2 (.350 ± .008)	8.9 ± 0.38 (.352 ± .015)	7.4 ± 0.2 (.292 ± .008)	6.9 ± 0.38 (.272 ± .015)	1.9 ± 0.38 (.075 ± .015)



TSM6

KEMET 6 Component Stack Dimensions						
Case Code	L	W	H	W2	H2	P
6C	6.5 ± 0.38 (.258 ± .015)	6.6 ± 0.2 (.262 ± .008)	7.8 ± 0.38 (.310 ± .015)	5.8 ± 0.2 (.230 ± .008)	6.6 ± 0.38 (.260 ± .015)	1.4 ± 0.38 (.055 ± .015)
6D	8.0 ± 0.38 (.315 ± .015)	8.9 ± 0.2 (.350 ± .008)	9.2 ± 0.38 (.365 ± .015)	7.4 ± 0.2 (.292 ± .008)	7.7 ± 0.38 (.304 ± .015)	1.9 ± 0.38 (.075 ± .015)
6X	8.0 ± 0.38 (.315 ± .015)	8.9 ± 0.2 (.350 ± .008)	13.3 ± 0.38 (.525 ± .015)	7.4 ± 0.2 (.292 ± .008)	11.0 ± 0.38 (.436 ± .015)	1.9 ± 0.38 (.075 ± .015)



Capacitance and Rated Voltage Chart

Capacitance		Rated Voltage						
μF	Code	6 V	10 V	16 V	20 V	25 V	35 V	50 V
9.4	945							2D
14	146							3D
19	196							4D
20	206						2C	2X
28	286							6D
30	306					2C	3C	3X
40	406						4C	4X
44	446				2C		2D	
45	456					3C		
60	606					4C	6C	6X
66	666				3C		3D	
88	886				4C		4D	
90	906					6C		
94	946			2C		2D		
132	137				6C		6D	
136	137				2D			
141	147			3C		3D		
188	197			4C		4D		
200	207		2C					
204	207				3D			
272	277				4D			
282	287			6C		6D		
300	307		3C	2D				
400	407		4C					
408	417				6D			
440	447	2C	2D					
450	457			3D				
600	607		6C	4D				
660	667	3C, 2D	3D, 2X					
880	887	4C	4D					
900	907			6D				
990	997	3D	3X					
1320	138	6C, 4D	6D, 4X					
1980	208	6D	6X					

Table 1A – TSM2 Ratings & Part Number Reference

Rated Voltage	Rated Cap	Case Code/ Case Size	KEMET Part Number	DC Leakage	DF	Standard ESR	Low ESR	Ultra-low ESR	Moisture Sensitivity
V	µF	KEMET/EIA	(See below for part options)	µA @ +20°C Max/5 Min	% @ +20°C 120 Hz Max	Ω @ +20°C 100 kHz Max	Ω @ +20°C 100 kHz Max	Ω @ +20°C 100 kHz Max	Temperature ≤ 260°C
6.3	440	2C	TSM2C447(1)006(2)(3)(4)(5)	27.8	10	0.600	0.150	0.115	1
10	200	2C	TSM2C207(1)010(2)(3)(4)(5)	20.0	8	0.600	0.150	NA	1
16	94	2C	TSM2C946(1)016(2)(3)(4)(5)	15.0	6	0.600	0.250	0.175	1
20	44	2C	TSM2C446(1)020(2)(3)(4)(5)	8.8	6	0.600	0.200	NA	1
25	30	2C	TSM2C306(1)025(2)(3)(4)(5)	7.6	6	0.750	0.450	NA	1
35	20	2C	TSM2C206(1)035(2)(3)(4)(5)	7.0	6	1.000	0.600	NA	1
6.3	660	2D	TSM2D667(1)006(2)(3)(4)(5)	41.6	8	0.250	0.075	0.050	1
10	440	2D	TSM2D447(1)010(2)(3)(4)(5)	44.0	8	0.250	0.100	0.040	1
16	300	2D	TSM2D307(1)016(2)(3)(4)(5)	48.0	8	0.350	0.200	0.075	1
20	136	2D	TSM2D137(1)020(2)(3)(4)(5)	27.2	8	0.350	0.100	0.075	1
25	94	2D	TSM2D946(1)025(2)(3)(4)(5)	23.6	10	0.350	0.100	0.060	1
35	44	2D	TSM2D446(1)035(2)(3)(4)(5)	15.4	6	0.350	0.200	0.100	1
50	9.4	2D	TSM2D945(1)050(2)(3)(4)(5)	4.8	6	0.750	0.300	0.140	1
10	660	2X	TSM2X667(1)010(2)(3)(4)(5)	66.0	10	0.250	0.050	0.025	1
50	20	2X	TSM2X206(1)050(2)(3)(4)(5)	10.0	6	0.350	0.200	NA	1
V	µF	KEMET/EIA	(See below for part options)	µA @ +20°C Max/5 Min	% @ +20°C 120 Hz Max	Ω @ +20°C 100 kHz Max	Ω @ +20°C 100 kHz Max	Ω @ +20°C 100 kHz Max	Temperature ≤ 260°C
Rated Voltage	Rated Cap	Case Code/ Case Size	KEMET Part Number	DC Leakage	DF	Standard ESR	Low ESR	Ultra-low ESR	Moisture Sensitivity

Table 1B – TSM3 Ratings & Part Number Reference

Rated Voltage	Rated Cap	Case Code/ Case Size	KEMET Part Number	DC Leakage	DF	Standard ESR	Low ESR	Ultra-low ESR	Moisture Sensitivity
V	µF	KEMET/EIA	(See below for part options)	µA @ +20°C Max/5 Min	% @ +20°C 120 Hz Max	Ω @ +20°C 100 kHz Max	Ω @ +20°C 100 kHz Max	Ω @ +20°C 100 kHz Max	Temperature ≤ 260°C
6.3	660	3C	TSM3C667(1)006(2)(3)(4)(5)	41.7	10	0.400	0.100	0.077	1
10	300	3C	TSM3C307(1)010(2)(3)(4)(5)	30.0	8	0.400	0.100	NA	1
16	141	3C	TSM3C147(1)016(2)(3)(4)(5)	22.5	6	0.400	0.167	0.117	1
20	66	3C	TSM3C666(1)020(2)(3)(4)(5)	13.2	6	0.400	0.133	NA	1
25	45	3C	TSM3C456(1)025(2)(3)(4)(5)	11.4	6	0.500	0.300	NA	1
35	30	3C	TSM3C306(1)035(2)(3)(4)(5)	10.5	6	0.667	0.400	NA	1
6.3	990	3D	TSM3D997(1)006(2)(3)(4)(5)	62.4	8	0.167	0.050	0.033	1
10	660	3D	TSM3D667(1)010(2)(3)(4)(5)	66.0	8	0.167	0.067	0.027	1
16	450	3D	TSM3D457(1)016(2)(3)(4)(5)	72.0	8	0.233	0.133	0.050	1
20	204	3D	TSM3D207(1)020(2)(3)(4)(5)	40.8	8	0.233	0.067	0.050	1
25	141	3D	TSM3D147(1)025(2)(3)(4)(5)	35.4	10	0.233	0.067	0.040	1
35	66	3D	TSM3D666(1)035(2)(3)(4)(5)	23.1	6	0.233	0.133	0.067	1
50	14	3D	TSM3D146(1)050(2)(3)(4)(5)	7.2	6	0.500	0.200	0.093	1
10	990	3X	TSM3X997(1)010(2)(3)(4)(5)	99.0	10	0.167	0.033	0.017	1
50	30	3X	TSM3X306(1)050(2)(3)(4)(5)	15.0	6	0.233	0.133	NA	1
V	µF	KEMET/EIA	(See below for part options)	µA @ +20°C Max/5 Min	% @ +20°C 120 Hz Max	Ω @ +20°C 100 kHz Max	Ω @ +20°C 100 kHz Max	Ω @ +20°C 100 kHz Max	Temperature ≤ 260°C
Rated Voltage	Rated Cap	Case Code/ Case Size	KEMET Part Number	DC Leakage	DF	Standard ESR	Low ESR	Ultra-low ESR	Moisture Sensitivity

- (1) To complete KEMET part number, insert M for ± 20%, K for ± 10%. Designates Capacitance tolerance.
 (2) To complete KEMET part number, insert B (0.1%/1,000 hours), C (0.01%/1,000 hours) or A = N/A. Designates Reliability Level.
 (3) To complete KEMET part number, insert B = Gold Plated, C = Hot solder dipped, H = Solder Plated, or T = 100% Tin (Sn). Designates Termination Finish.
 (4) To complete KEMET part number, insert 61 = None, 62 = 10 cycles +25°C, 63 = 10 cycles -55°C +85°C after Weibull or 64 = 10 cycles -55°C +85°C before Weibull. Designates Surge current option.
 (5) To complete KEMET part number, insert 10 = Standard ESR, 20 = Low ESR or 30 = Ultra Low ESR. Designates ESR option.
 Refer to Ordering Information for additional detail.

Table 1C – TSM4 Ratings & Part Number Reference

Rated Voltage	Rated Cap	Case Code/ Case Size	KEMET Part Number	DC Leakage	DF	Standard ESR	Low ESR	Ultra-low ESR	Moisture Sensitivity
V	µF	KEMET/EIA	(See below for part options)	µA @ +20°C Max/5 Min	% @ +20°C 120 Hz Max	Ω @ +20°C 100 kHz Max	Ω @ +20°C 100 kHz Max	Ω @ +20°C 100 kHz Max	Temperature ≤ 260°C
6.3	880	4C	TSM4C887(1)006(2)(3)(4)(5)	55.6	10	0.300	0.075	0.058	1
10	400	4C	TSM4C407(1)010(2)(3)(4)(5)	40.0	8	0.300	0.075	NA	1
16	188	4C	TSM4C197(1)016(2)(3)(4)(5)	30.0	6	0.300	0.125	0.088	1
20	88	4C	TSM4C886(1)020(2)(3)(4)(5)	17.6	6	0.300	0.100	NA	1
25	60	4C	TSM4C606(1)025(2)(3)(4)(5)	15.2	6	0.375	0.225	NA	1
35	40	4C	TSM4C406(1)035(2)(3)(4)(5)	14.0	6	0.500	0.300	NA	1
6.3	1320	4D	TSM4D138(1)006(2)(3)(4)(5)	83.2	8	0.125	0.038	0.025	1
10	880	4D	TSM4D887(1)010(2)(3)(4)(5)	88.0	8	0.125	0.050	0.020	1
16	600	4D	TSM4D607(1)016(2)(3)(4)(5)	96.0	8	0.175	0.100	0.038	1
20	272	4D	TSM4D277(1)020(2)(3)(4)(5)	54.4	8	0.175	0.050	0.038	1
25	188	4D	TSM4D187(1)025(2)(3)(4)(5)	47.2	10	0.175	0.050	0.030	1
35	88	4D	TSM4D886(1)035(2)(3)(4)(5)	30.8	6	0.175	0.100	0.050	1
50	19	4D	TSM4D196(1)050(2)(3)(4)(5)	9.6	6	0.375	0.150	0.070	1
10	1320	4X	TSM4X138(1)010(2)(3)(4)(5)	132.0	10	0.125	0.025	0.013	1
50	40	4X	TSM4X406(1)050(2)(3)(4)(5)	20.0	6	0.175	0.100	NA	1
V	µF	KEMET/EIA	(See below for part options)	µA @ +20°C Max/5 Min	% @ +20°C 120 Hz Max	Ω @ +20°C 100 kHz Max	Ω @ +20°C 100 kHz Max	Ω @ +20°C 100 kHz Max	Temperature ≤ 260°C
Rated Voltage	Rated Cap	Case Code/ Case Size	KEMET Part Number	DC Leakage	DF	Standard ESR	Low ESR	Ultra-low ESR	Moisture Sensitivity

Table 1D – TSM6 Ratings & Part Number Reference

Rated Voltage	Rated Cap	Case Code/ Case Size	KEMET Part Number	DC Leakage	DF	Standard ESR	Low ESR	Ultra-low ESR	Moisture Sensitivity
V	µF	KEMET/EIA	(See below for part options)	µA @ +20°C Max/5 Min	% @ +20°C 120 Hz Max	Ω @ +20°C 100 kHz Max	Ω @ +20°C 100 kHz Max	Ω @ +20°C 100 kHz Max	Temperature ≤ 260°C
6.3	1320	6C	TSM6C138(1)006(2)(3)(4)(5)	83.4	10	0.200	0.050	0.038	
10	600	6C	TSM6C607(1)010(2)(3)(4)(5)	60.0	8	0.200	0.050	NA	
16	282	6C	TSM6C287(1)016(2)(3)(4)(5)	45.0	6	0.200	0.083	0.058	
20	132	6C	TSM6C137(1)020(2)(3)(4)(5)	26.4	6	0.200	0.067	NA	
25	90	6C	TSM6C906(1)025(2)(3)(4)(5)	22.8	6	0.250	0.150	NA	
35	60	6C	TSM6C606(1)035(2)(3)(4)(5)	21.0	6	0.333	0.200	NA	
6.3	1980	6D	TSM6D208(1)006(2)(3)(4)(5)	124.8	8	0.083	0.025	0.017	
10	1320	6D	TSM6D138(1)010(2)(3)(4)(5)	132.0	8	0.083	0.033	0.013	
16	900	6D	TSM6D907(1)016(2)(3)(4)(5)	144.0	8	0.117	0.067	0.025	
20	408	6D	TSM6D417(1)020(2)(3)(4)(5)	81.6	8	0.117	0.033	0.025	
25	282	6D	TSM6D287(1)025(2)(3)(4)(5)	70.8	10	0.117	0.033	0.020	
35	132	6D	TSM6D137(1)035(2)(3)(4)(5)	46.2	6	0.117	0.067	0.033	
50	28	6D	TSM6D286(1)050(2)(3)(4)(5)	14.4	6	0.250	0.100	0.047	
10	1980	6X	TSM6X208(1)010(2)(3)(4)(5)	198.0	10	0.083	0.017	0.008	
50	60	6X	TSM6X606(1)050(2)(3)(4)(5)	30.0	6	0.117	0.067	NA	
V	µF	KEMET/EIA	(See below for part options)	µA @ +20°C Max/5 Min	% @ +20°C 120 Hz Max	Ω @ +20°C 100 kHz Max	Ω @ +20°C 100 kHz Max	Ω @ +20°C 100 kHz Max	Temperature ≤ 260°C
Rated Voltage	Rated Cap	Case Code/ Case Size	KEMET Part Number	DC Leakage	DF	Standard ESR	Low ESR	Ultra-low ESR	Moisture Sensitivity

- 1) To complete KEMET part number, insert M for ± 20%, K for ± 10%. Designates Capacitance tolerance.
 - 2) To complete KEMET part number, insert B (0.1%/1,000 hours), C (0.01%/1,000 hours) or A = N/A. Designates Reliability Level.
 - 3) To complete KEMET part number, insert B = Gold Plated, C = Hot solder dipped, H = Solder Plated, or T = 100% Tin (Sn). Designates Termination Finish.
 - 4) To complete KEMET part number, insert 61 = None, 62 = 10 cycles +25°C, 63 = 10 cycles -55°C +85°C after Weibull or 64 = 10 cycles -55°C +85°C before Weibull. Designates Surge current option.
 - 5) To complete KEMET part number, insert 10 = Standard ESR, 20 = Low ESR or 30 = Ultra Low ESR. Designates ESR option.
- Refer to Ordering Information for additional detail.

Recommended Voltage Derating Guidelines



Reverse Voltage

Solid tantalum capacitors are polar devices and may be permanently damaged or destroyed if connected with the wrong polarity. The positive terminal is identified on the capacitor body by a stripe plus in some cases a beveled edge. A small degree of transient reverse voltage is permissible for short periods per the table. The capacitors should not be operated continuously in reverse mode, even within these limits.

Temperature	Permissible Transient Reverse Voltage
25°C	15% of Rated Voltage
85°C	5% of Rated Voltage
125°C	1% of Rated Voltage

Soldering Process

KEMET's families of surface mount capacitors are compatible with wave (single or dual), convection, IR, or vapor phase reflow techniques. Preheating of these components is recommended to avoid extreme thermal stress. KEMET's recommended profile conditions for convection and IR reflow reflect the profile conditions of the IPC/J-STD-020D standard for moisture sensitivity testing. The devices can safely withstand a maximum of three reflow passes at these conditions.

Please note that although the X/7343-43 case size can withstand wave soldering, the tall profile (4.3 mm maximum) dictates care in wave process development.

Hand soldering should be performed with care due to the difficulty in process control. If performed, care should be taken to avoid contact of the soldering iron to the molded case. The iron should be used to heat the solder pad, applying solder between the pad and the termination, until reflow occurs. Once reflow occurs, the iron should be removed immediately. "Wiping" the edges of a chip and heating the top surface is not recommended.

During typical reflow operations, a slight darkening of the gold-colored epoxy may be observed. This slight darkening is normal and not harmful to the product. Marking permanency is not affected by this change.

Profile Feature	SnPb Assembly	Pb-Free Assembly
Preheat/Soak		
Temperature Minimum (T_{Smin})	100°C	150°C
Temperature Maximum (T_{Smax})	150°C	200°C
Time (t_s) from T_{Smin} to T_{Smax}	60 – 120 seconds	60 – 120 seconds
Ramp-up Rate (T_L to T_p)	3°C/seconds maximum	3°C/seconds maximum
Liquidous Temperature (T_L)	183°C	217°C
Time Above Liquidous (t_L)	60 – 150 seconds	60 – 150 seconds
Peak Temperature (T_p)	220°C* 235°C**	250°C* 260°C**
Time within 5°C of Maximum Peak Temperature (t_p)	20 seconds maximum	30 seconds maximum
Ramp-down Rate (T_p to T_L)	6°C/seconds maximum	6°C/seconds maximum
Time 25°C to Peak Temperature	6 minutes maximum	8 minutes maximum

Note: All temperatures refer to the center of the package, measured on the package body surface that is facing up during assembly reflow.

*Case Size D, E, P, Y, and X

**Case Size A, B, C, H, I, K, M, R, S, T, U, V, W, and Z

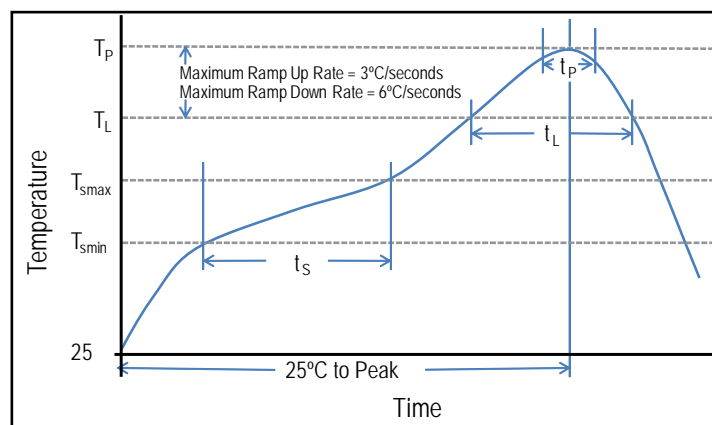

Construction

Reference	Name	Material
A	Lead frame	BeCu Alloy 190
B	Lead frame Attach	High Temperature Solder
C	Lead Termination	Solder Coated Alloy 752



Storage

Tantalum chip capacitors should be stored in normal working environments. While the chips themselves are quite robust in other environments, solderability will be degraded by exposure to high temperatures, high humidity, corrosive atmospheres, and long term storage. In addition, packaging materials will be degraded by high temperature– reels may soften or warp and tape peel force may increase. KEMET recommends that maximum storage temperature not exceed 40°C and maximum storage humidity not exceed 60% relative humidity. Temperature fluctuations should be minimized to avoid condensation on the parts and atmospheres should be free of chlorine and sulphur bearing compounds. For optimized solderability chip stock should be used promptly, preferably within three years of receipt.

Packaging

- Tantalum Stacks Packaging EIA–451 Packaging Material Standards for ESD Sensitive Items
- Antistatic Plastic Trays
- Polyurethane Polyether Foam



Overview

The KEMET Organic Capacitor (KO-CAP) is a tantalum capacitor with a Ta anode and Ta₂O₅ dielectric. A conductive organic polymer replaces the traditionally used MnO₂ as the cathode plate of the capacitor. This results in very low ESR and improved capacitance retention at high frequency. The KO-CAP also exhibits a benign failure mode which eliminates the ignition failures that can occur in standard MnO₂ tantalum types. KO-CAPs may also be operated at steady state voltages up to 90% of rated voltage for part types with rated voltages of ≤ 10 volts and up to 80% of rated voltage for part types > 10 volts with equivalent or better reliability than traditional MnO₂ tantalum capacitors operated at 50% of rated voltage.

The T520 Series KO-CAP Low ESR Polymer captures the best features of multilayer ceramic (low ESR, high frequency capacitance retention), aluminum electrolytic (higher capacitance, benign failure mode), and proven solid tantalum technology (volumetric efficiency, surface mount capability, extremely long life). The T520 can reduce component counts, eliminate through-hole assembly by replacing cumbersome leaded aluminum capacitors, and offer a cost-effective and space-saving solution.

Benefits

- Extremely low ESR
- -55°C to 105°C operating temperature range
- Polymer cathode technology
- High frequency capacitance retention
- Non-ignition failure mode
- Capacitance up to 1,500 μF
- 100% accelerated steady state aging
- 100% surge current tested
- Taped and reeled per EIA 481-1
- Volumetric efficiency
- Self-healing mechanism
- EIA standard case sizes

Applications

Typical applications include DC/DC converters, notebook PCs, portable electronics, telecommunications (mobile phone and base station), displays, SSD, HDD and USB.



Environmental Compliance

RoHS Compliant (6/6) according to Directive 2002/95/EC when ordered with 100% Sn solder.



RoHS Compliant

SPICE

For a detailed analysis of specific part numbers, please visit www.kemet.com for a free download of KEMET's SPICE software. The KEMET SPICE program is freeware intended to aid design engineers in analyzing the performance of these capacitors over frequency, temperature, ripple, and DC bias conditions.

Ordering Information

T	520	V	157	M	006	A	T	E045	
Capacitor Class	Series	Case Size	Capacitance Code (pF)	Capacitance Tolerance	Voltage	Failure Rate/Design	Lead Material	ESR Code	Packaging (C-Spec)
T = Tantalum	520 = Polymer	A, B, C, D, H, L, M, T, U, V, W, X, Y	First two digits represent significant figures. Third digit specifies number of zeros.	M = $\pm 20\%$	2R5 = 2.5 V 003 = 3 V 004 = 4 V 006 = 6.3 V 008 = 8 V 010 = 10 V 12R = 12.5 V 016 = 16 V 020 = 20 V 025 = 25 V	A = N/A	T = 100% Matte Tin (Sn) Plated H = Tin/Lead (SnPb) Solder Coated (5% Pb minimum)	E = ESR Last three digits specify ESR in m Ω . (045 = 45 m Ω)	Blank = 7" Reel 7280 = 13" Reel

Performance Characteristics

Item	Performance Characteristics
Operating Temperature	-55°C to 105°C
Rated Capacitance Range	10 – 1,500 μF @ 120 Hz/25°C
Capacitance Tolerance	M Tolerance (20%)
Rated Voltage Range	2.5 – 25 V
DF (120 Hz)	$\leq 10\%$
ESR (100 kHz)	Refer to Part Number Electrical Specification Table
Leakage Current	$\leq 0.1 \text{ CV}$ (μA) at rated voltage after 5 minutes

Qualification

Test	Condition	Characteristics				
Endurance	105°C @ rated voltage, 2,000 hours	Δ C/C	Within -20%/+10% of initial value			
		DF	Within initial limits			
		DCL	Within 1.25 x initial limit			
		ESR	Within 2.0 x initial limit			
Storage Life	105°C @ 0 volts, 2,000 hours	Δ C/C	Within -20%/+10% of initial value			
		DF	Within initial limits			
		DCL	Within 1.25 x initial limit			
		ESR	Within 2.0 x initial limit			
Humidity	60°C, 90% RH, 500 hours, rated voltage 60°C, 90% RH, 500 hours, No Load	Δ C/C	Within -5%/+35% of initial value			
		DF	Within initial limits			
		DCL	Within 5.0 x initial limit			
		ESR	Within 2.0 x initial limit			
Temperature Stability	Extreme temperature exposure at a succession of continuous steps at +25°C, -55°C, +25°C, +85°C, +105°C, +25°C	+25°C	-55°C	+85°C	+105°C	
		Δ C/C	IL*	±20%	±20%	±30%
		DF	IL	IL	1.2 x IL	1.5 x IL
		DCL	IL	n/a	10 x IL	10 x IL
Surge Voltage	105°C, 1.32 x rated voltage, 1,000 cycles	Δ C/C	Within -20%/+10% of initial value			
		DF	Within initial limits			
		DCL	Within initial limits			
		ESR	Within initial limits			
Mechanical Shock/Vibration	MIL-STD-202, Method 213, Condition I, 100 G peak. MIL-STD-202, Method 204, Condition D, 10 Hz to 2,000 Hz, 20 G peak	Δ C/C	Within ±10% of initial value			
		DF	Within initial limits			
		DCL	Within initial limits			

*IL = Initial limit

Electrical Characteristics

ESR vs. Frequency

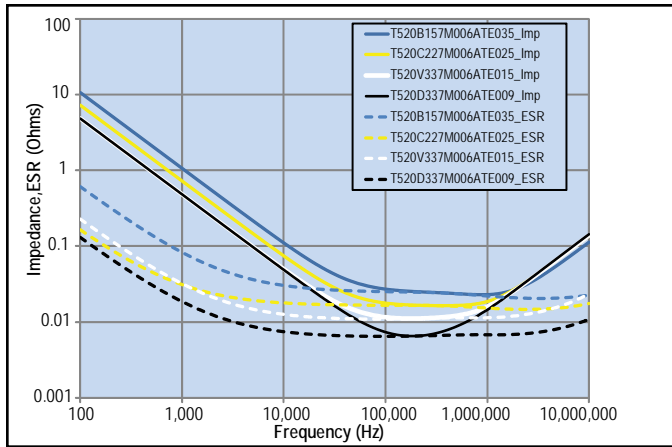

Capacitance vs. Frequency

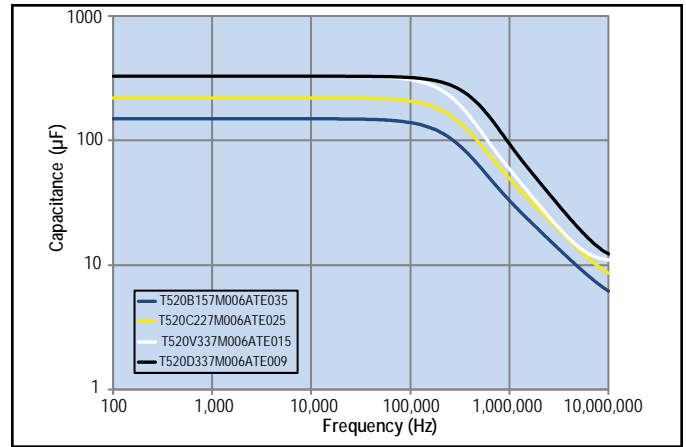

Dimensions – Millimeters (Inches)

Metric will govern



Case Size		Component													
KEMET	EIA	L*	W*	H*	F* ±0.1 ±(0.004)	S* ±0.3 ±(0.012)	B* ±0.15 (Ref) ±0.006	X (Ref)	P (Ref)	R (Ref)	T (Ref)	A (Min)	G (Ref)	E (Ref)	
A	3216-18	3.2 ±0.2 (0.126 ±0.008)	1.6 ±0.2 (0.063 ±0.008)	1.6 ±0.2 (0.063 ±0.008)	1.2 (.047)	0.8 (.031)	0.4 (.016)	0.10 ± 0.10 (.004 ± .004)	0.4 (.016)	0.4 (.016)	0.13 (.005)	0.8 (.31)	1.1 (.043)	1.3 (.051)	
B	3528-21	3.5 ±0.2 (0.138 ±0.008)	2.8 ±0.2 (0.110 ±0.008)	1.9 ±0.2 (0.075 ±0.008)	2.2 (.087)	0.8 (.031)	0.4 (.016)	0.10 ± 0.10 (.004 ± .004)	0.5 (.020)	1.0 (.039)	0.13 (.005)	1.1 (.043)	1.8 (.071)	2.2 (.087)	
C	6032-28	6.0 ±0.3 (0.236 ±0.03)	3.2 ±0.3 (0.126 ±0.012)	2.5 ±0.3 (0.098 ±0.012)	2.2 (.087)	1.3 (.051)	0.5 (.020)	0.10 ± 0.10 (.004 ± .004)	0.9 (.035)	1.0 (.039)	0.13 (.005)	2.5 (.098)	2.8 (.110)	2.4 (.094)	
D	7343-31	7.3 ±0.3 (0.287 ±0.012)	4.3 ±0.3 (0.169 ±0.012)	2.8 ±0.3 (0.110 ±0.012)	2.4 (.094)	1.3 (.051)	0.5 (.020)	0.10 ± 0.10 (.004 ± .004)	0.9 (.035)	1.0 (.039)	0.13 (.005)	3.8 (.150)	3.5 (.138)	3.5 (.138)	
H	7360-20	7.3 ±0.3 (0.287 ±0.012)	6.0 ±0.3 (0.236 ±0.012)	2.0 (0.078) Maximum	4.1 (.161)	1.3 (.051)	n/a	0.10 ± 0.10 (.004 ± .004)	n/a	n/a	0.13 (.005)	3.3 (.130)	3.5 (.138)	3.5 (.138)	
L	6032-19	6.0 ±0.3 (0.236 ±0.012)	3.2 ±0.2 (0.110 ±0.008)	1.9 (0.075)	2.2 (.087)	1.3 (.051)	n/a	0.05 (.002)	n/a	n/a	0.13 (.005)	2.5 (.098)	2.8 (.110)	2.4 (.094)	
M	3528-15	3.5 ±0.2 (0.138 ±0.008)	2.8 ±0.2 (0.110 ±0.008)	1.5 (0.059)	2.2 (.087)	0.8 (.031)	n/a	0.05 (.002)	n/a	n/a	0.13 (.005)	1.1 (.043)	1.8 (.071)	2.2 (.087)	
T	3528-12	3.5 ±0.2 (0.138 ±0.008)	2.8 ±0.2 (0.110 ±0.008)	1.2 (0.047)	2.2 (.087)	0.8 (.031)	n/a	0.05 (.002)	n/a	n/a	0.13 (.005)	1.1 (.043)	1.8 (.071)	2.2 (.087)	
U	6032-15	6.0 ±0.3 (0.236 ±0.012)	3.2 ±0.2 (0.110 ±0.008)	1.5 (0.059)	2.2 (.087)	1.3 (.051)	n/a	0.05 (.002)	n/a	n/a	0.13 (.005)	2.5 (.098)	2.8 (.110)	2.4 (.094)	
V	7343-19	7.3 ±0.3 (0.287 ±0.012)	4.3 ±0.3 (0.169 ±0.012)	1.9 (0.075)	2.4 (.094)	1.3 (.051)	n/a	0.05 (.002)	n/a	n/a	0.13 (.005)	3.8 (.150)	3.5 (.138)	3.5 (.138)	
W	7343-15	7.3 ±0.3 (0.287 ±0.012)	4.3 ±0.3 (0.169 ±0.012)	1.5 (0.059)	2.4 (.094)	1.3 (.051)	n/a	0.05 (.002)	n/a	n/a	0.13 (.005)	3.8 (.150)	3.5 (.138)	3.5 (.138)	
X	7343-43	7.3 ±0.3 (0.287 ±0.012)	4.3 ±0.3 (0.169 ±0.012)	4.0 ±0.3 (0.157 ±0.012)	2.4 (.094)	1.3 (.051)	0.5 (.020)	0.10 ± 0.10 (.004 ± .004)	1.7 (.067)	1.0 (.039)	0.13 (.005)	3.8 (.150)	3.5 (.138)	3.5 (.138)	
Y	7343-40	7.3 ±0.3 (0.287 ±0.012)	4.3 ±0.3 (0.169 ±0.012)	4.0 (0.157)	2.4 (.094)	1.3 (.051)	0.5 (.020)	0.10 ± 0.10 (.004 ± .004)	1.7 (.067)	1.0 (.039)	0.13 (.005)	3.8 (.150)	3.5 (.138)	3.5 (.138)	

Notes: (Ref) – Dimensions provided for reference only. No dimensions are provided for B, P or R because low profile cases do not have a bevel or a notch.

* MIL-PRF-55365/8 specified dimensions

Table 1 – Ratings & Part Number Reference

Rated Voltage	Rated Cap	Case Code/ Case Size	KEMET Part Number	DC Leakage	DF	ESR	Maximum Allowable Ripple Current	Moisture Sensitivity	Rated Temp
VDC	µF	KEMET/EIA	(See below for part options)	µA @ 20°C Maximum/5 Minutes	% @ 20°C 120 Hz Maximum	mΩ @ 20°C 100 kHz Maximum	(mA) 45°C 100 kHz	Temperature ≤ 260°C	(°C)
2	470	V/7343-19	T520V477M002A(1)E040	94	10	40	2200	3	105
2.5	47	A/3216-18	T520A476M2R5A(1)E090	12	8	90	1100	3	105
2.5	56	T/3528-12	T520T566M2R5A(1)E040	14	8	40	1600	3	105
2.5	56	T/3528-12	T520T566M2R5A(1)E070	14	8	70	1200	3	105
2.5	68	A/3216-18	T520A686M2R5A(1)E070	17	8	70	1300	3	105
2.5	68	A/3216-18	T520A686M2R5A(1)E080	17	8	80	1200	3	105
2.5	100	T/3528-12	T520T107M2R5A(1)E040	25	8	40	1600	3	105
2.5	100	T/3528-12	T520T107M2R5A(1)E070	25	8	70	1200	3	105
2.5	100	B/3528-21	T520B107M2R5A(1)E025	25	8	25	2300	3	105
2.5	100	B/3528-21	T520B107M2R5A(1)E035	25	8	35	1900	3	105
2.5	100	B/3528-21	T520B107M2R5A(1)E040	25	8	40	1800	3	105
2.5	100	B/3528-21	T520B107M2R5A(1)E070	25	8	70	1300	3	105
2.5	150	U/6032-15	T520U157M2R5A(1)E055	38	8	55	1600	3	105
2.5	220	B/3528-21	T520B227M2R5A(1)E015	55	8	15	2900	3	105
2.5	220	B/3528-21	T520B227M2R5A(1)E018	55	8	18	2700	3	105
2.5	220	B/3528-21	T520B227M2R5A(1)E021	55	8	21	2500	3	105
2.5	220	B/3528-21	T520B227M2R5A(1)E025	55	8	25	2300	3	105
2.5	220	B/3528-21	T520B227M2R5A(1)E030	55	8	30	2100	3	105
2.5	220	B/3528-21	T520B227M2R5A(1)E035	55	8	35	1900	3	105
2.5	220	B/3528-21	T520B227M2R5A(1)E055	55	8	55	1500	3	105
2.5	220	B/3528-21	T520B227M2R5A(1)E070	55	8	70	1300	3	105
2.5	220	U/6032-15	T520U227M2R5A(1)E055	55	8	55	1600	3	105
2.5	220	C/6032-28	T520C227M2R5A(1)E025	55	8	25	2600	3	105
2.5	220	C/6032-28	T520C227M2R5A(1)E045	55	8	45	1900	3	105
2.5	220	W/7343-15	T520W227M2R5A(1)E025	55	10	25	2700	3	105
2.5	220	V/7343-19	T520V227M2R5A(1)E006	55	10	6	5600	3	105
2.5	220	V/7343-19	T520V227M2R5A(1)E007	55	10	7	5200	3	105
2.5	220	V/7343-19	T520V227M2R5A(1)E009	55	10	9	4600	3	105
2.5	220	V/7343-19	T520V227M2R5A(1)E012	55	10	12	3900	3	105
2.5	220	V/7343-19	T520V227M2R5A(1)E015	55	10	15	3500	3	105
2.5	220	V/7343-19	T520V227M2R5A(1)E025	55	10	25	2700	3	105
2.5	220	V/7343-19	T520V227M2R5A(1)E045	55	10	45	2000	3	105
2.5	220	D/7343-31	T520D227M2R5A(1)E007	55	10	7	5700	3	105
2.5	220	D/7343-31	T520D227M2R5A(1)E040	55	10	40	2400	3	105
2.5	330	B/3528-21	T520B337M2R5A(1)E015	83	8	15	2900	3	105
2.5	330	B/3528-21	T520B337M2R5A(1)E018	83	8	18	2700	3	105
2.5	330	B/3528-21	T520B337M2R5A(1)E035	83	8	35	1900	3	105
2.5	330	B/3528-21	T520B337M2R5A(1)E045	83	8	45	1700	3	105
2.5	330	B/3528-21	T520B337M2R5A(1)E070	83	8	70	1300	3	105
2.5	330	C/6032-28	T520C337M2R5A(1)E015	83	8	15	3300	3	105
2.5	330	C/6032-28	T520C337M2R5A(1)E018	83	8	18	3000	3	105
2.5	330	C/6032-28	T520C337M2R5A(1)E025	83	8	25	2600	3	105
2.5	330	C/6032-28	T520C337M2R5A(1)E045	83	8	45	1900	3	105
2.5	330	L/6032-19	T520L337M2R5A(1)E009	83	8	9	4100	3	105
2.5	330	L/6032-19	T520L337M2R5A(1)E012	83	8	12	3500	3	105
2.5	330	L/6032-19	T520L337M2R5A(1)E025	83	8	25	2400	3	105
2.5	330	W/7343-15	T520W337M2R5A(1)E015	83	10	15	3500	3	105
2.5	330	W/7343-15	T520W337M2R5A(1)E025	83	10	25	2700	3	105
2.5	330	W/7343-15	T520W337M2R5A(1)E040	83	10	40	2100	3	105
2.5	330	V/7343-19	T520V337M2R5A(1)E006	83	10	6	5600	3	105
VDC	µF	KEMET/EIA	(See below for part options)	µA @ 20°C Maximum/5 Minutes	% @ 20°C 120 Hz Maximum	mΩ @ 20°C 100 kHz Maximum	(mA) 45°C 100 kHz	Temperature ≤ 260°C	(°C)
Rated Voltage	Rated Cap	Case Code/ Case Size	KEMET Part Number	DC Leakage	DF	ESR	Maximum Allowable Ripple Current	Moisture Sensitivity	Rated Temp

Other part number options:

1- Standard with tin terminations (14th character = T). Tin/lead terminations is also available (14th character = H).

Also available on large (13 inch) reels. Add 7280 to the end of the part number.

Higher voltage ratings and tighter tolerance product including ESR may be substituted within the same size at KEMET's option. Voltage substitutions will be marked with the higher voltage rating. Substitutions can include better than series.

Table 1 – Ratings & Part Number Reference cont'd

Rated Voltage	Rated Cap	Case Code/ Case Size	KEMET Part Number	DC Leakage	DF	ESR	Maximum Allowable Ripple Current	Moisture Sensitivity	Rated Temp
VDC	µF	KEMET/EIA	(See below for part options)	µA @ 20°C Maximum/5 Minutes	% @ 20°C 120 Hz Maximum	mΩ @ 20°C 100 kHz Maximum	(mA) 45°C 100 kHz	Temperature ≤ 260°C	(°C)
2.5	330	V/7343-19	T520V337M2R5A(1)E007	83	10	7	5200	3	105
2.5	330	V/7343-19	T520V337M2R5A(1)E009	83	10	9	4600	3	105
2.5	330	V/7343-19	T520V337M2R5A(1)E012	83	10	12	3900	3	105
2.5	330	V/7343-19	T520V337M2R5A(1)E015	83	10	15	3500	3	105
2.5	330	V/7343-19	T520V337M2R5A(1)E018	83	10	18	3200	3	105
2.5	330	V/7343-19	T520V337M2R5A(1)E025	83	10	25	2700	3	105
2.5	330	V/7343-19	T520V337M2R5A(1)E040	83	10	40	2200	3	105
2.5	330	D/7343-31	T520D337M2R5A(1)E006	83	10	6	6100	3	105
2.5	330	D/7343-31	T520D337M2R5A(1)E007	83	10	7	5700	3	105
2.5	470	V/7343-19	T520V477M2R5A(1)E007	118	10	7	5200	3	105
2.5	470	V/7343-19	T520V477M2R5A(1)E009	118	10	9	4600	3	105
2.5	470	V/7343-19	T520V477M2R5A(1)E012	118	10	12	3900	3	105
2.5	470	V/7343-19	T520V477M2R5A(1)E015	118	10	15	3500	3	105
2.5	470	V/7343-19	T520V477M2R5A(1)E018	118	10	18	3200	3	105
2.5	470	C/6032-28	T520C477M2R5A(1)E025	118	8	25	2600	3	105
2.5	470	C/6032-28	T520C477M2R5A(1)E045	118	8	45	1900	3	105
2.5	470	D/7343-31	T520D477M2R5A(1)E006	118	10	6	6100	3	105
2.5	470	D/7343-31	T520D477M2R5A(1)E007	118	10	7	5700	3	105
2.5	470	D/7343-31	T520D477M2R5A(1)E009	118	10	9	5000	3	105
2.5	680	D/7343-31	T520D687M2R5A(1)E010	170	10	10	4700	3	105
2.5	680	D/7343-31	T520D687M2R5A(1)E015	170	10	15	3900	3	105
2.5	680	D/7343-31	T520D687M2R5A(1)E040	170	10	40	2400	3	105
2.5	680	Y/7343-40	T520Y687M2R5A(1)E015	170	10	15	4000	3	105
2.5	680	Y/7343-40	T520Y687M2R5A(1)E025	170	10	25	3100	3	105
2.5	1000	D/7343-31	T520D108M2R5A(1)E015	250	10	15	3900	3	105
2.5	1000	D/7343-31	T520D108M2R5A(1)E030	250	10	30	2700	3	105
2.5	1000	Y/7343-40	T520Y108M2R5A(1)E010	250	10	10	4900	3	105
2.5	1000	Y/7343-40	T520Y108M2R5A(1)E015	250	10	15	4000	3	105
2.5	1000	Y/7343-40	T520Y108M2R5A(1)E025	250	10	25	3100	3	105
2.5	1000	X/7343-43	T520X108M2R5A(1)E010	250	10	10	5000	3	105
3	100	B/3528-21	T520B107M003A(1)E025	30	8	25	2300	3	105
3	100	B/3528-21	T520B107M003A(1)E035	30	8	35	1900	3	105
3	100	B/3528-21	T520B107M003A(1)E040	30	8	40	1800	3	105
3	100	B/3528-21	T520B107M003A(1)E070	30	8	70	1300	3	105
3	150	B/3528-21	T520B157M003A(1)E025	45	8	25	2300	3	105
3	150	B/3528-21	T520B157M003A(1)E035	45	8	35	1900	3	105
3	150	B/3528-21	T520B157M003A(1)E040	45	8	40	1800	3	105
3	150	B/3528-21	T520B157M003A(1)E070	45	8	70	1300	3	105
3	330	V/7343-19	T520V337M003A(1)E009	99	10	9	4600	3	105
3	330	V/7343-19	T520V337M003A(1)E012	99	10	12	3900	3	105
3	330	V/7343-19	T520V337M003A(1)E015	99	10	15	3500	3	105
3	330	V/7343-19	T520V337M003A(1)E025	99	10	25	2700	3	105
3	680	D/7343-31	T520D687M003A(1)E015	204	10	15	3900	3	105
3	680	D/7343-31	T520D687M003A(1)E040	204	10	40	2400	3	105
3	1000	X/7343-43	T520X108M003A(1)E015	300	10	15	4100	3	105
3	1000	X/7343-43	T520X108M003A(1)E030	300	10	30	2900	3	105
4	15	T/3528-12	T520T156M004A(1)E100	6	8	100	1000	3	105
4	33	A/3216-18	T520A336M004A(1)E070	13	8	70	1300	3	105
4	33	A/3216-18	T520A336M004A(1)E080	13	8	80	1200	3	105
VDC	µF	KEMET/EIA	(See below for part options)	µA @ 20°C Maximum/5 Minutes	% @ 20°C 120 Hz Maximum	mΩ @ 20°C 100 kHz Maximum	(mA) 45°C 100 kHz	Temperature ≤ 260°C	(°C)
Rated Voltage	Rated Cap	Case Code/ Case Size	KEMET Part Number	DC Leakage	DF	ESR	Maximum Allowable Ripple Current	Moisture Sensitivity	Rated Temp

Other part number options:

1- Standard with tin terminations (14th character = T). Tin/lead terminations is also available (14th character = H).

Also available on large (13 inch) reels. Add 7280 to the end of the part number.

Higher voltage ratings and tighter tolerance product including ESR may be substituted within the same size at KEMET's option. Voltage substitutions will be marked with the higher voltage rating. Substitutions can include better than series.

Table 1 – Ratings & Part Number Reference cont'd

Rated Voltage	Rated Cap	Case Code/ Case Size	KEMET Part Number	DC Leakage	DF	ESR	Maximum Allowable Ripple Current	Moisture Sensitivity	Rated Temp
VDC	µF	KEMET/EIA	(See below for part options)	µA @ 20°C Maximum/5 Minutes	% @ 20°C 120 Hz Maximum	mΩ @ 20°C 100 kHz Maximum	(mA) 45°C 100 kHz	Temperature ≤ 260°C	(°C)
4	47	A/3216-18	T520A476M004A(1)E070	19	8	70	1300	3	105
4	47	A/3216-18	T520A476M004A(1)E080	19	8	80	1200	3	105
4	47	T/3528-12	T520T476M004A(1)E070	19	8	70	1200	3	105
4	68	T/3528-12	T520T686M004A(1)E070	27	8	70	1200	3	105
4	68	B/3528-21	T520B686M004A(1)E025	27	8	25	2300	3	105
4	68	B/3528-21	T520B686M004A(1)E035	27	8	35	1900	3	105
4	68	B/3528-21	T520B686M004A(1)E040	27	8	40	1800	3	105
4	68	B/3528-21	T520B686M004A(1)E070	27	8	70	1300	3	105
4	68	U/6032-15	T520U686M004A(1)E055	27	8	55	1600	3	105
4	100	A/3216-18	T520A107M004A(1)E150	40	8	150	900	3	105
4	100	A/3216-18	T520A107M004A(1)E200	40	8	200	700	3	105
4	100	T/3528-12	T520T107M004A(1)E070	40	8	70	1200	3	105
4	100	T/3528-12	T520T107M004A(1)E150	40	8	150	800	3	105
4	100	B/3528-21	T520B107M004A(1)E025	40	8	25	2300	3	105
4	100	B/3528-21	T520B107M004A(1)E035	40	8	35	1900	3	105
4	100	B/3528-21	T520B107M004A(1)E040	40	8	40	1800	3	105
4	100	B/3528-21	T520B107M004A(1)E070	40	8	70	1300	3	105
4	100	U/6032-15	T520U107M004A(1)E055	40	8	55	1600	3	105
4	150	B/3528-21	T520B157M004A(1)E015	60	8	15	2900	3	105
4	150	B/3528-21	T520B157M004A(1)E018	60	8	18	2700	3	105
4	150	B/3528-21	T520B157M004A(1)E025	60	8	25	2300	3	105
4	150	B/3528-21	T520B157M004A(1)E030	60	8	30	2100	3	105
4	150	B/3528-21	T520B157M004A(1)E035	60	8	35	1900	3	105
4	150	B/3528-21	T520B157M004A(1)E040	60	8	40	1800	3	105
4	150	B/3528-21	T520B157M004A(1)E070	60	8	70	1300	3	105
4	150	U/6032-15	T520U157M004A(1)E055	60	8	55	1600	3	105
4	150	C/6032-28	T520C157M004A(1)E015	60	8	15	3300	3	105
4	150	C/6032-28	T520C157M004A(1)E025	60	8	25	2600	3	105
4	150	C/6032-28	T520C157M004A(1)E045	60	8	45	1900	3	105
4	150	C/6032-28	T520C157M004A(1)E100	60	8	100	1300	3	105
4	150	V/7343-19	T520V157M004A(1)E007	60	10	7	5200	3	105
4	150	V/7343-19	T520V157M004A(1)E009	60	10	9	4600	3	105
4	150	V/7343-19	T520V157M004A(1)E012	60	10	12	3900	3	105
4	150	V/7343-19	T520V157M004A(1)E015	60	10	15	3500	3	105
4	150	V/7343-19	T520V157M004A(1)E025	60	10	25	2700	3	105
4	150	D/7343-31	T520D157M004A(1)E007	60	10	7	5700	3	105
4	220	B/3528-21	T520B227M004A(1)E035	88	8	35	1900	3	105
4	220	B/3528-21	T520B227M004A(1)E045	88	8	45	1700	3	105
4	220	B/3528-21	T520B227M004A(1)E070	88	8	70	1300	3	105
4	220	C/6032-28	T520C227M004A(1)E015	88	8	15	3300	3	105
4	220	C/6032-28	T520C227M004A(1)E018	88	8	18	3000	3	105
4	220	C/6032-28	T520C227M004A(1)E025	88	8	25	2600	3	105
4	220	C/6032-28	T520C227M004A(1)E045	88	8	45	1900	3	105
4	220	C/6032-28	T520C227M004A(1)E055	88	8	55	1700	3	105
4	220	L/6032-19	T520L227M004A(1)E012	88	8	12	3500	3	105
4	220	L/6032-19	T520L227M004A(1)E025	88	8	25	2400	3	105
4	220	W/7343-15	T520W227M004A(1)E025	88	10	25	2700	3	105
4	220	W/7343-15	T520W227M004A(1)E040	88	10	40	2100	3	105
4	220	V/7343-19	T520V227M004A(1)E006	88	10	6	5600	3	105
4	220	V/7343-19	T520V227M004A(1)E007	88	10	7	5200	3	105
4	220	V/7343-19	T520V227M004A(1)E009	88	10	9	4600	3	105
VDC	µF	KEMET/EIA	(See below for part options)	µA @ 20°C Maximum/5 Minutes	% @ 20°C 120 Hz Maximum	mΩ @ 20°C 100 kHz Maximum	(mA) 45°C 100 kHz	Temperature ≤ 260°C	(°C)
Rated Voltage	Rated Cap	Case Code/ Case Size	KEMET Part Number	DC Leakage	DF	ESR	Maximum Allowable Ripple Current	Moisture Sensitivity	Rated Temp

Other part number options:

1- Standard with tin terminations (14th character = T). Tin/lead terminations is also available (14th character = H).

Also available on large (13 inch) reels. Add 7280 to the end of the part number.

Higher voltage ratings and tighter tolerance product including ESR may be substituted within the same size at KEMET's option. Voltage substitutions will be marked with the higher voltage rating. Substitutions can include better than series.

Table 1 – Ratings & Part Number Reference cont'd

Rated Voltage	Rated Cap	Case Code/ Case Size	KEMET Part Number	DC Leakage	DF	ESR	Maximum Allowable Ripple Current	Moisture Sensitivity	Rated Temp
VDC	µF	KEMET/EIA	(See below for part options)	µA @ 20°C Maximum/5 Minutes	% @ 20°C 120 Hz Maximum	mΩ @ 20°C 100 kHz Maximum	(mA) 45°C 100 kHz	Temperature ≤ 260°C	(°C)
4	220	V/7343-19	T520V227M004A(1)E012	88	10	12	3900	3	105
4	220	V/7343-19	T520V227M004A(1)E015	88	10	15	3500	3	105
4	220	V/7343-19	T520V227M004A(1)E018	88	10	18	3200	3	105
4	220	V/7343-19	T520V227M004A(1)E025	88	10	25	2700	3	105
4	220	V/7343-19	T520V227M004A(1)E040	88	10	40	2200	3	105
4	220	V/7343-19	T520V227M004A(1)E045	88	10	45	2000	3	105
4	220	D/7343-31	T520D227M004A(1)E006	88	10	6	6100	3	105
4	220	D/7343-31	T520D227M004A(1)E007	88	10	7	5700	3	105
4	220	D/7343-31	T520D227M004A(1)E012	88	10	12	4300	3	105
4	220	D/7343-31	T520D227M004A(1)E065	88	10	65	1900	3	105
4	330	C/6032-28	T520C337M004A(1)E025	132	8	25	2600	3	105
4	330	C/6032-28	T520C337M004A(1)E045	132	8	45	1900	3	105
4	330	V/7343-19	T520V337M004A(1)E007	132	10	7	5200	3	105
4	330	V/7343-19	T520V337M004A(1)E009	132	10	9	4600	3	105
4	330	V/7343-19	T520V337M004A(1)E012	132	10	12	3900	3	105
4	330	V/7343-19	T520V337M004A(1)E018	132	10	18	3200	3	105
4	330	V/7343-19	T520V337M004A(1)E025	132	10	25	2700	3	105
4	330	V/7343-19	T520V337M004A(1)E040	132	10	40	2200	3	105
4	330	D/7343-31	T520D337M004A(1)E006	132	10	6	6100	3	105
4	330	D/7343-31	T520D337M004A(1)E007	132	10	7	5700	3	105
4	330	D/7343-31	T520D337M004A(1)E009	132	10	9	5000	3	105
4	330	D/7343-31	T520D337M004A(1)E012	132	10	12	4300	3	105
4	330	D/7343-31	T520D337M004A(1)E015	132	10	15	3900	3	105
4	330	D/7343-31	T520D337M004A(1)E040	132	10	40	2400	3	105
4	330	D/7343-31	T520D337M004A(1)E045	132	10	45	2200	3	105
4	470	D/7343-31	T520D477M004A(1)E010	188	10	10	4700	3	105
4	470	D/7343-31	T520D477M004A(1)E012	188	10	12	4300	3	105
4	470	D/7343-31	T520D477M004A(1)E015	188	10	15	3900	3	105
4	470	D/7343-31	T520D477M004A(1)E018	188	10	18	3500	3	105
4	470	D/7343-31	T520D477M004A(1)E025	188	10	25	3000	3	105
4	470	D/7343-31	T520D477M004A(1)E040	188	10	40	2400	3	105
4	680	D/7343-31	T520D687M004A(1)E012	272	10	12	4300	3	105
4	680	D/7343-31	T520D687M004A(1)E015	272	10	15	3900	3	105
4	680	D/7343-31	T520D687M004A(1)E025	272	10	25	3000	3	105
4	680	Y/7343-40	T520Y687M004A(1)E010	272	10	10	4900	3	105
4	680	Y/7343-40	T520Y687M004A(1)E015	272	10	15	4000	3	105
4	680	Y/7343-40	T520Y687M004A(1)E025	272	10	25	3100	3	105
4	680	X/7343-43	T520X687M004A(1)E010	272	10	10	5000	3	105
4	680	X/7343-43	T520X687M004A(1)E015	272	10	15	4100	3	105
4	680	X/7343-43	T520X687M004A(1)E035	272	10	35	2700	3	105
6.3	15	T/3528-12	T520T156M006A(1)E100	9	8	100	1000	3	105
6.3	22	A/3216-18	T520A226M006A(1)E090	14	8	90	1100	3	105
6.3	22	A/3216-18	T520A226M006A(1)E100	14	8	100	1100	3	105
6.3	33	A/3216-18	T520A336M006A(1)E070	21	8	70	1300	3	105
6.3	33	A/3216-18	T520A336M006A(1)E080	21	8	80	1200	3	105
6.3	33	A/3216-18	T520A336M006A(1)E120	21	8	120	1000	3	105
6.3	33	T/3528-12	T520T336M006A(1)E070	21	8	70	1200	3	105
6.3	33	B/3528-21	T520B336M006A(1)E025	21	8	25	2300	3	105
6.3	33	B/3528-21	T520B336M006A(1)E035	21	8	35	1900	3	105
6.3	33	B/3528-21	T520B336M006A(1)E040	21	8	40	1800	3	105
VDC	µF	KEMET/EIA	(See below for part options)	µA @ 20°C Maximum/5 Minutes	% @ 20°C 120 Hz Maximum	mΩ @ 20°C 100 kHz Maximum	(mA) 45°C 100 kHz	Temperature ≤ 260°C	(°C)
Rated Voltage	Rated Cap	Case Code/ Case Size	KEMET Part Number	DC Leakage	DF	ESR	Maximum Allowable Ripple Current	Moisture Sensitivity	Rated Temp

Other part number options:

1- Standard with tin terminations (14th character = T). Tin/lead terminations is also available (14th character = H).

Also available on large (13 inch) reels. Add 7280 to the end of the part number.

Higher voltage ratings and tighter tolerance product including ESR may be substituted within the same size at KEMET's option. Voltage substitutions will be marked with the higher voltage rating. Substitutions can include better than series.

Table 1 – Ratings & Part Number Reference cont'd

Rated Voltage	Rated Cap	Case Code/ Case Size	KEMET Part Number	DC Leakage	DF	ESR	Maximum Allowable Ripple Current	Moisture Sensitivity	Rated Temp
VDC	µF	KEMET/EIA	(See below for part options)	µA @ 20°C Maximum/5 Minutes	% @ 20°C 120 Hz Maximum	mΩ @ 20°C 100 kHz Maximum	(mA) 45°C 100 kHz	Temperature ≤ 260°C	(°C)
6.3	33	B/3528-21	T520B336M006A(1)E070	21	8	70	1300	3	105
6.3	33	C/6032-28	T520C336M006A(1)E100	21	8	100	1300	3	105
6.3	47	A/3216-18	T520A476M006A(1)E150	30	8	150	900	3	105
6.3	47	T/3528-12	T520T476M006A(1)E040	30	8	40	1600	3	105
6.3	47	T/3528-12	T520T476M006A(1)E070	30	8	70	1200	3	105
6.3	47	B/3528-21	T520B476M006A(1)E025	30	8	25	2300	3	105
6.3	47	B/3528-21	T520B476M006A(1)E035	30	8	35	1900	3	105
6.3	47	B/3528-21	T520B476M006A(1)E040	30	8	40	1800	3	105
6.3	47	B/3528-21	T520B476M006A(1)E070	30	8	70	1300	3	105
6.3	68	A/3216-18	T520A686M006A(1)E150	43	8	150	900	3	105
6.3	68	T/3528-12	T520T686M006A(1)E070	43	8	70	1200	3	105
6.3	68	T/3528-12	T520T686M006A(1)E150	43	8	150	800	3	105
6.3	68	B/3528-21	T520B686M006A(1)E025	43	8	25	2300	3	105
6.3	68	B/3528-21	T520B686M006A(1)E035	43	8	35	1900	3	105
6.3	68	B/3528-21	T520B686M006A(1)E040	43	8	40	1800	3	105
6.3	68	B/3528-21	T520B686M006A(1)E070	43	8	70	1300	3	105
6.3	68	U/6032-15	T520U686M006A(1)E055	43	8	55	1600	3	105
6.3	68	U/6032-15	T520U686M006A(1)E070	43	8	70	1400	3	105
6.3	68	C/6032-28	T520C686M006A(1)E100	43	8	100	1300	3	105
6.3	100	T/3528-12	T520T107M006A(1)E070	63	8	70	1200	3	105
6.3	100	B/3528-21	T520B107M006A(1)E015	63	8	15	2900	3	105
6.3	100	B/3528-21	T520B107M006A(1)E018	63	8	18	2700	3	105
6.3	100	B/3528-21	T520B107M006A(1)E025	63	8	25	2300	3	105
6.3	100	B/3528-21	T520B107M006A(1)E035	63	8	35	1900	3	105
6.3	100	B/3528-21	T520B107M006A(1)E040	63	8	40	1800	3	105
6.3	100	B/3528-21	T520B107M006A(1)E045	63	8	45	1700	3	105
6.3	100	B/3528-21	T520B107M006A(1)E070	63	8	70	1300	3	105
6.3	100	U/6032-15	T520U107M006A(1)E055	63	8	55	1600	3	105
6.3	100	W/7343-15	T520W107M006A(1)E040	63	10	40	2100	3	105
6.3	100	V/7343-19	T520V107M006A(1)E009	63	10	9	4600	3	105
6.3	100	V/7343-19	T520V107M006A(1)E012	63	10	12	3900	3	105
6.3	100	V/7343-19	T520V107M006A(1)E015	63	10	15	3500	3	105
6.3	100	V/7343-19	T520V107M006A(1)E045	63	10	45	2000	3	105
6.3	100	C/6032-28	T520C107M006A(1)E025	63	8	25	2600	3	105
6.3	100	C/6032-28	T520C107M006A(1)E045	63	8	45	1900	3	105
6.3	120	B/3528-21	T520B127M006A(1)E035	76	8	35	1900	3	105
6.3	150	M/3528-15	T520M157M006A(1)E070	95	8	70	1300	3	105
6.3	150	M/3528-15	T520M157M006A(1)E150	95	8	150	900	3	105
6.3	150	M/3528-15	T520M157M006A(1)E200	95	8	200	800	3	105
6.3	150	B/3528-21	T520B157M006A(1)E025	95	8	25	2300	3	105
6.3	150	B/3528-21	T520B157M006A(1)E035	95	8	35	1900	3	105
6.3	150	B/3528-21	T520B157M006A(1)E045	95	8	45	1700	3	105
6.3	150	B/3528-21	T520B157M006A(1)E070	95	8	70	1300	3	105
6.3	150	C/6032-28	T520C157M006A(1)E015	95	8	15	3300	3	105
6.3	150	C/6032-28	T520C157M006A(1)E025	95	8	25	2600	3	105
6.3	150	C/6032-28	T520C157M006A(1)E045	95	8	45	1900	3	105
6.3	150	C/6032-28	T520C157M006A(1)E055	95	8	55	1700	3	105
6.3	150	U/6032-15	T520U157M006A(1)E045	95	8	45	1700	3	105
6.3	150	U/6032-15	T520U157M006A(1)E055	95	8	55	1600	3	105
6.3	150	L/6032-19	T520L157M006A(1)E012	95	8	12	3500	3	105
6.3	150	L/6032-19	T520L157M006A(1)E025	95	8	25	2400	3	105
VDC	µF	KEMET/EIA	(See below for part options)	µA @ 20°C Maximum/5 Minutes	% @ 20°C 120 Hz Maximum	mΩ @ 20°C 100 kHz Maximum	(mA) 45°C 100 kHz	Temperature ≤ 260°C	(°C)
Rated Voltage	Rated Cap	Case Code/ Case Size	KEMET Part Number	DC Leakage	DF	ESR	Maximum Allowable Ripple Current	Moisture Sensitivity	Rated Temp

Other part number options:

1- Standard with tin terminations (14th character = T). Tin/lead terminations is also available (14th character = H).

Also available on large (13 inch) reels. Add 7280 to the end of the part number.

Higher voltage ratings and tighter tolerance product including ESR may be substituted within the same size at KEMET's option. Voltage substitutions will be marked with the higher voltage rating. Substitutions can include better than series.

Table 1 – Ratings & Part Number Reference cont'd

Rated Voltage	Rated Cap	Case Code/ Case Size	KEMET Part Number	DC Leakage	DF	ESR	Maximum Allowable Ripple Current	Moisture Sensitivity	Rated Temp
VDC	µF	KEMET/EIA	(See below for part options)	µA @ 20°C Maximum/5 Minutes	% @ 20°C 120 Hz Maximum	mΩ @ 20°C 100 kHz Maximum	(mA) 45°C 100 kHz	Temperature ≤ 260°C	(°C)
6.3	150	W/7343-15	T520W157M006A(1)E025	95	10	25	2700	3	105
6.3	150	W/7343-15	T520W157M006A(1)E040	95	10	40	2100	3	105
6.3	150	V/7343-19	T520V157M006A(1)E006	95	10	6	5600	3	105
6.3	150	V/7343-19	T520V157M006A(1)E007	95	10	7	5200	3	105
6.3	150	V/7343-19	T520V157M006A(1)E009	95	10	9	4600	3	105
6.3	150	V/7343-19	T520V157M006A(1)E012	95	10	12	3900	3	105
6.3	150	V/7343-19	T520V157M006A(1)E015	95	10	15	3500	3	105
6.3	150	V/7343-19	T520V157M006A(1)E018	95	10	18	3200	3	105
6.3	150	V/7343-19	T520V157M006A(1)E025	95	10	25	2700	3	105
6.3	150	V/7343-19	T520V157M006A(1)E040	95	10	40	2200	3	105
6.3	150	V/7343-19	T520V157M006A(1)E045	95	10	45	2000	3	105
6.3	150	D/7343-31	T520D157M006A(1)E006	95	10	6	6100	3	105
6.3	150	D/7343-31	T520D157M006A(1)E007	95	10	7	5700	3	105
6.3	150	D/7343-31	T520D157M006A(1)E015	95	10	15	3900	3	105
6.3	150	D/7343-31	T520D157M006A(1)E025	95	10	25	3000	3	105
6.3	150	D/7343-31	T520D157M006A(1)E055	95	10	55	2000	3	105
6.3	220	B/3528-21	T520B227M006A(1)E035	139	8	35	1900	3	105
6.3	220	B/3528-21	T520B227M006A(1)E045	139	8	45	1700	3	105
6.3	220	B/3528-21	T520B227M006A(1)E070	139	8	70	1300	3	105
6.3	220	C/6032-28	T520C227M006A(1)E015	139	8	15	3300	3	105
6.3	220	C/6032-28	T520C227M006A(1)E018	139	8	18	3000	3	105
6.3	220	C/6032-28	T520C227M006A(1)E025	139	8	25	2600	3	105
6.3	220	C/6032-28	T520C227M006A(1)E045	139	8	45	1900	3	105
6.3	220	V/7343-19	T520V227M006A(1)E007	139	10	7	5200	3	105
6.3	220	V/7343-19	T520V227M006A(1)E009	139	10	9	4600	3	105
6.3	220	V/7343-19	T520V227M006A(1)E012	139	10	12	3900	3	105
6.3	220	V/7343-19	T520V227M006A(1)E015	139	10	15	3500	3	105
6.3	220	V/7343-19	T520V227M006A(1)E018	139	10	18	3200	3	105
6.3	220	V/7343-19	T520V227M006A(1)E025	139	10	25	2700	3	105
6.3	220	V/7343-19	T520V227M006A(1)E040	139	10	40	2200	3	105
6.3	220	D/7343-31	T520D227M006A(1)E006	139	10	6	6100	3	105
6.3	220	D/7343-31	T520D227M006A(1)E007	139	10	7	5700	3	105
6.3	220	D/7343-31	T520D227M006A(1)E009	139	10	9	5000	3	105
6.3	220	D/7343-31	T520D227M006A(1)E015	139	10	15	3900	3	105
6.3	220	D/7343-31	T520D227M006A(1)E018	139	10	18	3500	3	105
6.3	220	D/7343-31	T520D227M006A(1)E025	139	10	25	3000	3	105
6.3	220	D/7343-31	T520D227M006A(1)E040	139	10	40	2400	3	105
6.3	220	D/7343-31	T520D227M006A(1)E050	139	10	50	2100	3	105
6.3	330	V/7343-19	T520V337M006A(1)E015	208	10	15	3500	3	105
6.3	330	V/7343-19	T520V337M006A(1)E018	208	10	18	3200	3	105
6.3	330	V/7343-19	T520V337M006A(1)E025	208	10	25	2700	3	105
6.3	330	V/7343-19	T520V337M006A(1)E040	208	10	40	2200	3	105
6.3	330	V/7343-19	T520V337M006A(1)E045	208	10	45	2000	3	105
6.3	330	D/7343-31	T520D337M006A(1)E009	208	10	9	5000	3	105
6.3	330	D/7343-31	T520D337M006A(1)E010	208	10	10	4700	3	105
6.3	330	D/7343-31	T520D337M006A(1)E015	208	10	15	3900	3	105
6.3	330	D/7343-31	T520D337M006A(1)E018	208	10	18	3500	3	105
6.3	330	D/7343-31	T520D337M006A(1)E025	208	10	25	3000	3	105
6.3	330	D/7343-31	T520D337M006A(1)E040	208	10	40	2400	3	105
6.3	330	D/7343-31	T520D337M006A(1)E045	208	10	45	2200	3	105
6.3	330	Y/7343-40	T520Y337M006A(1)E010	208	10	10	4900	3	105
VDC	µF	KEMET/EIA	(See below for part options)	µA @ 20°C Maximum/5 Minutes	% @ 20°C 120 Hz Maximum	mΩ @ 20°C 100 kHz Maximum	(mA) 45°C 100 kHz	Temperature ≤ 260°C	(°C)
Rated Voltage	Rated Cap	Case Code/ Case Size	KEMET Part Number	DC Leakage	DF	ESR	Maximum Allowable Ripple Current	Moisture Sensitivity	Rated Temp

Other part number options:

1- Standard with tin terminations (14th character = T). Tin/lead terminations is also available (14th character = H).

Also available on large (13 inch) reels. Add 7280 to the end of the part number.

Higher voltage ratings and tighter tolerance product including ESR may be substituted within the same size at KEMET's option. Voltage substitutions will be marked with the higher voltage rating. Substitutions can include better than series.

Table 1 – Ratings & Part Number Reference cont'd

Rated Voltage	Rated Cap	Case Code/ Case Size	KEMET Part Number	DC Leakage	DF	ESR	Maximum Allowable Ripple Current	Moisture Sensitivity	Rated Temp
VDC	µF	KEMET/EIA	(See below for part options)	µA @ 20°C Maximum/5 Minutes	% @ 20°C 120 Hz Maximum	mΩ @ 20°C 100 kHz Maximum	(mA) 45°C 100 kHz	Temperature ≤ 260°C	(°C)
6.3	330	Y/7343-40	T520Y337M006A(1)E015	208	10	15	4000	3	105
6.3	330	Y/7343-40	T520Y337M006A(1)E025	208	10	25	3100	3	105
6.3	330	Y/7343-40	T520Y337M006A(1)E040	208	10	40	2500	3	105
6.3	470	W/7343-15	T520W477M006A(1)E055	296	10	55	1800	3	85
6.3	470	V/7343-19	T520V477M006A(1)E055	296	10	55	1800	3	85
6.3	470	Y/7343-40	T520Y477M006A(1)E010	296	10	10	4900	3	105
6.3	470	Y/7343-40	T520Y477M006A(1)E015	296	10	15	4000	3	105
6.3	470	Y/7343-40	T520Y477M006A(1)E018	296	10	18	3700	3	105
6.3	470	Y/7343-40	T520Y477M006A(1)E025	296	10	25	3100	3	105
6.3	470	Y/7343-40	T520Y477M006A(1)E035	296	10	35	2600	3	105
6.3	470	D/7343-31	T520D477M006A(1)E015	296	10	15	3900	3	105
6.3	470	D/7343-31	T520D477M006A(1)E025	296	10	25	3000	3	105
6.3	470	D/7343-31	T520D477M006A(1)E030	296	10	30	2700	3	105
6.3	470	X/7343-43	T520X477M006A(1)E010	296	10	10	5000	3	105
6.3	470	X/7343-43	T520X477M006A(1)E018	296	10	18	3700	3	105
6.3	470	X/7343-43	T520X477M006A(1)E035	296	10	35	2700	3	105
6.3	470	X/7343-43	T520X477M006A(1)E040	296	10	40	2500	3	105
6.3	1000	H/7260-20	T520H108M006A(1)E055	630	20	55	1800	4	85
6.3	1500	H/7260-20	T520H158M006A(1)E055	945	20	55	1800	4	85
8	33	T/3528-12	T520T336M008A(1)E070	26	8	70	1200	3	105
8	33	T/3528-12	T520T336M008A(1)E080	26	8	80	1100	3	105
8	33	B/3528-21	T520B336M008A(1)E025	26	8	25	2300	3	105
8	33	B/3528-21	T520B336M008A(1)E035	26	8	35	1900	3	105
8	33	B/3528-21	T520B336M008A(1)E040	26	8	40	1800	3	105
8	33	B/3528-21	T520B336M008A(1)E070	26	8	70	1300	3	105
8	33	U/6032-15	T520U336M008A(1)E070	26	8	70	1400	3	105
8	47	B/3528-21	T520B476M008A(1)E035	38	8	35	1900	3	105
8	47	B/3528-21	T520B476M008A(1)E070	38	8	70	1300	3	105
8	82	C/6032-28	T520C826M008A(1)E025	66	8	25	2600	3	105
8	82	C/6032-28	T520C826M008A(1)E045	66	8	45	1900	3	105
8	150	D/7343-31	T520D157M008A(1)E025	120	10	25	3000	3	105
8	150	D/7343-31	T520D157M008A(1)E040	120	10	40	2400	3	105
8	150	D/7343-31	T520D157M008A(1)E055	120	10	55	2000	3	105
8	150	V/7343-19	T520V157M008A(1)E040	120	10	40	2200	3	105
10	10	A/3216-18	T520A106M010A(1)E080	10	8	80	1200	3	105
10	15	A/3216-18	T520A156M010A(1)E080	15	8	80	1200	3	105
10	22	A/3216-18	T520A226M010A(1)E080	22	8	80	1200	3	105
10	33	T/3528-12	T520T336M010A(1)E040	33	8	40	1600	3	105
10	33	T/3528-12	T520T336M010A(1)E070	33	8	70	1200	3	105
10	33	T/3528-12	T520T336M010A(1)E080	33	8	80	1100	3	105
10	33	B/3528-21	T520B336M010A(1)E025	33	8	25	2300	3	105
10	33	B/3528-21	T520B336M010A(1)E035	33	8	35	1900	3	105
10	33	B/3528-21	T520B336M010A(1)E040	33	8	40	1800	3	105
10	33	B/3528-21	T520B336M010A(1)E070	33	8	70	1300	3	105
10	33	U/6032-15	T520U336M010A(1)E070	33	8	70	1400	3	105
10	47	B/3528-21	T520B476M010A(1)E035	47	8	35	1900	3	105
10	47	B/3528-21	T520B476M010A(1)E070	47	8	70	1300	3	105
10	47	U/6032-15	T520U476M010A(1)E055	47	8	55	1600	3	105
10	47	C/6032-28	T520C476M010A(1)E100	47	8	100	1300	3	105
VDC	µF	KEMET/EIA	(See below for part options)	µA @ 20°C Maximum/5 Minutes	% @ 20°C 120 Hz Maximum	mΩ @ 20°C 100 kHz Maximum	(mA) 45°C 100 kHz	Temperature ≤ 260°C	(°C)
Rated Voltage	Rated Cap	Case Code/ Case Size	KEMET Part Number	DC Leakage	DF	ESR	Maximum Allowable Ripple Current	Moisture Sensitivity	Rated Temp

Other part number options:

1- Standard with tin terminations (14th character = T). Tin/lead terminations is also available (14th character = H).

Also available on large (13 inch) reels. Add 7280 to the end of the part number.

Higher voltage ratings and tighter tolerance product including ESR may be substituted within the same size at KEMET's option. Voltage substitutions will be marked with the higher voltage rating. Substitutions can include better than series.

Table 1 – Ratings & Part Number Reference cont'd

Rated Voltage	Rated Cap	Case Code/ Case Size	KEMET Part Number	DC Leakage	DF	ESR	Maximum Allowable Ripple Current	Moisture Sensitivity	Rated Temp
VDC	µF	KEMET/EIA	(See below for part options)	µA @ 20°C Maximum/5 Minutes	% @ 20°C 120 Hz Maximum	mΩ @ 20°C 100 kHz Maximum	(mA) 45°C 100 kHz	Temperature ≤ 260°C	(°C)
10	68	U/6032-15	T520U686M010A(1)E055	68	8	55	1600	3	105
10	68	W/7343-15	T520W686M010A(1)E025	68	10	25	2700	3	105
10	68	W/7343-15	T520W686M010A(1)E040	68	10	40	2100	3	105
10	68	C/6032-28	T520C686M010A(1)E045	68	8	45	1900	3	105
10	68	V/7343-19	T520V686M010A(1)E025	68	10	25	2700	3	105
10	68	V/7343-19	T520V686M010A(1)E040	68	10	40	2200	3	105
10	68	V/7343-19	T520V686M010A(1)E045	68	10	45	2000	3	105
10	68	V/7343-19	T520V686M010A(1)E060	68	10	60	1800	3	105
10	68	V/7343-19	T520V686M010A(1)E100	68	10	100	1400	3	105
10	68	D/7343-31	T520D686M010A(1)E100	68	10	100	1500	3	105
10	100	C/6032-28	T520C107M010A(1)E025	100	8	25	2600	3	105
10	100	C/6032-28	T520C107M010A(1)E045	100	8	45	1900	3	105
10	100	L/6032-19	T520L107M010A(1)E025	100	8	25	2400	3	105
10	100	W/7343-15	T520W107M010A(1)E040	100	10	40	2100	3	105
10	100	V/7343-19	T520V107M010A(1)E018	100	10	18	3200	3	105
10	100	V/7343-19	T520V107M010A(1)E025	100	10	25	2700	3	105
10	100	V/7343-19	T520V107M010A(1)E045	100	10	45	2000	3	105
10	100	V/7343-19	T520V107M010A(1)E050	100	10	50	1900	3	105
10	100	D/7343-31	T520D107M010A(1)E018	100	10	18	3500	3	105
10	100	D/7343-31	T520D107M010A(1)E055	100	10	55	2000	3	105
10	100	D/7343-31	T520D107M010A(1)E080	100	10	80	1700	3	105
10	150	C/6032-28	T520C157M010A(1)E055	150	8	55	1700	3	105
10	150	V/7343-19	T520V157M010A(1)E018	150	10	18	3200	3	105
10	150	V/7343-19	T520V157M010A(1)E025	150	10	25	2700	3	105
10	150	V/7343-19	T520V157M010A(1)E040	150	10	40	2200	3	105
10	150	D/7343-31	T520D157M010A(1)E015	150	10	15	3900	3	105
10	150	D/7343-31	T520D157M010A(1)E018	150	10	18	3500	3	105
10	150	D/7343-31	T520D157M010A(1)E025	150	10	25	3000	3	105
10	150	D/7343-31	T520D157M010A(1)E040	150	10	40	2400	3	105
10	150	D/7343-31	T520D157M010A(1)E055	150	10	55	2000	3	105
10	150	Y/7343-40	T520Y157M010A(1)E015	150	10	15	4000	3	105
10	150	Y/7343-40	T520Y157M010A(1)E018	150	10	18	3700	3	105
10	150	Y/7343-40	T520Y157M010A(1)E025	150	10	25	3100	3	105
10	220	V/7343-19	T520V227M010A(1)E045	220	10	45	2000	3	105
10	220	V/7343-19	T520V227M010A(1)E025	220	10	25	2700	3	105
10	220	D/7343-31	T520D227M010A(1)E018	220	10	18	3500	3	105
10	220	D/7343-31	T520D227M010A(1)E025	220	10	25	3000	3	105
10	220	D/7343-31	T520D227M010A(1)E040	220	10	40	2400	3	105
10	220	Y/7343-40	T520Y227M010A(1)E040	220	10	40	2500	3	105
10	330	Y/7343-40	T520Y337M010A(1)E010	330	10	10	4900	3	105
10	330	Y/7343-40	T520Y337M010A(1)E015	330	10	15	4000	3	105
10	330	Y/7343-40	T520Y337M010A(1)E035	330	10	35	2600	3	105
10	330	X/7343-43	T520X337M010A(1)E010	330	10	10	5000	3	105
10	330	X/7343-43	T520X337M010A(1)E025	330	10	25	3100	3	105
10	330	X/7343-43	T520X337M010A(1)E040	330	10	40	2500	3	105
12.5	10	T/3528-12	T520T106M12RA(1)E150	13	8	150	800	3	105
12.5	15	T/3528-12	T520T156M12RA(1)E080	19	8	80	1100	3	105
16	10	B/3528-21	T520B106M016A(1)E100	16	8	100	1100	3	105
16	22	C/6032-28	T520C226M016A(1)E080	35	8	80	1400	3	105
VDC	µF	KEMET/EIA	(See below for part options)	µA @ 20°C Maximum/5 Minutes	% @ 20°C 120 Hz Maximum	mΩ @ 20°C 100 kHz Maximum	(mA) 45°C 100 kHz	Temperature ≤ 260°C	(°C)
Rated Voltage	Rated Cap	Case Code/ Case Size	KEMET Part Number	DC Leakage	DF	ESR	Maximum Allowable Ripple Current	Moisture Sensitivity	Rated Temp

Other part number options:

1- Standard with tin terminations (14th character = T). Tin/lead terminations is also available (14th character = H).

Also available on large (13 inch) reels. Add 7280 to the end of the part number.

Higher voltage ratings and tighter tolerance product including ESR may be substituted within the same size at KEMET's option. Voltage substitutions will be marked with the higher voltage rating. Substitutions can include better than series.

Table 1 – Ratings & Part Number Reference cont'd

Rated Voltage	Rated Cap	Case Code/ Case Size	KEMET Part Number	DC Leakage	DF	ESR	Maximum Allowable Ripple Current	Moisture Sensitivity	Rated Temp
VDC	µF	KEMET/EIA	(See below for part options)	µA @ 20°C Maximum/5 Minutes	% @ 20°C 120 Hz Maximum	mΩ @ 20°C 100 kHz Maximum	(mA) 45°C 100 kHz	Temperature ≤ 260°C	(°C)
16	22	C/6032-28	T520C226M016A(1)E080	35	8	80	1400	3	105
16	33	W/7343-15	T520W336M016A(1)E045	53	10	45	2000	3	105
16	33	V/7343-19	T520V336M016A(1)E045	53	10	45	2000	3	105
16	33	V/7343-19	T520V336M016A(1)E060	53	10	60	1800	3	105
16	33	V/7343-19	T520V336M016A(1)E070	53	10	70	1600	3	105
16	47	W/7343-15	T520W476M016A(1)E045	75	10	45	2000	3	105
16	47	V/7343-19	T520V476M016A(1)E045	75	10	45	2000	3	105
16	47	V/7343-19	T520V476M016A(1)E070	75	10	70	1600	3	105
16	47	D/7343-31	T520D476M016A(1)E035	75	10	35	2500	3	105
16	47	D/7343-31	T520D476M016A(1)E070	75	10	70	1800	3	105
16	68	D/7343-31	T520D686M016A(1)E050	109	10	50	2100	3	105
16	150	X/7343-43	T520X157M016A(1)E040	240	10	40	2500	3	105
20	22	V/7343-19	T520V226M020A(1)E040	44	10	40	2200	3	105
20	22	V/7343-19	T520V226M020A(1)E045	44	10	45	2000	3	105
20	22	V/7343-19	T520V226M020A(1)E090	44	10	90	1400	3	105
25	15	V/7343-19	T520V156M025A(1)E090	38	10	90	1400	3	105
25	15	D/7343-31	T520D156M025A(1)E060	38	10	60	1900	3	105
25	15	D/7343-31	T520D156M025A(1)E080	38	10	80	1700	3	105
VDC	µF	KEMET/EIA	(See below for part options)	µA @ 20°C Maximum/5 Minutes	% @ 20°C 120 Hz Maximum	mΩ @ 20°C 100 kHz Maximum	(mA) 45°C 100 kHz	Temperature ≤ 260°C	(°C)
Rated Voltage	Rated Cap	Case Code/ Case Size	KEMET Part Number	DC Leakage	DF	ESR	Maximum Allowable Ripple Current	Moisture Sensitivity	Rated Temp

Other part number options:

(1) Standard with tin terminations (14th character = T). Tin/lead terminations is also available (14th character = H).

Also available on large (13 inch) reels. Add 7280 to the end of the part number.

Higher voltage ratings and tighter tolerance product including ESR may be substituted within the same size at KEMET's option. Voltage substitutions will be marked with the higher voltage rating. Substitutions can include better than series.

Derating Guidelines

Voltage Rating	Maximum Recommended Steady State Voltage	Maximum Recommended Transient Voltage (1 ms – 1 μs)
-55°C to 105°C		
$2. V \leq V_R \leq 10 V$	90% of V_R	V_R
$12.5 V \leq V_R \leq 25 V$	80% of V_R	V_R

V_R = Rated Voltage

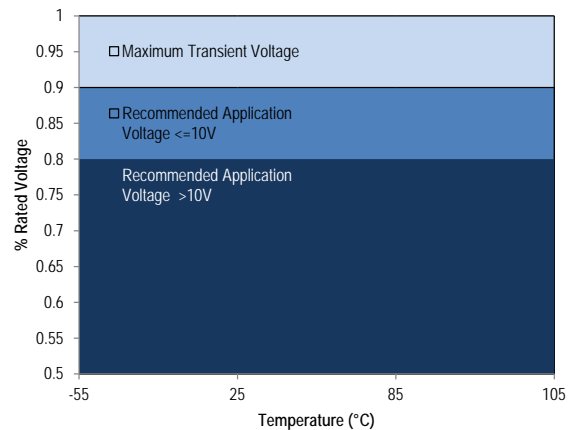

Ripple Current/Ripple Voltage

Permissible AC ripple voltage and current are related to equivalent series resistance (ESR) and the power dissipation capabilities of the device. Permissible AC ripple voltage which may be applied is limited by two criteria:

1. The positive peak AC voltage plus the DC bias voltage, if any, must not exceed the DC voltage rating of the capacitor.
2. The negative peak AC voltage in combination with bias voltage, if any, must not exceed the allowable limits specified for reverse voltage. See the Reverse Voltage section for allowable limits.

The maximum power dissipation by case size can be determined using the table at right. The maximum power dissipation rating stated in the table must be reduced with increasing environmental operating temperatures. Refer to the table below for temperature compensation requirements.

KEMET Series and Case Code	EIA Case Code	Maximum Power Dissipation (P max) mWatts @ 45°C with +30°C Rise
T520T	3528-12	105
T520M	3528-15	120
T520A	3216-18	112
T520B	3528-21	127
T520U	6032-15	135
T520L	3528-19	150
T520C	6032-28	165
T520W	7343-15	180
T520V / T522V	7343-19	187
T520D	7343-31	225
T520Y/T522Y	7343-40	241
T520X	7343-43	247
T520H	7360-20	187

The maximum power dissipation rating must be reduced with increasing environmental operating temperatures. Refer to the Temperature Compensation Multiplier table for details.

Temperature Compensation Multipliers for Maximum Power Dissipation		
≤ 45°C	45° C < T ≤ 85°C	85°C < T ≤ 125°C
1.00	0.70	0.25

T = Environmental Temperature

Using the P max of the device, the maximum allowable rms ripple current or voltage may be determined.

$$I(max) = \sqrt{P_{max}/R}$$

$$E(max) = \sqrt{P_{max} \cdot R}$$

I = rms ripple current (amperes)

E = rms ripple voltage (volts)

Reverse Voltage

Polymer tantalum capacitors are polar devices and may be permanently damaged or destroyed if connected in the wrong polarity. These devices will withstand a small degree of transient voltage reversal for short periods as shown in the below table.

Temperature	Permissible Transient Reverse Voltage
25°C	15% of Rated Voltage
55°C	10% of Rated Voltage
85°C	5% of Rated Voltage
105°C	3% of Rated Voltage
125°C*	1% of Rated Voltage

*For series rated to 125°C

Table 2 – Land Dimensions/Courtyard

KEMET	Metric Size Code	Density Level A: Maximum (Most) Land Protrusion (mm)					Density Level B: Median (Nominal) Land Protrusion (mm)					Density Level C: Minimum (Least) Land Protrusion (mm)				
		X	Y	C	V1	V2	X	Y	C	V1	V2	X	Y	C	V1	V2
A	3216-18	1.35	2.15	1.45	6.10	2.80	1.25	1.75	1.35	5.00	2.30	1.15	1.35	1.25	4.10	2.00
B	3528-21	2.35	2.15	1.45	6.10	4.00	2.25	1.75	1.35	5.00	3.50	2.15	1.35	1.25	4.10	3.20
C	6032-25	2.35	2.65	2.60	8.90	4.40	2.25	2.25	2.50	7.80	3.90	2.15	1.85	2.40	6.90	3.60
D	7343-31	2.55	3.75	2.70	10.20	5.50	2.45	3.35	2.60	9.10	5.00	2.35	2.95	2.50	8.20	4.70
H	7360-20	4.25	2.65	3.20	10.10	7.20	4.15	2.25	3.30	9.40	6.70	4.05	1.85	3.00	8.10	6.40
L	6032-19	2.35	2.65	2.60	8.90	4.40	2.25	2.25	2.50	7.80	3.90	2.15	1.85	2.40	6.90	3.60
M	3528-15	2.35	2.15	1.45	6.10	4.00	2.25	1.75	1.35	5.00	3.70	2.15	1.35	1.25	4.10	3.40
T	3528-12	2.35	2.15	1.45	6.10	4.00	2.25	1.75	1.35	5.00	3.50	2.15	1.35	1.25	4.10	3.20
U	6032-15	2.35	2.65	2.60	8.90	4.40	2.25	2.25	2.50	7.80	3.90	2.15	1.85	2.40	6.90	3.60
V	7343-19	2.55	3.75	2.70	10.20	5.50	2.45	3.35	2.60	9.10	5.00	2.35	2.95	2.50	8.20	4.70
W	7343-15	2.55	3.75	2.70	10.20	5.50	2.45	3.35	2.60	9.10	5.00	2.35	2.95	2.50	8.20	4.70
X ¹	7343-43	2.55	3.75	2.70	10.20	5.50	2.45	3.35	2.60	9.10	5.00	2.35	2.95	2.50	8.20	4.70
Y ¹	7343-40	2.55	3.75	2.70	10.20	5.50	2.45	3.35	2.60	9.10	5.00	2.35	2.95	2.50	8.20	4.70

Density Level A: For low-density product applications. Recommended for wave solder applications and provides a wider process window for reflow solder processes.

Density Level B: For products with a moderate level of component density. Provides a robust solder attachment condition for reflow solder processes.

Density Level C: For high component density product applications. Before adapting the minimum land pattern variations the user should perform qualification testing based on the conditions outlined in IPC Standard 7351 (IPC-7351).

¹ Height of these chips may create problems in wave soldering.



Soldering Process

KEMET’s families of surface mount capacitors are compatible with wave (single or dual), convection, IR, or vapor phase reflow techniques. Preheating of these components is recommended to avoid extreme thermal stress. KEMET’s recommended profile conditions for convection and IR reflow reflect the profile conditions of the IPC/J–STD–020D standard for moisture sensitivity testing. The devices can safely withstand a maximum of three reflow passes at these conditions.

Please note that although the X/7343–43 case size can withstand wave soldering, the tall profile (4.3 mm maximum) dictates care in wave process development.

Hand soldering should be performed with care due to the difficulty in process control. If performed, care should be taken to avoid contact of the soldering iron to the molded case. The iron should be used to heat the solder pad, applying solder between the pad and the termination, until reflow occurs. Once reflow occurs, the iron should be removed immediately. “Wiping” the edges of a chip and heating the top surface is not recommended.

During typical reflow operations, a slight darkening of the gold-colored epoxy may be observed. This slight darkening is normal and not harmful to the product. Marking permanency is not affected by this change.

Profile Feature	SnPb Assembly	Pb-Free Assembly
Preheat/Soak		
Temperature Minimum (T_{smin})	100°C	150°C
Temperature Maximum (T_{smax})	150°C	200°C
Time (t_s) from T_{smin} to T_{smax}	60 – 120 seconds	60 – 120 seconds
Ramp-up Rate (T_L to T_p)	3°C/seconds maximum	3°C/seconds maximum
Liquidous Temperature (T_L)	183°C	217°C
Time Above Liquidous (t_L)	60 – 150 seconds	60 – 150 seconds
Peak Temperature (T_p)	220°C* 235°C**	250°C* 260°C**
Time within 5°C of Maximum Peak Temperature (t_p)	20 seconds maximum	30 seconds maximum
Ramp-down Rate (T_p to T_L)	6°C/seconds maximum	6°C/seconds maximum
Time 25°C to Peak Temperature	6 minutes maximum	8 minutes maximum

Note: All temperatures refer to the center of the package, measured on the package body surface that is facing up during assembly reflow.

*Case Size D, E, P, Y, and X

**Case Size A, B, C, H, I, K, M, R, S, T, U, V, W, and Z



Construction



Capacitor Marking

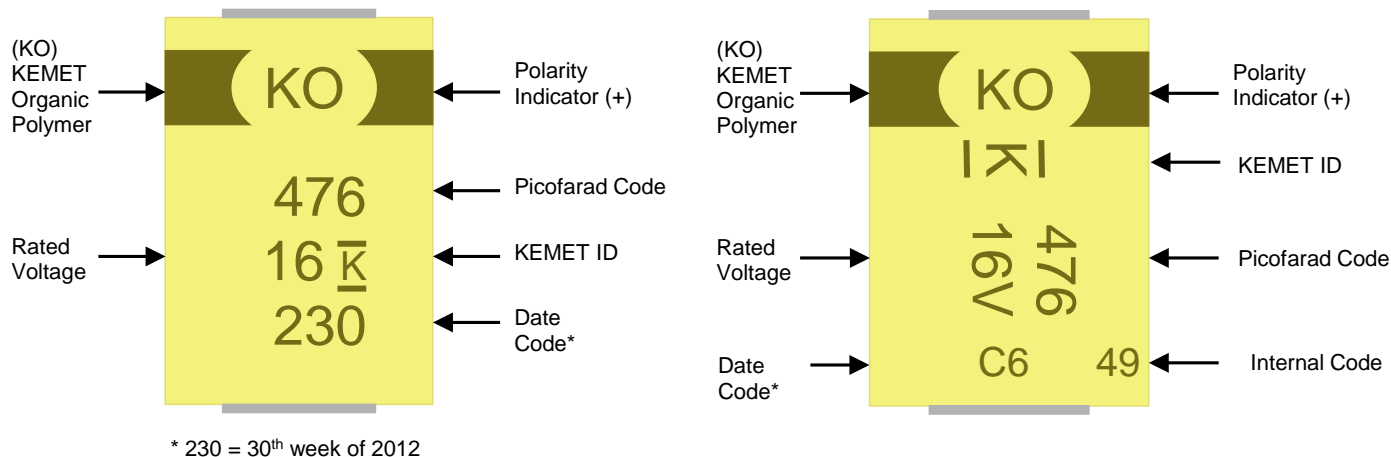

Date Code *	
1 st digit = Last number of Year	9 = 2009 0 = 2010 1 = 2011 2 = 2012 3 = 2013
2 nd and 3 rd digit = Week of the Year	01 = 1 st week of the Year to 52 = 52 nd week of the Year

Date Code*		
Year	Month	
X = 2009	1 = Jan	7 = Jul
A = 2010	2 = Feb	8 = Aug
B = 2011	3 = Mar	9 = Spt
C = 2012	4 = Apr	O = Oct
D = 2013	5 = May	N = Nov
E = 2014	6 = Jun	D = Dec

Storage

All KO-CAP Series are shipped in moisture barrier bags with a desiccant and moisture indicator card. These series are classified as MSL3 (Moisture Sensitivity Level 3). Product contained within the moisture barrier bags should be stored in normal working environments with temperatures not to exceed 40°C and humidity not in excess of 60% RH.

Overview

The KEMET Organic Capacitor (KO-CAP) is a tantalum capacitor with a Ta anode and Ta₂O₅ dielectric. A conductive organic polymer replaces the traditionally used MnO₂ as the cathode plate of the capacitor. This results in very low ESR and improved capacitance retention at high frequency. The KO-CAP also exhibits a benign failure mode which eliminates the ignition failures that can occur in standard MnO₂ tantalum types. KO-CAPs may also be operated at voltages up to 90% of rated voltage for part types with rated voltages of ≤ 10 volts and up to 80% of rated voltage for part types > 10 volts with equivalent or better reliability than traditional MnO₂ tantalum capacitors operated at 50% of rated voltage.

The T521 Series High Voltage Polymer Tantalum is designed for higher application voltages such as 12 V, 24 V, 28 V, and 48 V input rails. This series demonstrates excellent high voltage handling capabilities and reliability and is commonly selected as a replacement for other high capacitance dielectrics such as MnO₂ tantalum and aluminum electrolytic capacitors. The T521 Series can be safely operated at 80% of the rated voltages and can withstand transient conditions up to the rated voltage of the component. This series offers higher capacitance for a given application voltage when compared to multilayer ceramic and tantalum MnO₂ devices. The T521 Series also offers superior ESR performance over tantalum MnO₂ and aluminum electrolytic capacitors and a much lower profile than aluminum polymer and aluminum electrolytic capacitors.

Benefits

- Voltage ratings to 63 V
- Volumetric efficiency
- Stable temperature characteristics
- Up to 330 µF capacitance value
- High ripple current capability
- Low ESR
- High reliability
- Low profile design
- Benign failure mode
- Pb Free when ordered with 100% Sn termination
- RoHS Compliant and Halogen Free

Applications

Typical applications include DC/DC converters, power supply input and higher voltage applications such as 12 V to 50 V power input rails in the military/aerospace and industrial markets.



Environmental Compliance

RoHS Compliant (6/6) according to Directive 2002/95/EC when ordered with 100% Sn solder.



RoHS Compliant

SPICE

For a detailed analysis of specific part numbers, please visit www.kemet.com for a free download of KEMET's SPICE software. The KEMET SPICE program is freeware intended to aid design engineers in analyzing the performance of these capacitors over frequency, temperature, ripple, and DC bias conditions.

Ordering Information

T	521	V	226	M	025	A	T	E060	
Capacitor Class	Series	Case Size	Capacitance Code (pF)	Capacitance Tolerance	Voltage	Failure Rate/Design	Lead Material	ESR Code	Packaging (C-Spec)
T = Tantalum	521 = High Voltage Polymer	D, V, W, X	First two digits represent significant figures. Third digit specifies number of zeros.	M = $\pm 20\%$	016 = 16 V 020 = 20 V 025 = 25 V 035 = 35 V 050 = 50 V 063 = 63 V	A = N/A	T = 100% Matte Tin (Sn) Plated H = Tin/Lead (SnPb) Solder Coated (5% Pb minimum)	E = ESR Last three digits specify ESR in m Ω . (060 = 60 m Ω)	Blank = 7" Reel 7280 = 13" Reel

Performance Characteristics

Item	Performance Characteristics
Operating Temperature	-55°C to 105°C/125°C (Refer to part number for maximum temperature rating)
Rated Capacitance Range	15 – 330 μ F @ 120 Hz/25°C
Capacitance Tolerance	M Tolerance (20%)
Rated Voltage Range	16 – 63 V
DF (120 Hz)	$\leq 10\%$ - Refer to Part Number Electrical Specification Table
ESR (100 kHz)	Refer to Part Number Electrical Specification Table
Leakage Current	≤ 0.1 CV (mA) at rated voltage after 5 minutes

Qualification

Test	Condition	Characteristics				
Endurance	105°C @ rated voltage, 2,000 hours 125°C @ 2/3 rated voltage, 2,000 hours**	Δ C/C	Within -20%/+10% of initial value			
		DF	Within initial limits			
		DCL	IL @ 105°C, 2 x IL @ 125°C			
		ESR	2 x Initial Limit			
Storage Life	105°C @ 0 volts, 2,000 hours 125°C @ 0 voltage, 2,000 hours**	Δ C/C	Within -20%/+10% of initial value			
		DF	Within initial limits			
		DCL	IL @ 105°C, 2 x IL @ 125°C			
		ESR	2 x Initial Limit			
Humidity	60° C, 90% RH, 500 hours, rated voltage 60° C, 90% RH, 500 hours, No Load	Δ C/C	Within -5%/+35% of initial value			
		DF	Within initial limits			
		DCL	Within 3.0 x initial limit			
Temperature Stability	Extreme temperature exposure at a succession of continuous steps at +25°C, -55°C, +25°C, +85°C, +105°/125°C, +25°C	+25°C	-55°C	+85°C	+105°/125°C	
		Δ C/C	IL*	±20%	±20%	±30%
		DF	IL	IL	1.2 x IL	1.5 x IL
		DCL	IL	n/a	10 x IL	10 x IL
Surge Voltage	105°C, 1.32 x rated voltage, 33 Ω Resistance, 1,000 cycles	Δ C/C	Within -20%/+10% of initial value			
		DF	Within initial limits			
		DCL	Within initial limits			
		ESR	Within initial limits			
Mechanical Shock/Vibration	MIL-STD-202, Method 213, Condition I, 100 G peak. MIL-STD-202, Method 204, Condition D, 10 Hz to 2,000 Hz, 20 G peak	Δ C/C	Within ±10% of initial value			
		DF	Within initial limits			
		DCL	Within initial limits			

*IL = Initial limit

**Refer to part number specifications for individual temperature classification.

Electrical Characteristics

ESR vs. Frequency



Capacitance vs. Frequency



Dimensions – Millimeters (Inches)

Metric will govern



Case Size		Component												
KEMET	EIA	L*	W*	H*	F* ±0.1 ±(.004)	S* ±0.3 ±(.012)	B* ±0.15 (Ref) ±.006	X (Ref)	P (Ref)	R (Ref)	T (Ref)	A (Min)	G (Ref)	E (Ref)
D	7343-31	7.3 ±0.3 (0.287 ±0.012)	4.3 ±0.3 (.169 ±.012)	2.8 ±0.3 (.110 ±.012)	2.4 (.094)	1.3 (.051)	0.5 (.020)	0.10 ± 0.10 (.004 ± .004)	0.9 (.035)	1.0 (.039)	0.13 (.005)	3.8 (.150)	3.5 (.138)	3.5 (.138)
V	7343-20	7.3 ±0.3 (0.287 ±0.012)	4.3 ±0.3 (.169 ±.012)	2.0 Maximum	2.4 (.094)	1.3 (.051)	n/a	0.05 (.002)	n/a	n/a	0.13 (.005)	3.8 (.150)	3.5 (.138)	3.5 (.138)
W	7343-15	7.3 ±0.3 (0.287 ±0.012)	4.3 ±0.3 (.169 ±.012)	1.5 (.059)	2.4 (.094)	1.3 (.051)	n/a	0.05 (.002)	n/a	n/a	0.13 (.005)	3.8 (.150)	3.5 (.138)	3.5 (.138)
X	7343-43	7.3 ±0.3 (0.287 ±0.012)	4.3 ±0.3 (.169 ±.012)	4.0 ±0.3 (.157 ±.012)	2.4 (.094)	1.3 (.051)	0.5 (.020)	0.10 ± 0.10 (.004 ± .004)	1.7 (.067)	1.0 (.039)	0.13 (.005)	3.8 (.150)	3.5 (.138)	3.5 (.138)

Notes: (Ref) – Dimensions provided for reference only. No dimensions are provided for B, P or R because low profile cases do not have a bevel or a notch.

* MIL-PRF-55365/8 specified dimensions

Table 1 – Ratings & Part Number Reference

Rated Voltage	Rated Cap	Case Code/ Case Size	KEMET Part Number	DC Leakage	DF	ESR	Maximum Allowable Ripple Current	Moisture Sensitivity	Rated Temp
VDC	µF	KEMET/EIA	(See below for part options)	µA @ 20°C Max/5 Min	%@ 20°C 120 Hz Max	mΩ @ 20°C 100 kHz Max	(mA) +45°C 100 kHz	Temp ≤ 260°C	(°C)
16	47	V/7343-20	T521V476M016A(1)E080	75.2	10	80	1500.0	3	105
16	47	D/7343-31	T521D476M016A(1)E045	75.2	10	45	2200.0	3	105
16	47	D/7343-31	T521D476M016A(1)E055	75.2	10	55	2000.0	3	105
16	47	D/7343-31	T521D476M016A(1)E070	75.2	10	70	1800.0	3	105
16	47	D/7343-31	T521D476M016A(1)E090	75.2	10	90	1600.0	3	105
16	68	V/7343-20	T521V686M016A(1)E050	108.8	10	50	1900.0	3	105
16	68	V/7343-20	T521V686M016A(1)E090	108.8	10	90	1400.0	3	105
16	100	V/7343-20	T521V107M016A(1)E050	160.0	10	50	1900.0	3	125
16	100	D/7343-31	T521D107M016A(1)E050	160.0	10	50	2100.0	3	105
16	150	X/7343-43	T521X157M016A(1)E080	240.0	10	80	1800.0	3	105
16	220	X/7343-43	T521X227M016A(1)E035	352.0	10	35	2700.0	3	125
16	220	X/7343-43	T521X227M016A(1)E050	352.0	10	50	2200.0	3	125
16	330	X/7343-43	T521X337M016A(1)E025	528.0	10	25	3100.0	3	125
16	330	X/7343-43	T521X337M016A(1)E050	528.0	10	50	2200.0	3	125
20	47	V/7343-20	T521V476M020A(1)E090	94.0	10	90	1400.0	3	125
20	47	V/7343-20	T521V476M020A(1)E055	94.0	10	55	1800.0	3	125
20	47	D/7343-31	T521D476M020A(1)E055	94.0	10	55	2000.0	3	125
25	15	V/7343-20	T521V156M025A(1)E090	37.5	10	90	1400.0	3	105
25	22	V/7343-20	T521V226M025A(1)E060	55.0	10	60	1800.0	3	105
25	22	V/7343-20	T521V226M025A(1)E090	55.0	10	90	1400.0	3	105
25	33	V/7343-20	T521V336M025A(1)E060	82.5	10	60	1800.0	3	105
25	33	D/7343-31	T521D336M025A(1)E060	82.5	10	60	1900.0	3	105
25	100	X/7343-43	T521X107M025A(1)E060	250.0	10	60	2000.0	3	105
35	15	V/7343-20	T521V156M035A(1)E100	52.5	10	100	1400.0	3	125
35	15	V/7343-20	T521V156M035A(1)E125	52.5	10	125	1200.0	3	125
35	33	D/7343-31	T521D336M035A(1)E065	115.5	10	65	1900.0	3	125
35	47	X/7343-43	T521X476M035A(1)E030	164.5	10	30	2900.0	3	125
35	47	X/7343-43	T521X476M035A(1)E070	164.5	10	70	1900.0	3	125
50	6.8	D/7343-31	T521D685M050A(1)E070	34.0	10	70	1800.0	3	125
50	6.8	D/7343-31	T521D685M050A(1)E090	34.0	10	90	1600.0	3	125
50	10	D/7343-31	T521D106M050A(1)E090	50.0	10	90	1600.0	3	125
50	10	D/7343-31	T521D106M050A(1)E120	50.0	10	120	1369.0	3	125
50	18	X/7343-43	T521X186M050A(1)E070	90.0	10	70	1900.0	3	125
63	4.7	D/7343-31	T521D475M063A(1)E300	29.6	10	300	900.0	3	125
63	4.7	D/7343-31	T521D475M063A(1)E075	29.6	10	75	1700.0	3	125
63	10	X/7343-43	T521X106M063A(1)E050	35.0	10	50	2200.0	3	125
63	15	X/7343-43	T521X156M063A(1)E035	52.5	10	35	2600.0	3	125
63	15	X/7343-43	T521X156M063A(1)E150	94.5	10	150	1300.0	3	125
VDC	µF	KEMET/EIA	(See below for part options)	µA @ 20°C Max/5 Min	%@ 20°C 120 Hz Max	mΩ @ 20°C 100 kHz Max	(mA) +45°C 100 kHz	Temp ≤ 260°C	(°C)
Rated Voltage	Rated Cap	Case Code/ Case Size	KEMET Part Number	DC Leakage	DF	ESR	Maximum Allowable Ripple Current	Moisture Sensitivity	Rated Temp

Other part number options:

1- Standard with tin terminations (14th character = T). Tin/lead terminations is also available (14th character = H).

Also available on large (13 inch) reels. Add 7280 to the end of the part number.

Higher voltage ratings and tighter tolerance product including ESR may be substituted within the same size at KEMET's option. Voltage substitutions will be marked with the higher voltage rating. Substitutions can include better than series.

*Under development

Derating Guidelines

Voltage Rating	Maximum Recommended Steady State Voltage	Maximum Recommended Transient Voltage (1 ms – 1 μs)
-55°C to 105°C		
16 V ≤ V _R ≤ 63 V	80% of V _R	V _R
105°C to 125°C		
16 V ≤ V _R ≤ 63 V	54% of V _R	67% of V _R

V_R = Rated Voltage

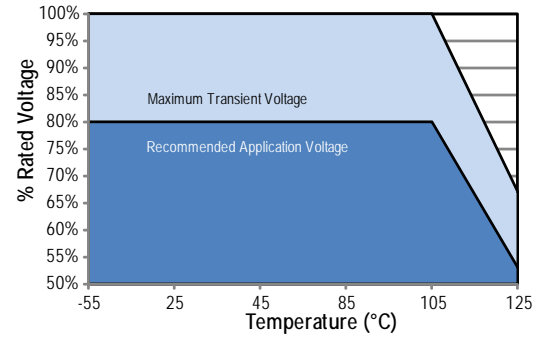

Ripple Current/Ripple Voltage

Permissible AC ripple voltage and current are related to equivalent series resistance (ESR) and the power dissipation capabilities of the device. Permissible AC ripple voltage which may be applied is limited by two criteria:

1. The positive peak AC voltage plus the DC bias voltage, if any, must not exceed the DC voltage rating of the capacitor.
2. The negative peak AC voltage in combination with bias voltage, if any, must not exceed the allowable limits specified for reverse voltage. See the Reverse Voltage section for allowable limits.

The maximum power dissipation by case size can be determined using the table at right. The maximum power dissipation rating stated in the table must be reduced with increasing environmental operating temperatures. Refer to the table below for temperature compensation requirements.

Temperature Compensation Multipliers for Maximum Power Dissipation		
≤ 45°C	45° C < T ≤ 85°C	85°C < T ≤ 125°C
1.00	0.70	0.25

T = Environmental Temperature

Using the P max of the device, the maximum allowable rms ripple current or voltage may be determined.

$$I(max) = \sqrt{P_{max}/R}$$

$$E(max) = \sqrt{P_{max} \cdot R}$$

I = rms ripple current (amperes)

E = rms ripple voltage (volts)

P max = maximum power dissipation (watts)

R = ESR at specified frequency (ohms)

Case Code	EIA Case Code	Maximum Power Dissipation (P max) mWatts @ 45°C with +30°C Rise
T	3528-12	105
M	3528-15	120
A	3216-18	112
B	3528-21	127
U	6032-15	135
L	3528-19	150
C	6032-28	165
W	7343-15	180
V	7343-20	187
D	7343-31	225
Y	7343-40	241
X	7343-43	247
H	7360-20	187
I	3216-10	95

The maximum power dissipation rating must be reduced with increasing environmental operating temperatures. Refer to the Temperature Compensation Multiplier table for details.

Reverse Voltage

Polymer tantalum capacitors are polar devices and may be permanently damaged or destroyed if connected in the wrong polarity. These devices will withstand a small degree of transient voltage reversal for short periods as shown in the below table.

Temperature	Permissible Transient Reverse Voltage
25°C	15% of Rated Voltage
55°C	10% of Rated Voltage
85°C	5% of Rated Voltage
105°C	3% of Rated Voltage
125°C*	1% of Rated Voltage

*For series rated to 125°C

Table 2 – Land Dimensions/Courtyard

KEMET	Metric Size Code	Density Level A: Maximum (Most) Land Protrusion (mm)					Density Level B: Median (Nominal) Land Protrusion (mm)					Density Level C: Minimum (Least) Land Protrusion (mm)				
		X	Y	C	V1	V2	X	Y	C	V1	V2	X	Y	C	V1	V2
D	7343-31	2.55	3.75	2.70	10.20	5.50	2.45	3.35	2.60	9.10	5.00	2.35	2.95	2.50	8.20	4.70
V	7343-20	2.55	3.75	2.70	10.20	5.50	2.45	3.35	2.60	9.10	5.00	2.35	2.95	2.50	8.20	4.70
W	7343-15	2.55	3.75	2.70	10.20	5.50	2.45	3.35	2.60	9.10	5.00	2.35	2.95	2.50	8.20	4.70
X ¹	7343-43	2.55	3.75	2.70	10.20	5.50	2.45	3.35	2.60	9.10	5.00	2.35	2.95	2.50	8.20	4.70

Density Level A: For low-density product applications. Recommended for wave solder applications and provides a wider process window for reflow solder processes.

Density Level B: For products with a moderate level of component density. Provides a robust solder attachment condition for reflow solder processes.

Density Level C: For high component density product applications. Before adapting the minimum land pattern variations the user should perform qualification testing based on the conditions outlined in IPC Standard 7351 (IPC-7351).

¹ Height of these chips may create problems in wave soldering.

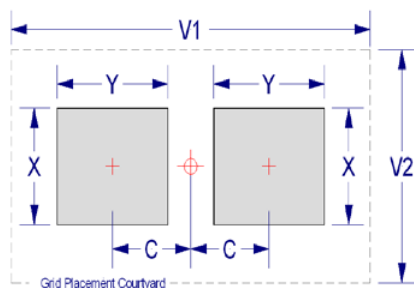

Soldering Process

KEMET’s families of surface mount capacitors are compatible with wave (single or dual), convection, IR, or vapor phase reflow techniques. Preheating of these components is recommended to avoid extreme thermal stress. KEMET’s recommended profile conditions for convection and IR reflow reflect the profile conditions of the IPC/J–STD–020D standard for moisture sensitivity testing. The devices can safely withstand a maximum of three reflow passes at these conditions.

Please note that although the X/7343–43 case size can withstand wave soldering, the tall profile (4.3 mm maximum) dictates care in wave process development.

Hand soldering should be performed with care due to the difficulty in process control. If performed, care should be taken to avoid contact of the soldering iron to the molded case. The iron should be used to heat the solder pad, applying solder between the pad and the termination, until reflow occurs. Once reflow occurs, the iron should be removed immediately. “Wiping” the edges of a chip and heating the top surface is not recommended.

During typical reflow operations, a slight darkening of the gold-colored epoxy may be observed. This slight darkening is normal and not harmful to the product. Marking permanency is not affected by this change.

Profile Feature	SnPb Assembly	Pb-Free Assembly
Preheat/Soak		
Temperature Minimum (T_{smin})	100°C	150°C
Temperature Maximum (T_{smax})	150°C	200°C
Time (t_s) from T_{smin} to T_{smax}	60 – 120 seconds	60 – 120 seconds
Ramp-up Rate (T_L to T_p)	3°C/seconds maximum	3°C/seconds maximum
Liquidous Temperature (T_L)	183°C	217°C
Time Above Liquidous (t_L)	60 – 150 seconds	60 – 150 seconds
Peak Temperature (T_p)	220°C* 235°C**	250°C* 260°C**
Time within 5°C of Maximum Peak Temperature (t_p)	20 seconds maximum	30 seconds maximum
Ramp-down Rate (T_p to T_L)	6°C/seconds maximum	6°C/seconds maximum
Time 25°C to Peak Temperature	6 minutes maximum	8 minutes maximum

Note: All temperatures refer to the center of the package, measured on the package body surface that is facing up during assembly reflow.

*Case Size D, E, P, Y, and X

**Case Size A, B, C, H, I, K, M, R, S, T, U, V, W, and Z

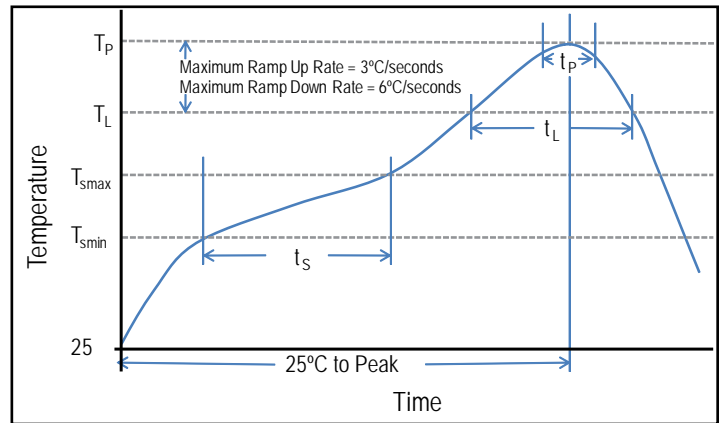

Construction



Capacitor Marking

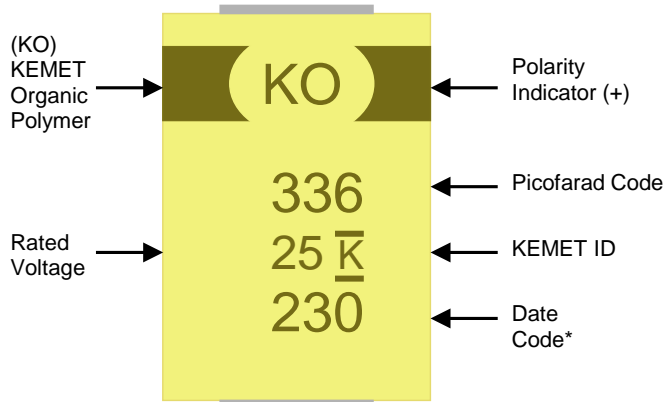

* 230 = 30th week of 2012

Date Code *	
1 st digit = Last number of Year	9 = 2009 0 = 2010 1 = 2011 2 = 2012 3 = 2013 4 = 2014
2 nd and 3 rd digit = Week of the Year	01 = 1 st week of the Year to 52 = 52 nd week of the Year

Storage

All KO-CAP series are shipped in moisture barrier bags with a desiccant and moisture indicator card. These series are classified as MSL3 (Moisture Sensitivity Level 3). Product contained within the moisture barrier bags should be stored in normal working environments with temperatures not to exceed 40°C and humidity not in excess of 60% RH.

Overview

The KEMET Organic Capacitor (KO-CAP) is a tantalum capacitor with a Ta anode and Ta₂O₅ dielectric. A conductive organic polymer replaces the traditionally used MnO₂ as the cathode plate of the capacitor. This results in very low ESR and improved capacitance retention at high frequency. The KO-CAP also exhibits a benign failure mode which eliminates the ignition failures that can occur in standard MnO₂ tantalum types. KO-CAPs may also be operated at steady state voltages up to

90% of rated voltage for part types with rated voltages of ≤ 10.

The T522 Reduced Leakage Polymer Tantalum Series is designed to meet the needs of leakage-sensitive applications such as battery supported circuits. The T522 Series offers the lowest leakage values available in polymer tantalum capacitors with upper leakage limits that are up to 70% lower than other polymer series.

Benefits

- ESR: 25 to 40 mΩ
- -55°C to 105°C operating temperature range
- Polymer cathode technology
- High frequency capacitance retention
- Non-ignition failure mode
- Capacitance: 150 to 470 μF
- Voltage: 6.3 V
- 100% accelerated steady state aging
- 100% surge current tested
- Low profile designs
- Volumetric efficiency
- Self-healing mechanism
- EIA standard case sizes

Applications

Typical applications include battery-dependent applications such as handheld consumer electronics, global tracking systems, energy harvesting, wireless sensors and other applications that seek high capacitance, low profile, safety and low power consumption.



Environmental Compliance

RoHS Compliant (6/6) according to Directive 2002/95/EC when ordered with 100% Sn solder.



RoHS Compliant

SPICE

For a detailed analysis of specific part numbers, please visit www.kemet.com for a free download of KEMET's SPICE software. The KEMET SPICE program is freeware intended to aid design engineers in analyzing the performance of these capacitors over frequency, temperature, ripple, and DC bias conditions.

Ordering Information

T	522	V	157	M	006	A	T	E025	
Capacitor Class	Series	Case Size	Capacitance Code (pF)	Capacitance Tolerance	Voltage	Failure Rate/Design	Lead Material	ESR Code	Packaging (C-Spec)
T = Tantalum	520 = Reduced Leakage Polymer	V, Y	First two digits represent significant figures. Third digit specifies number of zeros.	M = ±20%	006 = 6.3 V	A = N/A	T = 100% Matte Tin (Sn) Plated H = Tin/Lead (SnPb) Solder Coated (5% Pb minimum)	E = ESR Last three digits specify ESR in mΩ. (025 = 25 mΩ)	Blank = 7" Reel 7280 = 13" Reel

Performance Characteristics

Item	Performance Characteristics
Operating Temperature	-55°C to 105°C
Rated Capacitance Range	150 – 470 uF @ 120 Hz/25°C
Capacitance Tolerance	M Tolerance (20%)
Rated Voltage Range	6.3 V
DF (120 Hz)	≤ 10%
ESR (100 kHz)	Refer to Part Number Electrical Specification Table 1
Leakage Current	≤ 0.03 CV (μA) at rated voltage after 10 minutes

Qualification

Test	Condition	Characteristics				
Endurance	105°C @ rated voltage, 2,000 hours	Δ C/C	Within -20/+10% of initial value			
		DF	Within initial limits			
		DCL	Within 1.5 x initial limit			
		ESR	Within 2.0 x initial limit			
Storage Life	105°C @ 0 volts, 2,000 hours	Δ C/C	Within -20/+10% of initial value			
		DF	Within initial limits			
		DCL	Within 1.5 x initial limit			
		ESR	Within 2.0 x initial limit			
Humidity	60° C, 90% RH, 500 hours, rated voltage	Δ C/C	Within -5%/+35% of initial value			
		DF	Within initial limits			
		DCL	Within 5.0 x initial limit			
		ESR	Within 2.0 x initial limit			
Temperature Stability	Extreme temperature exposure at a succession of continuous steps at +25°C, -55°C, +25°C, +85°C, +105°/125°C, +25°C	+25°C	-55°C	+85°C	+105°C	
		Δ C/C	IL*	±20%	±20%	±30%
		DF	IL	IL	1.2 x IL	1.5 x IL
		DCL	IL	n/a	10 x IL	10 x IL
Surge Voltage	105°C, 1.32 x rated voltage, 33 Ω Resistance, 1,000 cycles	Δ C/C	Within -20%/+10% of initial value			
		DF	Within initial limits			
		DCL	Within initial limits			
		ESR	Within initial limits			
Mechanical Shock/Vibration	MIL-STD-202, Method 213, Condition I, 100 G peak. MIL-STD-202, Method 204, Condition D, 10 Hz to 2,000 Hz, 20 G peak	Δ C/C	Within ±10% of initial value			
		DF	Within initial limits			
		DCL	Within initial limits			

*IL = Initial limit

Electrical Characteristics

Impedance & ESR vs. Frequency



Capacitance vs. Frequency



Dimensions – Millimeters (Inches)

Metric will govern



Case Size		Component												
KEMET	EIA	L*	W*	H*	F* ± 0.1 ± (.004)	S* ± 0.3 ± (.012)	B* ± 0.15 (Ref) ± .006	X (Ref)	P (Ref)	R (Ref)	T (Ref)	A (Min)	G (Ref)	E (Ref)
V	7343-19	7.3 ± 0.3 (0.287 ± 0.012)	4.3 ± 0.3 (0.169 ± 0.012)	1.9 (.075)	2.4 (.094)	1.3 (.051)	n/a	0.05 (.002)	n/a	n/a	0.13 (.005)	3.8 (.150)	3.5 (.138)	3.5 (.138)
Y	7343-40	7.3 ± 0.3 (0.287 ± 0.012)	4.3 ± 0.3 (0.169 ± 0.012)	4.0 (.157) maximum	2.4 (.094)	1.3 (.051)	0.5 (.020)	0.10 ± 0.10 (.004 ± .004)	1.7 (.067)	1.0 (.039)	0.13 (.005)	3.8 (.150)	3.5 (.138)	3.5 (.138)

Notes: (Ref) – Dimensions provided for reference only. No dimensions are provided for B, P or R because low profile cases do not have a bevel or a notch.

* MIL-REF-55365/8 specified dimensions

Table 1 – Ratings & Part Number Reference

Rated Voltage	Rated Cap	Case Code/ Case Size	KEMET Part Number	DC Leakage	DF	ESR	Maximum Allowable Ripple Current	Moisture Sensitivity	Rated Temp
VDC	μF	KEMET/EIA	(See below for part options)	μA @ +20°C Max/10 Min.	% @ +20°C 120 Hz Max	mΩ @ +20°C 100 kHz Max	(mA) +45°C 100 kHz	Temperature ≤ 260°C	(°C)
6.3	150	V/7343-19	T522V157M006A(1)E025	28	10	25	2700	3	105
6.3	150	V/7343-19	T522V157M006A(1)E040	28	10	40	2200	3	105
6.3	220	V/7343-19	T522V227M006A(1)E025	42	10	25	2700	3	105
6.3	220	V/7343-19	T522V227M006A(1)E040	42	10	40	2200	3	105
6.3	330	V/7343-19	T522V337M006A(1)E040	62	10	40	2200	3	105
6.3	470	Y/7343-40	T522Y477M006A(1)E035	89	10	35	2600	3	105
VDC	μF	KEMET/EIA	(See below for part options)	μA @ +20°C Max/10 Min.	% @ +20°C 120 Hz Max	mΩ @ +20°C 100 kHz Max	(mA) +45°C 100 kHz	Temperature ≤ 260°C	(°C)
Rated Voltage	Rated Cap	Case Code/ Case Size	KEMET Part Number	DC Leakage	DF	ESR	Maximum Allowable Ripple Current	Moisture Sensitivity	Rated Temp

Other part number options:

(1) Standard with tin terminations (14th character = T). Tin/lead terminations is also available (14th character = H).

Also available on large (13 inch) reels. Add 7280 to the end of the part number.

Higher voltage ratings and tighter tolerance product including ESR may be substituted within the same size at KEMET's option. Voltage substitutions will be marked with the higher voltage rating. Substitutions can include better than series.

Derating Guidelines

Voltage Rating	Maximum Recommended Steady State Voltage	Maximum Recommended Transient Voltage (1 ms – 1 μs)
-55°C to 105°C		
6.3 V	90% of V_R	V_R

V_R = Rated Voltage



Ripple Current/Ripple Voltage

Permissible AC ripple voltage and current are related to equivalent series resistance (ESR) and the power dissipation capabilities of the device. Permissible AC ripple voltage which may be applied is limited by two criteria:

1. The positive peak AC voltage plus the DC bias voltage, if any, must not exceed the DC voltage rating of the capacitor.
2. The negative peak AC voltage in combination with bias voltage, if any, must not exceed the allowable limits specified for reverse voltage. See the Reverse Voltage section for allowable limits.

The maximum power dissipation by case size can be determined using the table at right. The maximum power dissipation rating stated in the table must be reduced with increasing environmental operating temperatures. Refer to the table below for temperature compensation requirements.

KEMET Series and Case Code	EIA Case Code	Maximum Power Dissipation (P max) mWatts @ 45°C with +30°C Rise
T520T	3528-12	105
T520M	3528-15	120
T520A	3216-18	112
T520B	3528-21	127
T520U	6032-15	135
T520L	3528-19	150
T520C	6032-28	165
T520W	7343-15	180
T520V / T522V	7343-19	187
T520D	7343-31	225
T520Y/T522Y	7343-40	241
T520X	7343-43	247
T520H	7360-20	187

The maximum power dissipation rating must be reduced with increasing environmental operating temperatures. Refer to the Temperature Compensation Multiplier table for details.

Temperature Compensation Multipliers for Maximum Power Dissipation		
≤ 45°C	45° C < T ≤ 85°C	85°C < T ≤ 125°C
1.00	0.70	0.25

T = Environmental Temperature

Using the P max of the device, the maximum allowable rms ripple current or voltage may be determined.

$$I(max) = \sqrt{P_{max}/R}$$

$$E(max) = \sqrt{P_{max} \cdot R}$$

I = rms ripple current (amperes)

E = rms ripple voltage (volts)

Reverse Voltage

Polymer tantalum capacitors are polar devices and may be permanently damaged or destroyed if connected in the wrong polarity. These devices will withstand a small degree of transient voltage reversal for short periods as shown in the below table.

Temperature	Permissible Transient Reverse Voltage
25°C	15% of Rated Voltage
55°C	10% of Rated Voltage
85°C	5% of Rated Voltage
105°C	3% of Rated Voltage
125°C*	1% of Rated Voltage

*For series rated to 125°C

Table 2 – Land Dimensions/Courtyard

KEMET	Metric Size Code	Density Level A: Maximum (Most) Land Protrusion (mm)					Density Level B: Median (Nominal) Land Protrusion (mm)					Density Level C: Minimum (Least) Land Protrusion (mm)				
		X	Y	C	V1	V2	X	Y	C	V1	V2	X	Y	C	V1	V2
V	7343-19	2.55	3.75	2.70	10.20	5.50	2.45	3.35	2.60	9.10	5.00	2.35	2.95	2.50	8.20	4.70
Y ¹	7343-40	2.55	3.75	2.70	10.20	5.50	2.45	3.35	2.60	9.10	5.00	2.35	2.95	2.50	8.20	4.70

Density Level A: For low-density product applications. Recommended for wave solder applications and provides a wider process window for reflow solder processes.

Density Level B: For products with a moderate level of component density. Provides a robust solder attachment condition for reflow solder processes.

Density Level C: For high component density product applications. Before adapting the minimum land pattern variations the user should perform qualification testing based on the conditions outlined in IPC Standard 7351 (IPC-7351).

¹ Height of these chips may create problems in wave soldering.



Soldering Process

KEMET's families of surface mount capacitors are compatible with wave (single or dual), convection, IR, or vapor phase reflow techniques. Preheating of these components is recommended to avoid extreme thermal stress. KEMET's recommended profile conditions for convection and IR reflow reflect the profile conditions of the IPC/J-STD-020D standard for moisture sensitivity testing. The devices can safely withstand a maximum of three reflow passes at these conditions.

Please note that although the X/7343-43 case size can withstand wave soldering, the tall profile (4.3 mm maximum) dictates care in wave process development.

Hand soldering should be performed with care due to the difficulty in process control. If performed, care should be taken to avoid contact of the soldering iron to the molded case. The iron should be used to heat the solder pad, applying solder between the pad and the termination, until reflow occurs. Once reflow occurs, the iron should be removed immediately. "Wiping" the edges of a chip and heating the top surface is not recommended.

During typical reflow operations, a slight darkening of the gold-colored epoxy may be observed. This slight darkening is normal and not harmful to the product. Marking permanency is not affected by this change.

Profile Feature	SnPb Assembly	Pb-Free Assembly
Preheat/Soak		
Temperature Minimum (T_{Smin})	100°C	150°C
Temperature Maximum (T_{Smax})	150°C	200°C
Time (t_s) from T_{Smin} to T_{Smax}	60 – 120 seconds	60 – 120 seconds
Ramp-up Rate (T_L to T_p)	3°C/seconds maximum	3°C/seconds maximum
Liquidous Temperature (T_L)	183°C	217°C
Time Above Liquidous (t_L)	60 – 150 seconds	60 – 150 seconds
Peak Temperature (T_p)	220°C* 235°C**	250°C* 260°C**
Time within 5°C of Maximum Peak Temperature (t_p)	20 seconds maximum	30 seconds maximum
Ramp-down Rate (T_p to T_L)	6°C/seconds maximum	6°C/seconds maximum
Time 25°C to Peak Temperature	6 minutes maximum	8 minutes maximum

Note: All temperatures refer to the center of the package, measured on the package body surface that is facing up during assembly reflow.

*Case Size D, E, P, Y and X

**Case Size A, B, C, H, I, K, M, R, S, T, U, V, W and Z

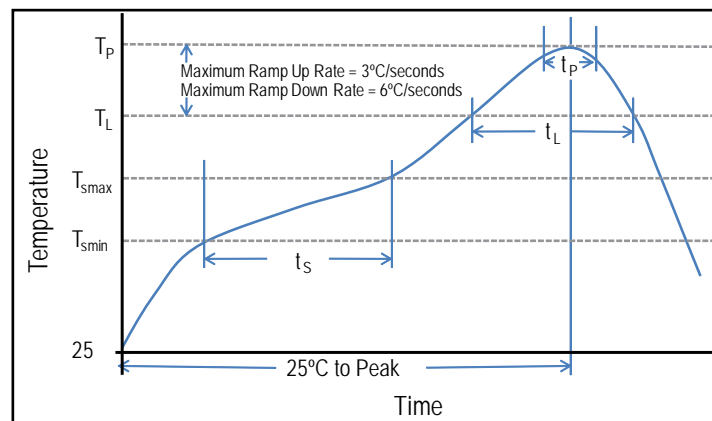

Construction

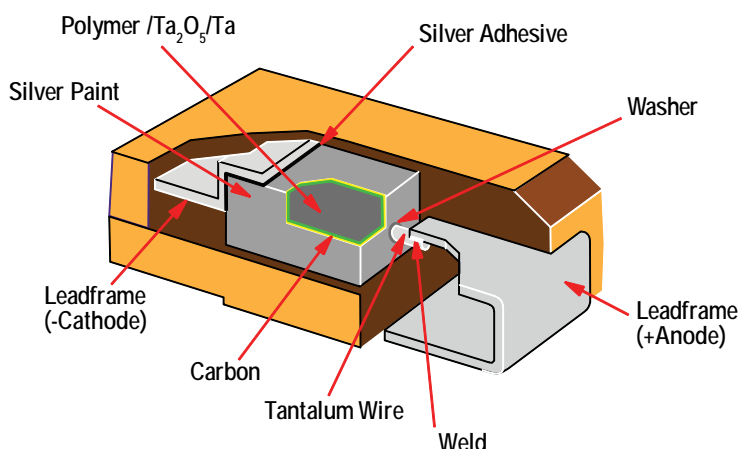

Capacitor Marking



* 242 = 42nd week of 2012

Date Code *	
1 st digit = Last number of Year	9 = 2009 0 = 2010 1 = 2011 2 = 2012 3 = 2013 4 = 2014
2 nd and 3 rd digit = Week of the Year	01 = 1 st week of the Year to 52 = 52 nd week of the Year

Storage

All KO-CAP Series are shipped in moisture barrier bags with a desiccant and moisture indicator card. This series is classified as MSL3 (Moisture Sensitivity Level 3). Product contained within the moisture barrier bags should be stored in normal working environments with temperatures not to exceed 40°C and humidity not in excess of 60% RH.

Overview

The KEMET Organic Capacitor (KO-CAP) is a tantalum capacitor with a Ta anode and Ta₂O₅ dielectric. A conductive organic polymer replaces the traditionally used MnO₂ as the cathode plate of the capacitor. This results in very low ESR and improved capacitance retention at high frequency. The KO-CAP also exhibits a benign failure mode which eliminates the ignition failures that can occur in standard MnO₂ tantalum types. KO-CAPs may also be operated at steady state voltages up to 90% of rated voltage for part types with rated voltages of

≤ 10 volts and up to 80% of rated voltage for part types > 10 volts with equivalent or better reliability than traditional MnO₂ tantalum capacitors operated at 50% of rated voltage. The T525 Series KO-CAP Low ESR Polymer is KEMET's 125°C rated tantalum polymer capacitor. This part offers the same advantages as the T520 Series such as low ESR, high frequency capacitance retention and a benign failure mode. The T525 Series is often the series of choice when considering automotive or industrial type applications.

Benefits

- Polymer cathode technology
- 125°C maximum operating temperature
- High frequency capacitance retention
- Non-ignition failure mode
- Capacitance: 33 µF to 680 µF
- Voltage: 2.5 V to 16 V
- Use up to 90% of rated voltage (10% derating) for part types ≤ 10 V
- Use up to 80% of rated voltage (20% derating) for part types > 10 V
- 100% surge current tested
- Self-healing mechanism
- Volumetrically efficient
- EIA standard case sizes
- RoHS Compliant and Halogen Free

Applications

Typical applications include automotive, industrial and military as per DSCC 04051.



Environmental Compliance

RoHS Compliant (6/6) according to Directive 2002/95/EC when ordered with 100% Sn solder.



RoHS Compliant

SPICE

For a detailed analysis of specific part numbers, please visit www.kemet.com for a free download of KEMET's SPICE software. The KEMET SPICE program is freeware intended to aid design engineers in analyzing the performance of these capacitors over frequency, temperature, ripple, and DC bias conditions.

Ordering Information

T	525	D	337	M	006	A	T	E800	
Capacitor Class	Series	Case Size	Capacitance Code (pF)	Capacitance Tolerance	Voltage	Failure Rate/Design	Lead Material	ESR	Packaging (C-Spec)
T = Tantalum	525 = 125°C Rated Polymer	B, D, T, V, Y	First two digits represent significant figures. Third digit specifies number of zeros.	M = ±20%	2R5 = 2.5 V 003 = 3 V 004 = 4 V 006 = 6.3 V 010 = 10 V 016 = 16 V	A = N/A	T = 100% Matte Tin (Sn) Plated H = Tin/Lead (SnPb) Solder Coated (5% Pb minimum)	Last three digits specify ESR in mΩ. (800 = 800 mΩ)	Blank = 7" Reel 7280 = 13" Reel

Performance Characteristics

Item	Performance Characteristics
Operating Temperature	-55°C to 125°C
Rated Capacitance Range	22 – 680 μF @ 120 Hz/25°C
Capacitance Tolerance	M Tolerance (20%)
Rated Voltage Range	2.5 – 16 V
DF (120 Hz)	≤ 10%
ESR (100 kHz)	Refer to Part Number Electrical Specification Table
Leakage Current	≤ 0.1 CV (μA) at rated voltage after 5 minutes

Qualification

Test	Condition	Characteristics				
Endurance	125°C @ 2/3 rated voltage, 2,000 hours	Δ C/C	Within -20%/+10% of initial value			
		DF	≤ Initial Limit			
		DCL	2 x IL @ 125°C			
		ESR	2 x Initial Limit			
Storage Life	125°C @ 0 volts, 2,000 hours	Δ C/C	Within -20%/+10% of initial value			
		DF	Within initial limits			
		DCL	Within 2.0 x initial limit			
		ESR	Within initial limit			
Humidity	60°C, 90% RH, 1,000 hours, No Load	Δ C/C	Within -5%/+35% of initial value			
		DF	≤ Initial Limit			
		DCL	Within 3.0 x initial limit			
Temperature Stability	Extreme temperature exposure at a succession of continuous steps at +25°C, -55°C, +25°C, +85°C, +125°C, +25°C		+25°C	-55°C	+85°C	+125°C
		Δ C/C	IL*	±20%	±20%	±30%
		DF	IL	IL	1.2 x IL	1.5 x IL
		DCL	IL	n/a	10 x IL	10 x IL
Surge Voltage	105°C, 1.32 x rated voltage, 33 Ω Resistance, 1,000 cycles	Δ C/C	Within -20%/+10% of initial value			
		DF	Within initial limits			
		DCL	Within initial limits			
		ESR	Within initial limits			
Mechanical Shock/Vibration	MIL-STD-202, Method 213, Condition I, 100 G peak. MIL-STD-202, Method 204, Condition D, 10 Hz to 2,000 Hz, 20 G peak	Δ C/C	Within ±10% of initial value			
		DF	Within initial limits			
		DCL	Within initial limits			

*IL = Initial Limit

Electrical Characteristics

ESR vs. Frequency



Capacitance vs. Frequency



Dimensions – Millimeters (Inches)

Metric will govern



Case Size		Component												
KEMET	EIA	L*	W*	H*	F* ±0.1 ±(.004)	S* ±0.3 ±(.012)	B* ±0.15 (Ref) ±.006	X (Ref)	P (Ref)	R (Ref)	T (Ref)	A (Min)	G (Ref)	E (Ref)
B	3528-21	3.5 ±0.2 (0.138 ±0.008)	2.8 ±0.2 (0.110 ±0.008)	1.9 ±0.2 (0.075 ±0.008)	2.2 (.087)	0.8 (.031)	0.4 (.016)	0.10 ± 0.10 (.004 ± .004)	0.5 (.020)	1.0 (.039)	0.13 (.005)	1.1 (.043)	1.8 (.071)	2.2 (.087)
D	7343-31	7.3 ±0.3 (0.287 ±0.012)	4.3 ±0.3 (0.169 ±0.012)	2.8 ±0.3 (0.110 ±0.012)	2.4 (.094)	1.3 (.051)	0.5 (.020)	0.10 ± 0.10 (.004 ± .004)	0.9 (.035)	1.0 (.039)	0.13 (.005)	3.8 (.150)	3.5 (.138)	3.5 (.138)
T	3528-12	3.5 ±0.2 (0.138 ±0.008)	2.8 ±0.2 (0.110 ±0.008)	1.2 (.047)	2.2 (.087)	0.8 (.031)	n/a	0.05 (.002)	n/a	n/a	0.13 (.005)	1.1 (.043)	1.8 (.071)	2.2 (.087)
V	7343-20	7.3 ±0.3 (0.287 ±0.012)	4.3 ±0.3 (.169 ± .012)	2.0 Maximum	2.4 (.094)	1.3 (.051)	n/a	0.05 (.002)	n/a	n/a	0.13 (.005)	3.8 (.150)	3.5 (.138)	3.5 (.138)
Y	7343-40	7.3 ±0.3 (0.287 ±0.012)	4.3 ±0.3 (0.169 ±0.012)	4.0 (.157)	2.4 (.094)	1.3 (.051)	0.5 (.020)	0.10 ± 0.10 (.004 ± .004)	1.7 (.067)	1.0 (.039)	0.13 (.005)	3.8 (.150)	3.5 (.138)	3.5 (.138)

Notes: (Ref) – Dimensions provided for reference only. No dimensions are provided for B, P or R because low profile cases do not have a bevel or a notch.

* MIL-PRF-55365/8 specified dimensions

Table 1 – Ratings & Part Number Reference

Rated Voltage	Rated Cap	Case Code/ Case Size	KEMET Part Number	DC Leakage	DF	ESR	Maximum Allowable Ripple Current	Moisture Sensitivity	Rated Temp
VDC	µF	KEMET/EIA	(See below for part options)	µA @ +20°C Max/5 Min	% @ +20°C 120 Hz Max	mΩ @ +20°C 100 kHz Max	(mA) 100 kHz +45°C	Temp ≤ 260°C	(°C)
2.5	100	T/3528-12	T525T107M2R5A(1)E080	25.0	10	80	1100.0	3	125
2.5	330	D/7343-31	T525D337M2R5A(1)E025	82.5	10	25	3000.0	3	125
2.5	470	D/7343-31	T525D477M2R5A(1)E025	117.5	10	25	3000.0	3	125
2.5	680	D/7343-31	T525D687M2R5A(1)E025	170.0	10	25	3000.0	3	125
3	100	B/3528-21	T525B107M003A(1)E080	30.0	8	80	1300.0	3	125
3	150	B/3528-21	T525B157M003A(1)E080	45.0	8	80	1300.0	3	125
3	330	D/7343-31	T525D337M003A(1)E025	99.0	10	25	3000.0	3	125
3	470	D/7343-31	T525D477M003A(1)E025	141.0	10	25	3000.0	3	125
3	680	D/7343-31	T525D687M003A(1)E025	204.0	10	25	3000.0	3	125
4	68	T/3528-12	T525T686M004A(1)E080	27.2	8	80	1100.0	3	125
4	68	B/3528-21	T525B686M004A(1)E080	27.2	8	80	1300.0	3	125
4	100	B/3528-21	T525B107M004A(1)E080	40.0	8	80	1300.0	3	125
4	220	D/7343-31	T525D227M004A(1)E025	88.0	10	25	3000.0	3	125
4	330	D/7343-31	T525D337M004A(1)E025	132.0	10	25	3000.0	3	125
4	470	D/7343-31	T525D477M004A(1)E025	188.0	10	25	3000.0	3	125
4	470	D/7343-31	T525D477M004A(1)E040	188.0	10	40	2400.0	3	125
6.3	33	B/3528-21	T525B336M006A(1)E080	20.8	8	80	1300.0	3	125
6.3	47	T/3528-12	T525T476M006A(1)E080	29.6	8	80	1100.0	3	125
6.3	47	B/3528-21	T525B476M006A(1)E070	29.6	8	70	1300.0	3	125
6.3	47	B/3528-21	T525B476M006A(1)E080	29.6	8	80	1300.0	3	125
6.3	68	B/3528-21	T525B686M006A(1)E080	42.8	8	80	1300.0	3	125
6.3	150	D/7343-31	T525D157M006A(1)E025	94.5	10	25	3000.0	3	125
6.3	220	D/7343-31	T525D227M006A(1)E025	138.6	10	25	3000.0	3	125
6.3	330	D/7343-31	T525D337M006A(1)E025	207.9	10	25	3000.0	3	125
6.3	330	D/7343-31	T525D337M006A(1)E040	207.9	10	40	2400.0	3	125
6.3	470	Y/7343-40	T525Y477M006A(1)E035	296.1	10	35	2600.0	3	125
8	33	T/3528-12	T525T336M008A(1)E080	26.4	8	80	1100.0	3	125
10	22	B/3528-21	T525B226M010A(1)E080	22.0	8	80	1300.0	3	125
10	33	T/3528-12	T525T336M010A(1)E080	33.0	8	80	1100.0	3	125
10	33	B/3528-21	T525B336M010A(1)E080	33.0	8	80	1300.0	3	125
10	100	D/7343-31	T525D107M010A(1)E025	100.0	10	25	3000.0	3	125
10	100	D/7343-31	T525D107M010A(1)E055	100.0	10	55	2000.0	3	125
10	150	D/7343-31	T525D157M010A(1)E025	150.0	10	25	3000.0	3	125
10	150	D/7343-31	T525D157M010A(1)E055	150.0	10	55	2000.0	3	125
10	220	D/7343-31	T525D227M010A(1)E025	220.0	10	25	3000.0	3	125
10	330	Y/7343-40	T525Y337M010A(1)E035	330.0	10	35	2600.0	3	125
16	47	D/7343-31	T525D476M016A(1)E035	75.2	10	35	2500.0	3	125
16	47	D/7343-31	T525D476M016A(1)E065	75.2	10	65	1900.0	3	125
VDC	µF	KEMET/EIA	(See below for part options)	µA @ +20°C Max/5 Min	% @ +20°C 120 Hz Max	mΩ @ +20°C 100 kHz Max	(mA) 100 kHz +45°C	Temp ≤ 260°C	(°C)
Rated Voltage	Rated Cap	Case Code/ Case Size	KEMET Part Number	DC Leakage	DF	ESR	Maximum Allowable Ripple Current	Moisture Sensitivity	Rated Temp

Other part number options:

(1) Standard with tin terminations (14th character = T). Tin/lead terminations is also available (14th character = H).

Also available on large (13 inch) reels. Add 7280 to the end of the part number.

Higher voltage ratings and tighter tolerance product including ESR may be substituted within the same size at KEMET's option. Voltage substitutions will be marked with the higher voltage rating. Substitutions can include better than series.

Derating Guidelines

Voltage Rating	Maximum Recommended Steady State Voltage	Maximum Recommended Transient Voltage (1ms – 1µs)
-55°C to 105°C		
$2.5 V \leq V_R \leq 10 V$	90% of V_R	V_R
$12.5 V \leq V_R \leq 16 V$	80% of V_R	V_R
105°C to 125°C		
$2.5 V \leq V_R \leq 10 V$	60% of V_R	67% of V_R
$12.5 V \leq V_R \leq 16 V$	54% of V_R	67% of V_R

V_R = Rated Voltage



Ripple Current/Ripple Voltage

Permissible AC ripple voltage and current are related to equivalent series resistance (ESR) and the power dissipation capabilities of the device. Permissible AC ripple voltage which may be applied is limited by two criteria:

1. The positive peak AC voltage plus the DC bias voltage, if any, must not exceed the DC voltage rating of the capacitor.
2. The negative peak AC voltage in combination with bias voltage, if any, must not exceed the allowable limits specified for reverse voltage. See the Reverse Voltage section for allowable limits.

The maximum power dissipation by case size can be determined using the table at right. The maximum power dissipation rating stated in the table must be reduced with increasing environmental operating temperatures. Refer to the table below for temperature compensation requirements.

Temperature Compensation Multipliers for Maximum Power Dissipation		
$\leq 45^\circ C$	$45^\circ C < T \leq 85^\circ C$	$85^\circ C < T \leq 125^\circ C$
1.00	0.70	0.25

T = Environmental Temperature

Case Code	EIA Case Code	Maximum Power Dissipation (P max) mWatts @ 45°C with +30°C Rise
T	3528-12	105
M	3528-15	120
A	3216-18	112
B	3528-21	127
U	6032-15	135
L	3528-19	150
C	6032-28	165
W	7343-15	180
V	7343-20	187
D	7343-31	225
Y	7343-40	241
X	7343-43	247
H	7360-20	187
I	3216-10	95

The maximum power dissipation rating must be reduced with increasing environmental operating temperatures. Refer to the Temperature Compensation Multiplier table for details.

Using the P max of the device, the maximum allowable rms ripple current or voltage may be determined.

$$I(max) = \sqrt{P_{max}/R}$$

$$E(max) = \sqrt{P_{max} \cdot R}$$

I = rms ripple current (amperes)

E = rms ripple voltage (volts)

P max = maximum power dissipation (watts)

R = ESR at specified frequency (ohms)

Reverse Voltage

Polymer tantalum capacitors are polar devices and may be permanently damaged or destroyed if connected in the wrong polarity. These devices will withstand a small degree of transient voltage reversal for short periods as shown in the below table.

Temperature	Permissible Transient Reverse Voltage
25°C	15% of Rated Voltage
55°C	10% of Rated Voltage
85°C	5% of Rated Voltage
105°C	3% of Rated Voltage
125°C*	1% of Rated Voltage

*For series rated to 125°C

Table 2 – Land Dimensions/Courtyard

KEMET	Metric Size Code	Density Level A: Maximum (Most) Land Protrusion (mm)					Density Level B: Median (Nominal) Land Protrusion (mm)					Density Level C: Minimum (Least) Land Protrusion (mm)				
		X	Y	C	V1	V2	X	Y	C	V1	V2	X	Y	C	V1	V2
B	3528-21	2.35	2.15	1.45	6.10	4.00	2.25	1.75	1.35	5.00	3.50	2.15	1.35	1.25	4.10	3.20
D	7343-31	2.55	3.75	2.70	10.20	5.50	2.45	3.35	2.60	9.10	5.00	2.35	2.95	2.50	8.20	4.70
T	3528-12	2.35	2.15	1.45	6.10	4.00	2.25	1.75	1.35	5.00	3.50	2.15	1.35	1.25	4.10	3.20
V	7343-20	2.55	3.75	2.70	10.20	5.50	2.45	3.35	2.60	9.10	5.00	2.35	2.95	2.50	8.20	4.70
Y ¹	7343-40	2.55	3.75	2.70	10.20	5.50	2.45	3.35	2.60	9.10	5.00	2.35	2.95	2.50	8.20	4.70

Density Level A: For low-density product applications. Recommended for wave solder applications and provides a wider process window for reflow solder processes.

Density Level B: For products with a moderate level of component density. Provides a robust solder attachment condition for reflow solder processes.

Density Level C: For high component density product applications. Before adapting the minimum land pattern variations the user should perform qualification testing based on the conditions outlined in IPC Standard 7351 (IPC-7351).

¹ Height of these chips may create problems in wave soldering.

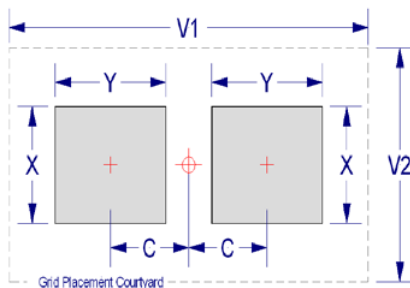

Soldering Process

KEMET’s families of surface mount capacitors are compatible with wave (single or dual), convection, IR, or vapor phase reflow techniques. Preheating of these components is recommended to avoid extreme thermal stress. KEMET’s recommended profile conditions for convection and IR reflow reflect the profile conditions of the IPC/J–STD–020D standard for moisture sensitivity testing. The devices can safely withstand a maximum of three reflow passes at these conditions.

Please note that although the X/7343–43 case size can withstand wave soldering, the tall profile (4.3 mm maximum) dictates care in wave process development.

Hand soldering should be performed with care due to the difficulty in process control. If performed, care should be taken to avoid contact of the soldering iron to the molded case. The iron should be used to heat the solder pad, applying solder between the pad and the termination, until reflow occurs. Once reflow occurs, the iron should be removed immediately. “Wiping” the edges of a chip and heating the top surface is not recommended.

During typical reflow operations, a slight darkening of the gold-colored epoxy may be observed. This slight darkening is normal and not harmful to the product. Marking permanency is not affected by this change.

Profile Feature	SnPb Assembly	Pb-Free Assembly
Preheat/Soak		
Temperature Minimum (T_{smin})	100°C	150°C
Temperature Maximum (T_{smax})	150°C	200°C
Time (t_s) from T_{smin} to T_{smax}	60 – 120 seconds	60 – 120 seconds
Ramp-up Rate (T_L to T_p)	3°C/seconds maximum	3°C/seconds maximum
Liquidous Temperature (T_L)	183°C	217°C
Time Above Liquidous (t_L)	60 – 150 seconds	60 – 150 seconds
Peak Temperature (T_p)	220°C* 235°C**	250°C* 260°C**
Time within 5°C of Maximum Peak Temperature (t_p)	20 seconds maximum	30 seconds maximum
Ramp-down Rate (T_p to T_L)	6°C/seconds maximum	6°C/seconds maximum
Time 25°C to Peak Temperature	6 minutes maximum	8 minutes maximum

Note: All temperatures refer to the center of the package, measured on the package body surface that is facing up during assembly reflow.

*Case Size D, E, P, Y, and X

**Case Size A, B, C, H, I, K, M, R, S, T, U, V, W, and Z

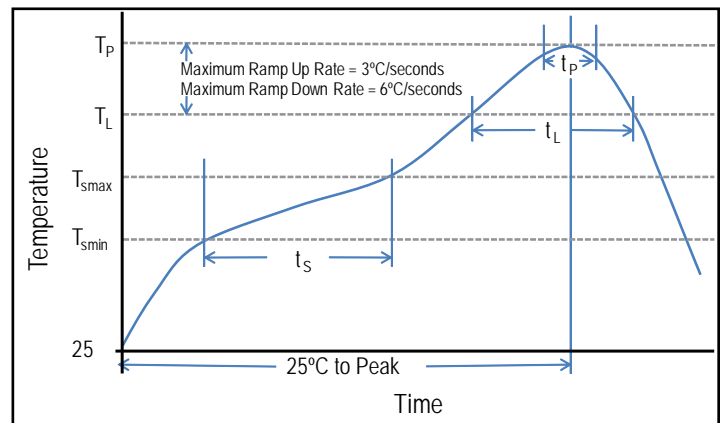

Construction

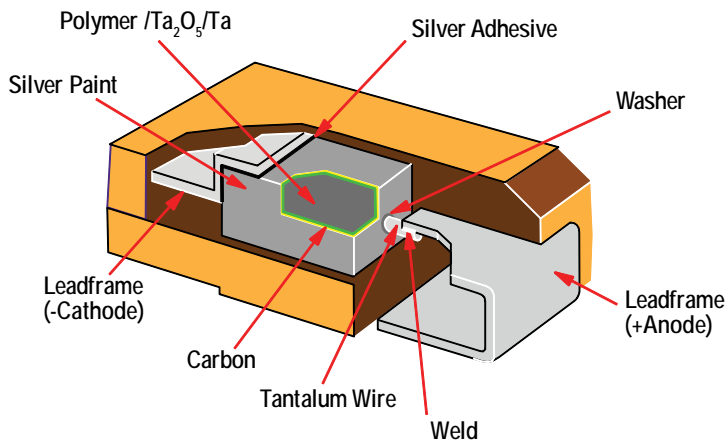

Capacitor Marking

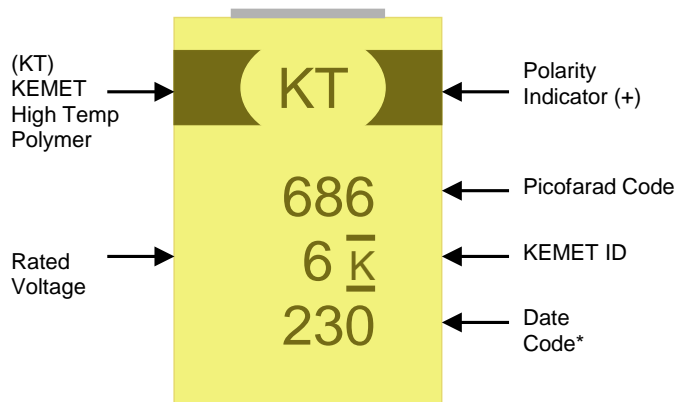

* 230 = 30th week of 2012

Date Code *	
1 st digit = Last number of Year	9 = 2009 0 = 2010 1 = 2011 2 = 2012 3 = 2013 4 = 2014
2 nd and 3 rd digit = Week of the Year	01 = 1 st week of the Year to 52 = 52 nd week of the Year

Storage

All KO-CAP series are shipped in moisture barrier bags with a desiccant and moisture indicator card. These series are classified as MSL3 (Moisture Sensitivity Level 3). Product contained within the moisture barrier bags should be stored in normal working environments with temperatures not to exceed 40°C and humidity not in excess of 60% RH.

Overview

The KEMET Organic Capacitor (KO-CAP) is a tantalum capacitor with a Ta anode and Ta₂O₅ dielectric. A conductive organic polymer replaces the traditionally used MnO₂ as the cathode plate of the capacitor. This results in very low ESR and improved capacitance retention at high frequency. The KO-CAP also exhibits a benign failure mode which eliminates the ignition failures that can occur in standard MnO₂ tantalum types. KO-CAPs may also be operated at steady state voltages up to 90% of rated voltage for part types with rated voltages of ≤ 10 volts and up to 80% of rated voltage for part types > 10 volts with equivalent or better reliability than traditional MnO₂ tantalum capacitors operated at 50% of rated voltage.

The T528 Series KO-CAP combines ultra-low ESR and high capacitance in a package design that offers the lowest ESL in the market for this type of product. This series offers exceptional performance for high-speed server and microprocessor decoupling – designs that are driving the demand for low inductance chips. The T528 uses a different termination design that allows for a reduction in the inductance loop area and comes in a low profile 1.7 mm case height. These product features offer the advantage of improved capacitance retention at frequencies of up to 1 MHz.

Benefits

- Polymer cathode technology
- 100% accelerated steady state aging
- Low ESL <0.7 nH @ 20 MHz
- 100% surge current tested
- High frequency capacitance retention
- Non-ignition failure mode
- Improved volumetric efficiency
- Self-healing mechanism
- Capacitance: 33 μF to 470 μF
- Use up to 90% of rated voltage (10% derating)
- Voltage: 2.5 V to 10 V
- RoHS compliant and Halogen Free
- 105°C maximum temperature capability
- Lead free 260°C reflow capable

Applications

Typical applications include high speed server, microprocessor decoupling and high ripple current applications.



Environmental Compliance

RoHS Compliant (6/6) according to Directive 2002/95/EC when ordered with 100% Sn Solder



RoHS Compliant

SPICE

For a detailed analysis of specific part numbers, please visit www.kemet.com for a free download of KEMET's SPICE software. The KEMET SPICE program is freeware intended to aid design engineers in analyzing the performance of these capacitors over frequency, temperature, ripple, and DC bias conditions.

Ordering Information

T	528	Z	337	M	2R5	A	T	E009	
Capacitor Class	Series	Case Size	Capacitance Code (pF)	Capacitance Tolerance	Voltage	Failure Rate/Design	Lead Material	ESR Code	Packaging (C-Spec)
T = Tantalum	528 = Low ESL Facedown Terminal Polymer	I, K, W, Z	First two digits represent significant figures. Third digit specifies number of zeros.	M = $\pm 20\%$	2R5 = 2.5 V 003 = 3 V 004 = 4 V 006 = 6.3 V 010 = 10 V	A = N/A	T = 100% Matte Tin (Sn) Plated	E = ESR Last three digits specify ESR in m Ω (009 = 9 m Ω)	Blank = 7" Reel 7280 = 13" Reel

Performance Characteristics

Item	Performance Characteristics
Operating Temperature	-55°C to 105°C
Rated Capacitance Range	33 – 470 μF @ 120 Hz/25°C
Capacitance Tolerance	M Tolerance (20%)
Rated Voltage Range	2.5 – 10 V
DF (120 Hz)	$\leq 10\%$
ESR (100 kHz)	Refer to Part Number Electrical Specification Table
Leakage Current	$\leq 0.1 \text{ CV}$ (μA) at rated voltage after 5 minutes

Qualification

Test	Condition	Characteristics					
Endurance	85°C @ rated voltage, 2,000 hours 125°C @ 2/3 rated voltage, 2,000 hours	Δ C/C	Within ±10% of initial value				
		DF	Within initial limits				
		DCL	Within 1.25 x initial limit				
		ESR	Within initial limits				
Storage Life	125°C @ 0 volts, 2,000 hours	Δ C/C	Within ±10% of initial value				
		DF	Within initial limits				
		DCL	Within 1.25 x initial limit				
		ESR	Within initial limits				
Thermal Shock	MIL-STD-202, Method 107, Condition B, mounted, -55°C to 125°C, 1,000 cycles	Δ C/C	Within ±5% of initial value				
		DF	Within initial limits				
		DCL	Within 1.25 x initial limit				
		ESR	Within initial limits				
Temperature Stability	Extreme temperature exposure at a succession of continuous steps at +25°C, -55°C, +25°C, +85°C, +125°C, +25°C		+25°C	-55°C	+85°C	+125°C	
		Δ C/C	IL*	±10%	±10%	±20%	
		DF	IL	IL	1.5 x IL	1.5 x IL	
		DCL	IL	n/a	10 x IL	12 x IL	
		Surge Voltage	25°C and 85°C, 1.32 x rated voltage 1,000 cycles (125°C, 1.2 x rated voltage)	Δ C/C	Within ±5% of initial value		
				DF	Within initial limits		
DCL	Within initial limits						
ESR	Within initial limits						
Mechanical Shock/Vibration	MIL-STD-202, Method 213, Condition I, 100 G peak MIL-STD-202, Method 204, Condition D, 10 Hz to 2,000 Hz, 20 G peak	Δ C/C	Within ±10 of initial value				
		DF	Within initial limits				
		DCL	Within initial limits				

*IL = Initial limit

Electrical Characteristics

ESR vs. Frequency

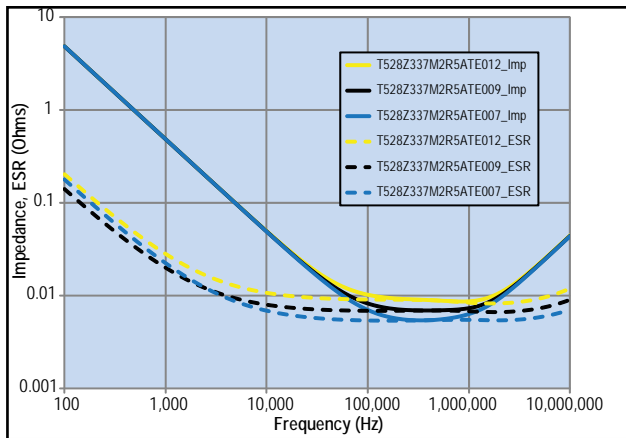

Capacitance vs. Frequency

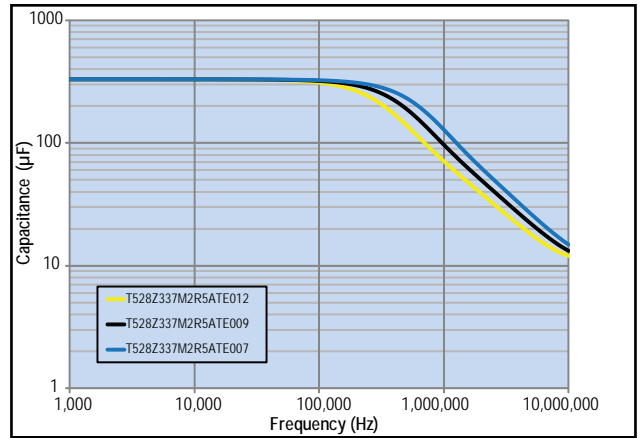

Dimensions – Millimeters

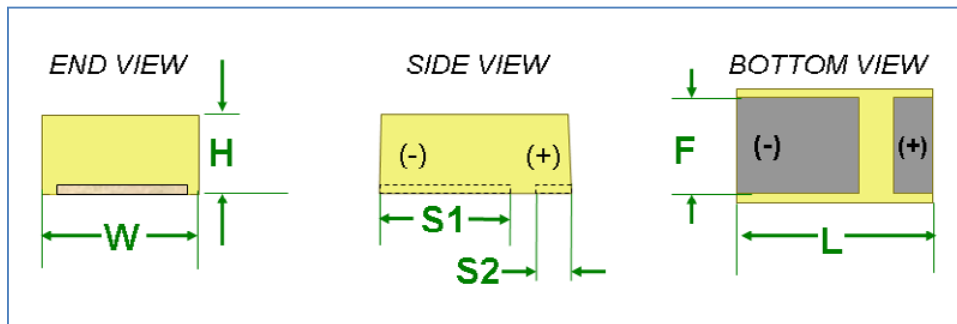

Case Size		Component					
KEMET	EIA	L	W	H	F ±0.2	S1 ±0.2	S2 ±0.2
I	3216-10	3.2 ±0.2	1.6 ±0.2	1.0 Maximum	1.2	1.0	0.7
K	3528-10	3.5 ±0.3	2.8 ±0.3	1.0 Maximum	2	1.2	0.6
W	7343-15	7.3 ±0.4	4.3 ±0.3	1.5 Maximum	2.8	5.1	1.3
Z	7343-17	7.3 ±0.4	4.3 ±0.3	1.7 Maximum	2.8	5.1	1.3

Table 1 – Ratings & Part Number Reference

Rated Voltage	Rated Capacitance	Case Code/ Case Size	KEMET Part Number	DC Leakage	DF	ESR	Maximum Allowable Ripple Current	Moisture Sensitivity
VDC	µF	KEMET/EIA	(See below for part options)	µA @ +20°C Maximum/ 5 Minutes	% @ +20°C 120 Hz Maximum	mΩ @ +20°C 100 kHz Maximum	(mA) +45°C 100 kHz	Temp ≤ 260°C
2.5	220	Z/7343-18	T528Z227M2R5ATE006	55.0	10	6	7400	3
2.5	330	W/7343-15	T528W337M2R5ATE009	82.5	10	9	6000	3
2.5	330	Z/7343-18	T528Z337M2R5ATE005	82.5	10	5	8100	3
2.5	330	Z/7343-18	T528Z337M2R5ATE006	82.5	10	6	7400	3
2.5	330	Z/7343-18	T528Z337M2R5ATE007	82.5	10	7	6800	3
2.5	330	Z/7343-18	T528Z337M2R5ATE008	82.5	10	8	6400	3
2.5	330	Z/7343-18	T528Z337M2R5ATE009	82.5	10	9	6000	3
2.5	330	Z/7343-18	T528Z337M2R5ATE012	82.5	10	12	5200	3
2.5	470	Z/7343-18	T528Z477M2R5ATE005	117.5	10	5	8100	3
2.5	470	Z/7343-18	T528Z477M2R5ATE006	117.5	10	6	7400	3
2.5	470	Z/7343-18	T528Z477M2R5ATE008	117.5	10	8	6400	3
2.5	470	Z/7343-18	T528Z477M2R5ATE009	117.5	10	9	6000	3
2.5	470	Z/7343-18	T528Z477M2R5ATE012	117.5	10	12	5200	3
3	100	I/3216-10	T528I107M003ATE150	30.0	10	150	800	3
3	100	I/3216-10	T528I107M003ATE200	30.0	10	200	700	3
4	68	I/3216-10	T528I686M004ATE150	27.2	10	150	800	3
4	68	I/3216-10	T528I686M004ATE200	27.2	10	200	700	3
4	220	K/3528-10	T528K227M004ATE100	88.0	10	100	1200	3
4	220	Z/7343-18	T528Z227M004ATE007	88.0	10	7	6800	3
4	220	Z/7343-18	T528Z227M004ATE008	88.0	10	8	6400	3
4	220	Z/7343-18	T528Z227M004ATE009	88.0	10	9	6000	3
4	220	Z/7343-18	T528Z227M004ATE012	88.0	10	12	5200	3
4	330	Z/7343-18	T528Z337M004ATE009	132.0	10	9	6000	3
4	330	Z/7343-18	T528Z337M004ATE012	132.0	10	12	5200	3
6.3	47	I/3216-10	T528I476M006ATE150	29.6	10	150	800	3
6.3	47	I/3216-10	T528I476M006ATE200	29.6	10	200	700	3
6.3	150	K/3528-10	T528K157M006ATE200	94.5	10	200	900	3
6.3	150	K/3528-10	T528K157M006ATE100	94.5	10	100	1200	3
6.3	150	K/3528-10	T528K157M006ATE200	94.5	10	200	900	3
6.3	150	Z/7343-18	T528Z157M006ATE007	94.5	10	7	6800	3
6.3	150	Z/7343-18	T528Z157M006ATE008	94.5	10	8	6400	3
6.3	150	Z/7343-18	T528Z157M006ATE009	94.5	10	9	6000	3
6.3	150	Z/7343-18	T528Z157M006ATE012	94.5	10	12	5200	3
6.3	220	Z/7343-18	T528Z227M006ATE009	138.6	10	9	6000	3
6.3	220	Z/7343-18	T528Z227M006ATE012	138.6	10	12	5200	3
10	33	I/3216-10	T528I336M010ATE150	33.0	10	150	800	3
10	33	I/3216-10	T528I336M010ATE200	33.0	10	200	700	3
VDC	µF	KEMET/EIA	(See below for part options)	µA @ +20°C Maximum/ 5 Minutes	% @ +20°C 120 Hz Maximum	mΩ @ +20°C 100 kHz Maximum	(mA) +45°C 100 kHz	Temp ≤ 260°C
Rated Voltage	Rated Capacitance	Case Code/ Case Size	KEMET Part Number	DC Leakage	DF	ESR	Maximum Allowable Ripple Current	Moisture Sensitivity

Other part number options:

1- Standard with tin terminations (14th character = T). Tin/lead terminations is also available (14th character = H).

Also available on large (13 inch) reels. Add 7280 to the end of the part number.

Higher voltage ratings and tighter tolerance product including ESR may be substituted within the same size at KEMET's option. Voltage substitutions will be marked with the higher voltage rating. Substitutions can include better than series.

Derating Guidelines

Voltage Rating	Maximum Recommended Steady State Voltage	Maximum Recommended Transient Voltage (1 ms – 1 μs)
-55°C to 105°C		
$2.5 V \leq V_R \leq 10 V$	90% of V_R	V_R

V_R = Rated Voltage

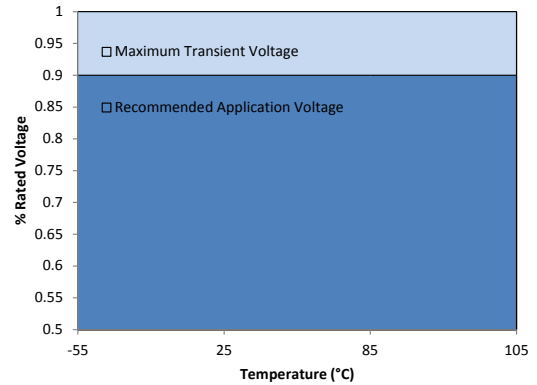

Ripple Current/Ripple Voltage

Permissible AC ripple voltage and current are related to equivalent series resistance (ESR) and the power dissipation capabilities of the device. Permissible AC ripple voltage which may be applied is limited by two criteria:

1. The positive peak AC voltage plus the DC bias voltage, if any, must not exceed the DC voltage rating of the capacitor.
2. The negative peak AC voltage in combination with bias voltage, if any, must not exceed the allowable limits specified for reverse voltage. See the Reverse Voltage section for allowable limits.

The maximum power dissipation by case size can be determined using the table at right. The maximum power dissipation rating stated in the table must be reduced with increasing environmental operating temperatures. Refer to the table below for temperature compensation requirements.

Case Code	EIA Case Code	Maximum Power Dissipation (P max) mWatts @ 45°C with +30°C Rise
W	7343-15	325
Z	7343-17	325
D	7343-31	255
Y	7343-40	263
X	7443-43	270

The maximum power dissipation rating must be reduced with increasing environmental operating temperatures. Refer to the Temperature Compensation Multiplier table for details.

Temperature Compensation Multipliers for Maximum Power Dissipation		
≤ 45°C	45° C < T ≤ 85°C	85°C < T ≤ 125°C
1.00	0.70	0.25

T = Environmental Temperature

Using the P max of the device, the maximum allowable rms ripple current or voltage may be determined.

$$I(max) = \sqrt{P_{max}/R}$$

$$E(max) = \sqrt{P_{max} \cdot R}$$

I = rms ripple current (amperes)

E = rms ripple voltage (volts)

P max = maximum power dissipation (watts)

R = ESR at specified frequency (ohms)

Reverse Voltage

Polymer tantalum capacitors are polar devices and may be permanently damaged or destroyed if connected in the wrong polarity. These devices will withstand a small degree of transient voltage reversal for short periods as shown in the below table.

Temperature	Permissible Transient Reverse Voltage
25°C	15% of Rated Voltage
55°C	10% of Rated Voltage
85°C	5% of Rated Voltage
105°C	3% of Rated Voltage
125°C*	1% of Rated Voltage

*For Series Rated to 125°C

Table 2 – Land Dimensions/Courtyard

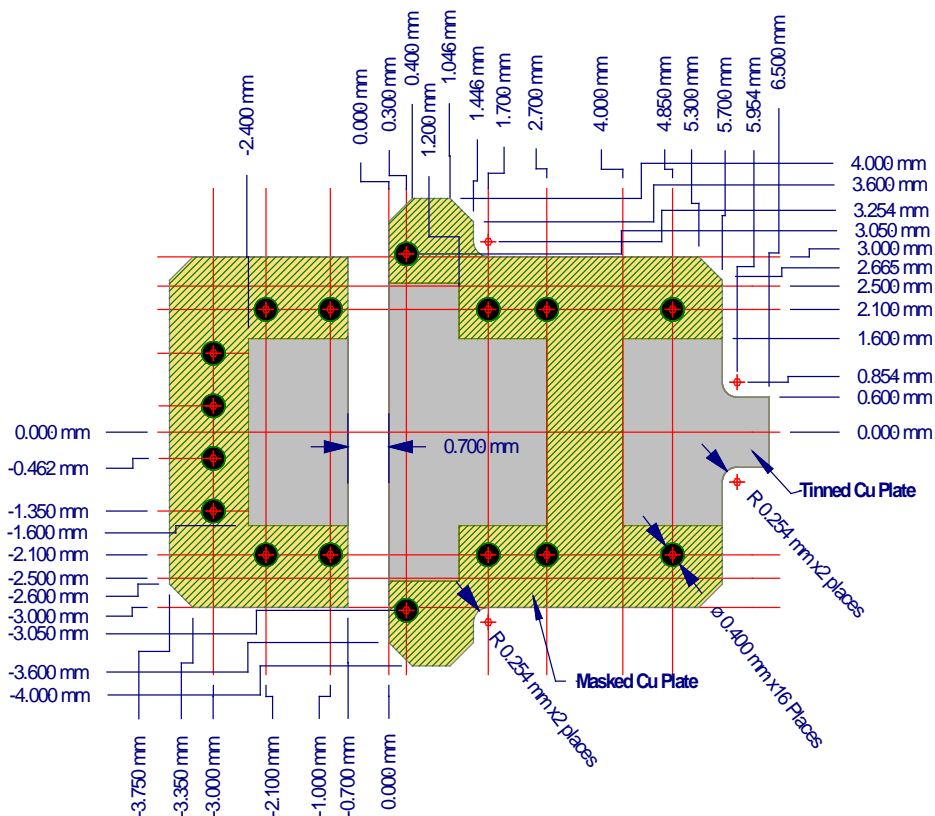

Soldering Process

KEMET’s families of surface mount capacitors are compatible with wave (single or dual), convection, IR, or vapor phase reflow techniques. Preheating of these components is recommended to avoid extreme thermal stress. KEMET’s recommended profile conditions for convection and IR reflow reflect the profile conditions of the IPC/J–STD–020D standard for moisture sensitivity testing. The devices can safely withstand a maximum of three reflow passes at these conditions.

Please note that although the X/7343–43 case size can withstand wave soldering, the tall profile (4.3 mm maximum) dictates care in wave process development.

Hand soldering should be performed with care due to the difficulty in process control. If performed, care should be taken to avoid contact of the soldering iron to the molded case. The iron should be used to heat the solder pad, applying solder between the pad and the termination, until reflow occurs. Once reflow occurs, the iron should be removed immediately. “Wiping” the edges of a chip and heating the top surface is not recommended.

During typical reflow operations, a slight darkening of the gold-colored epoxy may be observed. This slight darkening is normal and not harmful to the product. Marking permanency is not affected by this change.

Profile Feature	SnPb Assembly	Pb-Free Assembly
Preheat/Soak		
Temperature Minimum (T_{smin})	100°C	150°C
Temperature Maximum (T_{smax})	150°C	200°C
Time (t_s) from T_{smin} to T_{smax}	60 – 120 seconds	60 – 120 seconds
Ramp-up Rate (T_L to T_p)	3°C/seconds maximum	3°C/seconds maximum
Liquidous Temperature (T_L)	183°C	217°C
Time Above Liquidous (t_L)	60 – 150 seconds	60 – 150 seconds
Peak Temperature (T_p)	220°C* 235°C**	250°C* 260°C**
Time within 5°C of Maximum Peak Temperature (t_p)	20 seconds maximum	30 seconds maximum
Ramp-down Rate (T_p to T_L)	6°C/seconds maximum	6°C/seconds maximum
Time 25°C to Peak Temperature	6 minutes maximum	8 minutes maximum

Note: All temperatures refer to the center of the package, measured on the package body surface that is facing up during assembly reflow.

*Case Size D, E, P, Y, and X

**Case Size A, B, C, H, I, K, M, R, S, T, U, V, W, and Z

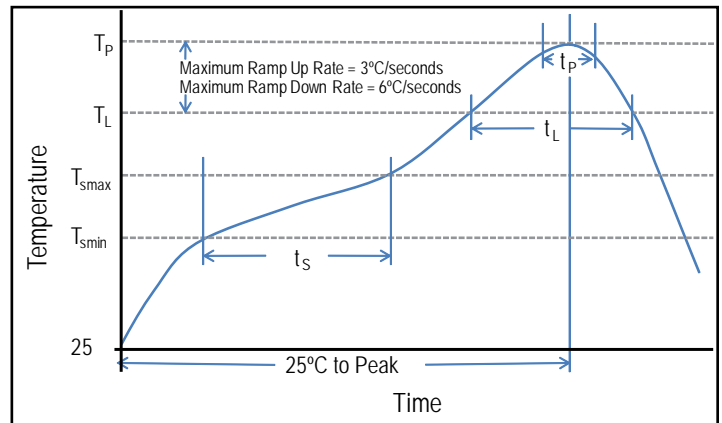

Construction

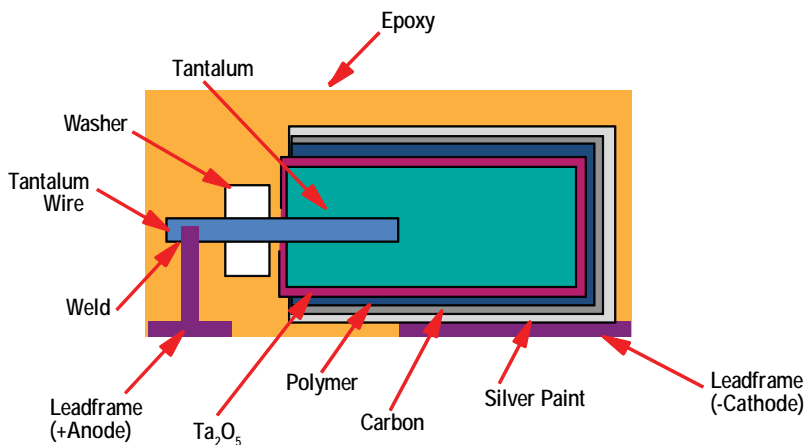

Capacitor Marking

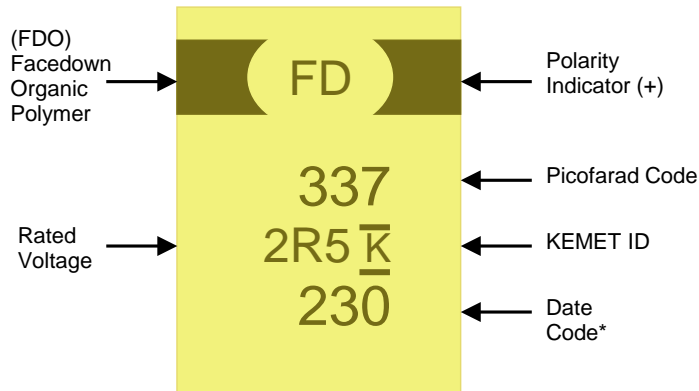

* 230 = 30th week of 2012

Date Code *	
1 st digit = Last number of Year	9 = 2009 0 = 2010 1 = 2011 2 = 2012 3 = 2013 4 = 2014
2 nd and 3 rd digit = Week of the Year	01 = 1 st week of the Year to 52 = 52 nd week of the Year

Storage

All KO-CAP series are shipped in moisture barrier bags with a desiccant and moisture indicator card. These series are classified as MSL3 (Moisture Sensitivity Level 3). Product contained within the moisture barrier bags should be stored in normal working environments with temperatures not to exceed 40°C and humidity not in excess of 60% RH.

Overview

The KEMET Organic Capacitor (KO-CAP) is a tantalum capacitor with a Ta anode and Ta₂O₅ dielectric. A conductive organic polymer replaces the traditionally used MnO₂ as the cathode plate of the capacitor. This results in very low ESR and improved capacitance retention at high frequency. The KO-CAP also exhibits a benign failure mode which eliminates the ignition failures that can occur in standard MnO₂ tantalum types. KO-CAPs may also be operated at steady state voltages up to 90% of rated voltage for part types with rated voltages of ≤10 volts and up to 80% of rated voltage for part types >10 volts with equivalent or better reliability than traditional MnO₂ tantalum capacitors operated at 50% of rated voltage.

The T530 Series KO-CAP offers the same advantages as the T520 Series but also has the added advantages of higher capacitance, 125°C performance capability, higher ripple current handling capability and a lower ESR range. Packaged as multiple anodes to reduce the depth that the signal must penetrate, this parallel arrangement reduces the ESR further still to achieve the highest capacitance and lowest ESR of any other type of surface mount capacitor with typical ESR values as low as 4 mΩ. With reduced ESR, the enhanced capacitance retention at higher frequencies provides the lowest total capacitance and most economical solution for high power applications.

Benefits

- ESR: 4 mΩ to 40 mΩ
- 125°C maximum operating temperature
- Polymer cathode technology
- High frequency capacitance retention
- Non-ignition failure mode
- Capacitance: 150 μF to 1,500 μF
- 100% accelerated steady state aging
- 100% surge current tested
- Utilizes multiple tantalum anode technology
- Volumetric efficiency
- Use up to 90% of rated voltage (10% derating) for part types ≤ 10 V
- Use up to 80% of rated voltage (20% derating) for part types > 10 V
- Self-healing mechanism
- EIA standard case sizes

Applications

Typical applications include high speed server, microprocessor decoupling and high ripple current applications.



Environmental Compliance

RoHS Compliant (6/6) according to Directive 2002/95/EC when ordered with 100% Sn Solder



RoHS Compliant

SPICE

For a detailed analysis of specific part numbers, please visit www.kemet.com for a free download of KEMET's SPICE software. The KEMET SPICE program is freeware intended to aid design engineers in analyzing the performance of these capacitors over frequency, temperature, ripple, and DC bias conditions.

Ordering Information

T	530	X	337	M	010	A	T	E005	
Capacitor Class	Series	Case Size	Capacitance Code (pF)	Capacitance Tolerance	Voltage	Failure Rate/Design	Lead Material	ESR Code	Packaging (C-Spec)
T = Tantalum	530 = High Capacitance 125°C Rated Polymer	D, X, Y	First two digits represent significant figures. Third digit specifies number of zeros.	M = ±20%	2R5 = 2.5 V 003 = 3 V 004 = 4 V 006 = 6.3 V 010 = 10 V 016 = 16 V	A = N/A	T = 100% Matte Tin (Sn) Plated H = Tin/Lead (SnPb) Solder Coated (5% Pb minimum) G = Gold Plated	E = ESR Last three digits specify ESR in mΩ (005 = 5 mΩ)	Blank = 7" Reel 7280 = 13" Reel

Performance Characteristics

Item	Performance Characteristics
Operating Temperature	-55°C to 125°C
Rated Capacitance Range	150 – 1,500 μF @ 120 Hz/25°C
Capacitance Tolerance	M Tolerance (20%)
Rated Voltage Range	2.5 – 16 V
DF (120 Hz)	8%
ESR (100 kHz)	Refer to Part Number Electrical Specification Table
Leakage Current	≤ 0.1 CV (μA) at rated voltage after 5 minutes

Qualification

Test	Condition	Characteristics				
Endurance	105°C @ rated voltage, 2,000 hours 125°C @ 2/3 rated voltage, 2,000 hours	Δ C/C	Within -20%/+10% of initial value			
		DF	≤ initial limit			
		DCL	2 x initial limit @ 125°C			
		ESR	2 x initial limit			
Storage Life	125°C @ 0 volts, 2,000 hours	Δ C/C	Within -20%/+10% of initial value			
		DF	Within initial limits			
		DCL	Within 2.0 x initial limit			
		ESR	Within 2.0 x initial limit			
Humidity	60°C, 90% RH, 1,000 hours, No Load	Δ C/C	Within -5%/+35% of initial value			
		DF	≤ initial limit			
		DCL	Within 3.0 x initial limit			
Temperature Stability	Extreme temperature exposure at a succession of continuous steps at +25°C, -55°C, +25°C, +85°C, +105°C, +25°C		+25°C	-55°C	+85°C	+125°C
		Δ C/C	IL*	±20%	±20%	±30%
		DF	IL	IL	1.2 x IL	1.5 x IL
Surge Voltage	105°C, 1.32 x rated voltage, 33Ω Resistance, 1,000 cycles	Δ C/C	Within -20%/+10% of initial value			
		DF	Within initial limits			
		DCL	Within initial limits			
		ESR	Within initial limits			
Mechanical Shock/Vibration	MIL-STD-202, Method 213, Condition I, 100 G peak MIL-STD-202, Method 204, Condition D, 10 Hz to 2,000 Hz, 20 G peak	Δ C/C	Within ±10% of initial value			
		DF	Within initial limits			
		DCL	Within initial limits			

*IL = Initial limit

Certification

DSCC Drawing 04052

Electrical Characteristics

ESR vs. Frequency

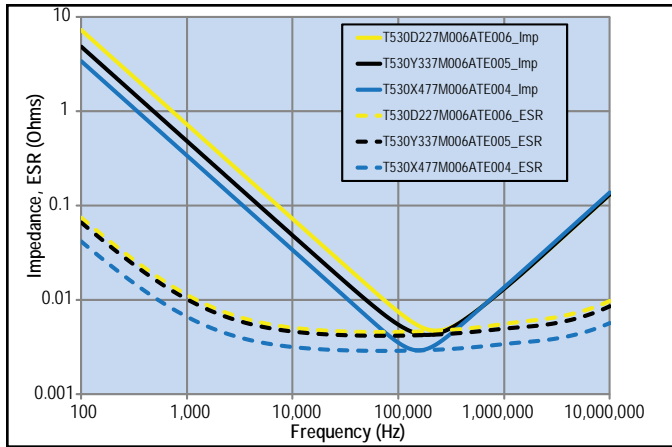

Capacitance vs. Frequency

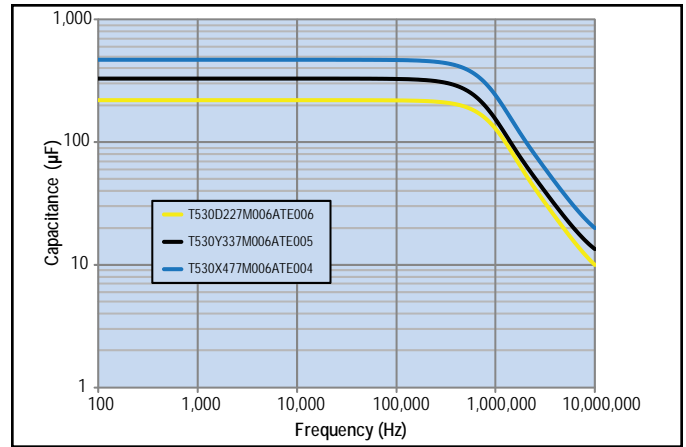

Dimensions – Millimeters (Inches)

Metric will govern

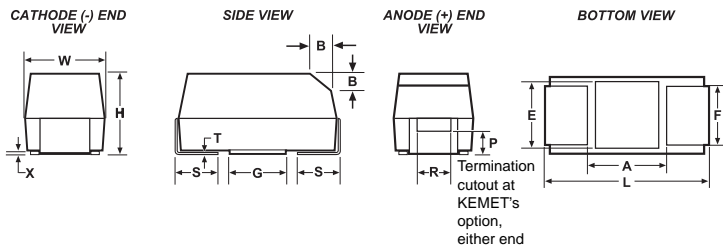

Case Size		Component												
KEMET	EIA	L*	W*	H*	F* ±0.1 ±(.004)	S* ±0.3 ±(.012)	B* ±0.15 (Ref) ±.006	X (Ref)	P (Ref)	R (Ref)	T (Ref)	A (Min)	G (Ref)	E (Ref)
D	7343-31	7.3 ±0.3 (0.287 ±0.012)	4.3 ±0.3 (0.169 ±0.012)	2.8 ±0.3 (0.110 ±0.012)	2.4 (.094)	1.3 (.051)	0.5 (.020)	0.10 ± 0.10 (.004 ± .004)	0.9 (.035)	1.0 (.039)	0.13 (.005)	3.8 (.150)	3.5 (.138)	3.5 (.138)
X	7343-43	7.3 ±0.3 (0.287 ±0.012)	4.3 ±0.3 (0.169 ±0.012)	4.3 ±0.3 (0.157 ±0.012)	2.4 (.094)	1.3 (.051)	0.5 (.020)	0.10 ± 0.10 (.004 ± .004)	1.7 (.067)	1.0 (.039)	0.13 (.005)	3.8 (.150)	3.5 (.138)	3.5 (.138)
Y	7343-40	7.3 ±0.3 (0.287 ±0.012)	4.3 ±0.3 (0.169 ±0.012)	4.0 (0.157)	2.4 (.094)	1.3 (.051)	0.5 (.020)	0.10 ± 0.10 (.004 ± .004)	1.7 (.067)	1.0 (.039)	0.13 (.005)	3.8 (.150)	3.5 (.138)	3.5 (.138)

Notes: (Ref) – Dimensions provided for reference only. No dimensions are provided for B, P or R because low profile cases do not have a bevel or a notch.

* MIL-PRF-55365/8 specified dimensions

Table 1 – Ratings & Part Number Reference

Rated Voltage	Rated Cap	Case Code/ Case Size	KEMET Part Number	DC Leakage	DF	ESR	Maximum Allowable Ripple Current	Moisture Sensitivity	Rated Temp
VDC	µF	KEMET/EIA	(See below for part options)	µA @ +20°C Maximum/ 5 Minutes	% @ +20°C 120 Hz Maximum	mΩ @ +20°C 100 kHz Maximum	(mA) +45°C 100 kHz	Temperature ≤ 260°C	(°C)
2.5	470	D/7343-31	T530D477M2R5A(1)E005	118	8	5	7100	3	125
2.5	470	D/7343-31	T530D477M2R5A(1)E006	118	8	6	6500	3	125
2.5	470	D/7343-31	T530D477M2R5A(1)E010	118	8	10	5000	3	125
2.5	560	D/7343-31	T530D567M2R5A(1)E005	140	8	5	7100	3	125
2.5	680	Y/7343-40	T530Y687M2R5A(1)E005	170	8	5	7300	3	125
2.5	680	Y/7343-40	T530Y687M2R5A(1)E006	170	8	6	6600	3	125
2.5	680	Y/7343-40	T530Y687M2R5(1)E007	170	8	7	6100	3	125
2.5	680	D/7343-31	T530D687M2R5A(1)E006	170	8	6	6500	3	125
2.5	680	D/7343-31	T530D687M2R5A(1)E010	170	8	10	5000	3	125
2.5	680	D/7343-31	T530D687M2R5(1)E007	170	8	7	6000	3	125
2.5	680	X/7343-43	T530X687M2R5A(1)E006	170	8	6	6700	3	125
2.5	1000	Y/7343-40	T530Y108M2R5A(1)E005	250	8	5	7300	3	125
2.5	1000	Y/7343-40	T530Y108M2R5A(1)E006	250	8	6	6600	3	125
2.5	1000	X/7343-43	T530X108M2R5A(1)E004	250	8	4	8200	3	125
2.5	1000	X/7343-43	T530X108M2R5A(1)E005	250	8	5	7300	3	125
2.5	1000	X/7343-43	T530X108M2R5A(1)E006	250	8	6	6700	3	125
2.5	1500	X/7343-43	T530X158M2R5A(1)E005	375	8	5	7300	3	125
3	470	D/7343-31	T530D477M003A(1)E010	141	8	10	5000	3	125
3	680	D/7343-31	T530D687M003A(1)E010	204	8	10	5000	3	125
3	1000	X/7343-43	T530X108M003A(1)E010	300	8	10	5200	3	125
3	1500	X/7343-43	T530X158M003A(1)E008	450	8	8	5800	3	125
4	330	D/7343-31	T530D337M004A(1)E005	132	8	5	7100	3	125
4	330	D/7343-31	T530D337M004A(1)E006	132	8	6	6500	3	125
4	470	D/7343-31	T530D477M004A(1)E006	188	8	6	6500	3	125
4	470	D/7343-31	T530D477M004A(1)E010	188	8	10	5000	3	125
4	470	Y/7343-40	T530Y477M004A(1)E005	188	8	5	7300	3	125
4	470	Y/7343-40	T530Y477M004A(1)E006	188	8	6	6600	3	125
4	680	Y/7343-40	T530Y687M004A(1)E005	272	8	5	7300	3	125
4	680	X/7343-43	T530X687M004A(1)E004	272	8	4	8200	3	125
4	680	X/7343-43	T530X687M004A(1)E005	272	8	5	7300	3	125
4	680	X/7343-43	T530X687M004A(1)E006	272	8	6	6700	3	125
4	680	X/7343-43	T530X687M004A(1)E010	272	8	10	5200	3	125
4	1000	X/7343-43	T530X108M004A(1)E006	400	8	6	6700	3	125
6.3	220	D/7343-31	T530D227M006A(1)E005	139	8	5	7100	3	125
6.3	220	D/7343-31	T530D227M006A(1)E006	139	8	6	6500	3	125
6.3	330	D/7343-31	T530D337M006A(1)E006	208	8	6	6500	3	125
6.3	330	D/7343-31	T530D337M006A(1)E010	208	8	10	5000	3	125
6.3	330	Y/7343-40	T530Y337M006A(1)E005	208	8	5	7300	3	125
6.3	330	Y/7343-40	T530Y337M006A(1)E006	208	8	6	6600	3	125
6.3	330	Y/7343-40	T530Y337M006A(1)E010	208	8	10	5100	3	125
6.3	470	Y/7343-40	T530Y477M006A(1)E005	296	8	5	7300	3	125
6.3	470	X/7343-43	T530X477M006A(1)E004	296	8	4	8200	3	125
6.3	470	X/7343-43	T530X477M006A(1)E005	296	8	5	7300	3	125
6.3	470	X/7343-43	T530X477M006A(1)E006	296	8	6	6700	3	125
6.3	470	X/7343-43	T530X477M006A(1)E010	296	8	10	5200	3	125
6.3	680	X/7343-43	T530X687M006A(1)E010	428	8	10	5200	3	125
VDC	µF	KEMET/EIA	(See below for part options)	µA @ +20°C Maximum/ 5 Minutes	% @ +20°C 120 Hz Maximum	mΩ @ +20°C 100 kHz Maximum	(mA) +45°C 100 kHz	Temperature ≤ 260°C	(°C)
Rated Voltage	Rated Cap	Case Code/ Case Size	KEMET Part Number	DC Leakage	DF	ESR	Maximum Allowable Ripple Current	Moisture Sensitivity	Rated Temp

Other part number options:

(1) Standard with tin terminations (14th character = T). Tin/lead terminations is also available (14th character = H).

Also available on large (13 inch) reels. Add 7280 to the end of the part number.

Higher voltage ratings and tighter tolerance product including ESR may be substituted within the same size at KEMET's option. Voltage substitutions will be marked with the higher voltage rating. Substitutions can include better than series.

Table 1 – Ratings & Part Number Reference cont'd

Rated Voltage	Rated Cap	Case Code/ Case Size	KEMET Part Number	DC Leakage	DF	ESR	Maximum Allowable Ripple Current	Moisture Sensitivity	Rated Temp
VDC	µF	KEMET/EIA	(See below for part options)	µA @ +20°C Maximum/ 5 Minutes	% @ +20°C 120 Hz Maximum	mΩ @ +20°C 100 kHz Maximum	(mA) +45°C 100 kHz	Temperature ≤ 260°C	(°C)
6.3	680	X/7343-43	T530X687M006A(1)E018	428	8	18	3900	3	125
10	150	D/7343-31	T530D157M010A(1)E005	150	8	5	7100	3	125
10	150	D/7343-31	T530D157M010A(1)E006	150	8	6	6500	3	125
10	150	D/7343-31	T530D157M010A(1)E010	150	8	10	5000	3	125
10	220	D/7343-31	T530D227M010A(1)E006	220	8	6	6500	3	125
10	220	D/7343-31	T530D227M010A(1)E010	220	8	10	5000	3	125
10	220	Y/7343-40	T530Y227M010A(1)E006	220	8	6	6600	3	125
10	330	X/7343-43	T530X337M010A(1)E004	330	8	4	8200	3	125
10	330	X/7343-43	T530X337M010A(1)E005	330	8	5	7300	3	125
10	330	X/7343-43	T530X337M010A(1)E006	330	8	6	6700	3	125
10	330	X/7343-43	T530X337M010A(1)E010	330	8	10	5200	3	125
16	150	X/7343-43	T530X157M016A(1)E015	240	8	15	4200	3	125
16	150	X/7343-43	T530X157M016A(1)E025	240	8	25	3300	3	125
16	150	X/7343-43	T530X157M016A(1)E040	240	8	40	2600	3	125
VDC	µF	KEMET/EIA	(See below for part options)	µA @ +20°C Maximum/ 5 Minutes	% @ +20°C 120 Hz Maximum	mΩ @ +20°C 100 kHz Maximum	(mA) +45°C 100 kHz	Temperature ≤ 260°C	(°C)
Rated Voltage	Rated Cap	Case Code/ Case Size	KEMET Part Number	DC Leakage	DF	ESR	Maximum Allowable Ripple Current	Moisture Sensitivity	Rated Temp

Other part number options:

(1) Standard with tin terminations (14th character = T). Tin/lead terminations is also available (14th character = H).

Also available on large (13 inch) reels. Add 7280 to the end of the part number.

Higher voltage ratings and tighter tolerance product including ESR may be substituted within the same size at KEMET's option. Voltage substitutions will be marked with the higher voltage rating. Substitutions can include better than series.

Derating Guidelines

Voltage Rating	Maximum Recommended Steady State Voltage	Maximum Recommended Transient Voltage (1 ms – 1 μs)
-55°C to 105°C		
2.5 V ≤ V _R ≤ 10 V	90% of V _R	V _R
V _R = 16 V	80% of V _R	V _R
105°C to 125°C		
2.5 V ≤ V _R ≤ 10 V	60% of V _R	67% of V _R
V _R = 16 V	54% of V _R	67% of V _R

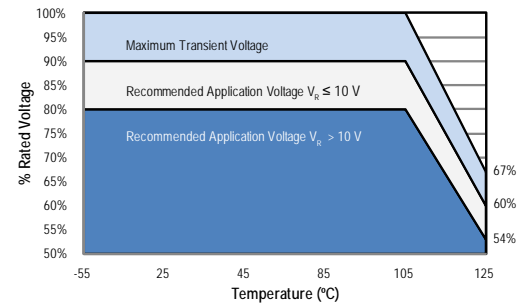

V_R = Rated Voltage

Ripple Current/Ripple Voltage

Permissible AC ripple voltage and current are related to equivalent series resistance (ESR) and the power dissipation capabilities of the device. Permissible AC ripple voltage which may be applied is limited by two criteria:

1. The positive peak AC voltage plus the DC bias voltage, if any, must not exceed the DC voltage rating of the capacitor.
2. The negative peak AC voltage in combination with bias voltage, if any, must not exceed the allowable limits specified for reverse voltage. See the Reverse Voltage section for allowable limits.

The maximum power dissipation by case size can be determined using the table at right. The maximum power dissipation rating stated in the table must be reduced with increasing environmental operating temperatures. Refer to the table below for temperature compensation requirements.

Case Code	EIA Case Code	Maximum Power Dissipation (P max) mWatts @ 45°C with +30°C Rise
W	7343-15	325
Z	7343-17	325
D	7343-31	255
Y	7343-40	263
X	7443-43	270

The maximum power dissipation rating must be reduced with increasing environmental operating temperatures. Refer to the Temperature Compensation Multiplier table for details.

Temperature Compensation Multipliers for Maximum Power Dissipation		
≤ 45°C	45° C < T ≤ 85°C	85°C < T ≤ 125°C
1.00	0.70	0.25

T = Environmental Temperature

Using the P max of the device, the maximum allowable rms ripple current or voltage may be determined.

$$I(max) = \sqrt{P_{max}/R}$$

$$E(max) = \sqrt{P_{max} \cdot R}$$

I = rms ripple current (amperes)

E = rms ripple voltage (volts)

P max = maximum power dissipation (watts)

R = ESR at specified frequency (ohms)

Reverse Voltage

Polymer tantalum capacitors are polar devices and may be permanently damaged or destroyed if connected in the wrong polarity. These devices will withstand a small degree of transient voltage reversal for short periods as shown in the below table.

Temperature	Permissible Transient Reverse Voltage
25°C	15% of Rated Voltage
55°C	10% of Rated Voltage
85°C	5% of Rated Voltage
105°C	3% of Rated Voltage
125°C*	1% of Rated Voltage

*For series rated to 125°C

Table 2 – Land Dimensions/Courtyard

KEMET	Metric Size Code	Density Level A: Maximum (Most) Land Protrusion (mm)					Density Level B: Median (Nominal) Land Protrusion (mm)					Density Level C: Minimum (Least) Land Protrusion (mm)				
		X	Y	C	V1	V2	X	Y	C	V1	V2	X	Y	C	V1	V2
Case	EIA															
D	7343-31	2.55	3.75	2.70	10.20	5.50	2.45	3.35	2.60	9.10	5.00	2.35	2.95	2.50	8.20	4.70
X ¹	7343-43	2.55	3.75	2.70	10.20	5.50	2.45	3.35	2.60	9.10	5.00	2.35	2.95	2.50	8.20	4.70
Y ¹	7343-40	2.55	3.75	2.70	10.20	5.50	2.45	3.35	2.60	9.10	5.00	2.35	2.95	2.50	8.20	4.70

Density Level A: For low-density product applications. Recommended for wave solder applications and provides a wider process window for reflow solder processes.

Density Level B: For products with a moderate level of component density. Provides a robust solder attachment condition for reflow solder processes.

Density Level C: For high component density product applications. Before adapting the minimum land pattern variations the user should perform qualification testing based on the conditions outlined in IPC Standard 7351 (IPC-7351).

¹ Height of these chips may create problems in wave soldering.

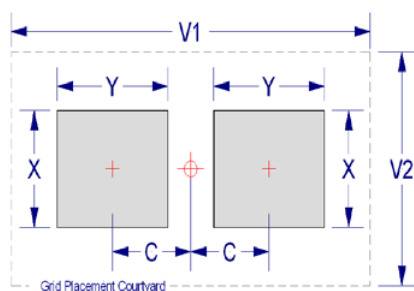

Soldering Process

KEMET's families of surface mount capacitors are compatible with wave (single or dual), convection, IR, or vapor phase reflow techniques. Preheating of these components is recommended to avoid extreme thermal stress. KEMET's recommended profile conditions for convection and IR reflow reflect the profile conditions of the IPC/J-STD-020D standard for moisture sensitivity testing. The devices can safely withstand a maximum of three reflow passes at these conditions.

Please note that although the X/7343-43 case size can withstand wave soldering, the tall profile (4.3 mm maximum) dictates care in wave process development.

Hand soldering should be performed with care due to the difficulty in process control. If performed, care should be taken to avoid contact of the soldering iron to the molded case. The iron should be used to heat the solder pad, applying solder between the pad and the termination, until reflow occurs. Once reflow occurs, the iron should be removed immediately. "Wiping" the edges of a chip and heating the top surface is not recommended.

During typical reflow operations, a slight darkening of the gold-colored epoxy may be observed. This slight darkening is normal and not harmful to the product. Marking permanency is not affected by this change.

Profile Feature	SnPb Assembly	Pb-Free Assembly
Preheat/Soak		
Temperature Minimum (T_{smin})	100°C	150°C
Temperature Maximum (T_{smax})	150°C	200°C
Time (t_s) from T_{smin} to T_{smax}	60 – 120 seconds	60 – 120 seconds
Ramp-up Rate (T_L to T_p)	3°C/seconds maximum	3°C/seconds maximum
Liquidous Temperature (T_L)	183°C	217°C
Time Above Liquidous (t_L)	60 – 150 seconds	60 – 150 seconds
Peak Temperature (T_p)	220°C* 235°C**	250°C* 260°C**
Time within 5°C of Maximum Peak Temperature (t_p)	20 seconds maximum	30 seconds maximum
Ramp-down Rate (T_p to T_L)	6°C/seconds maximum	6°C/seconds maximum
Time 25°C to Peak Temperature	6 minutes maximum	8 minutes maximum

Note: All temperatures refer to the center of the package, measured on the package body surface that is facing up during assembly reflow.

*Case Size D, E, P, Y, and X

**Case Size A, B, C, H, I, K, M, R, S, T, U, V, W, and Z

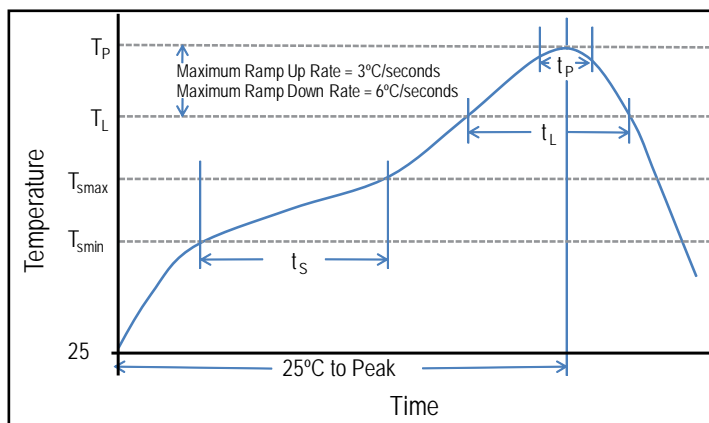

Construction

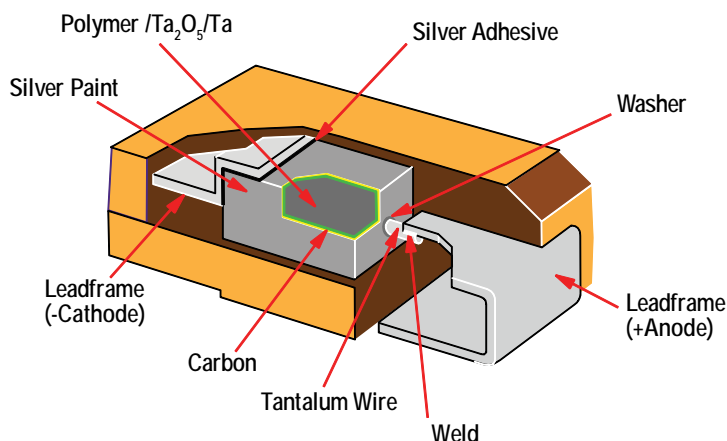

Capacitor Marking

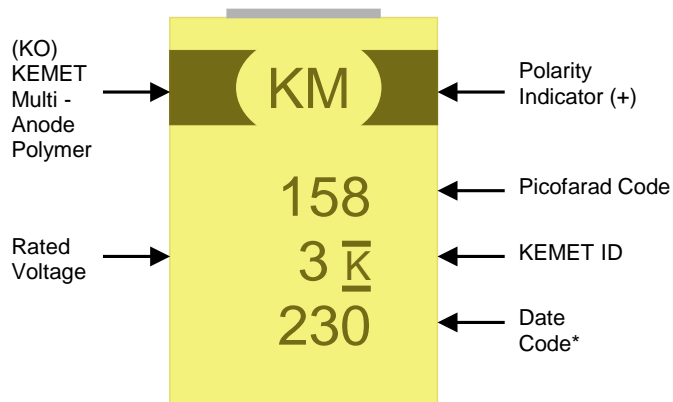

* 230 = 30th week of 2012

Date Code *	
1 st digit = Last number of Year	9 = 2009 0 = 2010 1 = 2011 2 = 2012 3 = 2013 4 = 2014
2 nd and 3 rd digit = Week of the Year	01 = 1 st week of the Year to 52 = 52 nd week of the Year

Storage

All KO-CAP series are shipped in moisture barrier bags with a desiccant and moisture indicator card. These series are classified as MSL3 (Moisture Sensitivity Level 3). Product contained within the moisture barrier bags should be stored in normal working environments with temperatures not to exceed 40°C and humidity not in excess of 60% RH.

Overview

The KEMET Organic Capacitor is a tantalum capacitor with a Ta anode and Ta₂O₅ dielectric. A conductive organic polymer replaces the traditionally used MnO₂ as the cathode plate of the capacitor. This results in very low ESR, improved capacitance retention at high frequency and improved ripple current handling capability. The polymer technology also exhibits a benign failure mode which eliminates the ignition failures. Tantalum polymers may also be operated at voltages up to 90% of rated voltage for part types with rated voltages of ≤ 10 volts and up to 80% of rated voltage for part types > 10 volts with equivalent or better reliability than traditional MnO₂ tantalum capacitors operated at 50% of rated voltage.

The T543 Series Polymer Tantalum COTS is an upscreened version of KEMET's commercial polymer product offering and captures the best features of multilayer ceramic capacitors (low ESR, high frequency capacitance retention), aluminum electrolytic capacitors (higher capacitance, benign failure mode), and proven solid tantalum technology (volumetric efficiency, surface mount capability, extremely long life). The T543 also offers an option for surge current testing (10 cycles at +25°C and 10 cycles at -55°C/+85°C) and termination finish (SnPb and 100% Sn).

Benefits

- Extremely low ESR
- -55°C to 105°C operating temperature range
- Polymer cathode technology
- High frequency capacitance retention
- Non-ignition failure mode
- Capacitance up to 1,500 µF
- Enhanced derating
- 100% accelerated steady state aging
- 100% surge current tested
- Taped and reeled per EIA 481-1
- Volumetric efficiency and self-healing mechanism
- Termination options (SnPb and 100% Sn)
- Surge options at 25°C and -55°C/85°C
- EIA standard case sizes

Applications

Typical applications include DC/DC converters, switch mode and point of load power supply, radar pulse capacitor and telecommunications (mobile phone and base station). Other general applications include decoupling and filtering in applications requiring low ESR or a benign failure mode.



Environmental Compliance

RoHS Compliant (6/6) according to Directive 2002/95/EC when ordered with 100% Sn solder.



RoHS Compliant

SPICE

For a detailed analysis of specific part numbers, please visit www.kemet.com for a free download of KEMET's SPICE software. The KEMET SPICE program is freeware intended to aid design engineers in analyzing the performance of these capacitors over frequency, temperature, ripple, and DC bias conditions.

Ordering Information

T	543	D	156	K	035	A	H	E	100
Capacitor Class	Series	Case Size	Capacitance Code (pF)	Capacitance Tolerance	Voltage	Failure Rate/Design	Lead Material	Surge	ESR
T = Tantalum	Polymer Tantalum COTS	A, B, C, D, H, L, M, T, U, V, W, X, Y	First two digits represent significant figures. Third digit specifies number of zeros.	K = $\pm 10\%$ M = $\pm 20\%$	2R5 = 2.5 V 003 = 3 V 004 = 4 V 006 = 6.3 V 010 = 10 V 12R = 12.5 V 016 = 16 V 020 = 20 V 025 = 25 V 035 = 35 V 050 = 50 V 063 = 63 V	A = N/A	H = Standard Solder Coated (SnPb 5% Pb minimum) T = 100% Tin (Sn)	E = None S = 10 cycles 25°C W = 10 cycles -55°C and 85°C	ESR in mΩ

Performance Characteristics

Item	Performance Characteristics
Operating Temperature	-55°C to 105°C
Rated Capacitance Range	5.6 – 1,500 μF @ 120 Hz/25°C
Capacitance Tolerance	K Tolerance (10%), M Tolerance (20%)
Rated Voltage Range	2.5 – 63 V
DF (120 Hz)	Refer to Part Number Electrical Specification Table
ESR (100 kHz)	Refer to Part Number Electrical Specification Table
Leakage Current	$\leq 0.1 \text{ CV}$ (μA) at rated voltage after 5 minutes

Qualification

Test	Condition	Characteristics				
Endurance	105°C @ rated voltage, 2,000 hours	Δ C/C	Within -20/+10 of initial value			
		DF	Within initial limits			
		DCL	Within 1.25 x initial limit			
		ESR	Within 2.0 x initial limit			
Storage Life	105°C @ 0 volts, 2,000 hours	Δ C/C	Within -20/+10 of initial value			
		DF	Within initial limits			
		DCL	Within 1.25 x initial limit			
		ESR	Within 2.0 x initial limit			
Humidity	60°C, 90% RH, 500 hours	Δ C/C	Within -5%/+35% of initial value			
		DF	Within initial limits			
		DCL	Within 5.0 x initial limit			
		ESR	Within 2.0 x initial limit			
Temperature Stability	Extreme temperature exposure at a succession of continuous steps at +25°C, -55°C, +25°C, +85°C, +105°C, +25° C	+25°C	-55°C	+85°C	+105°C	
		Δ C/C	IL*	+/-20%	+/-20%	+/-30%
		DF	IL	IL	1.2 x IL	1.5 x IL
		DCL	IL	n/a	10 x IL	10 x IL
Surge Voltage	105°C, 1.32 x rated voltage, 1,000 cycles	Δ C/C	Within -20/+10 of initial value			
		DF	Within initial limits			
		DCL	Within initial limits			
		ESR	Within initial limits			
Mechanical Shock/Vibration	MIL-STD-202, Method 213, Condition I, 100 G peak MIL-STD-202, Method 204, Condition D, 10 Hz to 2,000 Hz, 20 G peak	Δ C/C	Within ±10 of initial value			
		DF	Within initial limits			
		DCL	Within initial limits			

*IL = Initial limit

Electrical Characteristics

ESR vs. Frequency

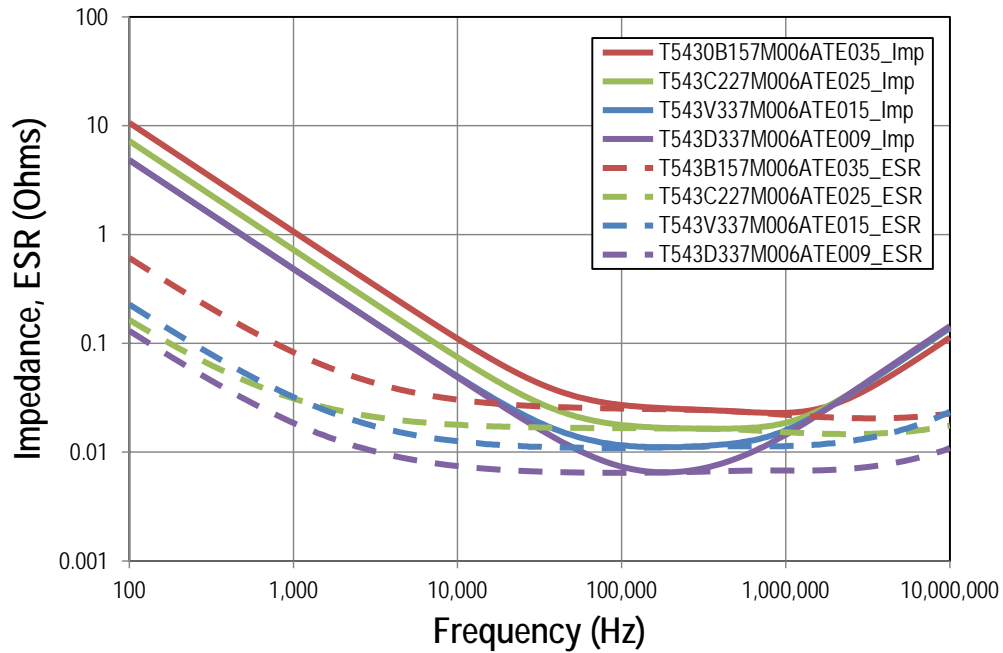

Capacitance vs. Frequency

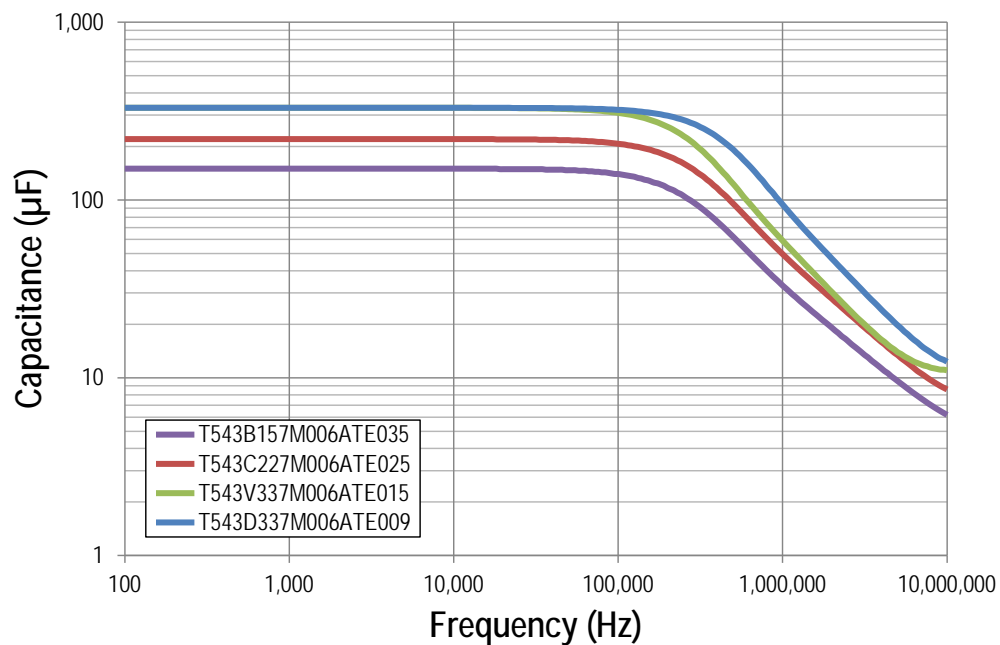

Dimensions – Millimeters

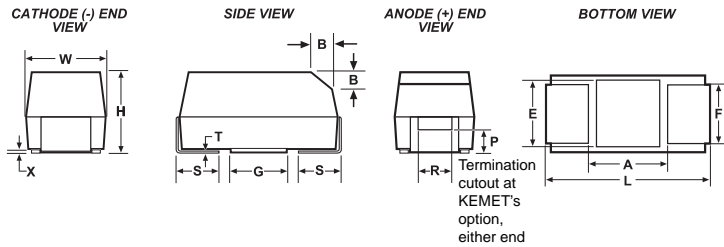

Case Size		Component												
KEMET	EIA	L*	W*	H*	F* ±0.1 ±(0.004)	S* ±0.3 ±(0.012)	B* ±0.15 (Ref) ±0.006	X (Ref)	P (Ref)	R (Ref)	T (Ref)	A (Min)	G (Ref)	E (Ref)
A	3216-18	3.2 ±0.2 (0.126 ±0.008)	1.6 ±0.2 (0.063 ±0.008)	1.6 ±0.2 (0.063 ±0.008)	1.2 (0.047)	0.8 (0.031)	0.4 (0.016)	0.10 ±0.10 (0.004 ±0.004)	0.4 (.016)	0.4 (0.016)	0.13 (0.005)	0.8 (.31)	1.1 (0.043)	1.3 (0.051)
B	3528-21	3.5 ±0.2 (0.138 ±0.008)	2.8 ±0.2 (0.110 ±0.008)	1.9 ±0.2 (0.075 ±0.008)	2.2 (0.087)	0.8 (0.031)	0.4 (0.016)	0.10 ±0.10 (0.004 ±0.004)	0.5 (.020)	1.0 (0.039)	0.13 (0.005)	1.1 (0.043)	1.8 (0.071)	2.2 (0.087)
C	6032-28	6.0 ±0.3 (0.236 ±0.03)	3.2 ±0.3 (0.126 ±0.012)	2.5 ±0.3 (0.098 ±0.012)	2.2 (0.087)	1.3 (0.051)	0.5 (0.020)	0.10 ±0.10 (0.004 ±0.004)	0.9 (.035)	1.0 (0.039)	0.13 (0.005)	2.5 (.098)	2.8 (0.110)	2.4 (0.094)
D	7343-31	7.3 ±0.3 (0.287 ±0.012)	4.3 ±0.3 (0.169 ±0.012)	2.8 ±0.3 (0.110 ±0.012)	2.4 (0.094)	1.3 (0.051)	0.5 (0.020)	0.10 ±0.10 (0.004 ±0.004)	0.9 (0.035)	1.0 (0.039)	0.13 (0.005)	3.8 (.150)	3.5 (0.138)	3.5 (0.138)
H	7360-20	7.3 ±0.3 (0.287 ±0.012)	6.0 ±0.3 (0.236 ±0.012)	2.0 (0.078) Maximum	4.1 (0.161)	1.3 (0.051)	n/a	0.10 ±0.10 (0.004 ±0.004)	n/a	n/a	0.13 (0.005)	3.3 (.130)	3.5 (0.138)	3.5 (0.138)
L	6032-19	6.0 ±0.3 (0.236 ±0.012)	3.2 ±0.2 (0.110 ±0.008)	1.9 (0.075)	2.2 (0.087)	1.3 (0.051)	n/a	0.05 (0.002)	n/a	n/a	0.13 (0.005)	2.5 (.098)	2.8 (0.110)	2.4 (0.094)
M	3528-15	3.5 ±0.2 (0.138 ±0.008)	2.8 ±0.2 (0.110 ±0.008)	1.5 (0.059)	2.2 (0.087)	0.8 (0.031)	n/a	0.05 (0.002)	n/a	n/a	0.13 (0.005)	1.1 (.043)	1.8 (0.071)	2.2 (0.087)
T	3528-12	3.5 ±0.2 (0.138 ±0.008)	2.8 ±0.2 (0.110 ±0.008)	1.2 (0.047)	2.2 (0.087)	0.8 (0.031)	n/a	0.05 (0.002)	n/a	n/a	0.13 (0.005)	1.1 (.043)	1.8 (0.071)	2.2 (0.087)
U	6032-15	6.0 ±0.3 (0.236 ±0.012)	3.2 ±0.2 (0.110 ±0.008)	1.5 (0.059)	2.2 (0.087)	1.3 (0.051)	n/a	0.05 (0.002)	n/a	n/a	0.13 (0.005)	2.5 (.098)	2.8 (0.110)	2.4 (0.094)
V	7343-20	7.3 ±0.3 (0.287 ±0.012)	4.3 ±0.3 (0.169 ±0.012)	2.0 (0.079)	2.4 (0.094)	1.3 (0.051)	n/a	0.05 (0.002)	n/a	n/a	0.13 (0.005)	3.8 (0.150)	3.5 (0.138)	3.5 (0.138)
W	7343-15	7.3 ±0.3 (0.287 ±0.012)	4.3 ±0.3 (0.169 ±0.012)	1.5 (0.059)	2.4 (0.094)	1.3 (0.051)	n/a	0.05 (0.002)	n/a	n/a	0.13 (0.005)	3.8 (0.150)	3.5 (0.138)	3.5 (0.138)
X	7343-43	7.3 ±0.3 (0.287 ±0.012)	4.3 ±0.3 (0.169 ±0.012)	4.0 ±0.3 (0.157 ±0.012)	2.4 (0.094)	1.3 (0.051)	0.5 (0.020)	0.10 ±0.10 (0.004 ±0.004)	1.7 (0.067)	1.0 (0.039)	0.13 (0.005)	3.8 (0.150)	3.5 (0.138)	3.5 (0.138)
Y	7343-40	7.3 ±0.3 (0.287 ±0.012)	4.3 ±0.3 (0.169 ±0.012)	4.0 (0.157)	2.4 (0.094)	1.3 (0.051)	0.5 (0.020)	0.10 ±0.10 (0.004 ±0.004)	1.7 (0.067)	1.0 (0.039)	0.13 (0.005)	3.8 (0.150)	3.5 (0.138)	3.5 (0.138)

Notes: (Ref) – Dimensions provided for reference only. No dimensions are provided for B, P or R because low profile cases do not have a bevel or a notch.

* MIL-PRF-55365/8 specified dimensions

Table 1 – Ratings & Part Number Reference

Rated Voltage	Rated Cap	Case Code/ Case Size	KEMET Part Number	DC Leakage	DF	ESR	Maximum Allowable Ripple Current	Rated Temp	Moisture Sensitivity
V	μF	KEMET/EIA	(See below for part options)	(μA) @ V _R , 20°C Maximum/ 5 Minutes	% @ 20°C 120 Hz Maximum	(mΩ) @ 20°C 100 kHz Maximum	(mA) 45°C 100 kHz	(°C)	Temperature ≤ 260°C
2.5	47	A/3216-18	T543A476(1)2R5A(2)(3)(4)	12	8	90	1116	105	3
2.5	56	T/3528-12	T543T566(1)2R5A(2)(3)(4)	14	8	40	1620	105	3
2.5	56	T/3528-12	T543T566(1)2R5A(2)(3)(4)	14	8	70	1225	105	3
2.5	68	A/3216-18	T543A686(1)2R5A(2)(3)(4)	17	8	70	1265	105	3
2.5	68	A/3216-18	T543A686(1)2R5A(2)(3)(4)	17	8	80	1183	105	3
2.5	100	T/3528-12	T543T107(1)2R5A(2)(3)(4)	25	8	40	1620	105	3
2.5	100	T/3528-12	T543T107(1)2R5A(2)(3)(4)	25	8	70	1225	105	3
2.5	100	T/3528-12	T543T107(1)2R5A(2)(3)(4)	25	8	80	1146	105	3
2.5	100	B/3528-21	T543B107(1)2R5A(2)(3)(4)	25	8	25	2254	105	3
2.5	100	B/3528-21	T543B107(1)2R5A(2)(3)(4)	25	8	35	1905	105	3
2.5	100	B/3528-21	T543B107(1)2R5A(2)(3)(4)	25	8	40	1782	105	3
2.5	100	B/3528-21	T543B107(1)2R5A(2)(3)(4)	25	8	70	1347	105	3
2.5	150	U/6032-15	T543U157(1)2R5A(2)(3)(4)	38	8	55	1567	105	3
2.5	220	B/3528-21	T543B227(1)2R5A(2)(3)(4)	55	8	25	2254	105	3
2.5	220	B/3528-21	T543B227(1)2R5A(2)(3)(4)	55	8	30	2058	105	3
2.5	220	B/3528-21	T543B227(1)2R5A(2)(3)(4)	55	8	35	1905	105	3
2.5	220	B/3528-21	T543B227(1)2R5A(2)(3)(4)	55	8	55	1520	105	3
2.5	220	B/3528-21	T543B227(1)2R5A(2)(3)(4)	55	8	70	1347	105	3
2.5	220	U/6032-15	T543U227(1)2R5A(2)(3)(4)	55	8	55	1567	105	3
2.5	220	C/6032-28	T543C227(1)2R5A(2)(3)(4)	55	8	25	2569	105	3
2.5	220	C/6032-28	T543C227(1)2R5A(2)(3)(4)	55	8	45	1915	105	3
2.5	220	W/7343-15	T543W227(1)2R5A(2)(3)(4)	55	10	25	2683	105	3
2.5	220	V/7343-20	T543V227(1)2R5A(2)(3)(4)	55	10	15	3531	105	3
2.5	220	V/7343-20	T543V227(1)2R5A(2)(3)(4)	55	10	25	2735	105	3
2.5	220	V/7343-20	T543V227(1)2R5A(2)(3)(4)	55	10	45	2039	105	3
2.5	220	D/7343-31	T543D227(1)2R5A(2)(3)(4)	55	10	40	2372	105	3
2.5	330	B/3528-21	T543B337(1)2R5A(2)(3)(4)	83	8	35	1905	105	3
2.5	330	B/3528-21	T543B337(1)2R5A(2)(3)(4)	83	8	45	1680	105	3
2.5	330	B/3528-21	T543B337(1)2R5A(2)(3)(4)	83	8	70	1347	105	3
2.5	330	L/6032-19	T543L337(1)2R5A(2)(3)(4)	83	8	12	3536	105	3
2.5	330	L/6032-19	T543L337(1)2R5A(2)(3)(4)	83	8	25	2449	105	3
2.5	330	C/6032-28	T543C337(1)2R5A(2)(3)(4)	83	8	15	3317	105	3
2.5	330	C/6032-28	T543C337(1)2R5A(2)(3)(4)	83	8	18	3028	105	3
2.5	330	C/6032-28	T543C337(1)2R5A(2)(3)(4)	83	8	25	2569	105	3
2.5	330	C/6032-28	T543C337(1)2R5A(2)(3)(4)	83	8	45	1915	105	3
2.5	330	W/7343-15	T543W337(1)2R5A(2)(3)(4)	83	10	15	3464	105	3
2.5	330	W/7343-15	T543W337(1)2R5A(2)(3)(4)	83	10	25	2683	105	3
2.5	330	W/7343-15	T543W337(1)2R5A(2)(3)(4)	83	10	40	2121	105	3
2.5	330	V/7343-20	T543V337(1)2R5A(2)(3)(4)	83	10	15	3531	105	3
2.5	330	V/7343-20	T543V337(1)2R5A(2)(3)(4)	83	10	18	3223	105	3
2.5	330	V/7343-20	T543V337(1)2R5A(2)(3)(4)	83	10	25	2735	105	3
2.5	330	V/7343-20	T543V337(1)2R5A(2)(3)(4)	83	10	40	2162	105	3
2.5	330	D/7343-31	T543D337(1)2R5A(2)(3)(4)	83	10	6	6124	105	3
2.5	330	D/7343-31	T543D337(1)2R5A(2)(3)(4)	83	10	7	5669	105	3
2.5	330	D/7343-31	T543D337(1)2R5A(2)(3)(4)	83	10	25	3000	105	3
2.5	470	C/6032-28	T543C477(1)2R5A(2)(3)(4)	118	8	25	2569	105	3
2.5	470	C/6032-28	T543C477(1)2R5A(2)(3)(4)	118	8	45	1915	105	3
2.5	470	V/7343-20	T543V477(1)2R5A(2)(3)(4)	118	10	18	3223	105	3
2.5	470	D/7343-31	T543D477(1)2R5A(2)(3)(4)	118	10	5	6708	105	3
2.5	470	D/7343-31	T543D477(1)2R5A(2)(3)(4)	118	10	6	6124	105	3
2.5	470	D/7343-31	T543D477(1)2R5A(2)(3)(4)	118	10	7	5669	105	3
V	μF	KEMET/EIA	(See below for part options)	(μA) @ V _R , 20°C Maximum/ 5 Minutes	% @ 20°C 120 Hz Maximum	(mΩ) @ 20°C 100 kHz Maximum	(mA) 45°C 100 kHz	(°C)	Temperature ≤ 260°C
Rated Voltage	Rated Capacitance	Case Code/ Case Size	KEMET Part Number	DC Leakage	DF	ESR	Maximum Allowable Ripple Current	Rated Temperature	Moisture Sensitivity

- (1) To complete KEMET part number, insert M for ±20%, K for ±10%. Designates capacitance tolerance.
 (2) To complete KEMET part number, H = Solder Plated, T = 100% Tin (Sn). Designates termination finish.
 (3) To complete KEMET part number, insert E = None, S = 10 cycles +25°C, W = 10 cycles -55°C +85°C. Designates surge current option.
 (4) To complete KEMET part number, insert the ESR in mΩ, for example 50 mΩ = 050. Designates ESR option.
 Refer to Ordering Information for additional detail.

Table 1 – Ratings & Part Number Reference cont'd

Rated Voltage	Rated Cap	Case Code/ Case Size	KEMET Part Number	DC Leakage	DF	ESR	Maximum Allowable Ripple Current	Rated Temp	Moisture Sensitivity
V	μF	KEMET/EIA	(See below for part options)	(μA) @ V _R , 20°C Maximum/ 5 Minutes	% @ 20°C 120 Hz Maximum	(mΩ) @ 20°C 100 kHz Maximum	(mA) 45°C 100 kHz	(°C)	Temperature ≤ 260°C
2.5	470	D/7343-31	T543D477(1)2R5A(2)(3)(4)	118	10	9	5000	105	3
2.5	470	D/7343-31	T543D477(1)2R5A(2)(3)(4)	118	10	10	4743	105	3
2.5	470	D/7343-31	T543D477(1)2R5A(2)(3)(4)	118	10	25	3000	105	3
2.5	560	D/7343-31	T543D567(1)2R5A(2)(3)(4)	140	10	5	6708	105	3
2.5	680	D/7343-31	T543D687(1)2R5A(2)(3)(4)	170	10	6	6124	105	3
2.5	680	D/7343-31	T543D687(1)2R5A(2)(3)(4)	170	10	10	4743	105	3
2.5	680	D/7343-31	T543D687(1)2R5A(2)(3)(4)	170	10	15	3873	105	3
2.5	680	D/7343-31	T543D687(1)2R5A(2)(3)(4)	170	10	40	2372	105	3
2.5	680	X/7343-43	T543Y687(1)2R5A(2)(3)(4)	170	10	5	6943	105	3
2.5	680	X/7343-43	T543Y687(1)2R5A(2)(3)(4)	170	10	6	6338	105	3
2.5	680	X/7343-43	T543Y687(1)2R5A(2)(3)(4)	170	10	10	4909	105	3
2.5	680	X/7343-43	T543Y687(1)2R5A(2)(3)(4)	170	10	15	4008	105	3
2.5	680	X/7343-43	T543Y687(1)2R5A(2)(3)(4)	170	10	25	3105	105	3
2.5	680	X/7343-43	T543X687(1)2R5A(2)(3)(4)	170	10	6	6416	105	3
2.5	1000	X/7343-43	T543Y108(1)2R5A(2)(3)(4)	250	10	5	6943	105	3
2.5	1000	X/7343-43	T543Y108(1)2R5A(2)(3)(4)	250	10	6	6338	105	3
2.5	1000	X/7343-43	T543Y108(1)2R5A(2)(3)(4)	250	10	10	4909	105	3
2.5	1000	X/7343-43	T543Y108(1)2R5A(2)(3)(4)	250	10	15	4008	105	3
2.5	1000	X/7343-43	T543Y108(1)2R5A(2)(3)(4)	250	10	25	3105	105	3
2.5	1000	X/7343-43	T543X108(1)2R5A(2)(3)(4)	250	10	5	7029	105	3
2.5	1000	X/7343-43	T543X108(1)2R5A(2)(3)(4)	250	10	6	6416	105	3
2.5	1000	X/7343-43	T543X108(1)2R5A(2)(3)(4)	250	10	10	4970	105	3
2.5	1500	X/7343-43	T543X158(1)2R5A(2)(3)(4)	375	10	5	7029	105	3
2.5	1500	X/7343-43	T543X158(1)2R5A(2)(3)(4)	375	10	10	4970	105	3
3	100	B/3528-21	T543B107(1)003A(2)(3)(4)	30	8	35	1905	105	3
3	100	B/3528-21	T543B107(1)003A(2)(3)(4)	30	8	40	1782	105	3
3	100	B/3528-21	T543B107(1)003A(2)(3)(4)	30	8	70	1347	105	3
3	100	B/3528-21	T543B107(1)003A(2)(3)(4)	30	8	80	1260	105	3
3	150	B/3528-21	T543B157(1)003A(2)(3)(4)	45	8	35	1905	105	3
3	150	B/3528-21	T543B157(1)003A(2)(3)(4)	45	8	40	1782	105	3
3	150	B/3528-21	T543B157(1)003A(2)(3)(4)	45	8	70	1347	105	3
3	150	B/3528-21	T543B157(1)003A(2)(3)(4)	45	8	80	1260	105	3
3	330	V/7343-20	T543V337(1)003A(2)(3)(4)	99	10	15	3531	105	3
3	330	V/7343-20	T543V337(1)003A(2)(3)(4)	99	10	25	2735	105	3
3	330	D/7343-31	T543D337(1)003A(2)(3)(4)	99	10	25	3000	105	3
3	470	D/7343-31	T543D477(1)003A(2)(3)(4)	141	10	10	4743	105	3
3	470	D/7343-31	T543D477(1)003A(2)(3)(4)	141	10	25	3000	105	3
3	680	D/7343-31	T543D687(1)003A(2)(3)(4)	204	10	10	4743	105	3
3	680	D/7343-31	T543D687(1)003A(2)(3)(4)	204	10	15	3873	105	3
3	680	D/7343-31	T543D687(1)003A(2)(3)(4)	204	10	25	3000	105	3
3	680	D/7343-31	T543D687(1)003A(2)(3)(4)	204	10	40	2372	105	3
3	1000	X/7343-43	T543X108(1)003A(2)(3)(4)	300	10	10	4970	105	3
3	1000	X/7343-43	T543X108(1)003A(2)(3)(4)	300	10	15	4058	105	3
3	1000	X/7343-43	T543X108(1)003A(2)(3)(4)	300	10	30	2869	105	3
3	1500	X/7343-43	T543X158(1)003A(2)(3)(4)	450	10	8	5557	105	3
4	15	T/3528-12	T543T156(1)004A(2)(3)(4)	6	8	100	1025	105	3
4	33	A/3216-18	T543A336(1)004A(2)(3)(4)	13	8	70	1265	105	3
4	33	A/3216-18	T543A336(1)004A(2)(3)(4)	13	8	80	1183	105	3
4	47	A/3216-18	T543A476(1)004A(2)(3)(4)	19	8	70	1265	105	3
4	47	A/3216-18	T543A476(1)004A(2)(3)(4)	19	8	80	1183	105	3
4	47	T/3528-12	T543T476(1)004A(2)(3)(4)	19	8	70	1225	105	3
V	μF	KEMET/EIA	(See below for part options)	(μA) @ V _R , 20°C Maximum/ 5 Minutes	% @ 20°C 120 Hz Maximum	(mΩ) @ 20°C 100 kHz Maximum	(mA) 45°C 100 kHz	(°C)	Temperature ≤ 260°C
Rated Voltage	Rated Capacitance	Case Code/ Case Size	KEMET Part Number	DC Leakage	DF	ESR	Maximum Allowable Ripple Current	Rated Temperature	Moisture Sensitivity

(1) To complete KEMET part number, insert M for ±20%, K for ±10%. Designates capacitance tolerance.
 (2) To complete KEMET part number, H = Solder Plated, T = 100% Tin (Sn). Designates termination finish.
 (3) To complete KEMET part number, insert E = None, S = 10 cycles +25°C, W = 10 cycles -55°C +85°C. Designates surge current option.
 (4) To complete KEMET part number, insert the ESR in mΩ, for example 50 mΩ = 050. Designates ESR option.
 Refer to Ordering Information for additional detail.

Table 1 – Ratings & Part Number Reference cont'd

Rated Voltage	Rated Cap	Case Code/ Case Size	KEMET Part Number	DC Leakage	DF	ESR	Maximum Allowable Ripple Current	Rated Temp	Moisture Sensitivity
V	μF	KEMET/EIA	(See below for part options)	(μA) @ V _R , 20°C Maximum/ 5 Minutes	% @ 20°C 120 Hz Maximum	(mΩ) @ 20°C 100 kHz Maximum	(mA) 45°C 100 kHz	(°C)	Temperature ≤ 260°C
4	68	T/3528-12	T543T686(1)004A(2)(3)(4)	27	8	70	1225	105	3
4	68	T/3528-12	T543T686(1)004A(2)(3)(4)	27	8	80	1146	105	3
4	68	B/3528-21	T543B686(1)004A(2)(3)(4)	27	8	35	1905	105	3
4	68	B/3528-21	T543B686(1)004A(2)(3)(4)	27	8	40	1782	105	3
4	68	B/3528-21	T543B686(1)004A(2)(3)(4)	27	8	70	1347	105	3
4	68	B/3528-21	T543B686(1)004A(2)(3)(4)	27	8	80	1260	105	3
4	68	U/6032-15	T543U686(1)004A(2)(3)(4)	27	8	55	1567	105	3
4	100	A/3216-18	T543A107(1)004A(2)(3)(4)	40	8	150	864	105	3
4	100	A/3216-18	T543A107(1)004A(2)(3)(4)	40	8	200	748	105	3
4	100	T/3528-12	T543T107(1)004A(2)(3)(4)	40	8	70	1225	105	3
4	100	T/3528-12	T543T107(1)004A(2)(3)(4)	40	8	150	837	105	3
4	100	B/3528-21	T543B107(1)004A(2)(3)(4)	40	8	35	1905	105	3
4	100	B/3528-21	T543B107(1)004A(2)(3)(4)	40	8	40	1782	105	3
4	100	B/3528-21	T543B107(1)004A(2)(3)(4)	40	8	70	1347	105	3
4	100	B/3528-21	T543B107(1)004A(2)(3)(4)	40	8	80	1260	105	3
4	100	U/6032-15	T543U107(1)004A(2)(3)(4)	40	8	55	1567	105	3
4	150	B/3528-21	T543B157(1)004A(2)(3)(4)	60	8	35	1905	105	3
4	150	B/3528-21	T543B157(1)004A(2)(3)(4)	60	8	40	1782	105	3
4	150	B/3528-21	T543B157(1)004A(2)(3)(4)	60	8	70	1347	105	3
4	150	U/6032-15	T543U157(1)004A(2)(3)(4)	60	8	55	1567	105	3
4	150	C/6032-28	T543C157(1)004A(2)(3)(4)	60	8	15	3317	105	3
4	150	C/6032-28	T543C157(1)004A(2)(3)(4)	60	8	25	2569	105	3
4	150	C/6032-28	T543C157(1)004A(2)(3)(4)	60	8	45	1915	105	3
4	150	C/6032-28	T543C157(1)004A(2)(3)(4)	60	8	100	1285	105	3
4	150	V/7343-20	T543V157(1)004A(2)(3)(4)	60	10	15	3531	105	3
4	150	V/7343-20	T543V157(1)004A(2)(3)(4)	60	10	25	2735	105	3
4	220	B/3528-21	T543B227(1)004A(2)(3)(4)	88	8	35	1905	105	3
4	220	B/3528-21	T543B227(1)004A(2)(3)(4)	88	8	45	1680	105	3
4	220	B/3528-21	T543B227(1)004A(2)(3)(4)	88	8	70	1347	105	3
4	220	L/6032-19	T543L227(1)004A(2)(3)(4)	88	8	12	3536	105	3
4	220	L/6032-19	T543L227(1)004A(2)(3)(4)	88	8	25	2449	105	3
4	220	C/6032-28	T543C227(1)004A(2)(3)(4)	88	8	15	3317	105	3
4	220	C/6032-28	T543C227(1)004A(2)(3)(4)	88	8	18	3028	105	3
4	220	C/6032-28	T543C227(1)004A(2)(3)(4)	88	8	25	2569	105	3
4	220	C/6032-28	T543C227(1)004A(2)(3)(4)	88	8	45	1915	105	3
4	220	C/6032-28	T543C227(1)004A(2)(3)(4)	88	8	55	1732	105	3
4	220	W/7343-15	T543W227(1)004A(2)(3)(4)	88	10	25	2683	105	3
4	220	W/7343-15	T543W227(1)004A(2)(3)(4)	88	10	40	2121	105	3
4	220	V/7343-20	T543V227(1)004A(2)(3)(4)	88	10	15	3531	105	3
4	220	V/7343-20	T543V227(1)004A(2)(3)(4)	88	10	18	3223	105	3
4	220	V/7343-20	T543V227(1)004A(2)(3)(4)	88	10	25	2735	105	3
4	220	V/7343-20	T543V227(1)004A(2)(3)(4)	88	10	40	2162	105	3
4	220	V/7343-20	T543V227(1)004A(2)(3)(4)	88	10	45	2039	105	3
4	220	D/7343-31	T543D227(1)004A(2)(3)(4)	88	10	25	3000	105	3
4	220	D/7343-31	T543D227(1)004A(2)(3)(4)	88	10	65	1861	105	3
4	330	C/6032-28	T543C337(1)004A(2)(3)(4)	132	8	25	2569	105	3
4	330	C/6032-28	T543C337(1)004A(2)(3)(4)	132	8	45	1915	105	3
4	330	V/7343-20	T543V337(1)004A(2)(3)(4)	132	10	18	3223	105	3
4	330	V/7343-20	T543V337(1)004A(2)(3)(4)	132	10	25	2735	105	3
4	330	V/7343-20	T543V337(1)004A(2)(3)(4)	132	10	40	2162	105	3
4	330	D/7343-31	T543D337(1)004A(2)(3)(4)	132	10	5	6708	105	3
Rated Voltage	Rated Capacitance	Case Code/ Case Size	KEMET Part Number	DC Leakage	DF	ESR	Maximum Allowable Ripple Current	Rated Temperature	Moisture Sensitivity

(1) To complete KEMET part number, insert M for ±20%, K for ±10%. Designates capacitance tolerance.
 (2) To complete KEMET part number, H = Solder Plated, T = 100% Tin (Sn). Designates termination finish.
 (3) To complete KEMET part number, insert E = None, S = 10 cycles +25°C, W = 10 cycles -55°C +85°C. Designates surge current option.
 (4) To complete KEMET part number, insert the ESR in mΩ, for example 50 mΩ = 050. Designates ESR option.
 Refer to Ordering Information for additional detail.

Table 1 – Ratings & Part Number Reference cont'd

Rated Voltage	Rated Cap	Case Code/ Case Size	KEMET Part Number	DC Leakage	DF	ESR	Maximum Allowable Ripple Current	Rated Temp	Moisture Sensitivity
V	μF	KEMET/EIA	(See below for part options)	(μA) @ V _R , 20°C Maximum/ 5 Minutes	% @ 20°C 120 Hz Maximum	(mΩ) @ 20°C 100 kHz Maximum	(mA) 45°C 100 kHz	(°C)	Temperature ≤ 260°C
4	330	D/7343-31	T543D337(1)004A(2)(3)(4)	132	10	6	6124	105	3
4	330	D/7343-31	T543D337(1)004A(2)(3)(4)	132	10	7	5669	105	3
4	330	D/7343-31	T543D337(1)004A(2)(3)(4)	132	10	9	5000	105	3
4	330	D/7343-31	T543D337(1)004A(2)(3)(4)	132	10	10	4743	105	3
4	330	D/7343-31	T543D337(1)004A(2)(3)(4)	132	10	12	4330	105	3
4	330	D/7343-31	T543D337(1)004A(2)(3)(4)	132	10	15	3873	105	3
4	330	D/7343-31	T543D337(1)004A(2)(3)(4)	132	10	25	3000	105	3
4	330	D/7343-31	T543D337(1)004A(2)(3)(4)	132	10	40	2372	105	3
4	330	D/7343-31	T543D337(1)004A(2)(3)(4)	132	10	45	2236	105	3
4	470	D/7343-31	T543D477(1)004A(2)(3)(4)	188	10	6	6124	105	3
4	470	D/7343-31	T543D477(1)004A(2)(3)(4)	188	10	10	4743	105	3
4	470	D/7343-31	T543D477(1)004A(2)(3)(4)	188	10	12	4330	105	3
4	470	D/7343-31	T543D477(1)004A(2)(3)(4)	188	10	15	3873	105	3
4	470	D/7343-31	T543D477(1)004A(2)(3)(4)	188	10	18	3536	105	3
4	470	D/7343-31	T543D477(1)004A(2)(3)(4)	188	10	25	3000	105	3
4	470	D/7343-31	T543D477(1)004A(2)(3)(4)	188	10	40	2372	105	3
4	470	X/7343-43	T543Y477(1)004A(2)(3)(4)	188	10	5	6943	105	3
4	470	X/7343-43	T543Y477(1)004A(2)(3)(4)	188	10	6	6338	105	3
4	470	X/7343-43	T543Y477(1)004A(2)(3)(4)	188	10	10	4909	105	3
4	470	X/7343-43	T543Y477(1)004A(2)(3)(4)	188	10	25	3105	105	3
4	470	X/7343-43	T543Y477(1)004A(2)(3)(4)	188	10	40	2455	105	3
4	680	D/7343-31	T543D687(1)004A(2)(3)(4)	272	10	25	3000	105	3
4	680	X/7343-43	T543Y687(1)004A(2)(3)(4)	272	10	5	6943	105	3
4	680	X/7343-43	T543Y687(1)004A(2)(3)(4)	272	10	10	4909	105	3
4	680	X/7343-43	T543Y687(1)004A(2)(3)(4)	272	10	15	4008	105	3
4	680	X/7343-43	T543Y687(1)004A(2)(3)(4)	272	10	25	3105	105	3
4	680	X/7343-43	T543X687(1)004A(2)(3)(4)	272	10	5	7029	105	3
4	680	X/7343-43	T543X687(1)004A(2)(3)(4)	272	10	6	6416	105	3
4	680	X/7343-43	T543X687(1)004A(2)(3)(4)	272	10	10	4970	105	3
4	680	X/7343-43	T543X687(1)004A(2)(3)(4)	272	10	15	4058	105	3
4	680	X/7343-43	T543X687(1)004A(2)(3)(4)	272	10	35	2657	105	3
4	1000	X/7343-43	T543X108(1)004A(2)(3)(4)	400	10	6	6416	105	3
4	1000	X/7343-43	T543X108(1)004A(2)(3)(4)	400	10	10	4970	105	3
6.3	15	T/3528-12	T543T156(1)006A(2)(3)(4)	9	8	100	1025	105	3
6.3	22	A/3216-18	T543A226(1)006A(2)(3)(4)	14	8	90	1116	105	3
6.3	22	A/3216-18	T543A226(1)006A(2)(3)(4)	14	8	100	1058	105	3
6.3	33	A/3216-18	T543A336(1)006A(2)(3)(4)	21	8	70	1265	105	3
6.3	33	A/3216-18	T543A336(1)006A(2)(3)(4)	21	8	80	1183	105	3
6.3	33	A/3216-18	T543A336(1)006A(2)(3)(4)	21	8	120	966	105	3
6.3	33	T/3528-12	T543T336(1)006A(2)(3)(4)	21	8	70	1225	105	3
6.3	33	B/3528-21	T543B336(1)006A(2)(3)(4)	21	8	25	2254	105	3
6.3	33	B/3528-21	T543B336(1)006A(2)(3)(4)	21	8	35	1905	105	3
6.3	33	B/3528-21	T543B336(1)006A(2)(3)(4)	21	8	40	1782	105	3
6.3	33	B/3528-21	T543B336(1)006A(2)(3)(4)	21	8	70	1347	105	3
6.3	33	B/3528-21	T543B336(1)006A(2)(3)(4)	21	8	80	1260	105	3
6.3	33	C/6032-28	T543C336(1)006A(2)(3)(4)	21	8	100	1285	105	3
6.3	47	A/3216-18	T543A476(1)006A(2)(3)(4)	30	8	150	864	105	3
6.3	47	T/3528-12	T543T476(1)006A(2)(3)(4)	30	8	70	1225	105	3
6.3	47	T/3528-12	T543T476(1)006A(2)(3)(4)	30	8	80	1146	105	3
6.3	47	B/3528-21	T543B476(1)006A(2)(3)(4)	30	8	25	2254	105	3
6.3	47	B/3528-21	T543B476(1)006A(2)(3)(4)	30	8	35	1905	105	3
V	μF	KEMET/EIA	(See below for part options)	(μA) @ V _R , 20°C Maximum/ 5 Minutes	% @ 20°C 120 Hz Maximum	(mΩ) @ 20°C 100 kHz Maximum	(mA) 45°C 100 kHz	(°C)	Temperature ≤ 260°C
Rated Voltage	Rated Capacitance	Case Code/ Case Size	KEMET Part Number	DC Leakage	DF	ESR	Maximum Allowable Ripple Current	Rated Temperature	Moisture Sensitivity

(1) To complete KEMET part number, insert M for ±20%, K for ±10%. Designates capacitance tolerance.
 (2) To complete KEMET part number, H = Solder Plated, T = 100% Tin (Sn). Designates termination finish.
 (3) To complete KEMET part number, insert E = None, S = 10 cycles +25°C, W = 10 cycles -55°C +85°C. Designates surge current option.
 (4) To complete KEMET part number, insert the ESR in mΩ, for example 50 mΩ = 050. Designates ESR option.
 Refer to Ordering Information for additional detail.

Table 1 – Ratings & Part Number Reference cont'd

Rated Voltage	Rated Cap	Case Code/ Case Size	KEMET Part Number	DC Leakage	DF	ESR	Maximum Allowable Ripple Current	Rated Temp	Moisture Sensitivity
V	μF	KEMET/EIA	(See below for part options)	(μA) @ V _R , 20°C Maximum/ 5 Minutes	% @ 20°C 120 Hz Maximum	(mΩ) @ 20°C 100 kHz Maximum	(mA) 45°C 100 kHz	(°C)	Temperature ≤ 260°C
6.3	47	B/3528-21	T543B476(1)006A(2)(3)(4)	30	8	40	1782	105	3
6.3	47	B/3528-21	T543B476(1)006A(2)(3)(4)	30	8	70	1347	105	3
6.3	47	B/3528-21	T543B476(1)006A(2)(3)(4)	30	8	80	1260	105	3
6.3	68	A/3216-18	T543A686(1)006A(2)(3)(4)	43	8	150	864	105	3
6.3	68	T/3528-12	T543T686(1)006A(2)(3)(4)	43	8	70	1225	105	3
6.3	68	T/3528-12	T543T686(1)006A(2)(3)(4)	43	8	150	837	105	3
6.3	68	B/3528-21	T543B686(1)006A(2)(3)(4)	43	8	25	2254	105	3
6.3	68	B/3528-21	T543B686(1)006A(2)(3)(4)	43	8	35	1905	105	3
6.3	68	B/3528-21	T543B686(1)006A(2)(3)(4)	43	8	40	1782	105	3
6.3	68	B/3528-21	T543B686(1)006A(2)(3)(4)	43	8	70	1347	105	3
6.3	68	B/3528-21	T543B686(1)006A(2)(3)(4)	43	8	80	1260	105	3
6.3	68	U/6032-15	T543U686(1)006A(2)(3)(4)	43	8	55	1567	105	3
6.3	68	U/6032-15	T543U686(1)006A(2)(3)(4)	43	8	70	1389	105	3
6.3	68	C/6032-28	T543C686(1)006A(2)(3)(4)	43	8	100	1285	105	3
6.3	100	T/3528-12	T543T107(1)006A(2)(3)(4)	63	8	70	1225	105	3
6.3	100	B/3528-21	T543B107(1)006A(2)(3)(4)	63	8	25	2254	105	3
6.3	100	B/3528-21	T543B107(1)006A(2)(3)(4)	63	8	35	1905	105	3
6.3	100	B/3528-21	T543B107(1)006A(2)(3)(4)	63	8	40	1782	105	3
6.3	100	B/3528-21	T543B107(1)006A(2)(3)(4)	63	8	45	1680	105	3
6.3	100	B/3528-21	T543B107(1)006A(2)(3)(4)	63	8	70	1347	105	3
6.3	100	U/6032-15	T543U107(1)006A(2)(3)(4)	63	8	55	1567	105	3
6.3	100	C/6032-28	T543C107(1)006A(2)(3)(4)	63	8	25	2569	105	3
6.3	100	C/6032-28	T543C107(1)006A(2)(3)(4)	63	8	45	1915	105	3
6.3	100	W/7343-15	T543W107(1)006A(2)(3)(4)	63	10	40	2121	105	3
6.3	100	V/7343-20	T543V107(1)006A(2)(3)(4)	63	10	15	3531	105	3
6.3	100	V/7343-20	T543V107(1)006A(2)(3)(4)	63	10	45	2039	105	3
6.3	120	B/3528-21	T543B127(1)006A(2)(3)(4)	76	8	35	1905	105	3
6.3	150	M/3528-15	T543M157(1)006A(2)(3)(4)	95	8	70	1309	105	3
6.3	150	M/3528-15	T543M157(1)006A(2)(3)(4)	95	8	150	894	105	3
6.3	150	B/3528-21	T543B157(1)006A(2)(3)(4)	95	8	25	2254	105	3
6.3	150	B/3528-21	T543B157(1)006A(2)(3)(4)	95	8	35	1905	105	3
6.3	150	B/3528-21	T543B157(1)006A(2)(3)(4)	95	8	45	1680	105	3
6.3	150	B/3528-21	T543B157(1)006A(2)(3)(4)	95	8	70	1347	105	3
6.3	150	U/6032-15	T543U157(1)006A(2)(3)(4)	95	8	45	1732	105	3
6.3	150	U/6032-15	T543U157(1)006A(2)(3)(4)	95	8	55	1567	105	3
6.3	150	L/6032-19	T543L157(1)006A(2)(3)(4)	95	8	12	3536	105	3
6.3	150	L/6032-19	T543L157(1)006A(2)(3)(4)	95	8	25	2449	105	3
6.3	150	C/6032-28	T543C157(1)006A(2)(3)(4)	95	8	15	3317	105	3
6.3	150	C/6032-28	T543C157(1)006A(2)(3)(4)	95	8	25	2569	105	3
6.3	150	C/6032-28	T543C157(1)006A(2)(3)(4)	95	8	45	1915	105	3
6.3	150	C/6032-28	T543C157(1)006A(2)(3)(4)	95	8	55	1732	105	3
6.3	150	W/7343-15	T543W157(1)006A(2)(3)(4)	95	10	25	2683	105	3
6.3	150	W/7343-15	T543W157(1)006A(2)(3)(4)	95	10	40	2121	105	3
6.3	150	V/7343-20	T543V157(1)006A(2)(3)(4)	95	10	15	3531	105	3
6.3	150	V/7343-20	T543V157(1)006A(2)(3)(4)	95	10	18	3223	105	3
6.3	150	V/7343-20	T543V157(1)006A(2)(3)(4)	95	10	25	2735	105	3
6.3	150	V/7343-20	T543V157(1)006A(2)(3)(4)	95	10	40	2162	105	3
6.3	150	V/7343-20	T543V157(1)006A(2)(3)(4)	95	10	45	2039	105	3
6.3	150	D/7343-31	T543D157(1)006A(2)(3)(4)	95	10	15	3873	105	3
6.3	150	D/7343-31	T543D157(1)006A(2)(3)(4)	95	10	25	3000	105	3
6.3	150	D/7343-31	T543D157(1)006A(2)(3)(4)	95	10	55	2023	105	3
V	μF	KEMET/EIA	(See below for part options)	(μA) @ V _R , 20°C Maximum/ 5 Minutes	% @ 20°C 120 Hz Maximum	(mΩ) @ 20°C 100 kHz Maximum	(mA) 45°C 100 kHz	(°C)	Temperature ≤ 260°C
Rated Voltage	Rated Capacitance	Case Code/ Case Size	KEMET Part Number	DC Leakage	DF	ESR	Maximum Allowable Ripple Current	Rated Temperature	Moisture Sensitivity

(1) To complete KEMET part number, insert M for ±20%, K for ±10%. Designates capacitance tolerance.
 (2) To complete KEMET part number, H = Solder Plated, T = 100% Tin (Sn). Designates termination finish.
 (3) To complete KEMET part number, insert E = None, S = 10 cycles +25°C, W = 10 cycles -55°C +85°C. Designates surge current option.
 (4) To complete KEMET part number, insert the ESR in mΩ, for example 50 mΩ = 050. Designates ESR option.
 Refer to Ordering Information for additional detail.

Table 1 – Ratings & Part Number Reference cont'd

Rated Voltage	Rated Cap	Case Code/ Case Size	KEMET Part Number	DC Leakage	DF	ESR	Maximum Allowable Ripple Current	Rated Temp	Moisture Sensitivity
V	μF	KEMET/EIA	(See below for part options)	(μA) @ V _R , 20°C Maximum/ 5 Minutes	% @ 20°C 120 Hz Maximum	(mΩ) @ 20°C 100 kHz Maximum	(mA) 45°C 100 kHz	(°C)	Temperature ≤ 260°C
6.3	220	B/3528-21	T543B227(1)006A(2)(3)(4)	139	8	35	1905	105	3
6.3	220	B/3528-21	T543B227(1)006A(2)(3)(4)	139	8	45	1680	105	3
6.3	220	B/3528-21	T543B227(1)006A(2)(3)(4)	139	8	70	1347	105	3
6.3	220	C/6032-28	T543C227(1)006A(2)(3)(4)	139	8	15	3317	105	3
6.3	220	C/6032-28	T543C227(1)006A(2)(3)(4)	139	8	18	3028	105	3
6.3	220	C/6032-28	T543C227(1)006A(2)(3)(4)	139	8	25	2569	105	3
6.3	220	C/6032-28	T543C227(1)006A(2)(3)(4)	139	8	45	1915	105	3
6.3	220	V/7343-20	T543V227(1)006A(2)(3)(4)	139	10	18	3223	105	3
6.3	220	V/7343-20	T543V227(1)006A(2)(3)(4)	139	10	25	2735	105	3
6.3	220	V/7343-20	T543V227(1)006A(2)(3)(4)	139	10	40	2162	105	3
6.3	220	D/7343-31	T543D227(1)006A(2)(3)(4)	139	10	5	6708	105	3
6.3	220	D/7343-31	T543D227(1)006A(2)(3)(4)	139	10	6	6124	105	3
6.3	220	D/7343-31	T543D227(1)006A(2)(3)(4)	139	10	7	5669	105	3
6.3	220	D/7343-31	T543D227(1)006A(2)(3)(4)	139	10	9	5000	105	3
6.3	220	D/7343-31	T543D227(1)006A(2)(3)(4)	139	10	10	4743	105	3
6.3	220	D/7343-31	T543D227(1)006A(2)(3)(4)	139	10	15	3873	105	3
6.3	220	D/7343-31	T543D227(1)006A(2)(3)(4)	139	10	18	3536	105	3
6.3	220	D/7343-31	T543D227(1)006A(2)(3)(4)	139	10	25	3000	105	3
6.3	220	D/7343-31	T543D227(1)006A(2)(3)(4)	139	10	40	2372	105	3
6.3	220	D/7343-31	T543D227(1)006A(2)(3)(4)	139	10	50	2121	105	3
6.3	330	V/7343-20	T543V337(1)006A(2)(3)(4)	208	10	15	3531	105	3
6.3	330	V/7343-20	T543V337(1)006A(2)(3)(4)	208	10	18	3223	105	3
6.3	330	V/7343-20	T543V337(1)006A(2)(3)(4)	208	10	25	2735	105	3
6.3	330	V/7343-20	T543V337(1)006A(2)(3)(4)	208	10	40	2162	105	3
6.3	330	V/7343-20	T543V337(1)006A(2)(3)(4)	208	10	45	2039	105	3
6.3	330	D/7343-31	T543D337(1)006A(2)(3)(4)	208	10	6	6124	105	3
6.3	330	D/7343-31	T543D337(1)006A(2)(3)(4)	208	10	9	5000	105	3
6.3	330	D/7343-31	T543D337(1)006A(2)(3)(4)	208	10	10	4743	105	3
6.3	330	D/7343-31	T543D337(1)006A(2)(3)(4)	208	10	15	3873	105	3
6.3	330	D/7343-31	T543D337(1)006A(2)(3)(4)	208	10	18	3536	105	3
6.3	330	D/7343-31	T543D337(1)006A(2)(3)(4)	208	10	25	3000	105	3
6.3	330	D/7343-31	T543D337(1)006A(2)(3)(4)	208	10	40	2372	105	3
6.3	330	D/7343-31	T543D337(1)006A(2)(3)(4)	208	10	45	2236	105	3
6.3	330	X/7343-43	T543Y337(1)006A(2)(3)(4)	208	10	5	6943	105	3
6.3	330	X/7343-43	T543Y337(1)006A(2)(3)(4)	208	10	6	6338	105	3
6.3	330	X/7343-43	T543Y337(1)006A(2)(3)(4)	208	10	10	4909	105	3
6.3	330	X/7343-43	T543Y337(1)006A(2)(3)(4)	208	10	15	4008	105	3
6.3	330	X/7343-43	T543Y337(1)006A(2)(3)(4)	208	10	25	3105	105	3
6.3	330	X/7343-43	T543Y337(1)006A(2)(3)(4)	208	10	40	2455	105	3
6.3	470	W/7343-15	T543W477(1)006A(2)(3)(4)	296	10	55	1809	85	3
6.3	470	V/7343-20	T543V477(1)006A(2)(3)(4)	296	10	55	1844	85	3
6.3	470	D/7343-31	T543D477(1)006A(2)(3)(4)	296	10	15	3873	105	3
6.3	470	D/7343-31	T543D477(1)006A(2)(3)(4)	296	10	25	3000	105	3
6.3	470	D/7343-31	T543D477(1)006A(2)(3)(4)	296	10	30	2739	105	3
6.3	470	X/7343-43	T543Y477(1)006A(2)(3)(4)	296	10	5	6943	105	3
6.3	470	X/7343-43	T543Y477(1)006A(2)(3)(4)	296	10	10	4909	105	3
6.3	470	X/7343-43	T543Y477(1)006A(2)(3)(4)	296	10	15	4008	105	3
6.3	470	X/7343-43	T543Y477(1)006A(2)(3)(4)	296	10	18	3659	105	3
6.3	470	X/7343-43	T543Y477(1)006A(2)(3)(4)	296	10	25	3105	105	3
6.3	470	X/7343-43	T543Y477(1)006A(2)(3)(4)	296	10	35	2624	105	3
6.3	470	X/7343-43	T543X477(1)006A(2)(3)(4)	296	10	5	7029	105	3
V	μF	KEMET/EIA	(See below for part options)	(μA) @ V _R , 20°C Maximum/ 5 Minutes	% @ 20°C 120 Hz Maximum	(mΩ) @ 20°C 100 kHz Maximum	(mA) 45°C 100 kHz	(°C)	Temperature ≤ 260°C
Rated Voltage	Rated Capacitance	Case Code/ Case Size	KEMET Part Number	DC Leakage	DF	ESR	Maximum Allowable Ripple Current	Rated Temperature	Moisture Sensitivity

- (1) To complete KEMET part number, insert M for ±20%, K for ±10%. Designates capacitance tolerance.
 (2) To complete KEMET part number, H = Solder Plated, T = 100% Tin (Sn). Designates termination finish.
 (3) To complete KEMET part number, insert E = None, S = 10 cycles +25°C, W = 10 cycles -55°C +85°C. Designates surge current option.
 (4) To complete KEMET part number, insert the ESR in mΩ, for example 50 mΩ = 050. Designates ESR option.
 Refer to Ordering Information for additional detail.

Table 1 – Ratings & Part Number Reference cont'd

Rated Voltage	Rated Cap	Case Code/ Case Size	KEMET Part Number	DC Leakage	DF	ESR	Maximum Allowable Ripple Current	Rated Temp	Moisture Sensitivity
V	μF	KEMET/EIA	(See below for part options)	(μA) @ V _R , 20°C Maximum/ 5 Minutes	% @ 20°C 120 Hz Maximum	(mΩ) @ 20°C 100 kHz Maximum	(mA) 45°C 100 kHz	(°C)	Temperature ≤ 260°C
6.3	470	X/7343-43	T543X477(1)006A(2)(3)(4)	296	10	6	6416	105	3
6.3	470	X/7343-43	T543X477(1)006A(2)(3)(4)	296	10	10	4970	105	3
6.3	470	X/7343-43	T543X477(1)006A(2)(3)(4)	296	10	18	3704	105	3
6.3	470	X/7343-43	T543X477(1)006A(2)(3)(4)	296	10	35	2657	105	3
6.3	470	X/7343-43	T543X477(1)006A(2)(3)(4)	296	10	40	2485	105	3
6.3	680	X/7343-43	T543X687(1)006A(2)(3)(4)	428	10	10	4970	105	3
6.3	680	X/7343-43	T543X687(1)006A(2)(3)(4)	428	10	18	3704	105	3
6.3	1000	D/7343-31	T543H108(1)006A(2)(3)(4)	630	20	55	1844	85	4
6.3	1500	D/7343-31	T543H158(1)006A(2)(3)(4)	945	20	55	1844	85	4
8	33	T/3528-12	T543T336(1)008A(2)(3)(4)	26	8	70	1225	105	3
8	33	T/3528-12	T543T336(1)008A(2)(3)(4)	26	8	80	1146	105	3
8	33	B/3528-21	T543B336(1)008A(2)(3)(4)	26	8	25	2254	105	3
8	33	B/3528-21	T543B336(1)008A(2)(3)(4)	26	8	35	1905	105	3
8	33	B/3528-21	T543B336(1)008A(2)(3)(4)	26	8	40	1782	105	3
8	33	B/3528-21	T543B336(1)008A(2)(3)(4)	26	8	70	1347	105	3
8	33	U/6032-15	T543U336(1)008A(2)(3)(4)	26	8	70	1389	105	3
8	47	B/3528-21	T543B476(1)008A(2)(3)(4)	38	8	35	1905	105	3
8	47	B/3528-21	T543B476(1)008A(2)(3)(4)	38	8	70	1347	105	3
8	150	V/7343-20	T543V157(1)008A(2)(3)(4)	120	10	40	2162	105	3
8	150	D/7343-31	T543D157(1)008A(2)(3)(4)	120	10	25	3000	105	3
8	150	D/7343-31	T543D157(1)008A(2)(3)(4)	120	10	40	2372	105	3
8	150	D/7343-31	T543D157(1)008A(2)(3)(4)	120	10	55	2023	105	3
10	10	A/3216-18	T543A106(1)010A(2)(3)(4)	10	8	80	1183	105	3
10	15	A/3216-18	T543A156(1)010A(2)(3)(4)	15	8	80	1183	105	3
10	22	A/3216-18	T543A226(1)010A(2)(3)(4)	22	8	80	1183	105	3
10	22	B/3528-21	T543B226(1)010A(2)(3)(4)	22	8	80	1260	105	3
10	33	T/3528-12	T543T336(1)010A(2)(3)(4)	33	8	70	1225	105	3
10	33	T/3528-12	T543T336(1)010A(2)(3)(4)	33	8	80	1146	105	3
10	33	B/3528-21	T543B336(1)010A(2)(3)(4)	33	8	25	2254	105	3
10	33	B/3528-21	T543B336(1)010A(2)(3)(4)	33	8	35	1905	105	3
10	33	B/3528-21	T543B336(1)010A(2)(3)(4)	33	8	40	1782	105	3
10	33	B/3528-21	T543B336(1)010A(2)(3)(4)	33	8	70	1347	105	3
10	33	B/3528-21	T543B336(1)010A(2)(3)(4)	33	8	80	1260	105	3
10	33	U/6032-15	T543U336(1)010A(2)(3)(4)	33	8	70	1389	105	3
10	47	B/3528-21	T543B476(1)010A(2)(3)(4)	47	8	35	1905	105	3
10	47	B/3528-21	T543B476(1)010A(2)(3)(4)	47	8	70	1347	105	3
10	47	U/6032-15	T543U476(1)010A(2)(3)(4)	47	8	55	1567	105	3
10	47	C/6032-28	T543C476(1)010A(2)(3)(4)	47	8	100	1285	105	3
10	68	U/6032-15	T543U686(1)010A(2)(3)(4)	68	8	55	1567	105	3
10	68	C/6032-28	T543C686(1)010A(2)(3)(4)	68	8	45	1915	105	3
10	68	W/7343-15	T543W686(1)010A(2)(3)(4)	68	10	25	2683	105	3
10	68	W/7343-15	T543W686(1)010A(2)(3)(4)	68	10	40	2121	105	3
10	68	V/7343-20	T543V686(1)010A(2)(3)(4)	68	10	25	2735	105	3
10	68	V/7343-20	T543V686(1)010A(2)(3)(4)	68	10	40	2162	105	3
10	68	V/7343-20	T543V686(1)010A(2)(3)(4)	68	10	45	2039	105	3
10	68	V/7343-20	T543V686(1)010A(2)(3)(4)	68	10	60	1765	105	3
10	68	V/7343-20	T543V686(1)010A(2)(3)(4)	68	10	100	1367	105	3
10	68	D/7343-31	T543D686(1)010A(2)(3)(4)	68	10	100	1500	105	3
10	100	L/6032-19	T543L107(1)010A(2)(3)(4)	100	8	25	2449	105	3
10	100	C/6032-28	T543C107(1)010A(2)(3)(4)	100	8	25	2569	105	3
10	100	C/6032-28	T543C107(1)010A(2)(3)(4)	100	8	45	1915	105	3
V	μF	KEMET/EIA	(See below for part options)	(μA) @ V _R , 20°C Maximum/ 5 Minutes	% @ 20°C 120 Hz Maximum	(mΩ) @ 20°C 100 kHz Maximum	(mA) 45°C 100 kHz	(°C)	Temperature ≤ 260°C
Rated Voltage	Rated Capacitance	Case Code/ Case Size	KEMET Part Number	DC Leakage	DF	ESR	Maximum Allowable Ripple Current	Rated Temperature	Moisture Sensitivity

(1) To complete KEMET part number, insert M for ±20%, K for ±10%. Designates capacitance tolerance.
 (2) To complete KEMET part number, H = Solder Plated, T = 100% Tin (Sn). Designates termination finish.
 (3) To complete KEMET part number, insert E = None, S = 10 cycles +25°C, W = 10 cycles -55°C +85°C. Designates surge current option.
 (4) To complete KEMET part number, insert the ESR in mΩ, for example 50 mΩ = 050. Designates ESR option.
 Refer to Ordering Information for additional detail.

Table 1 – Ratings & Part Number Reference cont'd

Rated Voltage	Rated Cap	Case Code/ Case Size	KEMET Part Number	DC Leakage	DF	ESR	Maximum Allowable Ripple Current	Rated Temp	Moisture Sensitivity
V	μF	KEMET/EIA	(See below for part options)	(μA) @ V _R , 20°C Maximum/ 5 Minutes	% @ 20°C 120 Hz Maximum	(mΩ) @ 20°C 100 kHz Maximum	(mA) 45°C 100 kHz	(°C)	Temperature ≤ 260°C
10	100	W/7343-15	T543W107(1)010A(2)(3)(4)	100	10	40	2121	105	3
10	100	V/7343-20	T543V107(1)010A(2)(3)(4)	100	10	18	3223	105	3
10	100	V/7343-20	T543V107(1)010A(2)(3)(4)	100	10	25	2735	105	3
10	100	V/7343-20	T543V107(1)010A(2)(3)(4)	100	10	45	2039	105	3
10	100	V/7343-20	T543V107(1)010A(2)(3)(4)	100	10	50	1934	105	3
10	100	D/7343-31	T543D107(1)010A(2)(3)(4)	100	10	18	3536	105	3
10	100	D/7343-31	T543D107(1)010A(2)(3)(4)	100	10	25	3000	105	3
10	100	D/7343-31	T543D107(1)010A(2)(3)(4)	100	10	55	2023	105	3
10	100	D/7343-31	T543D107(1)010A(2)(3)(4)	100	10	80	1677	105	3
10	150	C/6032-28	T543C157(1)010A(2)(3)(4)	150	8	55	1732	105	3
10	150	V/7343-20	T543V157(1)010A(2)(3)(4)	150	10	25	2735	105	3
10	150	V/7343-20	T543V157(1)010A(2)(3)(4)	150	10	40	2162	105	3
10	150	D/7343-31	T543D157(1)010A(2)(3)(4)	150	10	5	6708	105	3
10	150	D/7343-31	T543D157(1)010A(2)(3)(4)	150	10	6	6124	105	3
10	150	D/7343-31	T543D157(1)010A(2)(3)(4)	150	10	10	4743	105	3
10	150	D/7343-31	T543D157(1)010A(2)(3)(4)	150	10	15	3873	105	3
10	150	D/7343-31	T543D157(1)010A(2)(3)(4)	150	10	18	3536	105	3
10	150	D/7343-31	T543D157(1)010A(2)(3)(4)	150	10	25	3000	105	3
10	150	D/7343-31	T543D157(1)010A(2)(3)(4)	150	10	40	2372	105	3
10	150	D/7343-31	T543D157(1)010A(2)(3)(4)	150	10	55	2023	105	3
10	150	X/7343-43	T543Y157(1)010A(2)(3)(4)	150	10	25	3105	105	3
10	150	X/7343-43	T543Y157(1)010A(2)(3)(4)	150	10	18	3659	105	3
10	150	X/7343-43	T543Y157(1)010A(2)(3)(4)	150	10	25	3105	105	3
10	220	V/7343-20	T543V227(1)010A(2)(3)(4)	220	10	25	2735	105	3
10	220	V/7343-20	T543V227(1)010A(2)(3)(4)	220	10	45	2039	105	3
10	220	D/7343-31	T543D227(1)010A(2)(3)(4)	220	10	6	6124	105	3
10	220	D/7343-31	T543D227(1)010A(2)(3)(4)	220	10	10	4743	105	3
10	220	D/7343-31	T543D227(1)010A(2)(3)(4)	220	10	18	3536	105	3
10	220	D/7343-31	T543D227(1)010A(2)(3)(4)	220	10	25	3000	105	3
10	220	D/7343-31	T543D227(1)010A(2)(3)(4)	220	10	40	2372	105	3
10	220	X/7343-43	T543Y227(1)010A(2)(3)(4)	220	10	6	6338	105	3
10	220	X/7343-43	T543Y227(1)010A(2)(3)(4)	220	10	10	4909	105	3
10	220	X/7343-43	T543Y227(1)010A(2)(3)(4)	220	10	40	2455	105	3
10	330	X/7343-43	T543Y337(1)010A(2)(3)(4)	330	10	15	4008	105	3
10	330	X/7343-43	T543Y337(1)010A(2)(3)(4)	330	10	35	2624	105	3
10	330	X/7343-43	T543X337(1)010A(2)(3)(4)	330	10	5	7029	105	3
10	330	X/7343-43	T543X337(1)010A(2)(3)(4)	330	10	6	6416	105	3
10	330	X/7343-43	T543X337(1)010A(2)(3)(4)	330	10	10	4970	105	3
10	330	X/7343-43	T543X337(1)010A(2)(3)(4)	330	10	25	3143	105	3
10	330	X/7343-43	T543X337(1)010A(2)(3)(4)	330	10	40	2485	105	3
12.5	10	T/3528-12	T543T106(1)12RA(2)(3)(4)	13	8	150	837	105	3
12.5	15	T/3528-12	T543T156(1)12RA(2)(3)(4)	19	8	80	1146	105	3
12.5	330	X/7343-43	T543X337(1)12RA(2)(3)(4)	413	10	15	4058	105	3
16	10	B/3528-21	T543B106(1)016A(2)(3)(4)	16	8	100	1127	105	3
16	22	C/6032-28	T543C226(1)016A(2)(3)(4)	35	8	80	1436	105	3
16	33	W/7343-15	T543W336(1)016A(2)(3)(4)	53	10	45	2000	105	3
16	33	V/7343-20	T543V336(1)016A(2)(3)(4)	53	10	45	2039	105	3
16	33	V/7343-20	T543V336(1)016A(2)(3)(4)	53	10	60	1765	105	3
16	33	V/7343-20	T543V336(1)016A(2)(3)(4)	53	10	70	1634	105	3
16	47	W/7343-15	T543W476(1)016A(2)(3)(4)	75	10	45	2000	105	3
16	47	V/7343-20	T543V476(1)016A(2)(3)(4)	75	10	45	2039	105	3
V	μF	KEMET/EIA	(See below for part options)	(μA) @ V _R , 20°C Maximum/ 5 Minutes	% @ 20°C 120 Hz Maximum	(mΩ) @ 20°C 100 kHz Maximum	(mA) 45°C 100 kHz	(°C)	Temperature ≤ 260°C
Rated Voltage	Rated Capacitance	Case Code/ Case Size	KEMET Part Number	DC Leakage	DF	ESR	Maximum Allowable Ripple Current	Rated Temperature	Moisture Sensitivity

(1) To complete KEMET part number, insert M for ±20%, K for ±10%. Designates capacitance tolerance.
 (2) To complete KEMET part number, H = Solder Plated, T = 100% Tin (Sn). Designates termination finish.
 (3) To complete KEMET part number, insert E = None, S = 10 cycles +25°C, W = 10 cycles -55°C +85°C. Designates surge current option.
 (4) To complete KEMET part number, insert the ESR in mΩ, for example 50 mΩ = 050. Designates ESR option.
 Refer to Ordering Information for additional detail.

Table 1 – Ratings & Part Number Reference cont'd

Rated Voltage	Rated Cap	Case Code/ Case Size	KEMET Part Number	DC Leakage	DF	ESR	Maximum Allowable Ripple Current	Rated Temp	Moisture Sensitivity
V	μF	KEMET/EIA	(See below for part options)	(μA) @ V _R , 20°C Maximum/ 5 Minutes	% @ 20°C 120 Hz Maximum	(mΩ) @ 20°C 100 kHz Maximum	(mA) 45°C 100 kHz	(°C)	Temperature ≤ 260°C
16	47	V/7343-20	T543V476(1)016A(2)(3)(4)	75	10	70	1634	105	3
16	47	V/7343-20	T543V476(1)016A(2)(3)(4)	75	10	80	1529	105	3
16	47	D/7343-31	T543D476(1)016A(2)(3)(4)	75	10	35	2535	105	3
16	47	D/7343-31	T543D476(1)016A(2)(3)(4)	75	10	65	1861	105	3
16	47	D/7343-31	T543D476(1)016A(2)(3)(4)	75	10	70	1793	105	3
16	68	V/7343-20	T543V686(1)016A(2)(3)(4)	109	10	50	1934	105	3
16	68	V/7343-20	T543V686(1)016A(2)(3)(4)	109	10	90	1441	105	3
16	100	V/7343-20	T543V107(1)016A(2)(3)(4)	160	10	50	1934	105	3
16	100	D/7343-31	T543D107(1)016A(2)(3)(4)	160	10	35	2535	105	3
16	100	D/7343-31	T543D107(1)016A(2)(3)(4)	160	10	50	2121	105	3
16	150	X/7343-43	T543X157(1)016A(2)(3)(4)	240	10	15	4058	105	3
16	150	X/7343-43	T543X157(1)016A(2)(3)(4)	240	10	25	3143	105	3
16	150	X/7343-43	T543X157(1)016A(2)(3)(4)	240	10	40	2485	105	3
16	150	X/7343-43	T543X157(1)016A(2)(3)(4)	240	10	80	1757	105	3
16	220	X/7343-43	T543X227(1)016A(2)(3)(4)	352	10	35	2657	105	3
16	220	X/7343-43	T543X227(1)016A(2)(3)(4)	352	10	80	1757	105	3
16	330	X/7343-43	T543X337(1)016A(2)(3)(4)	528	10	25	3143	105	3
16	330	X/7343-43	T543X337(1)016A(2)(3)(4)	528	10	50	2223	105	3
20	22	V/7343-20	T543V226(1)020A(2)(3)(4)	44	10	40	2162	105	3
20	22	V/7343-20	T543V226(1)020A(2)(3)(4)	44	10	45	2039	105	3
20	22	V/7343-20	T543V226(1)020A(2)(3)(4)	44	10	90	1441	105	3
20	22	D/7343-31	T543D226(1)020A(2)(3)(4)	44	10	40	2372	105	3
20	22	D/7343-31	T543D226(1)020A(2)(3)(4)	44	10	45	2236	105	3
20	22	D/7343-31	T543D226(1)020A(2)(3)(4)	44	10	90	1581	105	3
20	33	D/7343-31	T543D336(1)020A(2)(3)(4)	66	10	60	1936	105	3
20	47	V/7343-20	T543V476(1)020A(2)(3)(4)	94	10	55	1844	105	3
20	47	V/7343-20	T543V476(1)020A(2)(3)(4)	94	10	90	1441	105	3
20	47	D/7343-31	T543D476(1)020A(2)(3)(4)	94	10	55	2023	105	3
20	100	X/7343-43	T543X107(1)020A(2)(3)(4)	200	10	35	2657	105	3
20	100	X/7343-43	T543X107(1)020A(2)(3)(4)	200	10	50	2223	105	3
25	15	V/7343-20	T543V156(1)025A(2)(3)(4)	38	10	90	1441	105	3
25	15	D/7343-31	T543D156(1)025A(2)(3)(4)	38	10	60	1936	105	3
25	15	D/7343-31	T543D156(1)025A(2)(3)(4)	38	10	80	1677	105	3
25	22	V/7343-20	T543V226(1)025A(2)(3)(4)	55	10	60	1765	105	3
25	22	V/7343-20	T543V226(1)025A(2)(3)(4)	55	10	90	1441	105	3
25	33	V/7343-20	T543V336(1)025A(2)(3)(4)	83	10	60	1765	105	3
25	33	D/7343-31	T543D336(1)025A(2)(3)(4)	83	10	60	1936	105	3
25	68	X/7343-43	T543X686(1)025A(2)(3)(4)	170	10	35	2657	105	3
25	68	X/7343-43	T543X686(1)025A(2)(3)(4)	170	10	50	2223	105	3
25	100	X/7343-43	T543X107(1)025A(2)(3)(4)	250	10	60	2029	105	3
35	15	V/7343-20	T543V156(1)035A(2)(3)(4)	53	10	100	1367	105	3
35	15	V/7343-20	T543V156(1)035A(2)(3)(4)	53	10	125	1223	105	3
35	15	D/7343-31	T543D156(1)035A(2)(3)(4)	53	10	100	1500	105	3
35	15	D/7343-31	T543D156(1)035A(2)(3)(4)	53	10	125	1342	105	3
35	33	X/7343-43	T543X336(1)035A(2)(3)(4)	116	10	65	1949	105	3
35	47	X/7343-43	T543X476(1)035A(2)(3)(4)	165	10	30	2869	105	3
35	47	X/7343-43	T543X476(1)035A(2)(3)(4)	165	10	60	2029	105	3
50	5.6	D/7343-31	T543D565(1)050A(2)(3)(4)	28	10	70	1793	105	3
50	5.6	D/7343-31	T543D565(1)050A(2)(3)(4)	28	10	90	1581	105	3
50	10	D/7343-31	T543D106(1)050A(2)(3)(4)	50	10	90	1581	105	3
50	12	X/7343-43	T543X126(1)050A(2)(3)(4)	60	10	45	2343	105	3
V	μF	KEMET/EIA	(See below for part options)	(μA) @ V _R , 20°C Maximum/ 5 Minutes	% @ 20°C 120 Hz Maximum	(mΩ) @ 20°C 100 kHz Maximum	(mA) 45°C 100 kHz	(°C)	Temperature ≤ 260°C
Rated Voltage	Rated Capacitance	Case Code/ Case Size	KEMET Part Number	DC Leakage	DF	ESR	Maximum Allowable Ripple Current	Rated Temperature	Moisture Sensitivity

(1) To complete KEMET part number, insert M for ±20%, K for ±10%. Designates capacitance tolerance.
 (2) To complete KEMET part number, H = Solder Plated, T = 100% Tin (Sn). Designates termination finish.
 (3) To complete KEMET part number, insert E = None, S = 10 cycles +25°C, W = 10 cycles -55°C +85°C. Designates surge current option.
 (4) To complete KEMET part number, insert the ESR in mΩ, for example 50 mΩ = 050. Designates ESR option.
 Refer to Ordering Information for additional detail.

Table 1 – Ratings & Part Number Reference cont'd

Rated Voltage	Rated Cap	Case Code/ Case Size	KEMET Part Number	DC Leakage	DF	ESR	Maximum Allowable Ripple Current	Rated Temp	Moisture Sensitivity
V	μF	KEMET/EIA	(See below for part options)	(μA) @ V _R , 20°C Maximum/ 5 Minutes	% @ 20°C 120 Hz Maximum	(mΩ) @ 20°C 100 kHz Maximum	(mA) 45°C 100 kHz	(°C)	Temperature ≤ 260°C
50	12	X/7343-43	T543X126(1)050A(2)(3)(4)	60	10	70	1878	105	3
50	18	X/7343-43	T543X186(1)050A(2)(3)(4)	90	10	35	2657	105	3
50	18	X/7343-43	T543X186(1)050A(2)(3)(4)	90	10	70	1878	105	3
50	22	X/7343-43	T543X226(1)050A(2)(3)(4)	110	10	40	2485	105	3
50	22	X/7343-43	T543X226(1)050A(2)(3)(4)	110	10	75	1815	105	3
50	33	X/7343-43	T543X336(1)050A(2)(3)(4)	165	10	40	2485	105	3
50	33	X/7343-43	T543X336(1)050A(2)(3)(4)	165	10	75	1815	105	3
50	10	D/7343-31	T543D106(1)050A(2)(3)(4)	50	10	100	1572	105	3
50	10	D/7343-31	T543D106(1)050A(2)(3)(4)	50	10	120	1435	105	3
50	18	X/7343-43	T543X186(1)050A(2)(3)(4)	90	10	70	1878	105	3
63	4.7	D/7343-31	T543D475(1)063A(2)(3)(4)	30	10	100	1572	105	3
63	4.7	D/7343-31	T543D475(1)063A(2)(3)(4)	30	10	120	1435	105	3
63	10	X/7343-43	T543X106(1)063A(2)(3)(4)	63	10	75	1815	105	3
63	10	X/7343-43	T543X106(1)063A(2)(3)(4)	63	10	100	1572	105	3
63	10	X/7343-43	T543X106(1)063A(2)(3)(4)	63	10	150	1283	105	3
63	15	X/7343-43	T543X156(1)063A(2)(3)(4)	95	10	50	2223	105	3
V	μF	KEMET/EIA	(See below for part options)	(μA) @ V _R , 20°C Maximum/ 5 Minutes	% @ 20°C 120 Hz Maximum	(mΩ) @ 20°C 100 kHz Maximum	(mA) 45°C 100 kHz	(°C)	Temperature ≤ 260°C
Rated Voltage	Rated Capacitance	Case Code/ Case Size	KEMET Part Number	DC Leakage	DF	ESR	Maximum Allowable Ripple Current	Rated Temperature	Moisture Sensitivity

- (1) To complete KEMET part number, insert M for ±20%, K for ±10%. Designates capacitance tolerance.
 (2) To complete KEMET part number, H = Solder Plated, T = 100% Tin (Sn). Designates termination finish.
 (3) To complete KEMET part number, insert E = None, S = 10 cycles +25°C, W = 10 cycles -55°C +85°C. Designates surge current option.
 (4) To complete KEMET part number, insert the ESR in mΩ, for example 50 mΩ = 050. Designates ESR option.
 Refer to Ordering Information for additional detail.

Derating Guidelines

Voltage Rating	Maximum Recommended Steady State Voltage	Maximum Recommended Transient Voltage (1 ms – 1 μs)
-55°C to 105°C		
$2.5\text{ V} \leq V_R \leq 10\text{ V}$	90% of V_R	V_R
$12.5\text{ V} \leq V_R \leq 63\text{ V}$	80% of V_R	V_R

V_R = Rated Voltage

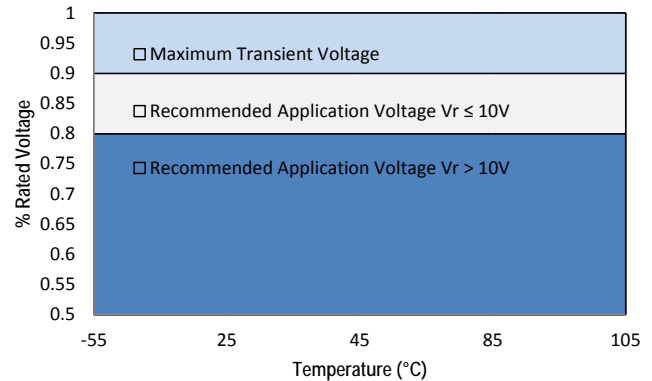

Ripple Current/Ripple Voltage

Permissible AC ripple voltage and current are related to equivalent series resistance (ESR) and the power dissipation capabilities of the device. Permissible AC ripple voltage which may be applied is limited by two criteria:

1. The positive peak AC voltage plus the DC bias voltage, if any, must not exceed the DC voltage rating of the capacitor.
2. The negative peak AC voltage in combination with bias voltage, if any, must not exceed the allowable limits specified for reverse voltage. See the Reverse Voltage section for allowable limits.

The maximum power dissipation by case size can be determined using the table at right. The maximum power dissipation rating stated in the table must be reduced with increasing environmental operating temperatures. Refer to the table below for temperature compensation requirements.

Temperature Compensation Multipliers for Maximum Power Dissipation		
$\leq 45^\circ\text{C}$	$45^\circ\text{C} < T \leq 85^\circ\text{C}$	$85^\circ\text{C} < T \leq 125^\circ\text{C}$
1.00	0.70	0.25

T = Environmental Temperature

Using the P_{max} of the device, the maximum allowable rms ripple current or voltage may be determined.

$$I(max) = \sqrt{P_{max}/R}$$

$$E(max) = \sqrt{P_{max} \cdot R}$$

I = rms ripple current (amperes)

E = rms ripple voltage (volts)

P_{max} = maximum power dissipation (watts)

R = ESR at specified frequency (ohms)

Case Code	EIA Case Code	Maximum Power Dissipation (P_{max}) mWatts @ 45°C with $+30^\circ\text{C}$ Rise
T	3528-12	105
M	3528-15	120
A	3216-18	112
B	3528-21	127
U	6032-15	135
L	3528-19	150
C	6032-28	165
W	7343-15	180
V	7343-20	187
D	7343-31	225
Y	7343-40	241
X	7343-43	247
H	7360-20	187
I	3216-10	95

The maximum power dissipation rating must be reduced with increasing environmental operating temperatures. Refer to the Temperature Compensation Multiplier table for details.

Reverse Voltage

Polymer tantalum capacitors are polar devices and may be permanently damaged or destroyed if connected in the wrong polarity. These devices will withstand a small degree of transient voltage reversal for short periods as shown in the below table.

Temperature	Permissible Transient Reverse Voltage
25°C	15% of Rated Voltage
55°C	10% of Rated Voltage
85°C	5% of Rated Voltage
105°C	3% of Rated Voltage
125°C*	1% of Rated Voltage

*For series rated to 125°C

Table 2 – Land Dimensions/Courtyard

KEMET	Metric Size Code	Density Level A: Maximum (Most) Land Protrusion (mm)					Density Level B: Median (Nominal) Land Protrusion (mm)					Density Level C: Minimum (Least) Land Protrusion (mm)				
		Case	EIA	X	Y	C	V1	V2	X	Y	C	V1	V2	X	Y	C
A	3216-18	1.35	2.15	1.45	6.10	2.80	1.25	1.75	1.35	5.00	2.30	1.15	1.35	1.25	4.10	2.00
B	3528-21	2.35	2.15	1.45	6.10	4.00	2.25	1.75	1.35	5.00	3.50	2.15	1.35	1.25	4.10	3.20
C	6032-25	2.35	2.65	2.60	8.90	4.40	2.25	2.25	2.50	7.80	3.90	2.15	1.85	2.40	6.90	3.60
D	7343-31	2.55	3.75	2.70	10.20	5.50	2.45	3.35	2.60	9.10	5.00	2.35	2.95	2.50	8.20	4.70
H	7360-20	4.25	2.65	3.20	10.10	7.20	4.15	2.25	3.30	9.40	6.70	4.05	1.85	3.00	8.10	6.40
L	6032-19	2.35	2.65	2.60	8.90	4.40	2.25	2.25	2.50	7.80	3.90	2.15	1.85	2.40	6.90	3.60
M	3528-15	2.35	2.15	1.45	6.10	4.00	2.25	1.75	1.35	5.00	3.70	2.15	1.35	1.25	4.10	3.40
T	3528-12	2.35	2.15	1.45	6.10	4.00	2.25	1.75	1.35	5.00	3.50	2.15	1.35	1.25	4.10	3.20
U	6032-15	2.35	2.65	2.60	8.90	4.40	2.25	2.25	2.50	7.80	3.90	2.15	1.85	2.40	6.90	3.60
V	7343-20	2.55	3.75	2.70	10.20	5.50	2.45	3.35	2.60	9.10	5.00	2.35	2.95	2.50	8.20	4.70
W	7343-15	2.55	3.75	2.70	10.20	5.50	2.45	3.35	2.60	9.10	5.00	2.35	2.95	2.50	8.20	4.70
X ¹	7343-43	2.55	3.75	2.70	10.20	5.50	2.45	3.35	2.60	9.10	5.00	2.35	2.95	2.50	8.20	4.70
Y ¹	7343-40	2.55	3.75	2.70	10.20	5.50	2.45	3.35	2.60	9.10	5.00	2.35	2.95	2.50	8.20	4.70

Density Level A: For low-density product applications. Recommended for wave solder applications and provides a wider process window for reflow solder processes.

Density Level B: For products with a moderate level of component density. Provides a robust solder attachment condition for reflow solder processes.

Density Level C: For high component density product applications. Before adapting the minimum land pattern variations the user should perform qualification testing based on the conditions outlined in IPC Standard 7351 (IPC-7351).

¹ Height of these chips may create problems in wave soldering.

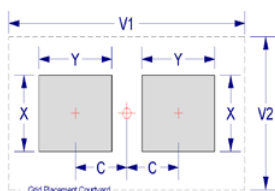

Soldering Process

KEMET's families of surface mount capacitors are compatible with wave (single or dual), convection, IR, or vapor phase reflow techniques. Preheating of these components is recommended to avoid extreme thermal stress. KEMET's recommended profile conditions for convection and IR reflow reflect the profile conditions of the IPC/J-STD-020D standard for moisture sensitivity testing. The devices can safely withstand a maximum of three reflow passes at these conditions.

Please note that although the X/7343-43 case size can withstand wave soldering, the tall profile (4.3 mm maximum) dictates care in wave process development.

Hand soldering should be performed with care due to the difficulty in process control. If performed, care should be taken to avoid contact of the soldering iron to the molded case. The iron should be used to heat the solder pad, applying solder between the pad and the termination, until reflow occurs. Once reflow occurs, the iron should be removed immediately. "Wiping" the edges of a chip and heating the top surface is not recommended.

During typical reflow operations, a slight darkening of the gold-colored epoxy may be observed. This slight darkening is normal and not harmful to the product. Marking permanency is not affected by this change.

Profile Feature	SnPb Assembly	Pb-Free Assembly
Preheat/Soak		
Temperature Minimum (T_{Smin})	100°C	150°C
Temperature Maximum (T_{Smax})	150°C	200°C
Time (t_s) from T_{Smin} to T_{Smax}	60 – 120 seconds	60 – 120 seconds
Ramp-up Rate (T_L to T_P)	3°C/seconds maximum	3°C/seconds maximum
Liquidous Temperature (T_L)	183°C	217°C
Time Above Liquidous (t_L)	60 – 150 seconds	60 – 150 seconds
Peak Temperature (T_P)	220°C* 235°C**	250°C* 260°C**
Time within 5°C of Maximum Peak Temperature (t_p)	20 seconds maximum	30 seconds maximum
Ramp-down Rate (T_P to T_L)	6°C/seconds maximum	6°C/seconds maximum
Time 25°C to Peak Temperature	6 minutes maximum	8 minutes maximum

Note: All temperatures refer to the center of the package, measured on the package body surface that is facing up during assembly reflow.

*Case Size D, E, P, Y, and X

**Case Size A, B, C, H, I, K, M, R, S, T, U, V, W, and Z

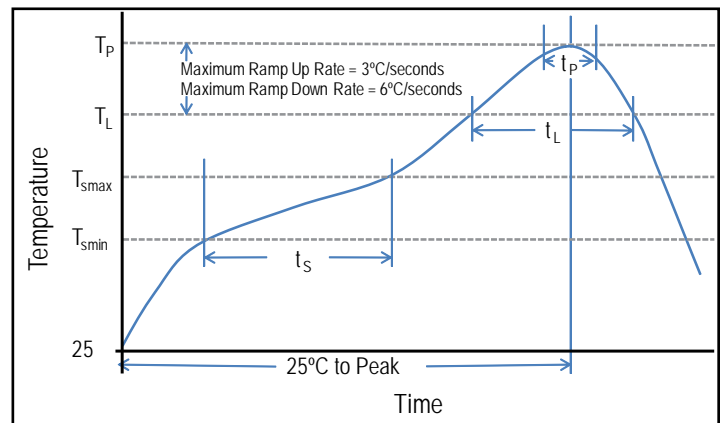

Construction

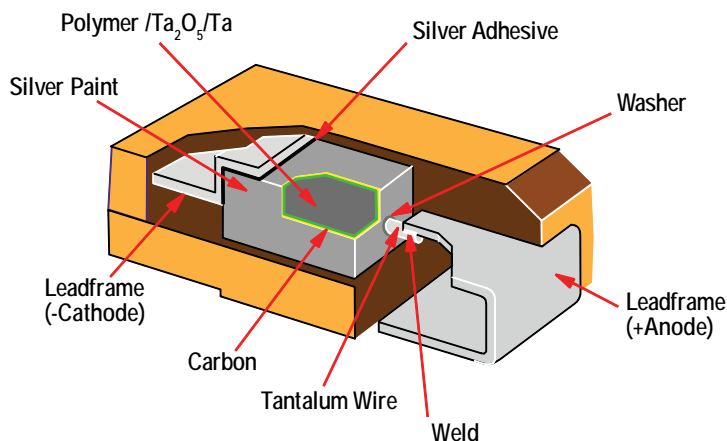

Capacitor Marking

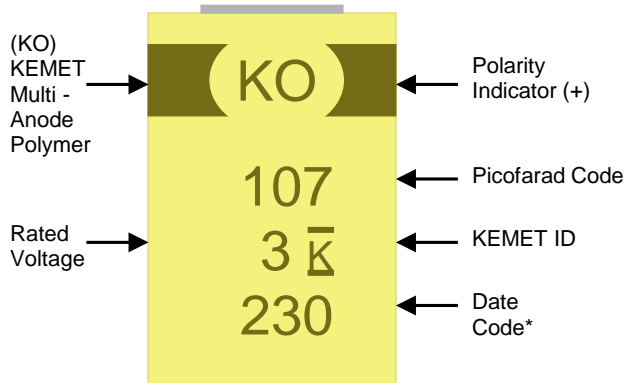

* 230 = 30th week of 2012

Date Code *	
1 st digit = Last number of Year	9 = 2009 0 = 2010 1 = 2011 2 = 2012 3 = 2013 4 = 2014
2 nd and 3 rd digit = Week of the Year	01 = 1 st week of the Year to 52 = 52 nd week of the Year

Storage

All KO-CAP Series are shipped in moisture barrier bags with a desiccant and moisture indicator card. These series are classified as MSL3 (Moisture Sensitivity Level 3). Product contained within the moisture barrier bags should be stored in normal working environments with temperatures not to exceed 40°C and humidity not in excess of 60% RH.

Overview

The KEMET Organic Capacitor is a tantalum capacitor with a Ta anode and Ta₂O₅ dielectric. A conductive organic polymer replaces the traditionally used MnO₂ as the cathode plate of the capacitor. This results in very low ESR and improved capacitance retention at high frequency. The polymer technology also exhibits a benign failure mode which eliminates the ignition failures that can occur in standard MnO₂ tantalum types. Ta polymers may be operated at voltages up to 90% of rated voltage for part types with rated voltages of ≤ 10 volts and up to 80% of rated voltage for part types > 10 volts with equivalent or better reliability than traditional MnO₂ tantalum capacitors operated at 50% of rated voltage.

The T545 Series was developed to deliver the highest energy per CC of any tantalum surface mount device (SMD). This capability makes this capacitor an excellent solution for designs requiring high energy at relatively low voltages, such as data hardening or data vaulting for solid state drives (SSD's). The T545 Series High Energy Polymer Tantalum Surface Mount Capacitor captures the best features of multilayer ceramic capacitors (low ESR and high frequency capacitance retention), aluminum electrolytic capacitors (higher capacitance and benign failure mode) and proven solid tantalum technology (volumetric efficiency, surface mount capability and extremely long life). In addition, this series is subjected to 100% thermal shock and voltage aging to insure long term reliability.

Benefits

- Extremely low ESR
- High energy delivery capability
- -55°C to 125°C operating temperature range
- Polymer cathode technology
- High frequency capacitance retention
- Non-ignition failure mode
- Capacitance up to 1,500 µF
- Voltage: 6.3 – 16 V
- 100% accelerated steady state aging
- 100% surge current tested
- 100% thermal shock
- Volumetric efficiency, very high capacitance
- Self-healing mechanism
- Taped and reeled per EIA 481-1, EIA standard case sizes

Applications

Typical applications include hold-up, data hardening or vaulting for enterprise and military SSDs, and high end desktop modems.



Environmental Compliance

RoHS Compliant (6/6) according to Directive 2002/95/EC when ordered with 100% Sn solder.



RoHS Compliant

SPICE

For a detailed analysis of specific part numbers, please visit www.kemet.com for a free download of KEMET's SPICE software. The KEMET SPICE program is freeware intended to aid design engineers in analyzing the performance of these capacitors over frequency, temperature, ripple, and DC bias conditions.

Ordering Information

T	545	H	108	M	006	A	T	E055
Capacitor Class	Series	Case Size	Capacitance Code (pF)	Capacitance Tolerance	Voltage	Failure Rate/Design	Lead Material	ESR
T = Tantalum	High Energy Polymer Tantalum	D, H, V, W, X, Y	First two digits represent significant figures. Third digit specifies number of zeros.	M = $\pm 20\%$	006 = 6.3 V 010 = 10 V 016 = 16 V	A = N/A	T = 100% Tin (Sn)	ESR in m Ω

Performance Characteristics

Item	Performance Characteristics
Operating Temperature	-55°C to 125°C
Rated Capacitance Range	47 μF – 1,500 μF @ 120 Hz/25°C
Capacitance Tolerance	M Tolerance (20%)
Rated Voltage Range	6.3 – 16 V
DF (120 Hz)	Refer to Part Number Electrical Specification Table
ESR (100 kHz)	Refer to Part Number Electrical Specification Table
Leakage Current	$\leq 0.1 \text{ CV}$ (μA) at rated voltage after 5 minutes

Qualification

Test	Condition	Characteristics				
Endurance	85°C @ rated voltage, 2,000 hours**	Δ C/C	Within -20/+10 of initial value			
		DF	Within initial limits			
		DCL	Within 1.25 x initial limit			
		ESR	Within 2.0 x initial limit			
Storage Life	85°C @ 0 volts, 2,000 hours**	Δ C/C	Within -20/+10 of initial value			
		DF	Within initial limits			
		DCL	Within 1.25 x initial limit			
		ESR	Within 2.0 x initial limit			
Humidity	60°C, 90% RH, 500 hours	Δ C/C	Within -5%/+35% of initial value			
		DF	Within initial limits			
		DCL	Within 5.0 x initial limit			
		ESR	Within 2.0 x initial limit			
Temperature Stability	Extreme temperature exposure at a succession of continuous steps at +25°C, -55°C, +25°C, +85°C, +25° C	+25°C	-55°C	+85°C		
		Δ C/C	IL*	+/-20%	+/-20%	
		DF	IL	IL	1.2 x IL	
		DCL	IL	n/a	10 x IL	
		Surge Voltage	85°C, 1.32 x rated voltage, 1,000 cycles	Δ C/C	Within -20/+10 of initial value	
				DF	Within initial limits	
DCL	Within initial limits					
ESR	Within initial limits					
Mechanical Shock/Vibration	MIL-STD-202, Method 213, Condition I, 100 G peak MIL-STD-202, Method 204, Condition D, 10 Hz to 2,000 Hz, 20 G peak	Δ C/C	Within ±10 of initial value			
		DF	Within initial limits			
		DCL	Within initial limits			

*IL = Initial limit

**Minimum temperature test condition 85°C

Electrical Characteristics

ESR vs. Frequency

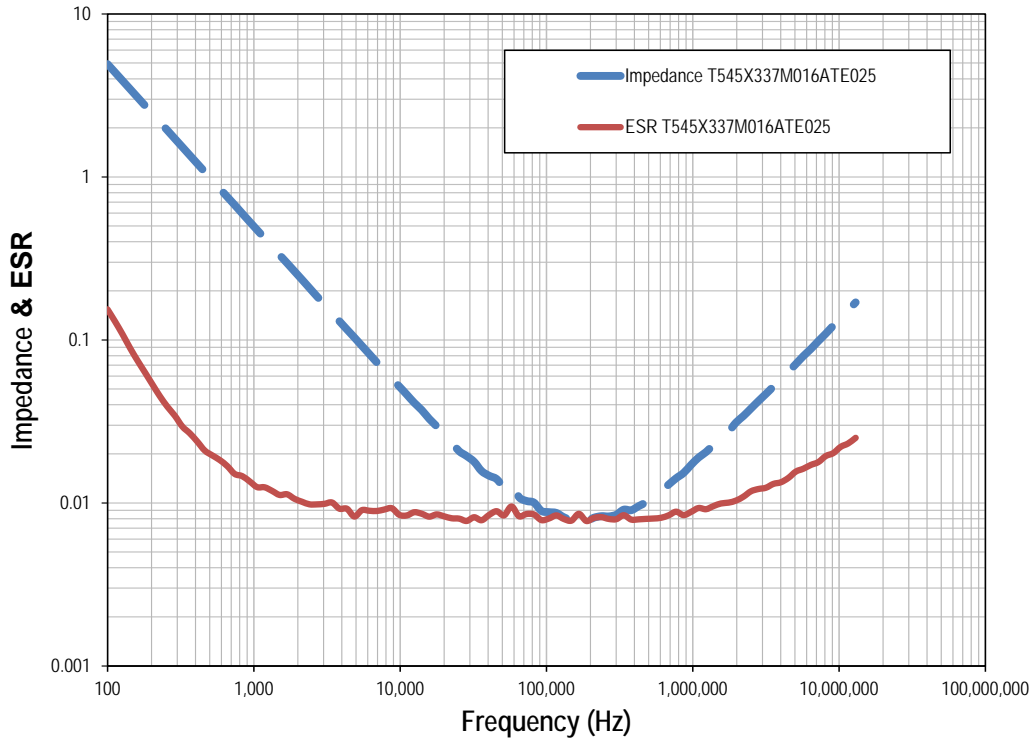

Capacitance vs. Frequency

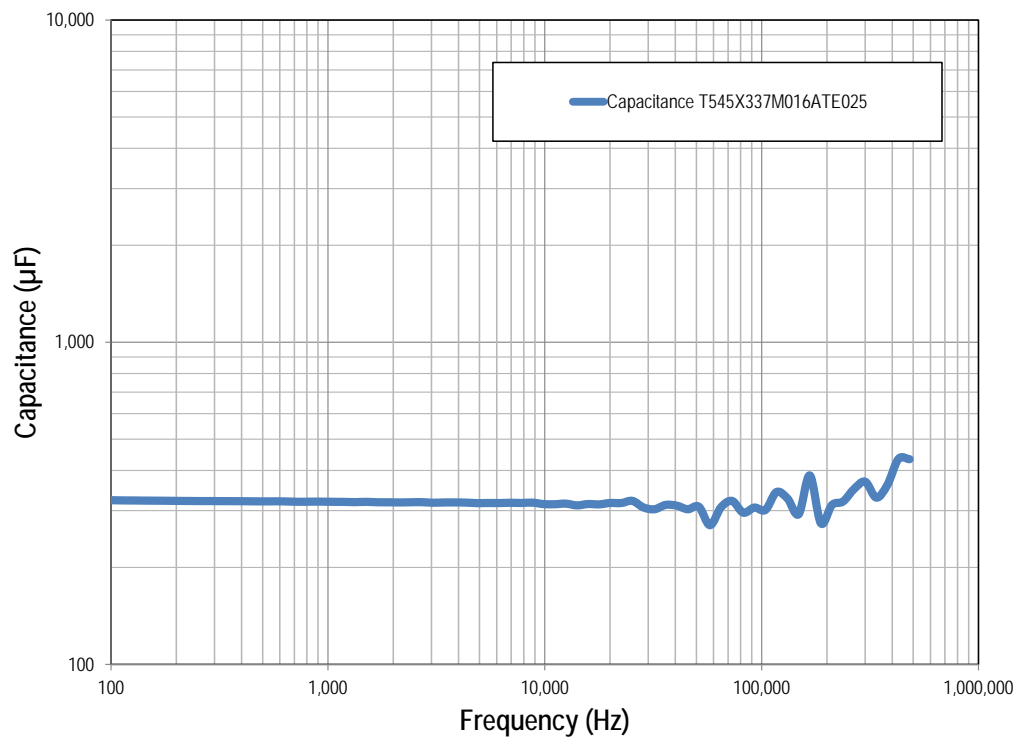

Dimensions – Millimeters

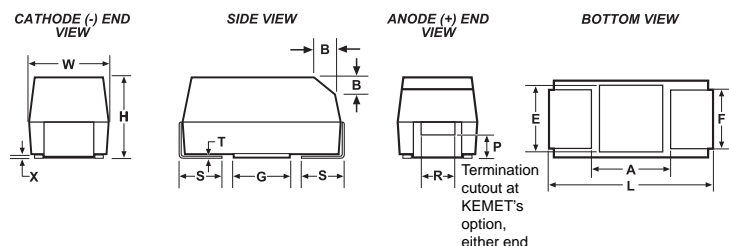

Case Size		Component												
KEMET	EIA	L*	W*	H*	F* ±0.1 ±(0.004)	S* ±0.3 ±(0.012)	B* ±0.15 (Ref) ±0.006	X (Ref)	P (Ref)	R (Ref)	T (Ref)	A (Min)	G (Ref)	E (Ref)
D	7343-31	7.3 ±0.3 (0.287 ±0.012)	4.3 ±0.3 (0.169 ±0.012)	2.8 ±0.3 (0.110 ±0.012)	2.4 (.094)	1.3 (.051)	0.5 (.020)	0.10 ± 0.10 (.004 ± .004)	0.9 (.035)	1.0 (.039)	0.13 (.005)	3.8 (.150)	3.5 (.138)	3.5 (.138)
H	7360-20	7.3 ±0.3 (0.287 ±0.012)	6.0 ±0.3 (0.236 ±0.012)	2.0 (0.078) Maximum	4.1 (.161)	1.3 (.051)	n/a	0.10 ± 0.10 (.004 ± .004)	n/a	n/a	0.13 (.005)	3.3 (.130)	3.5 (.138)	3.5 (.138)
V	7343-20	7.3 ±0.3 (0.287 ±0.012)	4.3 ±0.3 (0.169 ±0.012)	2.0 (0.079)	2.4 (.094)	1.3 (.051)	n/a	0.05 (.002)	n/a	n/a	0.13 (.005)	3.8 (.150)	3.5 (.138)	3.5 (.138)
W	7343-15	7.3 ±0.3 (0.287 ±0.012)	4.3 ±0.3 (0.169 ±0.012)	1.5 (0.059)	2.4 (.094)	1.3 (.051)	n/a	0.05 (.002)	n/a	n/a	0.13 (.005)	3.8 (.150)	3.5 (.138)	3.5 (.138)
X	7343-43	7.3 ±0.3 (0.287 ±0.012)	4.3 ±0.3 (0.169 ±0.012)	4.0 ±0.3 (0.157 ±0.012)	2.4 (.094)	1.3 (.051)	0.5 (.020)	0.10 ± 0.10 (.004 ± .004)	1.7 (.067)	1.0 (.039)	0.13 (.005)	3.8 (.150)	3.5 (.138)	3.5 (.138)
Y	7343-40	7.3 ±0.3 (0.287 ±0.012)	4.3 ±0.3 (0.169 ±0.012)	4.0 (0.157)	2.4 (.094)	1.3 (.051)	0.5 (.020)	0.10 ± 0.10 (.004 ± .004)	1.7 (.067)	1.0 (.039)	0.13 (.005)	3.8 (.150)	3.5 (.138)	3.5 (.138)

Notes: (Ref) – Dimensions provided for reference only. No dimensions are provided for B, P or R because low profile cases do not have a bevel or a notch.

* MIL-PRF-55365/8 specified dimensions

Table 1 – Ratings & Part Number Reference

Rated Voltage	Rated Capacitance	Case Code/ Case Size	KEMET Part Number	DC Leakage	DF	ESR	Maximum Allowable Ripple Current	MSL	Rated Temperature	Energy (mJ)
V	µF	KEMET/EIA		(µA) @ V _R , 20°C Maximum/ 5 Minutes	% @ 20°C 120 Hz Maximum	(mΩ) @ 20°C 100 kHz Maximum	(mA) 45°C 100 kHz	Reflow Temperature ≤ 260°C	(°C)	(½CVa²) - (½CVd²) Va = Voltage Applied Vd = Voltage Drop
6.3	1000	H/7360-20	T545H108M006ATE055	630.0	20	55	1850.0	4	85	11.57
6.3	1500	H/7360-20	T545H158M006ATE035	945.0	20	35	2300.0	4	85	17.36
6.3	1500	H/7360-20	T545H158M006ATE055	945.0	20	55	1850.0	4	85	17.36
6.3	470	W/7343-15	T545W477M006ATE035	296.0	10	35	2300.0	4	105	5.44
6.3	470	W/7343-15	T545W477M006ATE055	296.0	10	55	1800.0	4	105	5.44
6.3	470	Y/7343-40	T545Y477M006ATE025	296.0	10	25	3100.0	3	105	5.44
6.3	470	X/7343-43	T545X477M006ATE006	296.0	10	6	6700.0	3	125	5.44
10	100	W/7343-15	T545W107M010ATE040	100.0	10	40	2100.0	4	105	3.60
10	330	Y/7343-40	T545Y337M010ATE035	330.0	10	35	2600.0	3	105	11.88
10	330	X/7343-43	T545X337M010ATE006	330.0	10	6	6700.0	3	125	11.88
16	47	W/7343-15	T545W476M016ATE045	75.0	10	45	2000.0	3	105	3.64
16	220	X/7343-43	T545X227M016ATE035	352.0	10	35	2700.0	3	125	17.03
16	330	X/7343-43	T545X337M016ATE025	528.0	10	25	3300.0	3	125	25.55
16	100	V/7343-20	T545V107M016ATE055	160.0	10	55	1850.0	3	105	7.74
16	100	D/7343-31	T545D107M016ATE055	160.0	10	55	2050.0	3	105	7.74
Rated Voltage	Rated Capacitance	Case Code/ Case Size	KEMET Part Number	DC Leakage	DF	ESR	Maximum Allowable Ripple Current	MSL	Rated Temperature	Energy (mJ)

Derating Guidelines

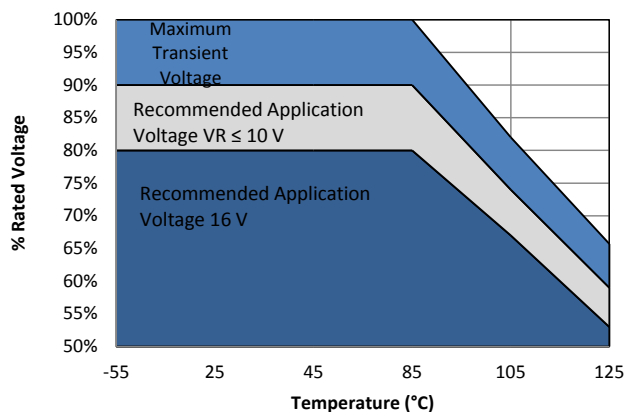

Voltage Rating	Maximum Recommended Steady State Voltage	Maximum Recommended Transient Voltage (1 ms – 1 μ s)	Maximum Recommended Steady State Voltage	Maximum Recommended Transient Voltage (1 ms – 1 μ s)
	-55°C to 105°C		105°C to 125°C	
$6.3 \text{ V} \leq V_R \leq 10 \text{ V}$	90% of V_R	V_R	60% of V_R	V_R
$V_R \leq 16 \text{ V}$	80% of V_R	V_R	54% of V_R	V_R

V_R = Rated Voltage

Ripple Current/Ripple Voltage

Permissible AC ripple voltage and current are related to equivalent series resistance (ESR) and the power dissipation capabilities of the device. Permissible AC ripple voltage which may be applied is limited by two criteria:

1. The positive peak AC voltage plus the DC bias voltage, if any, must not exceed the DC voltage rating of the capacitor.
2. The negative peak AC voltage in combination with bias voltage, if any, must not exceed the allowable limits specified for reverse voltage. See the Reverse Voltage section for allowable limits.

The maximum power dissipation by case size can be determined using the table at right. The maximum power dissipation rating stated in the table must be reduced with increasing environmental operating temperatures. Refer to the table below for temperature compensation requirements.

Temperature Compensation Multipliers for Maximum Power Dissipation		
≤ 45°C	45° C < T ≤ 85°C	85°C < T ≤ 125°C
1.00	0.70	0.25

T= Environmental Temperature

Using the P max of the device, the maximum allowable rms ripple current or voltage may be determined.

$$I(max) = \sqrt{P_{max}/R}$$

$$E(max) = \sqrt{P_{max} \cdot R}$$

I = rms ripple current (amperes)

E = rms ripple voltage (volts)

P max = maximum power dissipation (watts)

R = ESR at specified frequency (ohms)

Case Code	EIA Case Code	Maximum Power Dissipation (P max) mWatts @ 45°C with +30°C Rise
T	3528-12	105
M	3528-15	120
A	3216-18	112
B	3528-21	127
U	6032-15	135
L	3528-19	150
C	6032-28	165
W	7343-15	180
V	7343-20	187
D	7343-31	225
Y	7343-40	241
X	7343-43	247
H	7360-20	187
I	3216-10	95

The maximum power dissipation rating must be reduced with increasing environmental operating temperatures. Refer to the Temperature Compensation Multiplier table for details.

Reverse Voltage

Polymer tantalum capacitors are polar devices and may be permanently damaged or destroyed if connected in the wrong polarity. These devices will withstand a small degree of transient voltage reversal for short periods as shown in the below table.

Temperature	Permissible Transient Reverse Voltage
25°C	15% of Rated Voltage
55°C	10% of Rated Voltage
85°C	5% of Rated Voltage

Table 2 – Land Dimensions/Courtyard

KEMET	Metric Size Code	Density Level A: Maximum (Most) Land Protrusion (mm)					Density Level B: Median (Nominal) Land Protrusion (mm)					Density Level C: Minimum (Least) Land Protrusion (mm)					
		Case	EIA	X	Y	C	V1	V2	X	Y	C	V1	V2	X	Y	C	V1
D	7343-31		2.55	3.75	2.70	10.20	5.50	2.45	3.35	2.60	9.10	5.00	2.35	2.95	2.50	8.20	4.70
H	7360-20		4.25	2.65	3.20	10.10	7.20	4.15	2.25	3.30	9.40	6.70	4.05	1.85	3.00	8.10	6.40
V	7343-20		2.55	3.75	2.70	10.20	5.50	2.45	3.35	2.60	9.10	5.00	2.35	2.95	2.50	8.20	4.70
W	7343-15		2.55	3.75	2.70	10.20	5.50	2.45	3.35	2.60	9.10	5.00	2.35	2.95	2.50	8.20	4.70
X ¹	7343-43		2.55	3.75	2.70	10.20	5.50	2.45	3.35	2.60	9.10	5.00	2.35	2.95	2.50	8.20	4.70
Y ¹	7343-40		2.55	3.75	2.70	10.20	5.50	2.45	3.35	2.60	9.10	5.00	2.35	2.95	2.50	8.20	4.70

Density Level A: For low-density product applications. Recommended for wave solder applications and provides a wider process window for reflow solder processes.

Density Level B: For products with a moderate level of component density. Provides a robust solder attachment condition for reflow solder processes.

Density Level C: For high component density product applications. Before adapting the minimum land pattern variations the user should perform qualification testing based on the conditions outlined in IPC Standard 7351 (IPC-7351).

¹ Height of these chips may create problems in wave soldering.

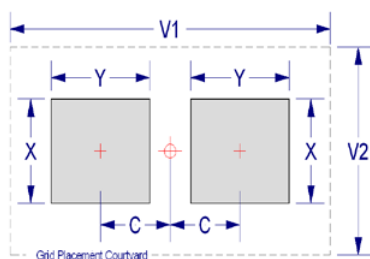

Soldering Process

KEMET's families of surface mount capacitors are compatible with wave (single or dual), convection, IR, or vapor phase reflow techniques. Preheating of these components is recommended to avoid extreme thermal stress. KEMET's recommended profile conditions for convection and IR reflow reflect the profile conditions of the IPC/J-STD-020D standard for moisture sensitivity testing. The devices can safely withstand a maximum of three reflow passes at these conditions.

Please note that although the X/7343-43 case size can withstand wave soldering, the tall profile (4.3 mm maximum) dictates care in wave process development.

Hand soldering should be performed with care due to the difficulty in process control. If performed, care should be taken to avoid contact of the soldering iron to the molded case. The iron should be used to heat the solder pad, applying solder between the pad and the termination, until reflow occurs. Once reflow occurs, the iron should be removed immediately. "Wiping" the edges of a chip and heating the top surface is not recommended.

During typical reflow operations, a slight darkening of the gold-colored epoxy may be observed. This slight darkening is normal and not harmful to the product. Marking permanency is not affected by this change.

Profile Feature	SnPb Assembly	Pb-Free Assembly
Preheat/Soak		
Temperature Minimum (T_{smin})	100°C	150°C
Temperature Maximum (T_{smax})	150°C	200°C
Time (t_s) from T_{smin} to T_{smax}	60 – 120 seconds	60 – 120 seconds
Ramp-up Rate (T_L to T_P)	3°C/seconds maximum	3°C/seconds maximum
Liquidous Temperature (T_L)	183°C	217°C
Time Above Liquidous (t_L)	60 – 150 seconds	60 – 150 seconds
Peak Temperature (T_P)	220°C* 235°C**	250°C* 260°C**
Time within 5°C of Maximum Peak Temperature (t_p)	20 seconds maximum	30 seconds maximum
Ramp-down Rate (T_P to T_L)	6°C/seconds maximum	6°C/seconds maximum
Time 25°C to Peak Temperature	6 minutes maximum	8 minutes maximum

Note: All temperatures refer to the center of the package, measured on the package body surface that is facing up during assembly reflow.

*Case Size D, E, P, Y, and X

**Case Size A, B, C, H, I, K, M, R, S, T, U, V, W, and Z

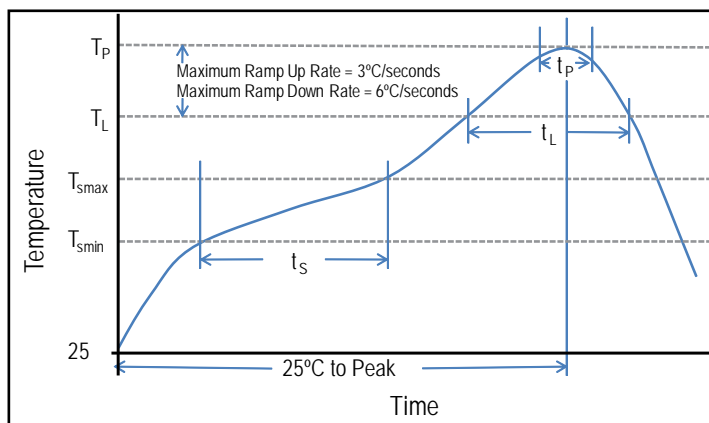

Construction

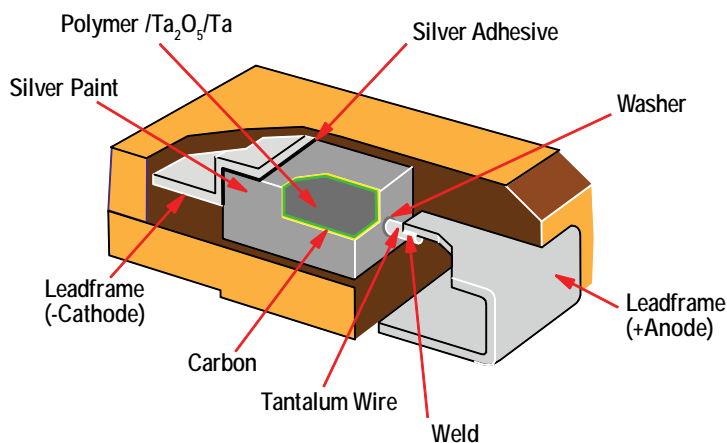

Overview

The KEMET Tantalum Stack Polymer (TSP) Series is designed to provide the highest capacitance/voltage ratings in surface mount configuration. KEMET's T540 Polymer COTS capacitors are utilized in stacks of 2,3,4 and 6 components to achieve a broad range of capacitance and voltage ratings. The T540 COTS series offers component level surge current testing options and standard and low ESR options. As with other KEMET Polymer product, this series may be operated at steady state voltages

up to 90% of rated voltage for part types with rated voltages of \leq 10 volts and up to 80% of rated voltage for part types $>$ 10 volts. Stacking configurations offer this Polymer COTS product with custom capacitance/voltage solutions and very low ESR options.

Note: Custom stacking solutions are available with other KEMET Tantalum Surface Mount Series. Please contact KEMET Product Management for availability.

Benefits

- Polymer cathode technology
- High capacitance
- Surface mountable
- Capacitance values of 66 μ F to 4080 μ F
- Capacitance can be custom specified
- Voltage ratings of 3 VDC to 16 VDC
- High volumetric efficiency
- Ultra low ESR
- Surge capability
- Operating temperature range of -55°C to +125°C
- Laser-marked case
- Use up to 90% of rated voltage for part types \leq 10 volts
- Use up to 80% of rated voltage for part types $>$ 10 volts

Applications

Typical applications include decoupling and filtering in a variety of market segments. The T540 Polymer COTS stack devices can be utilized in military and aerospace applications. Other KEMET series can be utilized in filtering and decoupling applications to service various market segments.



Environmental Compliance

RoHS Compliant (6/6) according to Directive 2002/95/EC when ordered with 100% Sn solder.



RoHS Compliant

SPICE

For a detailed analysis of specific part numbers, please visit www.kemet.com for a free download of KEMET's SPICE software. The KEMET SPICE program is freeware intended to aid design engineers in analyzing the performance of these capacitors over frequency, temperature, ripple, and DC bias conditions.

Ordering Information

T	SP	2D	207	M	010	A	H	65	20	D540
Capacitor Class	Series	Case Size	Capacitance Code (pF)	Capacitance Tolerance	Voltage	Failure Rate/Design	Lead Material	Surge	ESR	C-Spec 2
T = Tantalum	Stacks Polymer Cathode	2B, 3B, 4B, 6B, 2D, 3D, 4D, 6D	First two digits represent significant figures. Third digit specifies number of zeros.	M = $\pm 20\%$	003 = 3 V 004 = 4 V 006 = 6.3 V 010 = 10 V 016 = 16 V	A = N/A	H = Standard Solder Coated (SnPb 5% Pb minimum)	65 = No Surge 66 = 10 cycles @ 25°C 67 = 10 cycles -55°C and 85°C	10 = ESR - Standard 20 = ESR-Low	Designates discrete component series. D540 = T540

Note: These TSP Stacks are specific to T540 COTS.

Performance Characteristics

Item	Performance Characteristics
Operating Temperature	-55°C to 125°C
Rated Capacitance Range	66 – 4080 μ F @ 120 Hz/25° C
Capacitance Tolerance	M Tolerance (20%)
Rated Voltage Range	3 – 16 V
DF (120 Hz)	Refer to Part Number Electrical Specification Table
ESR (100 kHz)	Refer to Part Number Electrical Specification Table
Leakage Current	≤ 0.1 CV (mA) at rated voltage after 5 minutes

Qualification

Test	Condition	Characteristics	
Endurance	105°C @ rated voltage, 2,000 hours 125°C @ 2/3 rated voltage, 2,000 hours	Δ C/C	Within -20/+10% of initial value
		DF	≤ initial limit
		DCL	1.25 x IL @125° C
		ESR	2 x initial limit
Thermal Shock	KEMET specified test, mounted, -55°C to 125° C, 5 cycles	Δ C/C	Within ±5% of initial value
		DF	Within initial limits
		DCL	Within 1.25 x initial limit
		ESR	Within initial limits
Surge Voltage	85° C, 1.15 x rated voltage 1,000 cycles	Δ C/C	Within ±5% of initial value
		DF	Within initial limits
		DCL	Within initial limits
		ESR	Within initial limits
Surge Voltage	125°C, 0.77 x rated voltage 1,000 cycles	Δ C/C	Within ±5% of initial value
		DF	Within initial limits
		DCL	Within initial limits
		ESR	Within initial limits
Mechanical Vibration	MIL-STD-202, Method 204, Condition D, 10 Hz to 2,000 Hz, 20 G peak	Δ C/C	Within ±10 of initial value
		DF	Within initial limits
		DCL	Within initial limits

Dimensions – Millimeters (Inches)

Metric will govern

TSP2

KEMET 2 Component Stack Dimensions						
Case Code	L	W	H	W2	H2	P
2B	4.1 ± 0.38 (.162 ± .015)	3.1 ± 0.2 (.122 ± .008)	4.3 ± 0.38 (.170 ± .015)	2.3 ± 0.2 (.090 ± .008)	3.1 ± 0.38 (.124 ± .015)	0.76 ± 0.38 (.030 ± .015)
2D	8.0 ± 0.38 (.315 ± .015)	4.4 ± 0.2 (.174 ± .008)	6.2 ± 0.38 (.245 ± .015)	3.0 ± 0.2 (.120 ± .008)	4.8 ± 0.38 (.192 ± .015)	1.9 ± 0.38 (.075 ± .015)



TSP3

KEMET 3 Component Stack Dimensions						
Case Code	L	W	H	W2	H2	P
3B	4.1 ± 0.38 (.162 ± .015)	3.1 ± 0.2 (.122 ± .008)	6.3 ± 0.38 (.248 ± .015)	2.3 ± 0.2 (.090 ± .008)	5.3 ± 0.38 (.210 ± .015)	0.76 ± 0.38 (.030 ± .015)
3D	8.0 ± 0.38 (.315 ± .015)	4.4 ± 0.2 (.174 ± .008)	9.2 ± 0.38 (.365 ± .015)	3.0 ± 0.2 (.120 ± .008)	7.7 ± 0.38 (.304 ± .015)	1.9 ± 0.38 (.075 ± .015)

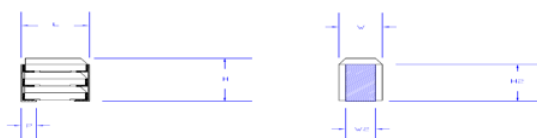

TSP4

KEMET 4 Component Stack Dimensions						
Case Code	L	W	H	W2	H2	P
4B	4.1 ± 0.38 (.162 ± .015)	6.1 ± 0.2 (.242 ± .008)	4.3 ± 0.38 (.170 ± .015)	5.3 ± 0.2 (.210 ± .008)	3.1 ± 0.38 (.124 ± .015)	0.76 ± 0.38 (.030 ± .015)
4D	8.0 ± 0.38 (.315 ± .015)	8.9 ± 0.2 (.350 ± .008)	6.2 ± 0.38 (.245 ± .015)	7.4 ± 0.2 (.292 ± .008)	4.8 ± 0.38 (.192 ± .015)	1.9 ± 0.38 (.075 ± .015)

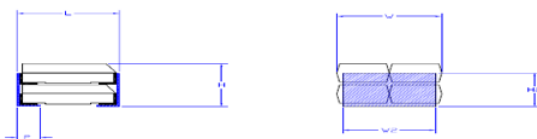

TSP6

KEMET 6 Component Stack Dimensions						
Case Code	L	W	H	W2	H2	P
6B	4.1 ± 0.38 (.162 ± .015)	6.1 ± 0.2 (.242 ± .008)	6.3 ± 0.38 (.248 ± .015)	5.3 ± 0.2 (.210 ± .008)	5.3 ± 0.38 (.210 ± .015)	0.76 ± 0.38 (.030 ± .015)
6D	8.0 ± 0.38 (.315 ± .015)	8.9 ± 0.2 (.350 ± .008)	9.2 ± 0.38 (.365 ± .015)	7.4 ± 0.2 (.292 ± .008)	7.7 ± 0.38 (.304 ± .015)	1.9 ± 0.38 (.075 ± .015)

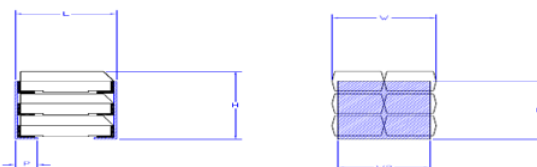

Capacitance and Rated Voltage Chart

Capacitance		Rated Voltage				
μF	Code	3	4	6.3	10	16
66	666				2B	
94	946					2D
99	996				3B	
132	137				4B	
136	137			2B		
141	147					3D
188	197					4D
198	207				6B	
200	207		2B		2D	
204	207			3B		
272	277			4B		
282	287					6D
300	307		3B		2D	
400	407		4B		4D	
408	407			6B		
440	447		2D		2D	
450	457	3B				
600	607	4B	6B			
660	667	2D		2D	3D	
880	887		4D		4D	
900	907	6B			6D	
940	947		2D			
990	997			3D		
1320	138			4D	6D	
1360	148	2D				
1410	148		3D			
1880	198		4D			
1980	208			6D		
2040	208	3D				
2720	278	4D				
2820	288		6D			
4080	418	6D				

Table 1A – TSP2 Ratings & Part Number Reference

Rated Voltage	Rated Capacitance	Case Code/ Case Size	KEMET Part Number	DC Leakage	DF	Standard ESR	Low ESR
V	µF	KEMET/EIA	(See below for part options)	µA @ +20°C Max/5 Min	% @ +20°C 120 Hz Max	mΩ +25°C 100 kHz Max	mΩ +25°C 100 kHz Max
4	200	2B	TSP2B207M004AH(1)(2)D540	80	8	40.0	N/A
6.3	136	2B	TSP2B137M006AH(1)(2)D540	86	8	40.0	N/A
10	66	2B	TSP2B666M010AH(1)(2)D540	66	8	40.0	N/A
3	660	2D	TSP2D667M003AH(1)(2)D540	198	10	12.5	N/A
3	1360	2D	TSP2D148M003AH(1)(2)D540	408	10	12.5	N/A
4	440	2D	TSP2D447M004AH(1)(2)D540	176	10	12.5	N/A
4	940	2D	TSP2D947M004AH(1)(2)D540	376	10	20	12.5
6.3	660	2D	TSP2D667M006AH(1)(2)D540	416	10	20	12.5
10	200	2D	TSP2D207M010AH(1)(2)D540	200	10	27.5	12.5
10	300	2D	TSP2D307M010AH(1)(2)D540	300	10	27.5	12.5
10	440	2D	TSP2D447M010AH(1)(2)D540	440	10	12.5	N/A
16	94	2D	TSP2D946M016AH(1)(2)D540	152	10	32.5	17.5
V	µF	KEMET/EIA	(See below for part options)	µA @ +20°C Max/5 Min	% @ +20°C 120 Hz Max	mΩ +25°C 100 kHz Max	mΩ +25°C 100 kHz Max
Rated Voltage	Rated Capacitance	Case Code/ Case Size	KEMET Part Number	DC Leakage	DF	Standard ESR	Low ESR

Table 1B – TSP3 Ratings & Part Number Reference

Rated Voltage	Rated Capacitance	Case Code/ Case Size	KEMET Part Number	DC Leakage	DF	Standard ESR	Low ESR
V	µF	KEMET/EIA	(See below for part options)	µA @ +20°C Max/5 Min	% @ +20°C 120 Hz Max	mΩ +25°C 100 kHz Max	mΩ +25°C 100 kHz Max
3	450	3B	TSP3B457M003AH(1)(2)D540	135	8	26.7	N/A
4	300	3B	TSP3B307M004AH(1)(2)D540	120	8	26.7	N/A
6.3	204	3B	TSP3B207M006AH(1)(2)D540	129	8	26.7	N/A
10	99	3B	TSP3B996M010AH(1)(2)D540	99	8	26.7	N/A
3	2040	3D	TSP3D208M003AH(1)(2)D540	612	10	8.3	N/A
4	1410	3D	TSP3D148M004AH(1)(2)D540	564	10	13.3	8.3
6.3	990	3D	TSP3D997M006AH(1)(2)D540	624	10	13.3	8.3
10	660	3D	TSP3D667M010AH(1)(2)D540	660	10	8.3	N/A
16	141	3D	TSP3D147M016AH(1)(2)D540	226	10	21.7	11.7
V	µF	KEMET/EIA	(See below for part options)	µA @ +20°C Max/5 Min	% @ +20°C 120 Hz Max	mΩ +25°C 100 kHz Max	mΩ +25°C 100 kHz Max
Rated Voltage	Rated Capacitance	Case Code/ Case Size	KEMET Part Number	DC Leakage	DF	Standard ESR	Low ESR

(1) To complete KEMET part number, insert 65 = None, 66 = 10 cycles +25°C, 67 = 10 cycles -55°C +85°C. Designates surge current option.

(2) To complete KEMET part number, insert 10 = Standard ESR, 20 = Low ESR. Designates ESR option.

Refer to Ordering Information for additional detail.

Table 1C – TSP4 Ratings & Part Number Reference

Rated Voltage	Rated Capacitance	Case Code/ Case Size	KEMET Part Number	DC Leakage	DF	Standard ESR	Low ESR
V	μF	KEMET/EIA	(See below for part options)	μA @ +20°C Max/5 Min	% @ +20°C 120 Hz Max	mΩ +25°C 100 kHz Max	mΩ +25°C 100 kHz Max
3	600	4B	TSP4B607M003AH(1)(2)D540	180	8	20.0	N/A
4	400	4B	TSP4B407M004AH(1)(2)D540	160	8	20.0	N/A
6.3	272	4B	TSP4B277M006AH(1)(2)D540	172	8	20.0	N/A
10	132	4B	TSP4B137M010AH(1)(2)D540	132	8	20.0	N/A
3	2720	4D	TSP4D278M003AH(1)(2)D540	816	10	6.25	N/A
4	880	4D	TSP4D887M004AH(1)(2)D540	352	10	6.25	N/A
4	1880	4D	TSP4D198M004AH(1)(2)D540	752	10	10	6.25
6.3	1320	4D	TSP4D138M006AH(1)(2)D540	832	10	10	6.25
10	400	4D	TSP4D407M010AH(1)(2)D540	400	10	13.75	6.25
10	880	4D	TSP4D887M010AH(1)(2)D540	880	10	6.25	N/A
16	188	4D	TSP4D197M016AH(1)(2)D540	301	10	16.25	8.75
V	μF	KEMET/EIA	(See below for part options)	μA @ +20°C Max/5 Min	% @ +20°C 120 Hz Max	mΩ +25°C 100 kHz Max	mΩ +25°C 100 kHz Max
Rated Voltage	Rated Capacitance	Case Code/ Case Size	KEMET Part Number	DC Leakage	DF	Standard ESR	Low ESR

Table 1D – TSP6 Ratings & Part Number Reference

Rated Voltage	Rated Capacitance	Case Code/ Case Size	KEMET Part Number	DC Leakage	DF	Standard ESR	Low ESR
V	μF	KEMET/EIA	(See below for part options)	μA @ +20°C Max/5 Min	% @ +20°C 120 Hz Max	mΩ +25°C 100 kHz Max	mΩ +25°C 100 kHz Max
3	900	6B	TSP6B907M003AH(1)(2)D540	270	8	13.3	N/A
4	600	6B	TSP6B607M004AH(1)(2)D540	240	8	13.3	N/A
6.3	408	6B	TSP6B407M006AH(1)(2)D540	258	8	13.3	N/A
10	198	6B	TSP6B207M010AH(1)(2)D540	198	8	13.3	N/A
3	4080	6D	TSP6D418M003AH(1)(2)D540	1224	10	4.2	N/A
4	2820	6D	TSP6D288M004AH(1)(2)D540	1128	10	6.7	4.2
6.3	1980	6D	TSP6D208M006AH(1)(2)D540	1248	10	6.7	4.2
10	900	6D	TSP6D907M010AH(1)(2)D540	900	10	9.2	4.2
10	1320	6D	TSP6D138M010AH(1)(2)D540	1320	10	4.2	N/A
16	282	6D	TSP6D287M016AH(1)(2)D540	452	10	10.8	5.8
V	μF	KEMET/EIA	(See below for part options)	μA @ +20°C Max/5 Min	% @ +20°C 120 Hz Max	mΩ +25°C 100 kHz Max	mΩ +25°C 100 kHz Max
Rated Voltage	Rated Capacitance	Case Code/ Case Size	KEMET Part Number	DC Leakage	DF	Standard ESR	Low ESR

(1) To complete KEMET part number, insert 65 = None, 66 = 10 cycles +25°C, 67 = 10 cycles -55°C +85°C. Designates surge current option.

(2) To complete KEMET part number, insert 10 = Standard ESR, 20 = Low ESR. Designates ESR option.

Refer to Ordering Information for additional detail.

Derating Guidelines

Voltage Rating	Maximum Recommended Steady State Voltage	Maximum Recommended Transient Voltage (1 ms – 1 μ s)
-55°C to 105°C		
$10 V \leq V_R$	90% of V_R	V_R
$V_R > 10$	80% of V_R	V_R

V_R = Rated Voltage

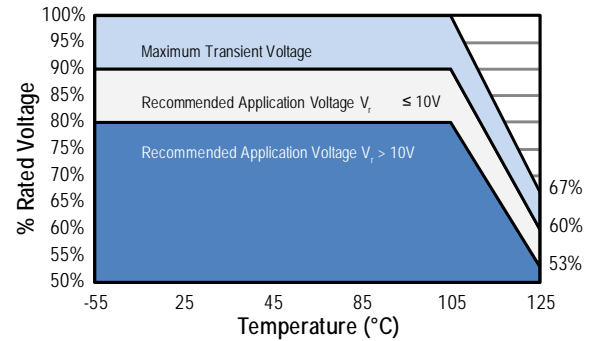

Reverse Voltage

Solid tantalum capacitors are polar devices and may be permanently damaged or destroyed if connected with the wrong polarity. The positive terminal is identified on the capacitor body by a stripe plus in some cases a beveled edge. A small degree of transient reverse voltage is permissible for short periods per the table. The capacitors should not be operated continuously in reverse mode, even within these limits.

Temperature	Permissible Transient Reverse Voltage
25°C	15% of Rated Voltage
85°C	5% of Rated Voltage
125°C	1% of Rated Voltage

Soldering Process

KEMET’s families of surface mount capacitors are compatible with wave (single or dual), convection, IR, or vapor phase reflow techniques. Preheating of these components is recommended to avoid extreme thermal stress. KEMET’s recommended profile conditions for convection and IR reflow reflect the profile conditions of the IPC/J–STD–020D standard for moisture sensitivity testing. The devices can safely withstand a maximum of three reflow passes at these conditions.

Please note that although the X/7343–43 case size can withstand wave soldering, the tall profile (4.3 mm maximum) dictates care in wave process development.

Hand soldering should be performed with care due to the difficulty in process control. If performed, care should be taken to avoid contact of the soldering iron to the molded case. The iron should be used to heat the solder pad, applying solder between the pad and the termination, until reflow occurs. Once reflow occurs, the iron should be removed immediately. “Wiping” the edges of a chip and heating the top surface is not recommended.

During typical reflow operations, a slight darkening of the gold-colored epoxy may be observed. This slight darkening is normal and not harmful to the product. Marking permanency is not affected by this change.

Profile Feature	SnPb Assembly	Pb-Free Assembly
Preheat/Soak		
Temperature Minimum (T_{smin})	100°C	150°C
Temperature Maximum (T_{smax})	150°C	200°C
Time (t_s) from T_{smin} to T_{smax}	60 – 120 seconds	60 – 120 seconds
Ramp-up Rate (T_L to T_p)	3°C/seconds maximum	3°C/seconds maximum
Liquidous Temperature (T_L)	183°C	217°C
Time Above Liquidous (t_L)	60 – 150 seconds	60 – 150 seconds
Peak Temperature (T_p)	220°C* 235°C**	250°C* 260°C**
Time within 5°C of Maximum Peak Temperature (t_p)	20 seconds maximum	30 seconds maximum
Ramp-down Rate (T_p to T_L)	6°C/seconds maximum	6°C/seconds maximum
Time 25°C to Peak Temperature	6 minutes maximum	8 minutes maximum

Note: All temperatures refer to the center of the package, measured on the package body surface that is facing up during assembly reflow.

*Case Size D, E, P, Y, and X

**Case Size A, B, C, H, I, K, M, R, S, T, U, V, W, and Z

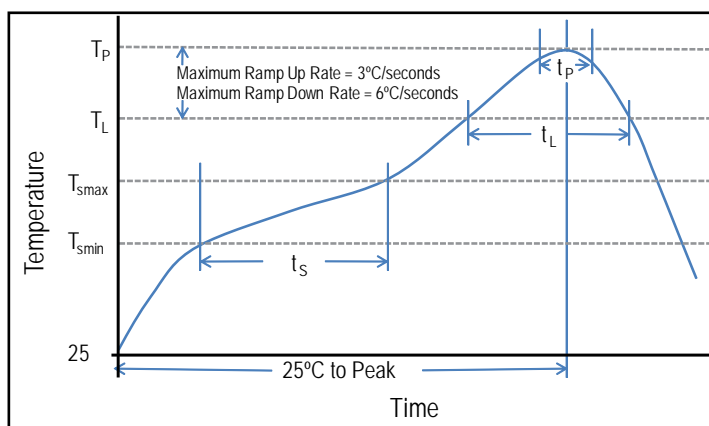

Construction

Reference	Name	Material
A	Leadframe	BeCu Alloy 190
B	Leadframe Attach	High Temp Solder
C	Lead Termination	Solder Coated Alloy 752

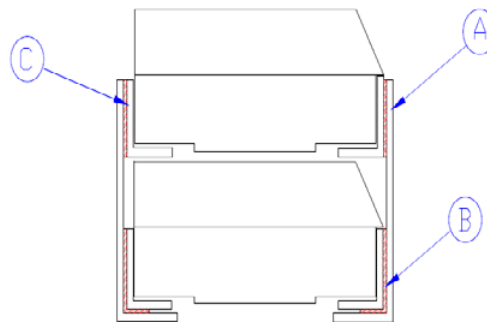

Storage and Handling

Tantalum chip capacitors should be stored in normal working environments. While the chips themselves are quite robust in other environments, solderability will be degraded by exposure to high temperatures, high humidity, corrosive atmospheres, and long term storage. In addition, packaging materials will be degraded by high temperature– reels may soften or warp and tape peel force may increase. KEMET recommends that maximum storage temperature not exceed 40°C and maximum storage humidity not exceed 70% relative humidity. Temperature fluctuations should be minimized to avoid condensation on the parts and atmospheres should be free of chlorine and sulfur bearing compounds. For optimized solderability chip stock should be used promptly, preferably within 1.5 years of receipt.

Packaging

- Tantalum Stacks Packaging EIA-451 Packaging Material Standards for ESD Sensitive Items
- Antistatic Plastic Trays
- Polyurethane Polyether Foam

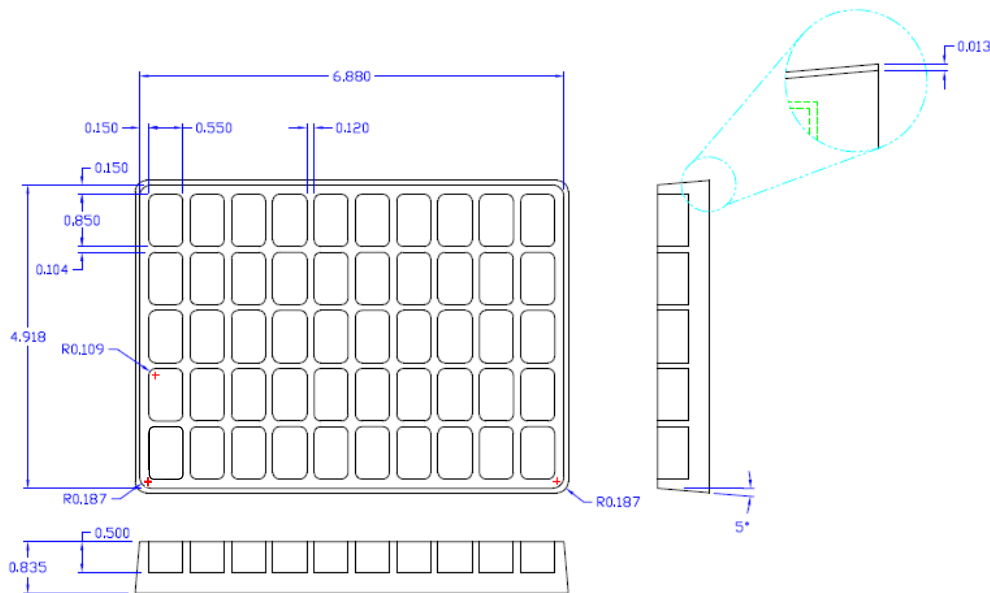

Overview

The KEMET Aluminum Organic Capacitor (AO-CAP) is a solid state aluminum capacitor with an aluminum oxide dielectric and conductive polymer cathode. The use of the conductive polymer cathode results in very low ESR and improved capacitance retention at high frequency. AO-CAP's may be operated at steady state voltages up to 100% of rated voltage (no derating) with equivalent or better reliability than tantalum capacitors operating at the recommended derated voltage.

The A700 Series AO-CAP offers the same advantages as the

polymer tantalum capacitors but also has the added advantages of 125°C performance capability, higher ripple current handling capability and a lower ESR range. Packaged with multiple anodes/elements to reduce the depth that the signal must penetrate, this parallel arrangement reduces the ESR further still to achieve lower ESR than other types of surface mount capacitors with similar capacitance ranges. With reduced ESR, the enhanced capacitance retention at higher frequencies provides the lowest total capacitance and an economical solution for power applications.

Benefits

- ESR: 6 mΩ to 70 mΩ
- Voltage: 2 V to 16 V
- Capacitance: 6.8 μF to 470 μF
- Operating Temperature: -55°C to 125°C
- Polymer cathode technology
- High frequency capacitance retention
- Non-ignition failure mode
- 100% accelerated steady state aging
- 100% surge current tested
- Volumetric efficiency
- Self-healing mechanism
- EIA standard case sizes

Applications

Typical applications include DC/DC converters, notebook PCs, telecommunications, displays, and industrial applications.

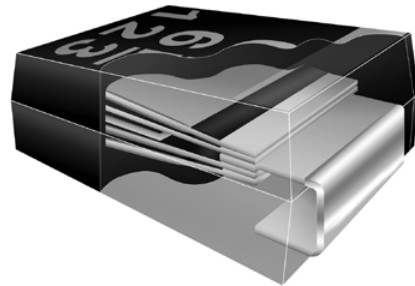

Environmental Compliance

RoHS Compliant (6/6) according to Directive 2002/95/EC when ordered with 100% Sn solder.



RoHS Compliant

SPICE

For a detailed analysis of specific part numbers, please visit www.kemet.com for a free download of KEMET's SPICE software. The KEMET SPICE program is freeware intended to aid design engineers in analyzing the performance of these capacitors over frequency, temperature, ripple, and DC bias conditions.

Ordering Information

A	700	V	476	M	006	A	T	E018	
Capacitor Class	Series	Case Size	Capacitance Code (pF)	Capacitance Tolerance	Voltage	Failure Rate/Design	Lead Material	ESR Code	Packaging (C-Spec)
A = Aluminum	700 = Aluminum Polymer	D, V, W, X	First two digits represent significant figures. Third digit specifies number of zeros.	M = ±20%	002 = 2 V 2R5 = 2.5 V 004 = 4 V 006 = 6.3 V 008 = 8 V 010 = 10 V 12R = 12.5 V 016 = 16 V	A = N/A	T = 100% Matte Tin (Sn) Plated	E = ESR Last three digits specify ESR in mΩ (018 = 18 mΩ)	Blank = 7" Reel 7280 = 13" Reel

Performance Characteristics

Item	Performance Characteristics
Operating Temperature	-55°C to 125°C
Rated Capacitance Range	6.8 – 470 μF @ 120 Hz/25°C
Capacitance Tolerance	M Tolerance (20%)
Rated Voltage Range	2 – 16 V
DF (120 Hz)	6%
ESR (100 kHz)	Refer to Part Number Electrical Specification Table
Leakage Current	≤ 4 V Rating: ≤ 0.06 CV (μA) at rated voltage after 5 minutes > 4 V Rating: ≤ 0.04 CV (μA) at rated voltage after 5 minutes

Qualification

Test	Condition	Characteristics					
Endurance	125°C @ rated voltage, 2,000 hours	Δ C/C	Within ±10% of initial value				
		DF	≤ initial limit				
		DCL	Within 1.25 x initial limit				
		ESR	Within 2.0 x initial limit				
Storage Life	125°C @ 0 volts, 2,000 hours	Δ C/C	Within ±10% of initial value				
		DF	Within initial limits				
		DCL	Within 1.25 x initial limit				
		ESR	Within 2.0 x initial limit				
Humidity	60°C, 90% RH, 1,000 hours, rated voltage 60°C, 90% RH, 500 hours, No Load	Δ C/C	Within -5%/+30% of initial value				
		DF	≤ initial limit				
		DCL	Within 5.0 x initial limit				
Temperature Stability	Extreme temperature exposure at a succession of continuous steps at +25°C, -55°C, +25°C, +85°C, +125°C, +25°C	+25°C	-55°C	+85°C	+125°C		
		Δ C/C	IL*	±15%	±15%	±20%	
		DF	IL	IL	1.2 x IL	1.5 x IL	
DCL		IL	n/a	10 x IL	10 x IL		
		Surge Voltage	125°C, 1.32 x rated voltage, 33 W Resistance, 1,000 cycles	Δ C/C	Within ±10% of initial value		
				DF	Within initial limits		
DCL	Within initial limits						
ESR	Within initial limits						
Mechanical Shock/Vibration	MIL-STD-202, Method 213, Condition I, 100 G peak MIL-STD-202, Method 204, Condition D, 10 Hz to 2,000 Hz, 20 G peak	Δ C/C	Within ±10% of initial value				
		DF	Within initial limits				
		DCL	Within initial limits				

*IL = Initial Limit

Electrical Characteristics

ESR vs. Frequency

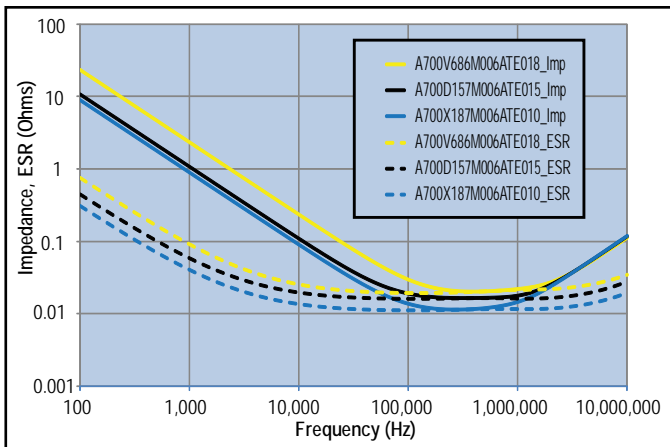

Capacitance vs. Frequency

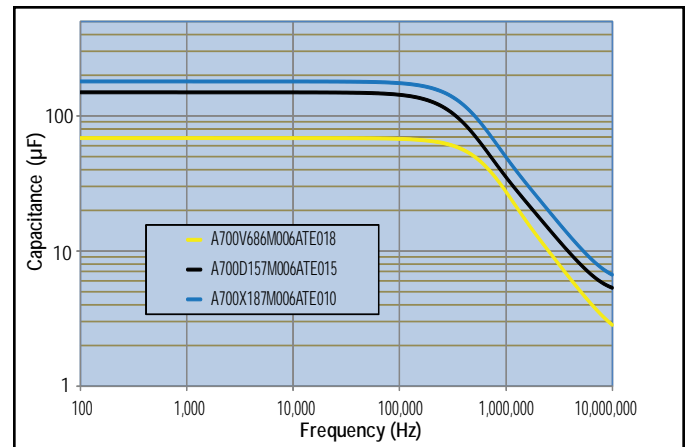

Dimensions – Millimeters (Inches)

Metric will govern

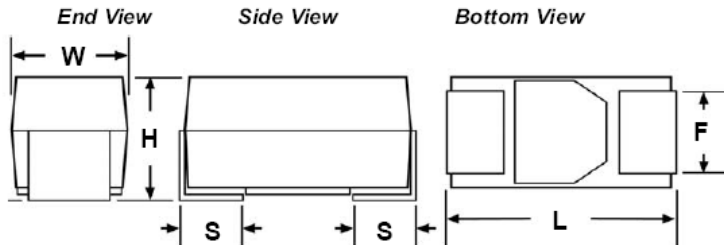

Case Size		Component				
KEMET	EIA	L*	W*	H*	F* ±0.1 ±(.004)	S* ±0.3 ±(.012)
D	7343-31	7.3 ±0.3 (0.287 ±0.012)	4.3 ±0.3 (0.169 ±0.012)	2.8 ±0.3 (0.098 ±0.012)	2.4 (.094)	1.3 (.051)
V	7343-20	7.3 ±0.3 (0.287 ±0.012)	4.3 ±0.3 (0.169 ±0.012)	2.0 (0.079) Maximum	2.4 (.094)	1.3 (.051)
W	7343-15	7.3 ±0.3 (0.287 ±0.012)	4.3 ±0.3 (0.169 ±0.012)	1.5 (0.059) Maximum	2.4 (.094)	1.3 (.051)
X	7343-43	7.3 ±0.3 (0.287 ±0.012)	4.3 ±0.3 (0.169 ±0.012)	4.0 ±0.3 (0.157 ±0.012)	2.4 (.094)	1.3 (.051)

Table 1 – Ratings & Part Number Reference

Rated Voltage	Rated Cap	Case Code/ Case Size	KEMET Part Number	DC Leakage	DF	ESR	Ripple Current	Moisture Sensitivity	Rated Temp
VDC	µF	KEMET/EIA	(See below for part options)	µA @ +20°C Maximum/5 Minutes	% @ +20°C 120 Hz Maximum	mΩ @ 20°C 100 kHz Maximum	(mA) @ 100 kHz with/T = +20°C @ -55°C to 125°C	Reflow Temperature ≤ 260°C	(°C)
2	100	W/7343-15	A700W107M002ATE009	12	6	9	5300	3	125
2	100	W/7343-15	A700W107M002ATE016	12	6	16	4000	3	125
2	100	V/7343-20	A700V107M002ATE018	12	6	18	3900	3	125
2	100	V/7343-20	A700V107M002ATE025	12	6	25	3300	3	125
2	100	V/7343-20	A700V107M002ATE028	12	6	28	3100	3	125
2	120	V/7343-20	A700V127M002ATE018	14	6	18	3900	3	125
2	120	V/7343-20	A700V127M002ATE025	14	6	25	3300	3	125
2	120	V/7343-20	A700V127M002ATE028	14	6	28	3100	3	125
2	150	V/7343-20	A700V157M002ATE009	18	6	9	5500	3	125
2	150	V/7343-20	A700V157M002ATE015	18	6	15	4200	3	125
2	150	V/7343-20	A700V157M002ATE018	18	6	18	3900	3	125
2	150	V/7343-20	A700V157M002ATE025	18	6	25	3300	3	125
2	150	V/7343-20	A700V157M002ATE028	18	6	28	3100	3	125
2	180	D/7343-31	A700D187M002ATE015	22	6	15	4100	3	125
2	180	D/7343-31	A700D187M002ATE018	22	6	18	3700	3	125
2	220	V/7343-20	A700V227M002ATE009	26	6	9	5500	3	125
2	220	V/7343-20	A700V227M002ATE015	26	6	15	4200	3	125
2	220	V/7343-20	A700V227M002ATE018	26	6	18	3900	3	125
2	220	D/7343-31	A700D227M002ATE009	26	6	9	5300	3	125
2	220	D/7343-31	A700D227M002ATE015	26	6	15	4100	3	125
2	220	D/7343-31	A700D227M002ATE018	26	6	18	3700	3	125
2	270	D/7343-31	A700D277M002ATE012	32	6	12	4600	3	125
2	270	X/7343-43	A700X277M002ATE010	32	6	10	4700	3	125
2	270	X/7343-43	A700X277M002ATE012	32	6	12	4300	3	125
2	270	X/7343-43	A700X277M002ATE015	32	6	15	3900	3	125
2	330	V/7343-20	A700V337M002ATE009	40	6	9	5500	3	125
2	330	D/7343-31	A700D337M002ATE006	40	6	6	6500	3	125
2	330	D/7343-31	A700D337M002ATE007	40	6	7	6000	3	125
2	330	D/7343-31	A700D337M002ATE009	40	6	9	5300	3	125
2	330	D/7343-31	A700D337M002ATE012	40	6	12	4600	3	125
2	330	X/7343-43	A700X337M002ATE010	40	6	10	4700	3	125
2	330	X/7343-43	A700X337M002ATE015	40	6	15	3900	3	125
2	390	X/7343-43	A700X397M002ATE010	47	6	10	4700	3	125
2	390	X/7343-43	A700X397M002ATE015	47	6	15	3900	3	125
2	470	D/7343-31	A700D477M002ATE005	56	6	5	7100	3	125
2	470	X/7343-43	A700X477M002ATE007	56	6	7	5700	3	125
2	470	X/7343-43	A700X477M002ATE010	56	6	10	4700	3	125
2	470	X/7343-43	A700X477M002ATE015	56	6	15	3900	3	125
2	560	X/7343-43	A700X567M002ATE005	67	6	5	6700	3	125
2.5	82	V/7343-20	A700V826M2R5ATE018	12	6	18	3900	3	125
2.5	82	V/7343-20	A700V826M2R5ATE025	12	6	25	3300	3	125
2.5	82	V/7343-20	A700V826M2R5ATE028	12	6	28	3100	3	125
2.5	150	D/7343-31	A700D157M2R5ATE015	23	6	15	4100	3	125
2.5	150	D/7343-31	A700D157M2R5ATE018	23	6	18	3700	3	125
2.5	180	D/7343-31	A700D187M2R5ATE015	27	6	15	4100	3	125
2.5	180	D/7343-31	A700D187M2R5ATE018	27	6	18	3700	3	125
2.5	220	X/7343-43	A700X227M2R5ATE010	33	6	10	4700	3	125
2.5	220	X/7343-43	A700X227M2R5ATE015	33	6	15	3900	3	125
2.5	330	X/7343-43	A700X337M2R5ATE010	50	6	10	4700	3	125
2.5	330	X/7343-43	A700X337M2R5ATE015	50	6	15	3900	3	125
4	68	V/7343-20	A700V686M004ATE020	16	6	20	3700	3	125
VDC	µF	KEMET/EIA	(See below for part options)	µA @ +20°C Maximum/5 Minutes	% @ +20°C 120 Hz Maximum	mΩ @ 20°C 100 kHz Maximum	(mA) @ 100 kHz with/T = +20°C @ -55°C to 125°C	Reflow Temperature ≤ 260°C	(°C)
Rated Voltage	Rated Cap	Case Code/ Case Size	KEMET Part Number	DC Leakage	DF	ESR	Ripple Current	Moisture Sensitivity	Rated Temp

Other part number options:

Also available on large (13 inch) reels. Add 7280 to the end of the part number.

Higher voltage ratings and tighter tolerance product including ESR may be substituted within the same size at KEMET's option. Voltage substitutions will be marked with the higher voltage rating. Substitutions can include better than series.

Table 1 – Ratings & Part Number Reference cont'd

Rated Voltage	Rated Cap	Case Code/ Case Size	KEMET Part Number	DC Leakage	DF	ESR	Ripple Current	Moisture Sensitivity	Rated Temp
VDC	µF	KEMET/EIA	(See below for part options)	µA @ +20°C Maximum/5 Minutes	% @ +20°C 120 Hz Maximum	mΩ @ 20°C 100 kHz Maximum	(mA) @ 100 kHz with/T = +20°C @ -55°C to 125°C	Reflow Temperature ≤ 260°C	(°C)
4	68	V/7343-20	A700V686M004ATE028	16	6	28	3100	3	125
4	82	V/7343-20	A700V826M004ATE025	20	6	25	3300	3	125
4	82	V/7343-20	A700V826M004ATE028	20	6	28	3100	3	125
4	120	D/7343-31	A700D127M004ATE015	29	6	15	4100	3	125
4	120	D/7343-31	A700D127M004ATE018	29	6	18	3700	3	125
4	150	D/7343-31	A700D157M004ATE015	36	6	15	4100	3	125
4	150	D/7343-31	A700D157M004ATE018	36	6	18	3700	3	125
4	180	D/7343-31	A700D187M004ATE015	43	6	15	4100	3	125
4	180	D/7343-31	A700D187M004ATE018	43	6	18	3700	3	125
4	180	X/7343-43	A700X187M004ATE010	43	6	10	4700	3	125
4	180	X/7343-43	A700X187M004ATE015	43	6	15	3900	3	125
4	180	X/7343-43	A700X187M004ATE018	43	6	18	3500	3	125
4	220	D/7343-31	A700D227M004ATE009	53	6	9	5300	3	125
4	220	D/7343-31	A700D227M004ATE010	53	6	10	5000	3	125
4	220	D/7343-31	A700D227M004ATE015	53	6	15	4100	3	125
4	220	X/7343-43	A700X227M004ATE010	53	6	10	4700	3	125
4	220	X/7343-43	A700X227M004ATE015	53	6	15	3900	3	125
4	270	X/7343-43	A700X277M004ATE010	65	6	10	4700	3	125
4	270	X/7343-43	A700X277M004ATE015	65	6	15	3900	3	125
4	330	X/7343-43	A700X337M004ATE010	79	6	10	4700	3	125
4	330	X/7343-43	A700X337M004ATE015	79	6	15	3900	3	125
6.3	10	V/7343-20	A700V106M006ATE055	3	6	55	2200	3	125
6.3	22	V/7343-20	A700V226M006ATE028	6	6	28	3100	3	125
6.3	22	V/7343-20	A700V226M006ATE045	6	6	45	2400	3	125
6.3	33	V/7343-20	A700V336M006ATE018	8	6	18	3900	3	125
6.3	33	V/7343-20	A700V336M006ATE025	8	6	25	3300	3	125
6.3	33	V/7343-20	A700V336M006ATE028	8	6	28	3100	3	125
6.3	47	V/7343-20	A700V476M006ATE018	12	6	18	3900	3	125
6.3	47	V/7343-20	A700V476M006ATE025	12	6	25	3300	3	125
6.3	47	V/7343-20	A700V476M006ATE028	12	6	28	3100	3	125
6.3	56	V/7343-20	A700V566M006ATE018	14	6	18	3900	3	125
6.3	56	V/7343-20	A700V566M006ATE025	14	6	25	3300	3	125
6.3	56	V/7343-20	A700V566M006ATE028	14	6	28	3100	3	125
6.3	68	V/7343-20	A700V686M006ATE018	17	6	18	3900	3	125
6.3	68	V/7343-20	A700V686M006ATE025	17	6	25	3300	3	125
6.3	68	V/7343-20	A700V686M006ATE028	17	6	28	3100	3	125
6.3	82	V/7343-20	A700V826M006ATE018	21	6	18	3900	3	125
6.3	82	V/7343-20	A700V826M006ATE025	21	6	25	3300	3	125
6.3	82	V/7343-20	A700V826M006ATE028	21	6	28	3100	3	125
6.3	100	V/7343-20	A700V107M006ATE015	25	6	15	4200	3	125
6.3	100	V/7343-20	A700V107M006ATE018	25	6	18	3900	3	125
6.3	100	V/7343-20	A700V107M006ATE025	25	6	25	3300	3	125
6.3	100	D/7343-31	A700D107M006ATE015	25	6	15	4100	3	125
6.3	100	D/7343-31	A700D107M006ATE018	25	6	18	3700	3	125
6.3	120	D/7343-31	A700D127M006ATE012	30	6	12	4600	3	125
6.3	120	D/7343-31	A700D127M006ATE015	30	6	15	4100	3	125
6.3	120	D/7343-31	A700D127M006ATE018	30	6	18	3700	3	125
6.3	150	D/7343-31	A700D157M006ATE010	38	6	10	5000	3	125
6.3	150	D/7343-31	A700D157M006ATE012	38	6	12	4600	3	125
6.3	150	D/7343-31	A700D157M006ATE015	38	6	15	4100	3	125
6.3	150	X/7343-43	A700X157M006ATE010	38	6	10	4700	3	125
6.3	150	X/7343-43	A700X157M006ATE012	38	6	12	4300	3	125
VDC	µF	KEMET/EIA	(See below for part options)	µA @ +20°C Maximum/5 Minutes	% @ +20°C 120 Hz Maximum	mΩ @ 20°C 100 kHz Maximum	(mA) @ 100 kHz with/T = +20°C @ -55°C to 125°C	Reflow Temperature ≤ 260°C	(°C)
Rated Voltage	Rated Cap	Case Code/ Case Size	KEMET Part Number	DC Leakage	DF	ESR	Ripple Current	Moisture Sensitivity	Rated Temp

Other part number options:

Also available on large (13 inch) reels. Add 7280 to the end of the part number.

Higher voltage ratings and tighter tolerance product including ESR may be substituted within the same size at KEMET's option. Voltage substitutions will be marked with the higher voltage rating. Substitutions can include better than series.

Table 1 – Ratings & Part Number Reference cont'd

Rated Voltage	Rated Cap	Case Code/ Case Size	KEMET Part Number	DC Leakage	DF	ESR	Ripple Current	Moisture Sensitivity	Rated Temp
VDC	µF	KEMET/EIA	(See below for part options)	µA @ +20°C Maximum/5 Minutes	% @ +20°C 120 Hz Maximum	mΩ @ 20°C 100 kHz Maximum	(mA) @ 100 kHz with/T = +20°C @ -55°C to 125°C	Reflow Temperature ≤ 260°C	(°C)
6.3	150	X/7343-43	A700X157M006ATE015	38	6	15	3900	3	125
6.3	180	X/7343-43	A700X187M006ATE010	45	6	10	4700	3	125
6.3	180	X/7343-43	A700X187M006ATE015	45	6	15	3900	3	125
6.3	220	X/7343-43	A700X227M006ATE015	55	6	15	3900	3	125
8	10	V/7343-20	A700V106M008ATE055	3	6	55	2200	3	125
8	22	V/7343-20	A700V226M008ATE028	7	6	28	3100	3	125
8	22	V/7343-20	A700V226M008ATE045	7	6	45	2400	3	125
8	33	V/7343-20	A700V336M008ATE018	11	6	18	3900	3	125
8	33	V/7343-20	A700V336M008ATE025	11	6	25	3300	3	125
8	33	V/7343-20	A700V336M008ATE028	11	6	28	3100	3	125
8	56	D/7343-31	A700D566M008ATE015	18	6	15	4100	3	125
8	56	D/7343-31	A700D566M008ATE018	18	6	18	3700	3	125
8	68	D/7343-31	A700D686M008ATE015	22	6	15	4100	3	125
8	68	D/7343-31	A700D686M008ATE018	22	6	18	3700	3	125
8	100	X/7343-43	A700X107M008ATE010	32	6	10	4700	3	125
8	100	X/7343-43	A700X107M008ATE012	32	6	12	4300	3	125
8	100	X/7343-43	A700X107M008ATE015	32	6	15	3900	3	125
10	10	V/7343-20	A700V106M010ATE055	4	6	55	2200	3	125
10	22	V/7343-20	A700V226M010ATE028	9	6	28	3100	3	125
10	33	V/7343-20	A700V336M010ATE018	13	6	18	3900	3	125
10	33	V/7343-20	A700V336M010ATE025	13	6	25	3300	3	125
10	33	V/7343-20	A700V336M010ATE028	13	6	28	3100	3	125
10	47	V/7343-20	A700V476M010ATE028	19	6	28	3100	3	125
10	56	D/7343-31	A700D566M010ATE015	22	6	15	4100	3	125
10	56	D/7343-31	A700D566M010ATE018	22	6	18	3700	3	125
10	68	D/7343-31	A700D686M010ATE015	27	6	15	4100	3	125
10	68	D/7343-31	A700D686M010ATE018	27	6	18	3700	3	125
10	100	X/7343-43	A700X107M010ATE010	40	6	10	4700	3	125
10	100	X/7343-43	A700X107M010ATE015	40	6	15	3900	3	125
10	120	X/7343-43	A700X127M010ATE010	48	6	10	4700	3	125
10	120	X/7343-43	A700X127M010ATE015	48	6	15	3900	3	125
10	150	X/7343-43	A700X157M010ATE010	60	6	10	4700	3	125
10	150	X/7343-43	A700X157M010ATE015	60	6	15	3900	3	125
12.5	10	V/7343-20	A700V106M12RATE040	5	6	40	2600	3	125
12.5	10	V/7343-20	A700V106M12RATE060	5	6	60	2100	3	125
12.5	15	V/7343-20	A700V156M12RATE040	8	6	40	2600	3	125
12.5	22	V/7343-20	A700V226M12RATE030	11	6	30	3000	3	125
12.5	47	D/7343-31	A700D476M12RATE020	24	6	20	3500	3	125
12.5	47	D/7343-31	A700D476M12RATE025	24	6	25	3200	3	125
12.5	100	X/7343-43	A700X107M12RATE015	50	6	15	3900	3	125
16	6.8	V/7343-20	A700V685M016ATE070	4	6	70	2000	3	125
16	8.2	V/7343-20	A700V825M016ATE045	5	6	45	2400	3	125
16	10	V/7343-20	A700V106M016ATE045	6	6	45	2400	3	125
16	10	V/7343-20	A700V106M016ATE060	6	6	60	2100	3	125
16	15	V/7343-20	A700V156M016ATE040	10	6	40	2600	3	125
16	22	D/7343-31	A700D226M016ATE018	14	6	18	3700	3	125
16	22	D/7343-31	A700D226M016ATE025	14	6	25	3200	3	125
16	22	D/7343-31	A700D226M016ATE030	14	6	30	2900	3	125
VDC	µF	KEMET/EIA	(See below for part options)	µA @ +20°C Maximum/5 Minutes	% @ +20°C 120 Hz Maximum	mΩ @ 20°C 100 kHz Maximum	(mA) @ 100 kHz with/T = +20°C @ -55°C to 125°C	Reflow Temperature ≤ 260°C	(°C)
Rated Voltage	Rated Cap	Case Code/ Case Size	KEMET Part Number	DC Leakage	DF	ESR	Ripple Current	Moisture Sensitivity	Rated Temp

Other part number options:

Also available on large (13 inch) reels. Add 7280 to the end of the part number.

Higher voltage ratings and tighter tolerance product including ESR may be substituted within the same size at KEMET's option. Voltage substitutions will be marked with the higher voltage rating. Substitutions can include better than series.

Derating Guidelines

Voltage Rating	Maximum Recommended Steady State Voltage	Maximum Recommended Transient Voltage (1 ms – 1 μs)
-55°C to 125°C		
$2 V \leq V_R \leq 16 V$	V_R	V_R

V_R = Rated Voltage

Ripple Current/Ripple Voltage

Permissible AC ripple voltage and current are related to equivalent series resistance (ESR) and the power dissipation capabilities of the device. Permissible AC ripple voltage which may be applied is limited by two criteria

1. The positive peak AC voltage plus the DC bias voltage, if any, must not exceed the DC voltage rating of the capacitor.
2. The negative peak AC voltage, in combination with bias voltage, if any, must not exceed the allowable limits specified for reverse voltage. See the Reverse Voltage section for allowable limits

Power capability is determined based on a 20°C temperature rise. A higher temperature rise and therefore higher power capability is allowable as long as the ambient temperature plus temperature rise due to ripple current does not exceed the rated temperature of the part.

The maximum power dissipation by case size can be determined using the below table.

KEMET Series and Case Code	EIA Case Code	Maximum Power Dissipation (P max) mWatts @ 25°C with +20°C Rise
A700W	7343-15	290
A700V	7343-20	270
A700D	7343-31	250
A700X	7343-43	225

Using the P max of the device, the maximum allowable rms ripple current or voltage may be determined.

$$I(max) = \sqrt{P_{max}/R}$$

$$E(max) = \sqrt{P_{max} \cdot R}$$

I = rms ripple current (amperes)

E = rms ripple voltage (volts)

P_{max} = maximum power dissipation(watts)

R = ESR at specified frequency (ohms)

Refer to part number listings for permissible Arms limits.

Reverse Voltage

Polymer aluminum capacitors are polar devices and may be permanently damaged or destroyed if connected in the wrong polarity. These devices will withstand a certain degree of transient voltage reversal for short periods as shown in the below table. Please note that these parts may not be operated continuously in reverse, even within these limits.

Temperature	Permissible Transient Reverse Voltage
25°C	60% of Rated Voltage
55°C	50% of Rated Voltage
85°C	40% of Rated Voltage
125°C	30% of Rated Voltage

Table 2 – Land Dimensions/Courtyard

KEMET	Metric Size Code	Density Level A: Maximum (Most) Land Protrusion (mm)					Density Level B: Median (Nominal) Land Protrusion (mm)					Density Level C: Minimum (Least) Land Protrusion (mm)				
		X	Y	C	V1	V2	X	Y	C	V1	V2	X	Y	C	V1	V2
D	7343-31	2.55	3.75	2.70	10.20	5.50	2.45	3.35	2.60	9.10	5.00	2.35	2.95	2.50	8.20	4.70
V	7343-20	2.55	3.75	2.70	10.20	5.50	2.45	3.35	2.60	9.10	5.00	2.35	2.95	2.50	8.20	4.70
W	7343-15	2.55	3.75	2.70	10.20	5.50	2.45	3.35	2.60	9.10	5.00	2.35	2.95	2.50	8.20	4.70
X ¹	7343-43	2.55	3.75	2.70	10.20	5.50	2.45	3.35	2.60	9.10	5.00	2.35	2.95	2.50	8.20	4.70

Density Level A: For low-density product applications. Recommended for wave solder applications and provides a wider process window for reflow solder processes.

Density Level B: For products with a moderate level of component density. Provides a robust solder attachment condition for reflow solder processes.

Density Level C: For high component density product applications. Before adapting the minimum land pattern variations the user should perform qualification testing based on the conditions outlined in IPC Standard 7351 (IPC-7351).

¹ Height of these chips may create problems in wave soldering.

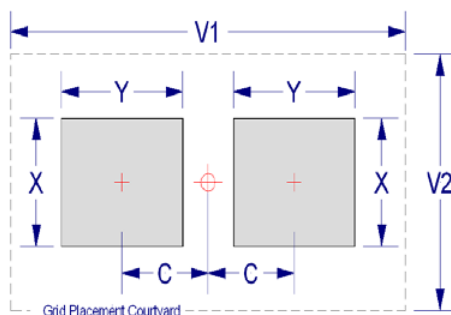

Soldering Process

KEMET's families of surface mount capacitors are compatible with wave (single or dual), convection, IR, or vapor phase reflow techniques. Preheating of these components is recommended to avoid extreme thermal stress. KEMET's recommended profile conditions for convection and IR reflow reflect the profile conditions of the IPC/J-STD-020D standard for moisture sensitivity testing. The devices can safely withstand a maximum of three reflow passes at these conditions.

Please note that although the X/7343-43 case size can withstand wave soldering, the tall profile (4.3 mm maximum) dictates care in wave process development.

Hand soldering should be performed with care due to the difficulty in process control. If performed, care should be taken to avoid contact of the soldering iron to the molded case. The iron should be used to heat the solder pad, applying solder between the pad and the termination, until reflow occurs. Once reflow occurs, the iron should be removed immediately. "Wiping" the edges of a chip and heating the top surface is not recommended.

During typical reflow operations, a slight darkening of the gold-colored epoxy may be observed. This slight darkening is normal and not harmful to the product. Marking permanency is not affected by this change.

Profile Feature	SnPb Assembly	Pb-Free Assembly
Preheat/Soak		
Temperature Minimum (T_{smin})	100°C	150°C
Temperature Maximum (T_{smax})	150°C	200°C
Time (t_s) from T_{smin} to T_{smax}	60 – 120 seconds	60 – 120 seconds
Ramp-up Rate (T_L to T_p)	3°C/seconds maximum	3°C/seconds maximum
Liquidous Temperature (T_L)	183°C	217°C
Time Above Liquidous (t_L)	60 – 150 seconds	60 – 150 seconds
Peak Temperature (T_p)	220°C* 235°C**	250°C* 260°C**
Time within 5°C of Maximum Peak Temperature (t_p)	20 seconds maximum	30 seconds maximum
Ramp-down Rate (T_p to T_L)	6°C/seconds maximum	6°C/seconds maximum
Time 25°C to Peak Temperature	6 minutes maximum	8 minutes maximum

Note: All temperatures refer to the center of the package, measured on the package body surface that is facing up during assembly reflow.

*Case Size D, E, P, Y, and X

**Case Size A, B, C, H, I, K, M, R, S, T, U, V, W, and Z

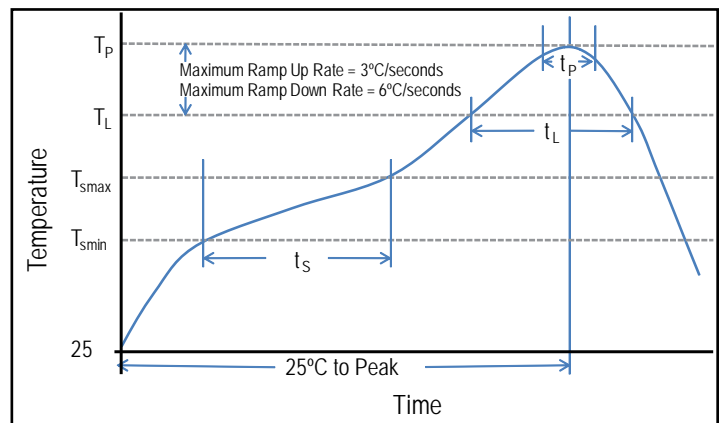

Capacitor Marking

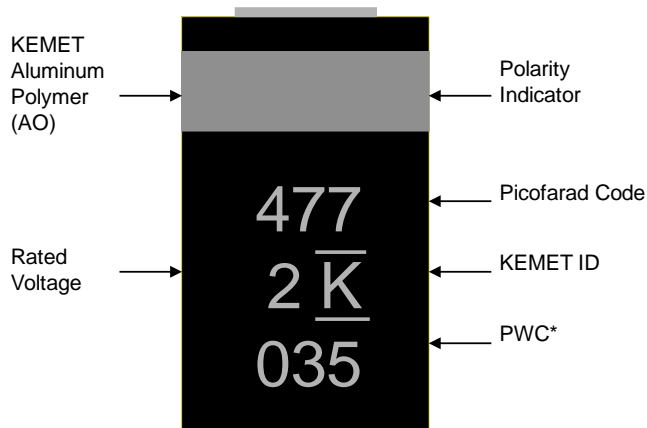

* 035 = 35th week of 2010

Date Code *	
1 st digit = Last number of Year	9 = 2009 0 = 2010 1 = 2011 2 = 2012 3 = 2013 4 = 2014
2 nd and 3 rd digit = Week of the Year	01 = 1 st week of the Year to 52 = 52 nd week of the Year

Storage

All AO-CAP series are shipped in moisture barrier bags with a desiccant and moisture indicator card. These series are classified as MSL3 (Moisture Sensitivity Level 3). Product contained within the moisture barrier bags should be stored in normal working environments with temperatures not to exceed 40°C and humidity not in excess of 60% RH.

Tape & Reel Packaging Information

KEMET's molded tantalum and aluminum chip capacitor families are packaged in 8 and 12 mm plastic tape on 7" and 13" reels in accordance with *EIA Standard 481-1: Embossed Carrier Taping of Surface Mount Components for Automatic Handling*. This packaging system is compatible with all tape-fed automatic pick-and-place systems.

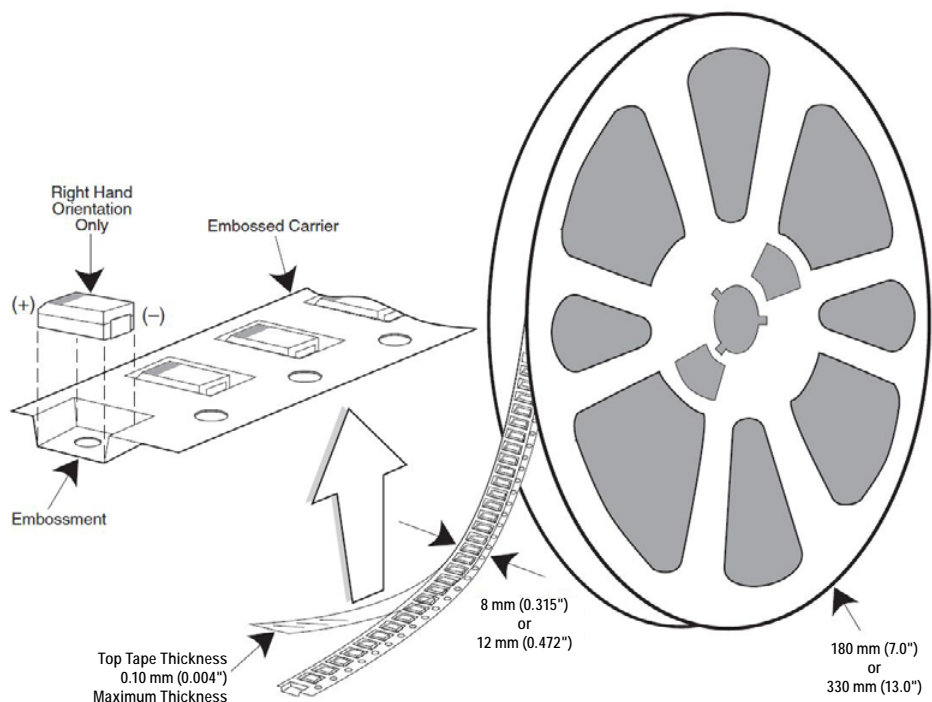

Table 3 – Packaging Quantity

Case Code		Tape Width (mm)	7" Reel*	13" Reel*
KEMET	EIA			
I	3216-10	8	3,000	12,000
S	3216-12	8	2,500	10,000
T	3528-12	8	2,500	10,000
M	3528-15	8	2,000	8,000
U	6032-15	12	1,000	5,000
L	6032-19	12	1,000	5,000
W	7343-15	12	1,000	3,000
Z	7343-17	12	1,000	3,000
V	7343-20	12	1,000	3,000
A	3216-18	8	2,000	9,000
B	3528-21	8	2,000	8,000
C	6032-28	12	500	3,000
D	7343-31	12	500	2,500
Y	7343-40	12	500	2,000
X	7343-43	12	500	2,000
E/T428P	7360-38	12	500	2,000
H	7360-20	12	1,000	2,500

* No C-Spec required for 7" reel packaging. C-7280 required for 13" reel packaging.

Figure 1 – Embossed (Plastic) Carrier Tape Dimensions

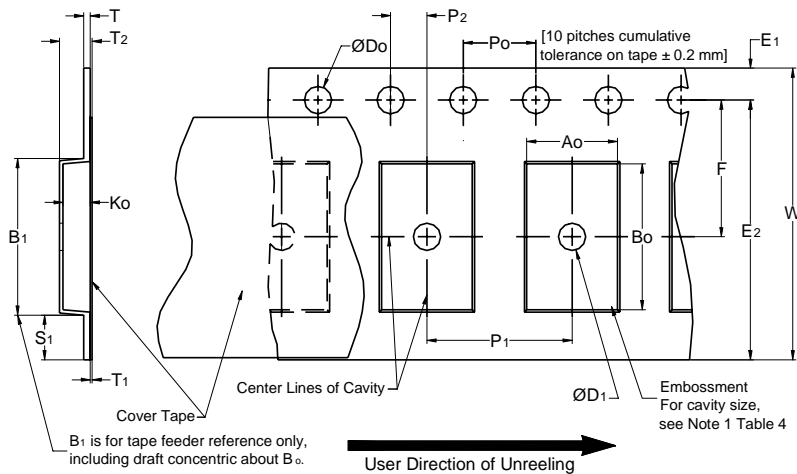

Table 4 – Embossed (Plastic) Carrier Tape Dimensions

Metric will govern

Constant Dimensions — Millimeters (Inches)									
Tape Size	D ₀	D ₁ Minimum Note 1	E ₁	P ₀	P ₂	R Reference Note 2	S ₁ Minimum Note 3	T Maximum	T ₁ Maximum
8 mm	1.5 +0.10/-0.0 (0.059 +0.004/-0.0)	1.0 (0.039)	1.75 ±0.10 (0.069 ±0.004)	4.0 ±0.10 (0.157 ±0.004)	2.0 ±0.05 (0.079 ±0.002)	25.0 (0.984)	0.600 (0.024)	0.600 (0.024)	0.100 (0.004)
12 mm		1.5 (0.059)				30 (1.181)			
16 mm									
Variable Dimensions — Millimeters (Inches)									
Tape Size	Pitch	B ₁ Maximum Note 4	E ₂ Minimum	F	P ₁	T ₂ Maximum	W Maximum	A ₀ , B ₀ & K ₀	
8 mm	Single (4 mm)	4.35 (0.171)	6.25 (0.246)	3.5 ±0.05 (0.138 ±0.002)	4.0 ±0.10 (0.157 ±0.004)	2.5 (0.098)	8.3 (0.327)	Note 5	
12 mm	Single (4 mm) & Double (8 mm)	8.2 (0.323)	10.25 (0.404)	5.5 ±0.05 (0.217 ±0.002)	8.0 ±0.10 (0.315 ±0.004)	4.6 (0.181)	12.3 (0.484)		
16 mm	Triple (12 mm)	12.1 (0.476)	14.25 (0.561)	5.5 ±0.05 (0.217 ±0.002)	8.0 ±0.10 (0.315 ±0.004)	4.6 (0.181)	16.3 (0.642)		

- The embossment hole location shall be measured from the sprocket hole controlling the location of the embossment. Dimensions of embossment location and hole location shall be applied independent of each other.
- The tape, with or without components, shall pass around R without damage (see Figure 5).
- If S₁ < 1.0 mm, there may not be enough area for cover tape to be properly applied (see EIA Standard 481–D, paragraph 4.3, section b).
- B₁ dimension is a reference dimension for tape feeder clearance only.
- The cavity defined by A₀, B₀ and K₀ shall surround the component with sufficient clearance that:
 - the component does not protrude above the top surface of the carrier tape.
 - the component can be removed from the cavity in a vertical direction without mechanical restriction, after the top cover tape has been removed.
 - rotation of the component is limited to 20° maximum for 8 and 12 mm tapes and 10° maximum for 16 mm tapes (see Figure 2).
 - lateral movement of the component is restricted to 0.5 mm maximum for 8 mm and 12 mm wide tape and to 1.0 mm maximum for 16 mm tape (see Figure 3).
 - see Addendum in EIA Standard 481–D for standards relating to more precise taping requirements.

Packaging Information Performance Notes

1. Cover Tape Break Force: 1.0 Kg minimum.
2. Cover Tape Peel Strength: The total peel strength of the cover tape from the carrier tape shall be:

Tape Width	Peel Strength
8 mm	0.1 to 1.0 Newton (10 to 100 gf)
12 and 16 mm	0.1 to 1.3 Newton (10 to 130 gf)

The direction of the pull shall be opposite the direction of the carrier tape travel. The pull angle of the carrier tape shall be 165° to 180° from the plane of the carrier tape. During peeling, the carrier and/or cover tape shall be pulled at a velocity of 300 ±10 mm/minute.

3. Labeling: Bar code labeling (standard or custom) shall be on the side of the reel opposite the sprocket holes. Refer to EIA Standards 556 and 624.

Figure 2 – Maximum Component Rotation

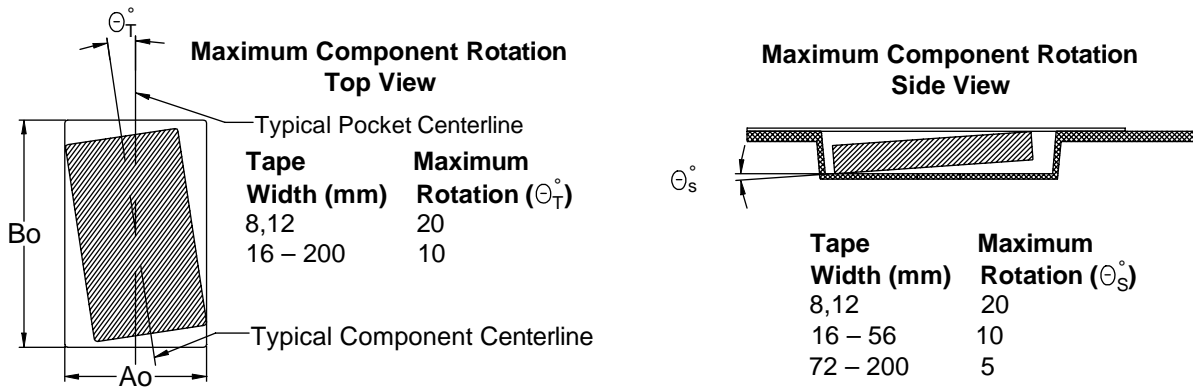

Figure 3 – Maximum Lateral Movement

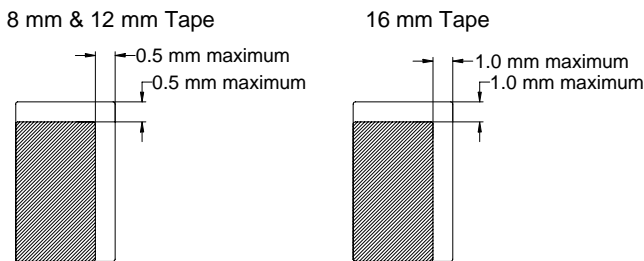

Figure 4 – Bending Radius

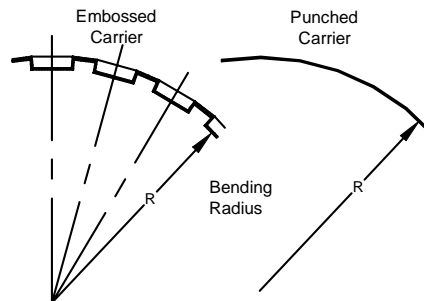
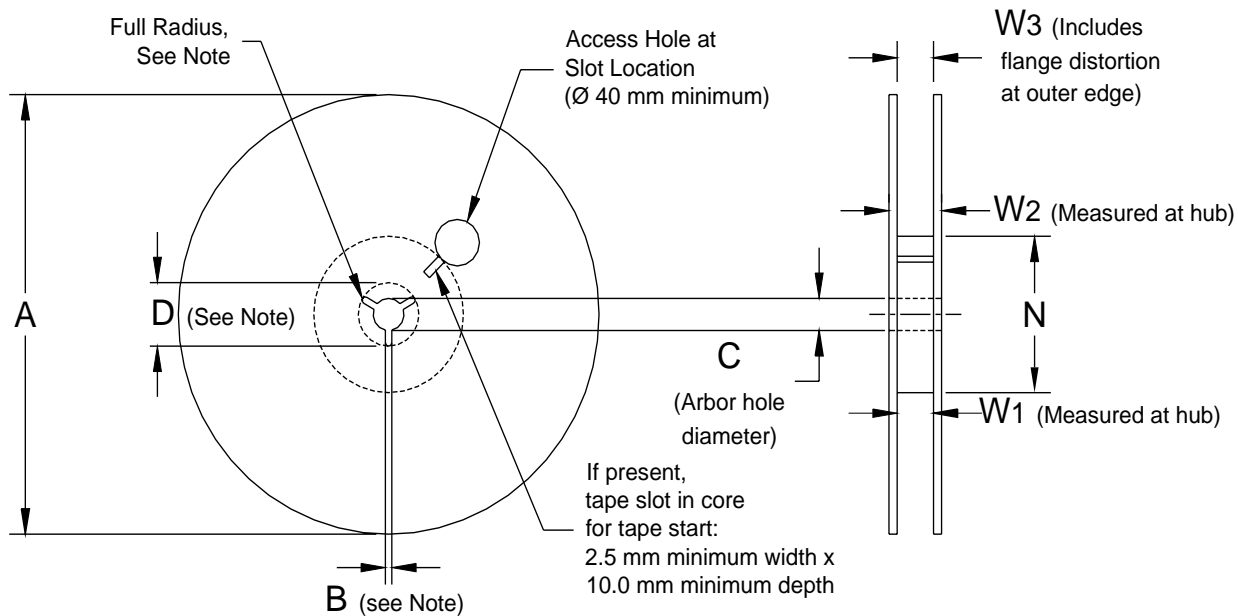

Figure 5 – Reel Dimensions



Note: Drive spokes optional; if used, dimensions B and D shall apply.

Table 5 – Reel Dimensions

Metric will govern

Constant Dimensions – Millimeters (Inches)				
Tape Size	A	B Minimum	C	D Minimum
8 mm	178 ±0.20 (7.008 ±0.008) or 330 ±0.20 (13.000 ±0.008)	1.5 (0.059)	13.0 +0.5/-0.2 (0.521 +0.02/-0.008)	20.2 (0.795)
12 mm				
16 mm				
Variable Dimensions – Millimeters (Inches)				
Tape Size	N Minimum	W ₁	W ₂ Maximum	W ₃
8 mm	50 (1.969)	8.4 +1.5/-0.0 (0.331 +0.059/-0.0)	14.4 (0.567)	Shall accommodate tape width without interference
12 mm		12.4 +2.0/-0.0 (0.488 +0.078/-0.0)	18.4 (0.724)	
16 mm		16.4 +2.0/-0.0 (0.646 +0.078/-0.0)	22.4 (0.882)	

Figure 6 – Tape Leader & Trailer Dimensions

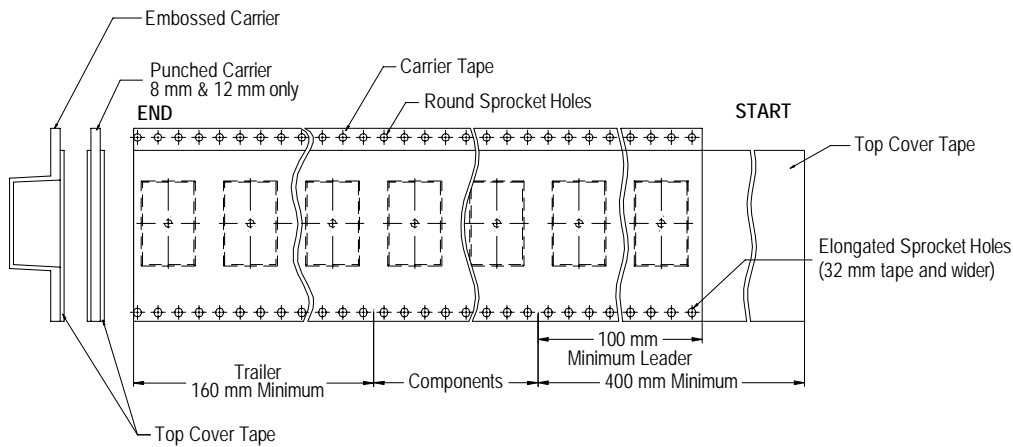
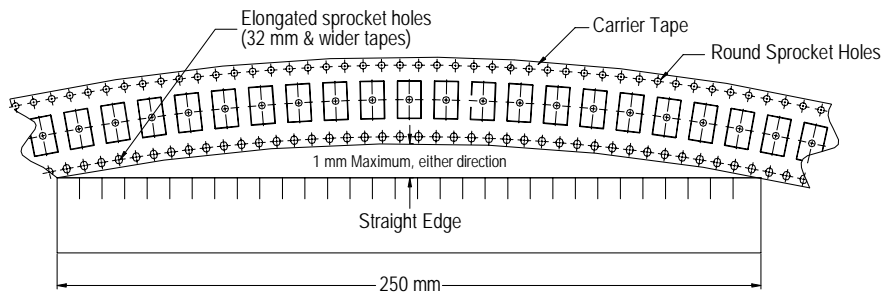

Figure 7 – Maximum Camber



Tape & Reel Packaging Information

KEMET's molded tantalum and aluminum chip capacitor families are packaged in 8 and 12 mm plastic tape on 7" and 13" reels in accordance with *EIA Standard 481-1: Embossed Carrier Taping of Surface Mount Components for Automatic Handling*. This packaging system is compatible with all tape-fed automatic pick-and-place systems.

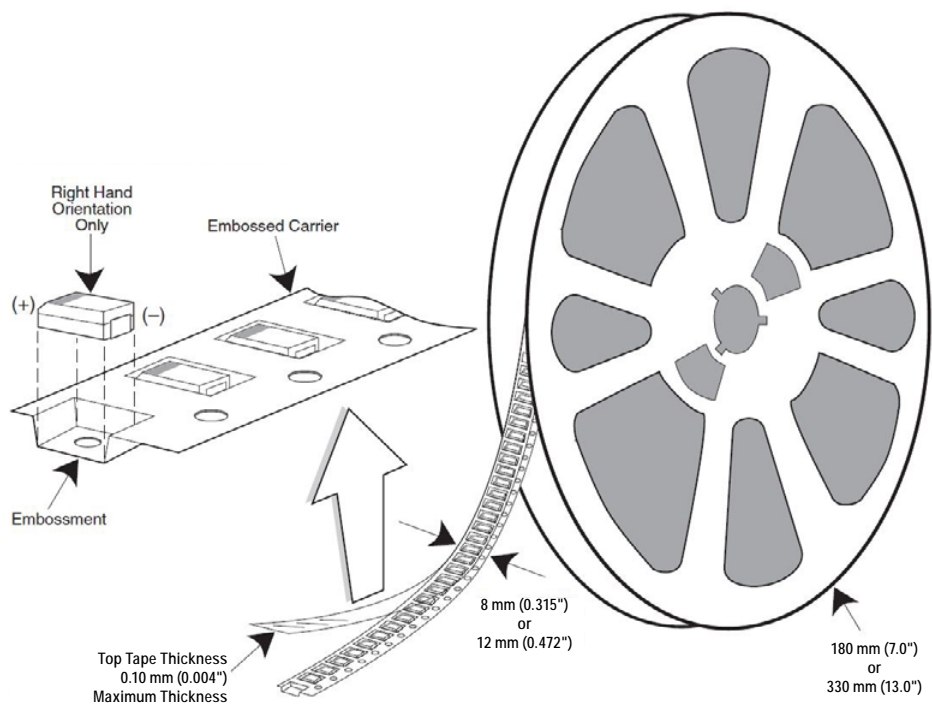

Table 3 – Packaging Quantity

Case Code		Tape Width (mm)	7" Reel*	13" Reel*
KEMET	EIA			
R	2012-12	8	2,500	10,000
I	3216-10	8	3,000	12,000
S	3216-12	8	2,500	10,000
T	3528-12	8	2,500	10,000
M	3528-15	8	2,000	8,000
U	6032-15	12	1,000	5,000
L	6032-19	12	1,000	5,000
W	7343-15	12	1,000	3,000
Z	7343-17	12	1,000	3,000
V	7343-19	12	1,000	3,000
A	3216-18	8	2,000	9,000
B	3528-21	8	2,000	8,000
C	6032-28	12	500	3,000
D	7343-31	12	500	2,500
Y	7343-40	12	500	2,000
X	7343-43	12	500	2,000
E/T428P	7360-38	12	500	2,000
H	7360-20	12	1,000	2,500

* No C-Spec required for 7" reel packaging. C-7280 required for 13" reel packaging.

Figure 1 – Embossed (Plastic) Carrier Tape Dimensions

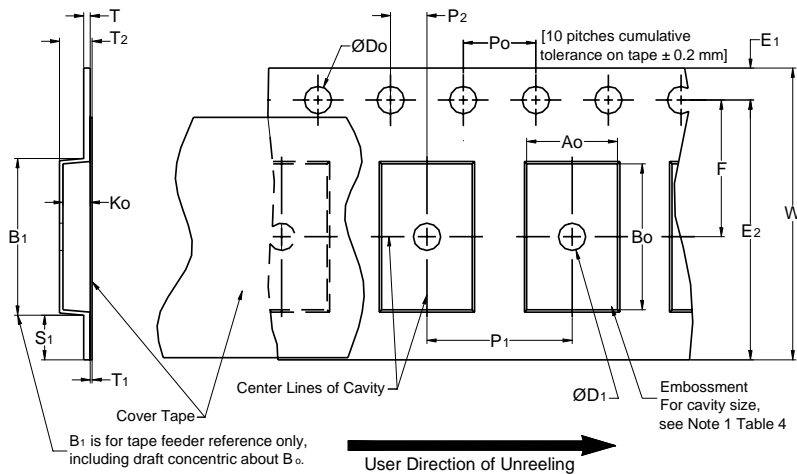

Table 4 – Embossed (Plastic) Carrier Tape Dimensions

Metric will govern

Constant Dimensions — Millimeters (Inches)									
Tape Size	D ₀	D ₁ Minimum Note 1	E ₁	P ₀	P ₂	R Reference Note 2	S ₁ Minimum Note 3	T Maximum	T ₁ Maximum
8 mm	1.5 +0.10/-0.0 (0.059 +0.004/-0.0)	1.0 (0.039)	1.75 ±0.10 (0.069 ±0.004)	4.0 ±0.10 (0.157 ±0.004)	2.0 ±0.05 (0.079 ±0.002)	25.0 (0.984)	0.600 (0.024)	0.600 (0.024)	0.100 (0.004)
12 mm		1.5 (0.059)				30 (1.181)			
16 mm									
Variable Dimensions — Millimeters (Inches)									
Tape Size	Pitch	B ₁ Maximum Note 4	E ₂ Minimum	F	P ₁	T ₂ Maximum	W Maximum	A ₀ , B ₀ & K ₀	
8 mm	Single (4 mm)	4.35 (0.171)	6.25 (0.246)	3.5 ±0.05 (0.138 ±0.002)	4.0 ±0.10 (0.157 ±0.004)	2.5 (0.098)	8.3 (0.327)	Note 5	
12 mm	Single (4 mm) & Double (8 mm)	8.2 (0.323)	10.25 (0.404)	5.5 ±0.05 (0.217 ±0.002)	8.0 ±0.10 (0.315 ±0.004)	4.6 (0.181)	12.3 (0.484)		
16 mm	Triple (12 mm)	12.1 (0.476)	14.25 (0.561)	5.5 ±0.05 (0.217 ±0.002)	8.0 ±0.10 (0.315 ±0.004)	4.6 (0.181)	16.3 (0.642)		

- The embossment hole location shall be measured from the sprocket hole controlling the location of the embossment. Dimensions of embossment location and hole location shall be applied independent of each other.
- The tape, with or without components, shall pass around R without damage (see Figure 5).
- If S₁ < 1.0 mm, there may not be enough area for cover tape to be properly applied (see EIA Standard 481-1, paragraph 4.3, section b).
- B₁ dimension is a reference dimension for tape feeder clearance only.
- The cavity defined by A₀, B₀ and K₀ shall surround the component with sufficient clearance that:
 - the component does not protrude above the top surface of the carrier tape.
 - the component can be removed from the cavity in a vertical direction without mechanical restriction, after the top cover tape has been removed.
 - rotation of the component is limited to 20° maximum for 8 and 12 mm tapes and 10° maximum for 16 mm tapes (see Figure 2).
 - lateral movement of the component is restricted to 0.5 mm maximum for 8 mm and 12 mm wide tape and to 1.0 mm maximum for 16 mm tape (see Figure 3).
 - see Addendum in EIA Standard 481-1 for standards relating to more precise taping requirements.

Packaging Information Performance Notes

1. Cover Tape Break Force: 1.0 Kg minimum.
2. Cover Tape Peel Strength: The total peel strength of the cover tape from the carrier tape shall be:

Tape Width	Peel Strength
8 mm	0.1 to 1.0 Newton (10 to 100 gf)
12 and 16 mm	0.1 to 1.3 Newton (10 to 130 gf)

The direction of the pull shall be opposite the direction of the carrier tape travel. The pull angle of the carrier tape shall be 165° to 180° from the plane of the carrier tape. During peeling, the carrier and/or cover tape shall be pulled at a velocity of 300 ±10 mm/minute.

3. Labeling: Bar code labeling (standard or custom) shall be on the side of the reel opposite the sprocket holes. Refer to EIA Standards 556 and 624.

Figure 2 – Maximum Component Rotation

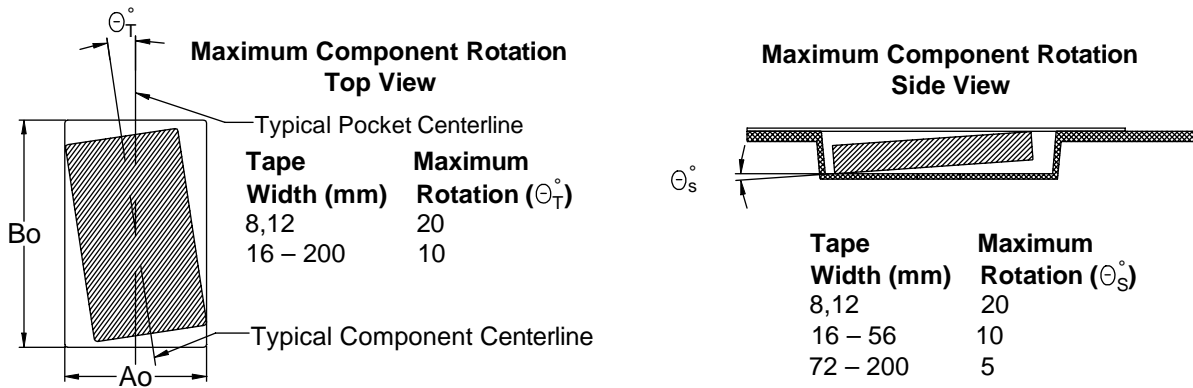

Figure 3 – Maximum Lateral Movement

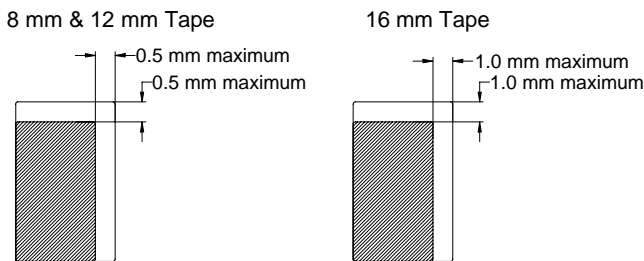

Figure 4 – Bending Radius

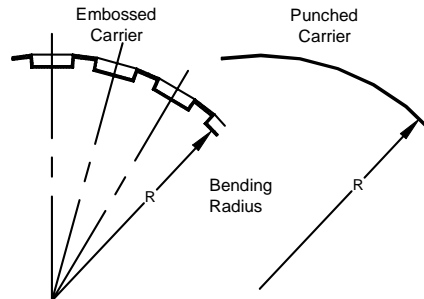
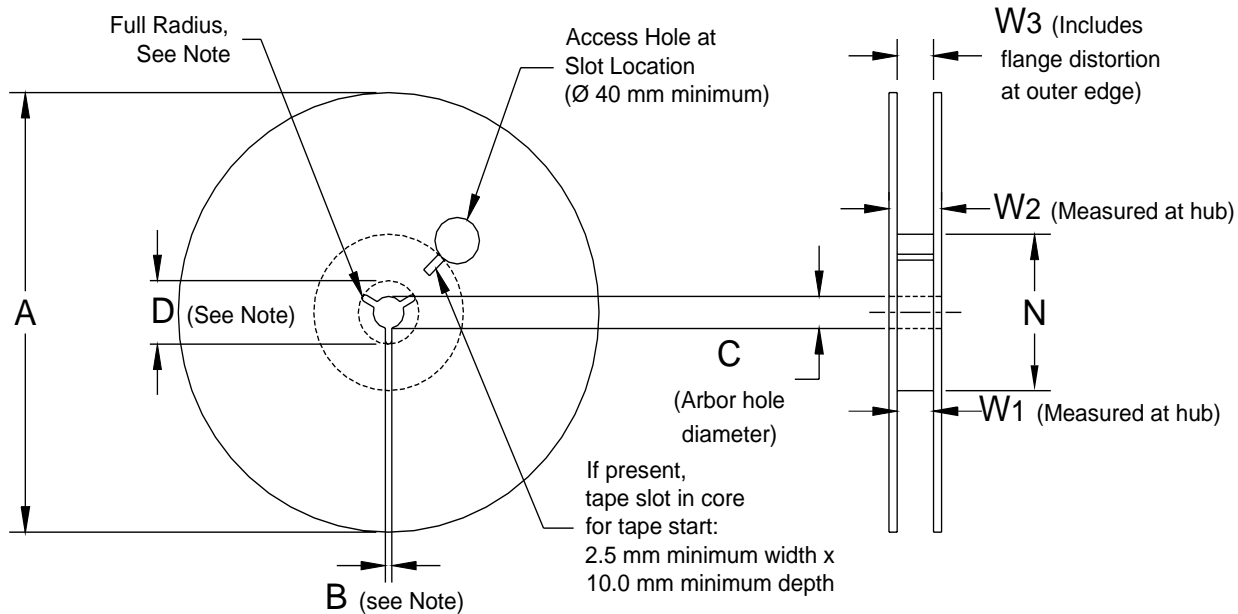

Figure 5 – Reel Dimensions



Note: Drive spokes optional; if used, dimensions B and D shall apply.

Table 5 – Reel Dimensions

Metric will govern

Constant Dimensions – Millimeters (Inches)				
Tape Size	A	B Minimum	C	D Minimum
8 mm	178 ±0.20 (7.008 ±0.008) or 330 ±0.20 (13.000 ±0.008)	1.5 (0.059)	13.0 +0.5/-0.2 (0.521 +0.02/-0.008)	20.2 (0.795)
12 mm				
16 mm				
Variable Dimensions – Millimeters (Inches)				
Tape Size	N Minimum	W ₁	W ₂ Maximum	W ₃
8 mm	50 (1.969)	8.4 +1.5/-0.0 (0.331 +0.059/-0.0)	14.4 (0.567)	Shall accommodate tape width without interference
12 mm		12.4 +2.0/-0.0 (0.488 +0.078/-0.0)	18.4 (0.724)	
16 mm		16.4 +2.0/-0.0 (0.646 +0.078/-0.0)	22.4 (0.882)	

Figure 6 – Tape Leader & Trailer Dimensions

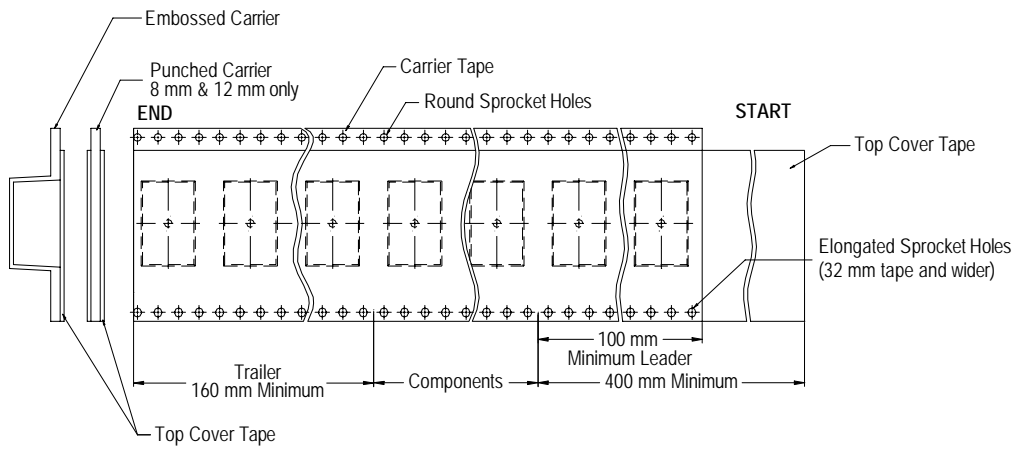
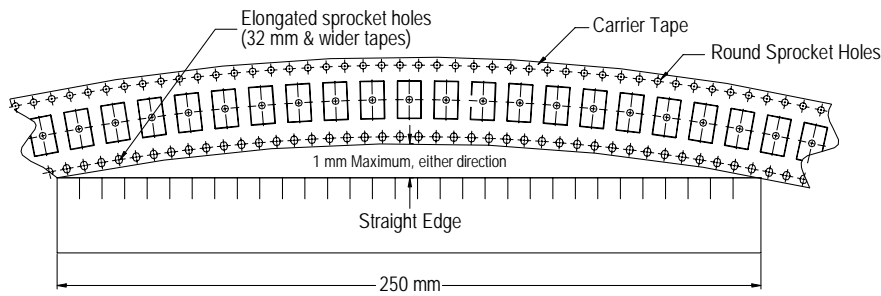

Figure 7 – Maximum Camber



KEMET Corporation World Headquarters

2835 KEMET Way
Simpsonville, SC 29681

Mailing Address:
P.O. Box 5928
Greenville, SC 29606

www.kemet.com
Tel: 864-963-6300
Fax: 864-963-6521

Corporate Offices
Fort Lauderdale, FL
Tel: 954-766-2800

North America

Southeast
Lake Mary, FL
Tel: 407-855-8886

Northeast
Wilmington, MA
Tel: 978-658-1663

Central
Novi, MI
Tel: 248-994-1030

West
Milpitas, CA
Tel: 408-433-9950

Mexico
Guadalajara, Jalisco
Tel: 52-33-3123-2141

Europe

Southern Europe
Paris, France
Tel: 33-1-4646-1006

Sasso Marconi, Italy
Tel: 39-051-939111

Central Europe
Landsberg, Germany
Tel: 49-8191-3350800

Kamen, Germany
Tel: 49-2307-438110

Northern Europe
Bishop's Stortford, United Kingdom
Tel: 44-1279-460122

Espoo, Finland
Tel: 358-9-5406-5000

Asia

Northeast Asia
Hong Kong
Tel: 852-2305-1168

Shenzhen, China
Tel: 86-755-2518-1306

Beijing, China
Tel: 86-10-5829-1711

Shanghai, China
Tel: 86-21-6447-0707

Taipei, Taiwan
Tel: 886-2-27528585

Southeast Asia
Singapore
Tel: 65-6586-1900

Penang, Malaysia
Tel: 60-4-6430200

Bangalore, India
Tel: 91-806-53-76817

Note: KEMET reserves the right to modify minor details of internal and external construction at any time in the interest of product improvement. KEMET does not assume any responsibility for infringement that might result from the use of KEMET Capacitors in potential circuit designs. KEMET is a registered trademark of KEMET Electronics Corporation.

Other KEMET Resources

Tools	
Resource	Location
Configure A Part: CapEdge	http://capacitoredge.kemet.com
SPICE & FIT Software	http://www.kemet.com/spice
Search Our FAQs: KnowledgeEdge	http://www.kemet.com/keask
Electrolytic LifeCalculator	http://www.kemet.com:8080/elc

Product Information	
Resource	Location
Products	http://www.kemet.com/products
Technical Resources (Including Soldering Techniques)	http://www.kemet.com/technicalpapers
RoHS Statement	http://www.kemet.com/rohs
Quality Documents	http://www.kemet.com/qualitydocuments

Product Request	
Resource	Location
Sample Request	http://www.kemet.com/sample
Engineering Kit Request	http://www.kemet.com/kits

Contact	
Resource	Location
Website	www.kemet.com
Contact Us	http://www.kemet.com/contact
Investor Relations	http://www.kemet.com/ir
Call Us	1-877-MyKEMET
Twitter	http://twitter.com/kemetcapacitors

Disclaimer

All product specifications, statements, information and data (collectively, the "Information") are subject to change without notice.

All Information given herein is believed to be accurate and reliable, but is presented without guarantee, warranty, or responsibility of any kind, expressed or implied.

Statements of suitability for certain applications are based on our knowledge of typical operating conditions for such applications, but are not intended to constitute – and we specifically disclaim – any warranty concerning suitability for a specific customer application or use. This Information is intended for use only by customers who have the requisite experience and capability to determine the correct products for their application. Any technical advice inferred from this Information or otherwise provided by us with reference to the use of our products is given gratis, and we assume no obligation or liability for the advice given or results obtained.

Although we design and manufacture our products to the most stringent quality and safety standards, given the current state of the art, isolated component failures may still occur. Accordingly, customer applications which require a high degree of reliability or safety should employ suitable designs or other safeguards (such as installation of protective circuitry or redundancies) in order to ensure that the failure of an electrical component does not result in a risk of personal injury or property damage.

Although all product-related warnings, cautions and notes must be observed, the customer should not assume that all safety measures are indicated or that other measures may not be required.

Product & Process Design

Sales & Marketing

Supplier

Material Management

Quality

Manufacturing

Logistics & Distribution

People: Leadership
& Development

KEMET Production System

Corporate Offices

KEMET Corporation
2835 KEMET Way
Simpsonville, SC 29681
USA
Tel: 864.963.6300
Fax: 864.963.6521

KEMET Electronics S.A.
15bis chemin des Mines
1202 Geneva
Switzerland
Tel: 41.22.715.0100
Fax: 41.22.715.0170

KEMET Electronics Marketing (S) Pte Ltd.
73 Bukit Timah Road
#05-01 Rex House
Singapore 229832
Tel: 65.6586.1900
Fax: 65.6586.1901

www.kemet.com

The Capacitance Company
KEMET
CHARGED[®]



**Стандарт
Электрон
Связь**

Мы молодая и активно развивающаяся компания в области поставок электронных компонентов. Мы поставляем электронные компоненты отечественного и импортного производства напрямую от производителей и с крупнейших складов мира.

Благодаря сотрудничеству с мировыми поставщиками мы осуществляем комплексные и плановые поставки широчайшего спектра электронных компонентов.

Собственная эффективная логистика и склад в обеспечивает надежную поставку продукции в точно указанные сроки по всей России.

Мы осуществляем техническую поддержку нашим клиентам и предпродажную проверку качества продукции. На все поставляемые продукты мы предоставляем гарантию .

Осуществляем поставки продукции под контролем ВП МО РФ на предприятия военно-промышленного комплекса России , а также работаем в рамках 275 ФЗ с открытием отдельных счетов в уполномоченном банке. Система менеджмента качества компании соответствует требованиям ГОСТ ISO 9001.

Минимальные сроки поставки, гибкие цены, неограниченный ассортимент и индивидуальный подход к клиентам являются основой для выстраивания долгосрочного и эффективного сотрудничества с предприятиями радиоэлектронной промышленности, предприятиями ВПК и научно-исследовательскими институтами России.

С нами вы становитесь еще успешнее!

Наши контакты:

Телефон: +7 812 627 14 35

Электронная почта: sales@st-electron.ru

Адрес: 198099, Санкт-Петербург,
Промышленная ул, дом № 19, литера Н,
помещение 100-Н Офис 331