

### Features

- ◆ Non-Magnetic Package Suitable for MRI Applications
- ◆ Rectangular MELF SMQ Ceramic Package
- ◆ Hermetically Sealed
- ◆ Low  $R_s$  for Low Series Loss
- ◆ Long  $\tau_L$  for Lower Intermodulation Distortion
- ◆ Low  $C_j$  for High Series Isolation
- ◆ High Average Incident Power Handling
- ◆ RoHS Compliant

### Description

The MA4P7441F-1091T is a surface mountable PIN diode in a non-magnetic, **Metal Electrode Leadless Faced (MELF)** package. The device incorporates M/A-COM Technology Solutions time proven HIPAX technology to produce a low inductance ceramic package with no ribbons or whisker wires. Incorporated in the package is a hard glass passivated, CERMACHIP™ PIN chip that is full face bonded on both the cathode and anode to maximize surface area for the lowest electrical and thermal resistance. The package utilizes a non-magnetic plating process that provides for a package with extremely low permeability. The MA4P7441F-1091T has been comprehensively characterized both electrically and mechanically to ensure repeatable and predictable performance. The non-magnetic MA4P7441F-1091T is the electrical equivalent of its magnetic counterpart the MA4P4001F-1091T.

### Applications

This diode is well suited for use in low loss, low distortion, high power switching circuits and can be used in high magnetic field environments at HF through UHF frequencies. The low thermal resistance of this device provides excellent performance at high RF power incident levels, up to 200 watts CW. This device is designed to meet the most demanding electrical and mechanical MRI environments.

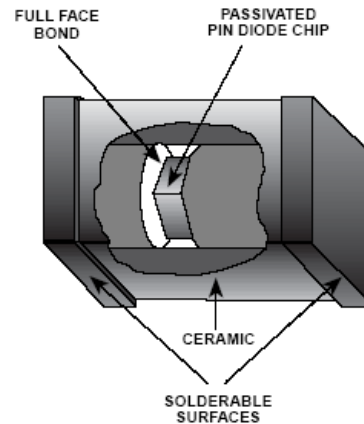

### Designed for Automated Assembly

These SMQ PIN diodes are designed for high volume tape and reel assembly. The rectangular package design provides for highly efficient automatic pick and place assembly techniques. The parallel flat surfaces are suitable for key jaw or vacuum pickup. All solderable surfaces are tin plated and compatible with reflow and vapor phase soldering methods.

### Absolute Maximum Ratings<sup>1</sup> @ 25°C

Parameter	Absolute Maximum
Operating Temperature	-65 °C to +125 °C
Storage Temperature	-65 °C to +150 °C
Diode Junction Temperature	+175 °C Continuous
Diode Mounting Temperature	+235 °C for 10 seconds
RF C.W. Incident Power	+ 53 dBm C.W.
Forward D.C. Current	+ 500 mA
Reverse D.C. Voltage @ -10uA	1 - 100 V I

1. Exceeding these limits may cause permanent damage.

1

**ADVANCED:** Data Sheets contain information regarding a product M/A-COM Technology Solutions is considering for development. Performance is based on target specifications, simulated results, and/or prototype measurements. Commitment to develop is not guaranteed.  
**PRELIMINARY:** Data Sheets contain information regarding a product M/A-COM Technology Solutions has under development. Performance is based on engineering tests. Specifications are typical. Mechanical outline has been fixed. Engineering samples and/or test data may be available. Commitment to produce in volume is not guaranteed.

• **North America** Tel: 800.366.2266 • **Europe** Tel: +353.21.244.6400  
 • **India** Tel: +91.80.43537383 • **China** Tel: +86.21.2407.1588  
 Visit [www.macomtech.com](http://www.macomtech.com) for additional data sheets and product information.

M/A-COM Technology Solutions Inc. and its affiliates reserve the right to make changes to the product(s) or information contained herein without notice.

### Electrical Specifications @ +25 °C

Parameter	Symbol	Condition	Minimum	Maximum	Nominal
Forward Voltage	$V_F$	$I_F = +100 \text{ mA}$	-	$.9 V_{DC}$	-
Voltage Rating	$V_R$	$I_r = -10 \text{ }\mu\text{A}$	$I - 100 I V_{DC}$	-	-
Total Capacitance	$C_T$	$-100 \text{ V @ } 100 \text{ MHz}$	-	2.2 pF	-
Series Resistance	$R_S$	$+100 \text{ mA @ } 100 \text{ MHz}$	-	0.5 $\Omega$	-
Parallel Resistance	$R_P$	$-10 \text{ V @ } 100 \text{ MHz}$	20 K $\Omega$	-	-
Carrier Lifetime	$\tau_L$	+6 mA / -10 mA (50% - 90% Voltage)	-	-	18 $\mu\text{s}$
I-Region Length	$\mu\text{m}$	-	-	-	175 $\mu\text{m}$
C.W. Thermal Resistance	$\theta$	-	-	5°C/W	-
Power Dissipation in Free Air	W	$I_F = +100 \text{ mA}$	-	9W	-
Power Dissipation	$P_D$	$I_F = +100 \text{ mA}$	-	30W	-

### Environmental Capability

MELF devices are appropriate for use in industrial and military applications and can be screened to meet the environmental requirements of MIL-STD-750, MIL-STD-202 as well as other military standards. The table below lists some of the MIL-STD 750 tests the device is designed to meet.

Test	Method	Description
High Temperature Storage	1031	+150°C, for 340 Hours
Temperature Shock	1051	-65°C to +150°C, 20 Cycles
HTRB	1038	80% of rated $V_B$ , +150°C, for 96 Hours
Moisture Resistance	1021	No Initial Conditioning, 85% RH, +85°C
Gross Leak	1071 Cond. E	Dye Penetrant Visual
Vibration Fatigue	2046	20,000G's, 60Hz, x, y, z axis
Solderability	2026	Test Temperature = +245°C

## Typical Electrical Performance

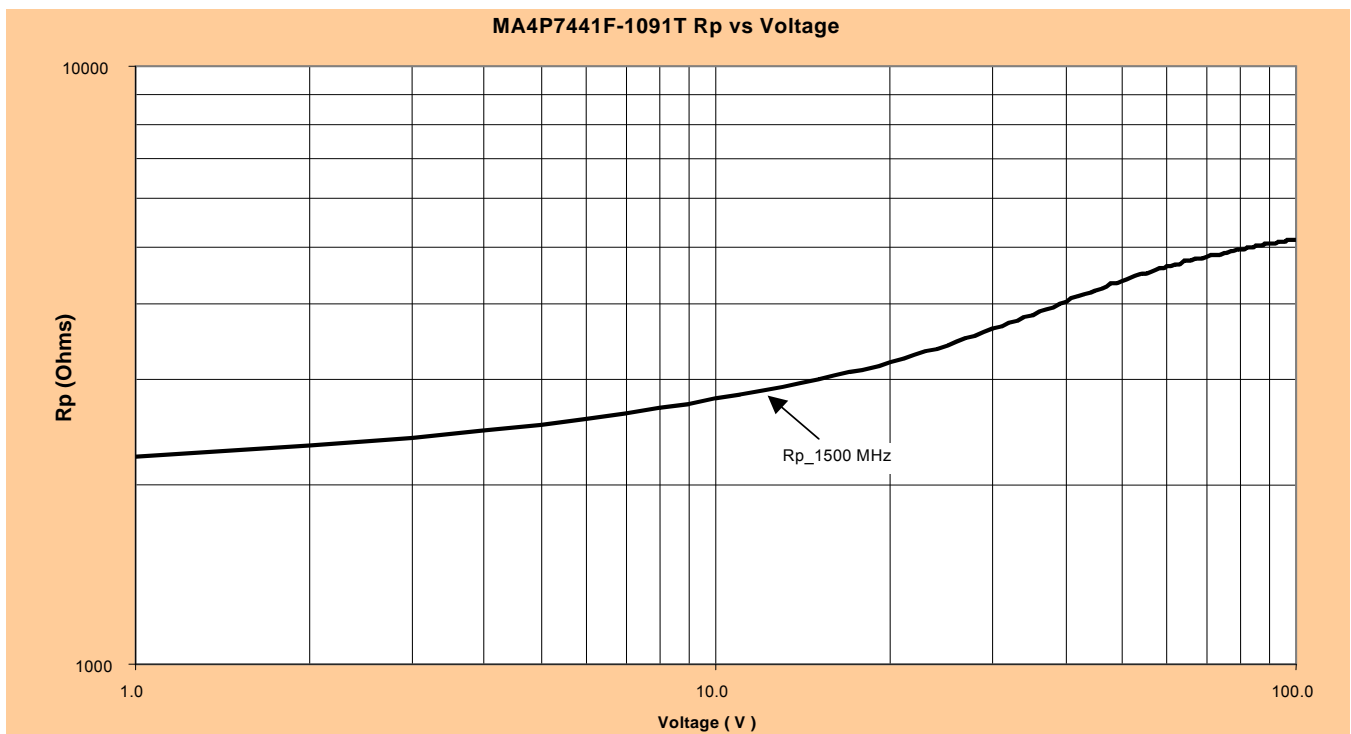
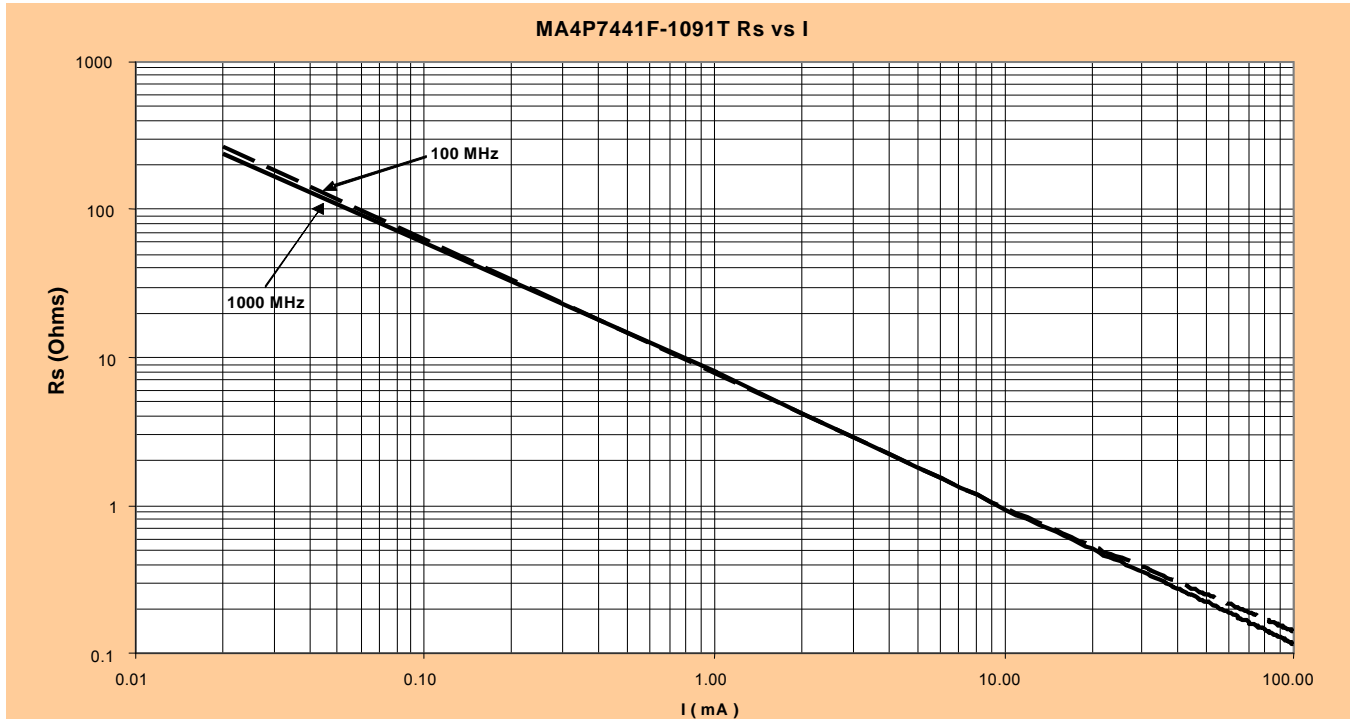

3

**ADVANCED:** Data Sheets contain information regarding a product M/A-COM Technology Solutions is considering for development. Performance is based on target specifications, simulated results, and/or prototype measurements. Commitment to develop is not guaranteed.  
**PRELIMINARY:** Data Sheets contain information regarding a product M/A-COM Technology Solutions has under development. Performance is based on engineering tests. Specifications are typical. Mechanical outline has been fixed. Engineering samples and/or test data may be available. Commitment to produce in volume is not guaranteed.

• **North America** Tel: 800.366.2266 • **Europe** Tel: +353.21.244.6400  
 • **India** Tel: +91.80.43537383 • **China** Tel: +86.21.2407.1588  
 Visit [www.macomtech.com](http://www.macomtech.com) for additional data sheets and product information.

M/A-COM Technology Solutions Inc. and its affiliates reserve the right to make changes to the product(s) or information contained herein without notice.

## Typical Electrical Performance

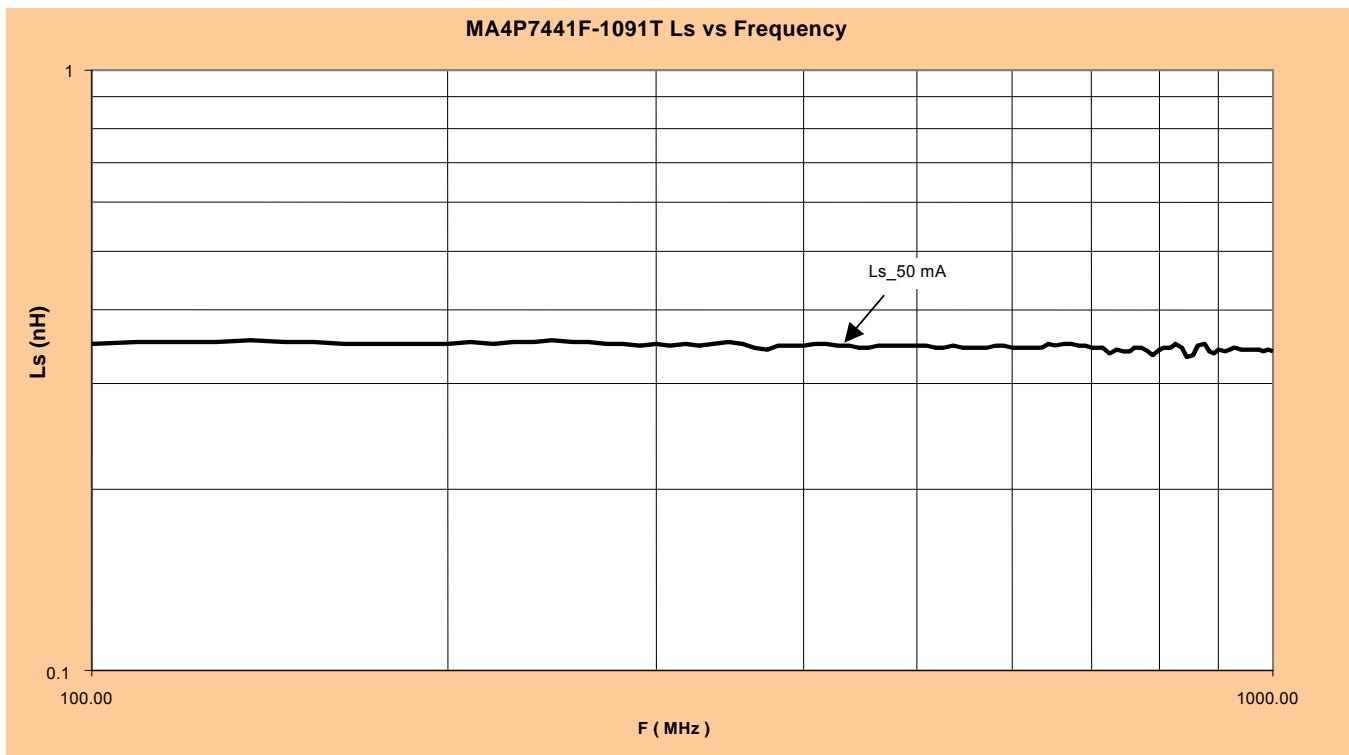
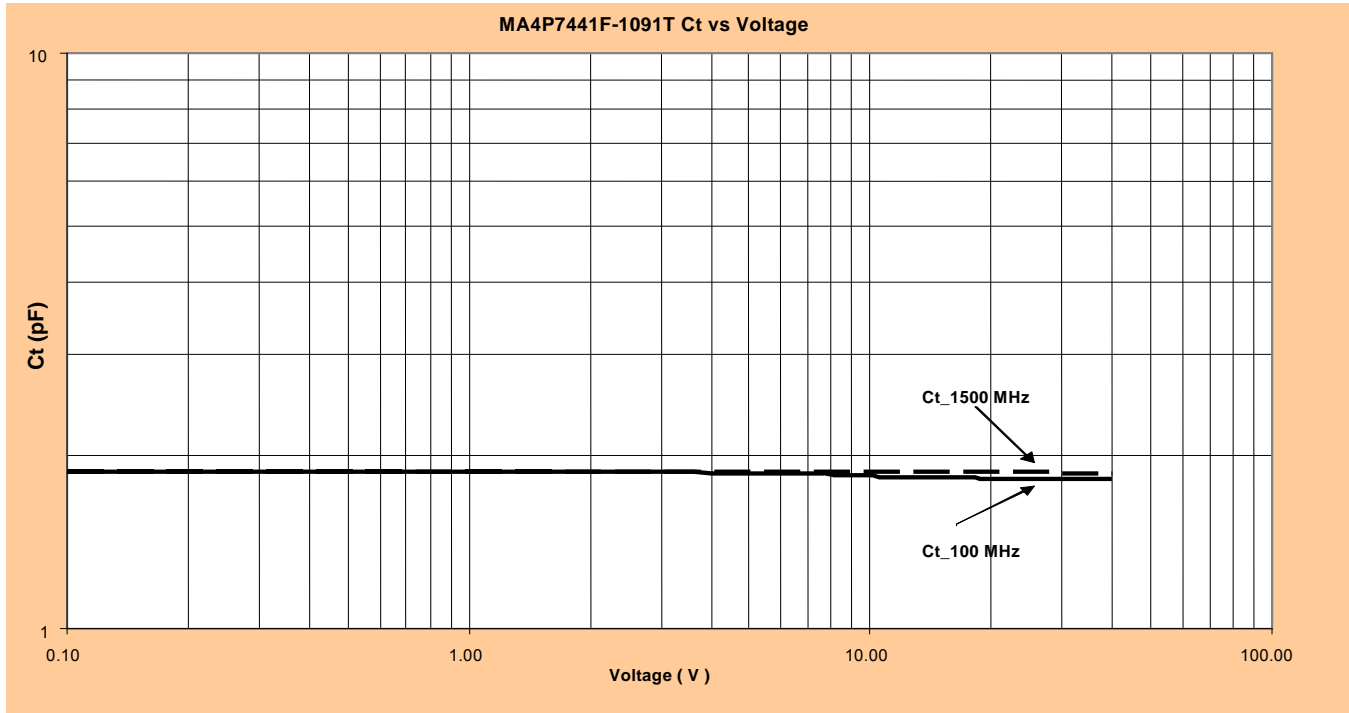

4

**ADVANCED:** Data Sheets contain information regarding a product M/A-COM Technology Solutions is considering for development. Performance is based on target specifications, simulated results, and/or prototype measurements. Commitment to develop is not guaranteed.  
**PRELIMINARY:** Data Sheets contain information regarding a product M/A-COM Technology Solutions has under development. Performance is based on engineering tests. Specifications are typical. Mechanical outline has been fixed. Engineering samples and/or test data may be available. Commitment to produce in volume is not guaranteed.

• North America Tel: 800.366.2266 • Europe Tel: +353.21.244.6400  
 • India Tel: +91.80.43537383 • China Tel: +86.21.2407.1588  
 Visit [www.macomtech.com](http://www.macomtech.com) for additional data sheets and product information.

*M/A-COM Technology Solutions Inc. and its affiliates reserve the right to make changes to the product(s) or information contained herein without notice.*

## Typical Non-Magnetic Performance

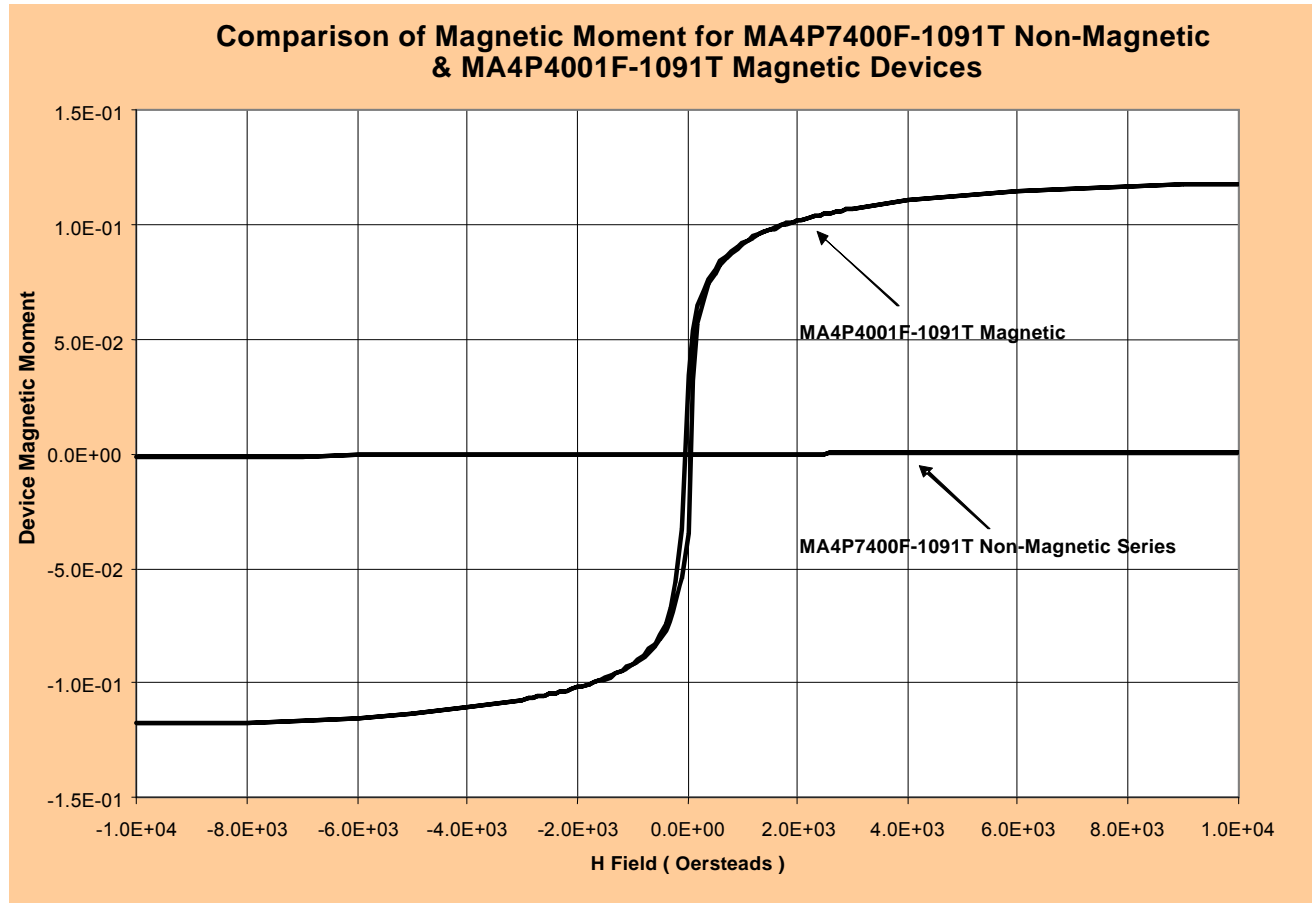

### Typical Magnetic Properties of Non-Magnetic MA4P7441F-1091T Device vs. Conventional MA4P4001F-1091T Magnetic Device

Magnetic Property	MA4P7441F-1091T	MA4P4001-1091T
Saturation Moment (EMU) @ H = H <sub>MAX</sub> Oersteds	1.0 x E-3	1.2 x E-1
Remanance Moment (EMU) @ H = 0 Oersteds	1.5 x E-6	3.4 x E-2
Coercivity (Oersteds) @ EMU = 0 Moment	3.0	51.3

## Mechanical Information

### 1091 MELF Surface Mount Package

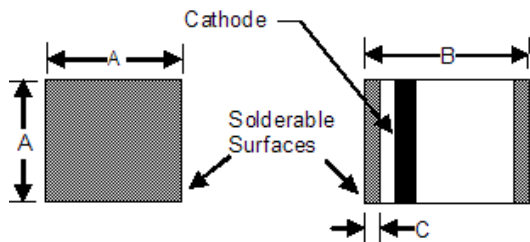

### Circuit Pad Layout for 1091 MELF Diodes

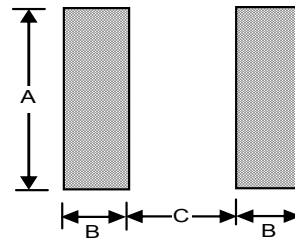

Case Style	Dimensions in Inches (mm)		
	A Square Min / Max	B Min / Max	C Min / Max
1091	0.138 / 0.155 (3.50 / 3.94)	0.180 / 0.200 (4.57 / 5.08)	0.008 / 0.030 (.203 / .762)

Dimension	Package Style 1091	
	inches	mm
A	0.150	3.81
B	0.050	1.27
C	0.100	2.54

## MELF Assembly Recommendations

- ◆ Devices may be soldered using standard 60Sn/40Pb or RoHS compliant solders. All solderable surfaces of MELF devices are tin plated 50  $\mu$ m thick to ensure an optimum connection.
- ◆ For recommended Sn/Pb and RoHS soldering profiles See Application Note [M538](#) on the M/A-COM Tech website.

## Ordering Information

Part Number	Package
MA4P7441F-1091T	Tape and Reel



**Стандарт  
Электрон  
Связь**

Мы молодая и активно развивающаяся компания в области поставок электронных компонентов. Мы поставляем электронные компоненты отечественного и импортного производства напрямую от производителей и с крупнейших складов мира.

Благодаря сотрудничеству с мировыми поставщиками мы осуществляем комплексные и плановые поставки широчайшего спектра электронных компонентов.

Собственная эффективная логистика и склад в обеспечивает надежную поставку продукции в точно указанные сроки по всей России.

Мы осуществляем техническую поддержку нашим клиентам и предпродажную проверку качества продукции. На все поставляемые продукты мы предоставляем гарантию .

Осуществляем поставки продукции под контролем ВП МО РФ на предприятия военно-промышленного комплекса России , а также работаем в рамках 275 ФЗ с открытием отдельных счетов в уполномоченном банке. Система менеджмента качества компании соответствует требованиям ГОСТ ISO 9001.

Минимальные сроки поставки, гибкие цены, неограниченный ассортимент и индивидуальный подход к клиентам являются основой для выстраивания долгосрочного и эффективного сотрудничества с предприятиями радиоэлектронной промышленности, предприятиями ВПК и научно-исследовательскими институтами России.

С нами вы становитесь еще успешнее!

**Наши контакты:**

**Телефон:** +7 812 627 14 35

**Электронная почта:** [sales@st-electron.ru](mailto:sales@st-electron.ru)

**Адрес:** 198099, Санкт-Петербург,  
Промышленная ул, дом № 19, литера Н,  
помещение 100-Н Офис 331