

Power management (dual transistors)

EMZ8 / UMZ8N

●Feature

- 1) Both a 2SA2018 chip and 2SC2412K chip in a EMT or UMT package.

●Equivalent circuits

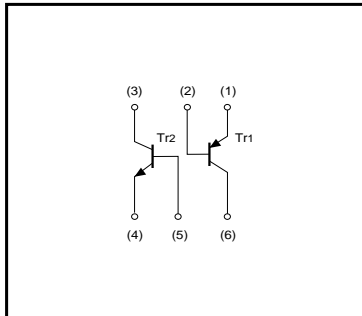

●Dimensions(Unit : mm)

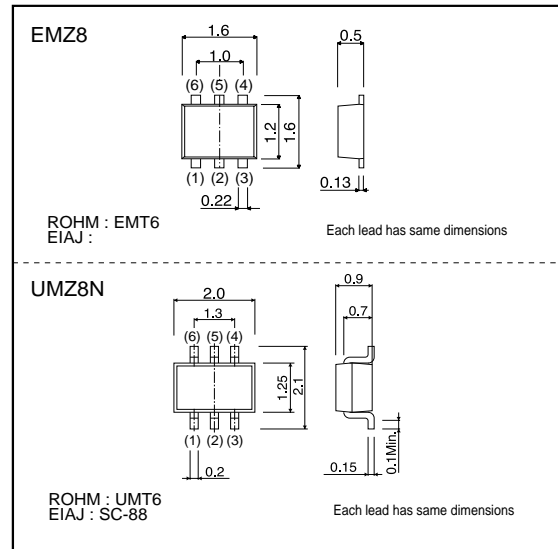

●Absolute maximum ratings (Ta=25°C)

Parameter	Symbol	Limits		Unit
		Tr1	Tr2	
Collector-base voltage	V _{CB0}	-15	60	V
Collector-emitter voltage	V _{CE0}	-12	50	V
Emitter-base voltage	V _{EB0}	-6	7	V
Collector current	I _c	-500	150	mA
	I _{CP}	-1	-	A
Collector power dissipation	P _c	150 (TOTAL)		mW *
Junction temperature	T _j	150		°C
Storage temperature	T _{stg}	-55 to +150		°C

* 120mW per element must not be exceeded.

●Package, marking, and packaging specifications

Part No.	EMZ8	UMZ8N
Package	EMT6	UMT6
Marking	Z8	Z8
Code	T2R	TR
Basic ordering unit (pieces)	8000	3000

Transistors

●Electrical characteristics (Ta=25°C)

Tr1

Parameter	Symbol	Min.	Typ.	Max.	Unit	Conditions
Collector-base breakdown voltage	BV _{CB0}	-15	-	-	V	I _C = -10μA
Collector-emitter breakdown voltage	BV _{CEO}	-12	-	-	V	I _C = -1mA
Emitter-base breakdown voltage	BV _{EB0}	-6	-	-	V	I _E = -10μA
Collector cutoff current	I _{CB0}	-	-	-0.1	μA	V _{CB} = -15V
Emitter cutoff current	I _{EB0}	-	-	-0.1	μA	V _{EB} = -6V
Collector-emitter saturation voltage	V _{CE(sat)}	-	-0.1	-0.25	V	I _C /I _B = -200mA/-10mA
DC current transfer ratio	h _{FE}	270	-	680	-	V _{CE} = -2V, I _C = -10mA
Transition frequency	f _r	-	260	-	MHz	V _{CE} = -2V, I _E = 10mA, f = 100MHz
Output capacitance	C _{ob}	-	6.5	-	pF	V _{CB} = -10V, I _E = 0A, f = 1MHz

Tr2

Parameter	Symbol	Min.	Typ.	Max.	Unit	Conditions
Collector-base breakdown voltage	BV _{CB0}	60	-	-	V	I _C = 50μA
Collector-emitter breakdown voltage	BV _{CEO}	50	-	-	V	I _C = 1mA
Emitter-base breakdown voltage	BV _{EB0}	7	-	-	V	I _E = 50μA
Collector cutoff current	I _{CB0}	-	-	0.1	μA	V _{CB} = 60V
Emitter cutoff current	I _{EB0}	-	-	0.1	μA	V _{EB} = 7V
Collector-emitter saturation voltage	V _{CE(sat)}	-	-	0.4	V	I _C /I _B = 50mA/5mA
DC current transfer ratio	h _{FE}	120	-	560	-	V _{CE} = 6V, I _C = 1mA
Transition frequency	f _r	-	180	-	MHz	V _{CE} = 12V, I _E = -2mA, f = 100MHz
Output capacitance	C _{ob}	-	2	3.5	pF	V _{CB} = 12V, I _E = 0A, f = 1MHz

●Electrical characteristic curves

<Tr1>

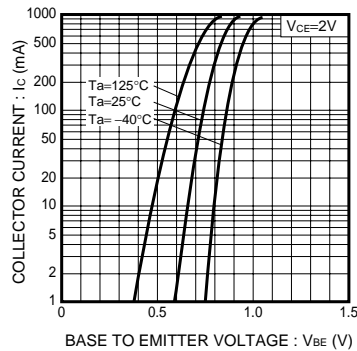

Fig.1 Grounded Emitter Propagation Characteristics

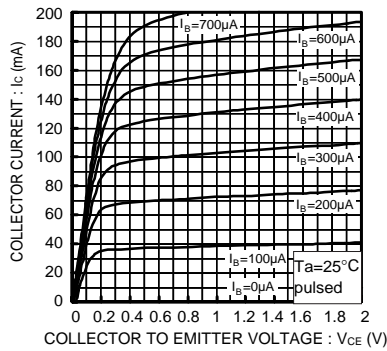

Fig.2 Typical Output Characteristics

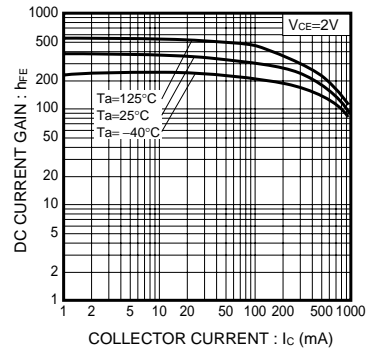

Fig.3 DC Current Gain vs. Collector Current

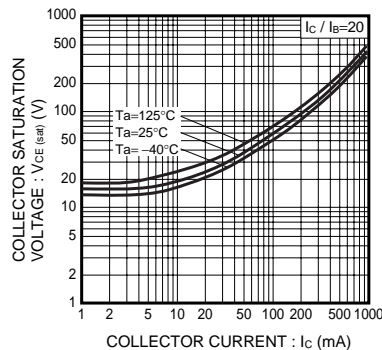

Fig.4 Collector-Emitter Saturation Voltage vs. Collector Current (I)

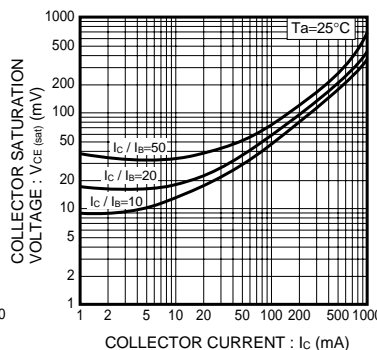

Fig.5 Collector-Emitter Saturation Voltage vs. Collector Current (II)

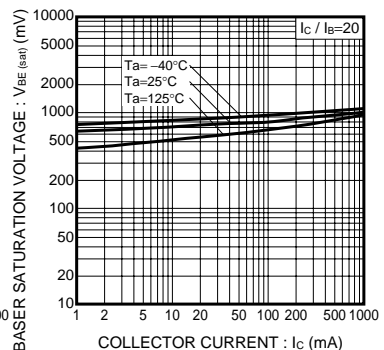

Fig.6 Base-Emitter Saturation Voltage vs. Collector Current

Transistors

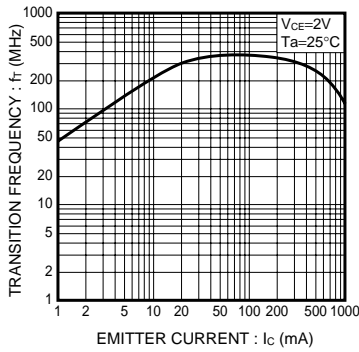

Fig.7 Gain Bandwidth Product vs. Emitter Current

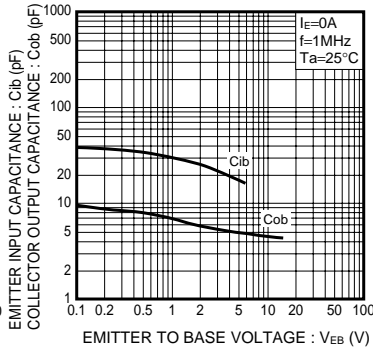

Fig.8 Collector Output Capacitance vs. Collector-Base Voltage
Emitter Input Capacitance vs. Emitter-Base Voltage

<Tr>

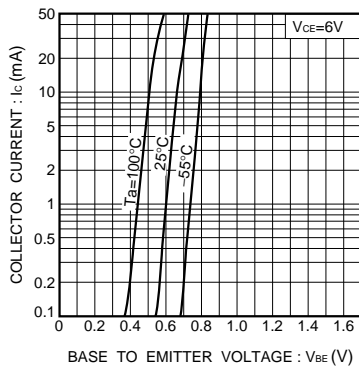

Fig.1 Grounded emitter propagation characteristics

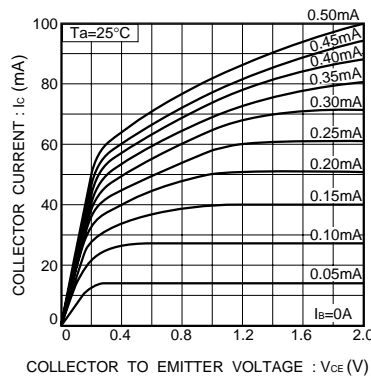

Fig.2 Grounded emitter output characteristics (I)

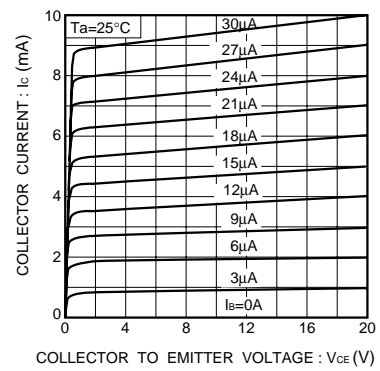

Fig.3 Grounded emitter output characteristics (II)

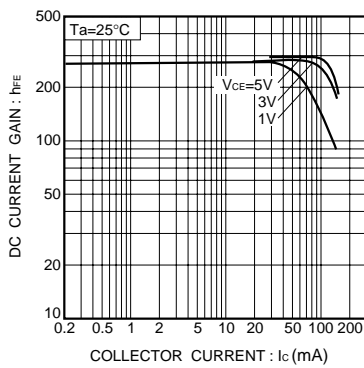

Fig.4 DC current gain vs. collector current (I)

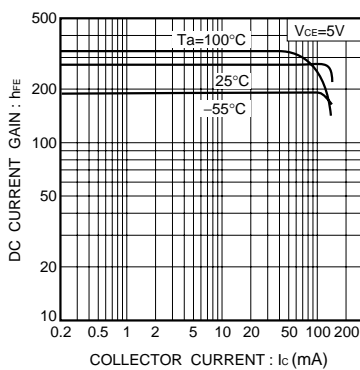

Fig.5 DC current gain vs. collector current (II)

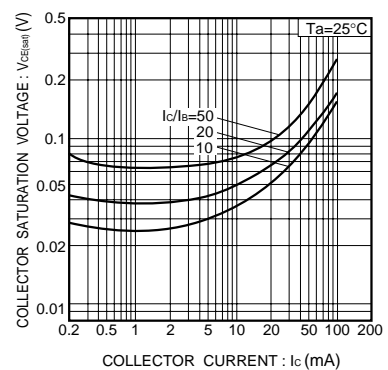

Fig.6 Collector-emitter saturation voltage vs. collector current

Transistors

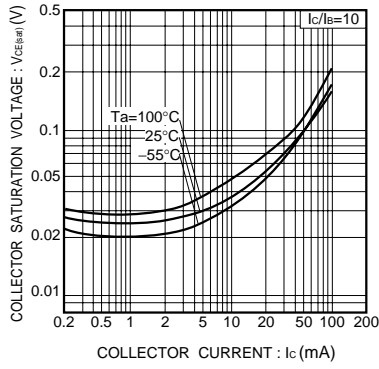

Fig.7 Collector-emitter saturation voltage vs. collector current (I)

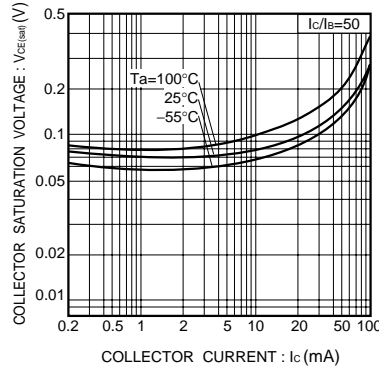

Fig.8 Collector-emitter saturation voltage vs. collector current (II)

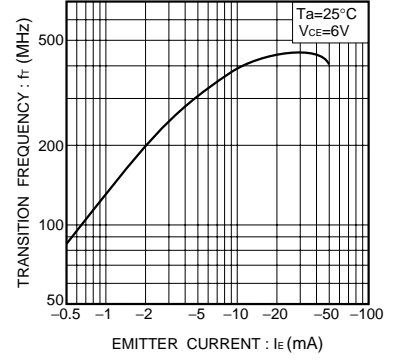

Fig.9 Gain bandwidth product vs. emitter current

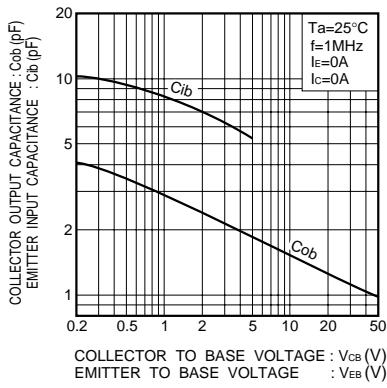

Fig.10 Collector output capacitance vs. collector-base voltage
Emitter input capacitance vs. emitter-base voltage

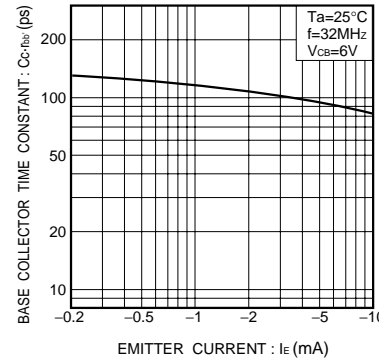

Fig.11 Base-collector time constant vs. emitter current

Notes

- No technical content pages of this document may be reproduced in any form or transmitted by any means without prior permission of ROHM CO.,LTD.
- The contents described herein are subject to change without notice. The specifications for the product described in this document are for reference only. Upon actual use, therefore, please request that specifications to be separately delivered.
- Application circuit diagrams and circuit constants contained herein are shown as examples of standard use and operation. Please pay careful attention to the peripheral conditions when designing circuits and deciding upon circuit constants in the set.
- Any data, including, but not limited to application circuit diagrams information, described herein are intended only as illustrations of such devices and not as the specifications for such devices. ROHM CO.,LTD. disclaims any warranty that any use of such devices shall be free from infringement of any third party's intellectual property rights or other proprietary rights, and further, assumes no liability of whatsoever nature in the event of any such infringement, or arising from or connected with or related to the use of such devices.
- Upon the sale of any such devices, other than for buyer's right to use such devices itself, resell or otherwise dispose of the same, no express or implied right or license to practice or commercially exploit any intellectual property rights or other proprietary rights owned or controlled by
- ROHM CO., LTD. is granted to any such buyer.
- Products listed in this document are no antiradiation design.

The products listed in this document are designed to be used with ordinary electronic equipment or devices (such as audio visual equipment, office-automation equipment, communications devices, electrical appliances and electronic toys).

Should you intend to use these products with equipment or devices which require an extremely high level of reliability and the malfunction of which would directly endanger human life (such as medical instruments, transportation equipment, aerospace machinery, nuclear-reactor controllers, fuel controllers and other safety devices), please be sure to consult with our sales representative in advance.

It is our top priority to supply products with the utmost quality and reliability. However, there is always a chance of failure due to unexpected factors. Therefore, please take into account the derating characteristics and allow for sufficient safety features, such as extra margin, anti-flammability, and fail-safe measures when designing in order to prevent possible accidents that may result in bodily harm or fire caused by component failure. ROHM cannot be held responsible for any damages arising from the use of the products under conditions out of the range of the specifications or due to non-compliance with the NOTES specified in this catalog.

Thank you for your accessing to ROHM product informations.

More detail product informations and catalogs are available, please contact your nearest sales office.

ROHM Customer Support System

THE AMERICAS / EUROPE / ASIA / JAPAN

www.rohm.com

Contact us : webmaster@rohm.co.jp



Стандарт Электрон Связь

Мы молодая и активно развивающаяся компания в области поставок электронных компонентов. Мы поставляем электронные компоненты отечественного и импортного производства напрямую от производителей и с крупнейших складов мира.

Благодаря сотрудничеству с мировыми поставщиками мы осуществляем комплексные и плановые поставки широчайшего спектра электронных компонентов.

Собственная эффективная логистика и склад в обеспечивает надежную поставку продукции в точно указанные сроки по всей России.

Мы осуществляем техническую поддержку нашим клиентам и предпродажную проверку качества продукции. На все поставляемые продукты мы предоставляем гарантию .

Осуществляем поставки продукции под контролем ВП МО РФ на предприятия военно-промышленного комплекса России , а также работаем в рамках 275 ФЗ с открытием отдельных счетов в уполномоченном банке. Система менеджмента качества компании соответствует требованиям ГОСТ ISO 9001.

Минимальные сроки поставки, гибкие цены, неограниченный ассортимент и индивидуальный подход к клиентам являются основой для выстраивания долгосрочного и эффективного сотрудничества с предприятиями радиоэлектронной промышленности, предприятиями ВПК и научно-исследовательскими институтами России.

С нами вы становитесь еще успешнее!

Наши контакты:

Телефон: +7 812 627 14 35

Электронная почта: sales@st-electron.ru

Адрес: 198099, Санкт-Петербург,
Промышленная ул, дом № 19, литера Н,
помещение 100-Н Офис 331