

LQA30T150C, LQA30B150C Qspeed™ Family

150 V, 30 A Common-Cathode Diode

Product Summary

$I_{F(AVG)}$ per diode	15	A
V_{RRM}	150	V
Q_{RR} (Typ at 125 °C)	31.5	nC
I_{RRM} (Typ at 125 °C)	1.82	A
Softness t_p/t_a (Typ at 125 °C)	0.55	

Pin Assignment

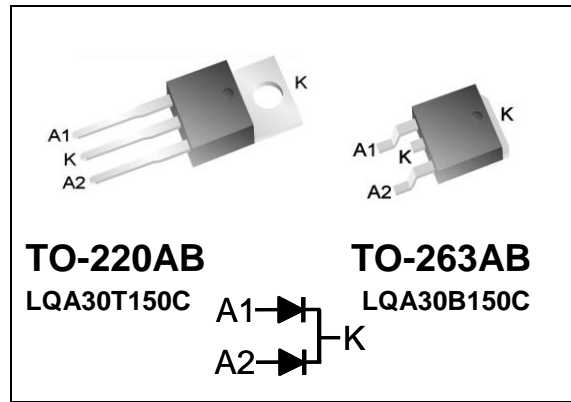

RoHS Compliant

Package uses Lead-free plating and "Green" mold compound Halogen free per IEC 61249-2-21.

General Description

This device has the lowest Q_{RR} of any 150 V Silicon diode. Its recovery characteristics increase efficiency, reduce EMI and eliminate snubbers.

Applications

- AC/DC and DC/DC output rectification
 - Output and freewheeling diodes
- Motor drive circuits
- DC-AC inverters

Features

- Low Q_{RR} , Low I_{RRM} , Low t_{RR}
- High di_f/dt capable
- Soft recovery

Benefits

- Increases efficiency
 - Eliminates need for snubber circuits
 - Reduces EMI filter component size and count
- Enables extremely fast switching

Absolute Maximum Ratings

Absolute maximum ratings are the values beyond which the device may be damaged or have its useful life impaired. Functional operation under these conditions is not implied.

Symbol	Parameter	Conditions	Rating	Units
V_{RRM}	Peak repetitive reverse voltage	$T_J = 25\text{ °C}$	150	V
$I_{F(AVG)}$	Average forward current	Per Diode, $T_J = 150\text{ °C}$, $T_C = 120\text{ °C}$ Per Device, $T_J = 150\text{ °C}$, $T_C = 120\text{ °C}$	15 30	A A
I_{FSM}	Non-repetitive peak surge current	Per Diode, 60 Hz, ½ cycle	130	A
I_{FSM}	Non-repetitive peak surge current	Per Diode, ½ cycle of $t = 28\text{ }\mu\text{s}$ Sinusoid, $T_C = 25\text{ °C}$	350	A
T_J	Operating junction temperature range		-55 to 150	°C
T_{STG}	Storage temperature		-55 to 150	°C
	Lead soldering temperature	Leads at 1.6 mm from case, 10 sec	300	°C
P_D	Power dissipation	$T_C = 25\text{ °C}$	56.8	W

Thermal Resistance

Symbol	Resistance from:	Conditions	Rating	Units
$R_{\theta JA}$	Junction to ambient	TO-220AB (only)	62	°C/W
$R_{\theta JC}$	Junction to case	Per Diode	2.2	°C/W
		Per Device	1.1	°C/W

Electrical Specifications at $T_J = 25\text{ }^\circ\text{C}$ (unless otherwise specified)

Symbol	Parameter	Conditions	Min	Typ	Max	Units	
DC Characteristics per diode							
I_R	Reverse current per diode	$V_R = 150\text{ V}, T_J = 25\text{ }^\circ\text{C}$	-	-	500	μA	
		$V_R = 150\text{ V}, T_J = 125\text{ }^\circ\text{C}$	-	0.27	-	mA	
V_F	Forward voltage per diode	$I_F = 15\text{ A}, T_J = 25\text{ }^\circ\text{C}$	-	0.98	1.2	V	
		$I_F = 15\text{ A}, T_J = 150\text{ }^\circ\text{C}$	-	0.86	-	V	
C_J	Junction capacitance per diode	$V_R = 10\text{ V}, 1\text{ MHz}$	-	54	-	pF	
Dynamic Characteristics per diode							
t_{RR}	Reverse recovery time, per diode	$di_F/dt = 100\text{ A}/\mu\text{s}$ $V_R = 100\text{ V},$ $I_F = 15\text{ A}$	$T_J = 25\text{ }^\circ\text{C}$	-	16.3	-	ns
			$T_J = 125\text{ }^\circ\text{C}$	-	28.7	-	ns
Q_{RR}	Reverse recovery charge, per diode	$di_F/dt = 100\text{ A}/\mu\text{s}$ $V_R = 100\text{ V},$ $I_F = 15\text{ A}$	$T_J = 25\text{ }^\circ\text{C}$	-	10.3	25.0	nC
			$T_J = 125\text{ }^\circ\text{C}$	-	31.5	-	nC
I_{RRM}	Maximum reverse recovery current, per diode	$di_F/dt = 100\text{ A}/\mu\text{s}$ $V_R = 100\text{ V},$ $I_F = 15\text{ A}$	$T_J = 25\text{ }^\circ\text{C}$	-	1.02	2.32	A
			$T_J = 125\text{ }^\circ\text{C}$	-	1.82	-	A
S	Softness per diode = $\frac{t_b}{t_a}$	$di_F/dt = 100\text{ A}/\mu\text{s}$ $V_R = 100\text{ V},$ $I_F = 15\text{ A}$	$T_J = 25\text{ }^\circ\text{C}$	-	0.63	-	
			$T_J = 125\text{ }^\circ\text{C}$	-	0.55	-	

Note to component engineers: Q-Series diodes employ Schottky technologies in their design and construction. Therefore, component engineers should plan their test setups to be similar to traditional Schottky test setups. (For further details, see application note AN-300.)

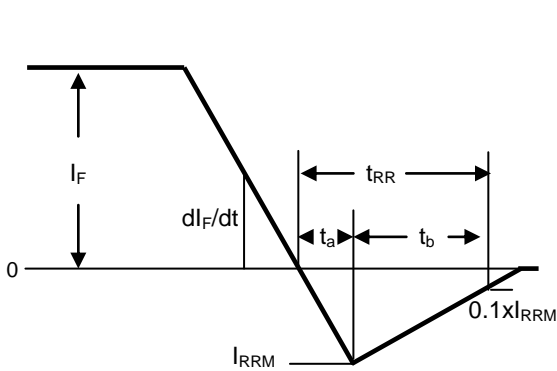

Figure 1. Reverse Recovery Definitions

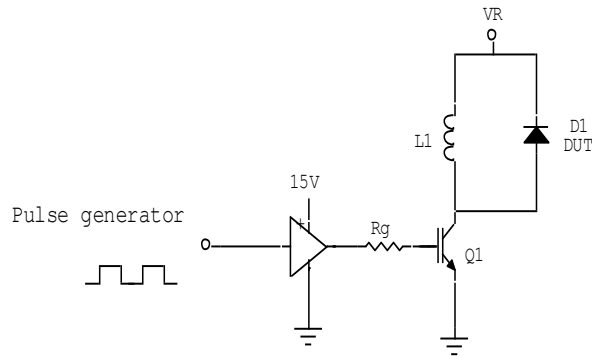

Figure 2. Reverse Recovery Test Circuit

Electrical Specifications at $T_J = 25\text{ }^\circ\text{C}$ (unless otherwise specified)

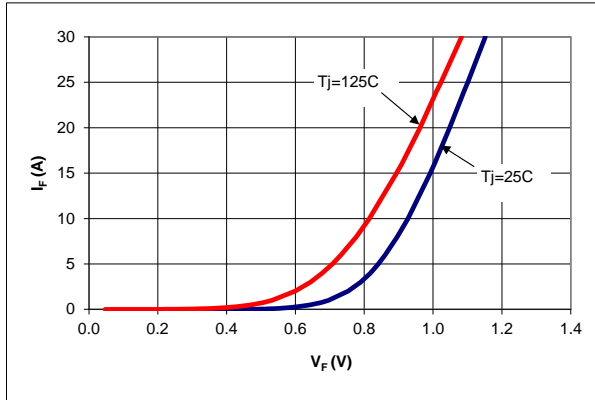

Figure 3. Typical I_F vs V_F

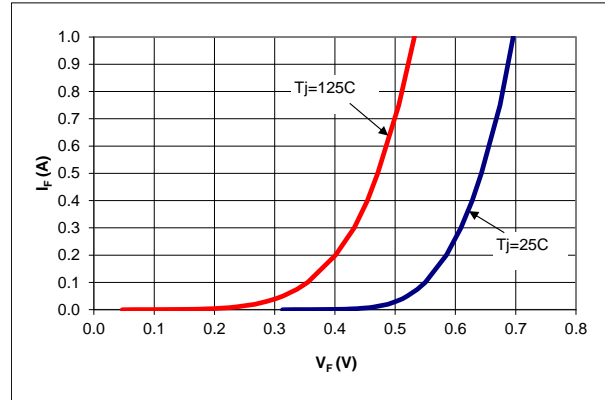

Figure 4. Typical I_F vs V_F

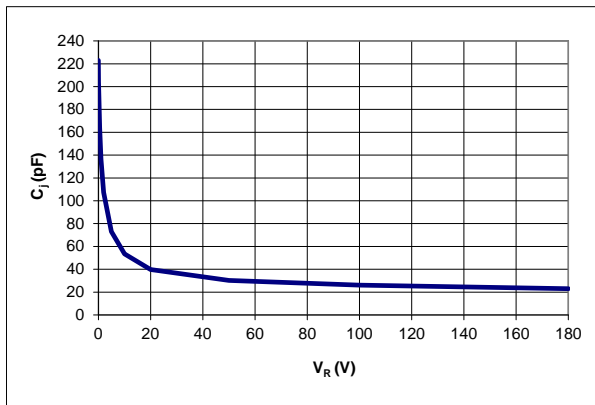

Figure 5. Typical C_i vs V_R

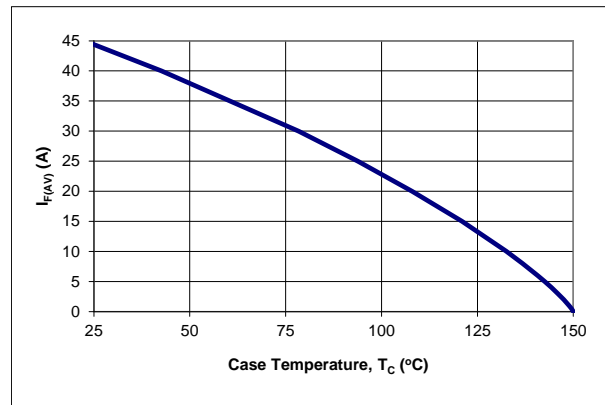

Figure 6. DC Current Derating Curve

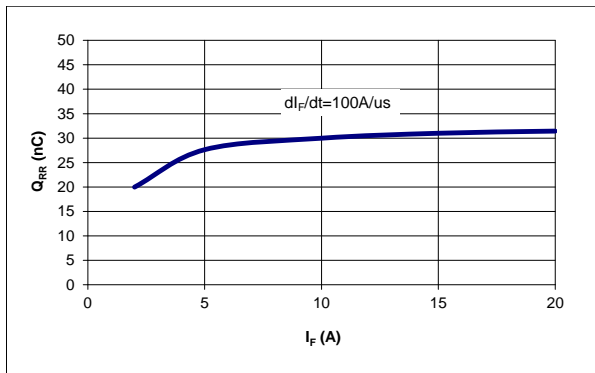

Figure 7. Typical Q_{RR} vs I_F at $T_J=125\text{ }^\circ\text{C}$

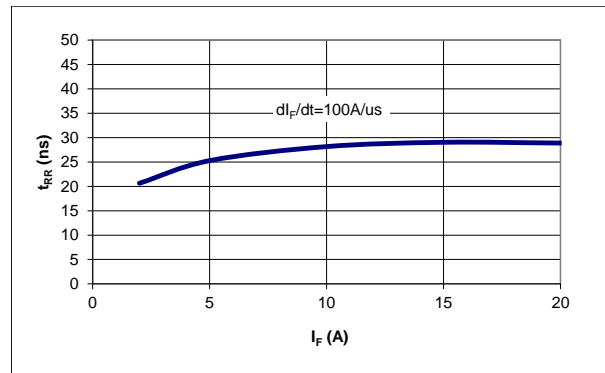

Figure 8. Typical t_{RR} vs I_F at $T_J=125\text{ }^\circ\text{C}$

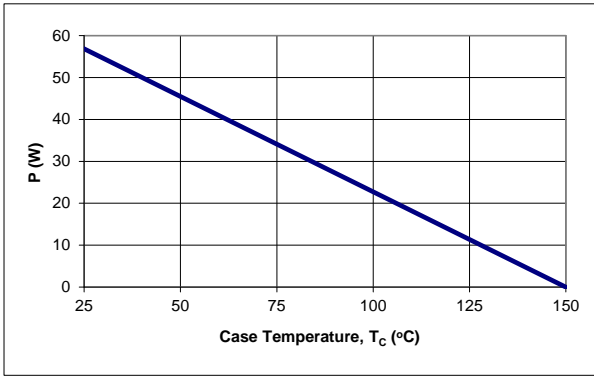

Figure 9. Power Derating Curve

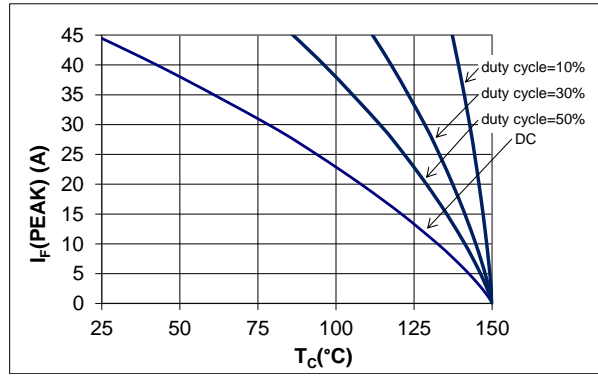

Figure 10. IF (Peak) vs TC, f = 70 kHz

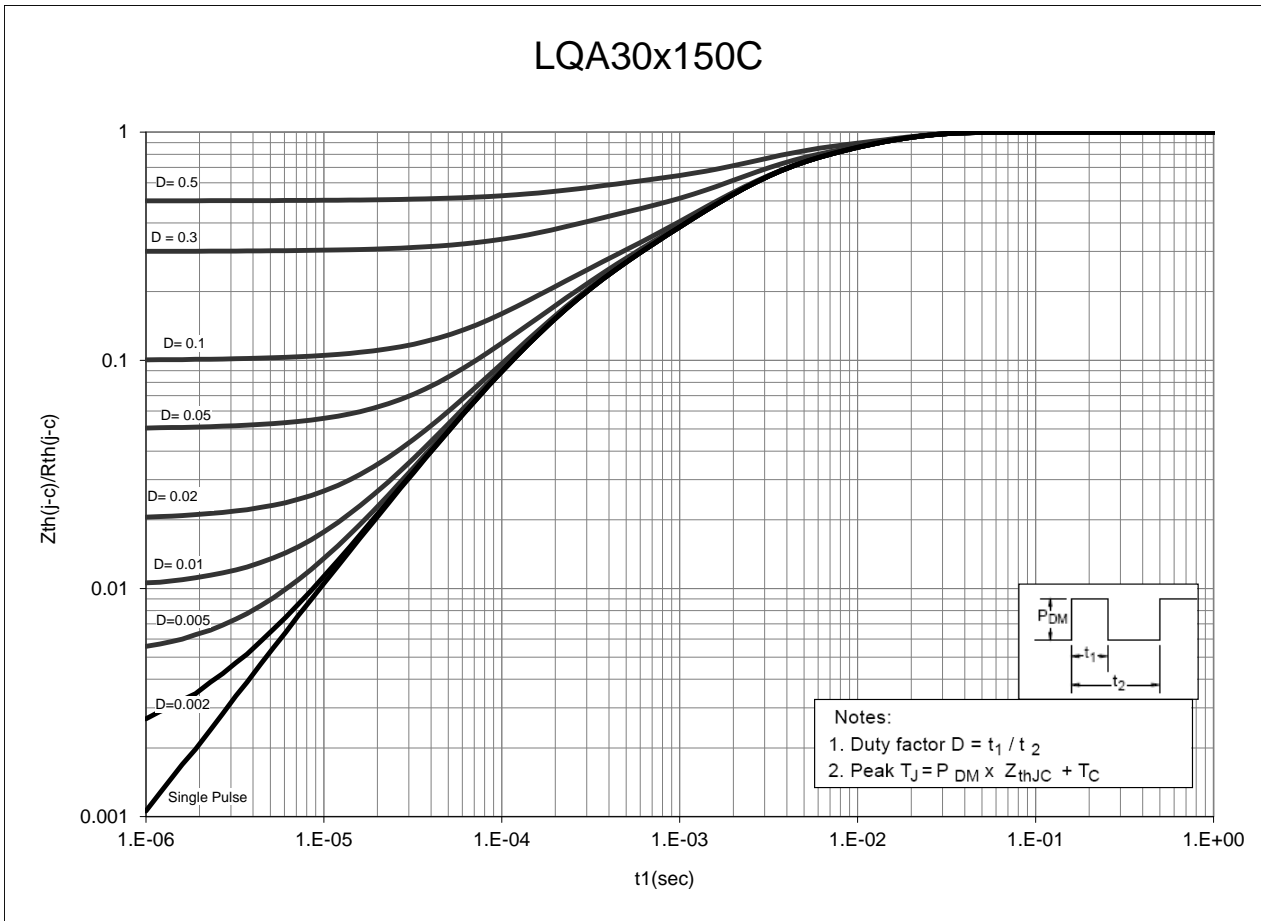
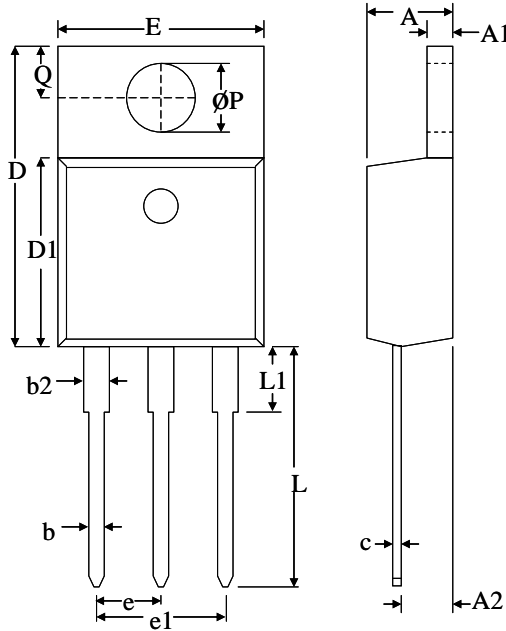

Figure 11. Normalized Maximum Transient Thermal Impedance

Dimensional Outline Drawings

TO-220AB



Dim	Millimeters	
	MIN	MAX
A	4.32	4.70
A1	1.11	1.38
A2	2.59	2.79
b	0.77	1.00
b2	1.23	1.36
C	0.34	0.47
D	14.71	15.75
D1	9.05	9.25
E	9.96	10.36
e	2.44	2.64
e1	4.98	5.18
L	12.70	14.22
L1	-	3.90
ØP	3.71	3.96
Q	2.54	2.90

Mechanical Mounting Method	Maximum Torque / Pressure specification
Screw through hole in package tab	1 Newton Meter (nm) or 8.8 inch-pounds (lb-in)
Clamp against package body	12.3 kilogram-force per square centimeter (kgf/cm ²) or 175 lbf/in ²

TO-263AB

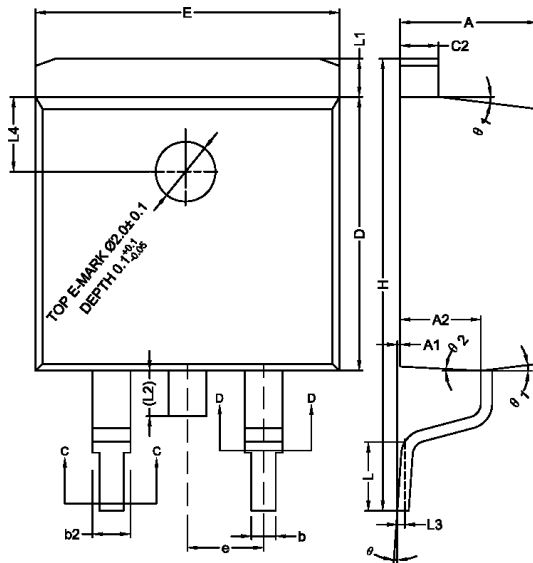

Dim	Millimeters	
	MIN	MAX
A	4.40	4.70
A1	0.00	0.25
A2	2.59	2.79
b	0.77	0.90
b2	1.23	1.36
c2	1.22	1.32
D	9.05	9.25
E	10.06	10.26
e	2.54 BSC	2.54 BSC
H	14.70	15.50
L	2.00	2.60
L1	1.17	1.40
L2	-	1.75
L3	0.25 BSC	0.25 BSC
L4	2.00 BSC	2.00 BSC
Ø	0°	8°
Ø1	5°	9°
Ø2	1°	5°

Soldering time and temperature: This product has been designed for use with high-temperature, lead-free solder. The component leads can be subjected to a maximum temperature of 300 °C, for up to 10 seconds. See Application Note AN-303, for more details.

Ordering Information

Part Number	Package	Packing
LQA30T150C	TO-220AB	50 units/tube
LQA30B150C	TO-263AB	800 units/reel

The information contained in this document is subject to change without notice

Revision	Notes	Date
1.0	Initial Release	12/14

For the latest updates, visit our website: www.power.com

Power Integrations reserves the right to make changes to its products at any time to improve reliability or manufacturability. Power Integrations does not assume any liability arising from the use of any device or circuit described herein. POWER INTEGRATIONS MAKES NO WARRANTY HEREIN AND SPECIFICALLY DISCLAIMS ALL WARRANTIES INCLUDING, WITHOUT LIMITATION, THE IMPLIED WARRANTIES OF MERCHANTABILITY, FITNESS FOR A PARTICULAR PURPOSE, AND NON-INFRINGEMENT OF THIRD PARTY RIGHTS.

PATENT INFORMATION

The products and applications illustrated herein (including transformer construction and circuits' external to the products) may be covered by one or more U.S. and foreign patents, or potentially by pending U.S. and foreign patent applications assigned to Power Integrations. A complete list of Power Integrations' patents may be found at www.power.com. Power Integrations grants its customers a license under certain patent rights as set forth at <http://www.power.com/ip.htm>.

The PI Logo, TOPSwitch, TinySwitch, LinkSwitch, LYTSwitch, InnoSwitch, DPA-Switch, PeakSwitch, CAPZero, SENZero, LinkZero, HiperPFS, HiperTFS, HiperLCS, Qspeed, EcoSmart, Clampless, E-Shield, Filterfuse, FluxLink, StackFET, PI Expert and PI FACTS are trademarks of Power Integrations, Inc. Other trademarks are property of their respective companies. ©Copyright 2014 Power Integrations, Inc.

Power Integrations Worldwide Sales Support Locations

WORLD HEADQUARTERS

5245 Hellyer Avenue
San Jose, CA 95138, USA.
Main: +1-408-414-9200
Customer Service:
Phone: +1-408-414-9665
Fax: +1-408-414-9765
e-mail: usasales@powerint.com

GERMANY

Lindwurmstrasse 114
80337, Munich
Germany
Phone: +49-895-527-39110
Fax: +49-895-527-39200
e-mail: eurosales@powerint.com

JAPAN

Kosei Dai-3 Building
2-12-11, Shin-Yokohama,
Kohoku-ku, Yokohama-shi,
Kanagawa 222-0033
Japan
Phone: +81-45-471-1021
Fax: +81-45-471-3717
e-mail: japansales@powerint.com

TAIWAN

5F, No. 318, Nei Hu Rd.,
Sec. 1
Nei Hu District
Taipei 11493, Taiwan R.O.C.
Phone: +886-2-2659-4570
Fax: +886-2-2659-4550
e-mail: taiwansales@powerint.com

CHINA (SHANGHAI)

Rm 2410, Charity Plaza, No. 88,
North Caoxi Road,
Shanghai, PRC 200030
Phone: +86-21-6354-6323
Fax: +86-21-6354-6325
e-mail: chinasales@powerint.com

INDIA

#1, 14th Main Road
Vasanthanagar
Bangalore-560052
India
Phone: +91-80-4113-8020
Fax: +91-80-4113-8023
e-mail: indiasales@powerint.com

KOREA

RM 602, 6FL
Korea City Air Terminal B/D,
159-6
Samsung-Dong, Kangnam-Gu,
Seoul, 135-728 Korea
Phone: +82-2-2016-6610
Fax: +82-2-2016-6630
e-mail: koreasales@powerint.com

UK

First Floor, Unit 15, Meadow
Court, Rutherford Close,
Stevenage, Herts. SG1 2EF
United Kingdom
Phone: +44 (0) 1252-730-141
Fax: +44 (0) 1252-727-689
e-mail: eurosales@powerint.com

CHINA (SHENZHEN)

17/F, Hivac Building, No. 2, Keji
Nan 8th Road, Nanshan District,
Shenzhen, China, 518057
Phone: +86-755-8672-8689
Fax: +86-755-8672-8690
e-mail: chinasales@powerint.com

ITALY

Via Milanese 20, 3rd. Fl.
20099 Sesto San Giovanni
(MI) Italy
Phone: +39-024-550-8701
Fax: +39-028-928-6009
e-mail: eurosales@powerint.com

SINGAPORE

51 Newton Road,
#19-01/05 Goldhill Plaza
Singapore, 308900
Phone: +65-6358-2160
Fax: +65-6358-2015
e-mail: singaporesales@powerint.com

APPLICATIONS HOTLINE

World Wide +1-408-414-9660

APPLICATIONS FAX

World Wide +1-408-414-9760



Стандарт Электрон Связь

Мы молодая и активно развивающаяся компания в области поставок электронных компонентов. Мы поставляем электронные компоненты отечественного и импортного производства напрямую от производителей и с крупнейших складов мира.

Благодаря сотрудничеству с мировыми поставщиками мы осуществляем комплексные и плановые поставки широчайшего спектра электронных компонентов.

Собственная эффективная логистика и склад в обеспечивает надежную поставку продукции в точно указанные сроки по всей России.

Мы осуществляем техническую поддержку нашим клиентам и предпродажную проверку качества продукции. На все поставляемые продукты мы предоставляем гарантию .

Осуществляем поставки продукции под контролем ВП МО РФ на предприятия военно-промышленного комплекса России , а также работаем в рамках 275 ФЗ с открытием отдельных счетов в уполномоченном банке. Система менеджмента качества компании соответствует требованиям ГОСТ ISO 9001.

Минимальные сроки поставки, гибкие цены, неограниченный ассортимент и индивидуальный подход к клиентам являются основой для выстраивания долгосрочного и эффективного сотрудничества с предприятиями радиоэлектронной промышленности, предприятиями ВПК и научно-исследовательскими институтами России.

С нами вы становитесь еще успешнее!

Наши контакты:

Телефон: +7 812 627 14 35

Электронная почта: sales@st-electron.ru

Адрес: 198099, Санкт-Петербург,
Промышленная ул, дом № 19, литера Н,
помещение 100-Н Офис 331