

# IRG4PH40KDPbF

INSULATED GATE BIPOLAR TRANSISTOR WITH  
ULTRAFAST SOFT RECOVERY DIODE

Short Circuit Rated  
UltraFast IGBT

### Features

- High short circuit rating optimized for motor control,  $t_{sc} = 10\mu s$ ,  $V_{CC} = 720V$ ,  $T_J = 125^\circ C$ ,  $V_{GE} = 15V$
- Combines low conduction losses with high switching speed
- Tighter parameter distribution and higher efficiency than previous generations
- IGBT co-packaged with HEXFRED™ ultrafast, ultrasoft recovery antiparallel diodes
- Lead-Free

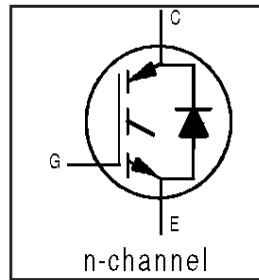

$V_{CES} = 1200V$
$V_{CE(on) typ.} = 2.74V$
@ $V_{GE} = 15V, I_C = 15A$

### Benefits

- Latest generation 4 IGBT's offer highest power density motor controls possible
- HEXFRED™ diodes optimized for performance with IGBTs. Minimized recovery characteristics reduce noise, EMI and switching losses
- This part replaces the IRGPH40KD2 and IRGPH40MD2 products
- For hints see design tip 97003

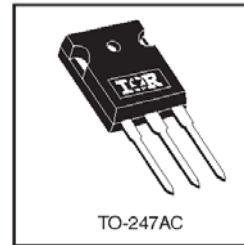

### Absolute Maximum Ratings

	Parameter	Max.	Units
$V_{CES}$	Collector-to-Emitter Voltage	1200	V
$I_C @ T_C = 25^\circ C$	Continuous Collector Current	30	A
$I_C @ T_C = 100^\circ C$	Continuous Collector Current	15	
$I_{CM}$	Pulsed Collector Current ①	60	
$I_{LM}$	Clamped Inductive Load Current ②	60	
$I_F @ T_C = 100^\circ C$	Diode Continuous Forward Current	8.0	
$I_{FM}$	Diode Maximum Forward Current	130	
$t_{sc}$	Short Circuit Withstand Time	10	$\mu s$
$V_{GE}$	Gate-to-Emitter Voltage	$\pm 20$	V
$P_D @ T_C = 25^\circ C$	Maximum Power Dissipation	160	W
$P_D @ T_C = 100^\circ C$	Maximum Power Dissipation	65	
$T_J$	Operating Junction and Storage Temperature Range	-55 to +150	$^\circ C$
$T_{STG}$			
	Mounting Torque, 6-32 or M3 Screw.	10 lbf•in (1.1 N•m)	

### Thermal Resistance

	Parameter	Min.	Typ.	Max.	Units
$R_{\theta JC}$	Junction-to-Case - IGBT	---	---	0.77	$^\circ C/W$
$R_{\theta JC}$	Junction-to-Case - Diode	---	---	1.7	
$R_{\theta CS}$	Case-to-Sink, flat, greased surface	---	0.24	---	
$R_{\theta JA}$	Junction-to-Ambient, typical socket mount	---	---	40	
Wt	Weight	---	6 (0.21)	---	g (oz)

## Electrical Characteristics @ T<sub>J</sub> = 25°C (unless otherwise specified)

	Parameter	Min.	Typ.	Max.	Units	Conditions
V <sub>(BR)CES</sub>	Collector-to-Emitter Breakdown Voltage <sup>③</sup>	1200	—	—	V	V <sub>GE</sub> = 0V, I <sub>C</sub> = 250μA
ΔV <sub>(BR)CES</sub> /ΔT <sub>J</sub>	Temperature Coeff. of Breakdown Voltage	—	0.37	—	V/°C	V <sub>GE</sub> = 0V, I <sub>C</sub> = 1.0mA
V <sub>CE(on)</sub>	Collector-to-Emitter Saturation Voltage	—	2.74	3.4	V	I <sub>C</sub> = 15A I <sub>C</sub> = 30A I <sub>C</sub> = 15A, T <sub>J</sub> = 150°C
		—	3.29	—		
		—	2.53	—		
V <sub>GE(th)</sub>	Gate Threshold Voltage	3.0	—	6.0		V <sub>CE</sub> = V <sub>GE</sub> , I <sub>C</sub> = 250μA
ΔV <sub>GE(th)</sub> /ΔT <sub>J</sub>	Temperature Coeff. of Threshold Voltage	—	-3.3	—	mV/°C	V <sub>CE</sub> = V <sub>GE</sub> , I <sub>C</sub> = 250μA
g <sub>fe</sub>	Forward Transconductance <sup>④</sup>	8.0	12	—	S	V <sub>CE</sub> = 100V, I <sub>C</sub> = 15A
I <sub>CES</sub>	Zero Gate Voltage Collector Current	—	—	250	μA	V <sub>GE</sub> = 0V, V <sub>CE</sub> = 1200V V <sub>GE</sub> = 0V, V <sub>CE</sub> = 1200V, T <sub>J</sub> = 150°C
		—	—	3000		
V <sub>FM</sub>	Diode Forward Voltage Drop	—	2.6	3.3	V	I <sub>C</sub> = 8.0A I <sub>C</sub> = 8.0A, T <sub>J</sub> = 125°C
		—	2.4	3.1		
I <sub>GES</sub>	Gate-to-Emitter Leakage Current	—	—	±100	nA	V <sub>GE</sub> = ±20V

## Switching Characteristics @ T<sub>J</sub> = 25°C (unless otherwise specified)

	Parameter	Min.	Typ.	Max.	Units	Conditions
Q <sub>g</sub>	Total Gate Charge (tum-on)	—	94	140	nC	I <sub>C</sub> = 15A V <sub>CC</sub> = 400V V <sub>GE</sub> = 15V
Q <sub>ge</sub>	Gate - Emitter Charge (tum-on)	—	14	22		
Q <sub>gc</sub>	Gate - Collector Charge (tum-on)	—	37	55		
t <sub>d(on)</sub>	Turn-On Delay Time	—	50	—	ns	T <sub>J</sub> = 25°C I <sub>C</sub> = 15A, V <sub>CC</sub> = 800V V <sub>GE</sub> = 15V, R <sub>G</sub> = 10Ω
t <sub>r</sub>	Rise Time	—	31	—		
t <sub>d(off)</sub>	Turn-Off Delay Time	—	96	140		
t <sub>f</sub>	Fall Time	—	220	330		
E <sub>on</sub>	Turn-On Switching Loss	—	1.31	—	mJ	Energy losses include "tail" and diode reverse recovery See Fig. 9,10,18
E <sub>off</sub>	Turn-Off Switching Loss	—	1.12	—		
E <sub>ts</sub>	Total Switching Loss	—	2.43	2.8		
t <sub>sc</sub>	Short Circuit Withstand Time	10	—	—	μs	V <sub>CC</sub> = 720V, T <sub>J</sub> = 125°C V <sub>GE</sub> = 15V, R <sub>G</sub> = 10Ω, V <sub>OPK</sub> < 500V
t <sub>d(on)</sub>	Turn-On Delay Time	—	49	—	ns	T <sub>J</sub> = 150°C, See Fig. 10,11,18 I <sub>C</sub> = 15A, V <sub>CC</sub> = 800V V <sub>GE</sub> = 15V, R <sub>G</sub> = 10Ω, Energy losses include "tail" and diode reverse recovery
t <sub>r</sub>	Rise Time	—	33	—		
t <sub>d(off)</sub>	Turn-Off Delay Time	—	290	—		
t <sub>f</sub>	Fall Time	—	440	—		
E <sub>ts</sub>	Total Switching Loss	—	5.1	—	mJ	
L <sub>E</sub>	Internal Emitter Inductance	—	13	—	nH	Measured 5mm from package
C <sub>ies</sub>	Input Capacitance	—	1600	—	pF	V <sub>GE</sub> = 0V V <sub>CC</sub> = 30V f = 1.0MHz
C <sub>oes</sub>	Output Capacitance	—	77	—		
C <sub>res</sub>	Reverse Transfer Capacitance	—	26	—		
t <sub>rr</sub>	Diode Reverse Recovery Time	—	63	95	ns	T <sub>J</sub> = 25°C T <sub>J</sub> = 125°C
		—	106	160		
I <sub>rr</sub>	Diode Peak Reverse Recovery Current	—	4.5	8.0	A	T <sub>J</sub> = 25°C T <sub>J</sub> = 125°C
		—	6.2	11		
Q <sub>rr</sub>	Diode Reverse Recovery Charge	—	140	380	nC	T <sub>J</sub> = 25°C T <sub>J</sub> = 125°C
		—	335	880		
di <sub>(rec)M</sub> /dt	Diode Peak Rate of Fall of Recovery During t <sub>b</sub>	—	133	—	A/μs	T <sub>J</sub> = 25°C T <sub>J</sub> = 125°C
		—	85	—		

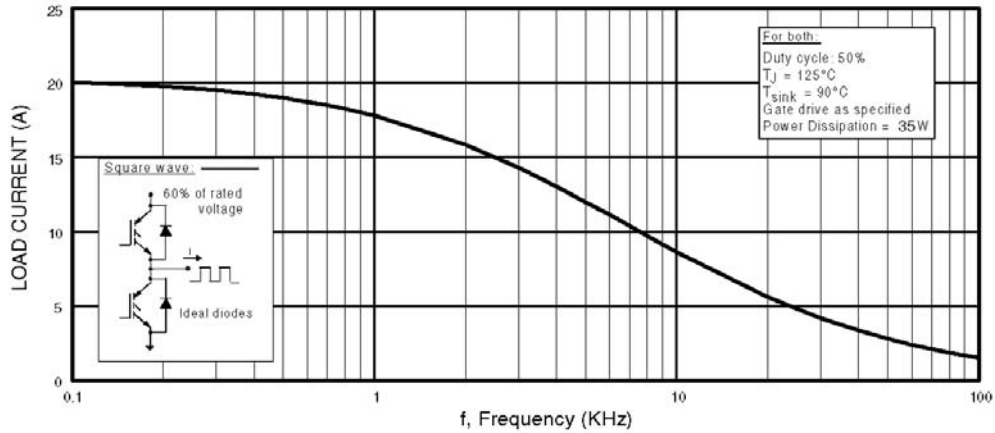

**Fig. 1** - Typical Load Current vs. Frequency  
 (Load Current =  $I_{\text{RMS}}$  of fundamental)

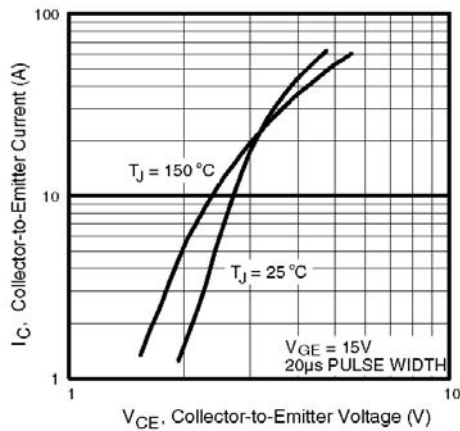

**Fig. 2** - Typical Output Characteristics

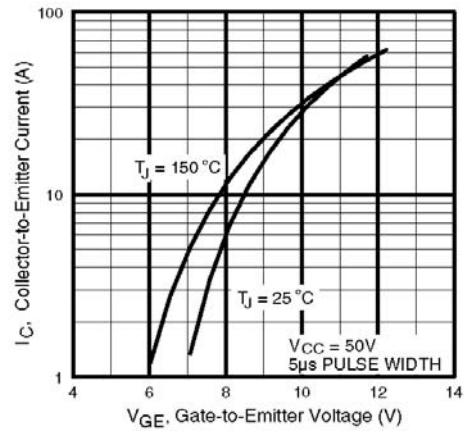

**Fig. 3** - Typical Transfer Characteristics

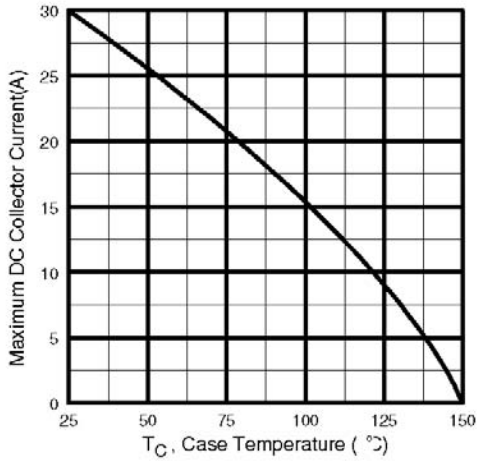

**Fig. 4** - Maximum Collector Current vs. Case Temperature

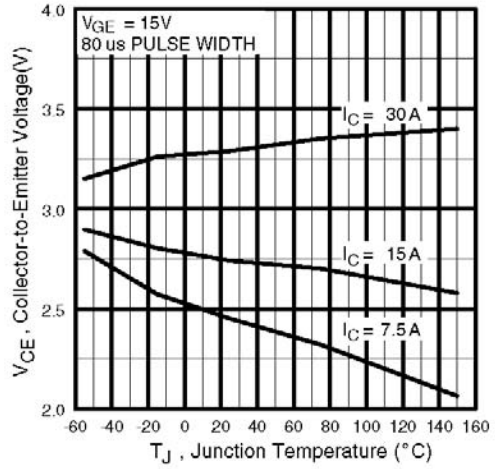

**Fig. 5** - Typical Collector-to-Emitter Voltage vs. Junction Temperature

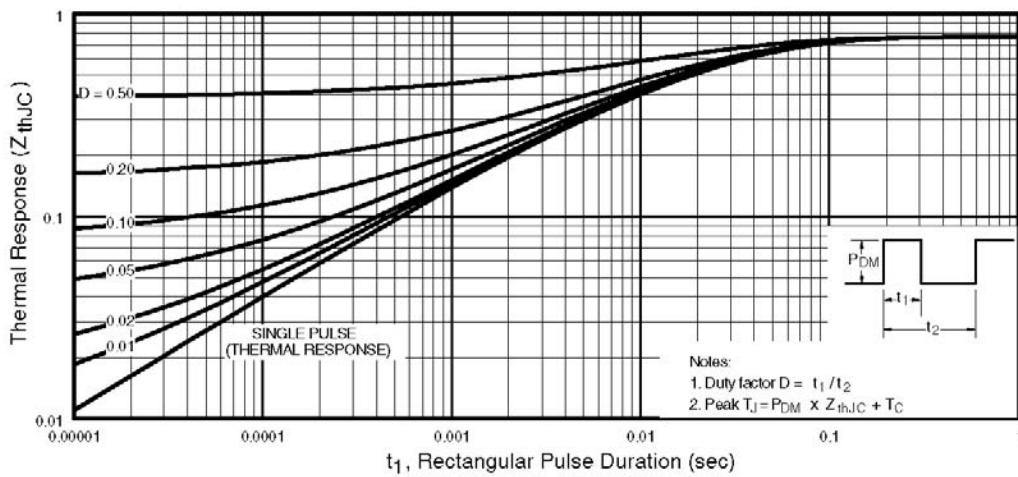

**Fig. 6** - Maximum Effective Transient Thermal Impedance, Junction-to-Case

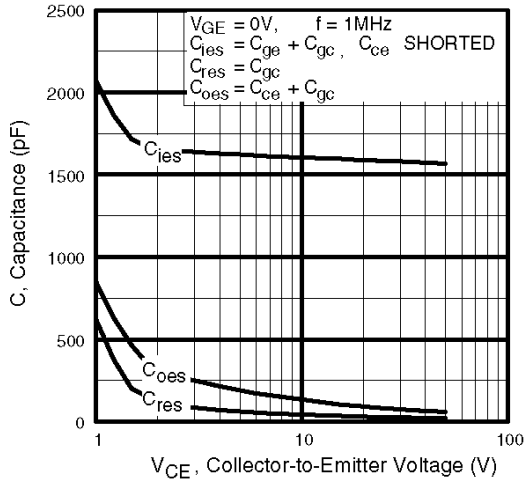

**Fig. 7** - Typical Capacitance vs. Collector-to-Emitter Voltage

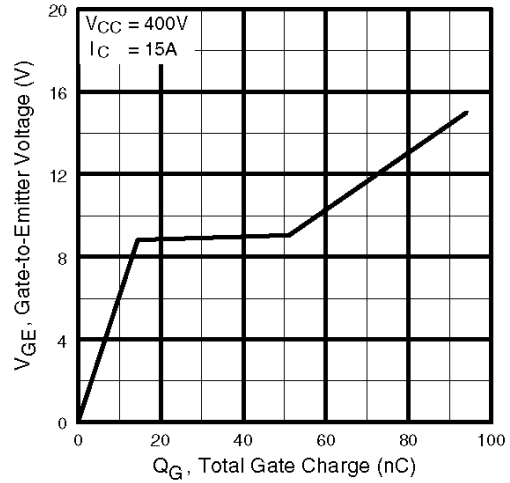

**Fig. 8** - Typical Gate Charge vs. Gate-to-Emitter Voltage

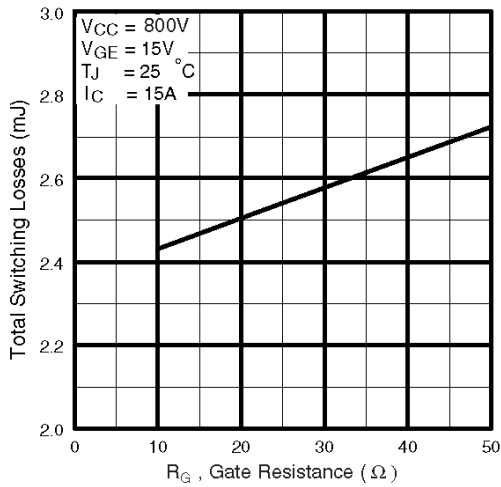

**Fig. 9** - Typical Switching Losses vs. Gate Resistance

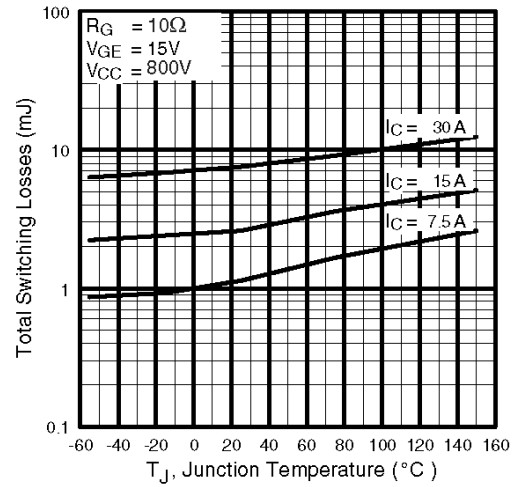

**Fig. 10** - Typical Switching Losses vs. Junction Temperature

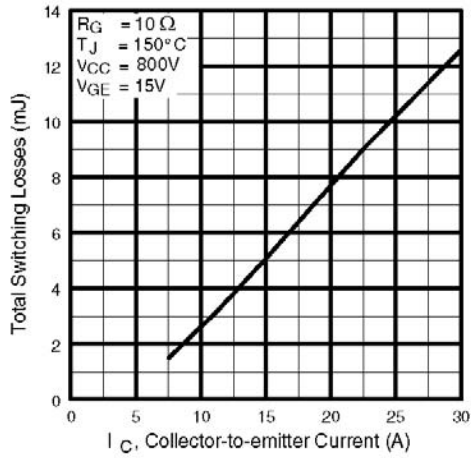

**Fig. 11** - Typical Switching Losses vs. Collector-to-Emitter Current

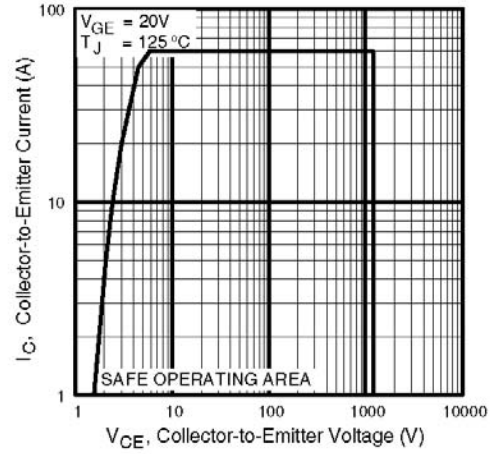

**Fig. 12** - Turn-Off SOA

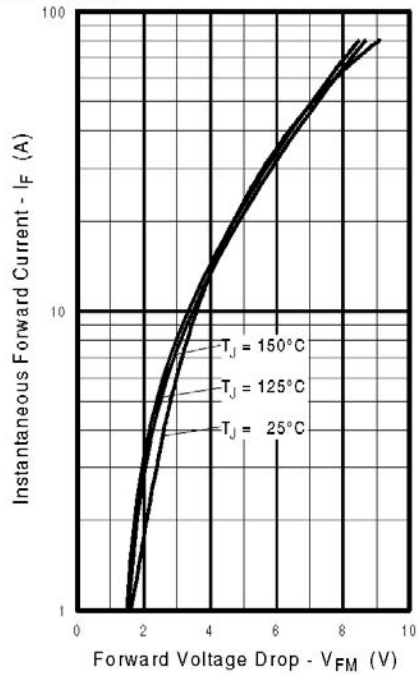

**Fig. 13** - Maximum Forward Voltage Drop vs. Instantaneous Forward Current

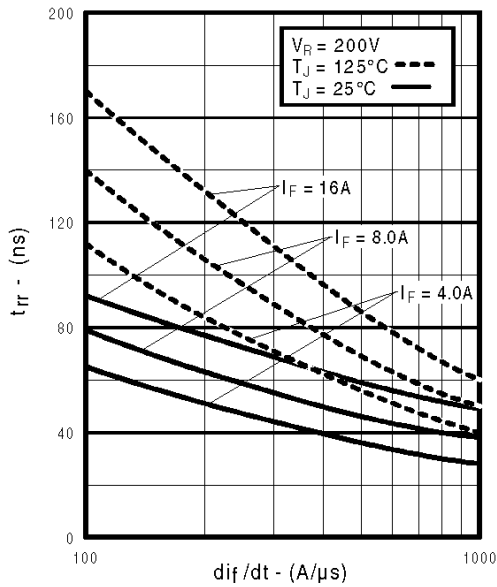

Fig. 14 - Typical Reverse Recovery vs.  $di_f/dt$

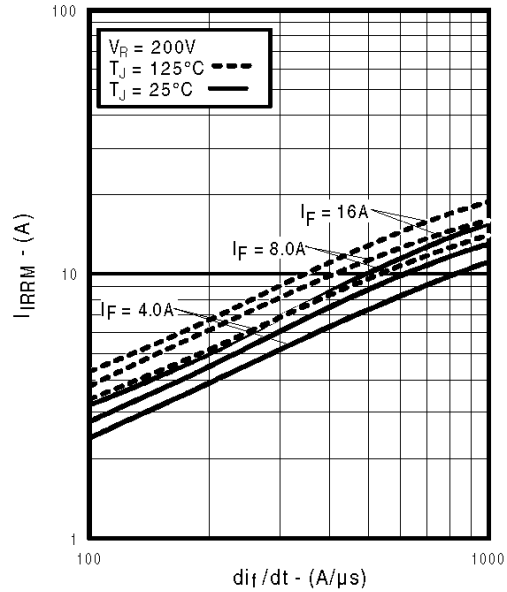

Fig. 15 - Typical Recovery Current vs.  $di_f/dt$

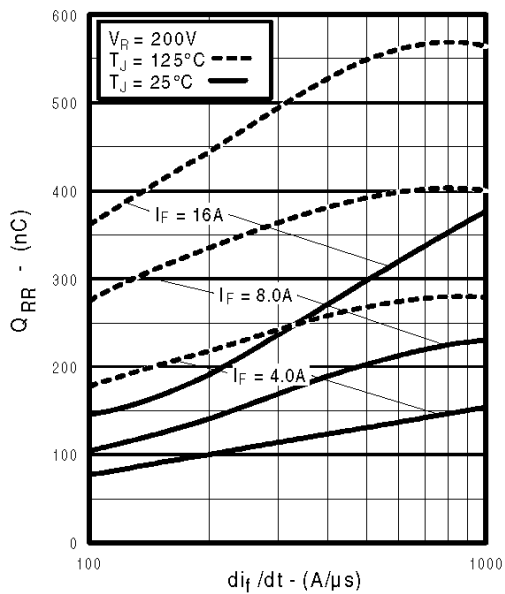

Fig. 16 - Typical Stored Charge vs.  $di_f/dt$

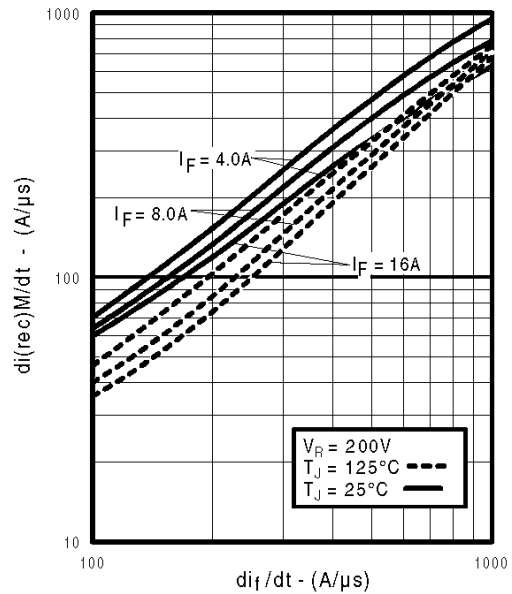
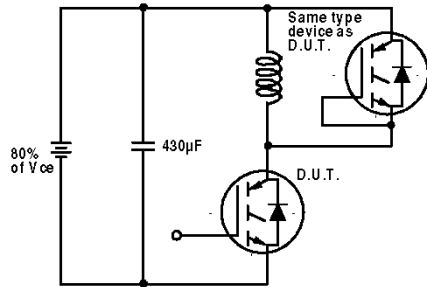
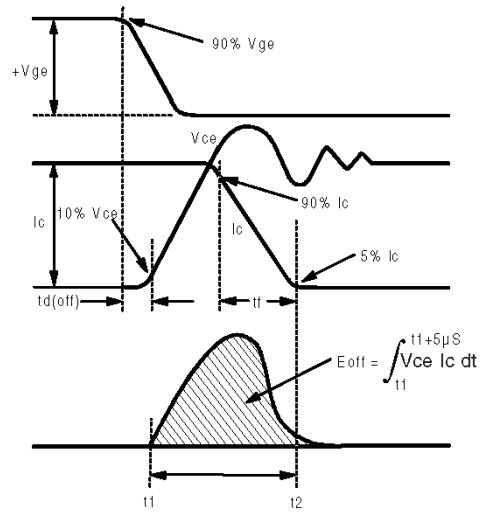

Fig. 17 - Typical  $di_{(rec)M}/dt$  vs.  $di_f/dt$



**Fig. 18a** - Test Circuit for Measurement of  $I_{LM}$ ,  $E_{on}$ ,  $E_{off}(\text{diode})$ ,  $t_{rr}$ ,  $Q_{rr}$ ,  $I_{rr}$ ,  $t_{d(on)}$ ,  $t_r$ ,  $t_{d(off)}$ ,  $t_f$



**Fig. 18b** - Test Waveforms for Circuit of Fig. 18a, Defining  $E_{off}$ ,  $t_{d(off)}$ ,  $t_f$

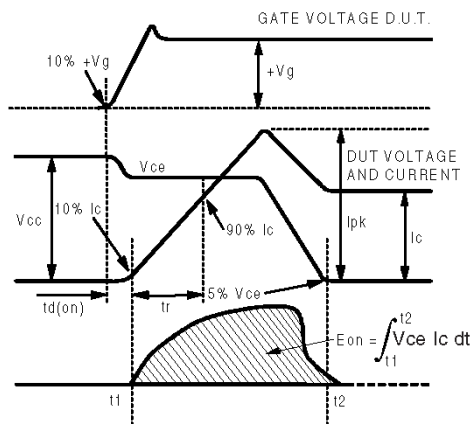

**Fig. 18c** - Test Waveforms for Circuit of Fig. 18a, Defining  $E_{on}$ ,  $t_{d(on)}$ ,  $t_r$

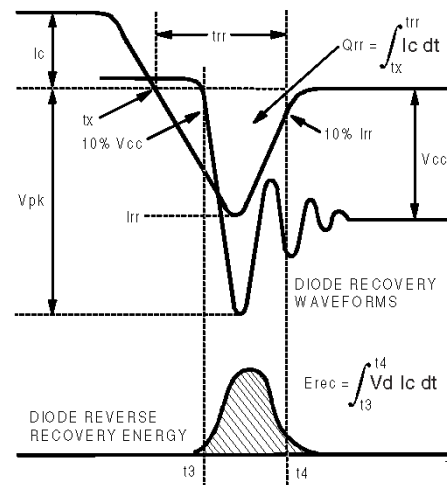

**Fig. 18d** - Test Waveforms for Circuit of Fig. 18a, Defining  $E_{rec}$ ,  $t_{rr}$ ,  $Q_{rr}$ ,  $I_{rr}$



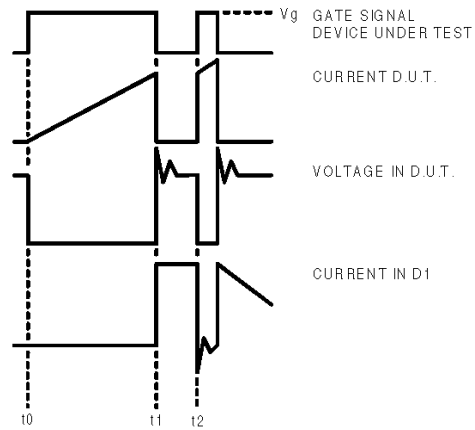

Figure 18e. Macro Waveforms for Figure 18a's Test Circuit

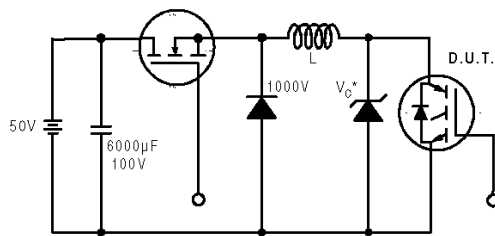

Figure 19. Clamped Inductive Load Test Circuit

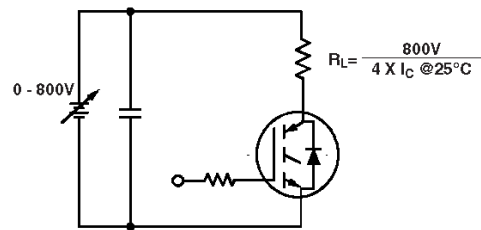

Figure 20. Pulsed Collector Current Test Circuit

# IRG4PH40KDPbF

International  
**IR** Rectifier

## Notes:

- ① Repetitive rating:  $V_{GE}=20V$ ; pulse width limited by maximum junction temperature (figure 20)
- ②  $V_{CC}=80\%(V_{CES})$ ,  $V_{GE}=20V$ ,  $L=10\mu H$ ,  $R_G=10\Omega$  (figure 19)
- ③ Pulse width  $\leq 80\mu s$ ; duty factor  $\leq 0.1\%$ .
- ④ Pulse width  $5.0\mu s$ , single shot.

## TO-247AC Package Outline

Dimensions are shown in millimeters (inches)

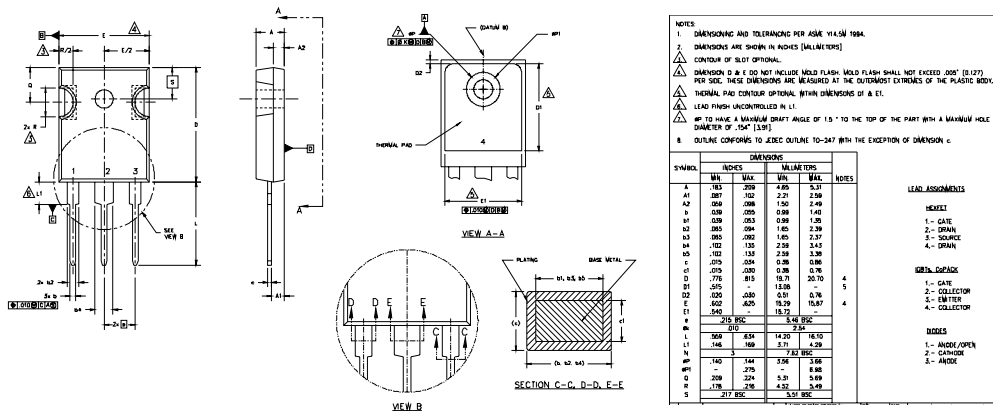

## TO-247AC Part Marking Information

EXAMPLE: THIS IS AN IRFP30  
WITH ASSEMBLY  
LOT CODE 5667  
ASSEMBLED ON WW 35, 2000  
IN THE ASSEMBLY LINE "H"

Note: "P" in assembly line  
position indicates "Lead-Free"

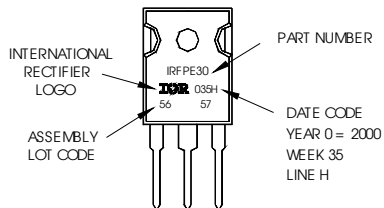

Data and specifications subject to change without notice.

International  
**IR** Rectifier

IR WORLD HEADQUARTERS: 233 Kansas St., El Segundo, California 90245, USA Tel: (310) 252-7105  
TAC Fax: (310) 252-7903

Visit us at [www.irf.com](http://www.irf.com) for sales contact information.06/04

[www.irf.com](http://www.irf.com)

Note: For the most current drawings please refer to the IR website at:  
<http://www.irf.com/package/>



## Стандарт Электрон Связь

Мы молодая и активно развивающаяся компания в области поставок электронных компонентов. Мы поставляем электронные компоненты отечественного и импортного производства напрямую от производителей и с крупнейших складов мира.

Благодаря сотрудничеству с мировыми поставщиками мы осуществляем комплексные и плановые поставки широчайшего спектра электронных компонентов.

Собственная эффективная логистика и склад в обеспечивает надежную поставку продукции в точно указанные сроки по всей России.

Мы осуществляем техническую поддержку нашим клиентам и предпродажную проверку качества продукции. На все поставляемые продукты мы предоставляем гарантию .

Осуществляем поставки продукции под контролем ВП МО РФ на предприятия военно-промышленного комплекса России , а также работаем в рамках 275 ФЗ с открытием отдельных счетов в уполномоченном банке. Система менеджмента качества компании соответствует требованиям ГОСТ ISO 9001.

Минимальные сроки поставки, гибкие цены, неограниченный ассортимент и индивидуальный подход к клиентам являются основой для выстраивания долгосрочного и эффективного сотрудничества с предприятиями радиоэлектронной промышленности, предприятиями ВПК и научно-исследовательскими институтами России.

С нами вы становитесь еще успешнее!

### Наши контакты:

**Телефон:** +7 812 627 14 35

**Электронная почта:** [sales@st-electron.ru](mailto:sales@st-electron.ru)

**Адрес:** 198099, Санкт-Петербург,  
Промышленная ул, дом № 19, литера Н,  
помещение 100-Н Офис 331