

# SN74S1051

## 12-BIT SCHOTTKY BARRIER DIODE BUS-TERMINATION ARRAY

SDLS018B – SEPTEMBER 1990 – REVISED MARCH 2003

- Designed to Reduce Reflection Noise
- Repetitive Peak Forward Current to 200 mA
- 12-Bit Array Structure Suited for Bus-Oriented Systems

### description/ordering information

This Schottky barrier diode bus-termination array is designed to reduce reflection noise on memory bus lines. This device consists of a 12-bit high-speed Schottky diode array suitable for clamping to  $V_{CC}$  and/or GND.

D, N, NS, OR PW PACKAGE  
(TOP VIEW)

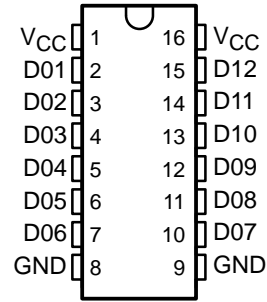

### ORDERING INFORMATION

$T_A$	PACKAGE†		ORDERABLE PART NUMBER	TOP-SIDE MARKING
0°C to 70°C	PDIP – N	Tube	SN74S1051N	SN74S1051N
	SOIC – D	Tube	SN74S1051D	S1051
		Tape and reel	SN74S1051DR	
	SOP – NS	Tape and reel	SN74S1051NSR	74S1051
TSSOP – PW	Tape and reel	SN74S1051PWR	S1051	

† Package drawings, standard packing quantities, thermal data, symbolization, and PCB design guidelines are available at [www.ti.com/sc/package](http://www.ti.com/sc/package).

### schematic diagrams

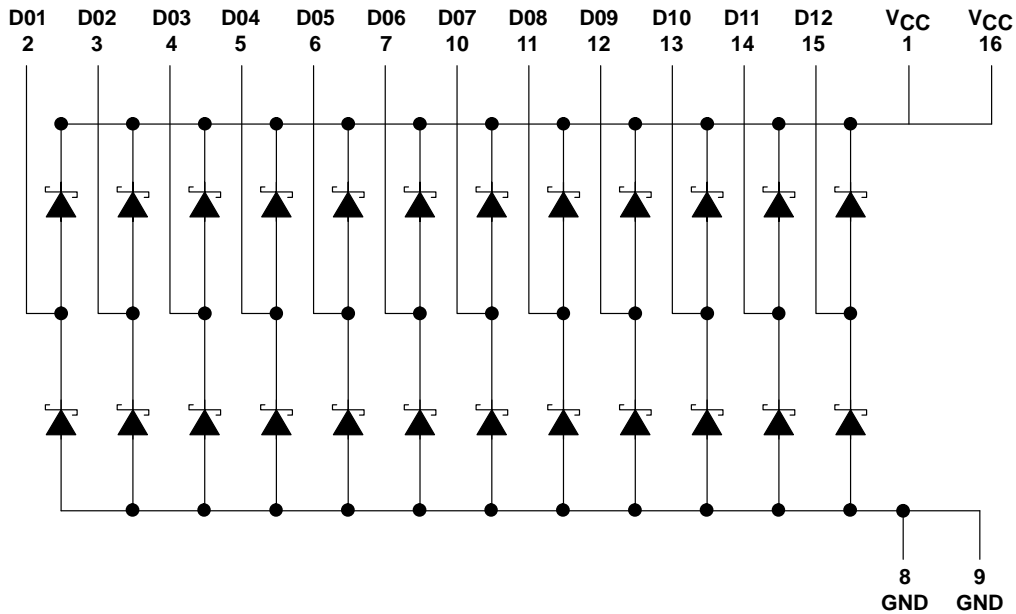

Please be aware that an important notice concerning availability, standard warranty, and use in critical applications of Texas Instruments semiconductor products and disclaimers thereto appears at the end of this data sheet.

PRODUCTION DATA information is current as of publication date. Products conform to specifications per the terms of Texas Instruments standard warranty. Production processing does not necessarily include testing of all parameters.

**TEXAS  
INSTRUMENTS**

POST OFFICE BOX 655303 • DALLAS, TEXAS 75265

Copyright © 2003, Texas Instruments Incorporated

# SN74S1051

## 12-BIT SCHOTTKY BARRIER DIODE

### BUS-TERMINATION ARRAY

SDLS018B – SEPTEMBER 1990 – REVISED MARCH 2003

#### absolute maximum ratings over operating free-air temperature range (unless otherwise noted)†

Steady-state reverse voltage, $V_R$	7 V
Continuous forward current, $I_F$ : Any D terminal from GND or to $V_{CC}$	50 mA
Total through all GND or $V_{CC}$ terminals	170 mA
Repetitive peak forward current‡, $I_{FRM}$ : Any D terminal from GND or $V_{CC}$	200 mA
Total through all GND or $V_{CC}$ terminals	1 A
Package thermal impedance, $\theta_{JA}$ (see Note 1): D package	73°C/W
N package	67°C/W
NS package	64°C/W
PW package	108°C/W
Operating free-air temperature range	0°C to 70°C
Storage temperature range, $T_{stg}$	-65°C to 150°C

† Stresses beyond those listed under “absolute maximum ratings” may cause permanent damage to the device. These are stress ratings only, and functional operation of the device at these or any other conditions beyond those indicated under “recommended operating conditions” is not implied. Exposure to absolute-maximum-rated conditions for extended periods may affect device reliability.

‡ These values apply for  $t_w \leq 100 \mu s$ , duty cycle  $\leq 20\%$ .

NOTE 1: The package thermal impedance is calculated in accordance with JESD 51-7.

#### electrical characteristics over recommended operating free-air temperature range (unless otherwise noted)

##### single-diode operation (see Note 2)

PARAMETER		TEST CONDITIONS		MIN	TYP§	MAX	UNIT
$V_F$	Static forward voltage	To $V_{CC}$	$I_F = 18 \text{ mA}$	0.85	1.05	V	
			$I_F = 50 \text{ mA}$	1.05	1.3		
		From GND	$I_F = 18 \text{ mA}$	0.75	0.95		
			$I_F = 50 \text{ mA}$	0.95	1.2		
$V_{FM}$	Peak forward voltage		$I_F = 200 \text{ mA}$	1.45		V	
$I_R$	Static reverse current	To $V_{CC}$	$V_R = 7 \text{ V}$			5	$\mu A$
		From GND			5		
$C_t$	Total capacitance	$V_R = 0 \text{ V}, f = 1 \text{ MHz}$		8	16	pF	
		$V_R = 2 \text{ V}, f = 1 \text{ MHz}$		4	8		

§ All typical values are at  $V_{CC} = 5 \text{ V}, T_A = 25^\circ C$ .

NOTE 2: Test conditions and limits apply separately to each of the diodes. The diodes not under test are open-circuited during the measurement of these characteristics.

##### multiple-diode operation

PARAMETER		TEST CONDITIONS		MIN	TYP§	MAX	UNIT
$I_x$	Internal crosstalk current	Total $I_F$ current = 1 A,	See Note 3	0.8	2	mA	
		Total $I_F$ current = 198 mA,	See Note 3	0.02	0.2		

§ All typical values are at  $V_{CC} = 5 \text{ V}, T_A = 25^\circ C$ .

NOTE 3:  $I_x$  is measured under the following conditions with one diode static, all others switching:

Switching diodes:  $t_w = 100 \mu s$ , duty cycle = 20%

Static diode:  $V_R = 5 \text{ V}$

The static diode input current is the internal crosstalk current,  $I_x$ .

#### switching characteristics over recommended operating free-air temperature range (unless otherwise noted) (see Figures 1 and 2)

PARAMETER		TEST CONDITIONS				MIN	TYP	MAX	UNIT
$t_{rr}$	Reverse recovery time	$I_F = 10 \text{ mA}, I_{RM(REC)} = 10 \text{ mA}, I_{R(REC)} = 1 \text{ mA}, R_L = 100 \Omega$				8	16	ns	



**PARAMETER MEASUREMENT INFORMATION**

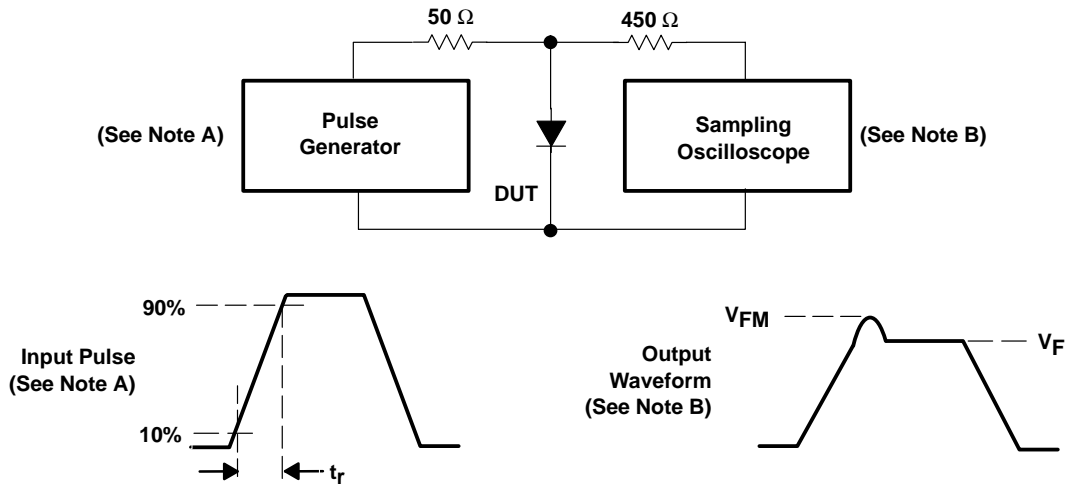

- NOTES: A. The input pulse is supplied by a pulse generator having the following characteristics:  $t_r = 20$  ns,  $Z_O = 50$   $\Omega$ , freq = 500 Hz, duty cycle = 1%.  
 B. The output waveform is monitored by an oscilloscope having the following characteristics:  $t_r \leq 350$  ps,  $R_i = 50$   $\Omega$ ,  $C_i \leq 5$  pF.

**Figure 1. Forward Recovery Voltage**

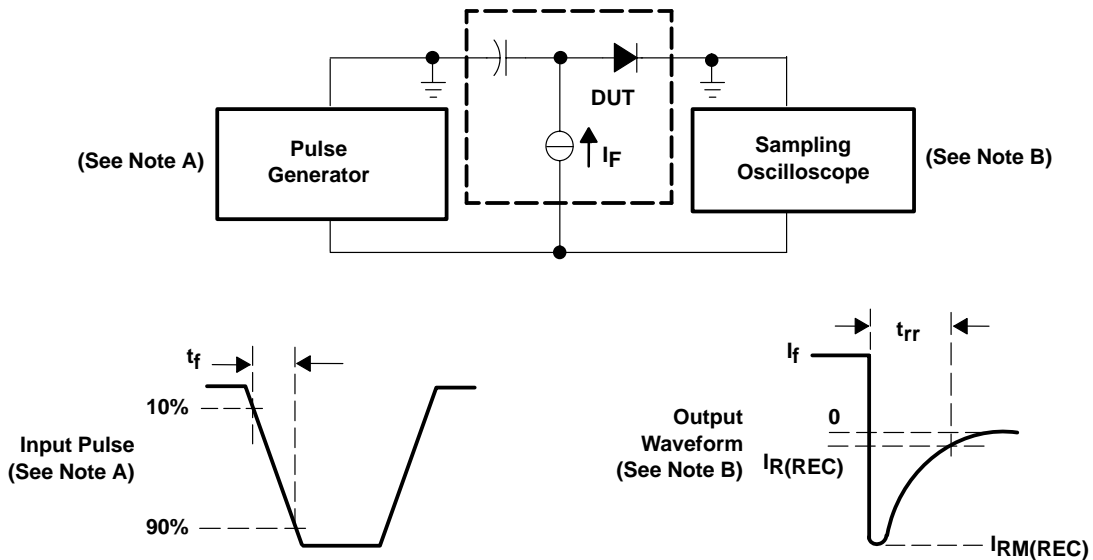

- NOTES: A. The input pulse is supplied by a pulse generator having the following characteristics:  $t_f = 0.5$  ns,  $Z_O = 50$   $\Omega$ ,  $t_w \geq 50$  ns, duty cycle = 1%.  
 B. The output waveform is monitored by an oscilloscope having the following characteristics:  $t_r \leq 350$  ps,  $R_i = 50$   $\Omega$ ,  $C_i \leq 5$  pF.

**Figure 2. Reverse Recovery Time**

# SN74S1051 12-BIT SCHOTTKY BARRIER DIODE BUS-TERMINATION ARRAY

SDLS018B – SEPTEMBER 1990 – REVISED MARCH 2003

## APPLICATION INFORMATION

Large negative transients at the inputs of memory devices (DRAMs, SRAMs, EPROMs, etc.) or on the CLOCK lines of many clocked devices can result in improper operation of the devices. The SN74S1051 diode termination array helps suppress negative transients caused by transmission-line reflections, crosstalk, and switching noise.

Diode terminations have several advantages when compared to resistor termination schemes. Split-resistor or Thevenin-equivalent termination can cause a substantial increase in power consumption. The use of a single resistor to ground to terminate a line usually results in degradation of the output high level, resulting in reduced noise immunity. Series damping resistors placed on the outputs of the driver reduce negative transients, but they also can increase propagation delays down the line because a series resistor reduces the output drive capability of the driving device. Diode terminations have none of these drawbacks.

The operation of the diode arrays in reducing negative transients is explained in the following figures. The diode conducts current when the voltage reaches a negative value large enough for the diode to turn on. Suppression of negative transients is tracked by the current-voltage characteristic curve for that diode. Typical current-versus-voltage curves for the SN74S1051 are shown in Figures 3 and 4.

To illustrate how the diode arrays act to reduce negative transients at the end of a transmission line, the test setup in Figure 5 was evaluated. The resulting waveforms with and without the diode are shown in Figure 6.

The maximum effectiveness of the diode arrays in suppressing negative transients occurs when the diode arrays are placed at the end of a line and/or the end of a long stub branching off a main transmission line. The diodes can also reduce the negative transients that occur due to discontinuities in the middle of a line. An example of this is a slot in a backplane that is provided for an add-on card.

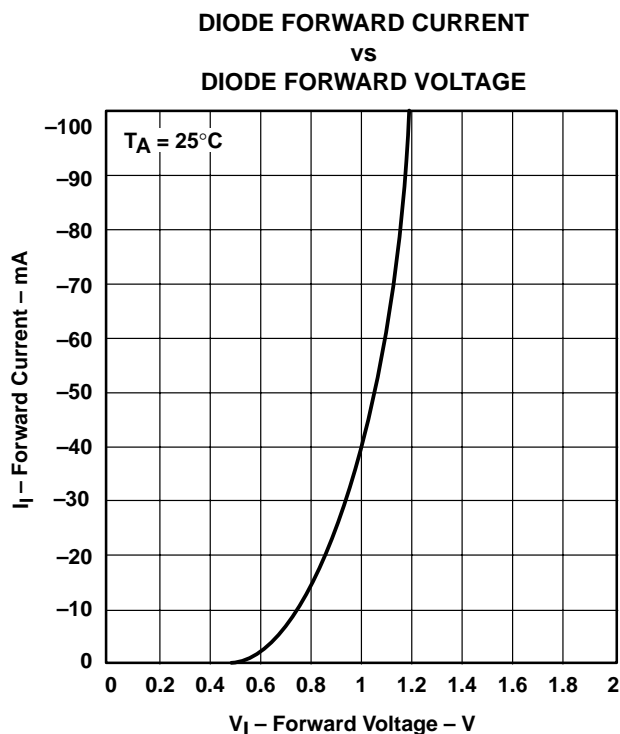
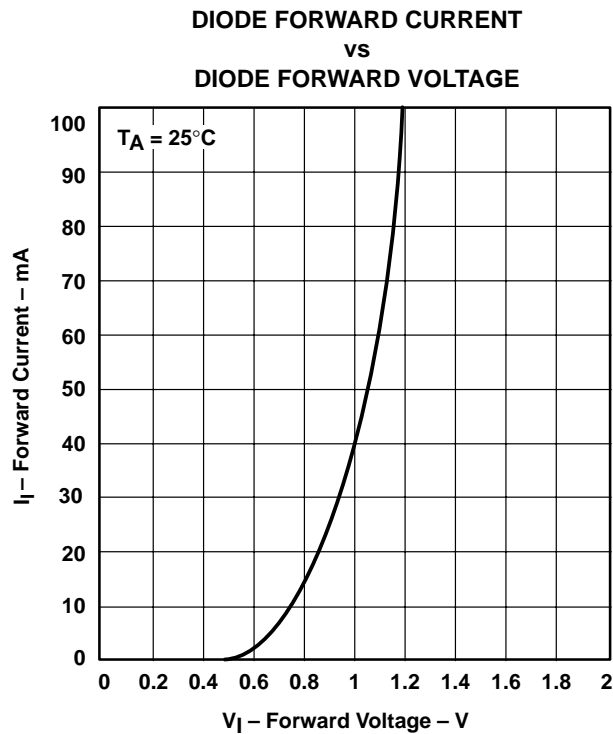

Figure 3. Typical Input Current vs Input Voltage  
(Lower Diode)



**Figure 4. Typical Input Current vs Input Voltage  
(Upper Diode)**

# SN74S1051 12-BIT SCHOTTKY BARRIER DIODE BUS-TERMINATION ARRAY

SDLS018B – SEPTEMBER 1990 – REVISED MARCH 2003

## APPLICATION INFORMATION

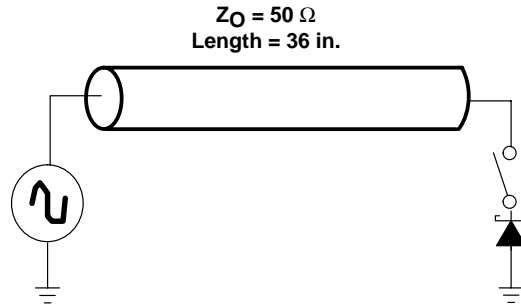

Figure 5. Diode Test Setup

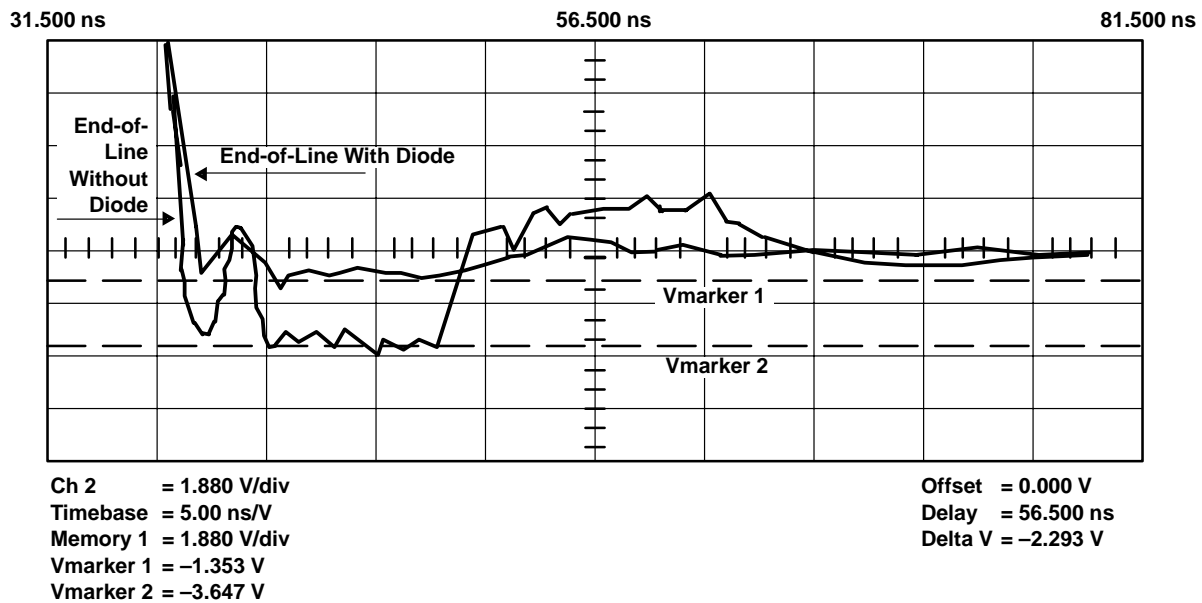

Figure 6. Reduction of Negative Transients at the End of a Transmission Line

**PACKAGING INFORMATION**

Orderable Device	Status (1)	Package Type	Package Drawing	Pins	Package Qty	Eco Plan (2)	Lead/Ball Finish	MSL Peak Temp (3)	Op Temp (°C)	Top-Side Markings (4)	Samples
SN74S1051D	ACTIVE	SOIC	D	16	40	Green (RoHS & no Sb/Br)	CU NIPDAU	Level-1-260C-UNLIM	0 to 70	S1051	<a href="#">Samples</a>
SN74S1051DE4	ACTIVE	SOIC	D	16	40	Green (RoHS & no Sb/Br)	CU NIPDAU	Level-1-260C-UNLIM	0 to 70	S1051	<a href="#">Samples</a>
SN74S1051DG4	ACTIVE	SOIC	D	16	40	Green (RoHS & no Sb/Br)	CU NIPDAU	Level-1-260C-UNLIM	0 to 70	S1051	<a href="#">Samples</a>
SN74S1051DR	ACTIVE	SOIC	D	16	2500	Green (RoHS & no Sb/Br)	CU NIPDAU	Level-1-260C-UNLIM	0 to 70	S1051	<a href="#">Samples</a>
SN74S1051DRE4	ACTIVE	SOIC	D	16	2500	Green (RoHS & no Sb/Br)	CU NIPDAU	Level-1-260C-UNLIM	0 to 70	S1051	<a href="#">Samples</a>
SN74S1051DRG4	ACTIVE	SOIC	D	16	2500	Green (RoHS & no Sb/Br)	CU NIPDAU	Level-1-260C-UNLIM	0 to 70	S1051	<a href="#">Samples</a>
SN74S1051N	ACTIVE	PDIP	N	16	25	Pb-Free (RoHS)	CU NIPDAU	N / A for Pkg Type	0 to 70	SN74S1051N	<a href="#">Samples</a>
SN74S1051NE4	ACTIVE	PDIP	N	16	25	Pb-Free (RoHS)	CU NIPDAU	N / A for Pkg Type	0 to 70	SN74S1051N	<a href="#">Samples</a>
SN74S1051NSR	ACTIVE	SO	NS	16	2000	Green (RoHS & no Sb/Br)	CU NIPDAU	Level-1-260C-UNLIM	0 to 70	74S1051	<a href="#">Samples</a>
SN74S1051NSRE4	ACTIVE	SO	NS	16	2000	Green (RoHS & no Sb/Br)	CU NIPDAU	Level-1-260C-UNLIM	0 to 70	74S1051	<a href="#">Samples</a>
SN74S1051NSRG4	ACTIVE	SO	NS	16	2000	Green (RoHS & no Sb/Br)	CU NIPDAU	Level-1-260C-UNLIM	0 to 70	74S1051	<a href="#">Samples</a>
SN74S1051PW	ACTIVE	TSSOP	PW	16	90	Green (RoHS & no Sb/Br)	CU NIPDAU	Level-1-260C-UNLIM	0 to 70	S1051	<a href="#">Samples</a>
SN74S1051PWE4	ACTIVE	TSSOP	PW	16	90	Green (RoHS & no Sb/Br)	CU NIPDAU	Level-1-260C-UNLIM	0 to 70	S1051	<a href="#">Samples</a>
SN74S1051PWG4	ACTIVE	TSSOP	PW	16	90	Green (RoHS & no Sb/Br)	CU NIPDAU	Level-1-260C-UNLIM	0 to 70	S1051	<a href="#">Samples</a>
SN74S1051PWR	ACTIVE	TSSOP	PW	16	2000	Green (RoHS & no Sb/Br)	CU NIPDAU	Level-1-260C-UNLIM	0 to 70	S1051	<a href="#">Samples</a>
SN74S1051PWRE4	ACTIVE	TSSOP	PW	16	2000	Green (RoHS & no Sb/Br)	CU NIPDAU	Level-1-260C-UNLIM	0 to 70	S1051	<a href="#">Samples</a>
SN74S1051PWRG4	ACTIVE	TSSOP	PW	16	2000	Green (RoHS & no Sb/Br)	CU NIPDAU	Level-1-260C-UNLIM	0 to 70	S1051	<a href="#">Samples</a>

(1) The marketing status values are defined as follows:

**ACTIVE:** Product device recommended for new designs.

**LIFEBUY:** TI has announced that the device will be discontinued, and a lifetime-buy period is in effect.

**NRND:** Not recommended for new designs. Device is in production to support existing customers, but TI does not recommend using this part in a new design.

**PREVIEW:** Device has been announced but is not in production. Samples may or may not be available.

**OBSOLETE:** TI has discontinued the production of the device.

(2) Eco Plan - The planned eco-friendly classification: Pb-Free (RoHS), Pb-Free (RoHS Exempt), or Green (RoHS & no Sb/Br) - please check <http://www.ti.com/productcontent> for the latest availability information and additional product content details.

**TBD:** The Pb-Free/Green conversion plan has not been defined.

**Pb-Free (RoHS):** TI's terms "Lead-Free" or "Pb-Free" mean semiconductor products that are compatible with the current RoHS requirements for all 6 substances, including the requirement that lead not exceed 0.1% by weight in homogeneous materials. Where designed to be soldered at high temperatures, TI Pb-Free products are suitable for use in specified lead-free processes.

**Pb-Free (RoHS Exempt):** This component has a RoHS exemption for either 1) lead-based flip-chip solder bumps used between the die and package, or 2) lead-based die adhesive used between the die and leadframe. The component is otherwise considered Pb-Free (RoHS compatible) as defined above.

**Green (RoHS & no Sb/Br):** TI defines "Green" to mean Pb-Free (RoHS compatible), and free of Bromine (Br) and Antimony (Sb) based flame retardants (Br or Sb do not exceed 0.1% by weight in homogeneous material)

(3) MSL, Peak Temp. -- The Moisture Sensitivity Level rating according to the JEDEC industry standard classifications, and peak solder temperature.

(4) Only one of markings shown within the brackets will appear on the physical device.

**Important Information and Disclaimer:** The information provided on this page represents TI's knowledge and belief as of the date that it is provided. TI bases its knowledge and belief on information provided by third parties, and makes no representation or warranty as to the accuracy of such information. Efforts are underway to better integrate information from third parties. TI has taken and continues to take reasonable steps to provide representative and accurate information but may not have conducted destructive testing or chemical analysis on incoming materials and chemicals. TI and TI suppliers consider certain information to be proprietary, and thus CAS numbers and other limited information may not be available for release.

In no event shall TI's liability arising out of such information exceed the total purchase price of the TI part(s) at issue in this document sold by TI to Customer on an annual basis.



## TAPE AND REEL INFORMATION



### QUADRANT ASSIGNMENTS FOR PIN 1 ORIENTATION IN TAPE



\*All dimensions are nominal

Device	Package Type	Package Drawing	Pins	SPQ	Reel Diameter (mm)	Reel Width W1 (mm)	A0 (mm)	B0 (mm)	K0 (mm)	P1 (mm)	W (mm)	Pin1 Quadrant
SN74S1051DR	SOIC	D	16	2500	330.0	16.4	6.5	10.3	2.1	8.0	16.0	Q1
SN74S1051NSR	SO	NS	16	2000	330.0	16.4	8.2	10.5	2.5	12.0	16.0	Q1
SN74S1051PWR	TSSOP	PW	16	2000	330.0	12.4	6.9	5.6	1.6	8.0	12.0	Q1

## TAPE AND REEL BOX DIMENSIONS



\*All dimensions are nominal

Device	Package Type	Package Drawing	Pins	SPQ	Length (mm)	Width (mm)	Height (mm)
SN74S1051DR	SOIC	D	16	2500	333.2	345.9	28.6
SN74S1051NSR	SO	NS	16	2000	367.0	367.0	38.0
SN74S1051PWR	TSSOP	PW	16	2000	367.0	367.0	35.0

N (R-PDIP-T\*\*)

PLASTIC DUAL-IN-LINE PACKAGE

16 PINS SHOWN

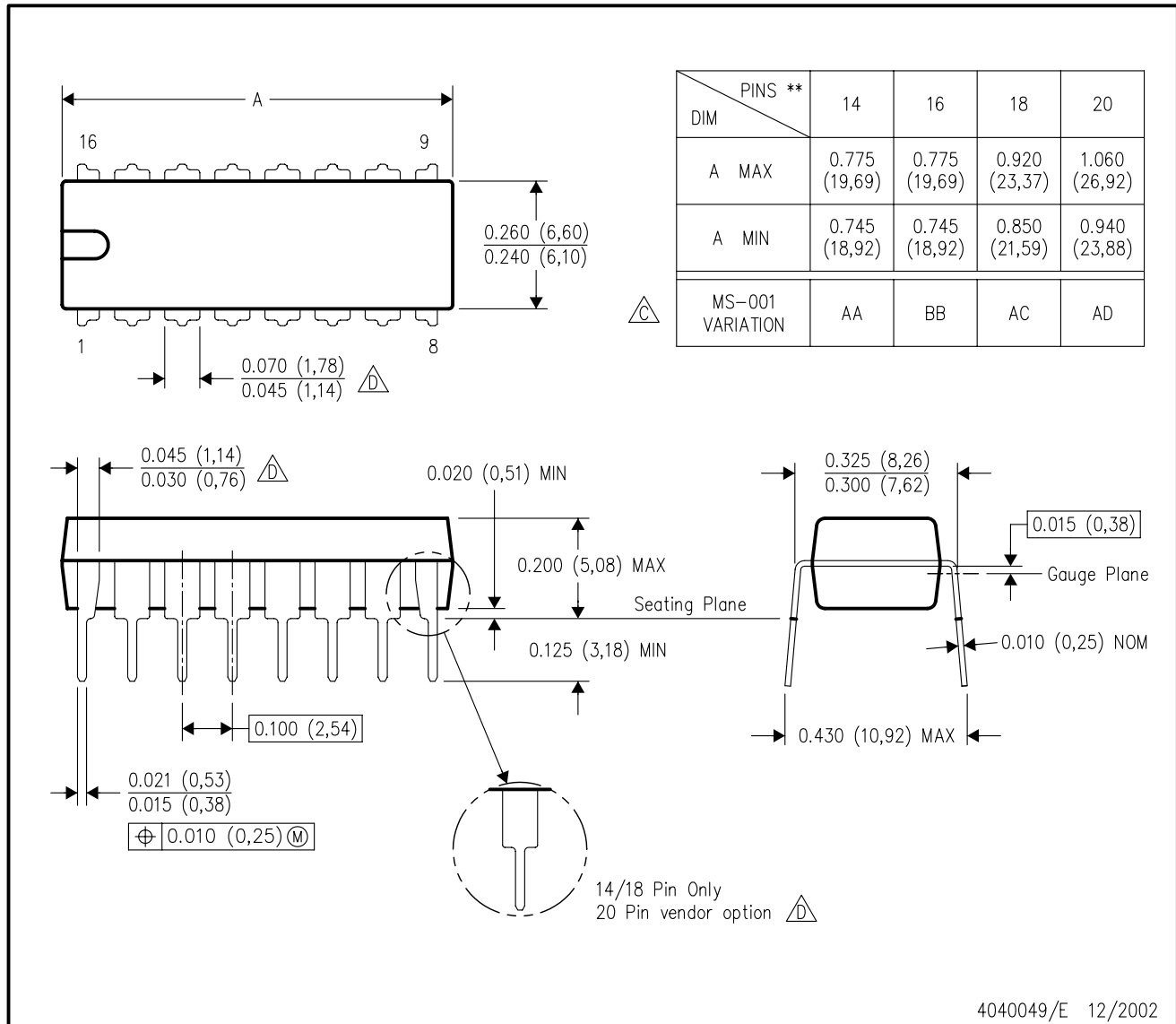

- NOTES:
- A. All linear dimensions are in inches (millimeters).
  - B. This drawing is subject to change without notice.
  - Falls within JEDEC MS-001, except 18 and 20 pin minimum body length (Dim A).
  - The 20 pin end lead shoulder width is a vendor option, either half or full width.

D (R-PDSO-G16)

PLASTIC SMALL OUTLINE



- NOTES:
- A. All linear dimensions are in inches (millimeters).
  - B. This drawing is subject to change without notice.
  - C. Body length does not include mold flash, protrusions, or gate burrs. Mold flash, protrusions, or gate burrs shall not exceed 0.006 (0,15) each side.
  - D. Body width does not include interlead flash. Interlead flash shall not exceed 0.017 (0,43) each side.
  - E. Reference JEDEC MS-012 variation AC.

D (R-PDSO-G16)

PLASTIC SMALL OUTLINE





- NOTES:
- All linear dimensions are in millimeters.
  - This drawing is subject to change without notice.
  - Publication IPC-7351 is recommended for alternate designs.
  - Laser cutting apertures with trapezoidal walls and also rounding corners will offer better paste release. Customers should contact their board assembly site for stencil design recommendations. Refer to IPC-7525 for other stencil recommendations.
  - Customers should contact their board fabrication site for solder mask tolerances between and around signal pads.

PW (R-PDSO-G16)

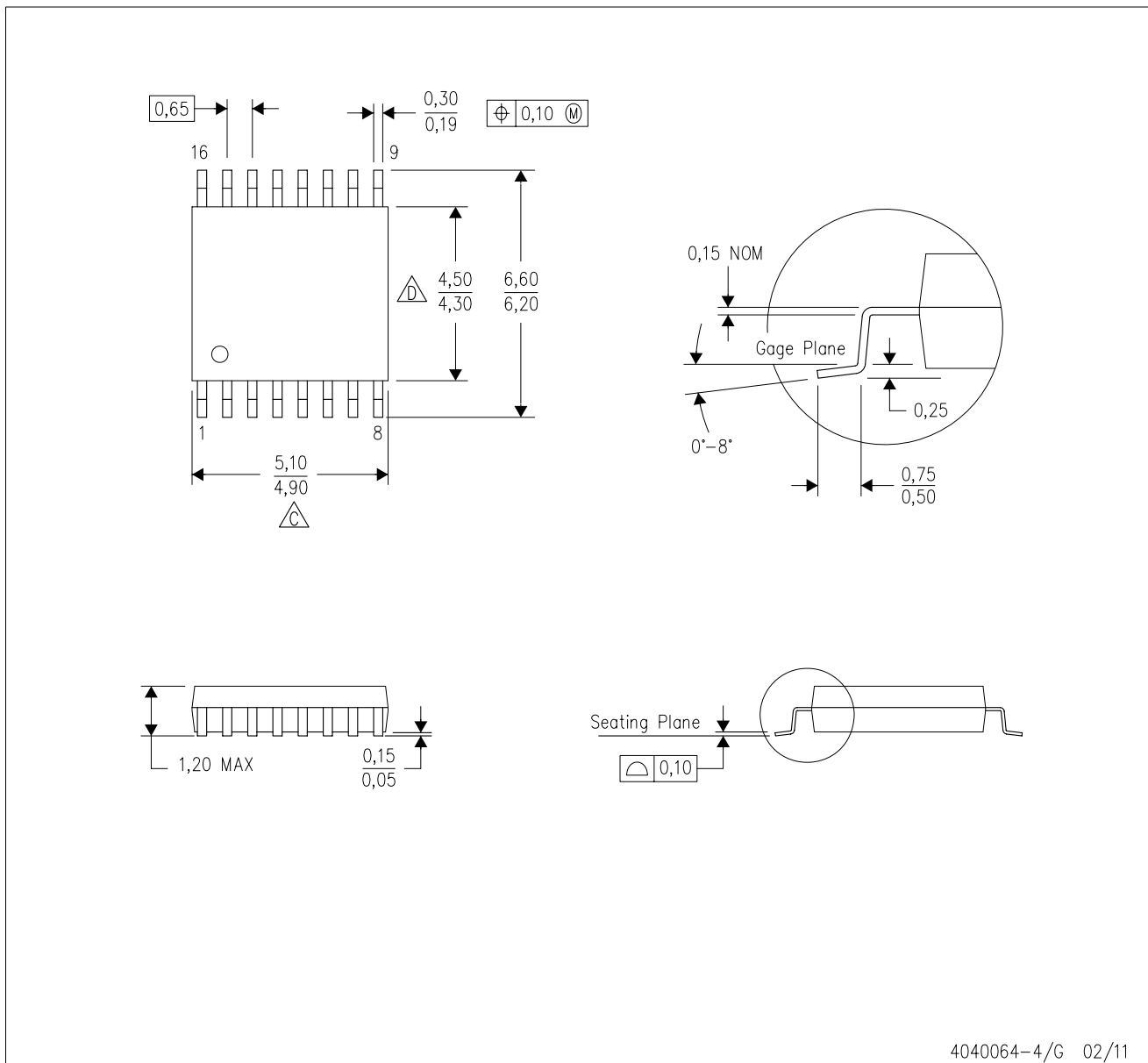
PLASTIC SMALL OUTLINE



4040064-4/G 02/11

- NOTES:
- A. All linear dimensions are in millimeters. Dimensioning and tolerancing per ASME Y14.5M-1994.
  - B. This drawing is subject to change without notice.
  -  Body length does not include mold flash, protrusions, or gate burrs. Mold flash, protrusions, or gate burrs shall not exceed 0,15 each side.
  -  Body width does not include interlead flash. Interlead flash shall not exceed 0,25 each side.
  - E. Falls within JEDEC MO-153

PW (R-PDSO-G16)

PLASTIC SMALL OUTLINE

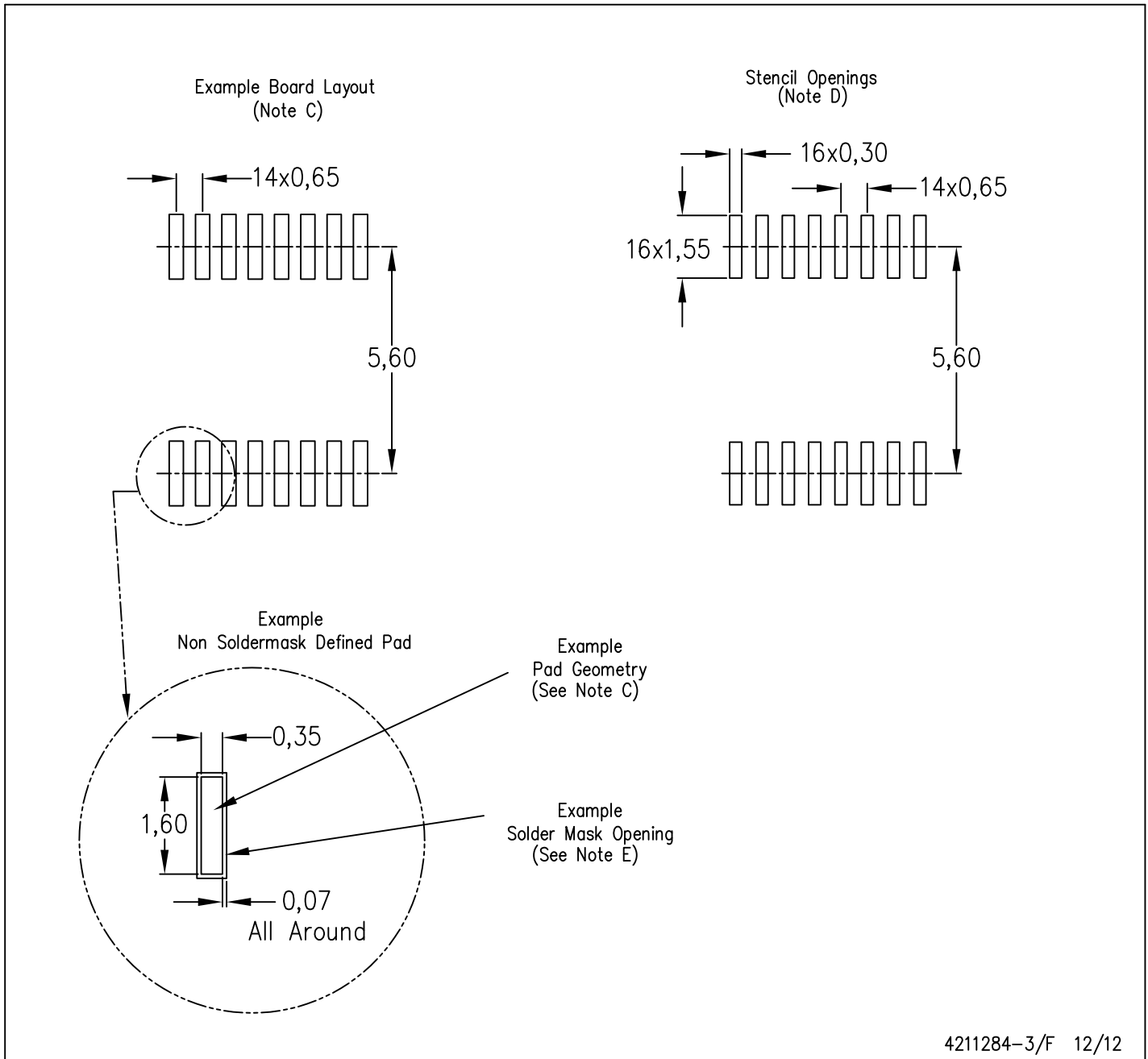

- NOTES:
- All linear dimensions are in millimeters.
  - This drawing is subject to change without notice.
  - Publication IPC-7351 is recommended for alternate designs.
  - Laser cutting apertures with trapezoidal walls and also rounding corners will offer better paste release. Customers should contact their board assembly site for stencil design recommendations. Refer to IPC-7525 for other stencil recommendations.
  - Customers should contact their board fabrication site for solder mask tolerances between and around signal pads.

# MECHANICAL DATA

NS (R-PDSO-G\*\*)

PLASTIC SMALL-OUTLINE PACKAGE

14-PINS SHOWN



- NOTES:
- A. All linear dimensions are in millimeters.
  - B. This drawing is subject to change without notice.
  - C. Body dimensions do not include mold flash or protrusion, not to exceed 0,15.



## IMPORTANT NOTICE

Texas Instruments Incorporated and its subsidiaries (TI) reserve the right to make corrections, enhancements, improvements and other changes to its semiconductor products and services per JESD46, latest issue, and to discontinue any product or service per JESD48, latest issue. Buyers should obtain the latest relevant information before placing orders and should verify that such information is current and complete. All semiconductor products (also referred to herein as "components") are sold subject to TI's terms and conditions of sale supplied at the time of order acknowledgment.

TI warrants performance of its components to the specifications applicable at the time of sale, in accordance with the warranty in TI's terms and conditions of sale of semiconductor products. Testing and other quality control techniques are used to the extent TI deems necessary to support this warranty. Except where mandated by applicable law, testing of all parameters of each component is not necessarily performed.

TI assumes no liability for applications assistance or the design of Buyers' products. Buyers are responsible for their products and applications using TI components. To minimize the risks associated with Buyers' products and applications, Buyers should provide adequate design and operating safeguards.

TI does not warrant or represent that any license, either express or implied, is granted under any patent right, copyright, mask work right, or other intellectual property right relating to any combination, machine, or process in which TI components or services are used. Information published by TI regarding third-party products or services does not constitute a license to use such products or services or a warranty or endorsement thereof. Use of such information may require a license from a third party under the patents or other intellectual property of the third party, or a license from TI under the patents or other intellectual property of TI.

Reproduction of significant portions of TI information in TI data books or data sheets is permissible only if reproduction is without alteration and is accompanied by all associated warranties, conditions, limitations, and notices. TI is not responsible or liable for such altered documentation. Information of third parties may be subject to additional restrictions.

Resale of TI components or services with statements different from or beyond the parameters stated by TI for that component or service voids all express and any implied warranties for the associated TI component or service and is an unfair and deceptive business practice. TI is not responsible or liable for any such statements.

Buyer acknowledges and agrees that it is solely responsible for compliance with all legal, regulatory and safety-related requirements concerning its products, and any use of TI components in its applications, notwithstanding any applications-related information or support that may be provided by TI. Buyer represents and agrees that it has all the necessary expertise to create and implement safeguards which anticipate dangerous consequences of failures, monitor failures and their consequences, lessen the likelihood of failures that might cause harm and take appropriate remedial actions. Buyer will fully indemnify TI and its representatives against any damages arising out of the use of any TI components in safety-critical applications.

In some cases, TI components may be promoted specifically to facilitate safety-related applications. With such components, TI's goal is to help enable customers to design and create their own end-product solutions that meet applicable functional safety standards and requirements. Nonetheless, such components are subject to these terms.

No TI components are authorized for use in FDA Class III (or similar life-critical medical equipment) unless authorized officers of the parties have executed a special agreement specifically governing such use.

Only those TI components which TI has specifically designated as military grade or "enhanced plastic" are designed and intended for use in military/aerospace applications or environments. Buyer acknowledges and agrees that any military or aerospace use of TI components which have **not** been so designated is solely at the Buyer's risk, and that Buyer is solely responsible for compliance with all legal and regulatory requirements in connection with such use.

TI has specifically designated certain components as meeting ISO/TS16949 requirements, mainly for automotive use. In any case of use of non-designated products, TI will not be responsible for any failure to meet ISO/TS16949.

### Products

Audio	<a href="http://www.ti.com/audio">www.ti.com/audio</a>
Amplifiers	<a href="http://amplifier.ti.com">amplifier.ti.com</a>
Data Converters	<a href="http://dataconverter.ti.com">dataconverter.ti.com</a>
DLP® Products	<a href="http://www.dlp.com">www.dlp.com</a>
DSP	<a href="http://dsp.ti.com">dsp.ti.com</a>
Clocks and Timers	<a href="http://www.ti.com/clocks">www.ti.com/clocks</a>
Interface	<a href="http://interface.ti.com">interface.ti.com</a>
Logic	<a href="http://logic.ti.com">logic.ti.com</a>
Power Mgmt	<a href="http://power.ti.com">power.ti.com</a>
Microcontrollers	<a href="http://microcontroller.ti.com">microcontroller.ti.com</a>
RFID	<a href="http://www.ti-rfid.com">www.ti-rfid.com</a>
OMAP Applications Processors	<a href="http://www.ti.com/omap">www.ti.com/omap</a>
Wireless Connectivity	<a href="http://www.ti.com/wirelessconnectivity">www.ti.com/wirelessconnectivity</a>

### Applications

Automotive and Transportation	<a href="http://www.ti.com/automotive">www.ti.com/automotive</a>
Communications and Telecom	<a href="http://www.ti.com/communications">www.ti.com/communications</a>
Computers and Peripherals	<a href="http://www.ti.com/computers">www.ti.com/computers</a>
Consumer Electronics	<a href="http://www.ti.com/consumer-apps">www.ti.com/consumer-apps</a>
Energy and Lighting	<a href="http://www.ti.com/energy">www.ti.com/energy</a>
Industrial	<a href="http://www.ti.com/industrial">www.ti.com/industrial</a>
Medical	<a href="http://www.ti.com/medical">www.ti.com/medical</a>
Security	<a href="http://www.ti.com/security">www.ti.com/security</a>
Space, Avionics and Defense	<a href="http://www.ti.com/space-avionics-defense">www.ti.com/space-avionics-defense</a>
Video and Imaging	<a href="http://www.ti.com/video">www.ti.com/video</a>

### TI E2E Community

[e2e.ti.com](http://e2e.ti.com)



## Стандарт Электрон Связь

Мы молодая и активно развивающаяся компания в области поставок электронных компонентов. Мы поставляем электронные компоненты отечественного и импортного производства напрямую от производителей и с крупнейших складов мира.

Благодаря сотрудничеству с мировыми поставщиками мы осуществляем комплексные и плановые поставки широчайшего спектра электронных компонентов.

Собственная эффективная логистика и склад в обеспечивает надежную поставку продукции в точно указанные сроки по всей России.

Мы осуществляем техническую поддержку нашим клиентам и предпродажную проверку качества продукции. На все поставляемые продукты мы предоставляем гарантию .

Осуществляем поставки продукции под контролем ВП МО РФ на предприятия военно-промышленного комплекса России , а также работаем в рамках 275 ФЗ с открытием отдельных счетов в уполномоченном банке. Система менеджмента качества компании соответствует требованиям ГОСТ ISO 9001.

Минимальные сроки поставки, гибкие цены, неограниченный ассортимент и индивидуальный подход к клиентам являются основой для выстраивания долгосрочного и эффективного сотрудничества с предприятиями радиоэлектронной промышленности, предприятиями ВПК и научно-исследовательскими институтами России.

С нами вы становитесь еще успешнее!

### Наши контакты:

**Телефон:** +7 812 627 14 35

**Электронная почта:** [sales@st-electron.ru](mailto:sales@st-electron.ru)

**Адрес:** 198099, Санкт-Петербург,  
Промышленная ул, дом № 19, литера Н,  
помещение 100-Н Офис 331