

Features

- High junction temperature: $T_j = 150\text{ °C}$
- Medium current SCRs
- High noise immunity up to 150 °C
- RoHS (2002/95/EC) compliant
- $600\text{ V } V_{\text{DRM}}, V_{\text{RRM}}$

Application

- General purpose AC line load switching
- Motor control circuits
- Small home appliances
- Lighting
- Inrush current limiting circuits
- Over-voltage crowbar protection

Description

Available in standard gate triggering levels, the TN1205H SCR series has very high switching capability up to junction temperature of 150 °C .

These products fit all modes of control found in applications such as overvoltage crowbar protection, motor control circuits in power tools and kitchen aids, inrush current limiting circuits, capacitive discharge ignition and voltage regulation circuits.

These products are particularly adapted for use in areas where the ambient temperature is high or the ventilation low, or where an increase of power density is required.

Through-hole or surface-mount packages provide performance in a limited space area.

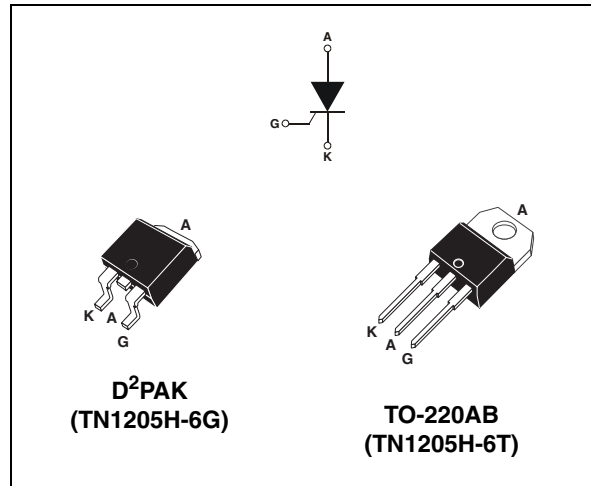

Table 1. Device summary

Order code	Package	$V_{\text{DRM}}, V_{\text{RRM}}$	I_{GT}
TN1205H-6T	TO-220AB	600 V	2 to 5 mA
TN1205H-6G	D ² PAK		

1 Characteristics

Table 2. Absolute ratings (limiting values)

Symbol	Parameter			Value	Unit	
$I_{T(RMS)}$	On-state rms current (180° conduction angle)	TO220-AB, D ² PAK	$T_c = 136\text{ °C}$	12	A	
$I_{T(AV)}$	Average on-state current (180° conduction angle)			7.6	A	
I_{TSM}	Non repetitive surge peak on-state current		$T_j = 25\text{ °C}$	$t_p = 8.3\text{ ms}$	126	A
				$t_p = 10\text{ ms}$	120	
I^2t	I^2t Value for fusing		$t_p = 10\text{ ms}$	72	A ² S	
V_{DSM}, V_{RSM}	Non repetitive surge peak off-state voltage		$t_p = 10\text{ ms}$	$V_{DRM}, V_{RRM} + 100$	V	
di/dt	Critical rate of rise of on-state current $I_G = 2 \times I_{GT}$, $t_r \leq 100\text{ ns}$	$F = 60\text{ Hz}$	$T_j = 150\text{ °C}$	100	A/ μ s	
I_{GM}	Peak gate current	$t_p = 20\text{ }\mu$ s	$T_j = 150\text{ °C}$	4	A	
$P_{G(AV)}$	Average gate power dissipation		$T_j = 150\text{ °C}$	1	W	
V_{RGM}	Maximum peak reverse gate voltage			5	V	
T_{stg} T_j	Storage junction temperature range Operating junction temperature range			- 40 to + 150	°C	
T_L	Maximum lead temperature for soldering during 10 s.			260	°C	

Table 3. Electrical characteristics ($T_j = 25\text{ °C}$, unless otherwise specified)

Symbol	Test conditions		Value	Unit
I_{GT}	$V_D = 12\text{ V}, R_L = 33\text{ }\Omega$	MIN.	2	mA
		MAX.	5	
V_{GT}	$V_D = V_{DRM}, R_L = 3.3\text{ k}\Omega$	MAX.	1.3	V
V_{GD}	$V_D = V_{DRM}, R_L = 3.3\text{ k}\Omega$	MIN.	0.2	V
I_H	$I_T = 500\text{ mA}$ gate open	MAX.	20	mA
I_L	$I_G = 1.2 I_{GT}$	MAX.	40	mA
dV/dt	$V_D = 67\% V_{DRM}$ gate open	$T_j = 125\text{ °C}$	200	V/ μ s
		$T_j = 150\text{ °C}$	100	
t_{gt}	$I_{TM} = 40\text{ A}, V_D = 500\text{ V}, I_G = 100\text{ mA}, di_G/dt = 5\text{ A}/\mu$ s	typ.	1.9	μ s
t_q	$V_{DM} = 335\text{ V}, T_j = 125\text{ °C}, I_{TM} = 20\text{ A}, V_R = 25\text{ V}, (di_T/dt)_{Max} = 30\text{ A}/\mu$ s, $dV_D/dt = 50\text{ V}/\mu$ s, $R_{GK} = 100\text{ }\Omega$	typ.	65	μ s

Table 4. Static characteristics

Symbol	Test conditions		Value	Unit	
V_T	$I_{TM} = 24\text{ A}$, $t_p = 380\ \mu\text{s}$	$T_j = 25\text{ }^\circ\text{C}$	MAX.	1.6	V
V_{TD}	Threshold voltage	$T_j = 150\text{ }^\circ\text{C}$		0.8	V
R_d	Dynamic resistance	$T_j = 150\text{ }^\circ\text{C}$		30	m Ω
I_{DRM} I_{RRM}	$V_{DRM} = V_{RRM}$	$T_j = 25\text{ }^\circ\text{C}$		5	μA
		$T_j = 125\text{ }^\circ\text{C}$	1	mA	
		$T_j = 150\text{ }^\circ\text{C}$	3		

Table 5. Thermal resistance

Symbol	Parameter		Value Max.	Unit	
$R_{th(j-c)}$	Junction to case (DC)		1.3	$^\circ\text{C/W}$	
$R_{th(j-a)}$	Junction to ambient (DC)	$S^{(1)} = 1\text{ cm}^2$	D ² PAK	45	$^\circ\text{C/W}$
			TO-220AB	60	

1. S = Copper surface under tab

Figure 1. Maximum average power dissipation vs. average on-state current

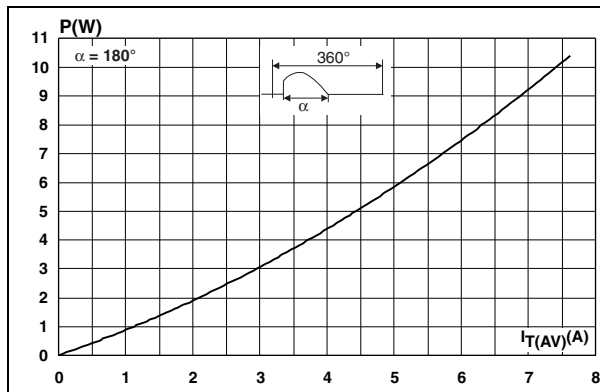

Figure 2. Average and DC on-state current vs. case temperature

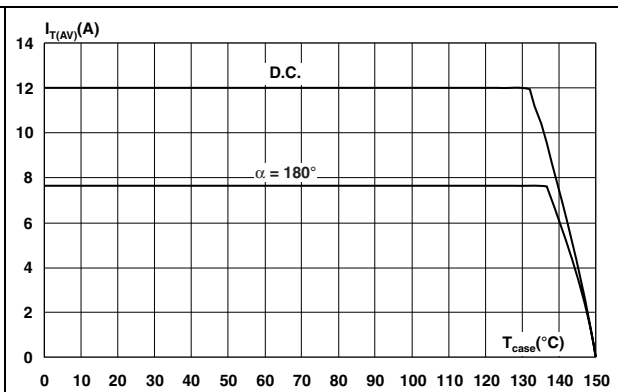

Figure 3. Average and DC on-state current vs. ambient temperature

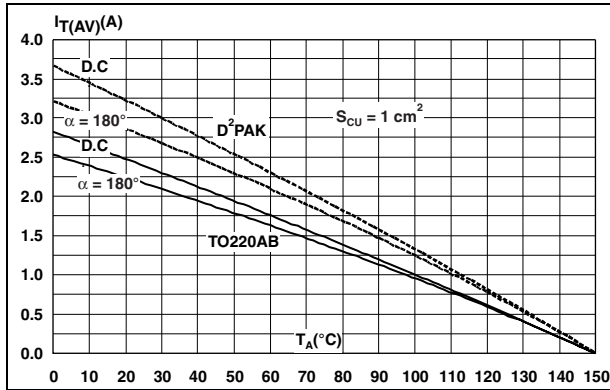

Figure 4. Relative variation of thermal impedance vs. pulse duration

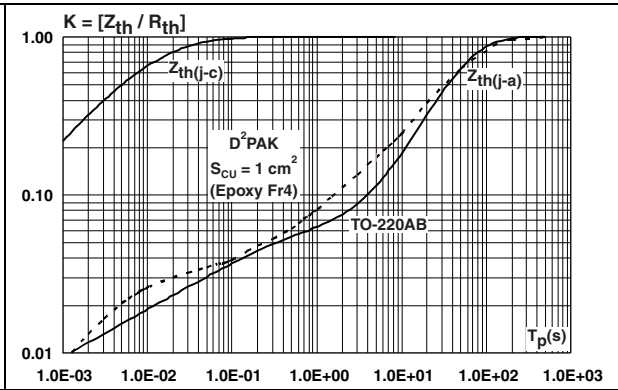

Figure 5. Relative variation of I_{GT}, V_{GT}, I_H, I_L vs. junction temperature (typical values)

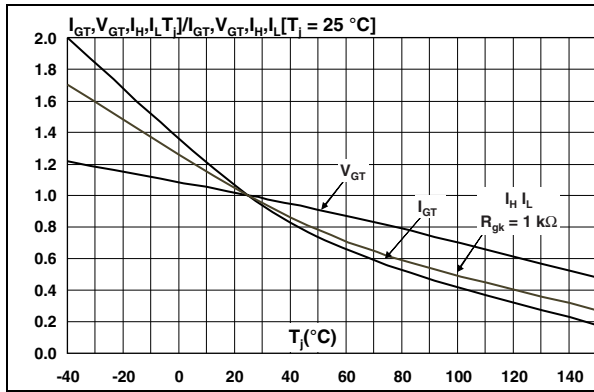

Figure 6. Relative variation of static dV/dt immunity vs. junction temperature (typical values)

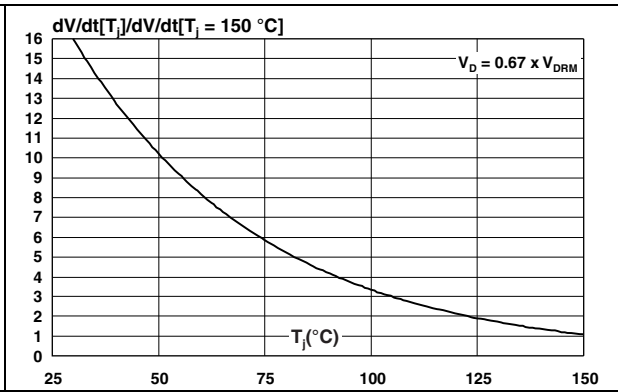

Figure 7. Surge peak on-state current vs. number of cycles

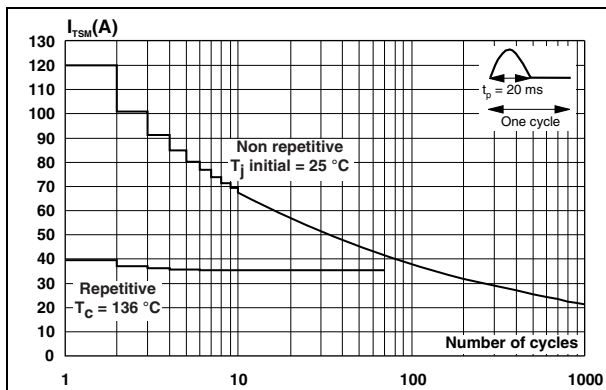

Figure 8. Non repetitive surge peak on-state current and corresponding value of I^2t vs. sinusoidal pulse width

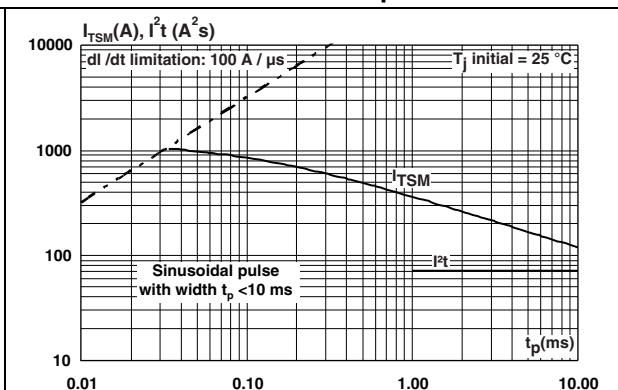

Figure 9. On-state characteristics (maximum values)

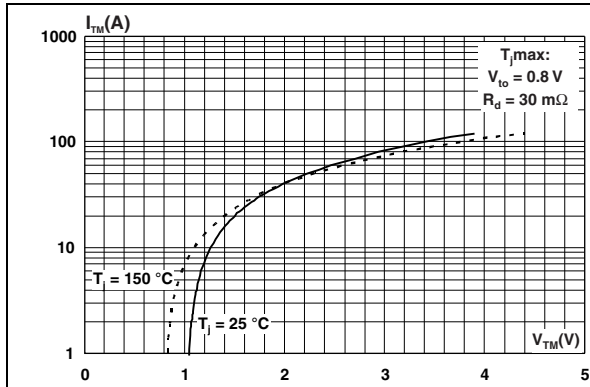

Figure 10. Relative variation of leakage current vs. junction temperature for different values of blocking voltage

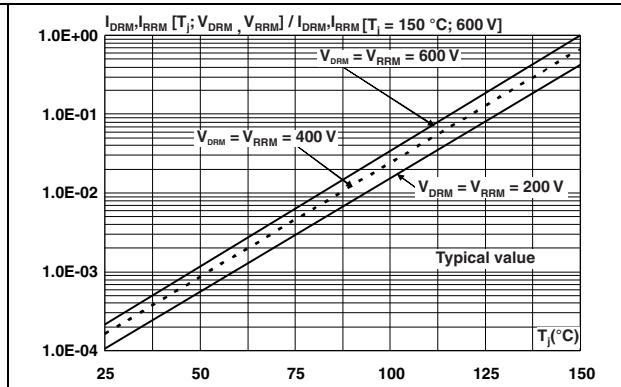
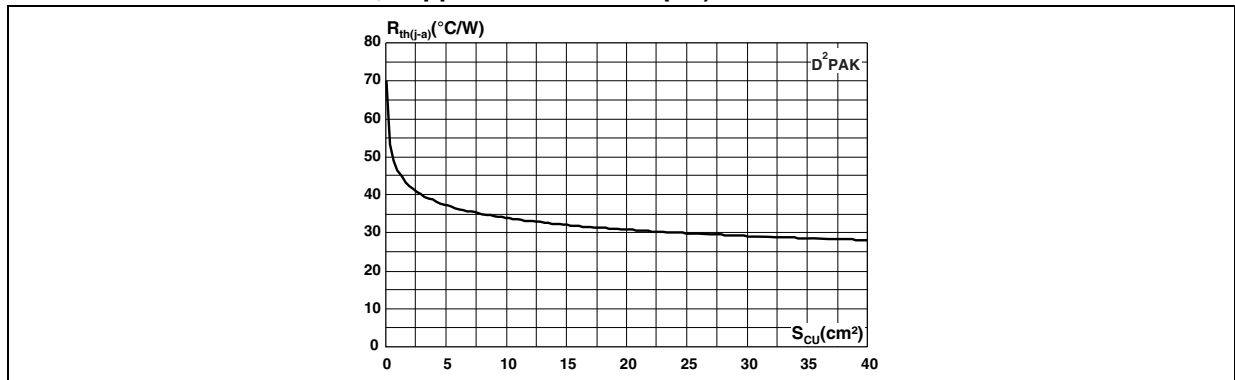
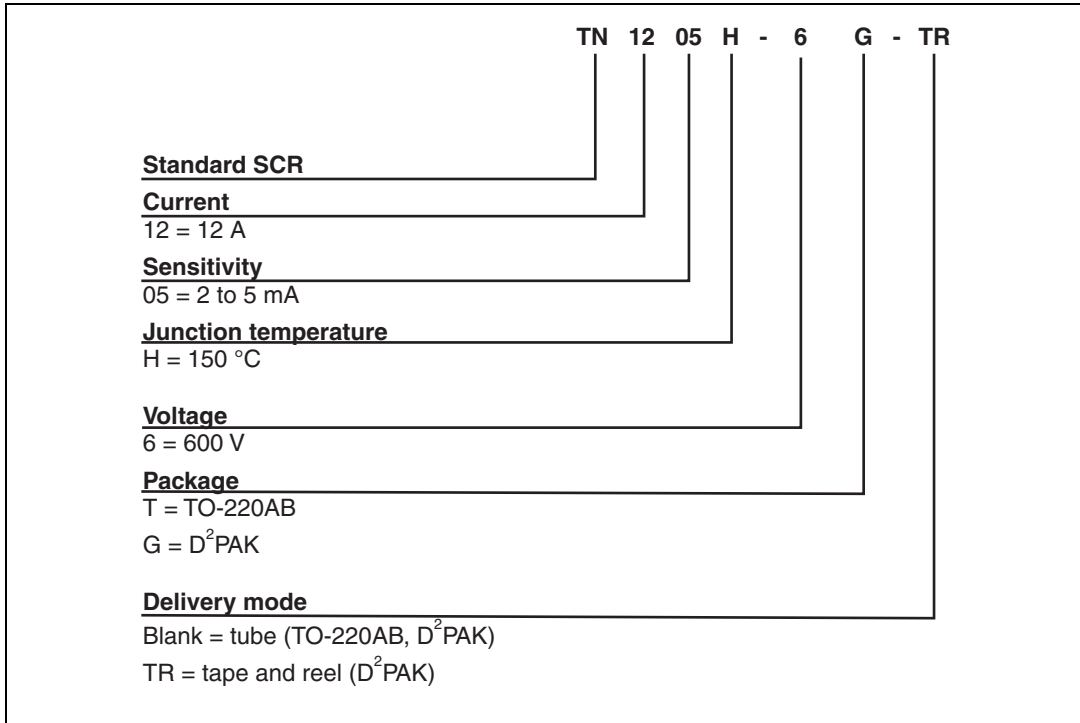

Figure 11. Thermal resistance junction to ambient vs. copper surface under tab (D^2 PAK, printed circuit board FR4, copper thickness: 35 μm)



2 Ordering information scheme

Figure 12. Ordering information scheme



3 Package information

- Epoxy meets UL94, V0
- Lead-free package

In order to meet environmental requirements, ST offers these devices in different grades of ECOPACK® packages, depending on their level of environmental compliance. ECOPACK® specifications, grade definitions and product status are available at: www.st.com. ECOPACK® is an ST trademark.

Table 6. TO-220AB dimensions

Ref.	Dimensions					
	Millimeters			Inches		
	Min.	Typ.	Max.	Min.	Typ.	Max.
A	15.20		15.90	0.598		0.625
a1		3.75			0.147	
a2	13.00		14.00	0.511		0.551
B	10.00		10.40	0.393		0.409
b1	0.61		0.88	0.024		0.034
b2	1.23		1.32	0.048		0.051
C	4.40		4.60	0.173		0.181
c1	0.49		0.70	0.019		0.027
c2	2.40		2.72	0.094		0.107
e	2.40		2.70	0.094		0.106
F	6.20		6.60	0.244		0.259
ØI	3.75		3.85	0.147		0.151
I4	15.80	16.40	16.80	0.622	0.646	0.661
L	2.65		2.95	0.104		0.116
I2	1.14		1.70	0.044		0.066
I3	1.14		1.70	0.044		0.066
M		2.60			0.102	

Table 7. D²PAK Dimensions

Ref.	Dimensions					
	Millimeters			Inches		
	Min.	Typ.	Max.	Min.	Typ.	Max.
A	4.30		4.60	0.169		0.181
A1	2.49		2.69	0.098		0.106
A2	0.03		0.23	0.001		0.009
B	0.70		0.93	0.027		0.037
B2	1.25	1.40		0.048	0.055	
C	0.45		0.60	0.017		0.024
C2	1.21		1.36	0.047		0.054
D	8.95		9.35	0.352		0.368
E	10.00		10.28	0.393		0.405
G	4.88		5.28	0.192		0.208
L	15.00		15.85	0.590		0.624
L2	1.27		1.40	0.050		0.055
L3	1.40		1.75	0.055		0.069
R	0.40			0.016		
V2	0°		8°	0°		8°

Figure 13. Footprint (dimensions in mm)

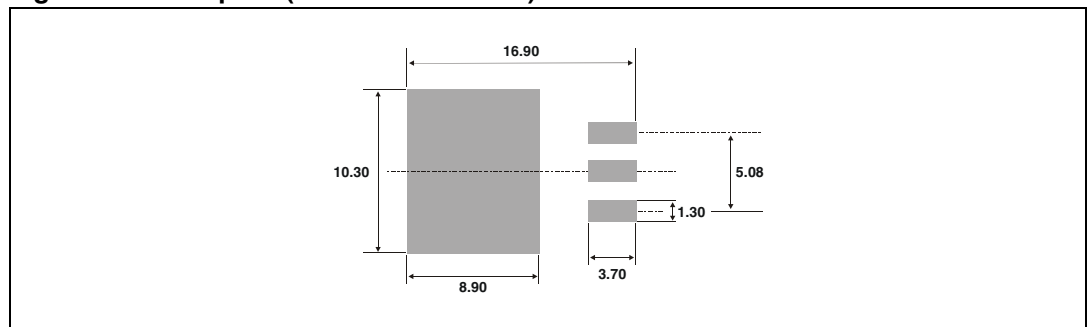

4 Ordering information

Table 8. Ordering information

Order code	Marking	Package	Weight	Base qty	Delivery mode
TN1205H-6T	TN1205H6T	TO-220AB	2.0 g	50	Tube
TN1205H-6G	TN1205H6G	D ² PAK	1.5 g	50	Tube
TN1205H-6G-TR	TN1205H6G	D ² PAK	1.5 g	1000	Tape and reel

5 Revision history

Table 9. Document revision history

Date	Revision	Changes
17-Feb-2011	1	First issue.
26-Sep-2011	2	Corrected typographical error in Features and Description.
17-Jan-2012	3	Updated units for t_{gt} in Table 3 .
26-Apr-2012	4	Moved junction temperature to top of features list. Description reworded for readability. No technical changes.

Please Read Carefully:

Information in this document is provided solely in connection with ST products. STMicroelectronics NV and its subsidiaries ("ST") reserve the right to make changes, corrections, modifications or improvements, to this document, and the products and services described herein at any time, without notice.

All ST products are sold pursuant to ST's terms and conditions of sale.

Purchasers are solely responsible for the choice, selection and use of the ST products and services described herein, and ST assumes no liability whatsoever relating to the choice, selection or use of the ST products and services described herein.

No license, express or implied, by estoppel or otherwise, to any intellectual property rights is granted under this document. If any part of this document refers to any third party products or services it shall not be deemed a license grant by ST for the use of such third party products or services, or any intellectual property contained therein or considered as a warranty covering the use in any manner whatsoever of such third party products or services or any intellectual property contained therein.

UNLESS OTHERWISE SET FORTH IN ST'S TERMS AND CONDITIONS OF SALE ST DISCLAIMS ANY EXPRESS OR IMPLIED WARRANTY WITH RESPECT TO THE USE AND/OR SALE OF ST PRODUCTS INCLUDING WITHOUT LIMITATION IMPLIED WARRANTIES OF MERCHANTABILITY, FITNESS FOR A PARTICULAR PURPOSE (AND THEIR EQUIVALENTS UNDER THE LAWS OF ANY JURISDICTION), OR INFRINGEMENT OF ANY PATENT, COPYRIGHT OR OTHER INTELLECTUAL PROPERTY RIGHT.

UNLESS EXPRESSLY APPROVED IN WRITING BY TWO AUTHORIZED ST REPRESENTATIVES, ST PRODUCTS ARE NOT RECOMMENDED, AUTHORIZED OR WARRANTED FOR USE IN MILITARY, AIR CRAFT, SPACE, LIFE SAVING, OR LIFE SUSTAINING APPLICATIONS, NOR IN PRODUCTS OR SYSTEMS WHERE FAILURE OR MALFUNCTION MAY RESULT IN PERSONAL INJURY, DEATH, OR SEVERE PROPERTY OR ENVIRONMENTAL DAMAGE. ST PRODUCTS WHICH ARE NOT SPECIFIED AS "AUTOMOTIVE GRADE" MAY ONLY BE USED IN AUTOMOTIVE APPLICATIONS AT USER'S OWN RISK.

Resale of ST products with provisions different from the statements and/or technical features set forth in this document shall immediately void any warranty granted by ST for the ST product or service described herein and shall not create or extend in any manner whatsoever, any liability of ST.

ST and the ST logo are trademarks or registered trademarks of ST in various countries.

Information in this document supersedes and replaces all information previously supplied.

The ST logo is a registered trademark of STMicroelectronics. All other names are the property of their respective owners.

© 2012 STMicroelectronics - All rights reserved

STMicroelectronics group of companies

Australia - Belgium - Brazil - Canada - China - Czech Republic - Finland - France - Germany - Hong Kong - India - Israel - Italy - Japan - Malaysia - Malta - Morocco - Philippines - Singapore - Spain - Sweden - Switzerland - United Kingdom - United States of America

www.st.com



Стандарт Электрон Связь

Мы молодая и активно развивающаяся компания в области поставок электронных компонентов. Мы поставляем электронные компоненты отечественного и импортного производства напрямую от производителей и с крупнейших складов мира.

Благодаря сотрудничеству с мировыми поставщиками мы осуществляем комплексные и плановые поставки широчайшего спектра электронных компонентов.

Собственная эффективная логистика и склад в обеспечивает надежную поставку продукции в точно указанные сроки по всей России.

Мы осуществляем техническую поддержку нашим клиентам и предпродажную проверку качества продукции. На все поставляемые продукты мы предоставляем гарантию .

Осуществляем поставки продукции под контролем ВП МО РФ на предприятия военно-промышленного комплекса России , а также работаем в рамках 275 ФЗ с открытием отдельных счетов в уполномоченном банке. Система менеджмента качества компании соответствует требованиям ГОСТ ISO 9001.

Минимальные сроки поставки, гибкие цены, неограниченный ассортимент и индивидуальный подход к клиентам являются основой для выстраивания долгосрочного и эффективного сотрудничества с предприятиями радиоэлектронной промышленности, предприятиями ВПК и научно-исследовательскими институтами России.

С нами вы становитесь еще успешнее!

Наши контакты:

Телефон: +7 812 627 14 35

Электронная почта: sales@st-electron.ru

Адрес: 198099, Санкт-Петербург,
Промышленная ул, дом № 19, литера Н,
помещение 100-Н Офис 331