

## Install in 22-dia. or 25-dia. Panel Cutout

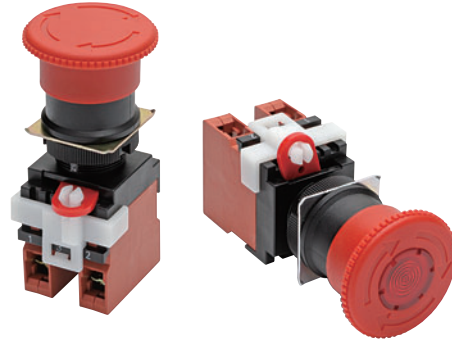

- Direct opening mechanism to open the circuit when the contact welds ☹.
- Safety lock mechanism prevents operating errors.
- Easy mounting and removal of Switch Blocks using a lever.
- Mount three Switch Units in series to improve wiring efficiency (with non-lighted Switch Units, three Units can be mounted for multiple contacts).
- Finger protection mechanism on Switch Unit provided as a standard feature.
- Install using either round, or forked crimp terminals.
- Oil-resistant to IP65 (non-lighted models)/IP65 (lighted models)
- A lock plate is provided as a standard feature to ensure that the control box and switch are not easily separated.



For the most recent information on models that have been certified for safety standards, refer to your OMRON website.

Be sure to read the "Safety Precautions" on page 17.

## Model Number Structure

**Model Number Legend (Completely Assembled)**..... Shipped as a set which includes the Operation Unit, Lamp (lighted models only), and Switch.

A22E **L** - **M** - **24A** - **01** - **□**

### 1. Lighted/Non-lighted

Code	Description
None	Non-lighted
L	Lighted *

\* Lighted Emergency Stop Switches are available only for the medium (M) push-lock turn-reset models.

### 2. Head Size

Code	Size	Description
MP	Medium 40 dia.	Push-pull
S	Small 30 dia.	Push-lock turn-reset
M	Medium 40 dia.	
L	Large 60 dia.	

### 3. Light Source Without Voltage Reduction Unit

Code	Description	Operating Voltage
None	Non-lighted	---
6A	LED	6 VAC/VDC
12A		12 VAC/VDC
24A		24 VAC/VDC

### With Voltage Reduction Unit

Code	Description	Operating Voltage
T1	LED	100 VAC
T2		200 VAC

Equipped with 24-VAC/DC LED.

### 4. Contacts

Code	Description
01	1NC
11	1NO + 1NC
02	2NC (1NC + 1NC)
12	1NO + 2NC (1NC + 1NC)
03	3NC (1NC + 1NC + 1NC)





### 5. Configuration

Code	Configuration
None	Switch only
B	Switch with Integrated Control Box

## Ordering Information

### List of Models (Completely Assembled)

#### Non-lighted Models



Operating		Set Model	Color of cap
Appearance	Contact Configuration		
40-dia. head Medium Push-pull A22E-MP		1NC	A22E-MP-01
		1NO + 1NC	A22E-MP-11
		2NC (1NC + 1NC)	A22E-MP-02
30-dia. head Small Push-lock Turn-reset A22E-S		1NC	A22E-S-01 *
		1NO + 1NC	A22E-S-11 *
		2NC (1NC + 1NC)	A22E-S-02 *
		1NO + 2NC (1NC + 1NC)	A22E-S-12 *
		3NC (1NC + 1NC + 1NC)	A22E-S-03 *
40-dia. head Medium Push-lock Turn-reset A22E-M		1NC	A22E-M-01 *
		1NO + 1NC	A22E-M-11 *
		2NC (1NC + 1NC)	A22E-M-02 *
		1NO + 2NC (1NC + 1NC)	A22E-M-12 *
		3NC (1NC + 1NC + 1NC)	A22E-M-03 *
60-dia. head Large Push-lock Turn-reset A22E-L		1NC	A22E-L-01 *
		1NO + 1NC	A22E-L-11 *
		2NC (1NC + 1NC)	A22E-L-02 *

\* Models with Korean S-mark certification.

**Note: 1.** Yellow cap models are also available (not for emergency stop use). Contact your OMRON representative.

**2.** The Operation Unit of A22E except models with EMO/EMS indication is red. (The engraved mark is not white.)

#### With EMO/EMS Indication (non-lighted)

Operating		Set Model	Color of cap
Appearance	Contact Configuration		
40-dia. head Medium Push-lock Turn-reset With EMO Indication		1NC	A22E-M-01-EMO *
		1NO + 1NC	A22E-M-11-EMO *
		2NC (1NC + 1NC)	A22E-M-02-EMO *
		1NO + 2NC (1NC + 1NC)	A22E-M-12-EMO *
		3NC (1NC + 1NC + 1NC)	A22E-M-03-EMO *
40-dia. head Medium Push-lock Turn-reset With EMS Indication		1NC	A22E-M-01-EMS *
		1NO + 1NC	A22E-M-11-EMS *
		2NC (1NC + 1NC)	A22E-M-02-EMS *
		1NO + 2NC (1NC + 1NC)	A22E-M-12-EMS *
		3NC (1NC + 1NC + 1NC)	A22E-M-03-EMS *

\* Models with Korean S-mark certification.



**Note:** The colors of switch blocks are the followings:

1NO: black

1NC: red

The above illustration shows the 2NC (1NC + 1NC) classification.

## Lighted Models

Appearance	Operating			Push-lock turn-reset system	Color of cap
	Contact configuration	Lighting	Rated voltage	Set Model	
40-dia. head Push-lock Turn-reset without Voltage Reduction Unit A22E 	1NC	LED	6 VAC/VDC	A22EL-M-6A-01 *	Red
			12 VAC/VDC	A22EL-M-12A-01 *	
			24 VAC/VDC	A22EL-M-24A-01 *	
	1NO + 1NC		6 VAC/VDC	A22EL-M-6A-11 *	
			12 VAC/VDC	A22EL-M-12A-11 *	
			24 VAC/VDC	A22EL-M-24A-11 *	
	2NC (1NC + 1NC)		6 VAC/VDC	A22EL-M-6A-02 *	
			12 VAC/VDC	A22EL-M-12A-02 *	
			24 VAC/VDC	A22EL-M-24A-02 *	
40-dia. head Push-lock Turn-reset with Voltage Reduction Unit A22E 	1NC	100 VAC	A22EL-M-T1-01		
		200 VAC	A22EL-M-T2-01		
	1NO + 1NC	100 VAC	A22EL-M-T1-11		
		200 VAC	A22EL-M-T2-11		
	2NC (1NC + 1NC)	100 VAC	A22EL-M-T1-02		
		200 VAC	A22EL-M-T2-02		

\* Models with Korean S-mark certification.

**Note:** The Operation Unit of A22E except models with EMO/EMS indication is red. (The engraved mark is not white.)

## Switch with Integrated Control Box

Appearance	Contact configuration	Model
	1NC	A22E-M-01B *
	1NO + 1NC	A22E-M-11B *
	2NC (1NC + 1NC)	A22E-M-02B *

\* Models with Korean S-mark certification.

**Subassembled**.....The Operation Unit, Lamp, or Switch can be ordered separately. Use them in combination for models that are not available as assembled Units. These can also be used as inventory for maintenance parts.

Non-lighted

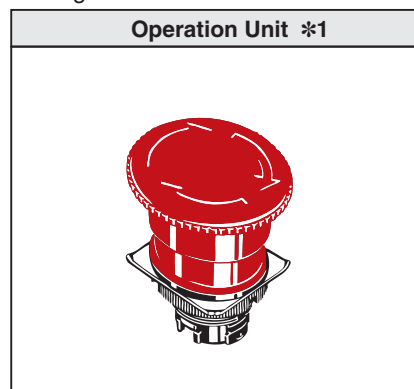

Lighted (without Voltage Reduction Unit)

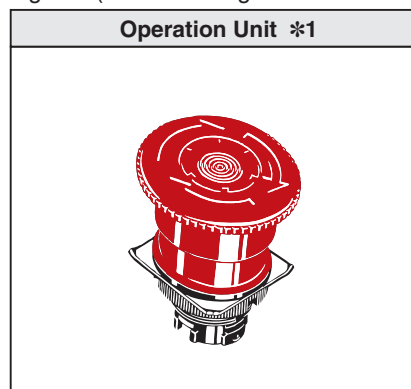



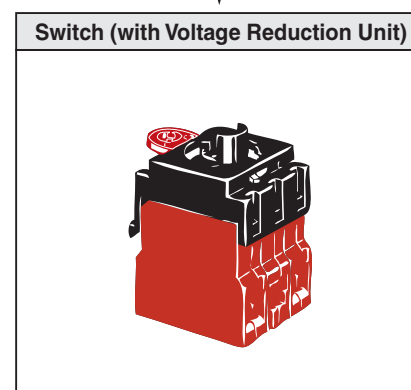
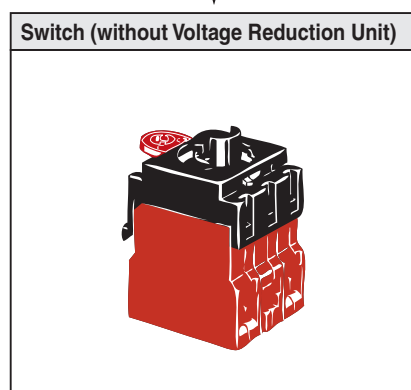
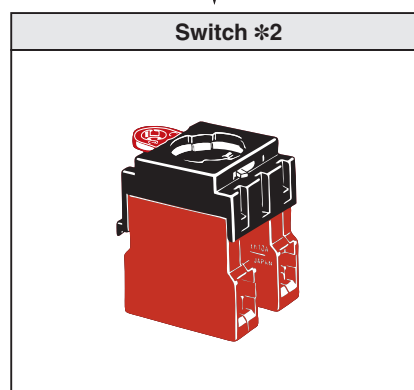
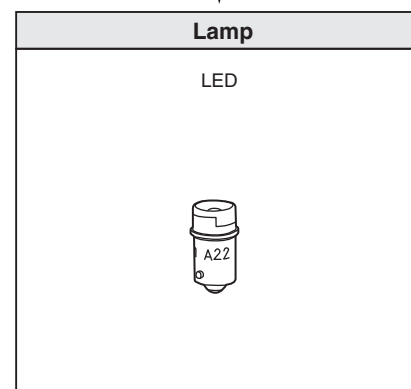
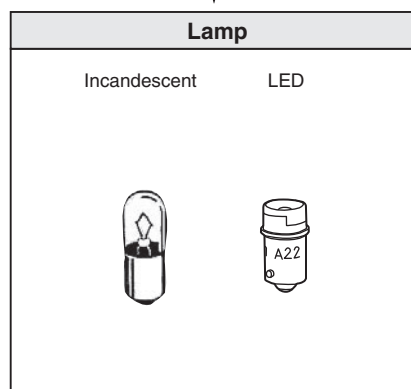
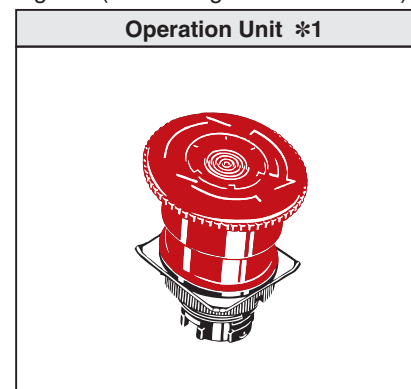

Lighted (with Voltage Reduction Unit)



\*1.The Operation Unit of A22E except models with EMO/EMS indication is red. (The engraved mark is not white.)

\*2. Up to three Switch Units can be mounted for multiple contacts.

**Operation Units**  
Non-lighted

Function	Sealing capability Size	IP65 oil-resistant models		
		Small (30 dia.)	Medium (40 dia.)	Large (60 dia.)
Push-pull		---	A22E-MP 	---
	Push-lock, turn-reset	A22E-S 	A22E-M 	A22E-L 

**Lighted**

Function	Sealing capability Size	IP65
		Medium (40 dia.)
Push-lock, turn-reset		A22EL-M 

**Note:** The Operation Unit of A22E except models with EMO/EMS indication is red. (The engraved mark is not white.)

**Lamp  
LED**

Appearance	LED light		Rated voltage	Model
	Red	Standard	6 VAC/VDC	<b>A22-6AR</b>
			12 VAC/VDC	<b>A22-12AR</b>
			24 VAC/VDC	<b>A22-24AR</b>



**Note:** For voltage-reduction lighting, use the A22-24AR.

**Incandescent**



Appearance	Rated voltage	Model
	6 VDC	<b>A22-5</b>
	14 VAC	<b>A22-12</b>
	28 VAC	<b>A22-24</b>
	130 VAC	<b>A22-H1</b>

**Switch (Standard Load)**

**Without Voltage Reduction Unit**

















Classification Appearance		Non-lighted	Lighted
			
Switch Action		Momentary	Momentary
		Model	Model
Contacts	1NC	<b>A22-01M</b>	<b>A22L-01M</b>
	1NO + 1NC	<b>A22-11M</b>	<b>A22L-11M</b>
	2NC (1NC + 1NC)	<b>A22-02M</b>	<b>A22L-02M</b>





**With Voltage Reduction Unit**

Classification Appearance		Lighted (110 VAC)	Lighted (220 VAC)
			
Switch Action		Momentary	Momentary
		Model	Model
Contacts	1NC	<b>A22L-01M-T1</b>	<b>A22L-01M-T2</b>
	1NO + 1NC	<b>A22L-11M-T1</b>	<b>A22L-11M-T2</b>
	2NC (1NC + 1NC)	<b>A22L-02M-T1</b>	<b>A22L-02M-T2</b>

**Note:** When using with a Voltage Reduction Unit, use the A22-24AR.

## Accessories (Order Separately)

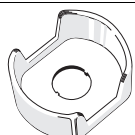
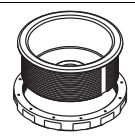
Item	Appearance	Classification		Model	Remarks
Switch Blocks		1NO	Standard load	<b>A22-10</b>	Provided as standard. Order Switch Blocks only when adding or replacing them.
			Microload	<b>A22-10S</b>	
		1NC	Standard load	<b>A22-01</b>	
			Microload	<b>A22-01S</b>	
		2NO (1NO + 1NO), one-piece	Standard load	<b>A22-20</b>	Order Switch Blocks only when adding or replacing them.
			Microload	<b>A22-20S</b>	
2NC (1NC + 1NC), one-piece		Standard load	<b>A22-02</b>		
		Microload	<b>A22-02S</b>		
Lamp Sockets		Direct lighting		<b>A22-TN</b>	Used when changing the lighting method.
		Voltage-reduction lighting	100 VAC	<b>A22-T1</b>	
			200 VAC	<b>A22-T2</b>	
Mounting Latches		---		<b>A22-3200</b>	Provided as standard. Order Mounting Latches only when mounting Switch Blocks or Lamp Sockets that are purchased individually.
Legend Plates for Emergency Stop		60-dia. black letters on yellow back-ground		<b>A22Z-3466-1</b>	"EMERGENCY STOP" is indicated on the plate. *2
		90-dia. black letters on yellow back-ground		<b>A22Z-3476-1</b>	
		60-dia. black letters on yellow back-ground		<b>A22Z-3466-2</b>	"EMERGENCY OFF" is indicated on the plate.
Hole Plug		Round		<b>A22Z-3530</b>	Can be plugged into pre-cut panel holes for future expansion. The color is black.
Connectors		Applicable cable diameter	7 to 9 dia.	<b>A22Z-3500-1</b>	Plastic connector used to extend a cable from the Switch Box.
			9 to 11 dia.	<b>A22Z-3500-2</b>	
25-dia. Ring		---		<b>A22Z-R25</b>	Can be fit into a 25-dia. hole in the panel. Since this is not attached to the main body, order separately. (Refer to page 15.)
30-dia. Resin Attachment		---		<b>A22Z-A30</b>	Can be fit into a 30-dia. hole in the panel. (Refer to page 15.)
Lock Plate		---		<b>A22Z-3380</b>	Use to fix the lever on the Switch.
Control Boxes (Enclosures)		One hole, yellow box (for emergency stop)		<b>A22Z-B101Y</b>	Material: Polycarbonate resin *2
Operation Keys		---		<b>A22K-K</b>	Two keys are provided.
Lock Ring		Rounded shape		<b>A22Z-3360</b>	The body is equipped with a Lock Fitting. This Lock Fitting is used when a more secure lock feature is required.
Lamp Extractor		---		<b>A22Z-3901</b>	Rubber tool used to replace Lamps easily
Tightening Tool		---		<b>A22Z-3905</b>	Tool used to tighten rings from the back of the panel and to attach caps to lighted models.
E-stop Shroud for EMO, Yellow		---		<b>A22Z-EG1</b>	Provides SEMI-S2/SEMATECH Application Guide for SEMI-S2 compatibility. The SEMI-S2-compatible Shroud and legend plate for EMERGENCY OFF come as a set. Use with an A22E Emergency Stop Switch. (for emergency shutoff) *1 *2

Item	Appearance	Classification	Model	Remarks
E-stop Shroud for EMO, Yellow		Legend plate for EMERGENCY OFF is not included.	A22Z-EG10	Provides SEMI-S2/SEMATECH APPLICATION GUIDE FOR SEMI S2 compatibility. Use with an A22E with EMO indication. (for emergency off) *2
E-stop Shroud for EMS, White		---	A22Z-EG1-W	Provides SEMI-S2/SEMATECH Application Guide for SEMI-S2 compatibility. The SEMI-S2-compatible Shroud and legend plate for EMERGENCY STOP come as a set. Use with an A22E Emergency Stop Switch. (for emergency stop) *1*2
E-stop Shroud for EMS, White		Legend plate for EMERGENCY STOP is not included.	A22Z-EG10-W	Provides SEMI-S2/SEMATECH APPLICATION GUIDE FOR SEMI S2 compatibility. Use with an A22E with EMS indication. (for emergency stop) *2
E-stop Shroud, Yellow		Spacer Unit is not included.	A22Z-EG2	SEMI-S2/SEMATECH Application Guide for SEMI S2-compatible Shroud. (for emergency shutoff) *1*2 Use together with an A22E Emergency Stop Switch.
		One Spacer Unit is included.	A22Z-EG21	
		Two Spacer Units are included.	A22Z-EG22	
E-stop Shroud for EMO, Yellow		---	A22Z-EG3	Provides SEMI-S2/SEMATECH Application Guide for SEMI-S2 compatibility. The SEMI-S2-compatible Shroud and legend plate for EMERGENCY OFF come as a set. Use with an A22E Emergency Stop Switch. (for emergency shutoff) *1 *2

\*1. These Shrouds are for use with the equipment only that conforms to SEMI standards. Do not use them for any other applications (e.g. emergency stop switches for machines or devices such as Machine tools, Printing presses, Industrial machinery, etc).

\*2. The A22-B101Y cannot be used in combination with the A22Z-3476-1 and the A22Z-EG□.

**Note:** 1. Accessories for A22Z-EG1: one "EMERGENCY OFF" label, two rubber washers, and one lock ring  
2. Accessories for A22Z-EG10: one rubber washer and one lock ring (without label)

## Specifications

### Certified Standard Ratings

- UL, cUL (File No.E41515)  
6A at 220 VAC, 10 A at 110 VAC
- TÜV (EN60947-5-1) (Low Voltage Directive)  
3 A at 220 VAC
- CCC (GB14048.5)  
3 A at 240 VAC, 1.5 A at 24 VDC

### Certified Standards

Certification body	Standards	File No.
UL *1	UL508, C22.2 No.14	E41515
TÜV SÜD	EN60947-5-1, EN60947-5-5 (certified direct opening)	Consult your OMRON representative for details.
CQC (CCC)	GB14048.5	2003010303070635
KOSHA *2	EN60947-5-1	Consult your OMRON representative for details.

**Note:** Only models with NC contacts have a direct opening mechanism.

\*1. UL-certification for CSA C22.2 No. 14 has been obtained. Certification has been obtained for the Switch Unit and the Lamp Socket.

\*2. Some models have been certified.

## Ratings

### Contacts (Standard Load)

Rated carry current (A)	Rated voltage (V)	Rated current (A)			
		AC15 (inductive load)	AC12 (resistive load)	DC13 (inductive load)	DC12 (resistive load)
10	24 VAC	10	10	---	---
	110 VAC	5	10		
	220 VAC	3	6		
	380 VAC	2	3		
	440 VAC	1	2		
	24 VDC	---	---	1.5	10
	110 VDC			0.5	2
	220 VDC			0.2	0.6
	380 VDC			0.1	0.2

**Note:** 1. Rated current values are determined according to the testing conditions. The above ratings were obtained by conducting tests under the following conditions.

- (1) Ambient temperature: 20°±2°C
- (2) Ambient humidity: 65±5%
- (3) Operating frequency: 20 operations/minute

2. Minimum applicable load: 10 mA at 5 VDC

### LED Indicators without Voltage Reduction Unit

Rated voltage	Rated current	Operating voltage
6 VAC/VDC	8 mA	6 VAC/VDC±5%
12 VAC/VDC		12 VAC/VDC±5%
24 VAC/VDC		24 VAC/VDC±5%



## Characteristics

Item	Type	Emergency Stop Switches	
		Non-lighted model: A22E	Lighted model: A22EL
Allowable operating frequency	Mechanical	30 operations/minute *3	
	Electrical	30 operations/minute *3	
Insulation resistance		100 MΩ min. (at 500 VDC)	
Dielectric strength	Between terminals of same polarity	2,500 VAC, 50/60 Hz for 1 min	
	Between each terminal and ground	2,500 VAC, 50/60 Hz for 1 min	
Vibration resistance *2		10 to 55 Hz, 1.5-mm double amplitude (within 1 ms)	
Shock resistance	Destruction	1,000 m/s <sup>2</sup>	
	Malfunction *2	250 m/s <sup>2</sup> max.	
Durability	Mechanical	300,000 operations min. *3	
	Electrical	300,000 operations min. *3	
Ambient operating temperature *1		-20 to 70°C	-20 to 55°C
Ambient operating humidity		35% to 85%	
Ambient storage temperature		-40 to 70°C	
Degree of protection		IP65 (oil-resistant) *4	IP65 *4
Electric shock protection class		Class II	
PTI (tracking characteristic)		175	
Degree of contamination		3 (EN60947-5-1)	

\*1. With no icing or condensation.

\*2. Malfunction within 1 ms.

\*3. Setting and resetting once is counted as one operation.

\*4. The degree of protection from the front of the panel.

## Structure and Nomenclature

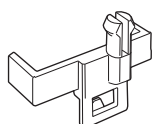
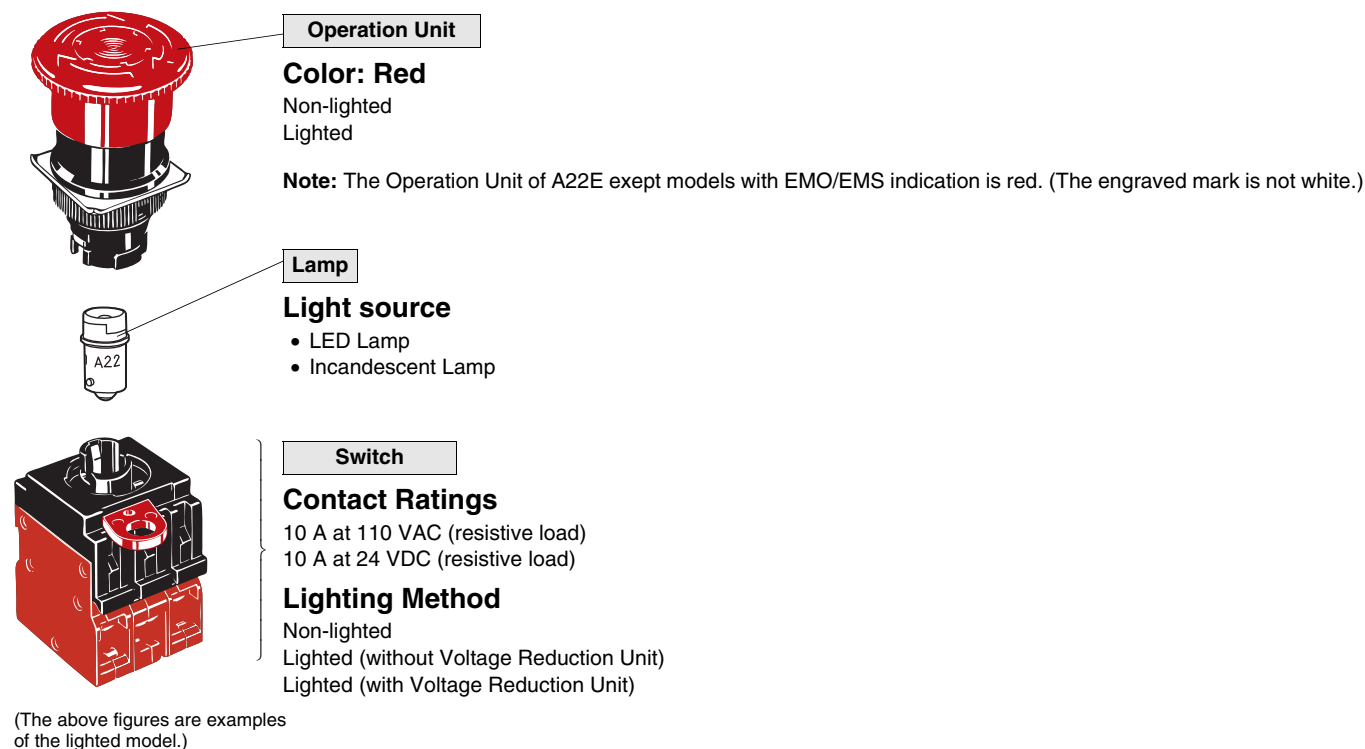

### Lock Plate (Attached with the Operation Unit)

(Refer to the Mounting the Lock Plate on page 17 for use.)

# Dimensions

## Non-lighted Models

### A22E-MP

Medium Push-pull (40-dia.)

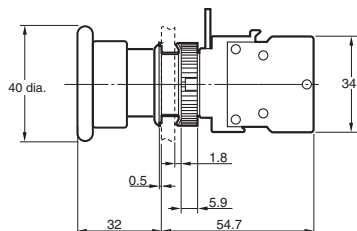
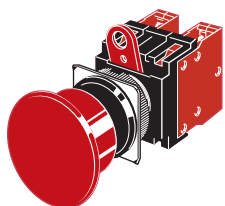

### A22E-S

Small Push-lock, Turn-reset (30-dia.)

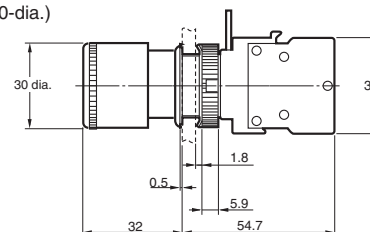

### A22E-M

Medium Push-lock, Turn-reset (40-dia.)

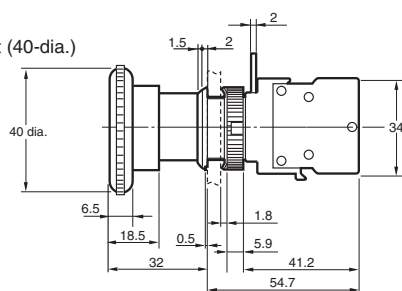
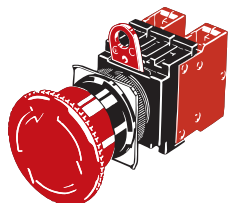

### A22E-L

Large Push-lock, Turn-reset (60-dia.)

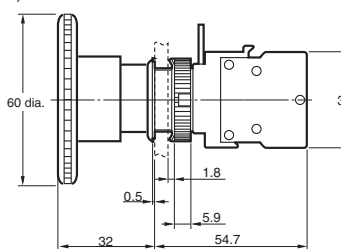
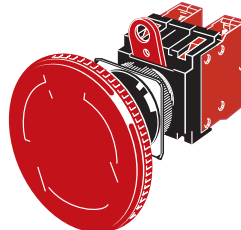

Note: The dimensions are the same as for EMO/EMS indication models.

## Lighted Models

### A22EL-M

Medium Push-lock, Turn-reset (40-dia.)

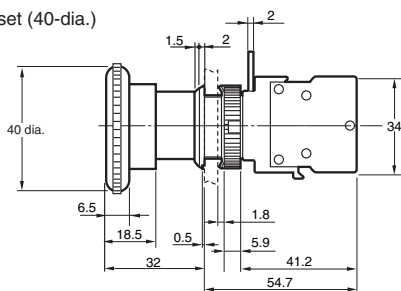
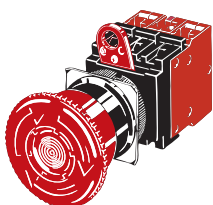

### Switch dimensions when mounted to a DPST-NO (or 2NC (1NC + 1NC)) one-piece Switch Block

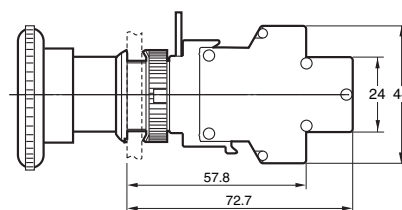

Note: The operation unit is an example for the A22E-M.

Note: The Operation Unit of A22E except models with EMO/EMS indication is red. (The engraved mark is not white.)

## Dimensions for Accessories

**Hole Plug**  
Round A22Z-3530

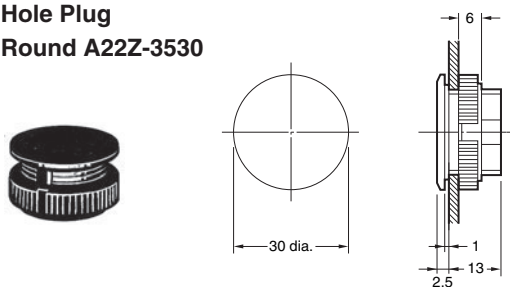

**30-dia. Resin Attachment**  
A22Z-A30

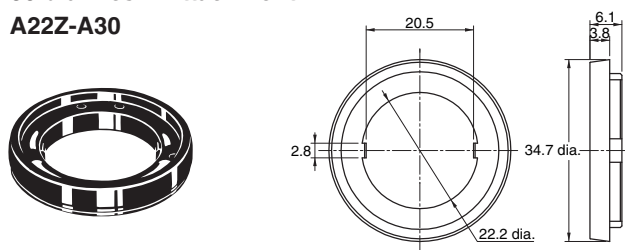

**Lamp Extractor**  
A22Z-3901



Material: Chloroprene rubber

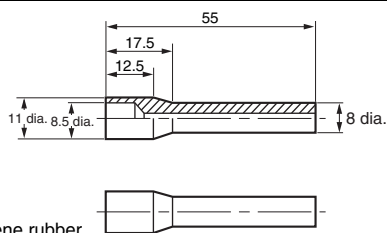

**Tightening Tool**  
A22Z-3905

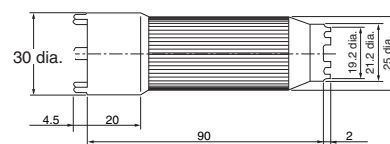
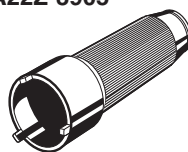

### Legend Plates for Emergency Stop

A22Z-3476-1 (90 dia.)

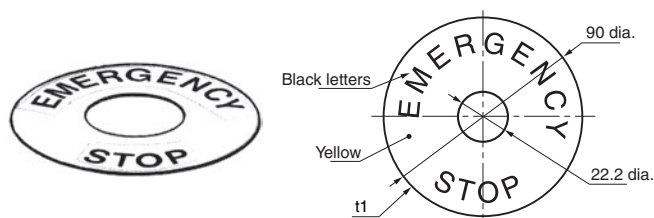

A22Z-3466-1 (60 dia.)

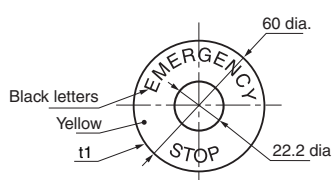

A22Z-3466-2 (60 dia.)

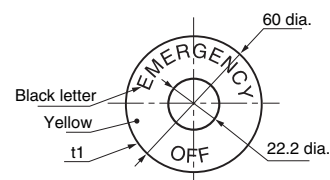

**Lock Ring**  
A22Z-3360



Material: Nickel plated on iron

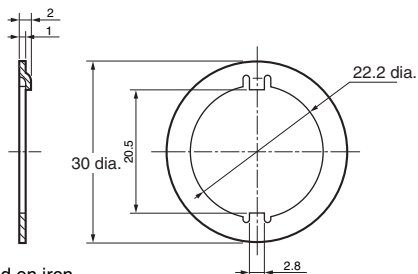

**25-dia. Ring**  
A22Z-R25



Material: NBR (black)

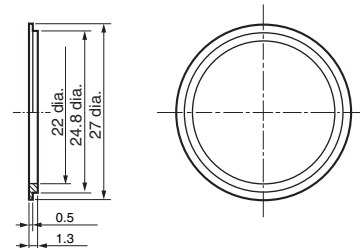

### Lamp

LED A22-6□, 12□, 24□

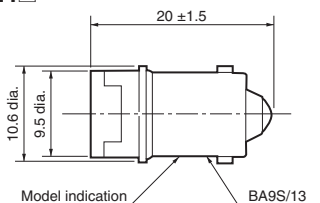

Incandescent Lamp A22-5, 12, 24, H1

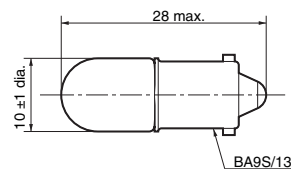

### Control Box

A22Z-B101Y (1 hole)

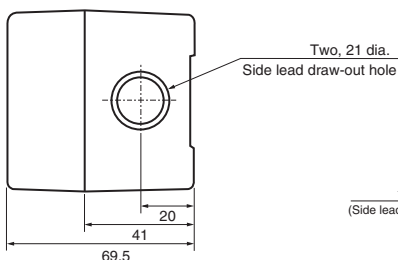
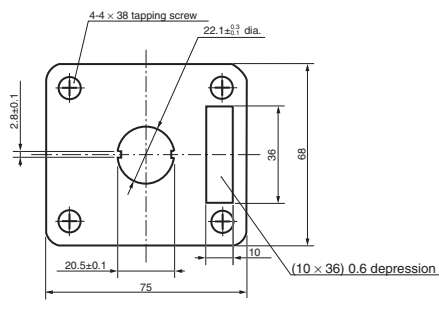

Cable Draw-out Hole (Top View)

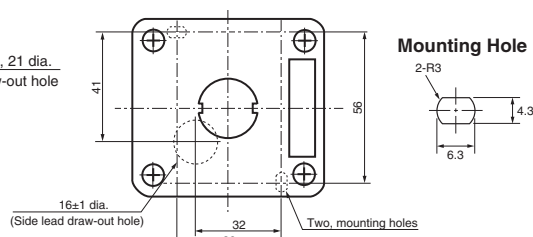

**E-stop Shroud**

**A22Z-EG1, A22Z-EG1-W, A22Z-EG10, A22Z-EG10-W**

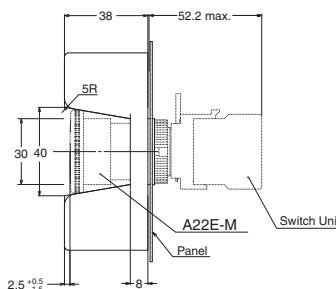
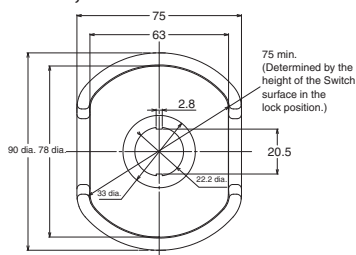

Panel Cutout Dimensions

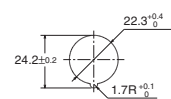

Allowable panel thickness: 1 to 3 mm

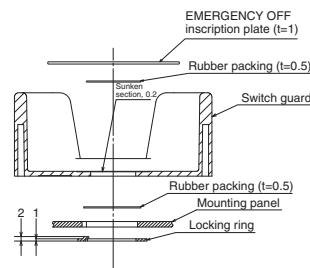

- Note:**
1. The dimensions of the Shroud conform to the specifications of the SEMATECH Application Guide for SEMI S2-93.
  2. The Shroud is not provided with the Switch.



"EMERGENCY STOP" is indicated on A22Z-EG1-W. Legend plate is not provided with A22Z-EG10 and A22Z-EG10-W.

**E-stop Shroud**

**A22Z-EG2, A22Z-EG21, A22Z-EG22**

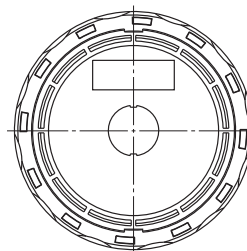
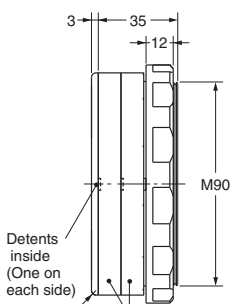
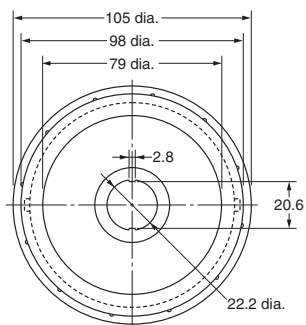
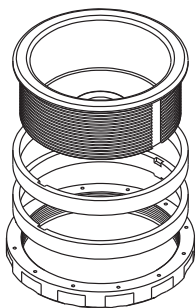

The number of spacers depends on the model  
 A22Z-EG2 : No Spacer  
 A22Z-EG21 : 1 Spacer  
 A22Z-EG22 : 2 Spacers

**Mounting with Spacers**

With 1 Spacer      With 2 Spacers

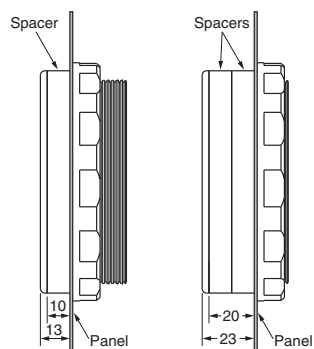

**Mounting a 1-pole Switch Unit \***

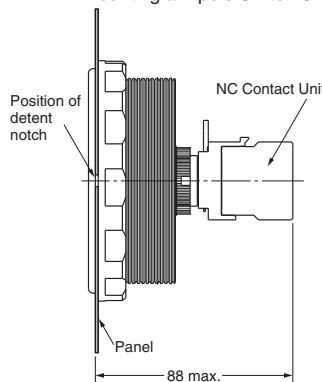

**Mounting a 2-pole Switch Unit \***

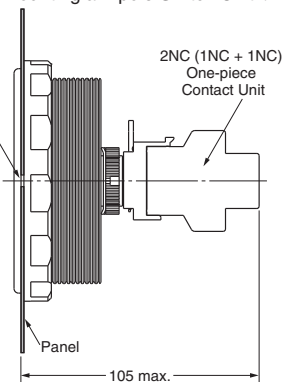

- Note:**
1. The dimensions of the Shroud conform to the specifications of the SEMATECH Application Guide for SEMI S2-93.

2. The Shroud is not provided with the Switch.
3. Tighten to a torque of 1.96 to 2.94 N·m.
4. The allowable panel thicknesses are as follows:  
 Without Spacers: t=1.3 to 22.5 mm  
 With 1 Spacer: t=1.3 to 12.5 mm  
 With 2 Spacers: t=1.3 to 2.5 mm

\* These are the dimension from the front of the panel when the Switch Unit is attached.

**E-stop Shroud  
A22Z-EG3**

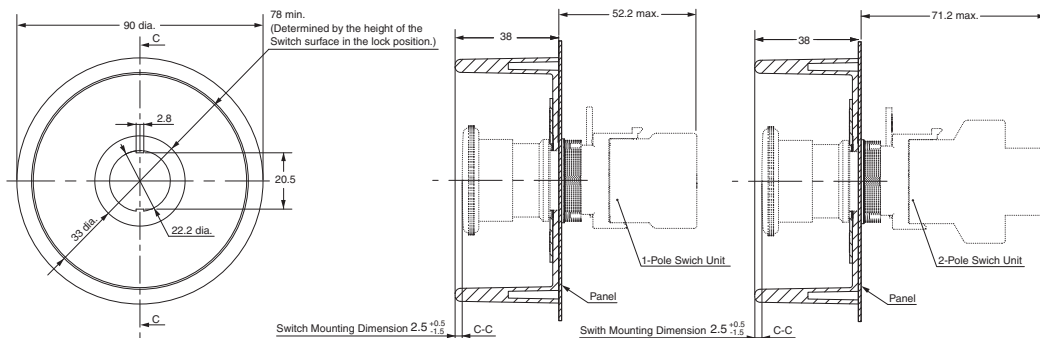
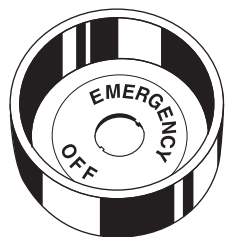

- Note: 1.** The dimensions of the Shroud conform to the specifications of the SEMATECH Application Guide for SEMI S2-93.
- 2.** The Shroud is not provided with the Switch.

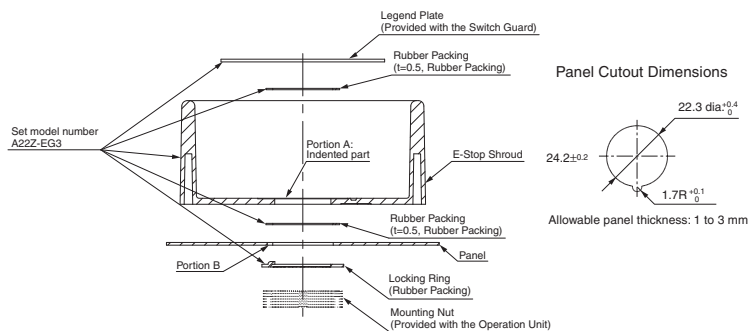
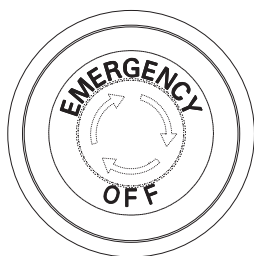

## Panel Cutouts

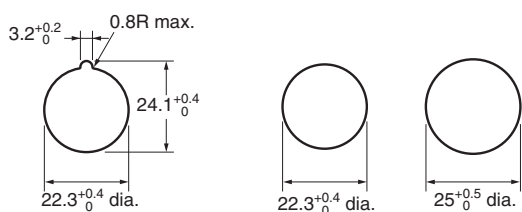

**With Lock Fitting**      **Without Lock Fitting**

**A Lock Ring is provided as a standard feature.**

- When painting or coating the panel, make sure that the specified panel dimensions apply to the panel after painting or coating.
- Use an A22Z-R25 Ring when mounting to a panel with a 25-mm diameter hole.

## Terminal Arrangement (Bottom View)

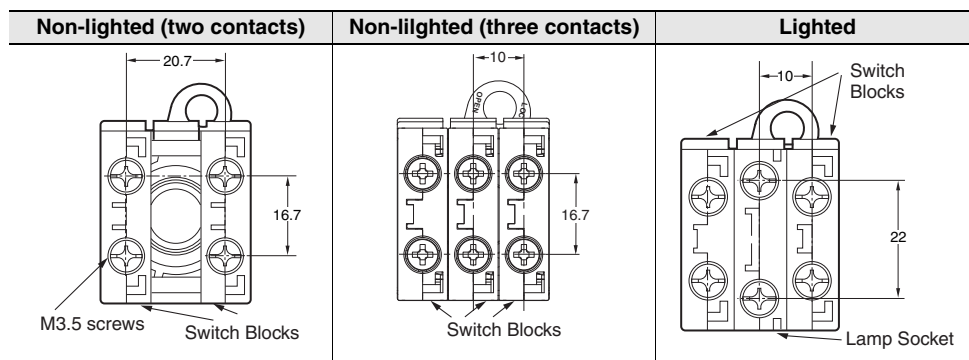

## Terminal Connection

Type	Terminal connection (BOTTOM VIEW)			
	1NO + 1NC	2NC (1NC + 1NC)	1NO + 2NC (1NC + 1NC)	3NC (1NC + 1NC + 1NC)
Non-lighted				
Lighted without Voltage Reduction Unit				
Lighted with Voltage Reduction Unit				

**Note:** The above terminal connection diagrams are examples for 1NO + 1NC and 2NC (1NC + 1NC).



## Assembling the Cap

Emergency Stop Switch
<ul style="list-style-type: none"> <li>Insert the protrusion of the Tightening Wrench (A22Z-3905) into the Cap slot and then turn to remove the Cap.</li> </ul> <p>Cap slot Protrusion</p>

## Installing/Replacing the Lamp



(1) Installing/Replacing from the Panel Surface	(2) Installing/Replacing on the Switch
<ul style="list-style-type: none"> <li>Insert the Lamp Extractor (A22Z-3901) into the lamp, then rotate the Extractor while pressing it.</li> </ul>	<ul style="list-style-type: none"> <li>Grip the indicator with your fingers, then rotate the indicator while pressing it against the Switch.</li> </ul>

## Control Box (Enclosure)

(1) Mounting the Switch	(2) Creating a Cable Port Hole	(3) Securing the Connector Cable						
<p>The Standard-size Legend Plate Frame can be mounted. Mount the Frame as shown in the following diagram. Mount the Switch in the same way as for an ordinary panel.</p> <p>Snap-in Legend Plate</p>	<p>Place the tip of a screwdriver on the surface where the cable port hole is to be created with the cover attached and strike the screwdriver to punch a hole. Attempts to punch a hole on the other side of the case will damage the Box.</p>	<ol style="list-style-type: none"> <li>Insert the connector into the cable port hole in the Box and secure with the Mounting Ring inside the box.</li> <li>Pass the tightening cap through the cable, insert the cable into the connector, and tighten the tightening cap to secure the cable.</li> </ol> <p>Inside Box Outside</p> <table border="1"> <thead> <tr> <th>Cable diameter</th> <th>Connector</th> </tr> </thead> <tbody> <tr> <td>7 to 9 dia.</td> <td>A22Z-3500-1</td> </tr> <tr> <td>9 to 11 dia.</td> <td>A22Z-3500-2</td> </tr> </tbody> </table>	Cable diameter	Connector	7 to 9 dia.	A22Z-3500-1	9 to 11 dia.	A22Z-3500-2
Cable diameter	Connector							
7 to 9 dia.	A22Z-3500-1							
9 to 11 dia.	A22Z-3500-2							

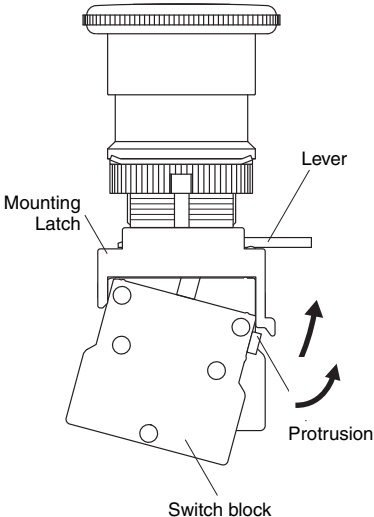
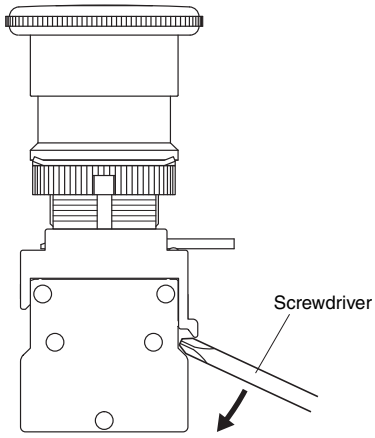

## Installing/Removing the Switch Blocks

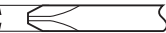
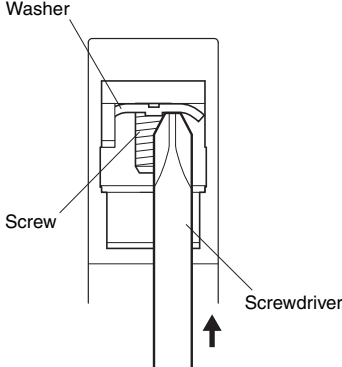
(1) Installing the Switch Blocks	(2) Removing the Switch Blocks	Wiring
<ul style="list-style-type: none"> <li>Hook the small protrusion on the Mounting Latch into the groove on the other side of the lever, then push up the Switch Block in the direction indicated by the arrow in the figure below.</li> </ul> 	<ul style="list-style-type: none"> <li>Insert a screwdriver between the Mounting Latch and the Switch Block, then push down the screwdriver in the direction indicated by the arrow in the following figure.</li> </ul>  <p style="text-align: center;">Use either of the following screwdrivers.</p> <ul style="list-style-type: none"> <li>⊖ Flat-head screwdriver 3 to 6 mm </li> <li>⊕ Phillips screwdriver 3 to 6 mm dia. </li> </ul>	<ul style="list-style-type: none"> <li>Loosen the terminal screw from the Switch Unit until it completely comes off the groove, insert a screwdriver as shown in the following figure, then push up the washer in the direction indicated by the arrow to temporarily secure it.</li> <li>Now, a round crimp terminal can be connected. After inserting the terminal, tighten the screws to complete wiring.</li> </ul> 

## Safety Precautions

Be sure to read the precautions for **All PushButton Switches** in the website at: <http://www.ia.omron.com/>.

### Indication and Meaning for Safe Use

<b>⚠ CAUTION</b>	<b>Indicates a potentially hazardous situation which, if not avoided, may result in minor or moderate injury or in property damage.</b>
<b>Precautions for Safe Use</b>	<b>Supplementary comments on what to do or avoid doing, to use the product safely.</b>

### ⚠ CAUTION

Do not apply a voltage exceeding the rated voltage across the incandescent lamp terminals. The lamp may be destroyed and the operation unit may fly out. 

If the Operation Unit is separated from the Socket Unit, the equipment will not stop, creating a hazardous condition. Secure the lever on the Socket Unit by using the A22Z-3380 Lock Plate so that the Operation Unit cannot be easily separated from the Socket Unit. (Refer to "Mounting the Lock Plate" at the right.) 

### Precautions for Correct Use

#### Mounting

- Always make sure that the power is turned OFF before wiring the Switch. Also, do not touch the terminals or other current-carrying parts while power is being supplied. Electric shock may occur.
- Do not tighten the mounting ring more than necessary using tools such as pointed-nose pliers. Doing so will damage the mounting ring. The tightening torque is 0.98 to 1.96 N·m.
- Recommended panel thickness: 1 to 5 mm.
- When mounting the caps after changing the LED or the caps, tighten the caps at a tightening torque of 0.49 to 0.78 N·m.

#### Mounting the Lock Plate

- Confirm that the lever on the Mounting Latch is on the side where the Operation Unit is secured and then insert the protrusion on the Lock Plate into the hole in the lever on the Mounting Latch.
- Press the hole on the Lock Plate onto the protrusion on the Mounting Latch until it clicks into place.

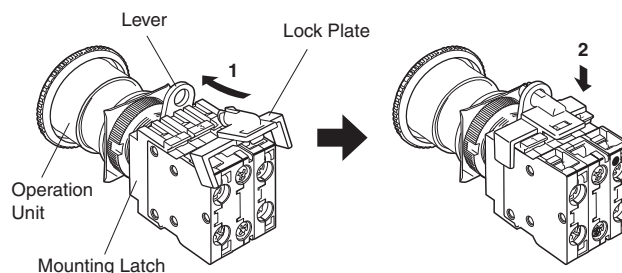

## Wiring

- Terminal screws must be Phillips or slotted M3.5 screws with a square washer.
- The tightening torque is 1.08 to 1.27 N·m.
- Single wires, stranded wires, and crimp terminals can be connected to the Switch.
- Applicable Wiring Materials:  
Twisted strands: 2 mm<sup>2</sup> max.  
Solid wire: 1.6 mm dia. max.

### Naked Crimp Terminals

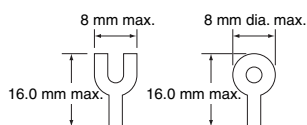

### Crimp Terminals with Insulating Sheaths

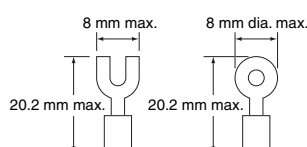

- After wiring the Switch, maintain an appropriate clearance and creepage distance.

## Operating Environment

- The IP65 model is designed with a protective structure so that it will not sustain damage if it is subjected to water from any direction to the front of the panel.
- The Switch is intended for indoor use only. Using the Switch outdoor may cause it to fail.

## LEDs

- The LED current-limiting resistor is built-in, so internal resistance is not required.
- If commercially available LEDs are used, select the ones that meet the following conditions:  
Base: BA9S/13  
Overall length: 26 mm max.  
Power consumption: 2.6 W max.  
When DC-specific LEDs are used, wire the Switch so that the X1 terminal is positive.
- Mis-lighting of the LED  
The LED lights with approx. 0.1 mA or less of micro-current. Take a countermeasure like adding a resistor to prevent mis-lighting in parallel to the LED.  
The micro-current varies with the machine (leak current or stray capacity between cables, etc.). Select resistance value and allowable power consumption that meet the actual current.

### (Circuit example)

In case of using 24 VAC/VDC, Direct lighting

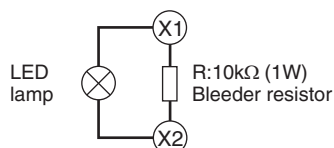

## Using the Microload

Contact failure may occur if a Switch designed for a standard load is used to switch a microload. Use Switches within the application ranges shown in the following graph. Even within the application range, insert a contact protection circuit, if necessary, to prevent the reduction of life expectancy due to extreme wear on the contacts caused by loads where inrush current occurs when the contact is opened and closed.

The minimum applicable load is the N-level reference value. This value indicates the malfunction reference level for the reliability level of 60% ( $\lambda_{60}$ ) (conforming to JIS C5003).

The equation,  $\lambda_{60} = 0.5 \times 10^{-6}/\text{time}$  indicates that the estimated malfunction rate is less than 1/2,000,000 with a reliability level of 60%.

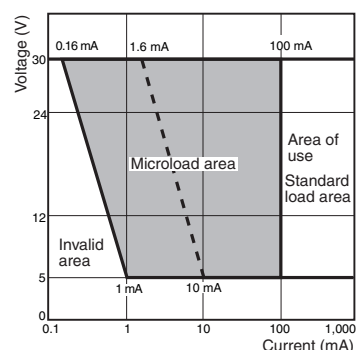

## Others

- If the panel is to be coated, make sure that the panel meets the specified dimensions after coating.
- Due to the structure of the Switch, severe shock or vibration may cause malfunctions or damage to the Switch.  
Also, most Switches are made from resin and will be damaged if they come into contact with sharp objects. Particularly scratches on the Operation Unit may create visual and operational obtrusions.  
Handle the Switches with care, and do not throw or drop them.

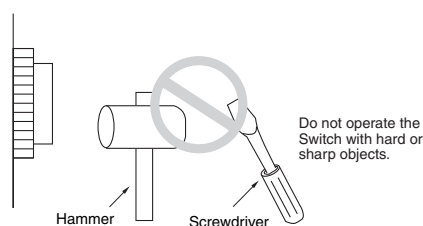
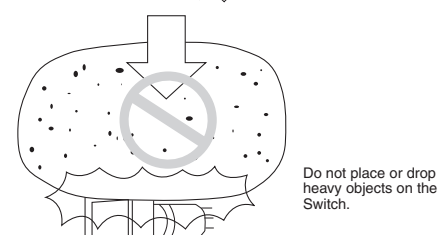
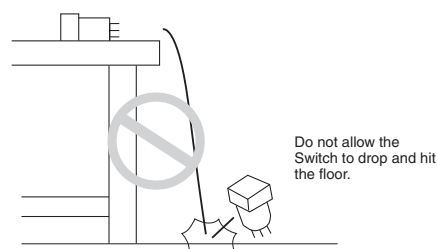

## Terms and Conditions Agreement

### Read and understand this catalog.

Please read and understand this catalog before purchasing the products. Please consult your OMRON representative if you have any questions or comments.

### Warranties.

(a) Exclusive Warranty. Omron's exclusive warranty is that the Products will be free from defects in materials and workmanship for a period of twelve months from the date of sale by Omron (or such other period expressed in writing by Omron). Omron disclaims all other warranties, express or implied.

(b) Limitations. OMRON MAKES NO WARRANTY OR REPRESENTATION, EXPRESS OR IMPLIED, ABOUT NON-INFRINGEMENT, MERCHANTABILITY OR FITNESS FOR A PARTICULAR PURPOSE OF THE PRODUCTS. BUYER ACKNOWLEDGES THAT IT ALONE HAS DETERMINED THAT THE PRODUCTS WILL SUITABLY MEET THE REQUIREMENTS OF THEIR INTENDED USE.

Omron further disclaims all warranties and responsibility of any type for claims or expenses based on infringement by the Products or otherwise of any intellectual property right. (c) Buyer Remedy. Omron's sole obligation hereunder shall be, at Omron's election, to (i) replace (in the form originally shipped with Buyer responsible for labor charges for removal or replacement thereof) the non-complying Product, (ii) repair the non-complying Product, or (iii) repay or credit Buyer an amount equal to the purchase price of the non-complying Product; provided that in no event shall Omron be responsible for warranty, repair, indemnity or any other claims or expenses regarding the Products unless Omron's analysis confirms that the Products were properly handled, stored, installed and maintained and not subject to contamination, abuse, misuse or inappropriate modification. Return of any Products by Buyer must be approved in writing by Omron before shipment. Omron Companies shall not be liable for the suitability or unsuitability or the results from the use of Products in combination with any electrical or electronic components, circuits, system assemblies or any other materials or substances or environments. Any advice, recommendations or information given orally or in writing, are not to be construed as an amendment or addition to the above warranty.

See <http://www.omron.com/global/> or contact your Omron representative for published information.

### Limitation on Liability; Etc.

OMRON COMPANIES SHALL NOT BE LIABLE FOR SPECIAL, INDIRECT, INCIDENTAL, OR CONSEQUENTIAL DAMAGES, LOSS OF PROFITS OR PRODUCTION OR COMMERCIAL LOSS IN ANY WAY CONNECTED WITH THE PRODUCTS, WHETHER SUCH CLAIM IS BASED IN CONTRACT, WARRANTY, NEGLIGENCE OR STRICT LIABILITY.

Further, in no event shall liability of Omron Companies exceed the individual price of the Product on which liability is asserted.

### Suitability of Use.

Omron Companies shall not be responsible for conformity with any standards, codes or regulations which apply to the combination of the Product in the Buyer's application or use of the Product. At Buyer's request, Omron will provide applicable third party certification documents identifying ratings and limitations of use which apply to the Product. This information by itself is not sufficient for a complete determination of the suitability of the Product in combination with the end product, machine, system, or other application or use. Buyer shall be solely responsible for determining appropriateness of the particular Product with respect to Buyer's application, product or system. Buyer shall take application responsibility in all cases.

NEVER USE THE PRODUCT FOR AN APPLICATION INVOLVING SERIOUS RISK TO LIFE OR PROPERTY OR IN LARGE QUANTITIES WITHOUT ENSURING THAT THE SYSTEM AS A WHOLE HAS BEEN DESIGNED TO ADDRESS THE RISKS, AND THAT THE OMRON PRODUCT(S) IS PROPERLY RATED AND INSTALLED FOR THE INTENDED USE WITHIN THE OVERALL EQUIPMENT OR SYSTEM.

### Programmable Products.

Omron Companies shall not be responsible for the user's programming of a programmable Product, or any consequence thereof.

### Performance Data.

Data presented in Omron Company websites, catalogs and other materials is provided as a guide for the user in determining suitability and does not constitute a warranty. It may represent the result of Omron's test conditions, and the user must correlate it to actual application requirements. Actual performance is subject to the Omron's Warranty and Limitations of Liability.

### Change in Specifications.

Product specifications and accessories may be changed at any time based on improvements and other reasons. It is our practice to change part numbers when published ratings or features are changed, or when significant construction changes are made. However, some specifications of the Product may be changed without any notice. When in doubt, special part numbers may be assigned to fix or establish key specifications for your application. Please consult with your Omron's representative at any time to confirm actual specifications of purchased Product.

### Errors and Omissions.

Information presented by Omron Companies has been checked and is believed to be accurate; however, no responsibility is assumed for clerical, typographical or proofreading errors or omissions.

2013.9

In the interest of product improvement, specifications are subject to change without notice.

**OMRON Corporation**  
Industrial Automation Company

<http://www.ia.omron.com/>

(c)Copyright OMRON Corporation 2013 All Right Reserved.



## Стандарт Электрон Связь

Мы молодая и активно развивающаяся компания в области поставок электронных компонентов. Мы поставляем электронные компоненты отечественного и импортного производства напрямую от производителей и с крупнейших складов мира.

Благодаря сотрудничеству с мировыми поставщиками мы осуществляем комплексные и плановые поставки широчайшего спектра электронных компонентов.

Собственная эффективная логистика и склад в обеспечивает надежную поставку продукции в точно указанные сроки по всей России.

Мы осуществляем техническую поддержку нашим клиентам и предпродажную проверку качества продукции. На все поставляемые продукты мы предоставляем гарантию .

Осуществляем поставки продукции под контролем ВП МО РФ на предприятия военно-промышленного комплекса России , а также работаем в рамках 275 ФЗ с открытием отдельных счетов в уполномоченном банке. Система менеджмента качества компании соответствует требованиям ГОСТ ISO 9001.

Минимальные сроки поставки, гибкие цены, неограниченный ассортимент и индивидуальный подход к клиентам являются основой для выстраивания долгосрочного и эффективного сотрудничества с предприятиями радиоэлектронной промышленности, предприятиями ВПК и научно-исследовательскими институтами России.

С нами вы становитесь еще успешнее!

### Наши контакты:

**Телефон:** +7 812 627 14 35

**Электронная почта:** [sales@st-electron.ru](mailto:sales@st-electron.ru)

**Адрес:** 198099, Санкт-Петербург,  
Промышленная ул, дом № 19, литера Н,  
помещение 100-Н Офис 331