

LL01CR-AU85135L Data Sheet

For CREE Single-Color LEDs



Features:

- High efficiency
- Available in 1 beam Patterns
- Optimized for uniform effects
- Lens without Housing

Typical applications :

- Stage Lighting
- Street Lights
- Decorative Light
- Architectural Lighting
- Down Light

Table of Contents

General Information.....	2
General Specifications.....	2
Optical Specifications.....	3
Mechanical Specifications.....	4
Illumination charts.....	5
Package Specifications.....	6
Product Nomenclature.....	7

General Information

- **Compatible Led Type :**

The LL01CR-AU85135L single lens are optimized for Single-Color (CREE XP-E) Cree LEDs from Cree Opto. ⁽¹⁾

- **Beam Angle Type :**

An optimized profile integrate different front shape enable the generation of one lens model : oval beam (85*135deg) ⁽²⁾

- **The Way to Assembly :**

Please fix it when the two holes in the lens and the two screw holes in the MCPCB are at the same point in order to get the best optical effort.

*** Manually installation or if necessary thermal glue are recommended.**

- **Function :**

LL01CR-AU85135L provides exceptional color mixing result with the highest efficiency through careful engineering and precision manufacturing process.

General Specifications

- Lens Material Optical Grade PMMA PC
- Operating Temperature range -40°C ~ + 110°C (upper limit +120°C)
- Storage Temperature range -40°C ~ + 110°C (upper limit +120°C)

*Average transmittance in visible spectrum 400nm~700nm > 90%

Notes:

(1) Cree XP-E is a trademark of Cree,Inc, for technical information on LEDs, please refer to Cree,Inc, www.cree.com/xlamp.

(2) Typical beam divergence will be affected by different color of LEDs.

Optical Specifications [Typical beam Angle and intensity (cd/lm) of LL01 lens]

- CREE XP-E LED

Typical Cone Angle (degree) ⁽³⁾ with CREE XP-E			
Part Number	Red LEDs	Green LEDs	Blue LEDs
LL01CR-AU85135L	--	--	--

The typical cone angle measures where the luminous intensity is 50% of the peak value of intensity. This typical cone varies with LED color due to different chip size and chip position tolerance.

Typical on axis intensity (cd/w) ⁽⁴⁾ with CREE XP-E			
Part Number	Red LEDs	Green LEDs	Blue LEDs
LL01CR-AU85135L	--	--	--

Luminous intensity depends on the flux binning and tolerance of the LEDs. Please refer to the LEDs data sheet for more details on Flux binning and mechanical tolerance.

- CREE XP-E LED

Typical Cone Angle (degree) ⁽³⁾ with CREE XP-E			
Part Number	White LEDs	Warm white LEDs	
LL01CR-AU85135L	83*133	82*136	

The typical cone angle the full angle measured where the luminous intensity is 50% of the peak value of intensity. That typical cone varies with LED color due to different chip size and chip position tolerance.

Typical on axis intensity (cd/w) ⁽⁴⁾ with CREE XP-E			
Part Number	White LEDs	Warm white LEDs	
LL01CR-AU85135L	25	20	

Luminous intensity depends on the flux binning and tolerance of the LEDs. Please refer to the LEDs data sheet for more detail on Flux binning and mechanical tolerance

Notes:

(3) The typical divergence will be changed by different color, chip size and chip position tolerance. The typical total divergence is the full angle measured where the luminous intensity is half of the peak value.

(4) The efficiency value listed above is the total value of the whole lens model, the value depends on the total flux of the LED used. Luminous intensity depends on the LEDs flux and its tolerances, for more details of LED flux, please check Cree data sheet at www.cree.com.

Mechanical Specifications

• Usage and Maintenance :

1. If necessary, clean lenses with mild soap, water and soft cloth
2. Never use any commercial cleaning solvents on lenses, like alcohol
3. Please handle or install lenses with wearing gloves, skin oils may damage lens or its optical characteristic.

1. Lens + Leds+MCPCB assembly instruction

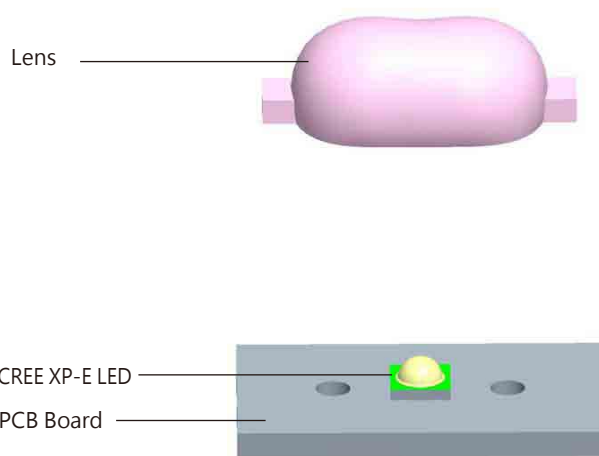

2. View assembly lens with MCPCB:

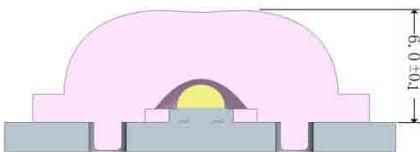

3. Lens dimensions and Top Views:

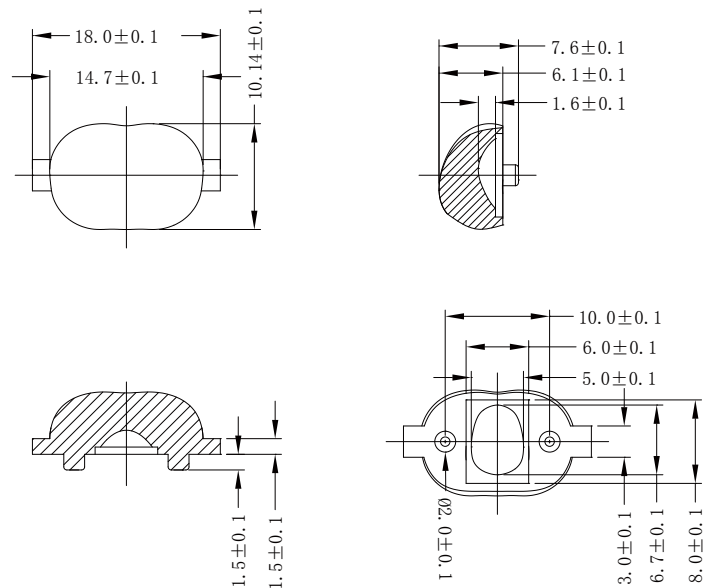

- Notes:
- (1) All dimensions are in mm.
 - (2) Drawing not to scale.
 - (3) Collimator material is PC.

ILLUMINATION CHARTS

*CREE single white LED: CREE XP-E

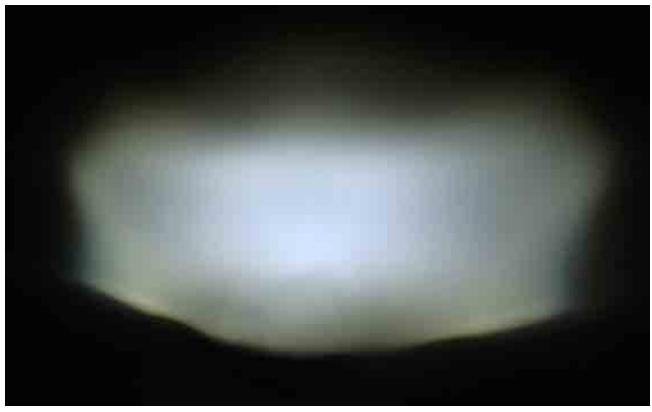
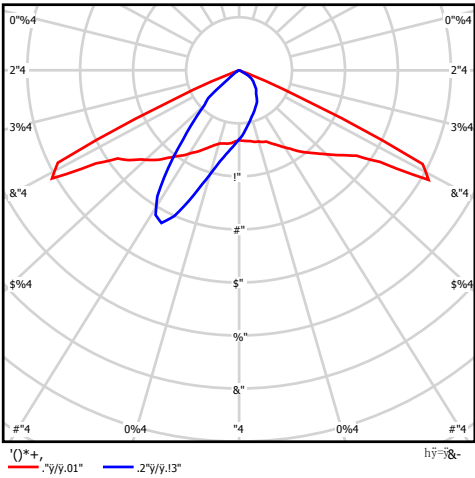
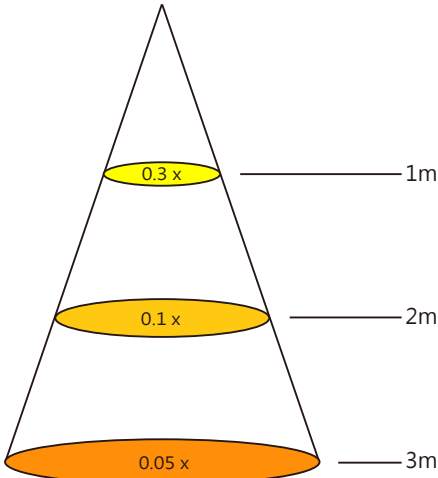
LL01CR-AU85135L	
1. Beam Pattern	
	
2. Light Distribution Curve	
	
3. Illuminance	
	

Notes: The Flux of CREE XP-E LED is 88 lm

Package

Item	Quantity	Total	Size (long*width* high)
Inner box	1000pcs/Plastic bag	1000pcs	34*30*3.5 cm
Outer box	2Plastic bag/box	2000pcs	35*31*21 cm
Outer box	2 inner box/outer box	4000pcs	64.7*36.5*24 cm

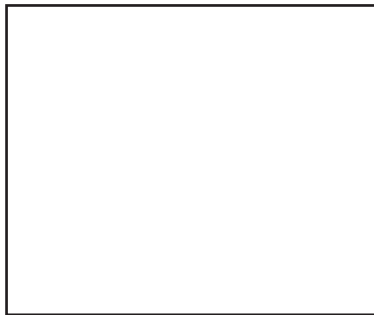

1000pcs/Plastic bag

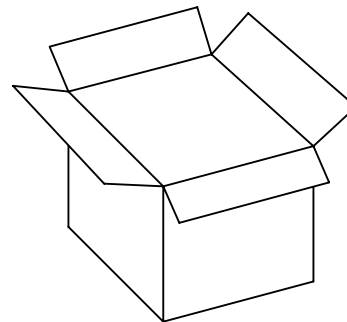
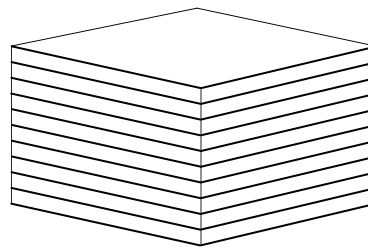

2000pcs/inner box

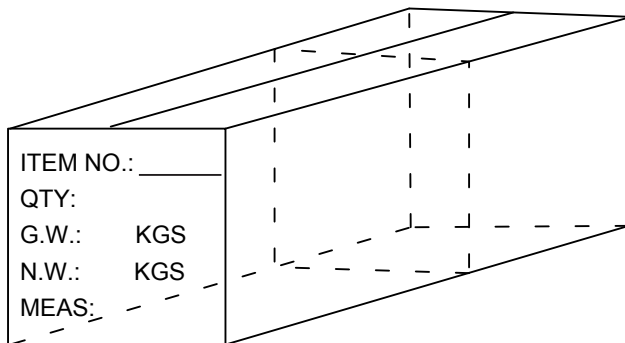

4000pcs/outer box

Product Nomenclature

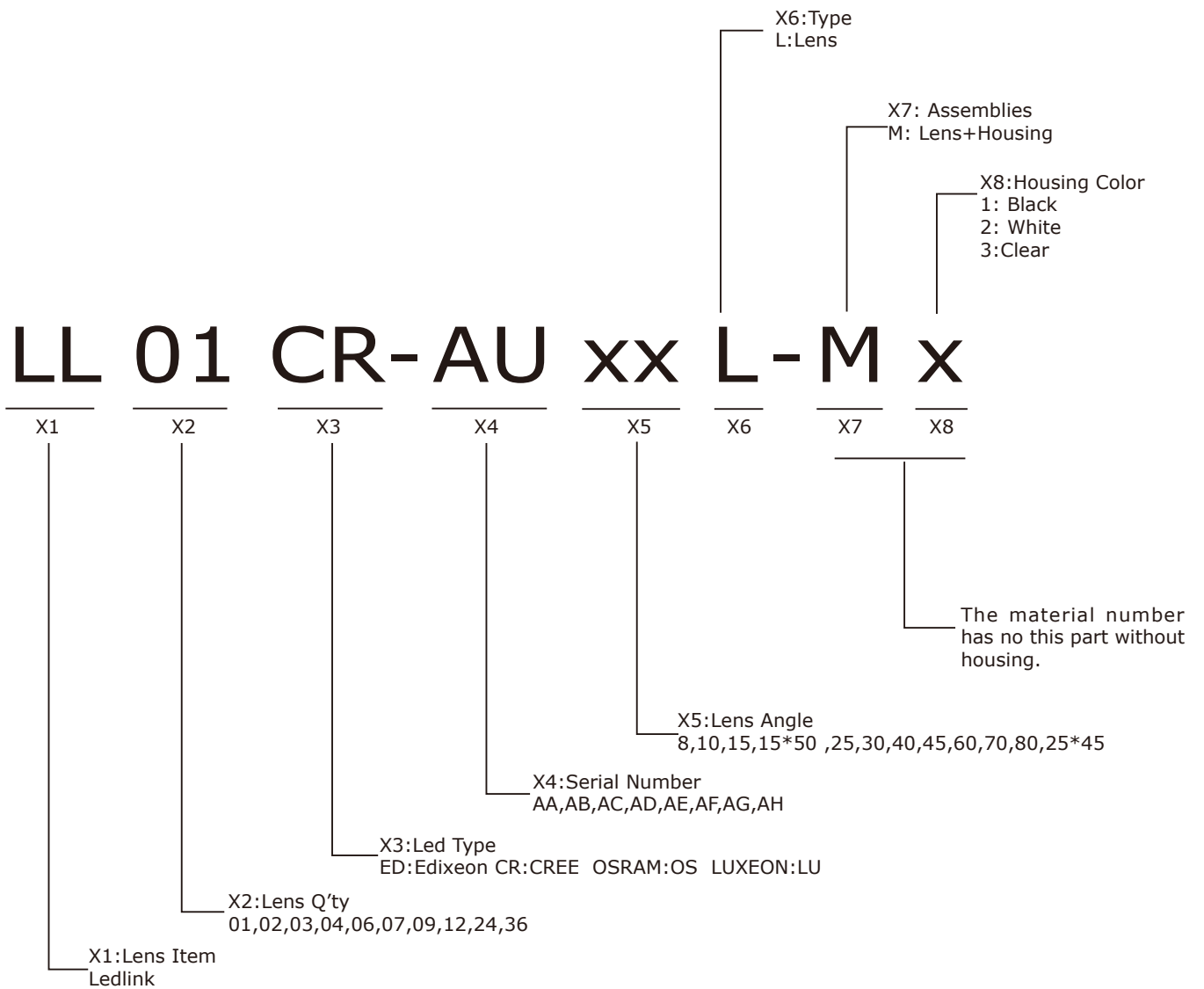



Стандарт Электрон Связь

Мы молодая и активно развивающаяся компания в области поставок электронных компонентов. Мы поставляем электронные компоненты отечественного и импортного производства напрямую от производителей и с крупнейших складов мира.

Благодаря сотрудничеству с мировыми поставщиками мы осуществляем комплексные и плановые поставки широчайшего спектра электронных компонентов.

Собственная эффективная логистика и склад в обеспечивает надежную поставку продукции в точно указанные сроки по всей России.

Мы осуществляем техническую поддержку нашим клиентам и предпродажную проверку качества продукции. На все поставляемые продукты мы предоставляем гарантию .

Осуществляем поставки продукции под контролем ВП МО РФ на предприятия военно-промышленного комплекса России , а также работаем в рамках 275 ФЗ с открытием отдельных счетов в уполномоченном банке. Система менеджмента качества компании соответствует требованиям ГОСТ ISO 9001.

Минимальные сроки поставки, гибкие цены, неограниченный ассортимент и индивидуальный подход к клиентам являются основой для выстраивания долгосрочного и эффективного сотрудничества с предприятиями радиоэлектронной промышленности, предприятиями ВПК и научно-исследовательскими институтами России.

С нами вы становитесь еще успешнее!

Наши контакты:

Телефон: +7 812 627 14 35

Электронная почта: sales@st-electron.ru

Адрес: 198099, Санкт-Петербург,
Промышленная ул, дом № 19, литера Н,
помещение 100-Н Офис 331