

# Switching Transistors

## NPN Silicon

# MPS2369 MPS2369A\*

\*ON Semiconductor Preferred Device

### MAXIMUM RATINGS

Rating	Symbol	Value	Unit
Collector–Emitter Voltage	$V_{CEO}$	15	Vdc
Collector–Emitter Voltage	$V_{CES}$	40	Vdc
Collector–Base Voltage	$V_{CBO}$	40	Vdc
Emitter–Base Voltage	$V_{EBO}$	4.5	Vdc
Collector Current — Continuous	$I_C$	200	mAdc
Total Device Dissipation @ $T_A = 25^\circ\text{C}$ Derate above $25^\circ\text{C}$	$P_D$	625 5.0	mW mW/ $^\circ\text{C}$
Operating and Storage Junction Temperature Range	$T_J, T_{stg}$	-55 to +150	$^\circ\text{C}$

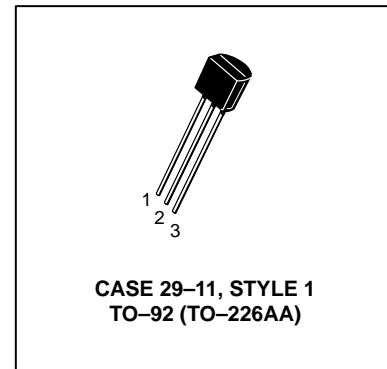

### THERMAL CHARACTERISTICS

Characteristic	Symbol	Max	Unit
Thermal Resistance, Junction to Ambient	$R_{\theta JA}$	200	$^\circ\text{C}/\text{W}$

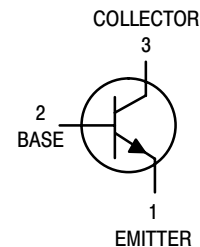

### ELECTRICAL CHARACTERISTICS ( $T_A = 25^\circ\text{C}$ unless otherwise noted)

Characteristic	Symbol	Min	Typ	Max	Unit
----------------	--------	-----	-----	-----	------

### OFF CHARACTERISTICS

Collector–Emitter Breakdown Voltage <sup>(1)</sup> ( $I_C = 10 \text{ mAdc}, I_B = 0$ )	MPS2369A	$V_{(BR)CEO}$	15	—	—	Vdc
Collector–Emitter Breakdown Voltage ( $I_C = 10 \text{ }\mu\text{Adc}, V_{BE} = 0$ )	MPS2369,A	$V_{(BR)CES}$	40	—	—	Vdc
Collector–Base Breakdown Voltage ( $I_C = 10 \text{ }\mu\text{Adc}, I_E = 0$ )	MPS2369,A	$V_{(BR)CBO}$	40	—	—	Vdc
Emitter–Base Breakdown Voltage ( $I_E = 10 \text{ }\mu\text{Adc}, I_C = 0$ )	MPS2369,A	$V_{(BR)EBO}$	4.5	—	—	Vdc
Collector Cutoff Current ( $V_{CB} = 20 \text{ Vdc}, I_E = 0$ ) ( $V_{CB} = 20 \text{ Vdc}, I_E = 0, T_A = 125^\circ\text{C}$ )	MPS2369,A	$I_{CBO}$	— —	— —	0.4 30	$\mu\text{Adc}$
Collector Cutoff Current ( $V_{CE} = 20 \text{ Vdc}, V_{BE} = 0$ )	MPS2369,A	$I_{CES}$	—	—	0.4	$\mu\text{Adc}$

1. Pulse Test: Pulse Width  $\leq 300 \mu\text{s}$ , Duty Cycle  $\leq 2.0\%$ .

Preferred devices are ON Semiconductor recommended choices for future use and best overall value.

# MPS2369 MPS2369A

## ELECTRICAL CHARACTERISTICS ( $T_A = 25^\circ\text{C}$ unless otherwise noted) (Continued)

Characteristic	Symbol	Min	Typ	Max	Unit	
<b>ON CHARACTERISTICS</b>						
DC Current Gain <sup>(1)</sup> ( $I_C = 10\text{ mA}$ , $V_{CE} = 1.0\text{ Vdc}$ ) ( $I_C = 10\text{ mA}$ , $V_{CE} = 1.0\text{ Vdc}$ , $T_A = -55^\circ\text{C}$ ) ( $I_C = 10\text{ mA}$ , $V_{CE} = 1.0\text{ Vdc}$ ) ( $I_C = 10\text{ mA}$ , $V_{CE} = 0.35\text{ Vdc}$ ) ( $I_C = 10\text{ mA}$ , $V_{CE} = 0.35\text{ Vdc}$ , $T_A = -55^\circ\text{C}$ ) ( $I_C = 30\text{ mA}$ , $V_{CE} = 0.4\text{ Vdc}$ ) ( $I_C = 100\text{ mA}$ , $V_{CE} = 2.0\text{ Vdc}$ ) ( $I_C = 100\text{ mA}$ , $V_{CE} = 1.0\text{ Vdc}$ )	MPS2369A MPS2369 MPS2369 MPS2369A MPS2369A MPS2369A MPS2369 MPS2369A	$h_{FE}$	— 20 40 40 20 30 20 20	— — — — — — — —	120 — 120 — — — — —	—
Collector–Emitter Saturation Voltage <sup>(1)</sup> ( $I_C = 10\text{ mA}$ , $I_B = 1.0\text{ mA}$ ) ( $I_C = 10\text{ mA}$ , $I_B = 1.0\text{ mA}$ ) ( $I_C = 10\text{ mA}$ , $I_B = 1.0\text{ mA}$ , $T_A = +125^\circ\text{C}$ ) ( $I_C = 30\text{ mA}$ , $I_B = 3.0\text{ mA}$ ) ( $I_C = 100\text{ mA}$ , $I_B = 10\text{ mA}$ )	MPS2369 MPS2369A MPS2369A MPS2369A MPS2369A	$V_{CE(sat)}$	— — — — —	— — — — —	0.25 0.20 0.30 0.25 0.50	Vdc
Base–Emitter Saturation Voltage <sup>(1)</sup> ( $I_C = 10\text{ mA}$ , $I_B = 1.0\text{ mA}$ ) ( $I_C = 10\text{ mA}$ , $I_B = 1.0\text{ mA}$ , $T_A = +125^\circ\text{C}$ ) ( $I_C = 10\text{ mA}$ , $I_B = 1.0\text{ mA}$ , $T_A = -55^\circ\text{C}$ ) ( $I_C = 30\text{ mA}$ , $I_B = 3.0\text{ mA}$ ) ( $I_C = 100\text{ mA}$ , $I_B = 10\text{ mA}$ )	MPS2369 MPS2369A MPS2369A MPS2369A MPS2369A	$V_{BE(sat)}$	0.7 0.5 — — —	— — — — —	0.85 — 1.02 1.15 1.60	Vdc

## SMALL–SIGNAL CHARACTERISTICS

Output Capacitance ( $V_{CB} = 5.0\text{ Vdc}$ , $I_E = 0$ , $f = 1.0\text{ MHz}$ )	MPS2369,A	$C_{obo}$	—	—	4.0	pF
Small–Signal Current Gain ( $I_C = 10\text{ mA}$ , $V_{CE} = 10\text{ Vdc}$ , $f = 100\text{ MHz}$ )	MPS2369,A	$h_{fe}$	5.0	—	—	—

## SWITCHING CHARACTERISTICS

Storage Time ( $I_{B1} = I_{B2} = I_C = 10\text{ mA}$ ) (Figure 3)	MPS2369,A	$t_s$	—	5.0	13	ns
Turn–On Time ( $V_{CC} = 3.0\text{ Vdc}$ , $I_C = 10\text{ mA}$ , $I_{B1} = 3.0\text{ mA}$ ) (Figure 1)	MPS2369,A	$t_{on}$	—	8.0	12	ns
Turn–Off Time ( $V_{CC} = 3.0\text{ Vdc}$ , $I_C = 10\text{ mA}$ , $I_{B1} = 3.0\text{ mA}$ , $I_{B2} = 1.5\text{ mA}$ ) (Figure 2)	MPS2369,A	$t_{off}$	—	10	18	ns

1. Pulse Test: Pulse Width  $\leq 300\ \mu\text{s}$ , Duty Cycle  $\leq 2.0\%$ .

## MPS2369 MPS2369A

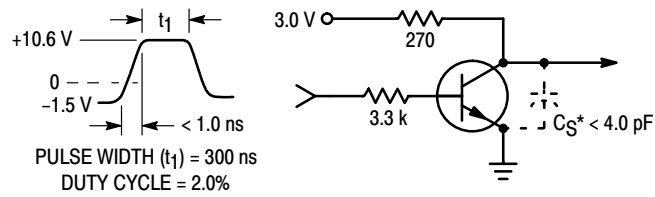

Figure 1.  $t_{on}$  Circuit

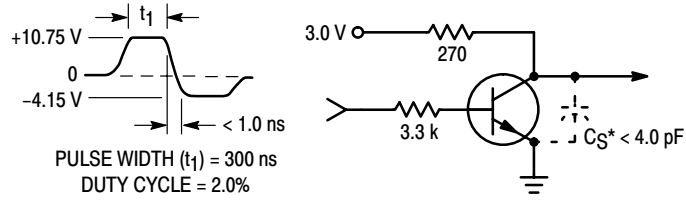

Figure 2.  $t_{off}$  Circuit

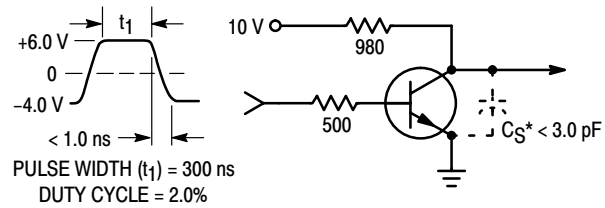

Figure 3. Storage Test Circuit

\*Total shunt capacitance of test jig and connectors.

# MPS2369 MPS2369A

## PACKAGE DIMENSIONS

### TO-92 (TO-226) CASE 29-11 ISSUE AL

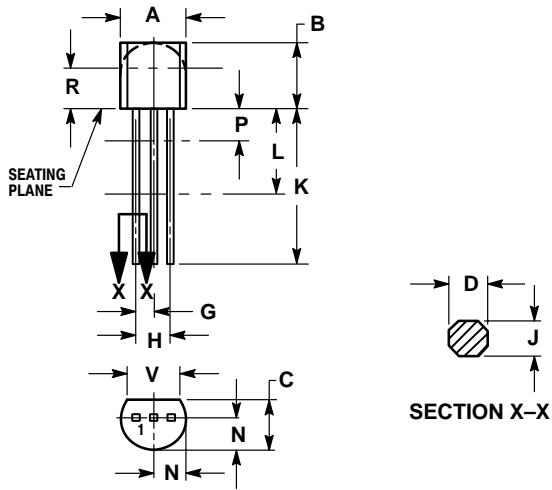

#### NOTES:

1. DIMENSIONING AND TOLERANCING PER ANSI Y14.5M, 1982.
2. CONTROLLING DIMENSION: INCH.
3. CONTOUR OF PACKAGE BEYOND DIMENSION R IS UNCONTROLLED.
4. LEAD DIMENSION IS UNCONTROLLED IN P AND BEYOND DIMENSION K MINIMUM.

DIM	INCHES		MILLIMETERS	
	MIN	MAX	MIN	MAX
A	0.175	0.205	4.45	5.20
B	0.170	0.210	4.32	5.33
C	0.125	0.165	3.18	4.19
D	0.016	0.021	0.407	0.533
G	0.045	0.055	1.15	1.39
H	0.095	0.105	2.42	2.66
J	0.015	0.020	0.39	0.50
K	0.500	---	12.70	---
L	0.250	---	6.35	---
N	0.080	0.105	2.04	2.66
P	---	0.100	---	2.54
R	0.115	---	2.93	---
V	0.135	---	3.43	---

**ON Semiconductor** and  are trademarks of Semiconductor Components Industries, LLC (SCILLC). SCILLC reserves the right to make changes without further notice to any products herein. SCILLC makes no warranty, representation or guarantee regarding the suitability of its products for any particular purpose, nor does SCILLC assume any liability arising out of the application or use of any product or circuit, and specifically disclaims any and all liability, including without limitation special, consequential or incidental damages. "Typical" parameters which may be provided in SCILLC data sheets and/or specifications can and do vary in different applications and actual performance may vary over time. All operating parameters, including "Typicals" must be validated for each customer application by customer's technical experts. SCILLC does not convey any license under its patent rights nor the rights of others. SCILLC products are not designed, intended, or authorized for use as components in systems intended for surgical implant into the body, or other applications intended to support or sustain life, or for any other application in which the failure of the SCILLC product could create a situation where personal injury or death may occur. Should Buyer purchase or use SCILLC products for any such unintended or unauthorized application, Buyer shall indemnify and hold SCILLC and its officers, employees, subsidiaries, affiliates, and distributors harmless against all claims, costs, damages, and expenses, and reasonable attorney fees arising out of, directly or indirectly, any claim of personal injury or death associated with such unintended or unauthorized use, even if such claim alleges that SCILLC was negligent regarding the design or manufacture of the part. SCILLC is an Equal Opportunity/Affirmative Action Employer.

#### PUBLICATION ORDERING INFORMATION

##### Literature Fulfillment:

Literature Distribution Center for ON Semiconductor  
P.O. Box 5163, Denver, Colorado 80217 USA  
Phone: 303-675-2175 or 800-344-3860 Toll Free USA/Canada  
Fax: 303-675-2176 or 800-344-3867 Toll Free USA/Canada  
Email: ONlit@hibbertco.com

**N. American Technical Support:** 800-282-9855 Toll Free USA/Canada

**JAPAN:** ON Semiconductor, Japan Customer Focus Center  
4-32-1 Nishi-Gotanda, Shinagawa-ku, Tokyo, Japan 141-0031  
Phone: 81-3-5740-2700  
Email: r14525@onsemi.com

**ON Semiconductor Website:** <http://onsemi.com>

For additional information, please contact your local Sales Representative.



## Стандарт Электрон Связь

Мы молодая и активно развивающаяся компания в области поставок электронных компонентов. Мы поставляем электронные компоненты отечественного и импортного производства напрямую от производителей и с крупнейших складов мира.

Благодаря сотрудничеству с мировыми поставщиками мы осуществляем комплексные и плановые поставки широчайшего спектра электронных компонентов.

Собственная эффективная логистика и склад в обеспечивает надежную поставку продукции в точно указанные сроки по всей России.

Мы осуществляем техническую поддержку нашим клиентам и предпродажную проверку качества продукции. На все поставляемые продукты мы предоставляем гарантию .

Осуществляем поставки продукции под контролем ВП МО РФ на предприятия военно-промышленного комплекса России , а также работаем в рамках 275 ФЗ с открытием отдельных счетов в уполномоченном банке. Система менеджмента качества компании соответствует требованиям ГОСТ ISO 9001.

Минимальные сроки поставки, гибкие цены, неограниченный ассортимент и индивидуальный подход к клиентам являются основой для выстраивания долгосрочного и эффективного сотрудничества с предприятиями радиоэлектронной промышленности, предприятиями ВПК и научно-исследовательскими институтами России.

С нами вы становитесь еще успешнее!

### Наши контакты:

**Телефон:** +7 812 627 14 35

**Электронная почта:** [sales@st-electron.ru](mailto:sales@st-electron.ru)

**Адрес:** 198099, Санкт-Петербург,  
Промышленная ул, дом № 19, литера Н,  
помещение 100-Н Офис 331