

FCI CONFIDENTIAL

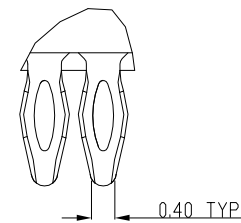

This document is the property of and embodies CONFIDENTIAL and PROPRIETARY information of FCI. No part of the information shown on this document may be used in any way or disclosed to others without the written consent of FCI. Copyright FCI.

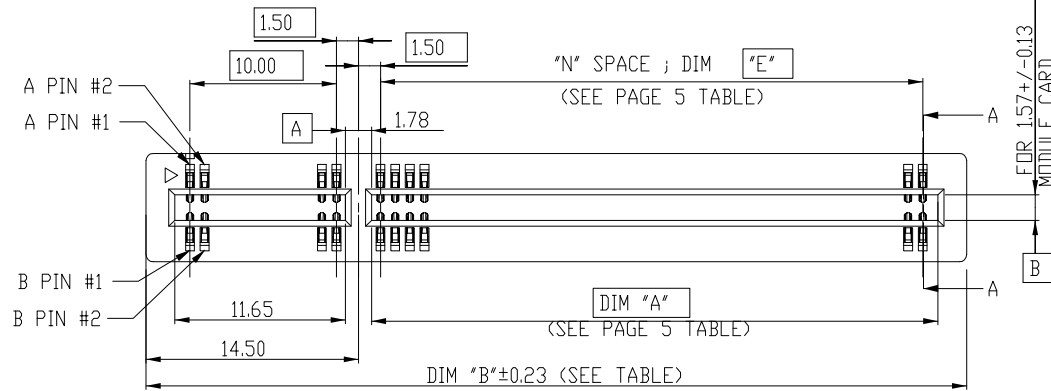

DETAIL A
SCALE 8.000

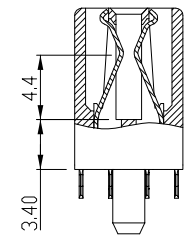
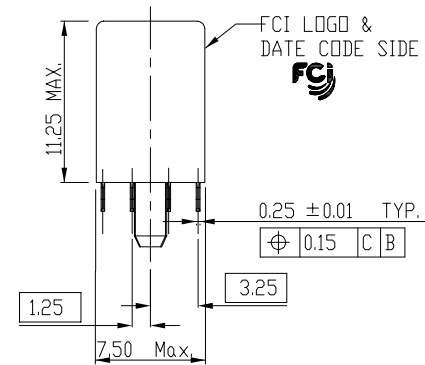
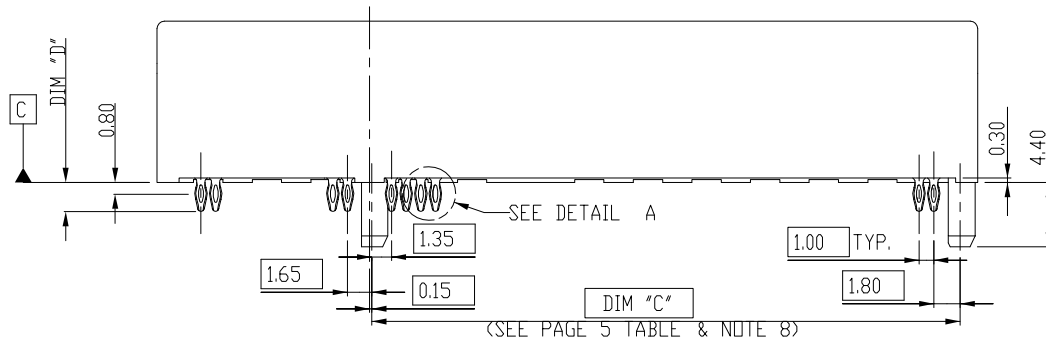

SECTION A-A
SCALE 2.000

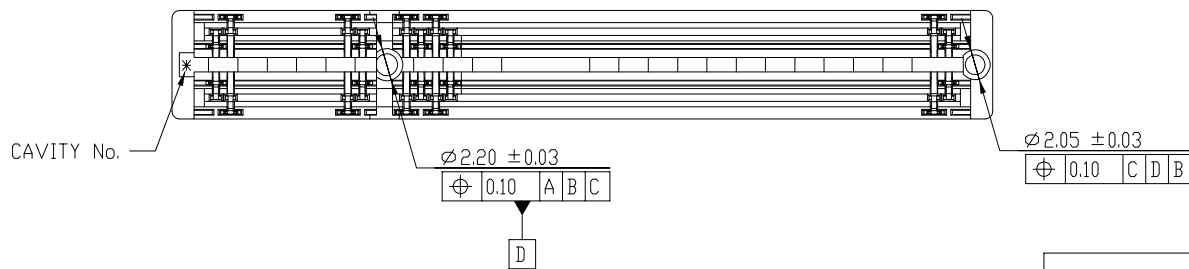

rev	ecn no	dr	date
A	T09-1074	RC	05/19/2009
B	T09-1112	RC	09/02/2009
C	T09-1159	RC	12/16/2009
D	DG-008068	HT	11/22/2011
-	-	-	-
-	-	-	-
-	-	-	-

www.fciconnect.com		surface - ✓	tolerance std	projection	MM
		TOLERANCES UNLESS OTHERWISE SPECIFIED		⊕	↔
Dr	Richard Chiu	06/16/2008	ANGULAR	size	Scale
Eng	Richard Chiu	06/16/2008	LINEAR	A4	1.000
Chr	Paul Wang	06/16/2008	0° ±5°	ECN	DG-008068
Appr	Joseph Hsia	06/16/2008	Product family	Spec ref	
FCI		title		dwg no	
		PCIE GENERATION II		10082378	
		PRESS-FIT TYPE ASSEMBLY		Rev. D	
		catalog no		CUSTOMER	
				sheet 1 of 6	

REV F1 2006-04-17



This document is the property of and embodies CONFIDENTIAL and PROPRIETARY information of FCI. No part of the information shown on this document may be used in any way or disclosed to others without the written consent of FCI. Copyright FCI.

REV F1 2006-04-17

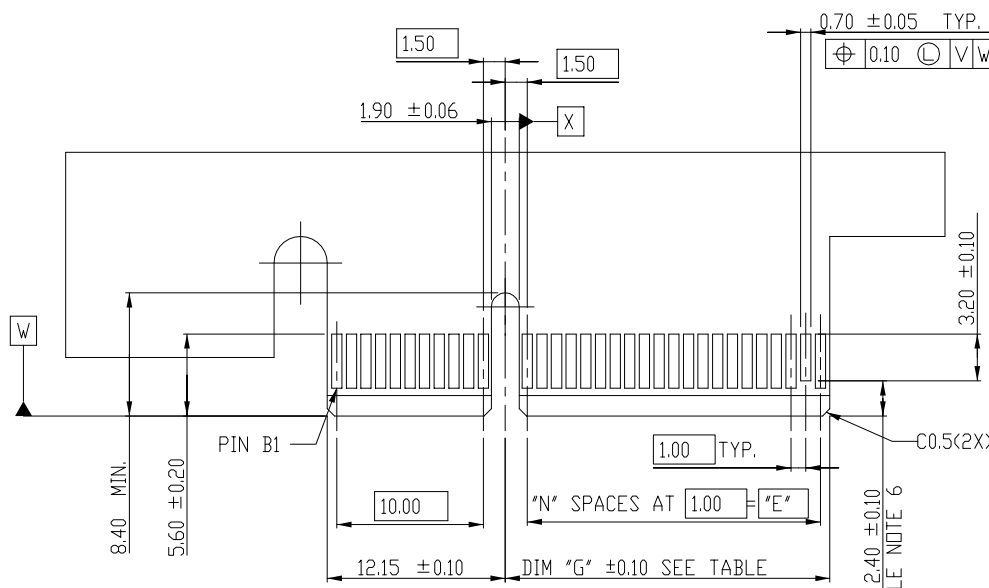

I/O PANEL DIRECTION
PRIMARY (COMPONENT) SIDE

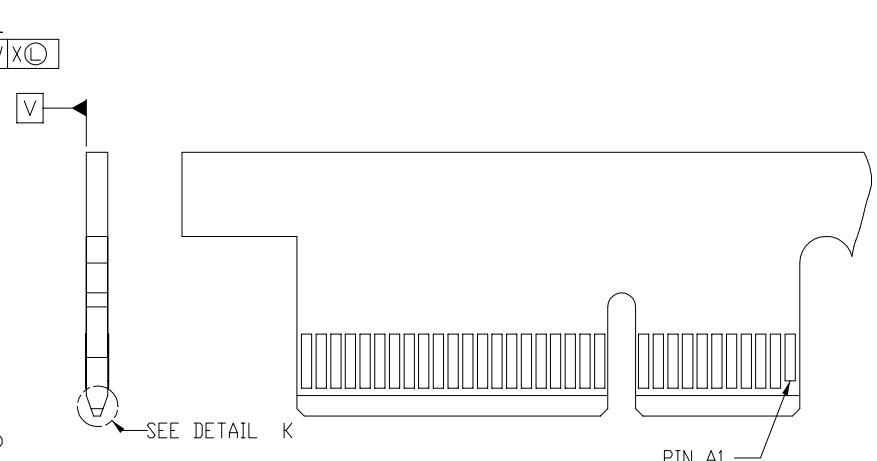

I/O PANEL DIRECTION
SECONDARY (SOLDER) SIDE

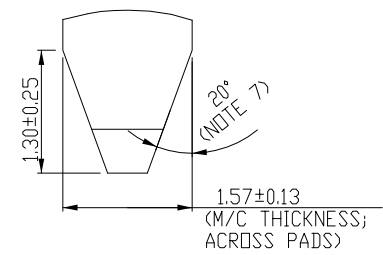

DETAIL K
SCALE 12.000

PDS. REF.	N	DIM "G"	"F"
36	6	8.15	B17
64	20	22.15	B31
98	37	39.15	B48
164	70	72.15	B81

www.fciconnect.com			surface <input checked="" type="checkbox"/>	tolerance std	projection	MM
			TOLERANCES UNLESS OTHERWISE SPECIFIED			← →
Dr	Richard Chiu	06/16/2008	ANGULAR	0.X ±0.25	size	Scale 1.000
Eng	Richard Chiu	06/16/2008	LINEAR	0.XX ±0.15	A4	
Chr	Paul Wang	06/16/2008	0° ±5°	0.XXX ±0.10	ECN	DG-008068
Appr	Joseph Hsia	06/16/2008	Product family		Spec ref	
	title PCIE GENERATION II PRESS-FIT TYPE ASSEMBLY		dwg no 10082378		Rev. D	
catalog no			- CUSTOMER		sheet 2 of 6	



This document is the property of and embodies CONFIDENTIAL and PROPRIETARY information of FCI. No part of the information shown on this document may be used in any way or disclosed to others without the written consent of FCI. Copyright FCI.

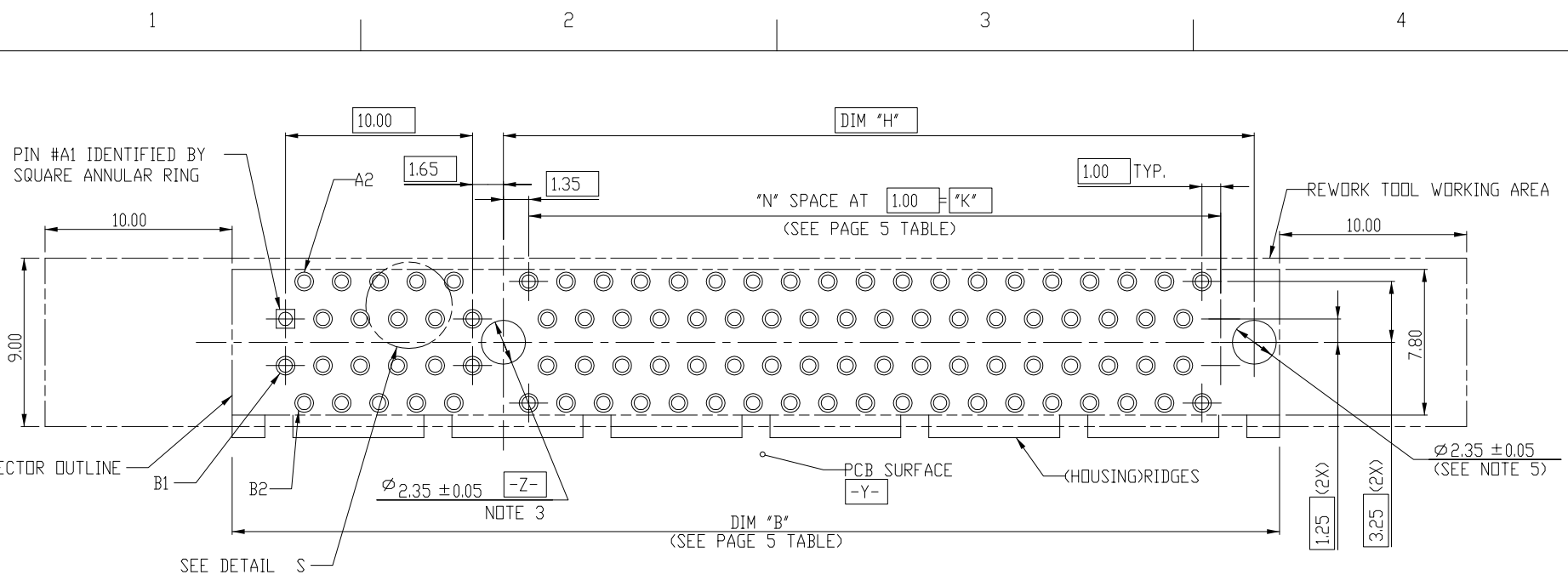

← I/O PANEL DIRECTION

RECOMMENDED FOOTPRINT

POS. REF.	N	DIM "H"	DIM "K"
36	6	9.15	6.00
64	20	23.15	20.00
98	37	40.15	37.00
164	70	73.15	70.00

$\phi 0.70 \pm 0.08$ TYP.
 $\phi 0.10$ (M) (Y) (Z)
 (SEE NOTE 9 FOR PLATING DETAIL)

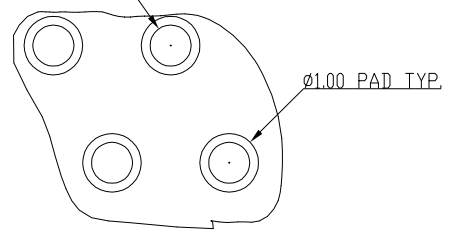

www.fciconnect.com			surface <input checked="" type="checkbox"/>	tolerance std	projection	MM
			TOLERANCES UNLESS OTHERWISE SPECIFIED			← →
Dr	Richard Chiu	06/16/2008	ANGULAR	0.X ±0.25	size	Scale 1.000
Eng	Richard Chiu	06/16/2008	LINEAR	0.XX ±0.15	A4	
Chr	Paul Wang	06/16/2008	0° ±5°	0.XXX ±0.10	ECN	DG-008068
Appr	Joseph Hsia	06/16/2008	Product family		Spec ref	
			title PCIE GENERATION II PRESS-FIT TYPE ASSEMBLY		dwg no 10082378	Rev. D
			catalog no -	CUSTOMER	sheet 3 of 6	



1 | 2 | 3 | 4

NOTES:

1. MATERIAL:
 - HOUSING: HIGH PERFORMANCE RESIN, GLASS FILLED UL94V-0 RATED
 - TERMINAL: COPPER ALLOY
 - PLATING: 50u" NICKEL UNDERPLATE ALL OVER TERMINAL
 - CONTACT AREA PLATING - SEE PRODUCT NUMBER CODE
 - CONTACT TAIL: TIN OR Sn/Pb - 100u" MIN. OVER 50u" NICKEL
2. P/N SEE TABLE AND PRODUCT NUMBER CODE : DESH-XXXXTLF FOR TRAY PACKAGING.
3. PACKAGING SPECIFICATION: GS-14-974
4. PRODUCT SPECIFICATION : GS-12-584

△ THE HORIZONTAL AXIS FOR THE HOLE PATTERN IS ESTABLISHED BY A LINE THROUGH THE CENTER OF THE TWO Ø2.35 HOLES. THE VERTICAL AXIS IS 90° TO THE HORIZONTAL AXIS, THROUGH THE CENTER OF DATUM Z.

△ NO TIE BAR PERMITTED FROM CARD EDGE TO LEADING EDGE OF PAD FOR PINS A1 AND PIN NUMBERS "F".

△ CHAMFER EDGES MUST BE FREE OF CUTTING BURRS.

△ DIMENSION APPLIES AT CENTER OF PLASTIC PEGS, DIMENSION SHOWN IS TO CENTER LINE OF PEGS.

△ ALL PTH SHOULD BE 0.70~0.82 mm DIA DRILLED AND 0.025 mm MIN. ELECTRO-DEPOSITED COPPER THK ON THROUGH HOLE WALL.

10. PRODUCT RoHS DEFINITIONS:

- a-IF TERMINAL PLATING OPTION IS "0,1 OR 2" WHICH MEANS PRODUCT IS 'ROHS COMPATIBLE'. THERE WILL BE "LF" SUFFIX IN THE END.
- b-IF TERMINAL PLATING OPTION IS "3,4 OR 5" WHICH MEANS PRODUCT IS 'ROHS COMPLIANT'. THERE WILL BE NO "LF" SUFFIX IN THE END.
- c-"LF" MEANS THE PRODUCT IS LEAD-FREE, 2um MINIMUM MATTE TIN OVER 1.27um MINIMUM NICKEL UNDERPLATE.

11. THE PRODUCT IS NOT INTENDED TO BE EXPOSED TO A MANUFACTURING SOLDER PROCESS.

10082378 - X X X X X X X X

HOUSING COLOR OPTION:
1: BLACK

0: NON-RIDGE TYPE
1: RIDGE TYPE
(SEE SIDE VIEW OF THIS PAGE)

TERMINAL PLATING OPTIONS

0-50u" Ni UNDERPLATE
30u" Au CONTACT AREA
100u" TIN TAIL AREA -----RoHS COMPATIBALE

1-50u" Ni UNDERPLATE
15u" Au CONTACT AREA
100u" TIN TAIL AREA -----RoHS COMPATIBALE

2-50u" Ni UNDERPLATE
GOLD FLASH CONTACT AREA
100u" TIN TAIL AREA -----RoHS COMPATIBALE

3-50u" Ni UNDERPLATE
30u" Au CONTACT AREA
100u" TIN/LEAD TAIL AREA -----RoHS COMPLIANT

4-50u" Ni UNDERPLATE
15u" Au CONTACT AREA
100u" TIN/LEAD TAIL AREA -----RoHS COMPLIANT

5-50u" Ni UNDERPLATE
GOLD FLASH CONTACT AREA
100u" TIN/LEAD TAIL AREA -----RoHS COMPLIANT

LEAD FREE OPTION
"LF": LEAD-FREE (FOR TERMINAL PLATING OPTION 0,1,2)
"□□": NOT LEAD-FREE (FOR TERMINAL PLATING OPTION 3,4,5)

PACKAGING OPTIONS
T-TRAY PACKAGING

PDS OPTIONS
0-36
1-64
2-98
3-164

TAIL LENGTH OPTIONS

	DIM "D"	PCB THICKNESS
0	2.00±0.20	2.36
1	3.25±0.20	4.19

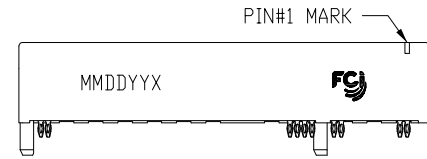

DATE CODE:
MMDDYY:MONTH/DAY/YEAR
X: "K" - GEN.2 MARK

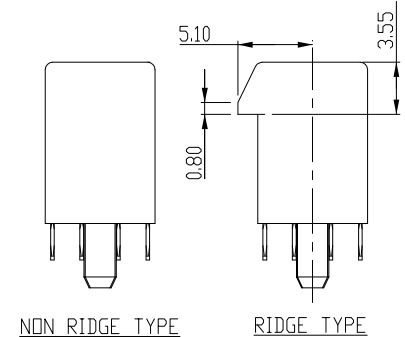

www.fciconnect.com			surface <input checked="" type="checkbox"/>	tolerance std	projection	MM
			TOLERANCES UNLESS OTHERWISE SPECIFIED			
Dr	Richard Chiu	06/16/2008	ANGULAR	0.X ±0.25	size	Scale 1.000
Eng	Richard Chiu	06/16/2008	LINEAR	0.XX ±0.15	ECN	DG-008068
Chr	Paul Wang	06/16/2008	0° ±5°	0.XXX ±0.10	Product family	Spec ref
Appr	Joseph Hsia	06/16/2008	Product family		Spec ref	
			title PCIE GENERATION II PRESS-FIT TYPE ASSEMBLY		dwg no 10082378	Rev. D
			catalog no -	CUSTOMER	sheet 4 of 6	

1 | 2 | 3 | 4

FCI CONFIDENTIAL



This document is the property of and embodies CONFIDENTIAL and PROPRIETARY information of FCI. No part of the information shown on this document may be used in any way or disclosed to others without the written consent of FCI. Copyright FCI.

REV F1 2006-04-17

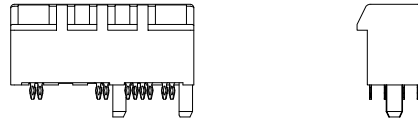

36 PIN RIDGE TYPE FRONT VIEW

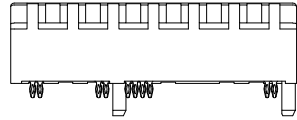
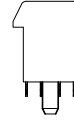

64 PIN RIDGE TYPE FRONT VIEW

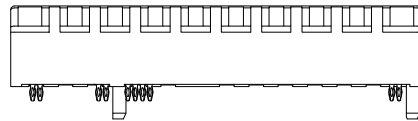
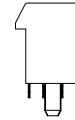

98 PIN RIDGE TYPE FRONT VIEW

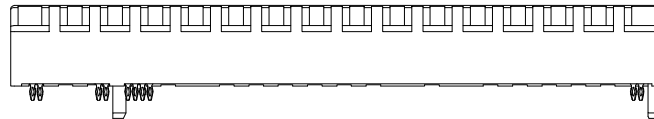
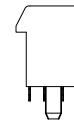

164 PIN RIDGE TYPE FRONT VIEW

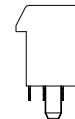

www.fciconnect.com			surface <input checked="" type="checkbox"/>	tolerance std	projection	MM	
			TOLERANCES UNLESS OTHERWISE SPECIFIED			↔	
Dr	Richard Chiu	06/16/2008	ANGULAR	0.X	±0.25	size	Scale
Eng	Richard Chiu	06/16/2008	LINEAR	0.XX	±0.15	A4	1.000
Chr	Paul Wang	06/16/2008	0° ±5°	0.XXX	±0.10	ECN	DG-008068
Appr	Joseph Hsia	06/16/2008	Product family		-	Spec ref	
			title			no	
			PCIE GENERATION II			10082378	
			PRESS-FIT TYPE ASSEMBLY			Rev. D	
			catalog no			CUSTOMER sheet 5 of 6	

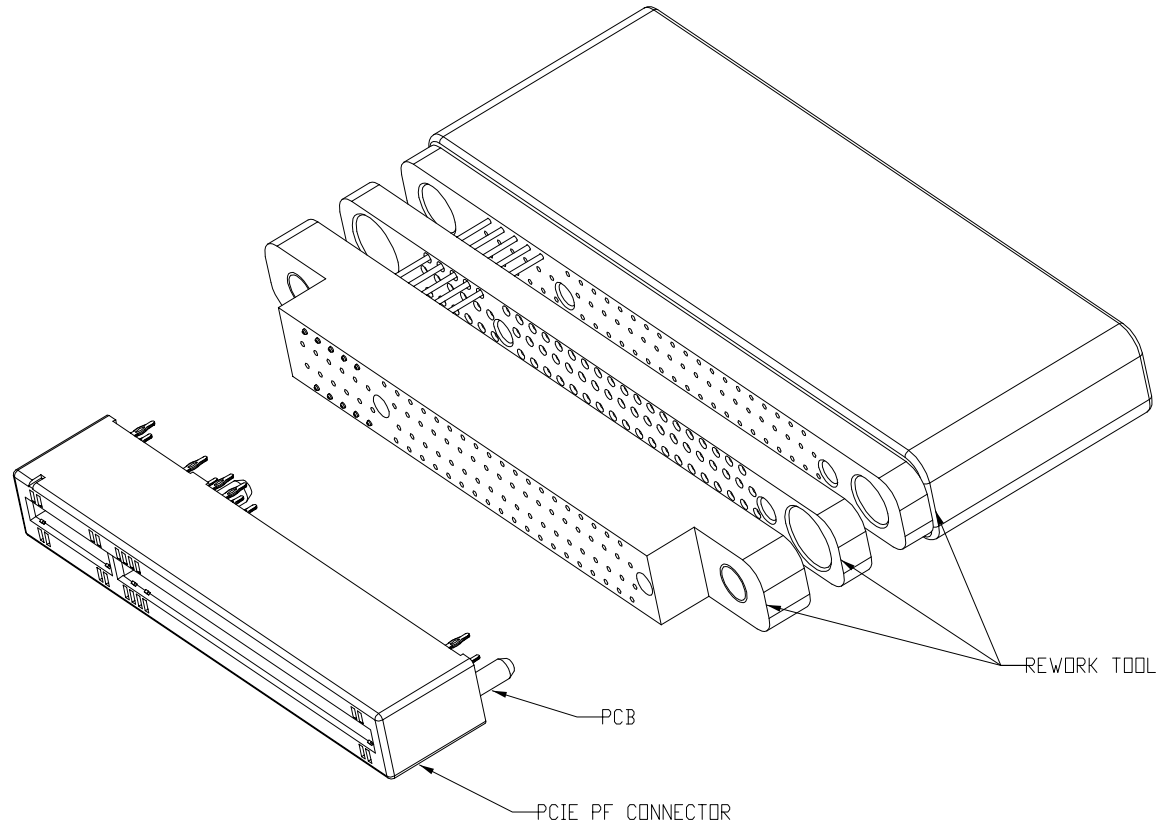

CONNECTOR REWORK TOOL & ILLUSTRATION
(SEE APPLICATION SPECIFICATION GS-20-117 FOR DETAILS)

PRODUCT DIMENSION TABLE FOR EACH TYPES

CONNECTOR	# PDS REF.	N	DIM 'A'	DIM 'B'	DIM 'C'	DIM 'E'
1 PORT	36	6	7.65	25.00	9.15	6.00
4 PORT	64	20	21.65	39.00	23.15	20.00
8 PORT	98	37	38.65	56.00	40.15	37.00
16 PORT	164	70	71.65	89.00	73.15	70.00

www.fciconnect.com			surface <input checked="" type="checkbox"/>	tolerance std	projection	MM	
			TOLERANCES UNLESS OTHERWISE SPECIFIED			←→	
Dr	Richard Chiu	06/16/2008	ANGULAR	0.X	±0.25	size	Scale
Eng	Richard Chiu	06/16/2008	LINEAR	0.XX	±0.15	A4	1.000
Chr	Paul Wang	06/16/2008	0° ±5°	0.XXX	±0.10	ECN	DG-008068
Appr	Joseph Hsia	06/16/2008	Product family			Spec ref	
			title PCIE GENERATION II PRESS-FIT TYPE ASSEMBLY			no 10082378	
catalog no			CUSTOMER			Rev. D	
			sheet 6 of 6				



Стандарт Электрон Связь

Мы молодая и активно развивающаяся компания в области поставок электронных компонентов. Мы поставляем электронные компоненты отечественного и импортного производства напрямую от производителей и с крупнейших складов мира.

Благодаря сотрудничеству с мировыми поставщиками мы осуществляем комплексные и плановые поставки широчайшего спектра электронных компонентов.

Собственная эффективная логистика и склад в обеспечивает надежную поставку продукции в точно указанные сроки по всей России.

Мы осуществляем техническую поддержку нашим клиентам и предпродажную проверку качества продукции. На все поставляемые продукты мы предоставляем гарантию .

Осуществляем поставки продукции под контролем ВП МО РФ на предприятия военно-промышленного комплекса России , а также работаем в рамках 275 ФЗ с открытием отдельных счетов в уполномоченном банке. Система менеджмента качества компании соответствует требованиям ГОСТ ISO 9001.

Минимальные сроки поставки, гибкие цены, неограниченный ассортимент и индивидуальный подход к клиентам являются основой для выстраивания долгосрочного и эффективного сотрудничества с предприятиями радиоэлектронной промышленности, предприятиями ВПК и научно-исследовательскими институтами России.

С нами вы становитесь еще успешнее!

Наши контакты:

Телефон: +7 812 627 14 35

Электронная почта: sales@st-electron.ru

Адрес: 198099, Санкт-Петербург,
Промышленная ул, дом № 19, литера Н,
помещение 100-Н Офис 331