

FEATURES

- 3MSPS Sampling ADC with Two Simultaneous Differential Inputs
- 1.5MSPS Throughput per Channel
- Low Power Dissipation: 14mW (Typ)
- 3V Single Supply Operation
- $\pm 1.25V$ Differential Input Range
- Pin Compatible 0V to 2.5V Input Range Version (LTC1407/LTC1407A)
- 2.5V Internal Bandgap Reference with External Overdrive
- 3-Wire Serial Interface
- Sleep (10 μ W) Shutdown Mode
- Nap (3mW) Shutdown Mode
- 80dB Common Mode Rejection at 100kHz
- Tiny 10-Lead MS Package

APPLICATIONS

- Telecommunications
- Data Acquisition Systems
- Uninterrupted Power Supplies
- Multiphase Motor Control
- I & Q Demodulation
- Industrial Radio

DESCRIPTION

The LTC[®]1407-1/LTC1407A-1 are 12-bit/14-bit, 3MSPS ADCs with two 1.5MSPS simultaneously sampled differential inputs. The devices draw only 4.7mA from a single 3V supply and come in a tiny 10-lead MS package. A sleep shutdown feature lowers power consumption to 10 μ W. The combination of speed, low power and tiny package makes the LTC1407-1/LTC1407A-1 suitable for high speed, portable applications.

The LTC1407-1/LTC1407A-1 contain two separate differential inputs that are sampled simultaneously on the rising edge of the CONV signal. These two sampled inputs are then converted at a rate of 1.5MSPS per channel.

The 80dB common mode rejection allows users to eliminate ground loops and common mode noise by measuring signals differentially from the source.

The devices convert $-1.25V$ to $1.25V$ bipolar inputs differentially. The absolute voltage swing for CH0⁺, CH0⁻, CH1⁺ and CH1⁻ extends from ground to the supply voltage.

The serial interface sends out the two conversion results in 32 clocks for compatibility with standard serial interfaces.

LT, LTC, LTM, Linear Technology and the Linear logo are registered trademarks of Linear Technology Corporation. All other trademarks are the property of their respective owners. Protected by U.S. Patents including 6084440, 6522187.

BLOCK DIAGRAM

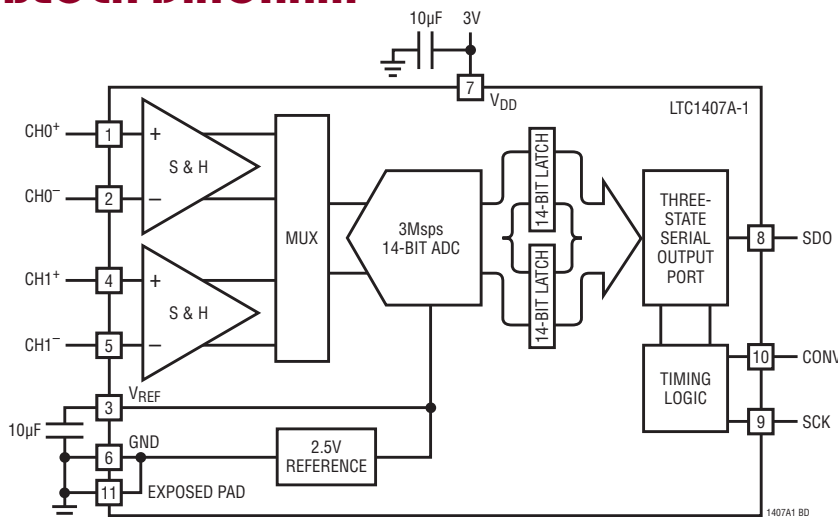

THD, 2nd and 3rd vs Input Frequency for Differential Input Signals

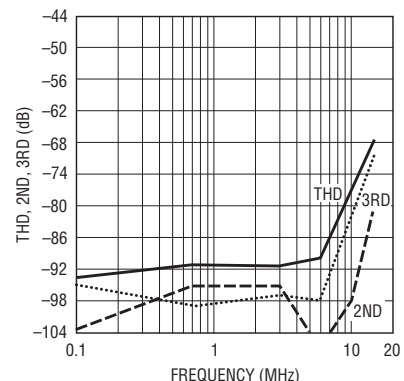

LTC1407-1/LTC1407A-1

ABSOLUTE MAXIMUM RATINGS

(Notes 1, 2)

Supply Voltage (V_{DD})	4V
Analog Input Voltage (Note 3)	-0.3V to ($V_{DD} + 0.3V$)
Digital Input Voltage	-0.3V to ($V_{DD} + 0.3V$)
Digital Output Voltage	-0.3V to ($V_{DD} + 0.3V$)
Power Dissipation	100mW
Operation Temperature Range	
LTC1407C-1/LTC1407AC-1	0°C to 70°C
LTC1407I-1/LTC1407AI-1	-40°C to 85°C
Storage Temperature Range	-65°C to 150°C
Lead Temperature (Soldering, 10 sec)	300°C

PIN CONFIGURATION

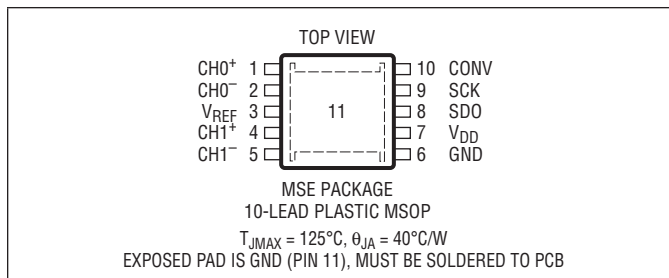

ORDER INFORMATION

LEAD FREE FINISH	TAPE AND REEL	PART MARKING	PACKAGE DESCRIPTION	TEMPERATURE RANGE
LTC1407CMSE-1#PBF	LTC1407CMSE-1#TRPBF	LTBGT	10-Lead Plastic MSOP	0°C to 70°C
LTC1407IMSE-1#PBF	LTC1407IMSE-1#TRPBF	LTBGV	10-Lead Plastic MSOP	-40°C to 85°C
LTC1407ACMSE-1#PBF	LTC1407ACMSE-1#TRPBF	LTBGW	10-Lead Plastic MSOP	0°C to 70°C
LTC1407AIMSE-1#PBF	LTC1407AIMSE-1#TRPBF	LTBGX	10-Lead Plastic MSOP	-40°C to 85°C

Consult LTC Marketing for parts specified with wider operating temperature ranges.

Consult LTC Marketing for information on non-standard lead based finish parts.

For more information on lead free part marking, go to: <http://www.linear.com/leadfree/>

For more information on tape and reel specifications, go to: <http://www.linear.com/tapeandreel/>

CONVERTER CHARACTERISTICS

The ● denotes the specifications which apply over the full operating temperature range, otherwise specifications are at $T_A = 25^\circ\text{C}$. With internal reference, $V_{DD} = 3V$.

PARAMETER	CONDITIONS	LTC1407-1			LTC1407A-1				
		MIN	TYP	MAX	MIN	TYP	MAX		
Resolution (No Missing Codes)		●	12		14			Bits	
Integral Linearity Error	(Notes 5, 17)	●	-2	±0.25	2	-4	±0.5	4	LSB
Offset Error	(Notes 4, 17)	●	-10	±1	10	-20	±2	20	LSB
Offset Match from CH0 to CH1	(Note 17)		-5	±0.5	5	-10	±1	10	LSB
Gain Error	(Notes 4, 17)	●	-30	±5	30	-60	±10	60	LSB
Gain Match from CH0 to CH1	(Note 17)		-5	±1	5	-10	±2	10	LSB
Gain Tempco	Internal Reference (Note 4) External Reference			±15 ±1			±15 ±1		ppm/°C ppm/°C

ANALOG INPUT The ● denotes the specifications which apply over the full operating temperature range, otherwise specifications are at $T_A = 25^\circ\text{C}$. With internal reference, $V_{DD} = 3\text{V}$.

SYMBOL	PARAMETER	CONDITIONS	MIN	TYP	MAX	UNITS
V_{IN}	Analog Differential Input Range (Notes 3, 8, 9)	$2.7\text{V} \leq V_{DD} \leq 3.3\text{V}$		-1.25 to 1.25		V
V_{CM}	Analog Common Mode + Differential Input Range (Note 10)			0 to V_{DD}		V
I_{IN}	Analog Input Leakage Current		●		1	μA
C_{IN}	Analog Input Capacitance	(Note 18)		13		pF
t_{ACQ}	Sample-and-Hold Acquisition Time	(Note 6)	●		39	ns
t_{AP}	Sample-and-Hold Aperture Delay Time			1		ns
t_{JITTER}	Sample-and-Hold Aperture Delay Time Jitter			0.3		ps
t_{SK}	Sample-and-Hold Aperture Skew from CH0 to CH1			200		ps
CMRR	Analog Input Common Mode Rejection Ratio	$f_{IN} = 1\text{MHz}, V_{IN} = 0\text{V to } 3\text{V}$ $f_{IN} = 100\text{MHz}, V_{IN} = 0\text{V to } 3\text{V}$		-60 -15		dB dB

DYNAMIC ACCURACY The ● denotes the specifications which apply over the full operating temperature range, otherwise specifications are at $T_A = 25^\circ\text{C}$. With internal reference, $V_{DD} = 3\text{V}$. Single-ended signal drive $\text{CH0}^+/\text{CH1}^+$ with $\text{CH0}^-/\text{CH1}^- = 1.5\text{V DC}$. Differential signals drive both inputs of each channel with $V_{CM} = 1.5\text{V DC}$.

SYMBOL	PARAMETER	CONDITIONS	LTC1407-1			LTC1407A-1			UNITS
			MIN	TYP	MAX	MIN	TYP	MAX	
SINAD	Signal-to-Noise Plus Distortion Ratio	100kHz Input Signal (Note 19)	●		70.5		73.5		dB
		750kHz Input Signal (Note 19)		68	70.5	70	73.5		dB
		100kHz Input Signal, External $V_{REF} = 3.3\text{V}$, $V_{DD} \geq 3.3\text{V}$ (Note 19)			72.0		76.3		dB
		750kHz Input Signal, External $V_{REF} = 3.3\text{V}$, $V_{DD} \geq 3.3\text{V}$ (Note 19)			72.0		76.3		dB
THD	Total Harmonic Distortion	100kHz First 5 Harmonics (Note 19)	●		-87		-90		dB
		750kHz First 5 Harmonics (Note 19)			-83	-77	-86	-80	dB
SFDR	Spurious Free Dynamic Range	100kHz Input Signal (Note 19)			87		90		dB
		750kHz Input Signal (Note 19)			83		86		dB
IMD	Intermodulation Distortion	0.625 V_{P-P} 1.4MHz Summed with 0.625 V_{P-P} , 1.56MHz into CH0^+ and Inverted into CH0^- . Also Applicable to CH1^+ and CH1^-			-82		-82		dB
	Code-to-Code Transition Noise	$V_{REF} = 2.5\text{V}$ (Note 17)			0.25		1		LSB_{RMS}
	Full Power Bandwidth	$V_{IN} = 2.5\text{V}_{P-P}$, $\text{SDO} = 11585\text{LSB}_{P-P}$ (-3dBFS) (Note 15)			50		50		MHz
	Full Linear Bandwidth	$S/(N + D) \geq 68\text{dB}$			5		5		MHz

LTC1407-1/LTC1407A-1

INTERNAL REFERENCE CHARACTERISTICS $T_A = 25^\circ\text{C}$. $V_{DD} = 3\text{V}$.

PARAMETER	CONDITIONS	MIN	TYP	MAX	UNITS
V_{REF} Output Voltage	$I_{OUT} = 0$		2.5		V
V_{REF} Output Tempco			15		ppm/ $^\circ\text{C}$
V_{REF} Line Regulation	$V_{DD} = 2.7\text{V}$ to 3.6V , $V_{REF} = 2.5\text{V}$		600		$\mu\text{V/V}$
V_{REF} Output Resistance	Load Current = 0.5mA		0.2		Ω
V_{REF} Setting Time			2		ms

DIGITAL INPUTS AND DIGITAL OUTPUTS The ● denotes the specifications which apply over the full operating temperature range, otherwise specifications are at $T_A = 25^\circ\text{C}$. $V_{DD} = 3\text{V}$.

SYMBOL	PARAMETER	CONDITIONS	MIN	TYP	MAX	UNITS
V_{IH}	High Level Input Voltage	$V_{DD} = 3.3\text{V}$	● 2.4			V
V_{IL}	Low Level Input Voltage	$V_{DD} = 2.7\text{V}$	●		0.6	V
I_{IN}	Digital Input Current	$V_{IN} = 0\text{V}$ to V_{DD}	●		± 10	μA
C_{IN}	Digital Input Capacitance			5		pF
V_{OH}	High Level Output Voltage	$V_{DD} = 3\text{V}$, $I_{OUT} = -200\mu\text{A}$	● 2.5	2.9		V
V_{OL}	Low Level Output Voltage	$V_{DD} = 2.7\text{V}$, $I_{OUT} = 160\mu\text{A}$ $V_{DD} = 2.7\text{V}$, $I_{OUT} = 1.6\text{mA}$	●	0.05 0.10	0.4	V V
I_{OZ}	Hi-Z Output Leakage D_{OUT}	$V_{OUT} = 0\text{V}$ to V_{DD}	●		± 10	μA
C_{OZ}	Hi-Z Output Capacitance D_{OUT}			1		pF
I_{SOURCE}	Output Short-Circuit Source Current	$V_{OUT} = 0\text{V}$, $V_{DD} = 3\text{V}$		20		mA
I_{SINK}	Output Short-Circuit Sink Current	$V_{OUT} = V_{DD} = 3\text{V}$		15		mA

POWER REQUIREMENTS The ● denotes the specifications which apply over the full operating temperature range, otherwise specifications are at $T_A = 25^\circ\text{C}$. With internal reference, $V_{DD} = 3\text{V}$.

SYMBOL	PARAMETER	CONDITIONS	MIN	TYP	MAX	UNITS
V_{DD}	Supply Voltage		2.7		3.6	V
I_{DD}	Supply Current	Active Mode, $f_{SAMPLE} = 1.5\text{MSPS}$ Nap Mode Sleep Mode (LTC1407) Sleep Mode (LTC1407A)	● ●	4.7 1.1 2.0 2.0	7.0 1.5 15 10	mA mA μA μA
PD	Power Dissipation	Active Mode with SCK in Fixed State (Hi or Lo)		12		mW

TIMING CHARACTERISTICS

The ● denotes the specifications which apply over the full operating temperature range, otherwise specifications are at $T_A = 25^\circ\text{C}$. $V_{DD} = 3\text{V}$.

SYMBOL	PARAMETER	CONDITIONS	MIN	TYP	MAX	UNITS
$f_{\text{SAMPLE(MAX)}}$	Maximum Sampling Frequency per Channel (Conversion Rate)		●	1.5		MHz
$t_{\text{THROUGHPUT}}$	Minimum Sampling Period (Conversion + Acquisition Period)		●		667	ns
t_{SCK}	Clock Period	(Note 16)	●	19.6	10000	ns
t_{CONV}	Conversion Time	(Note 6)		32	34	SCLK cycles
t_1	Minimum Positive or Negative SCLK Pulse Width	(Note 6)		2		ns
t_2	CONV to SCK Setup Time	(Notes 6, 10)		3	10000	ns
t_3	SCK Before CONV	(Note 6)		0		ns
t_4	Minimum Positive or Negative CONV Pulse Width	(Note 6)		4		ns
t_5	SCK to Sample Mode	(Note 6)		4		ns
t_6	CONV to Hold Mode	(Notes 6, 11)		1.2		ns
t_7	32nd SCK \uparrow to CONV \uparrow Interval (Affects Acquisition Period)	(Notes 6, 7, 13)		45		ns
t_8	Minimum Delay from SCK to Valid Bits 0 Through 11	(Notes 6, 12)		8		ns
t_9	SCK to Hi-Z at SDO	(Notes 6, 12)		6		ns
t_{10}	Previous SDO Bit Remains Valid After SCK	(Notes 6, 12)		2		ns
t_{12}	V_{REF} Settling Time After Sleep-to-Wake Transition	(Notes 6, 14)			2	ms

Note 1: Stresses beyond those listed under Absolute Maximum Ratings may cause permanent damage to the device. Exposure to any Absolute Maximum Rating condition for extended periods may affect device reliability and lifetime.

Note 2: All voltage values are with respect to ground GND.

Note 3: When these pins are taken below GND or above V_{DD} , they will be clamped by internal diodes. This product can handle input currents greater than 100mA below GND or greater than V_{DD} without latchup.

Note 4: Offset and range specifications apply for a single-ended CH0^+ or CH1^+ input with CH0^- or CH1^- grounded and using the internal 2.5V reference.

Note 5: Integral linearity is tested with an external 2.55V reference and is defined as the deviation of a code from the straight line passing through the actual endpoints of a transfer curve. The deviation is measured from the center of quantization band.

Note 6: Guaranteed by design, not subject to test.

Note 7: Recommended operating conditions.

Note 8: The analog input range is defined for the voltage difference between CH0^+ and CH0^- or CH1^+ and CH1^- . Performance is specified with $\text{CH0}^- = 1.5\text{V DC}$ while driving CH0^+ and with $\text{CH1}^- = 1.5\text{V DC}$ while driving CH1^+ .

Note 9: The absolute voltage at CH0^+ , CH0^- , CH1^+ and CH1^- must be within this range.

Note 10: If less than 3ns is allowed, the output data will appear one clock cycle later. It is best for CONV to rise half a clock before SCK, when running the clock at rated speed.

Note 11: Not the same as aperture delay. Aperture delay (1ns) is the difference between the 2.2ns delay through the sample-and-hold and the 1.2ns CONV to hold mode delay.

Note 12: The rising edge of SCK is guaranteed to catch the data coming out into a storage latch.

Note 13: The time period for acquiring the input signal is started by the 32nd rising clock and it is ended by the rising edge of CONV.

Note 14: The internal reference settles in 2ms after it wakes up from sleep mode with one or more cycles at SCK and a 10 μF capacitive load.

Note 15: The full power bandwidth is the frequency where the output code swing drops by 3dB with a 2.5V $_{\text{P-P}}$ input sine wave.

Note 16: Maximum clock period guarantees analog performance during conversion. Output data can be read with an arbitrarily long clock period.

Note 17: The LTC1407A-1 is measured and specified with 14-bit Resolution (1LSB = 152 μV) and the LTC1407-1 is measured and specified with 12-bit Resolution (1LSB = 610 μV).

Note 18: The sampling capacitor at each input accounts for 4.1pF of the input capacitance.

Note 19: Full-scale sinewaves are fed into the noninverting inputs while the inverting inputs are kept at 1.5V DC.

LTC1407-1/LTC1407A-1

TYPICAL PERFORMANCE CHARACTERISTICS $V_{DD} = 3V$, $T_A = 25^\circ C$. Single-ended signals drive +CH0/+CH1 with -CH0/-CH1 = 1.5V DC, differential signals drive both inputs with $V_{CM} = 1.5V$ DC (LTC1407A-1)

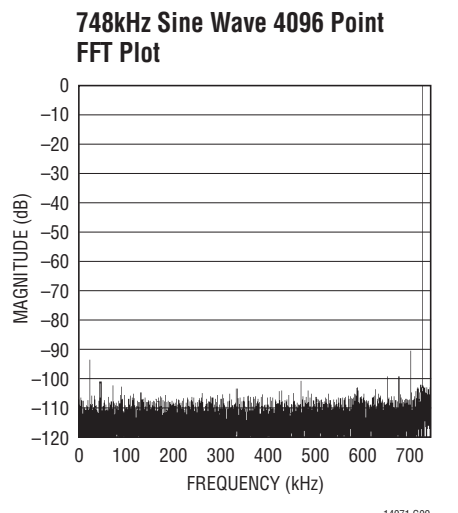
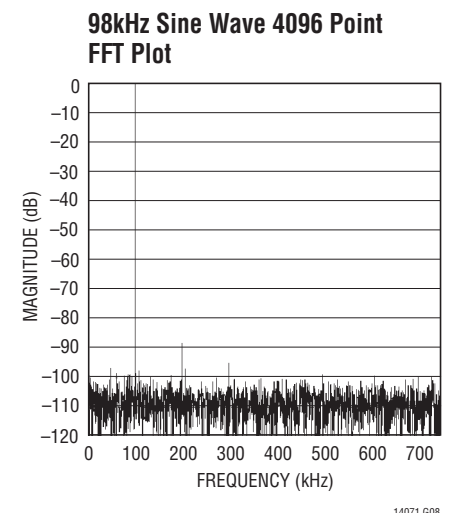
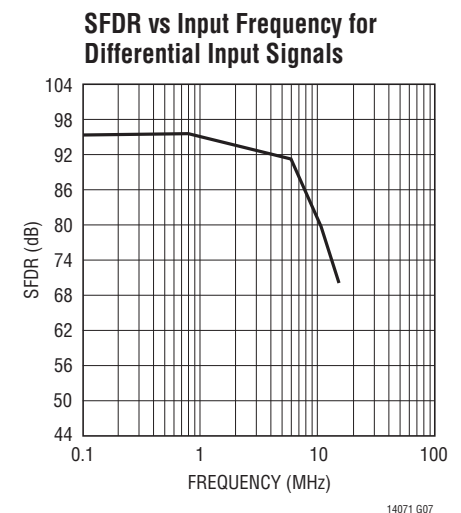
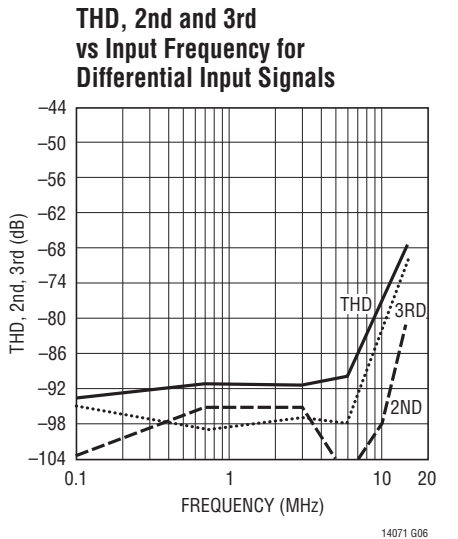
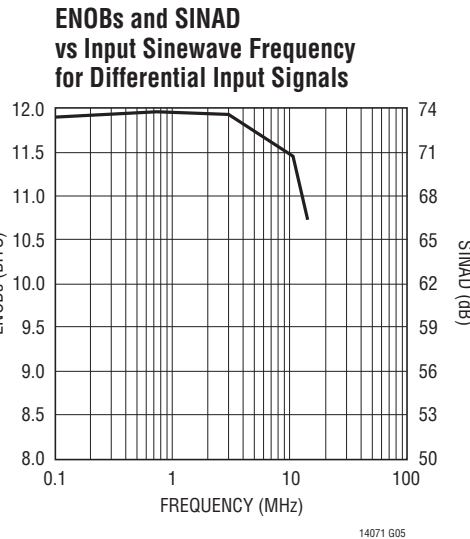
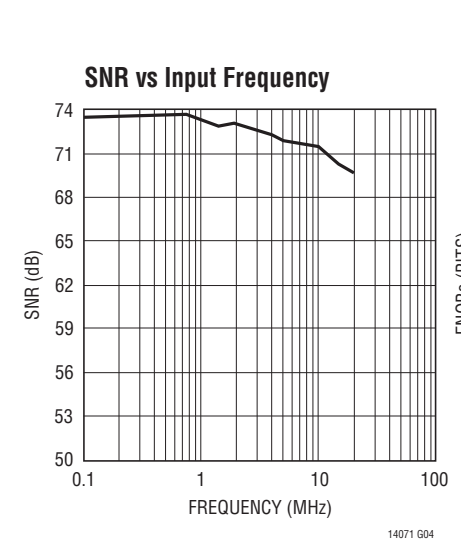
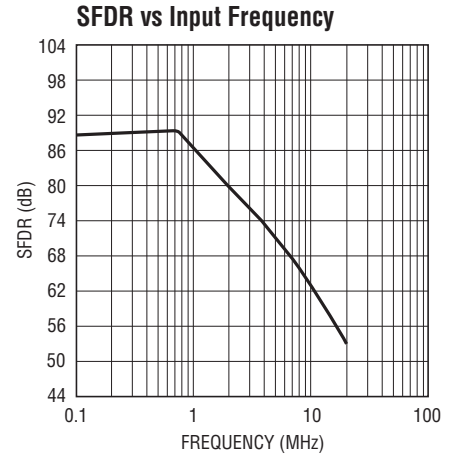
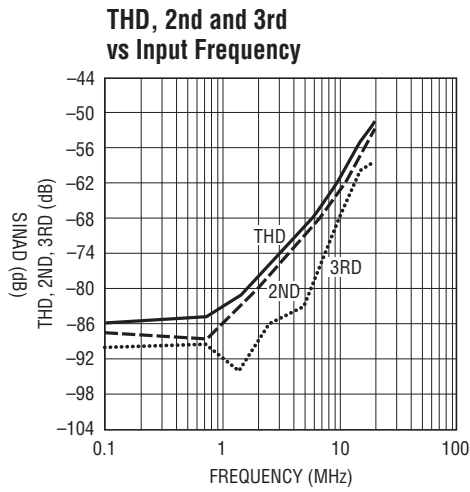
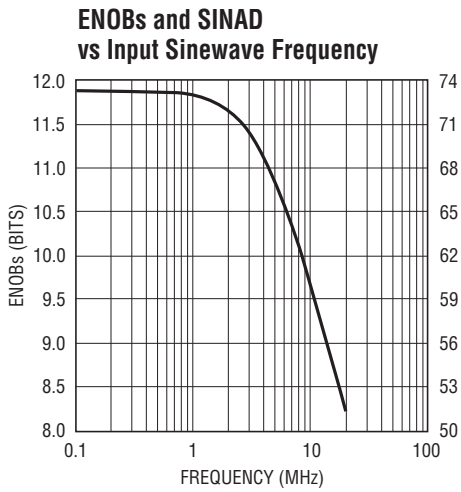

TYPICAL PERFORMANCE CHARACTERISTICS $V_{DD} = 3V$, $T_A = 25^\circ C$. Single-ended signals drive +CH0/+CH1 with -CH0/-CH1 = 1.5V DC, differential signals drive both inputs with $V_{CM} = 1.5V$ DC (LTC1407A-1)

1403kHz Input Summed with 1563kHz Input IMD 4096 Point FFT Plot for Differential Input Signals

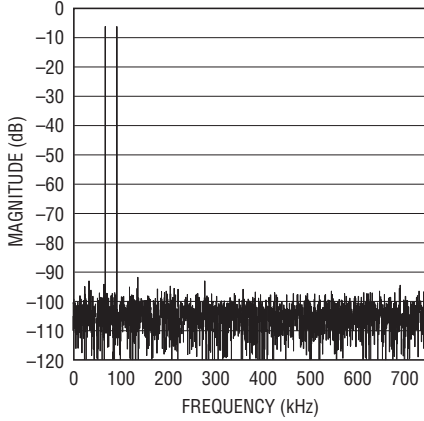

748kHz Sine Wave 4096 Point FFT Plot for Differential Input Signals

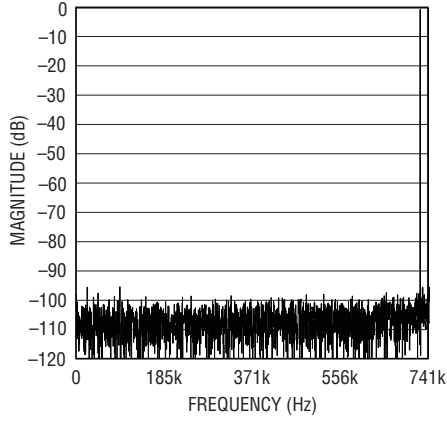

10.7MHz Sine Wave 4096 Point FFT Plot for Differential Input Signals

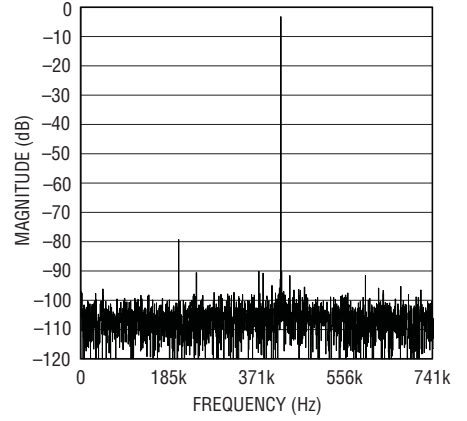

Differential Linearity for CH0 with Internal 2.5V Reference

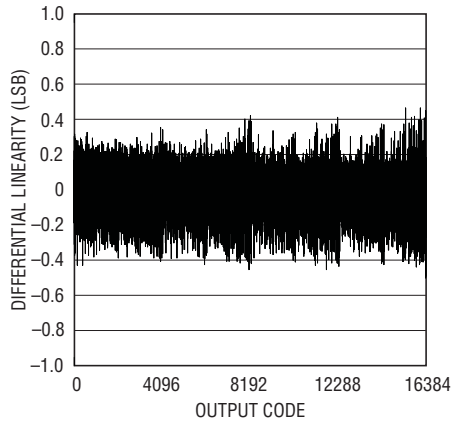

Integral Linearity End Point Fit for CH0 with Internal 2.5V Reference

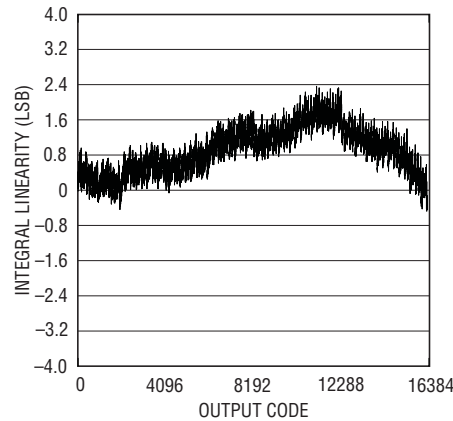

Integral Linearity End Point Fit for CH0 with Internal 2.5V Reference for Differential Input Signals

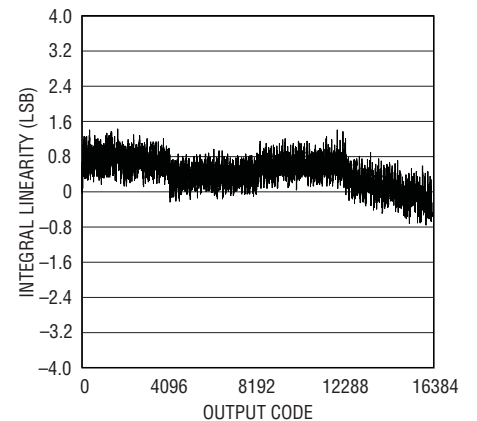

Differential Linearity for CH1 with Internal 2.5V Reference

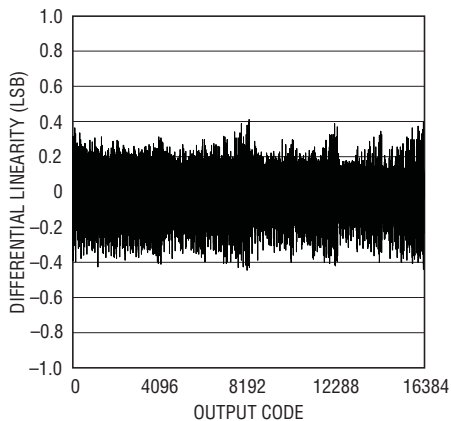

Integral Linearity End Point Fit for CH1 with Internal 2.5V Reference

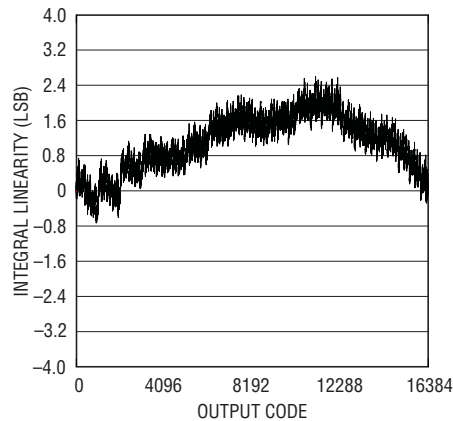

Integral Linearity End Point Fit for CH1 with Internal 2.5V Reference for Differential Input Signals

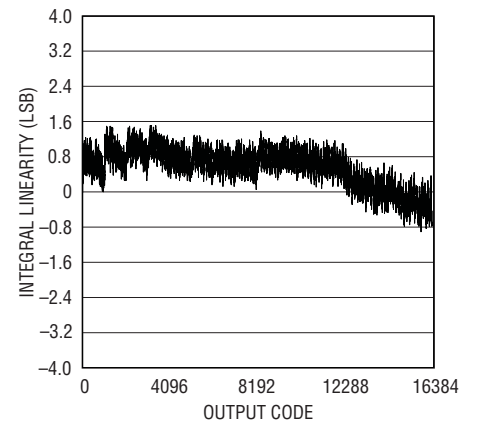

LTC1407-1/LTC1407A-1

TYPICAL PERFORMANCE CHARACTERISTICS $V_{DD} = 3V$, $T_A = 25^\circ C$. Single ended signals drive +CH0/+CH1 with -CH0/-CH1 = 1.5V DC, differential signals drive both inputs with $V_{CM} = 1.5V$ DC (LTC1407A-1)

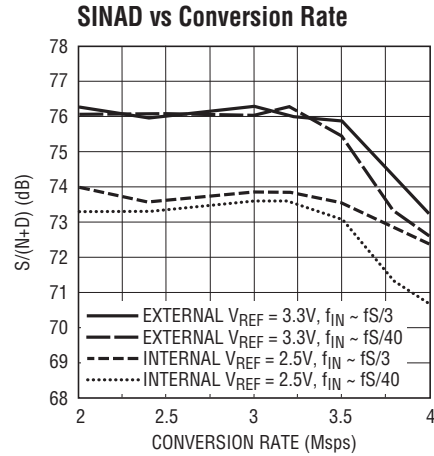
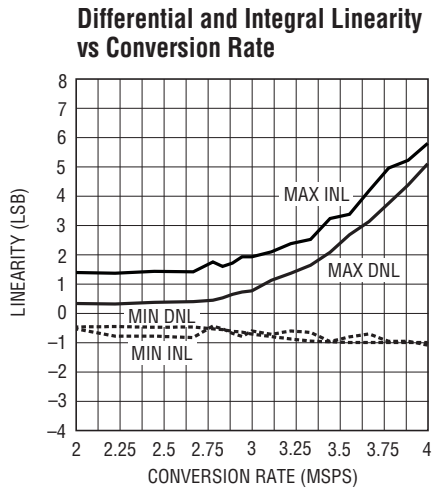

$V_{DD} = 3V$, $T_A = 25^\circ C$ (LTC1407-1/LTC1407A-1)

14071 G19

14071 G20

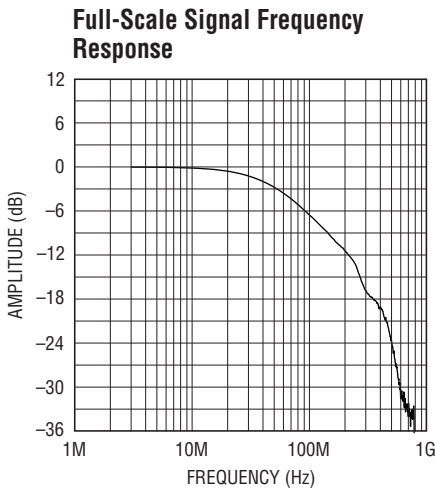

14071 G21

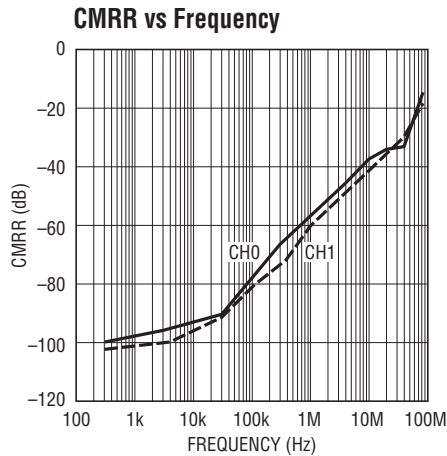

14071 G22

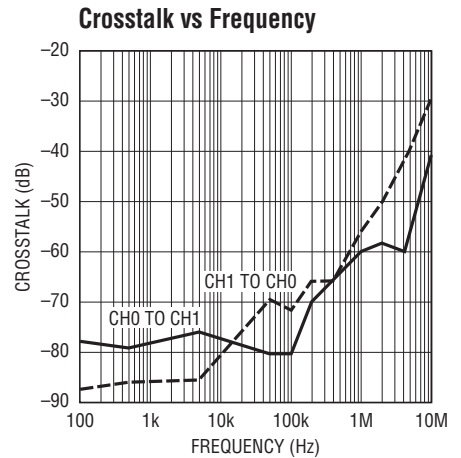

14071 G23

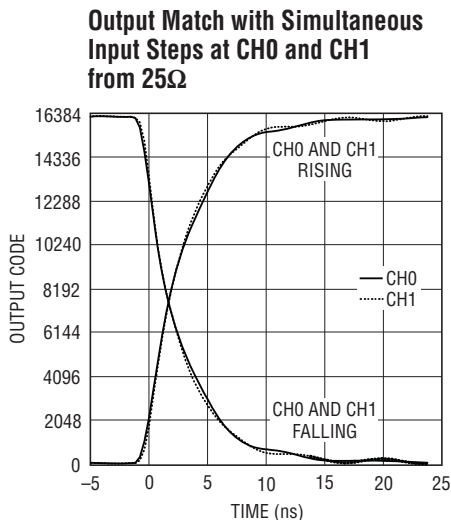

14071 G24

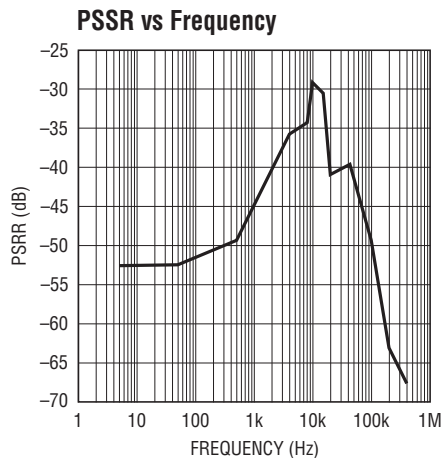

14071 G25

14071fb

TYPICAL PERFORMANCE CHARACTERISTICS $V_{DD} = 3V, T_A = 25^\circ C$ (LTC1407-1/LTC1407A-1)

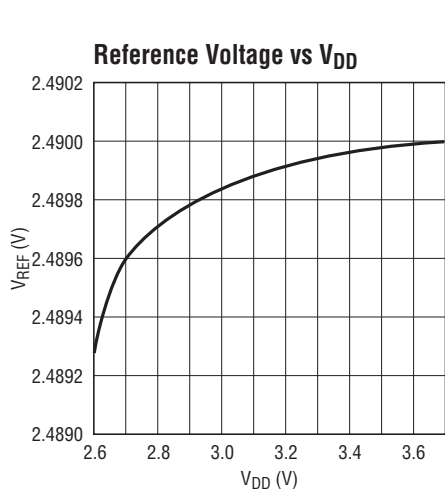

14071 G26

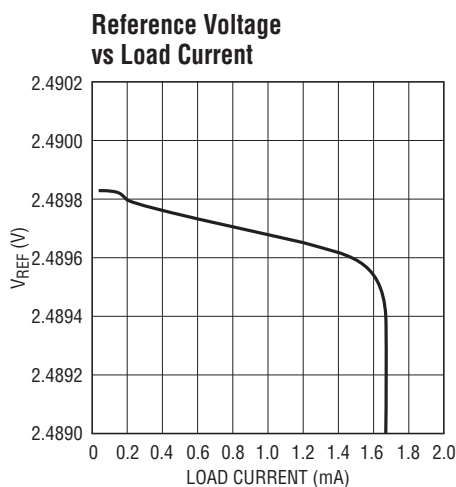

14071 G27

PIN FUNCTIONS

CH0⁺ (Pin 1): Noninverting Channel 0. CH0⁺ operates fully differentially with respect to CH0⁻, with a $-1.25V$ to $1.25V$ differential swing with respect to CH0⁻ and a 0 to V_{DD} absolute input range.

CH0⁻ (Pin 2): Inverting Channel 0. CH0⁻ operates fully differentially with respect to CH0⁺, with a $1.25V$ to $-1.25V$ differential swing with respect to CH0⁺ and a 0 to V_{DD} absolute input range.

V_{REF} (Pin 3): 2.5V Internal Reference. Bypass to GND and a solid analog ground plane with a $10\mu F$ ceramic capacitor (or $10\mu F$ tantalum in parallel with $0.1\mu F$ ceramic). Can be overdriven by an external reference voltage $\geq 2.55V$ and $\leq V_{DD}$.

CH1⁺ (Pin 4): Noninverting Channel 1. CH1⁺ operates fully differentially with respect to CH1⁻, with a $-1.25V$ to $1.25V$ differential swing with respect to CH1⁻ and a 0 to V_{DD} absolute input range.

CH1⁻ (Pin 5): Inverting Channel 1. CH1⁻ operates fully differentially with respect to CH1⁺, with a $1.25V$ to $-1.25V$ differential swing with respect to CH1⁺ and a 0 to V_{DD} absolute input range.

GND (Pins 6, 11): Ground and Exposed Pad. This single ground pin and the Exposed Pad must be tied directly to

the solid ground plane under the part. Keep in mind that analog signal currents and digital output signal currents flow through these connections.

V_{DD} (Pin 7): 3V Positive Supply. This single power pin supplies 3V to the entire chip. Bypass to GND pin and solid analog ground plane with a $10\mu F$ ceramic capacitor (or $10\mu F$ tantalum) in parallel with $0.1\mu F$ ceramic. Keep in mind that internal analog currents and digital output signal currents flow through this pin. Care should be taken to place the $0.1\mu F$ bypass capacitor as close to Pins 6 and 7 as possible.

SDO (Pin 8): Three-State Serial Data Output. Each pair of output data words represent the two analog input channels at the start of the previous conversion. The output format is 2's complement.

SCK (Pin 9): External Clock Input. Advances the conversion process and sequences the output data on the rising edge. One or more pulses wake from sleep.

CONV (Pin 10): Convert Start. Holds the two analog input signals and starts the conversion on the rising edge. Two pulses with SCK in fixed high or fixed low state starts nap mode. Four or more pulses with SCK in fixed high or fixed low state starts sleep mode.

LTC1407-1/LTC1407A-1

BLOCK DIAGRAM

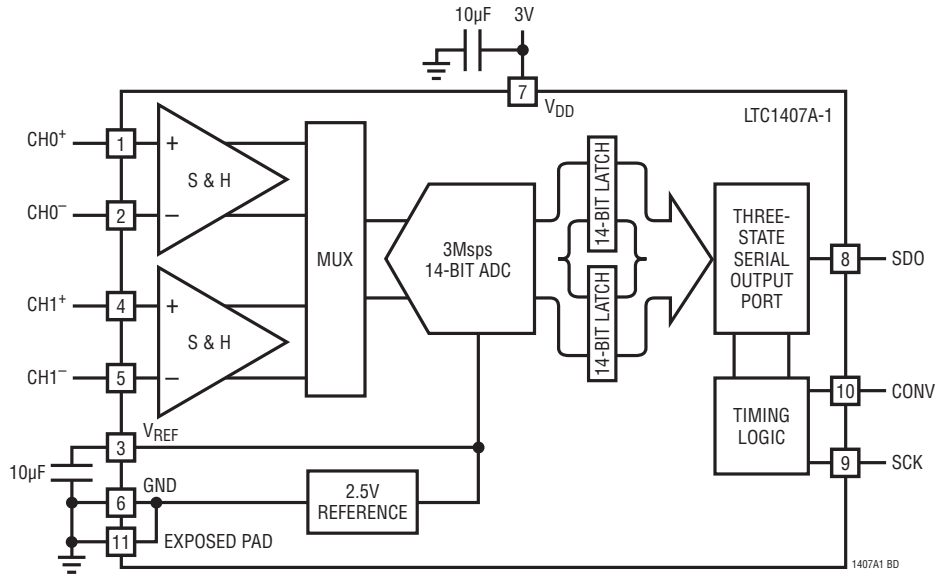

TIMING DIAGRAMS

LTC1407-1 Timing Diagram

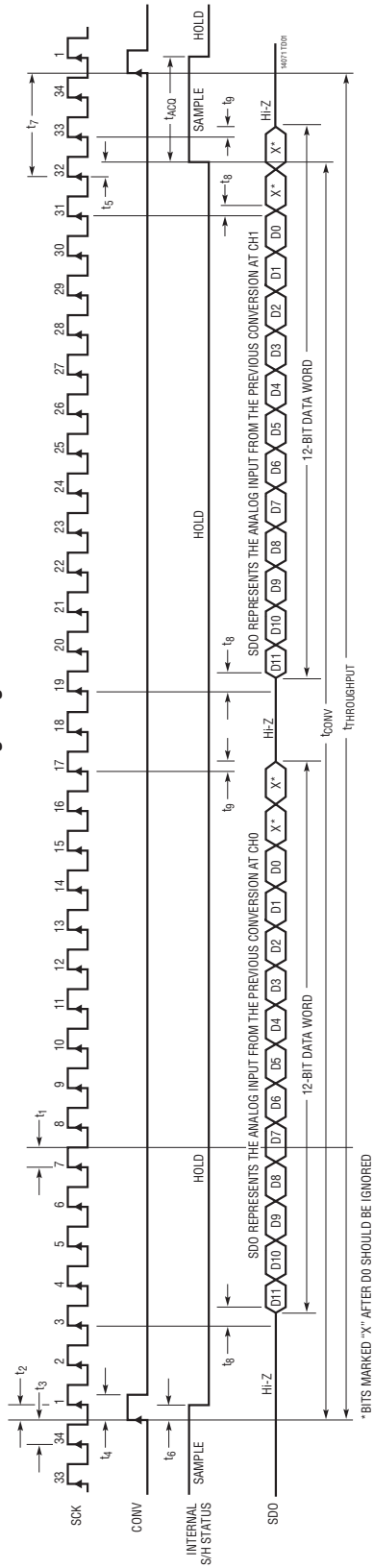

LTC1407A-1 Timing Diagram

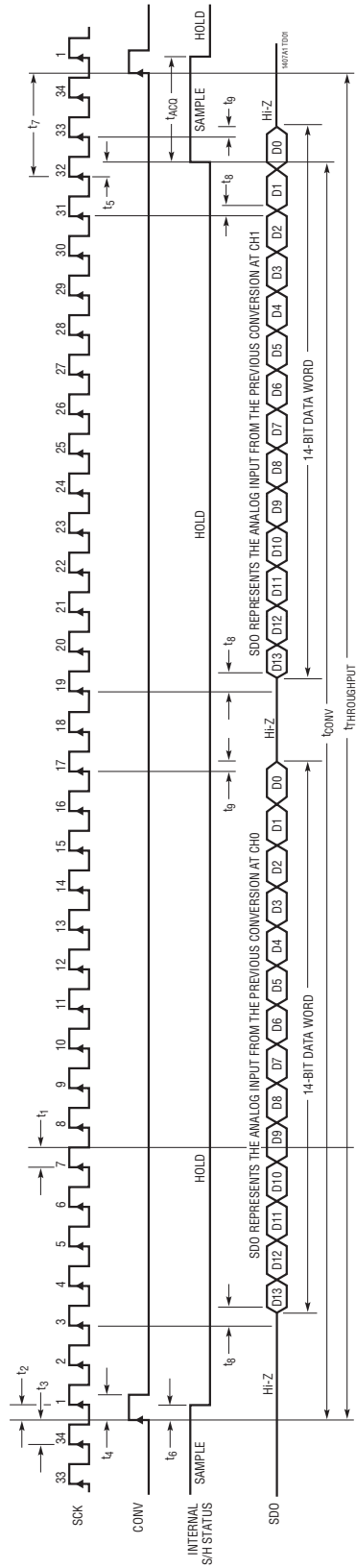

TIMING DIAGRAMS

Nap Mode Waveforms

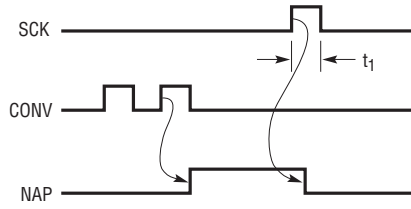

Sleep Mode Waveforms

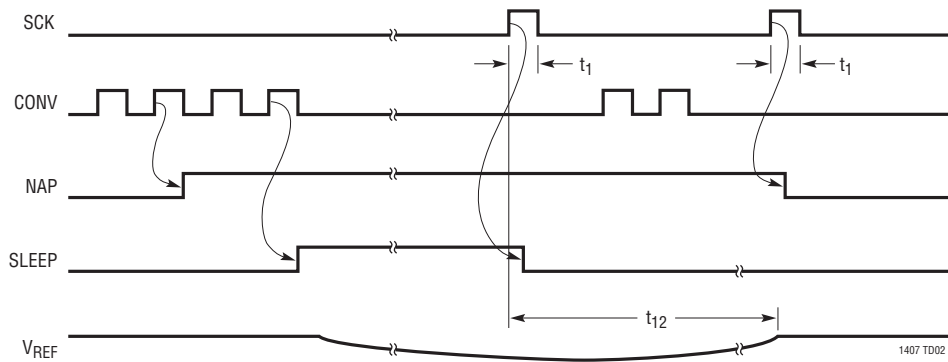

NOTE: NAP AND SLEEP ARE INTERNAL SIGNALS

SCK to SDO Delay

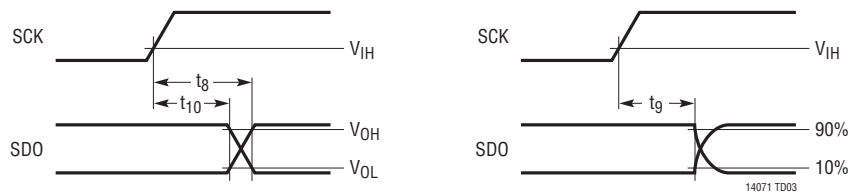

APPLICATIONS INFORMATION

DRIVING THE ANALOG INPUT

The differential analog inputs of the LTC1407-1/LTC1407A-1 are easy to drive. The inputs may be driven differentially or as a single-ended input (i.e., the $CH0^-$ input is AC grounded at $V_{CC}/2$). All four analog inputs of both differential analog input pairs, $CH0^+$ with $CH0^-$ and $CH1^+$ with $CH1^-$, are sampled at the same instant. Any unwanted signal that is common to both inputs of each input pair will be reduced by the common mode rejection of the sample-and-hold circuit. The inputs draw only one small current spike while charging the sample-and-hold capacitors at the end of conversion. During conversion, the analog inputs draw only a small leakage current. If the source impedance of the driving circuit is low, then the LTC1407-1/LTC1407A-1 inputs can be driven directly. As source impedance increases, so will acquisition time. For minimum acquisition time with high source impedance, a buffer amplifier must be used. The main requirement is that the amplifier driving the analog input(s) must settle after the small current spike before the next conversion starts (settling time must be 39ns for full throughput rate). Also keep in mind, while choosing an input amplifier, the amount of noise and harmonic distortion added by the amplifier.

CHOOSING AN INPUT AMPLIFIER

Choosing an input amplifier is easy if a few requirements are taken into consideration. First, to limit the magnitude of the voltage spike seen by the amplifier from charging the sampling capacitor, choose an amplifier that has a low output impedance ($<100\Omega$) at the closed-loop bandwidth frequency. For example, if an amplifier is used in a gain of 1 and has a unity-gain bandwidth of 50MHz, then the output impedance at 50MHz must be less than 100Ω . The second requirement is that the closed-loop bandwidth must be greater than 40MHz to ensure adequate small-signal settling for full throughput rate. If slower op amps are used, more time for settling can be provided by increasing

the time between conversions. The best choice for an op amp to drive the LTC1407-1/LTC1407A-1 depends on the application. Generally, applications fall into two categories: AC applications where dynamic specifications are most critical and time domain applications where DC accuracy and settling time are most critical. The following list is a summary of the op amps that are suitable for driving the LTC1407-1/LTC1407A-1.

LT1566-1: Low Noise 2.3MHz Continuous Time Low-pass Filter.

LT[®]1630: Dual 30MHz Rail-to-Rail Voltage FB Amplifier. 2.7V to $\pm 15V$ supplies. Very high A_{VOL} , 500 μV offset and 520ns settling to 0.5LSB for a 4V swing. THD and noise are $-93dB$ to 40kHz and below 1LSB to 320kHz ($A_V = 1$, 2V_{P-P} into 1k Ω , $V_S = 5V$), making the part excellent for AC applications (to 1/3 Nyquist) where rail-to-rail performance is desired. Quad version is available as LT1631.

LT1632: Dual 45MHz Rail-to-Rail Voltage FB Amplifier. 2.7V to $\pm 15V$ supplies. Very high A_{VOL} , 1.5mV offset and 400ns settling to 0.5LSB for a 4V swing. It is suitable for applications with a single 5V supply. THD and noise are $-93dB$ to 40kHz and below 1LSB to 800kHz ($A_V = 1$, 2V_{P-P} into 1k Ω , $V_S = 5V$), making the part excellent for AC applications where rail-to-rail performance is desired. Quad version is available as LT1633.

LT1801: 80MHz GBWP, $-75dBc$ at 500kHz, 2mA/amplifier, 8.5nV/ \sqrt{Hz} .

LT1806/LT1807: 325MHz GBWP, $-80dBc$ distortion at 5MHz, unity-gain stable, rail-to-rail in and out, 10mA/amplifier, 3.5nV/ \sqrt{Hz} .

LT1810: 180MHz GBWP, $-90dBc$ distortion at 5MHz, unity-gain stable, rail-to-rail in and out, 15mA/amplifier, 16nV/ \sqrt{Hz} .

LinearView is a trademark of Linear Technology Corporation.

APPLICATIONS INFORMATION

LT1818/LT1819: 400MHz, 2500V/μs, 9mA, Single/Dual Voltage Mode Operational Amplifier.

LT6200: 165MHz GBWP, -85dBc distortion at 1MHz, unity-gain stable, rail-to-rail in and out, 15mA/amplifier, 0.95nV/√Hz.

LT6203: 100MHz GBWP, -80dBc distortion at 1MHz, unity-gain stable, rail-to-rail in and out, 3mA/amplifier, 1.9nV/√Hz.

LT6600: Amplifier/Filter Differential In/Out with 10MHz Cutoff.

INPUT FILTERING AND SOURCE IMPEDANCE

The noise and the distortion of the input amplifier and other circuitry must be considered since they will add to the LTC1407-1/LTC1407A-1 noise and distortion. The small-signal bandwidth of the sample-and-hold circuit is 50MHz. Any noise or distortion products that are present at the analog inputs will be summed over this entire bandwidth. Noisy input circuitry should be filtered prior to the analog inputs to minimize noise. A simple 1-pole RC filter is sufficient for many applications. For example, Figure 1 shows a 47pF capacitor from CHO⁺ to ground and a 51Ω source resistor to limit the net input bandwidth to 30MHz. The 47pF capacitor also acts as a charge reservoir for the input sample-and-hold and isolates the ADC input from sampling-glitch sensitive circuitry. High quality capacitors and resistors should be used since these

components can add distortion. NPO and silvermica type dielectric capacitors have excellent linearity. Carbon surface mount resistors can generate distortion from self heating and from damage that may occur during soldering. Metal film surface mount resistors are much less susceptible to both problems. When high amplitude unwanted signals are close in frequency to the desired signal frequency a multiple pole filter is required.

High external source resistance, combined with 13pF of input capacitance, will reduce the rated 50MHz input bandwidth and increase acquisition time beyond 39ns.

INPUT RANGE

The analog inputs of the LTC1407-1/LTC1407A-1 may be driven fully differentially with a single supply. Either input may swing up to 3V, provided the differential swing is no greater than 1.25V. In the valid input range, each input of each channel is always up to ±1.25V away from the other input of each channel. The -1.25V to 1.25V range is also ideally suited for AC-coupled signals in single supply applications. Figure 2 shows how to AC-couple signals in a single supply system without needing a mid-supply 1.5V DC external reference. The DC common mode level is supplied by the previous stage that is already bounded by single supply voltage of the system. The common mode range of the inputs extends from ground to the supply voltage V_{DD}. If the difference between the CHO⁺ and CHO⁻ inputs or the CH1⁺ and CH1⁻ inputs exceeds 1.25V, the output code will stay fixed at zero and all ones, and if this difference goes below -1.25V, the output code will stay fixed at one and all zeros.

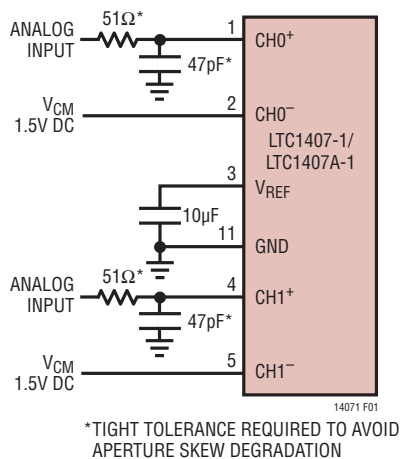

Figure 1. RC Input Filter

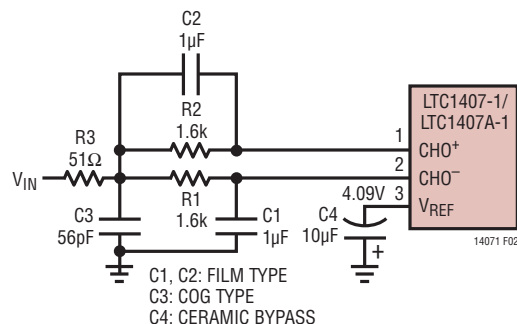

Figure 2. AC Coupling of AC Signals with 1kHz Low Cut

APPLICATIONS INFORMATION

INTERNAL REFERENCE

The LTC1407-1/LTC1407A-1 have an on-chip, temperature compensated, bandgap reference that is factory trimmed near 2.5V to obtain a precise $\pm 1.25V$ input span. The reference amplifier output V_{REF} , (Pin 3) must be bypassed with a capacitor to ground. The reference amplifier is stable with capacitors of $1\mu F$ or greater. For the best noise performance, a $10\mu F$ ceramic or a $10\mu F$ tantalum in parallel with a $0.1\mu F$ ceramic is recommended. The V_{REF} pin can be overdriven with an external reference as shown in Figure 3. The voltage of the external reference must be higher than the 2.5V of the open-drain P-channel output of the internal reference. The recommended range for an external reference is 2.55V to V_{DD} . An external reference at 2.55V will see a DC quiescent load of 0.75mA and as much as 3mA during conversion.

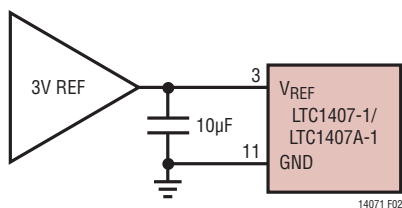

Figure 3

INPUT SPAN VERSUS REFERENCE VOLTAGE

The differential input range has a unipolar voltage span that equals the difference between the voltage at the reference buffer output V_{REF} (Pin 3) and the voltage at the Exposed Pad ground. The differential input range of ADC is $-1.25V$ to $1.25V$ when using the internal reference. The internal ADC is referenced to these two nodes. This relationship also holds true with an external reference.

DIFFERENTIAL INPUTS

The ADC will always convert the bipolar difference of $CH0^+$ minus $CH0^-$ or the bipolar difference of $CH1^+$ minus $CH1^-$, independent of the common mode voltage at either set of inputs. The common mode rejection holds up at high frequencies (see Figure 4). The only requirement is that both inputs not go below ground or exceed V_{DD} . Integral nonlinearity errors (INL) and differential nonlinearity

errors (DNL) are largely independent of the common mode voltage. However, the offset error will vary. CMRR is typically better than 60dB.

Figure 5 shows the ideal input/output characteristics for the LTC1407-1/LTC1407A-1. The code transitions occur midway between successive integer LSB values (i.e., 0.5LSB, 1.5LSB, 2.5LSB, $FS - 1.5LSB$). The output code is 2's complement with $1LSB = 2.5V/16384 = 153\mu V$ for the LTC1407A-1 and $1LSB = 2.5V/4096 = 610\mu V$ for the LTC1407-1. The LTC1407A-1 has 1LSB RMS of Gaussian white noise. Figure 6a shows the LTC1819 converting a single-ended input signal to differential input signals for optimum THD and SFDR performance as shown in the FFT plot (Figure 6b).

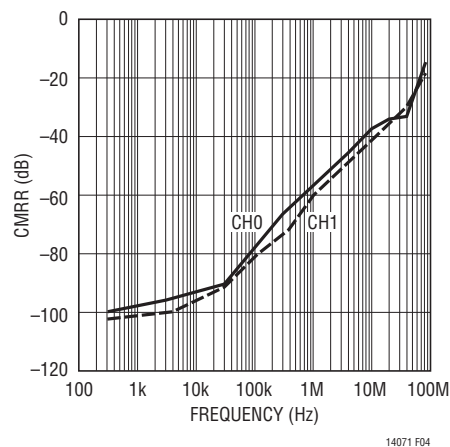

Figure 4. CMRR vs Frequency

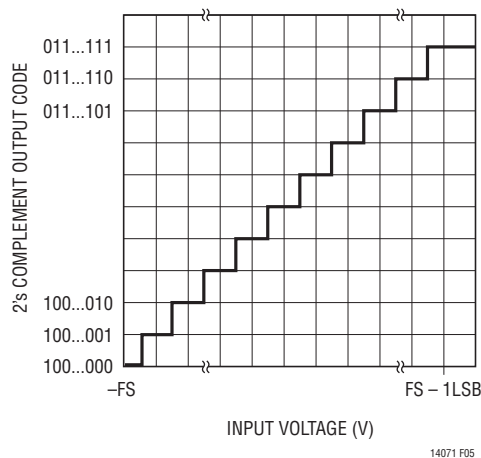

Figure 5. LTC1407-1/LTC1407A-1 Transfer Characteristic

APPLICATIONS INFORMATION

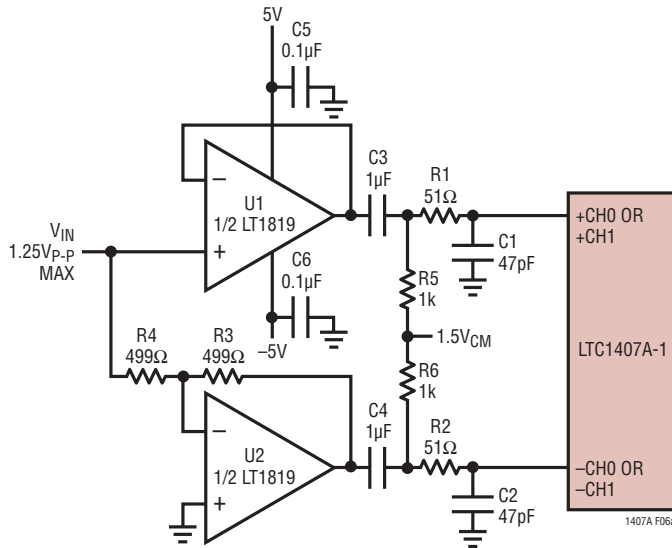

Figure 6a. The LT1819 Driving the LTC1407A-1 Differentially

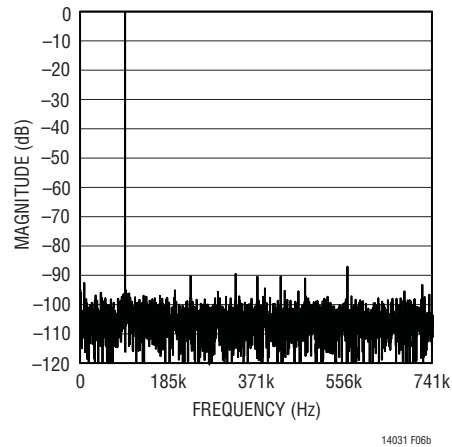

Figure 6b. LTC1407-1 6MHz Sine Wave 4096 Point FFT Plot with the LT1819 Driving the Inputs Differentially

Board Layout and Bypassing

Wire wrap boards are not recommended for high resolution and/or high speed A/D converters. To obtain the best performance from the LTC1407-1/LTC1407A-1, a printed circuit board with ground plane is required. Layout for the printed circuit board should ensure that digital and analog signal lines are separated as much as possible. In particular, care should be taken not to run any digital track alongside an analog signal track. If optimum phase match between the inputs is desired, the length of the four input wires of the two input channels should be kept matched. But each pair of input wires to the two input channels should be kept separated by a ground trace to avoid high frequency crosstalk between channels.

High quality tantalum and ceramic bypass capacitors should be used at the V_{DD} and V_{REF} pins as shown in the Block Diagram on the first page of this data sheet. For optimum performance, a $10\mu\text{F}$ surface mount tantalum capacitor with a $0.1\mu\text{F}$ ceramic is recommended for the V_{DD} and V_{REF} pins. Alternatively, $10\mu\text{F}$ ceramic chip capacitors such as X5R or X7R may be used. The capacitors must be located as close to the pins as possible. The traces connecting the pins and the bypass capacitors must be kept short and should be made as wide as possible. The V_{DD} bypass capacitor returns to GND (Pin 6) and the V_{REF} bypass capacitor returns to the Exposed Pad ground (Pin 11).

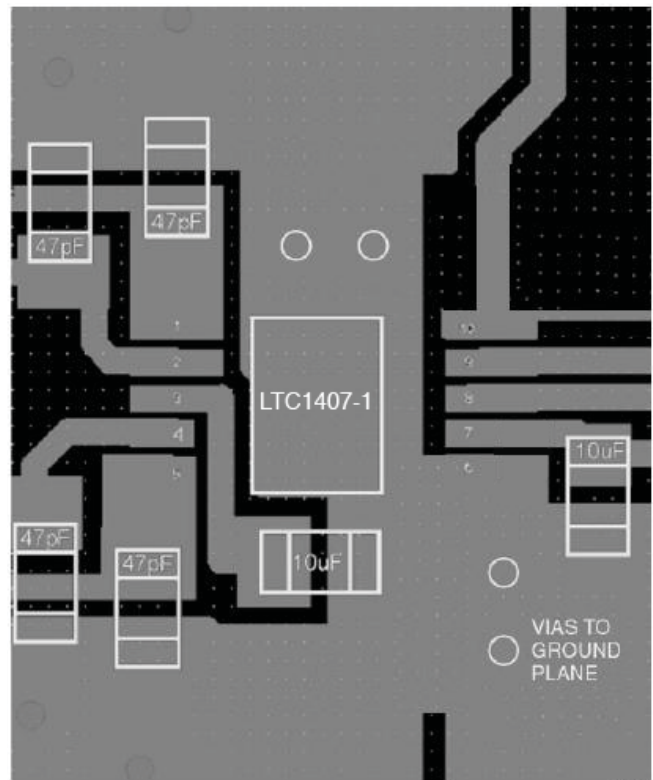

Figure 7. Recommended Layout

Care should be taken to place the $0.1\mu\text{F}$ V_{DD} bypass capacitor as close to Pins 6 and 7 as possible.

Figure 7 shows the recommended system ground connections. All analog circuitry grounds should be terminated

APPLICATIONS INFORMATION

at the LTC1407-1/LTC1407A-1 Exposed Pad. The ground return from the LTC1407-1/LTC1407A-1 Pin 6 to the power supply should be low impedance for noise-free operation. The Exposed Pad of the 10-lead MSE package is also tied to Pin 6 and the LTC1407-1/LTC1407A-1 GND. The Exposed Pad should be soldered on the PC board to reduce ground connection inductance. Digital circuitry grounds must be connected to the digital supply common.

POWER-DOWN MODES

Upon power-up, the LTC1407-1/LTC1407A-1 are initialized to the active state and are ready for conversion. The nap and sleep mode waveforms show the power-down modes for the LTC1407-1/LTC1407A-1. The SCK and CONV inputs control the power-down modes (see Timing Diagrams). Two rising edges at CONV, without any intervening rising edges at SCK, put the LTC1407-1/LTC1407A-1 in nap mode and the power drain drops from 14mW to 6mW. The internal reference remains powered in nap mode. One or more rising edges at SCK wake up the LTC1407-1/LTC1407A-1 for service very quickly and CONV can start an accurate conversion within a clock cycle.

Four rising edges at CONV, without any intervening rising edges at SCK, put the LTC1407-1/LTC1407A-1 in sleep mode and the power drain drops from 14mW to 10 μ W. To bring the part out of sleep mode requires one or more rising SCK edges followed by a nap request. Then one or more rising edges at SCK wake up the LTC1407-1/LTC1407A-1 for operation. When nap mode is entered after sleep mode, the reference that was shut down in sleep mode is reactivated.

The internal reference (V_{REF}) takes 2ms to slew and settle with a 10 μ F load. Using sleep mode more frequently compromises the settled accuracy of the internal reference. Note that for slower conversion rates, the nap and sleep modes can be used for substantial reductions in power consumption.

DIGITAL INTERFACE

The LTC1407-1/LTC1407A-1 have a 3-wire SPI (serial protocol interface) interface. The SCK and CONV inputs and SDO output implement this interface. The SCK and CONV inputs accept swings from 3V logic and are TTL

compatible, if the logic swing does not exceed V_{DD} . A detailed description of the three serial port signals follows:

Conversion Start Input (CONV)

The rising edge of CONV starts a conversion, but subsequent rising edges at CONV are ignored by the LTC1407-1/LTC1407A-1 until the following 32 SCK rising edges have occurred. The duty cycle of CONV can be arbitrarily chosen to be used as a frame sync signal for the processor serial port. A simple approach to generate CONV is to create a pulse that is one SCK wide to drive the LTC1407-1/LTC1407A-1 and then buffer this signal to drive the frame sync input of the processor serial port. It is good practice to drive the LTC1407-1/LTC1407A-1 CONV input first to avoid digital noise interference during the sample-to-hold transition triggered by CONV at the start of conversion. It is also good practice to keep the width of the low portion of the CONV signal greater than 15ns to avoid introducing glitches in the front end of the ADC just before the sample-and-hold goes into hold mode at the rising edge of CONV.

Minimizing Jitter on the CONV Input

In high speed applications where high amplitude sinewaves above 100kHz are sampled, the CONV signal must have as little jitter as possible (10ps or less). The square wave output of a common crystal clock module usually meets this requirement easily. The challenge is to generate a CONV signal from this crystal clock without jitter corruption from other digital circuits in the system. A clock divider and any gates in the signal path from the crystal clock to the CONV input should not share the same integrated circuit with other parts of the system. As shown in the interface circuit examples, the SCK and CONV inputs should be driven first, with digital buffers used to drive the serial port interface. Also note that the master clock in the DSP may already be corrupted with jitter, even if it comes directly from the DSP crystal. Another problem with high speed processor clocks is that they often use a low cost, low speed crystal (i.e., 10MHz) to generate a fast, but jittery, phase-locked-loop system clock (i.e., 40MHz). The jitter in these PLL-generated high speed clocks can be several nanoseconds. Note that if you choose to use the frame sync signal generated by the DSP port, this signal will have the same jitter of the DSP's master clock.

APPLICATIONS INFORMATION

Serial Clock Input (SCK)

The rising edge of SCK advances the conversion process and also updates each bit in the SDO data stream. After CONV rises, the third rising edge of SCK sends out two sets of 12/14 data bits, with the MSB sent first. A simple approach is to generate SCK to drive the LTC1407-1/LTC1407A-1 first and then buffer this signal with the appropriate number of inverters to drive the serial clock input of the processor serial port. Use the falling edge of the clock to latch data from the serial data output (SDO) into your processor serial port. The 14-bit serial data will be received right justified, in two 16-bit words with 32 or more clocks per frame sync. It is good practice to drive the LTC1407-1/LTC1407A-1 SCK input first to avoid digital noise interference during the internal bit comparison decision by the internal high speed comparator. Unlike the CONV input, the SCK input is not sensitive to jitter because the input signal is already sampled and held constant.

Serial Data Output (SDO)

Upon power-up, the SDO output is automatically reset to the high impedance state. The SDO output remains in high impedance until a new conversion is started. SDO sends out two sets of 12/14 bits in 2's complement format in the output data stream after the third rising edge of SCK after the start of conversion with the rising edge of CONV. The two 12-/14-bit words are separated by two clock cycles in high impedance mode. Please note the delay specification from SCK to a valid SDO. SDO is always guaranteed to

be valid by the next rising edge of SCK. The 32-bit output data stream is compatible with the 16-bit or 32-bit serial port of most processors.

HARDWARE INTERFACE TO TMS320C54x

The LTC1407-1/LTC1407A-1 are serial output ADCs whose interface has been designed for high speed buffered serial ports in fast digital signal processors (DSPs). Figure 8 shows an example of this interface using a TMS320C54X.

The buffered serial port in the TMS320C54x has direct access to a 2kB segment of memory. The ADC's serial data can be collected in two alternating 1kB segments, in real time, at the full 3MSPS conversion rate of the LTC1407-1/LTC1407A-1. The DSP assembly code sets frame sync mode at the BFSR pin to accept an external positive going pulse and the serial clock at the BCLKR pin to accept an external positive edge clock. Buffers near the LTC1407-1/LTC1407A-1 may be added to drive long tracks to the DSP to prevent corruption of the signal to LTC1407-1/LTC1407A-1. This configuration is adequate to traverse a typical system board, but source resistors at the buffer outputs and termination resistors at the DSP, may be needed to match the characteristic impedance of very long transmission lines. If you need to terminate the SDO transmission line, buffer it first with one or two 74ACxx gates. The TTL threshold inputs of the DSP port respond properly to the 3V swing used with the LTC1407-1/LTC1407A-1.

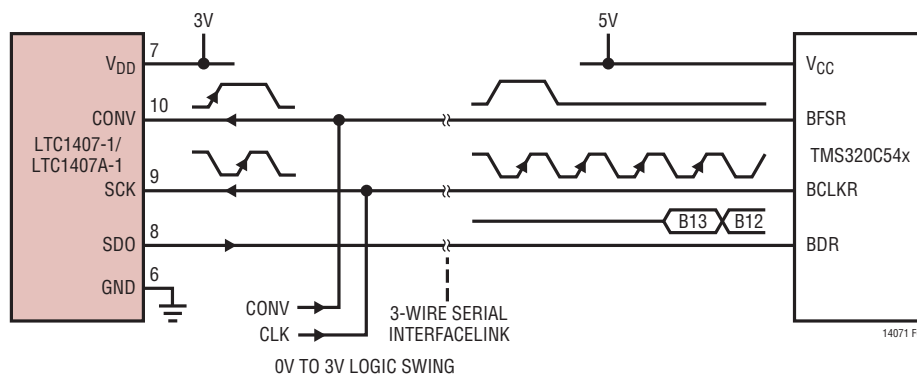

Figure 8. DSP Serial Interface to TMS320C54x

APPLICATIONS INFORMATION

```

; 12-03-03 *****
; Files: 014SIAB.ASM -> 1407A Sine wave collection with Serial Port interface
;         bvectors.asm   both channels collected in sequence in the same 2k record.
;         s2k14ini.asm   Buffered mode 2k buffer size.
; First element at 1024, last element at 1023, two middles at 2047 and 0000
; bipolar mode
; Works 16 or 64 clock frames.
; negative edge BCLKR
; negative BFSR pulse
; -0 data shifted
; *****

        .width 160
        .length 110
        .title "sineb0 BSP in auto buffer mode"
        .mmregs
        .setsect ".text", 0x500,0 ;Set address of executable
        .setsect "vectors", 0x180,0 ;Set address of incoming 1403 data
        .setsect "buffer", 0x800,0 ;Set address of BSP buffer for clearing
        .setsect "result", 0x1800,0 ;Set address of result for clearing
        .text ;.text marks start of code

start:
        ;this label seems necessary
        ;Make sure /PWRDWN is low at J1-9
        ;to turn off AC01 adc

        tim=#0fh
        prd=#0fh
        tcr = #10h ; stop timer
        tspc = #0h ; stop TDM serial port to AC01
        pmst = #01a0h ; set up iptr. Processor Mode SStatus register
        sp = #0700h ; init stack pointer.
        dp = #0 ; data page
        ar2 = #1800h ; pointer to computed receive buffer.
        ar3 = #0800h ; pointer to Buffered Serial Port receive buffer
        ar4 = #0h ; reset record counter
        call sineinit ; Double clutch the initialization to insure a proper
sinepeek:
        call sineinit ; reset. The external frame sync must occur 2.5 clocks
        ; or more after the port comes out of reset.
wait    goto    wait

;    ————— Buffered Receive Interrupt Routine —————

breceive:
        ifr = #10h ; clear interrupt flags
        TC = bitf(@BSPCE,#4000h) ; check which half (bspce(bit14)) of buffer
        if (NTC) goto bufull ; if this still the first half get next half
        bspce = #(2023h + 08000h); turn on halt for second half (bspce(bit15))
        return_enable

```

APPLICATIONS INFORMATION

```

;           _____ mask and shift input data _____
bufull:
    b = *ar3+ << -0           ; load acc b with BSP buffer and shift right -0
    b = #07FFFh & b           ; mask out the TRISTATE bits with #03FFFh
    b = b ^ #2000h           ; invert the MSB for bipolar operation
;
    *ar2+ = data(#0bh)        ; store B to out buffer and advance AR2 pointer
    TC = (@ar2 == #02000h)    ; output buffer is 2k starting at 1800h
    if (TC) goto start        ; restart if out buffer is at lfffh
    goto bufull

;           _____ dummy bsend return _____
bsend  return_enable         ;this is also a dummy return to define bsend
;                                     ;in vector table file BVECTORS.ASM
;           _____ end ISR _____

    .copy "c:\dskplus\1403\s2k14ini.asm"    ;initialize buffered serial port
    .space 16*32                            ;clear a chunk at the end to mark the end

;=====
;
;  VECTORS
;
;=====
    .sect "vectors"                ;The vectors start here
    .copy "c:\dskplus\1403\bvectors.asm"    ;get BSP vectors

    .sect "buffer"                 ;Set address of BSP buffer for clearing
    .space 16*0x800
    .sect "result"                ;Set address of result for clearing
    .space 16*0x800

    .end

; *****
; File: BVECTORS.ASM -> Vector Table for the 'C54x DSKplus          10.Jul.96
;                               BSP vectors and Debugger vectors
;                               TDM vectors just return
; *****
; The vectors in this table can be configured for processing external and
; internal software interrupts. The DSKplus debugger uses four interrupt
; vectors. These are RESET, TRAP2, INT2, and HPIINT.
; * DO NOT MODIFY THESE FOUR VECTORS IF YOU PLAN TO USE THE DEBUGGER *
;
; All other vector locations are free to use. When programming always be sure
; the HPIINT bit is unmasked (IMR=200h) to allow the communications kernel and
; host PC interact. INT2 should normally be masked (IMR(bit 2) = 0) so that the
; DSP will not interrupt itself during a HINT. HINT is tied to INT2 externally.
;
;
;

```

APPLICATIONS INFORMATION

```

        .title "Vector Table"
        .mmregs

reset    goto #80h          ;00; RESET * DO NOT MODIFY IF USING DEBUGGER *
        nop
        nop
nmi      return_enable     ;04; non-maskable external interrupt
        nop
        nop
trap2    goto #88h          ;08; trap2 * DO NOT MODIFY IF USING DEBUGGER *
        nop
        nop
        .space 52*16       ;0C-3F: vectors for software interrupts 18-30
int0     return_enable     ;40; external interrupt int0
        nop
        nop
        nop
int1     return_enable     ;44; external interrupt int1
        nop
        nop
        nop
int2     return_enable     ;48; external interrupt int2
        nop
        nop
        nop
tint     return_enable     ;4C; internal timer interrupt
        nop
        nop
        nop
brint    goto breceive     ;50; BSP receive interrupt
        nop
        nop
        nop
bxint    goto bsend        ;54; BSP transmit interrupt
        nop
        nop
        nop
trint    return_enable     ;58; TDM receive interrupt
        nop
        nop
        nop
txint    return_enable     ;5C; TDM transmit interrupt
        nop
        nop
        nop
int3     return_enable     ;60; external interrupt int3
        nop
        nop
        nop
hpiint   dgoto #0e4h       ;64; HPIint * DO NOT MODIFY IF USING DEBUGGER *
        nop
        nop

```

APPLICATIONS INFORMATION

* 2' cable from counter to CLK at DUT

*No right shift is needed to right justify the input data in the main program

*

*the two msbs should also be masked

*

*

```

Loopback      .set      NO          ;(digital looback mode?)          DLB bit
Format        .set      BIT_16      ;(Data format? 16,12,10,8)          FO bit
IntSync       .set      NO          ;(internal Frame syncs generated?) TXM bit
IntCLK        .set      NO          ;(internal clks generated?)        MCM bit
BurstMode     .set      YES         ;(if BurstMode=NO, then Continuous) FSM bit
CLKDIV        .set      3           ;(3=default value, 1/4 CLOCKOUT)
PCM_Mode      .set      NO          ;(Turn on PCM mode?)
FS_polarity   .set      YES         ;(change polarity)YES=^^^\_/\^^^, NO=___/\^\\___
CLK_polarity  .set      NO          ;(change polarity)for BCLKR YES=_/\^, NO=~\__
Frame_ignore  .set      !YES        ;(inverted !YES -ignores frame)
XMTautobuf    .set      NO          ;(transmit autobuffering)
RCVautobuf    .set      YES         ;(receive autobuffering)
XMThalt       .set      NO          ;(transmit buff halt if XMT buff is full)
RCVhalt       .set      NO          ;(receive buff halt if RCV buff is full)
XMTbufAddr    .set      0x800       ;(address of transmit buffer)
XMTbufSize    .set      0x000       ;(length of transmit buffer)
RCVbufAddr    .set      0x800       ;(address of receive buffer)
RCVbufSize    .set      0x800       ;(length of receive buffer)works up to 800

```

*

* See notes in the 'C54x CPU and Peripherals Reference Guide on setting up

* valid buffer start and length values. Page 9-44

*

*

```

      .eval ((Loopback >> 1)|((Format & 2)<<1)|(BurstMode <<3)|(IntCLK <<4)|(IntSync
<<5)) ,SPCval
      .eval ((CLKDIV)|(FS_polarity <<5)|(CLK_polarity<<6)|((Format &
1)<<7)|(Frame_ignore<<8)|(PCM_Mode<<9)), SPCEval
      .eval (SPCEval|(XMTautobuf<<10)|(XMThalt<<12)|(RCVautobuf<<13)|(RCVhalt<<15)),
SPCEval

```

sineinit:

```

    bspc = #SPCval          ; places buffered serial port in reset
    ifr = #10h              ; clear interrupt flags
    imr = #210h             ; Enable HPINT,enable BRINT0
    intm = 0                ; all unmasked interrupts are enabled.
    bspce = #SPCEval        ; programs BSPCE and ABU
    axr = #XMTbufAddr       ; initializes transmit buffer start address
    bkx = #XMTbufSize       ; initializes transmit buffer size
    arr = #RCVbufAddr       ; initializes receive buffer start address
    bkr = #RCVbufSize       ; initializes receive buffer size
    bspc = #(SPCval | GO)   ; bring buffered serial port out of reset
    return                  ;for transmit and receive because GO=0xC0

```

PACKAGE DESCRIPTION

MSE Package
10-Lead Plastic MSOP
 (Reference LTC DWG # 05-08-1664 Rev C)

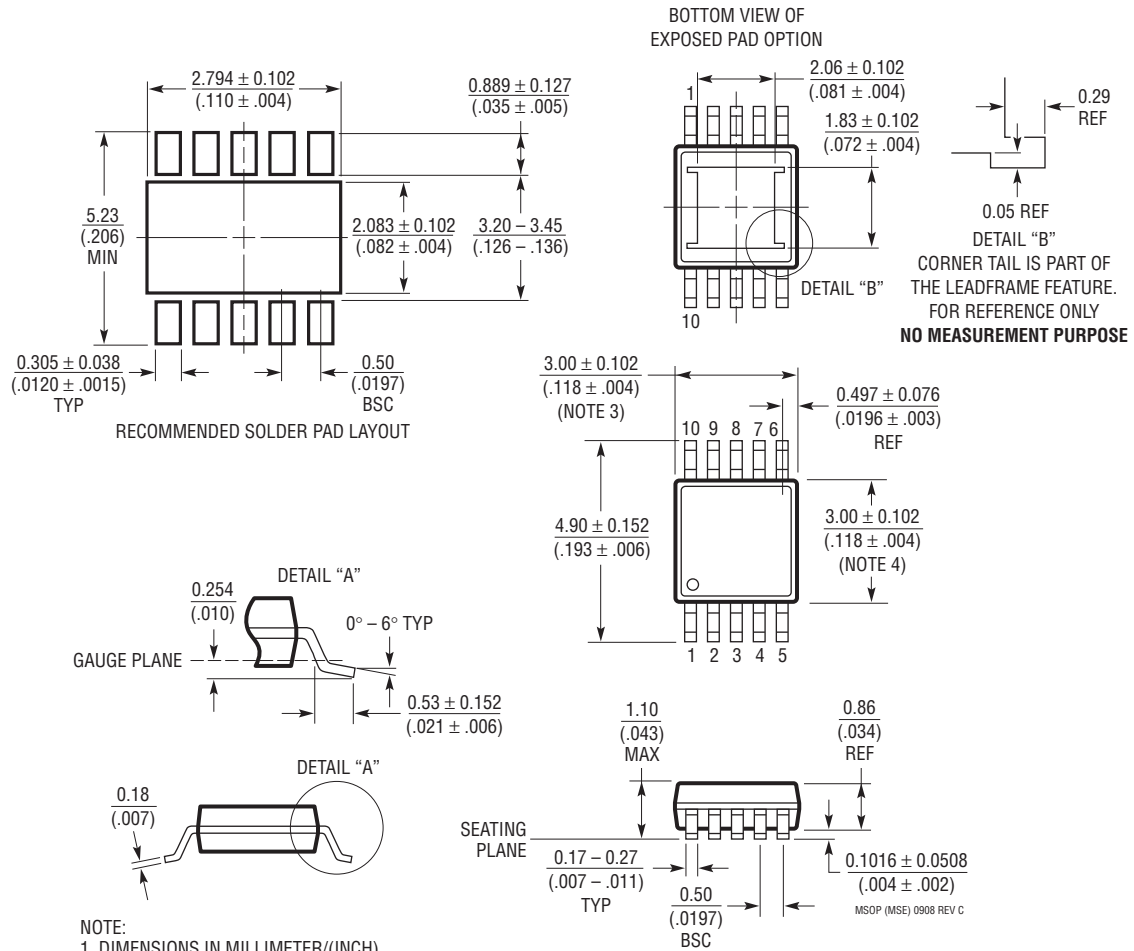

- NOTE:
1. DIMENSIONS IN MILLIMETER/(INCH)
 2. DRAWING NOT TO SCALE
 3. DIMENSION DOES NOT INCLUDE MOLD FLASH, PROTRUSIONS OR GATE BURRS.
MOLD FLASH, PROTRUSIONS OR GATE BURRS SHALL NOT EXCEED 0.152mm (.006") PER SIDE
 4. DIMENSION DOES NOT INCLUDE INTERLEAD FLASH OR PROTRUSIONS.
INTERLEAD FLASH OR PROTRUSIONS SHALL NOT EXCEED 0.152mm (.006") PER SIDE
 5. LEAD COPLANARITY (BOTTOM OF LEADS AFTER FORMING) SHALL BE 0.102mm (.004") MAX

REVISION HISTORY (Revision history begins at Rev B)

REV	DATE	DESCRIPTION	PAGE NUMBER
B	12/09	Update Pin Configuration	2

LTC1407-1/LTC1407A-1

TYPICAL APPLICATION

PART NUMBER	DESCRIPTION	COMMENTS
ADCs		
LTC1608	16-Bit, 500ksps Parallel ADC	±5V Supply, ±2.5V Span, 90dB SINAD
LTC1609	16-Bit, 250ksps Serial ADC	5V Configurable Bipolar/Unipolar Inputs
LTC1403/LTC1403A	12-/14-Bit, 2.8Msps Serial ADC	3V, 15mW, Unipolar Inputs, MSOP Package
LTC1403-1/LTC1403A-1	12-/14-Bit, 2.8Msps Serial ADC	3V, 15mW, Bipolar Inputs, MSOP Package
LTC1407/LTC1407A	12-/14-Bit, 3Msps Simultaneous Sampling ADC	3V, 14mW, 2-Channel Unipolar Input Range
LTC1411	14-Bit, 2.5Msps Parallel ADC	5V, Selectable Spans, 80dB SINAD
LTC1420	12-Bit, 10Msps Parallel ADC	5V, Selectable Spans, 72dB SINAD
LTC1405	12-Bit, 5Msps Parallel ADC	5V, Selectable Spans, 115mW
LTC1412	12-Bit, 3Msps Parallel ADC	±5V Supply, ±2.5V Span, 72dB SINAD
LTC1402	12-Bit, 2.2Msps Serial ADC	5V or ±5V Supply, 4.096V or ±2.5V Span
LTC1864/LTC1865 LTC1864L/LTC1865L	16-Bit, 250ksps 1-/2-Channel Serial ADCs	5V or 3V (L-Version), Micropower, MSOP Package
DACs		
LTC1666/LTC1667 LTC1668	12-/14-/16-Bit, 50Msps DAC	87dB SFDR, 20ns Settling Time
LTC1592	16-Bit, Serial SoftSpan™ I _{OUT} DAC	±1LSB INL/DNL, Software Selectable Spans
References		
LT1790-2.5	Micropower Series Reference in SOT-23	0.05% Initial Accuracy, 10ppm Drift
LT1461-2.5	Precision Voltage Reference	0.04% Initial Accuracy, 3ppm Drift
LT1460-2.5	Micropower Series Voltage Reference	0.10% Initial Accuracy, 10ppm Drift

SoftSpan is a trademark of Linear Technology Corporation.



**Стандарт
Электрон
Связь**

Мы молодая и активно развивающаяся компания в области поставок электронных компонентов. Мы поставляем электронные компоненты отечественного и импортного производства напрямую от производителей и с крупнейших складов мира.

Благодаря сотрудничеству с мировыми поставщиками мы осуществляем комплексные и плановые поставки широчайшего спектра электронных компонентов.

Собственная эффективная логистика и склад в обеспечивает надежную поставку продукции в точно указанные сроки по всей России.

Мы осуществляем техническую поддержку нашим клиентам и предпродажную проверку качества продукции. На все поставляемые продукты мы предоставляем гарантию .

Осуществляем поставки продукции под контролем ВП МО РФ на предприятия военно-промышленного комплекса России , а также работаем в рамках 275 ФЗ с открытием отдельных счетов в уполномоченном банке. Система менеджмента качества компании соответствует требованиям ГОСТ ISO 9001.

Минимальные сроки поставки, гибкие цены, неограниченный ассортимент и индивидуальный подход к клиентам являются основой для выстраивания долгосрочного и эффективного сотрудничества с предприятиями радиоэлектронной промышленности, предприятиями ВПК и научно-исследовательскими институтами России.

С нами вы становитесь еще успешнее!

Наши контакты:

Телефон: +7 812 627 14 35

Электронная почта: sales@st-electron.ru

Адрес: 198099, Санкт-Петербург,
Промышленная ул, дом № 19, литера Н,
помещение 100-Н Офис 331