

NJG1512HD3

■ABSOLUTE MAXIMUM RATINGS

($T_a=25^{\circ}\text{C}$, $Z_s=Z_l=50\Omega$)

PARAMETER	SYMBOL	CONDITIONS	RATINGS	UNITS
Input Power	P_{in}	$V_{CTL}=0V/2.7V$	27	dBm
Control Voltage	V_{CTR}		6.0	V
Power Dissipation	P_D		200	mW
Operating Temp.	T_{opr}		-20~+85	$^{\circ}\text{C}$
Storage Temp.	T_{stg}		-40~+150	$^{\circ}\text{C}$

■ELECTRICAL CHARACTERISTICS

(TEST CIRCUIT : $V_{CTL}=0/2.7V$, $Z_s=Z_o=50\Omega$, $T_a=25^{\circ}\text{C}$)

PARAMETER	SYMBOL	CONDITIONS	MIN	TYP	MAX	UNITS
Control voltage (L)	$V_{CTL(L)}$		-0.2	0	0.2	V
Control voltage (H)	$V_{CTL(H)}$		2.5	2.7	5.5	V
Control current	I_{CTL}		-	2.0	4.0	μA
Insertion loss 1	LOSS1	$f=1.0\text{GHz}$, $P_{in}=0\text{dBm}$	-	0.6	1.0	dB
Insertion loss 2	LOSS2	$f=2.0\text{GHz}$, $P_{in}=0\text{dBm}$	-	1.0	1.2	dB
Isolation 1	ISL1	$f=1.0\text{GHz}$, $P_{in}=0\text{dBm}$	41	44	-	dB
Isolation 2	ISL2	$f=2.0\text{GHz}$, $P_{in}=0\text{dBm}$	41	44	-	dB
Pin at 1dB compression point	$P_{-1\text{dB}}$	$f=2.0\text{GHz}$	19.0	22.0	-	dBm
VSWR	VSWR	$f=0.1\sim 2.5\text{GHz}$, ON STATE	-	1.2	1.8	
Switching time	T_{SW}	$f=0.1\sim 2.5\text{GHz}$	-	8	-	ns

■TERMINAL INFORMATION

No.	SYMBOL	EXPLANATION
1	VCTL2	Control port 2. The voltage of this port controls PC to P1 state. The 'ON' and 'OFF' state is toggled by controlling voltage of this terminal such as high-state (2.5~5.5V) or low-state (-0.2~+0.2V). The voltage of 3rd pin has to be set to opposite state. The bypass capacitor has to be chosen to reduce switching speed delay from 10pF~1000pF range.
2	PC	Common RF port. In order to block the DC bias voltage of internal circuit, an external capacitor is required. (1~500MHz: 1uF, 0.5~2.5GHz: 56pF)
3	VCTL1	Control port 1. The voltage of this port controls PC to P1 state. The 'ON' and 'OFF' state is toggled by controlling voltage of this terminal such as high-state (2.5~5.5V) or low-state (-0.2~+0.2V). The voltage of 1st pin has to be set to opposite state. The bypass capacitor has to be chosen to reduce switching speed delay from 10pF~1000pF range.
4	P1	RF port. This port is connected with PC port by controlling 1st pin ($V_{CTL(H)}$) to 2.5~5.5V and 3rd pin ($V_{CTL(L)}$) to -0.2~+0.2V. An external capacitor is required to block the DC bias voltage of internal circuit. (1~500MHz: 1uF, 0.5~2.5GHz: 56pF)
5	GND	Ground terminal. Please connect this terminal with ground plane as close as possible for excellent RF performance.
6	P2	RF port. This port is connected with PC port by controlling 3rd pin ($V_{CTL(H)}$) to 2.5~5.5V and 1st pin ($V_{CTL(L)}$) to -0.2~+0.2V. An external capacitor is required to block the DC bias voltage of internal circuit. (1~500MHz: 1uF, 0.5~2.5GHz: 56pF)

NJG1512HD3

TYPICAL CHARACTERISTICS

PC-P1 Isolation vs. Frequency
(VCTL1=2.7V, VCTL2=0V, Pin=0dBm)

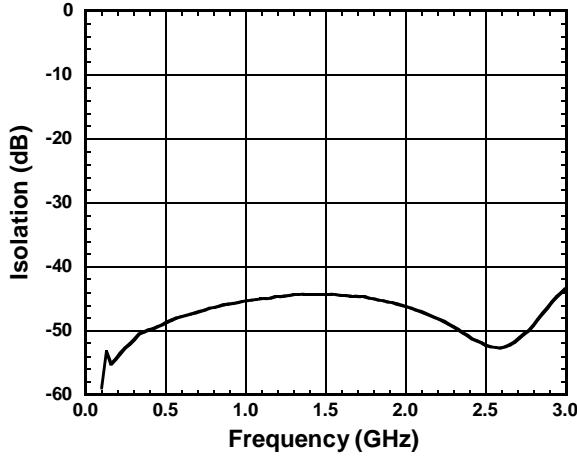

PC-P2 Isolation vs. Frequency
(VCTL1=0V, VCTL2=2.7V, Pin=0dBm)

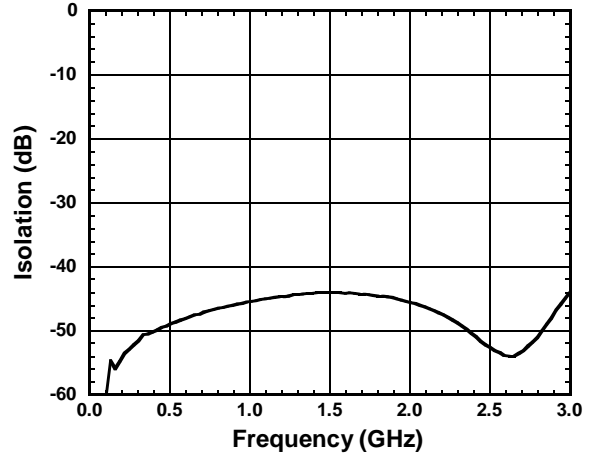

PC-P1 Insetion Loss vs. Frequency
(VCTL1=0V, VCTL2=2.7V, Pin=0dBm)

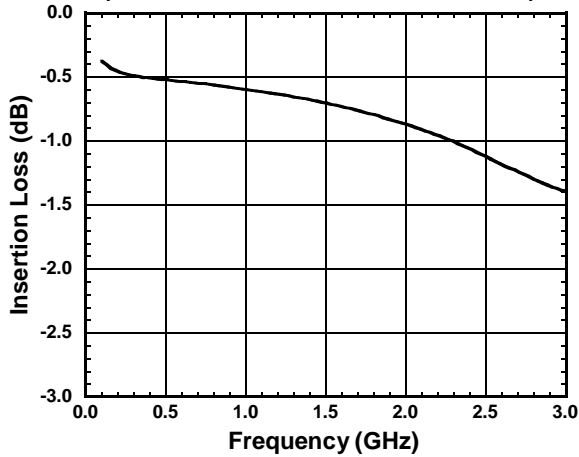

PC-P2 Insetion Loss vs. Frequency
(VCTL1=2.7V, VCTL2=0V, Pin=0dBm)

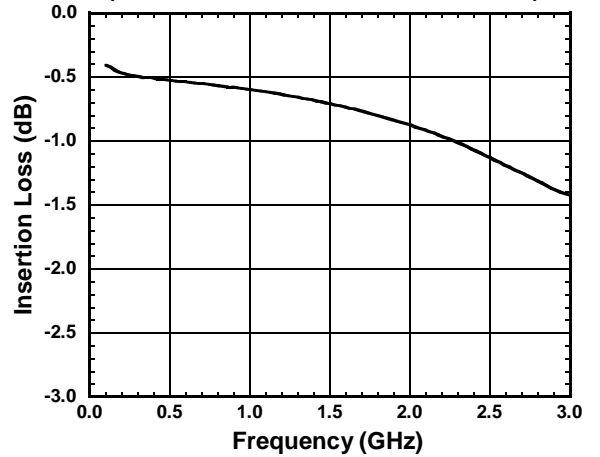

P1 VSWR vs. Frequency

(VCTL1=0V, VCTL2=2.7V, Pin=0dBm)

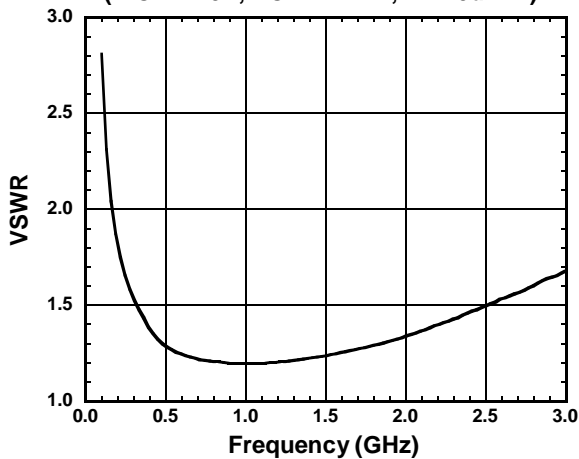

P2 VSWR vs. Frequency

(VCTL1=2.7V, VCTL2=0V, Pin=0dBm)

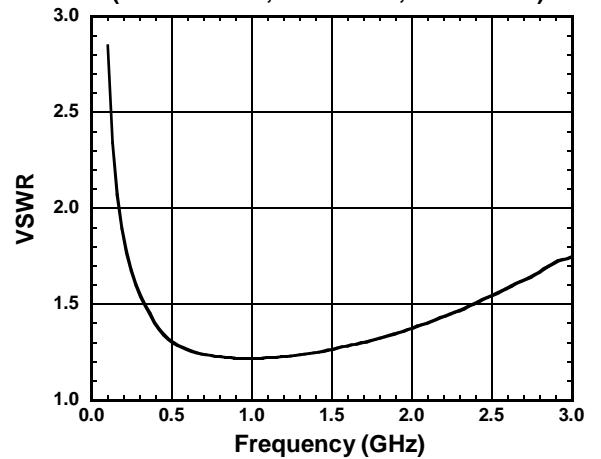

TYPICAL CHARACTERISTICS

Insertion Loss vs. Input Power

(VCTL=0V/2.7V, f=2GHz)

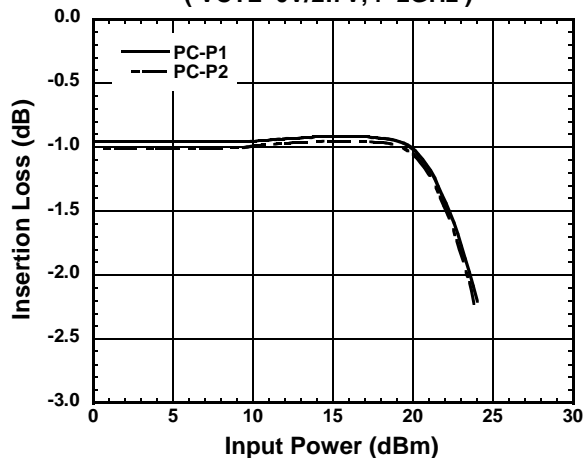

Isolation vs. Input Power

(VCTL=0V/2.7V, f=2GHz)

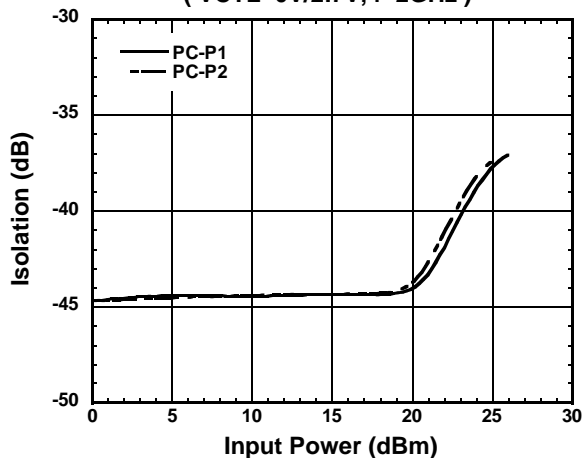

PC-P1 Isolation vs. Ambient Temperature

(f=2GHz, Pin=0dBm, VCTL1=2.7V, VCTL2=0V)

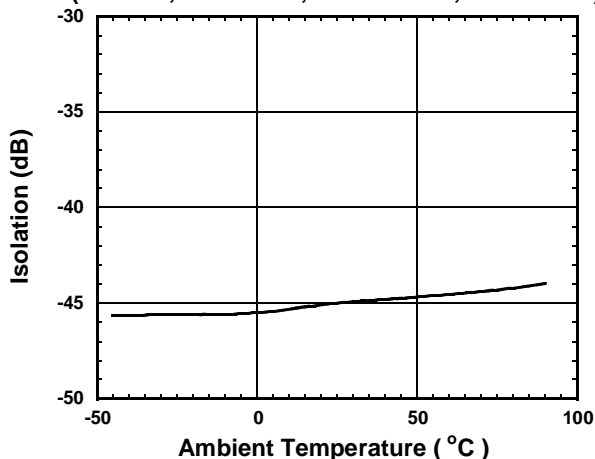

PC-P2 Isolation vs. Ambient Temperature

(f=2GHz, Pin=0dBm, VCTL1=0V, VCTL2=2.7V)

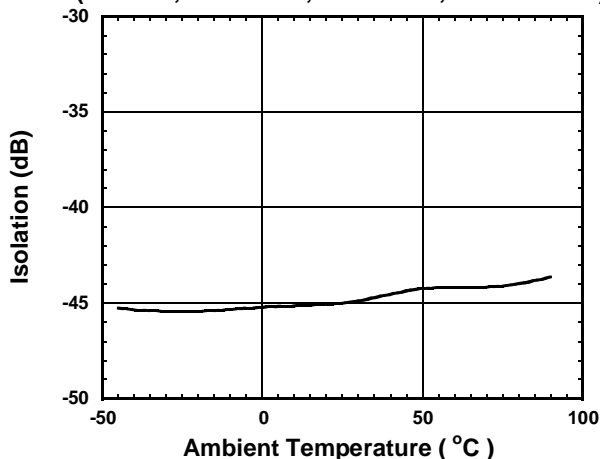

PC-P1 Loss vs. Ambient Temperature

(f=2GHz, Pin=0dBm, VCTL1=0V, VCTL2=2.7V)

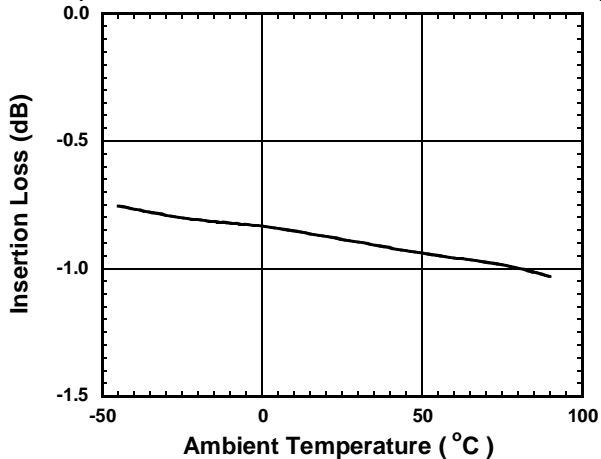

PC-P2 Loss vs. Ambient Temperature

(f=2GHz, Pin=0dBm, VCTL1=2.7V, VCTL2=0V)

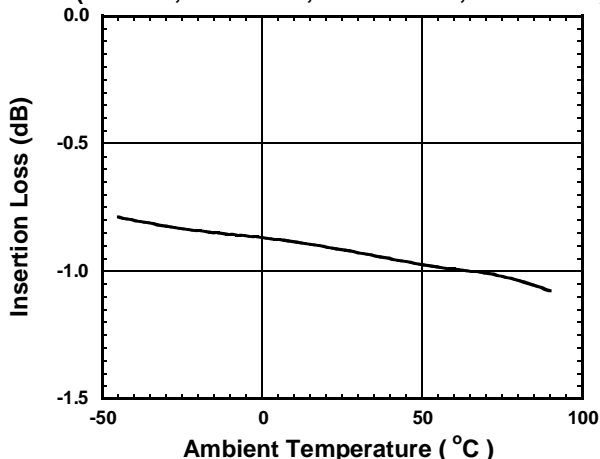

NJG1512HD3

TYPICAL CHARACTERISTICS

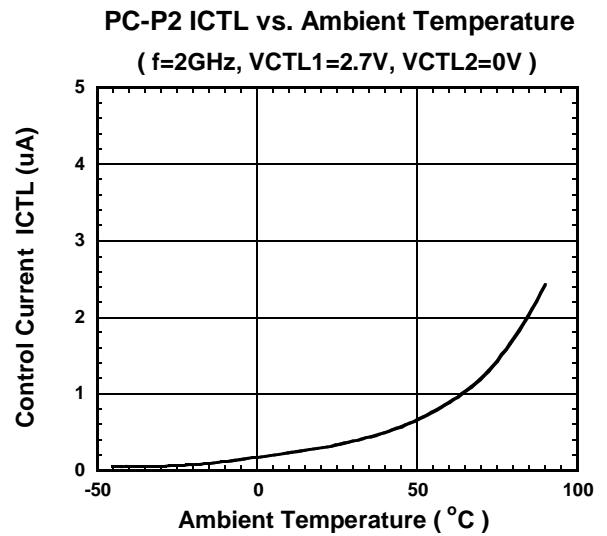
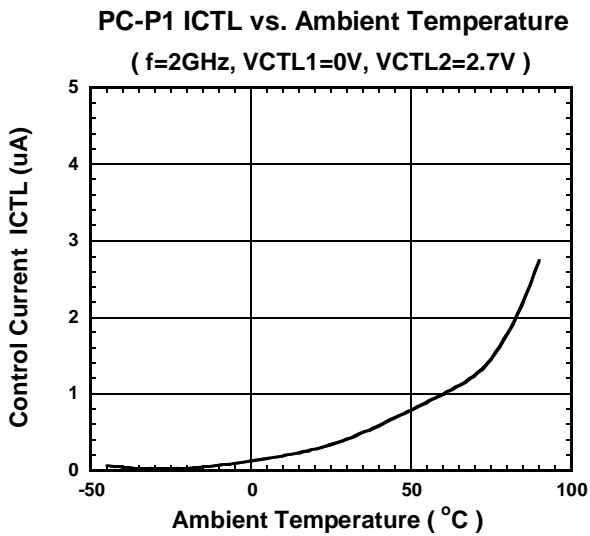
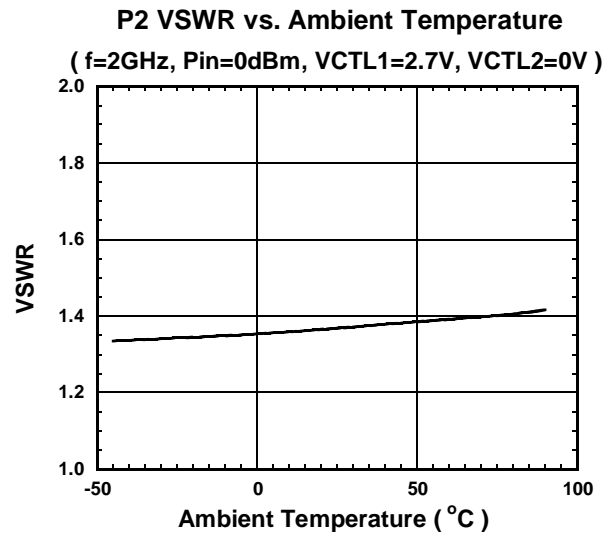
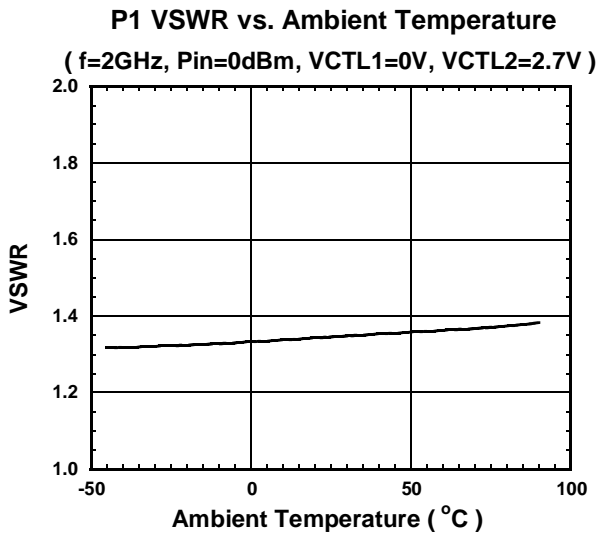

TYPICAL CHARACTERISTICS

PC-P1 Isolation vs. Ambient Temperature
(f=1GHz, Pin=0dBm, VCTL1=2.7V, VCTL2=0V)

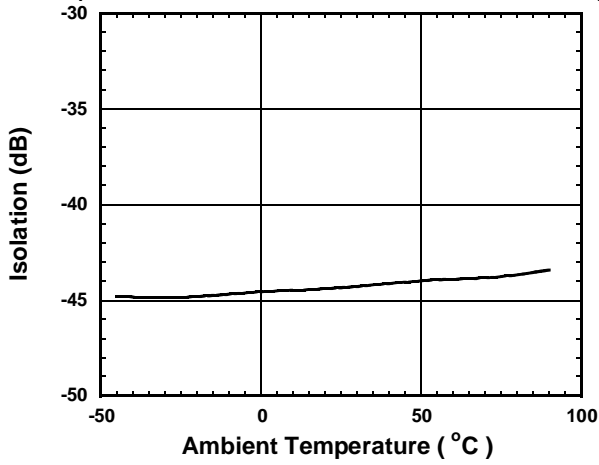

PC-P2 Isolation vs. Ambient Temperature
(f=1GHz, Pin=0dBm, VCTL1=0V, VCTL2=2.7V)

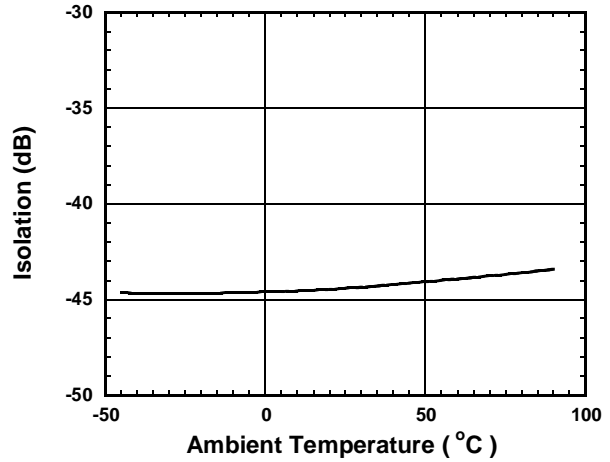

PC-P1 Loss vs. Ambient Temperature
(f=1GHz, Pin=0dBm, VCTL1=0V, VCTL2=2.7V)

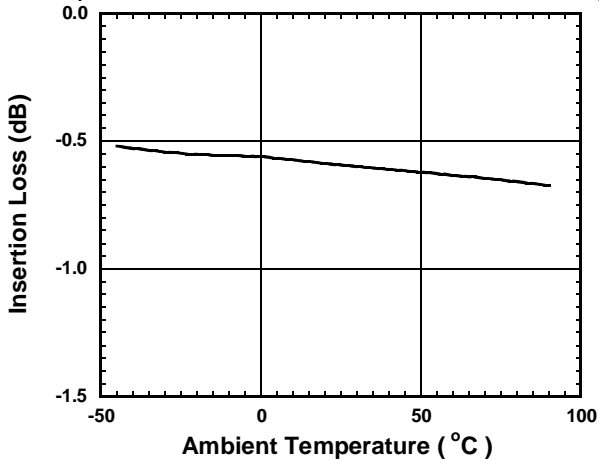

PC-P2 Loss vs. Ambient Temperature
(f=1GHz, Pin=0dBm, VCTL1=2.7V, VCTL2=0V)

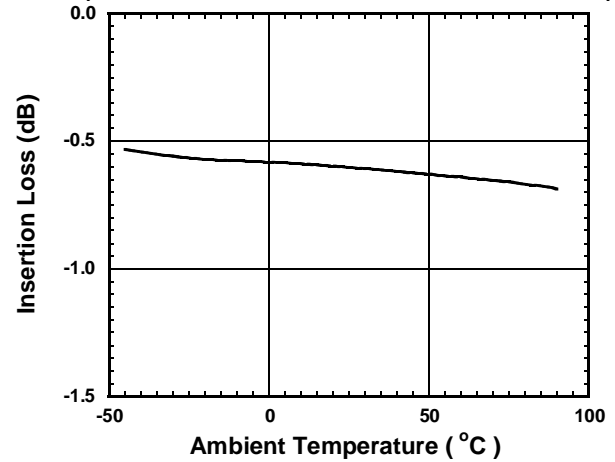

P1 VSWR vs. Ambient Temperature
(f=1GHz, Pin=0dBm, VCTL1=0V, VCTL2=2.7V)

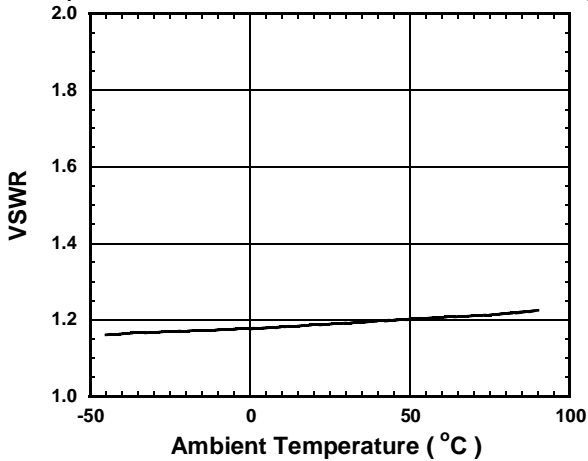

P2 VSWR vs. Ambient Temperature
(f=1GHz, Pin=0dBm, VCTL1=2.7V, VCTL2=0V)

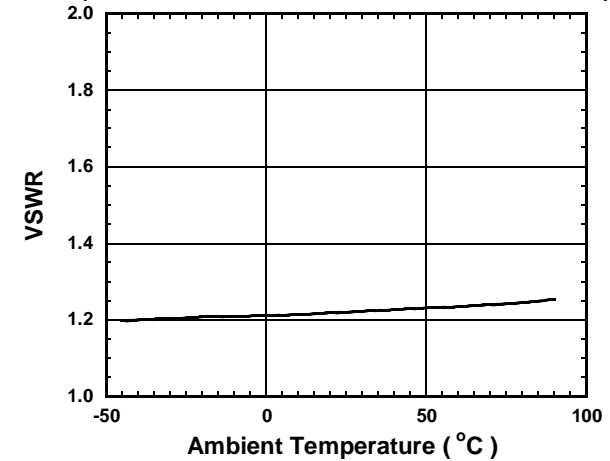

NJG1512HD3

■APPLICATION CIRCUIT: Single control signal operation by using C-MOS inverter
(frequency range: 0.1~2.0GHz)

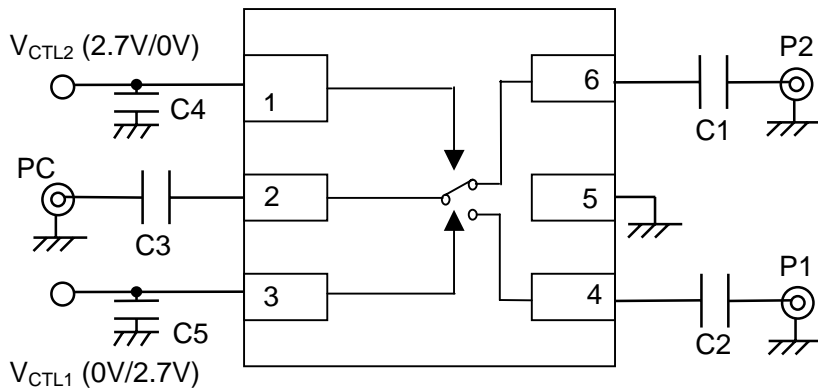

	Test circuit 1 0.5~2GHz	Test circuit 2 1~500MHz
C1~C3	56pF	0.1uF
C4, C5	10pF	1000pF

■RECOMMENDED PCB DESIGN

(TOP VIEW)

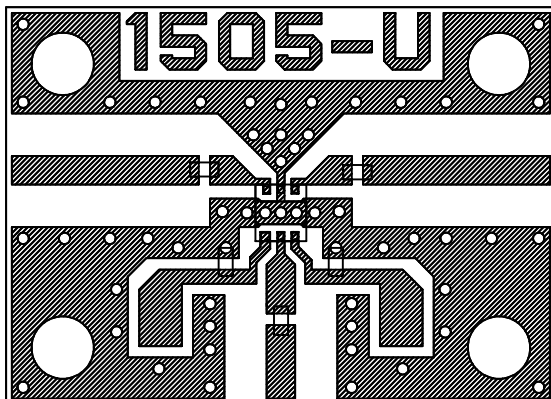

PCB SIZE=19.4x14.0mm
PCB: FR-4, t=0.5mm
STRIPLINE WIDTH =1mm
CAPACITOR: size 1005

PRECAUTIONS

- [1] The external capacitors should be connected to the input and output RF terminals (P₁, P₂, P_C) to block DC current. Please use a 0.1uF capacitor at 1 to 500MHz, a 56pF at 500MHz to 2.0GHz.
- [2] To avoid coupling between terminals, the capacitors have to be placed at the control terminals (V_{CTR1}, V_{CTR2}) as close as possible. The capacitor values of 1000pF at 1 to 500MHz, 10pF at 500MHz to 2GHz are desired. In general, the switching time is depending on the capacitor values, so please be careful choosing capacitor values.
- [3] For good isolation characteristics, the ground terminals (5pin) should be directly connected to the ground patterns and through-holes as close as possible using relatively wide patterns.

■ PACKAGE OUTLINE (USB10-D3)

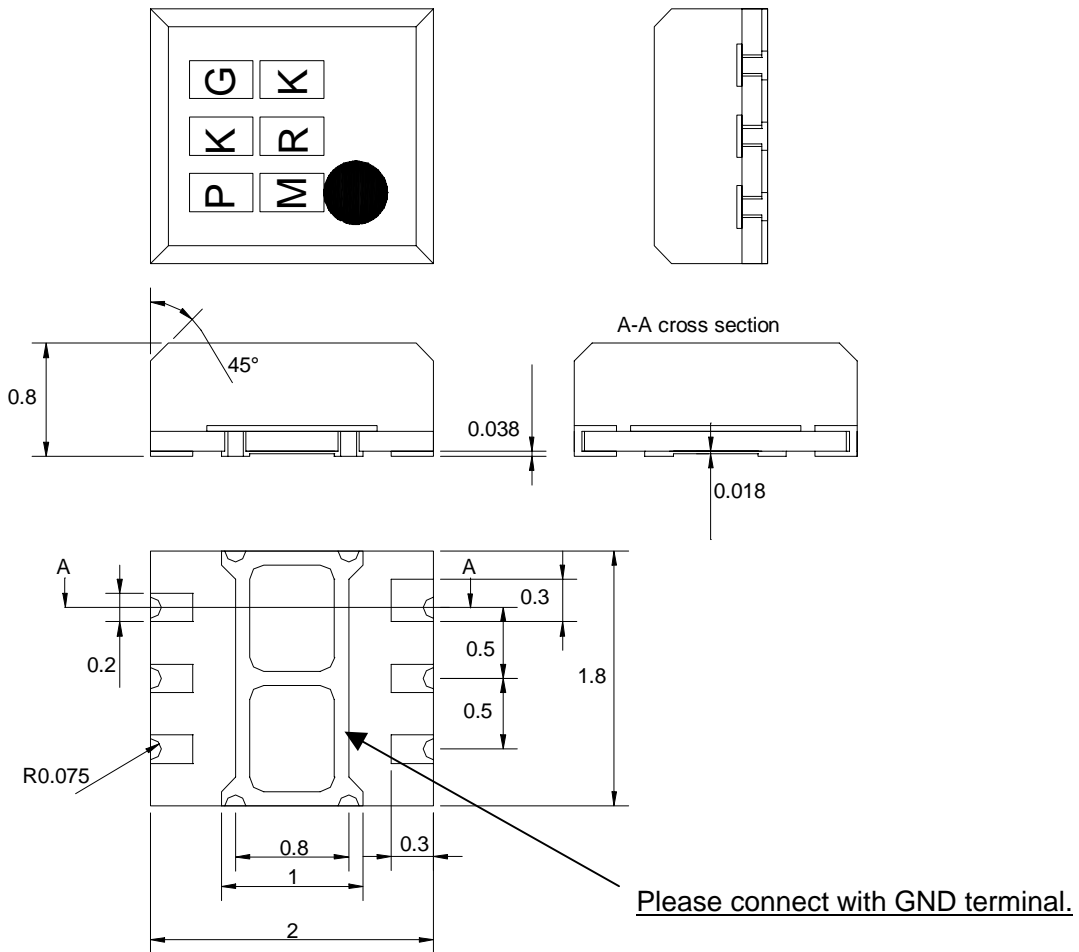

TERMINAL TREAT :Au
 PCB :FR5
 Molding material : Epoxy resin
 UNIT :mm
 WEIGHT :13mg

Cautions on using this product

This product contains Gallium-Arsenide (GaAs) which is a harmful material.

- Do NOT eat or put into mouth.
- Do NOT dispose in fire or break up this product.
- Do NOT chemically make gas or powder with this product.
- To waste this product, please obey the relating law of your country.

This product may be damaged with electric static discharge (ESD) or spike voltage. Please handle with care to avoid these damages.

[CAUTION]

The specifications on this databook are only given for information, without any guarantee as regards either mistakes or omissions. The application circuits in this databook are described only to show representative usages of the product and not intended for the guarantee or permission of any right including the industrial rights.

Mouser Electronics

Authorized Distributor

Click to View Pricing, Inventory, Delivery & Lifecycle Information:

[NJR:](#)

[NJG1512HD3-TE1](#)



Стандарт Электрон Связь

Мы молодая и активно развивающаяся компания в области поставок электронных компонентов. Мы поставляем электронные компоненты отечественного и импортного производства напрямую от производителей и с крупнейших складов мира.

Благодаря сотрудничеству с мировыми поставщиками мы осуществляем комплексные и плановые поставки широчайшего спектра электронных компонентов.

Собственная эффективная логистика и склад в обеспечивает надежную поставку продукции в точно указанные сроки по всей России.

Мы осуществляем техническую поддержку нашим клиентам и предпродажную проверку качества продукции. На все поставляемые продукты мы предоставляем гарантию .

Осуществляем поставки продукции под контролем ВП МО РФ на предприятия военно-промышленного комплекса России , а также работаем в рамках 275 ФЗ с открытием отдельных счетов в уполномоченном банке. Система менеджмента качества компании соответствует требованиям ГОСТ ISO 9001.

Минимальные сроки поставки, гибкие цены, неограниченный ассортимент и индивидуальный подход к клиентам являются основой для выстраивания долгосрочного и эффективного сотрудничества с предприятиями радиоэлектронной промышленности, предприятиями ВПК и научно-исследовательскими институтами России.

С нами вы становитесь еще успешнее!

Наши контакты:

Телефон: +7 812 627 14 35

Электронная почта: sales@st-electron.ru

Адрес: 198099, Санкт-Петербург,
Промышленная ул, дом № 19, литера Н,
помещение 100-Н Офис 331