



# Mains Filters

Designed to reduce conducted mains borne EMI, this extensive range provides many solutions to EMI problems. To meet individual design requirements the filters are available with two attenuation options – standard and medical. Current ratings are from 1 to 10 amps with single or twin fused types also available.

The choice of mounting options will suit most applications with flange, snap to panel or base/bulkhead.

Type	Page
<b>Flange and Snap Fit</b>	
PS00 Series	132-135
PS01 Series	132-135
<b>Base Mounting and Bulkhead</b>	
PS02 Series	136-139
PS03 Series	139-139
<b>Fused Inlets</b>	
PS20 Series	140-141
PS21 Series	140-141
PS25 Series	142-145
PS26 Series	142-145

IEC Power Inlets Flange and Snap Fit

PANEL MOUNTING



Flange PS00/A

- 1, 3, 6 or 10 Amp Current Rating
- 3 Alternative Circuits
- Optional Additional Components
- 2.8 or 6.3mm tabs

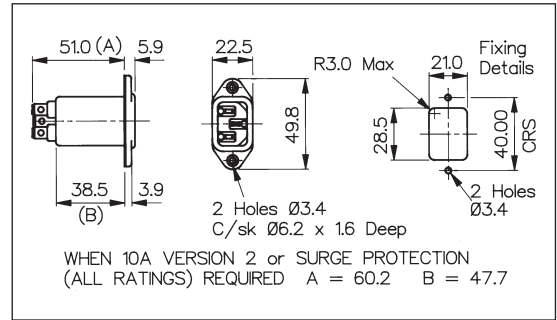

SNAP FIT



Snap Fit PS01/A

- 1, 3, 6 or 10 Amp Current Rating
- 3 Alternative Circuits
- Optional Additional Components
- 2.8 or 6.3mm tabs
- 1, 1.5, 2 or 3mm panels

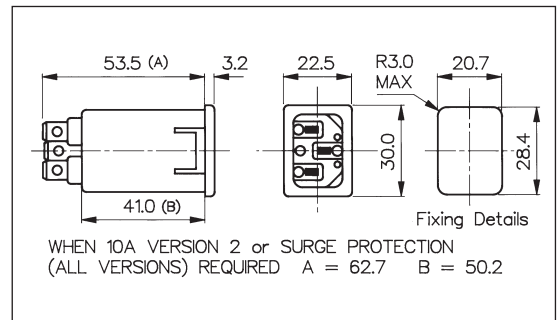

PS00 or PS01/Axx xx /xx xx

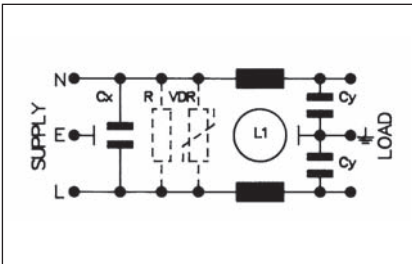

Series	Rating	L/C Circuit	Additional Components	Tag Type and Configuration	Panel Thickness
PS00/A	01 = 1A	1 = Version 1	0 = None	28 = 2.8mm	00 = Flange
PS01/A	03 = 3A	2 = Version 2	1 = Bleed (R) Resistor	63 = 6.3mm tabs	10 = 1.0mm
	06 = 6A	3 = Version 3	2 = Surge (VDR) Protection		15 = 1.5mm
	10 = 10A		3 = "R" plus "VDR"		20 = 2.0mm
					30 = 3.0mm

Specification	PS00/Axxxx/xx00	PS01/Axxxx/xxxx	Part No. Example
Max. Working Voltage:	250V a.c. 50-400Hz	250V a.c. 50-400Hz	<b>PS00/A0120/6300 =</b> PS00 series, flange fitting, standard filtered IEC power inlet, rated at 1 ampere. L/C circuit version 2, i.e. L1 = 2 x 10mH, Cx = 15nF, Cy = 2 x 2.2nF, without bleed resistor or surge protection device fitted, with 6.3mm tabs.
Earth Leakage Current:	<0.35mA (250V, 50Hz)	<0.35mA (250V, 50Hz)	
Temperature Range:	-25°C to +85°C	-25°C to +85°C	
Max. Ambient Temp.: (@ Full Load)	40°C (derate linearly to 0A @ 85°C)	40°C (derate linearly to 0A @ 85°C)	
Test Voltage:	2700V d.c. 2 secs. Lines to Earth 1100V d.c. 2 secs. Live to Neutral	2700V d.c. 2 secs. Lines to Earth 1100V d.c. 2 secs. Live to Neutral	
Approvals:			
Mating Connectors:	PX0587, PX0587/SE, PX0588	PX0587, PX0587/SE, PX0588	
<b>RoHS</b>	Compliant	Compliant	

**Rating & Version Table**

**PS00/Axxxx/xx00 & PS01/Axxxx/xxxx**

Rating	Version	L1	Cx	Cy
1 AMP	1	2 x 2.8mH	1 x 15nF	2 x 2.2nF
	2	2 x 10mH	1 x 15nF	2 x 2.2nF
	3	2 x 10mH	1 x 47nF	2 x 2.2nF
3 AMP	1	2 x 0.75mH	1 x 15nF	2 x 2.2nF
	2	2 x 1.8mH	1 x 15nF	2 x 2.2nF
	3	2 x 1.8mH	1 x 47nF	2 x 2.2nF
6 AMP	1	2 x 0.3mH	1 x 15nF	2 x 2.2nF
	2	2 x 0.7mH	1 x 15nF	2 x 2.2nF
	3	2 x 0.7mH	1 x 47nF	2 x 2.2nF
10 AMP	1	2 x 0.17mH	1 x 15nF	2 x 2.2nF
	2	2 x 0.35mH	1 x 15nF	2 x 2.2nF
	3	2 x 0.17mH	1 x 47nF	2 x 2.2nF

**Version 1**

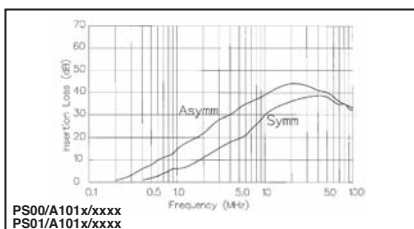
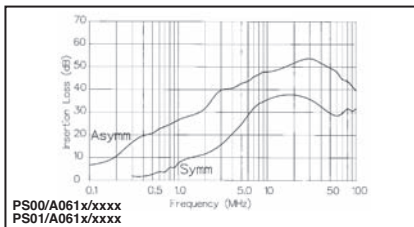
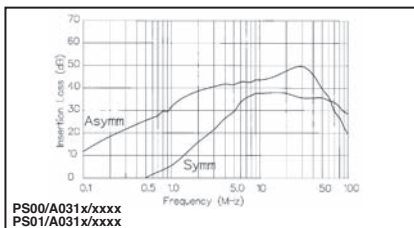
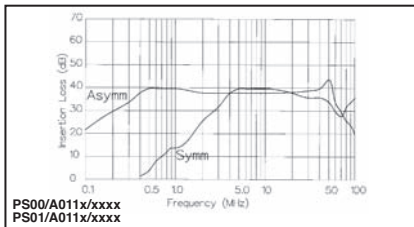

**Version 2**

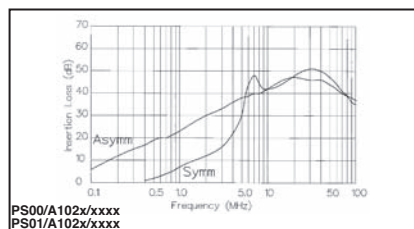
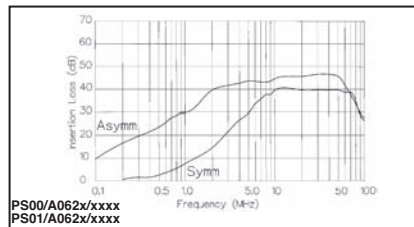
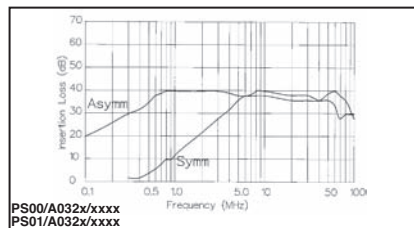
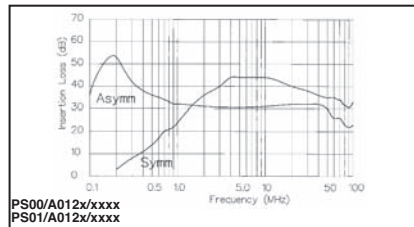

**Version 3**

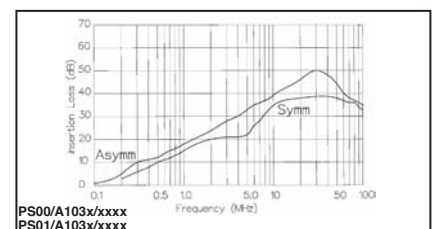
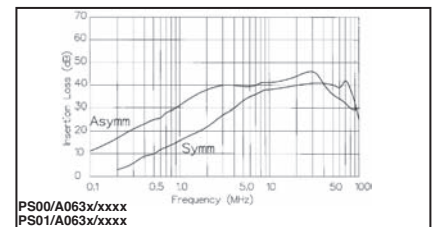
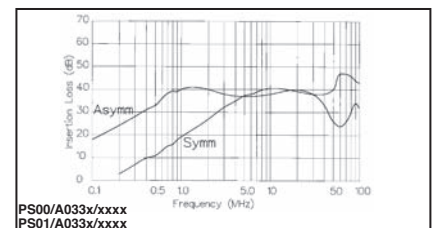
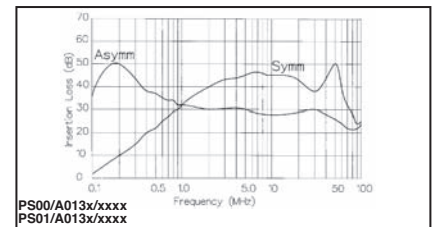

Medical IEC Power Inlets Flange and Snap Fit

PANEL MOUNTING



Flange PS00/B

- 1, 3, 6 or 10 Amp Current Rating
- Medical
- 3 Alternative Circuits
- Optional Additional Components
- 2.8 or 6.3mm tabs

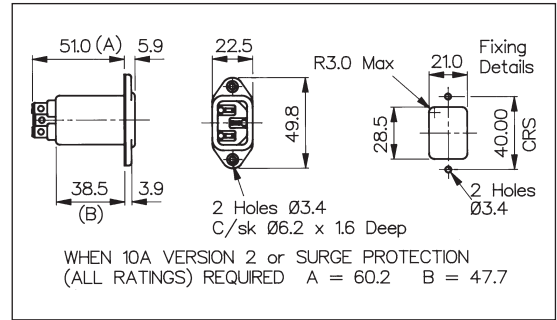

SNAP FIT



Snap Fit PS01/B

- 1, 3, 6 or 10 Amp Current Rating
- Medical
- 3 Alternative Circuits
- Optional Additional Components
- 2.8 or 6.3mm tabs
- 1, 1.5, 2 or 3mm panels

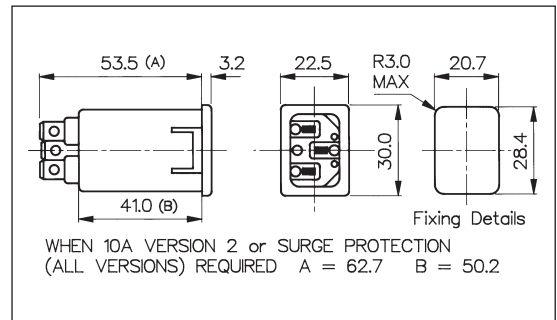

PS00 or PS01/Bxx xx /xx xx

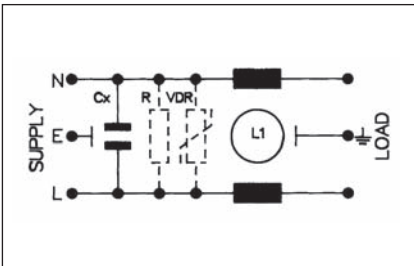

Series	Rating	L/C Circuit	Additional Components	Tag Type and Configuration	Panel Thickness
PS00/B	01 = 1A	1 = Version 1	0 = None	28 = 2.8mm	00 = Flange
PS01/B	03 = 3A	2 = Version 2	1 = Bleed (R) Resistor	63 = 6.3mm tabs	10 = 1.0mm
	06 = 6A	3 = Version 3	2 = Surge (VDR) Protection		15 = 1.5mm
	10 = 10A		3 = "R" plus "VDR"		20 = 2.0mm
					30 = 3.0mm

Specification	PS00/Bxxxx/xx00	PS01/Bxxxx/xxxx	Part No. Example
Max. Working Voltage:	250V a.c. 50-400Hz	250V a.c. 50-400Hz	<b>PS00/B0120/6300 =</b> PS00 series, flange fitting, filtered IEC power inlet, for medical applications, rated at 1 ampere. L/C circuit version 2, i.e. L1 = 2 x 10mH, Cx = 15nF, without bleed resistor or surge protection device fitted, with 6.3mm tabs.
Earth Leakage Current:	<100µA (typically 5µA 250V, 50Hz)	<100µA (typically 5µA 250V, 50Hz)	
Temperature Range:	-25°C to +85°C	-25°C to +85°C	
Max. Ambient Temp.: (@ Full Load)	40°C (derate linearly to 0A @ 85°C)	40°C (derate linearly to 0A @ 85°C)	
Test Voltage:	2700V d.c. 2 secs. Lines to Earth 1100V d.c. 2 secs. Live to Neutral	2700V d.c. 2 secs. Lines to Earth 1100V d.c. 2 secs. Live to Neutral	
Approvals:			
Mating Connectors:	PX0587, PX0587/SE, PX0588	PX0587, PX0587/SE, PX0588	
<b>RoHS</b>	Compliant	Compliant	

**Rating & Version Table**

**PS00/Bxxxx/xx00 & PS01/Bxxxx/xxxx**

Rating	Version	L1	Cx
1 AMP	1	2 x 2.8mH	1 x 15nF
"	2	2 x 10mH	1 x 15nF
"	3	2 x 10mH	1 x 47nF
3 AMP	1	2 x 0.75mH	1 x 15nF
"	2	2 x 1.8mH	1 x 15nF
"	3	2 x 1.8mH	1 x 47nF
6 AMP	1	2 x 0.3mH	1 x 15nF
"	2	2 x 0.7mH	1 x 15nF
"	3	2 x 0.7mH	1 x 47nF
10 AMP	1	2 x 0.17mH	1 x 15nF
"	2	2 x 0.35mH	1 x 15nF
"	3	2 x 0.17mH	1 x 47nF

**Version 1**

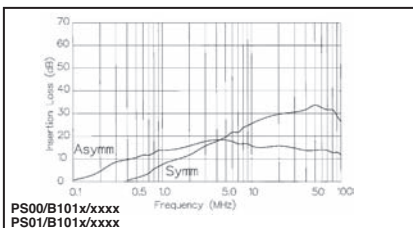
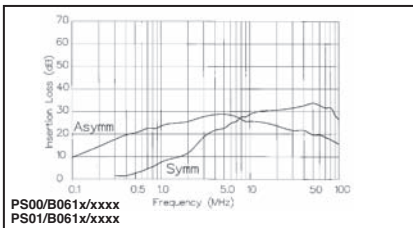
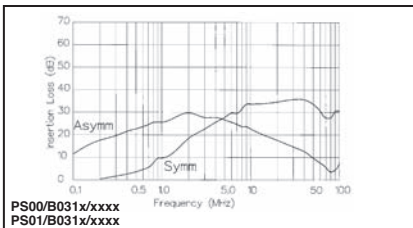
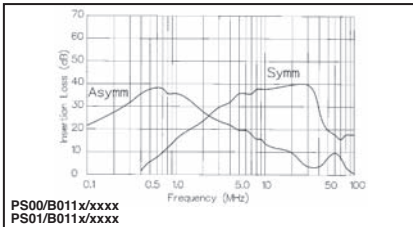

**Version 2**

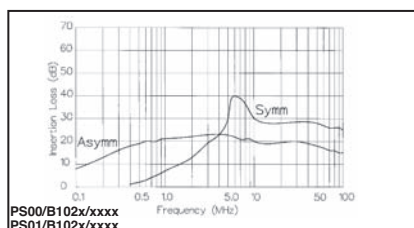
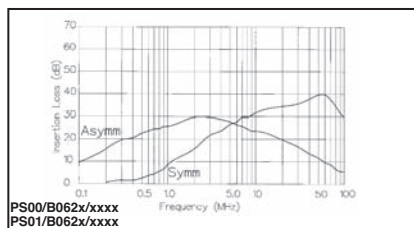
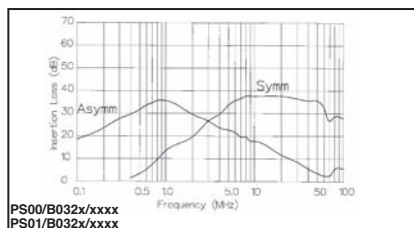
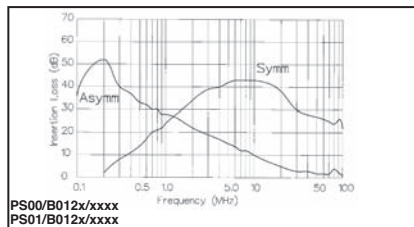

**Version 3**

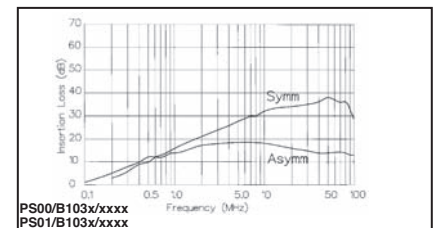
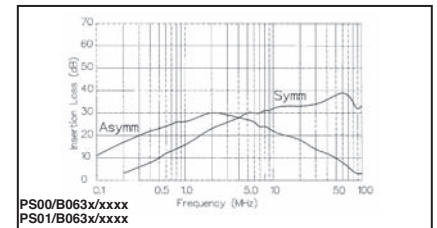
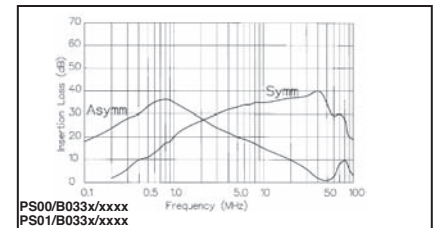
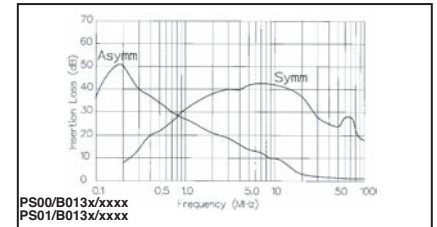

Base Mounting and Bulkhead

BASE MOUNTING



- 1, 3, 6 or 10 Amp Current Rating
- 3 Alternative Circuits
- Optional Additional Components
- 2.8 or 6.3mm tabs

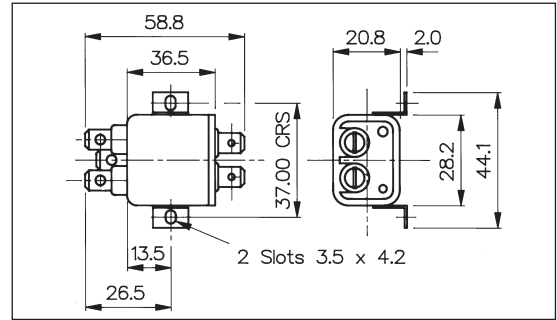

BULKHEAD MOUNTING



- 1, 3, 6 or 10 Amp Current Rating
- 3 Alternative Circuits
- Optional Additional Components
- 2.8 or 6.3mm tabs

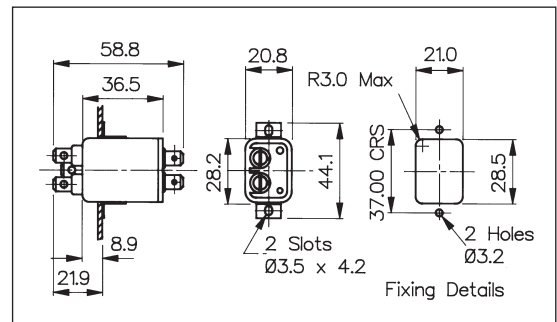

PS02 or PS03/Axx xx /xx

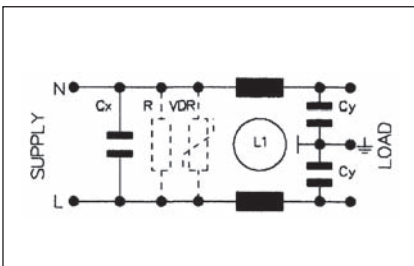

Series	Rating	L/C Circuit	Additional Components	Tag Type and Configuration
PS02/A	01 = 1A	1 = Version 1	0 = None	28 = 2.8mm
PS03/A	03 = 3A	2 = Version 2	1 = Bleed (R) Resistor	63 = 6.3mm tabs
	06 = 6A	3 = Version 3	2 = Surge (VDR) Protection	
	10 = 10A		3 = "R" plus "VDR"	

Specification	PS02/Axxxx/xx	PS03/Axxxx/xx	Part No. Example
Max. Working Voltage:	250V a.c. 50-400Hz	250V a.c. 50-400Hz	<b>PS02/A0311/28 =</b> PS02 series, standard base mounting filter, rated at 3 amperes. L/C circuit version 1, i.e. L1 = 2 x 0.75mH, Cx = 15nF, Cy = 2 x 2.2nF. with bleed resistor fitted, with 2.8mm tabs.
Earth Leakage Current:	<0.35mA (250V, 50Hz)	<0.35mA (250V, 50Hz)	
Temperature Range:	-25°C to +85°C	-25°C to +85°C	
Max. Ambient Temp.: (@ Full Load)	40°C (derate linearly to 0A @ 85°C)	40°C (derate linearly to 0A @ 85°C)	
Test Voltage:	2700V d.c. 2 secs. Lines to Earth 1100V d.c. 2 secs. Live to Neutral	2700V d.c. 2 secs. Lines to Earth 1100V d.c. 2 secs. Live to Neutral	
Approvals:			
	Compliant	Compliant	

IEC CONNECTORS

**Rating & Version Table**  
**PS02/Axxxx/xx & PS03/Axxxx/xx**

Rating	Version	L1	Cx	Cy
1 AMP	1	2 x 2.8mH	1 x 15nF	2 x 2.2nF
"	2	2 x 10mH	1 x 15nF	2 x 2.2nF
"	3	2 x 10mH	1 x 47nF	2 x 2.2nF
3 AMP	1	2 x 0.75mH	1 x 15nF	2 x 2.2nF
"	2	2 x 1.8mH	1 x 15nF	2 x 2.2nF
"	3	2 x 1.8mH	1 x 47nF	2 x 2.2nF
6 AMP	1	2 x 0.3mH	1 x 15nF	2 x 2.2nF
"	2	2 x 0.7mH	1 x 15nF	2 x 2.2nF
"	3	2 x 0.7mH	1 x 47nF	2 x 2.2nF
10 AMP	1	2 x 0.17mH	1 x 15nF	2 x 2.2nF
"	2	2 x 0.35mH	1 x 15nF	2 x 2.2nF
"	3	2 x 0.17mH	1 x 47nF	2 x 2.2nF

**Version 1**

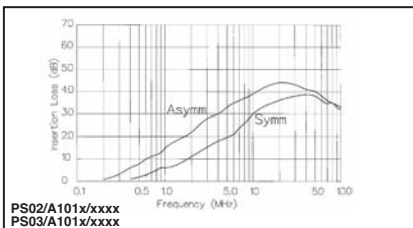
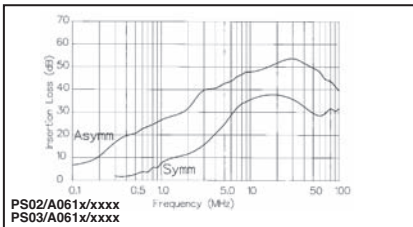
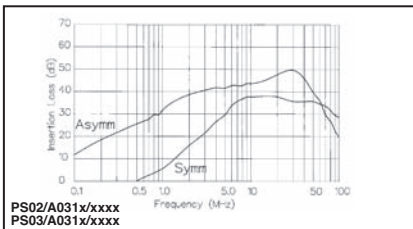
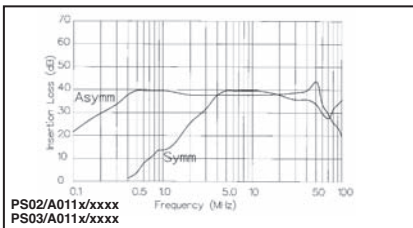

**Version 2**

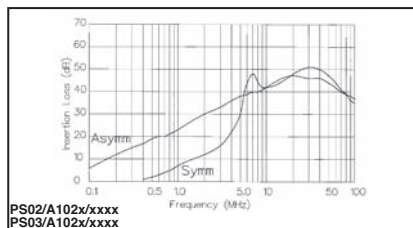
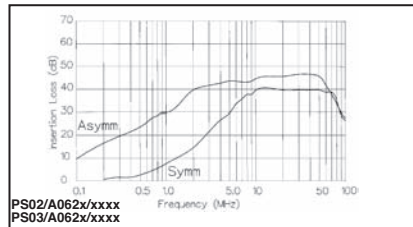
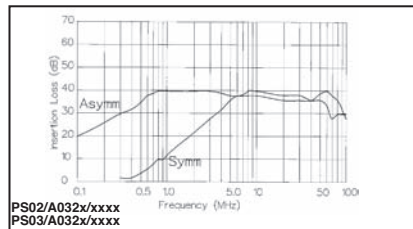
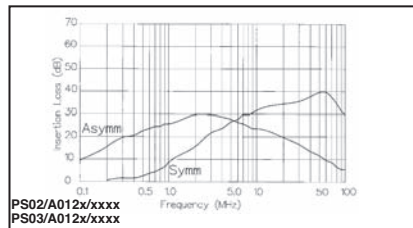

**Version 3**

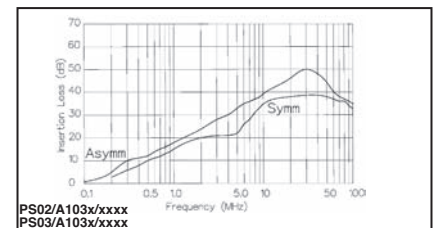
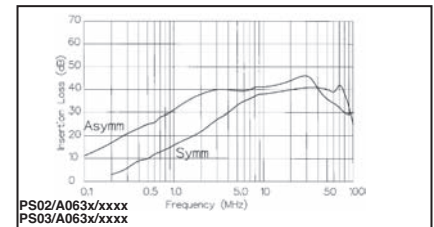
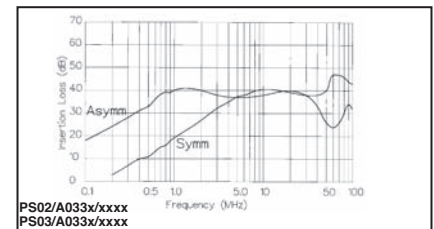
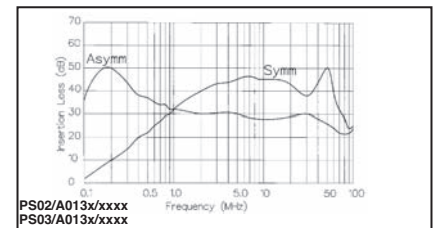

Medical Base Mounting and Bulkhead

BASE MOUNTING

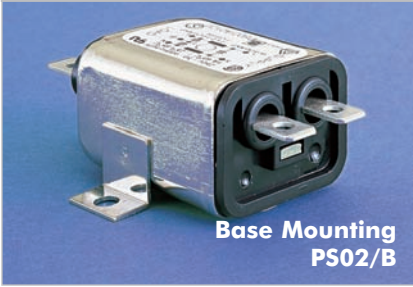

- 1, 3, 6 or 10 Amp Current Rating
- Medical
- 3 Alternative Circuits
- Optional Additional Components
- 2.8 or 6.3mm tabs

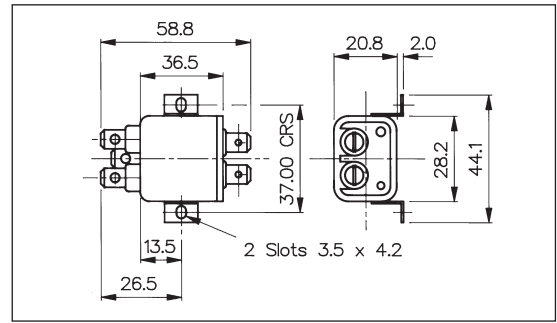

BULKHEAD MOUNTING



- 1, 3, 6 or 10 Amp Current Rating
- Medical
- 3 Alternative Circuits
- Optional Additional Components
- 2.8 or 6.3mm tabs

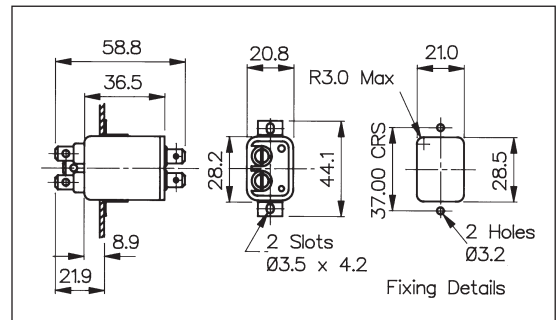

PS02 or PS03/Bxx xx /xx

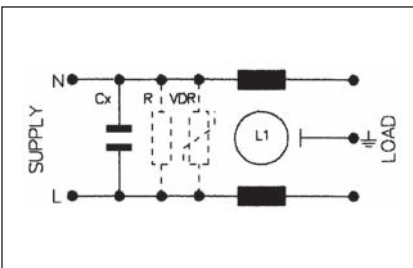

Series	Rating	L/C Circuit	Additional Components	Tag Type and Configuration
PS02/B	01 = 1A	1 = Version 1	0 = None	28 = 2.8mm
PS03/B	03 = 3A	2 = Version 2	1 = Bleed (R) Resistor	63 = 6.3mm tabs
	06 = 6A	3 = Version 3	2 = Surge (VDR) Protection	
	10 = 10A		3 = "R" plus "VDR"	

Specification	PS02/Bxxxx/xx	PS03/Bxxxx/xx	Part No. Example
Max. Working Voltage:	250V a.c. 50-400Hz	250V a.c. 50-400Hz	<b>PS03/B0630/63 =</b> PS03 series, bulkhead mounting for medical applications, rated at 6 amperes. L/C circuit version 3, i.e. L1 = 2 x 0.7mH, Cx = 47nF, without bleed resistor or surge protection device fitted, with 6.3mm tabs.
Earth Leakage Current:	<100µA (typically 5µA 250V, 50Hz)	<100µA (typically 5µA 250, 50Hz)	
Temperature Range:	-25°C to +85°C	-25°C to +85°C	
Max. Ambient Temp.: (@ Full Load)	40°C (derate linearly to 0A @ 85°C)	40°C (derate linearly to 0A @ 85°C)	
Test Voltage:	2700V d.c. 2 secs. Lines to Earth 1100V d.c. 2 secs. Live to Neutral	2700V d.c. 2 secs. Lines to Earth 1100V d.c. 2 secs. Live to Neutral	
Approvals:	 Compliant	 Compliant	



**Rating & Version Table**

**PS02/Bxxxx/xx & PS03/Bxxxx/xx**

Rating	Version	L1	Cx
1 AMP	1	2 x 2.8mH	1 x 15nF
"	2	2 x 10mH	1 x 15nF
"	3	2 x 10mH	1 x 47nF
3 AMP	1	2 x 0.75mH	1 x 15nF
"	2	2 x 1.8mH	1 x 15nF
"	3	2 x 1.8mH	1 x 47nF
6 AMP	1	2 x 0.3mH	1 x 15nF
"	2	2 x 0.7mH	1 x 15nF
"	3	2 x 0.7mH	1 x 47nF
10 AMP	1	2 x 0.17mH	1 x 15nF
"	2	2 x 0.35mH	1 x 15nF
"	3	2 x 0.17mH	1 x 47nF

**Version 1**

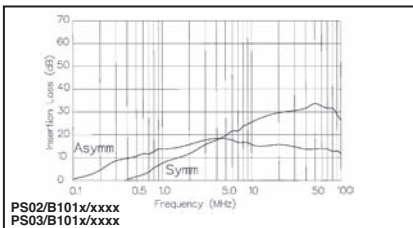
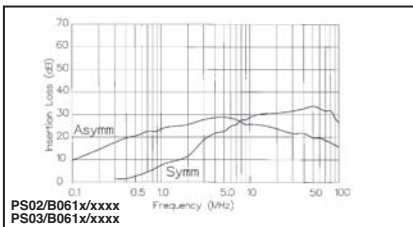
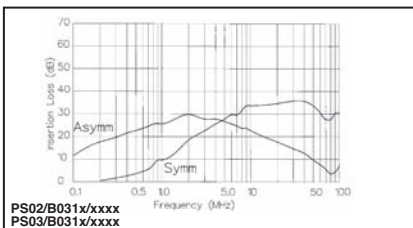
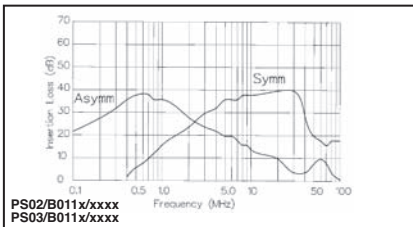

**Version 2**

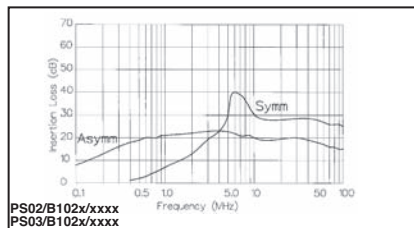
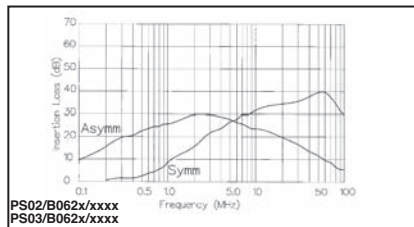
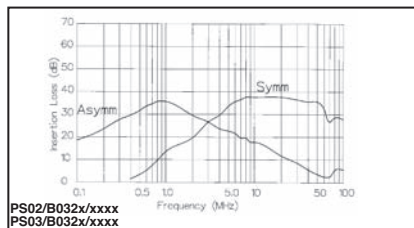
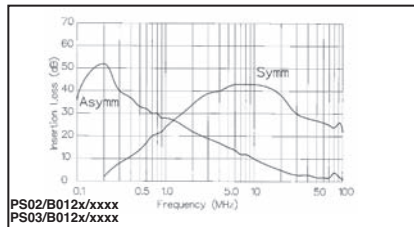

**Version 3**

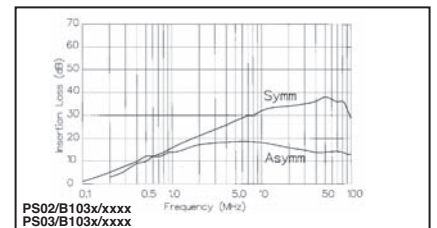
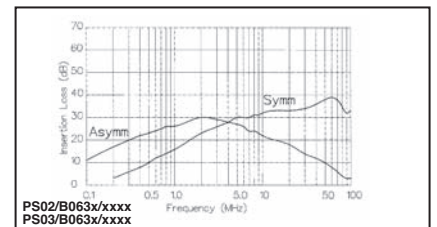
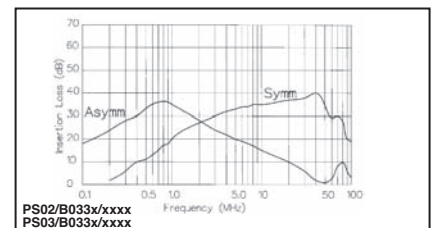
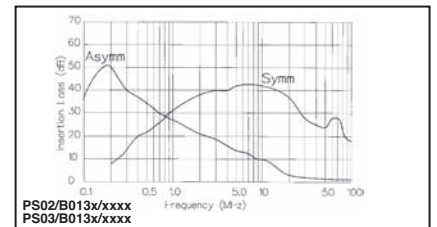

IEC Power Inlets (Single Fused)

PANEL MOUNTING



- 1, 3, or 6 Amp Current Rating
- Single Fused
- 2 Alternative Circuits
- 2.8 or 6.3mm tabs

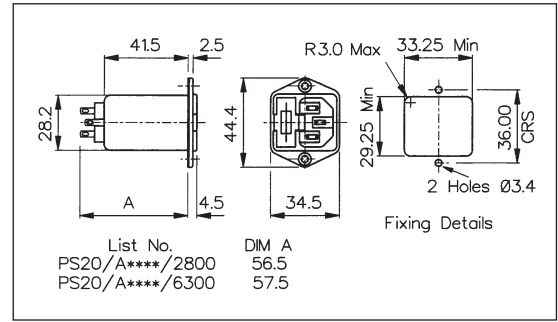

SNAP FIT

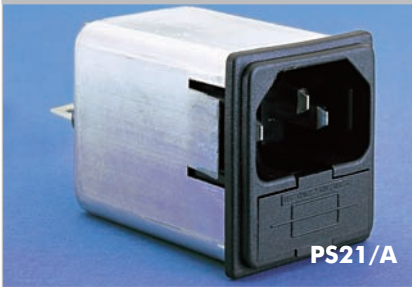

- 1, 3, or 6 Amp Current Rating
- Single Fused
- 2 Alternative Circuits
- 2.8 or 6.3mm tabs
- 1, 1.5, 2 or 3mm panels

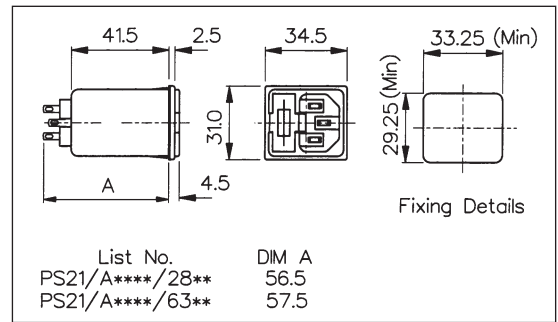

PS20 or PS21/Axx xx /xx xx

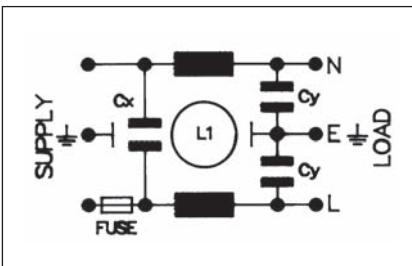

Series	Rating	L/C Circuit	Additional Components	Tag Type and Configuration	Panel Thickness
PS20/A	01 = 1A	3 = Version 3	0 = None	28 = 2.8mm	Blank = Flange
PS21/A	03 = 3A	2 = Version 2		63 = 6.3mm tabs	10 = 1.0mm
	06 = 6A	3 = Version 3			15 = 1.5mm
					20 = 2.0mm
					30 = 3.0mm

Specification	PS20/Axxx0/xx00	PS21/Axxx0/xxxx	Part No. Example
Max. Working Voltage:	250V a.c. 50-400Hz	250V a.c. 50-400Hz	<b>PS20/A0620/63 =</b> PS20 series, flange fitting, standard filtered IEC power inlet, single fused, rated at 6 amperes. L/C circuit version 2, i.e L1 = 2 x 0.7mH, Cx = 1 x 15nF, Cy = 2 x 2.2nF. Without bleed resistor or surge protection device fitted, with 6.3mm tabs.
Earth Leakage Current:	<0.35mA (250V, 50Hz)	<0.35mA (250V, 50Hz)	
Temperature Range:	-25°C to +85°C	-25°C to +85°C	
Max. Ambient Temp.: (@ Full Load)	40°C (derate linearly to 0A @ 85°C)	40°C (derate linearly to 0A @ 85°C)	
Test Voltage:	2700V d.c. 2 secs. Lines to Earth 1100V d.c. 2 secs. Live to Neutral	2700V d.c. 2 secs. Lines to Earth 1100V d.c. 2 secs. Live to Neutral	
Approvals:			
Mating Connectors:	PX0587, PX0587/SE, PX0588	PX0587, PX0587/SE, PX0588	
Accessories:	P.No. 14340 (see page 96)	P.No. 14340 (see page 96)	
RoHS	Compliant	Compliant	

**Rating & Version Table**

**PS20/Axxx0/xx00 & PS21/Axxx0/xxxx**

Rating	Version	L1	Cx	Cy
1 AMP	1			
"	2			
"	3	2 x 10mH	1 x 47nF	2 x 2.2nF
3 AMP	1			
"	2	2 x 1.8mH	1 x 15nF	2 x 2.2nF
"	3	2 x 6.5mH	1 x 47nF	2 x 2.2nF
6 AMP	1			
"	2	2 x 0.7mH	1 x 15nF	2 x 2.2nF
"	3	2 x 2mH	1 x 47nF	2 x 2.2nF

**Version 2**

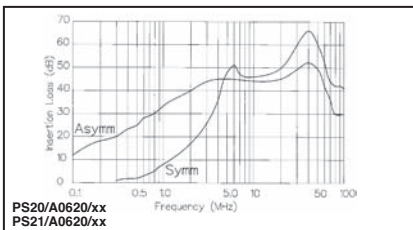
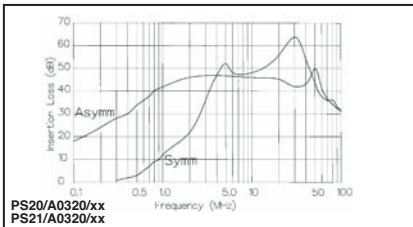

**Version 3**

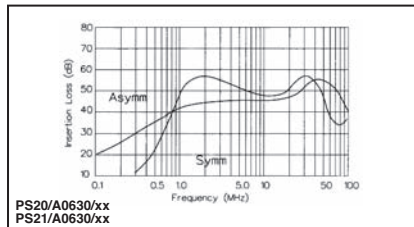
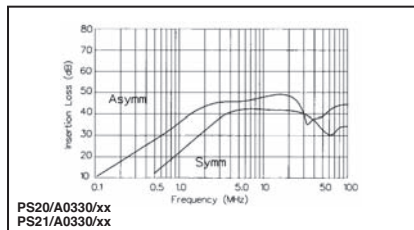
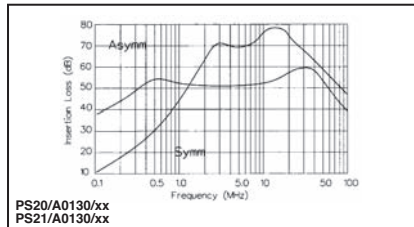

IEC Power Inlets Flange and Snap Fit (Twin Fused)

PANEL MOUNTING

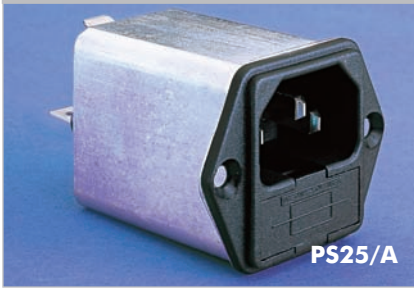

- 2 or 4 Amp Current Rating
- Twin Fused
- Optional Additional Components
- 2.8 or 6.3mm tabs

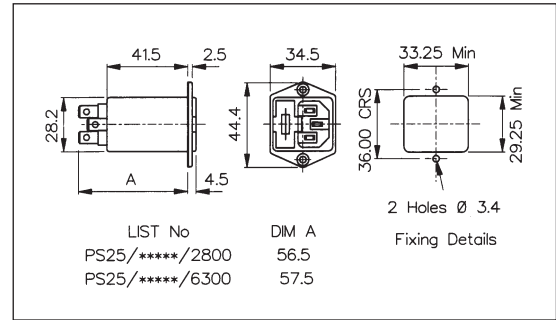

SNAP FIT

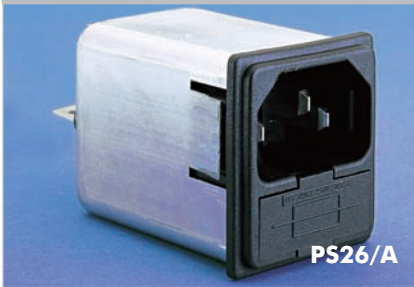

- 2 or 4 Amp Current Rating
- Twin Fused
- Optional Additional Components
- 2.8 or 6.3mm tabs
- 1, 1.5, 2 or 3mm panels

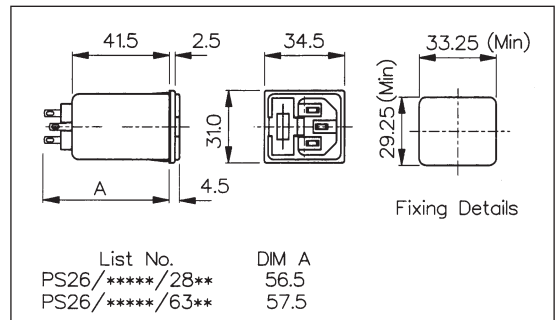

PS25 or PS26/Axx2x/xx xx

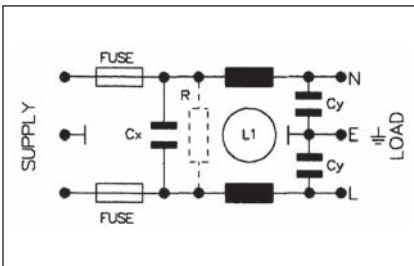

Series	Rating	L/C Circuit	Additional Components	Tag Type and Configuration	Panel Thickness
PS25/A	02 = 2A	2 = Version 2	0 = None	28 = 2.8mm	Blank = Flange
PS26/A	04 = 4A		1 = Bleed (R) Resistor	63 = 6.3mm tabs	10 = 1.0mm 15 = 1.5mm 20 = 2.0mm 30 = 3.0mm

Specification

Specification	PS25/Axx2x/xx00	PS26/Axx2x/xxxx	Part No. Example
Max. Working Voltage:	250V a.c. 50-400Hz	250V a.c. 50-400Hz	<p>PS25/A0420/28=</p> <p>PS25 series, flange fitting, standard filtered IEC power inlet, twin fused, rated at 4 amperes. L/C circuit version 2, i.e L1 = 2 x 0.7mH, Cx = 1 x 15nF, Cy = 2 x 2.2nF Without bleed resistor fitted, with 2.8mm tabs.</p>
Max. Power Dissipation:	2.5W per fuse	2.5W per fuse	
Earth Leakage Current:	<0.35mA (250V, 50Hz)	<0.35mA (250V, 50Hz)	
Temperature Range:	-25°C to +85°C	-25°C to +85°C	
Max. Ambient Temp.: (@ Full Load)	40°C (derate linearly to 0A @ 85°C)	40°C (derate linearly to 0A @ 85°C)	
Test Voltage:	2700V d.c. 2 secs. Lines to Earth 1100V d.c. 2 secs. Live to Neutral	2700V d.c. 2 secs. Lines to Earth 1100V d.c. 2 secs. Live to Neutral	
Approvals:			
Mating Connectors:	PX0587, PX0587/SE, PX0588	PX0587, PX0587/SE, PX0588	
Accessories:	P.No. 14340 (see page 96)	P.No. 14340 (see page 96)	
RoHS	Compliant	Compliant	

**Rating & Version Table**  
**PS25/Axx2x/xx00 & PS26/Axx2x/xxxx**

Rating	Version	L1	Cx	Cy
2 AMP	1	2 x 1.8mH	1 x 15nF	2 x 2.2nF
"	2			
"	3			
4 AMP	1	2 x 0.7mH	1 x 15nF	2 x 2.2nF
"	2			
"	3			

**Version 2**

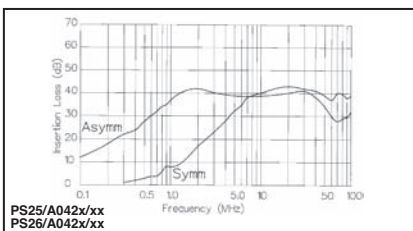
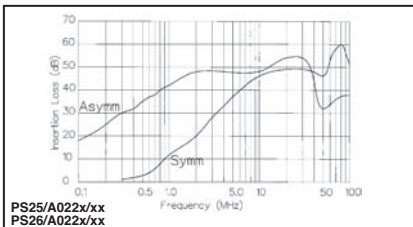

## Medical IEC Power Inlets (Twin Fused)

### PANEL MOUNTING

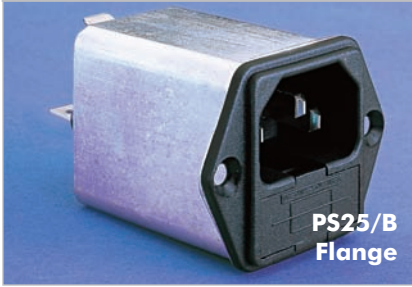

- 2 or 4 Amp Current Rating
- Medical
- Twin Fused
- Optional Additional Components
- 2.8 or 6.3mm tabs

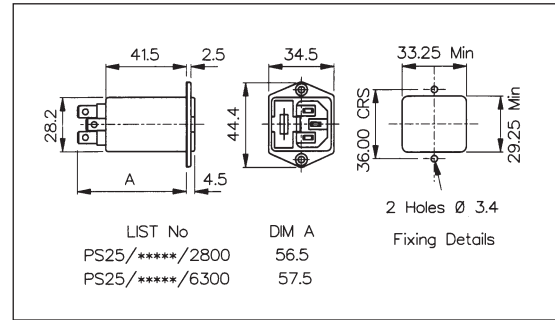

### SNAP FIT



- 2 or 4 Amp Current Rating
- Medical
- Twin Fused
- Optional Additional Components
- 2.8 or 6.3mm tabs
- 1, 1.5, 2 or 3mm panels

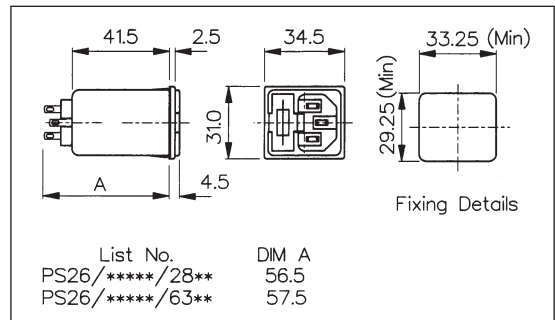

### PS25 or PS26/Bxx 2x / xx xx

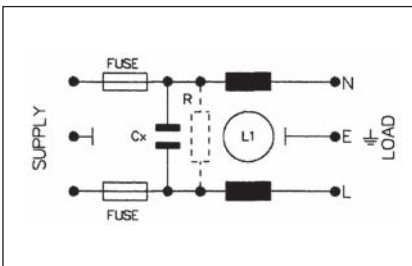

Series	Rating	L/C Circuit	Additional Components	Tag Type and Configuration	Panel Thickness
PS25/B	02 = 2A	2 = Version 2	0 = None	28 = 2.8mm	Blank = Flange
PS26/B	04 = 4A		1 = Bleed (R) Resistor	63 = 6.3mm tabs	10 = 1.0mm 15 = 1.5mm 20 = 2.0mm 30 = 3.0mm

### Specification

Specification	PS25/Bxx2x/xx00	PS26/Bxx2x/xxxx	Part No. Example
Max. Working Voltage:	250V a.c. 50-400Hz	250V a.c. 50-400Hz	<div style="border: 1px solid black; padding: 5px;"> <b>PS25/B0220/63 =</b>                      PS25 series, flange fitting, for medical applications, rated at 2 amperes. L/C circuit version 2, i.e L1 = 2 x 1.8mH, Cx = 1 x 15nF, without bleed resistor fitted, with 6.3mm tabs.                 </div>
Max. Power Dissipation:	2.5W per fuse	2.5W per fuse	
Earth Leakage Current:	<100µA (typically 5µA 250V, 50Hz)	<100µA (typically 5µA 250V, 50Hz)	
Temperature Range:	-25°C to +85°C	-25°C to +85°C	
Max. Ambient Temp.: (@ Full Load)	40°C (derate linearly to 0A @ 85°C)	40°C (derate linearly to 0A @ 85°C)	
Test Voltage:	2700V d.c. 2 secs. Lines to Earth 1100V d.c. 2 secs. Live to Neutral	2700V d.c. 2 secs. Lines to Earth 1100V d.c. 2 secs. Live to Neutral	
Approvals:			
Mating Connectors:	PX0587, PX0587/SE, PX0588	PX0587, PX0587/SE, PX0588	
Accessories:	P.No. 14340 (see page 96)	P.No. 14340 (see page 96)	
<b>RoHS</b>	Compliant	Compliant	

**Rating & Version Table**

**PS25/Bxx2x/xx00 & PS26/Bxx2x/xxxx**

Rating	Version	L1	Cx
2 AMP	1	2 x 1.8mH	1 x 15nF
"	2		
"	3		
4 AMP	1	2 x 0.7mH	1 x 15nF
"	2		
"	3		

**Version 2**

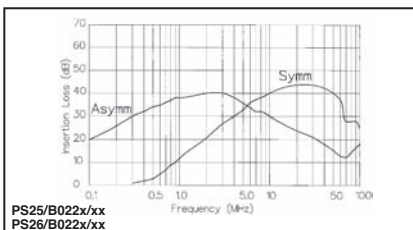
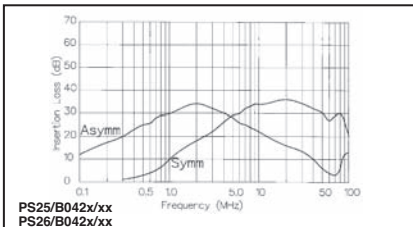







## Стандарт Электрон Связь

Мы молодая и активно развивающаяся компания в области поставок электронных компонентов. Мы поставляем электронные компоненты отечественного и импортного производства напрямую от производителей и с крупнейших складов мира.

Благодаря сотрудничеству с мировыми поставщиками мы осуществляем комплексные и плановые поставки широчайшего спектра электронных компонентов.

Собственная эффективная логистика и склад в обеспечивает надежную поставку продукции в точно указанные сроки по всей России.

Мы осуществляем техническую поддержку нашим клиентам и предпродажную проверку качества продукции. На все поставляемые продукты мы предоставляем гарантию .

Осуществляем поставки продукции под контролем ВП МО РФ на предприятия военно-промышленного комплекса России , а также работаем в рамках 275 ФЗ с открытием отдельных счетов в уполномоченном банке. Система менеджмента качества компании соответствует требованиям ГОСТ ISO 9001.

Минимальные сроки поставки, гибкие цены, неограниченный ассортимент и индивидуальный подход к клиентам являются основой для выстраивания долгосрочного и эффективного сотрудничества с предприятиями радиоэлектронной промышленности, предприятиями ВПК и научно-исследовательскими институтами России.

С нами вы становитесь еще успешнее!

### Наши контакты:

**Телефон:** +7 812 627 14 35

**Электронная почта:** [sales@st-electron.ru](mailto:sales@st-electron.ru)

**Адрес:** 198099, Санкт-Петербург,  
Промышленная ул, дом № 19, литера Н,  
помещение 100-Н Офис 331