

AVX RF Microwave Products



Version 16.4

AVX
A KYOCERA GROUP COMPANY

*AVX Microwave
Ask The World Of Us*

As one of the world's broadest line multilayer ceramic chip capacitor suppliers, and a major Thin Film RF/Microwave capacitor, inductor, directional coupler and low pass filter and microwave ceramic capacitor manufacturer, it is our mission to provide **First In Class** Technology, Quality and Service, by establishing progressive design, manufacturing and continuous improvement programs driving toward a single goal:

TOTAL CUSTOMER SATISFACTION

QV2000

Table of Contents

Company Profile	4
------------------------------	----------

Thin-Film RF/Microwave Capacitor Technology

Accu-P®

Thin-Film Technology.....	6
Thin-Film Chip Capacitors	7-9
0201 Typical Electrical Tables – Accu-P®	10-11
0402 Typical Electrical Tables – Accu-P®	12-13
0603 Typical Electrical Tables – Accu-P®	14-15
0805 Typical Electrical Tables – Accu-P®	16-17
1210 Typical Electrical Tables – Accu-P®	18-19
High Frequency Characteristics	20-25
Environmental / Mechanical Characteristics	26
Performance Characteristics RF Power Applications.....	27
Application Notes.....	28-29
Automatic Insertion Packaging	30

Thin-Film RF/Microwave Inductor Technology

Accu-L®

L0201 Tight Tolerance RF Inductor	32-33
L0402 Tight Tolerance RF Inductor	34-35
L0603 AND L0805 SMD High-Q RF Inductor – Accu-L®	36-38
Environmental Characteristics.....	39
Application Notes	40

Thin-Film RF/Microwave Directional Couplers

CP0302/CP0402/CP0603/CP0805 and DB0603N/DB0805 3dB 90°

CP0402W2700FNTR Wide Band High Directivity	42-43
CP0402W2700FNTR Test Jigs	44
CP0302A5425ENTR / CP0402Q5425ENTR / CP0603Q5425ENTR High Directivity Directional Couplers For WiFi Bands	45-46
CP0402P High Directivity, Tight Coupling Tolerance	47-48
CP0402 High Directivity LGA Termination.....	49-52
CP0603 High Directivity LGA Termination.....	53-58
CP0402 / CP0603 High Directivity Couplers Test Jigs.....	59
CP0603 SMD Type – Thin-Film Directional Couplers.....	60-62
CP0603 SMD Type – High Directivity	63
CP0805 SMD Type – Thin-Film Directional Couplers.....	64-68
CP0805 and CP0603 Test Jigs	69
DB0603N 3dB 90° Couplers	70-86
DB0805 3dB 90° Couplers	87-98
DB0805 3dB 90° Test Jigs	99

Thin-Film RF/Microwave Harmonic Low Pass Filter

LP0402/LP0603/LP0805

LP0402N Series Harmonic Low Pass Filter Lead-Free LGA Termination.....	101-103
LP0402N Series Harmonic Low Pass Filter Lead-Free LGA Termination Test Jigs	104
LP0603 Lead-Free LGA Type	105-108
LP0603 Test Jigs	109
LP0805 Type Harmonic.....	110-111
LP0805 Test Jigs	112

1206 High Performance

LP1206A0512BNTR Harmonic Low Pass Filter.....	113-114
LP1206A0700ANTR Low Pass Filter.....	115-116

Thin-Film RF/Microwave Products – Designer Kits

Multilayer Organic (MLO™) Technology

MLO™ Capacitors

MLO™ Diplexers

0603 WLAN/BT	125-130
0805 CDMA	131-132
0805 WCDMA	133-134
0805 WLAN	135-136
0805 WLAN/BT	137-138
Automated SMT Assembly/SMT Reflow Profile.....	139

MLO™ Inductors

Tight Tolerance	140-141
High Current.....	142-143
Hi-Q.....	144-145
Performance Characteristics.....	146
Automated SMT Assembly/SMT Reflow Profile.....	147

MLO™ SMT Crossovers

RF-DC.....	148-150
RF-RF	151-153
Automated SMT Assembly/SMT Reflow Profile.....	154

RF Inductors

AL Series – Air Core Inductors.....	156-162
AS Series – Square Air Core Inductors.....	163-167
LCWC Series – Wire Wound Chip Inductor	168-177

RF/Microwave Capacitors

RF/Microwave Multilayer Capacitors (MLC)

UQ Series High Q Ultra Low ESR MLC	179-191
SQ Series Ultra Low ESR MLC	192-204
MK Series Ultra Low ESR, COG (NPO) Capacitors	205-207
AQ Series	208-211
MIL-PRF-55681 “BG” Voltage Temperature Limits (+90±20ppm/°C).....	212-214
• CDR11BG; CDR12BG (0.055" x 0.055") - Failure Rate Level: M, P, R, S • CDR13BG; CDR14BG (0.110" x 0.110") - Failure Rate Level: M, P, R, S	
Performance Curves	215-219
Automatic Insertion Packaging	220
HQ® Series, High RF Power Capacitors.....	221-227

RF/Microwave COG (NPO) Capacitors

Ultra Low ESR “CU” Series, COG (NPO) Capacitors (RoHS)	228-229
Ultra Low ESR “U” Series, COG (NPO) Capacitors (RoHS).....	230-232
Ultra Low ESR “U” Series, COG (NPO) Capacitors (RoHS) Automotive, AEC Q200 Qualified.....	233-235
Ultra Low ESR “U” Series, COG (NPO) Capacitors (Sn/Pb).....	236-238

RF/Microwave “U” Series Designer Kits

Table of Contents

Company Profile	4	
Thin-Film RF/Microwave Capacitor Technology	5-30	1
Accu-P		
Thin-Film RF/Microwave Inductor Technology	31-40	2
Accu-L [®]		
Thin-Film RF/Microwave Directional Couplers	41-99	3
CP0302/CP0402/CP0603/CP0805 and DB0603N/DB0805 3dB 90°		
Thin-Film RF/Microwave Harmonic Low Pass Filter	100-116	4
LP0402/LP0603/LP0805		
LP1206 High Performance		
Thin-Film RF/Microwave Products – Designer Kits	117-119	5
Multilayer Organic (MLO™) Technology	120-154	6
MLO™ Capacitors	MLO™ Inductors	
MLO™ Diplexers	MLO™ SMT Crossovers	
RF Inductors	155-177	7
Air Core Inductors		
Square Air Core Inductors		
Wire Wound Chip Inductors		
RF/Microwave Capacitors	178-239	8
RF/Microwave Multilayer Capacitors (MLC)		
RF/Microwave COG (NPO) Capacitors		
RF/Microwave “U” Series Designer Kits		

AVX Corporation is a leading manufacturer of multilayer ceramic, thin film and tantalum, as well as other passive electronic components. These products are used in virtually every electronic system today, including data processing, telecommunications, consumer electronics, automotive electronics, military and aerospace systems, and instrumentation and process controls.

We continually strive to be the leader in all component segments we supply. RF/Microwave capacitors is a thrust business for us. AVX offers a broad line of RF/Microwave Chip Capacitors in a wide range of sizes, styles, and ratings.

The Thin-Film Products range illustrated in this catalog represents the state-of-the-art in RF Capacitors, Inductors, Directional Couplers and Low Pass Filters. The thin-film technology provides components that exhibit excellent batch-to-batch repeatability of electrical parameters at RF frequencies.

The Accu-P® series of capacitors are available in ultra-tight tolerances ($\pm 0.01\text{pF}$) as well as non-standard capacitance values.

The Accu-L® series of inductors are ideally suited for applications requiring an extremely high Q and high current capability.

The CP0302/CP0402/CP0603/CP0805 series of Directional Couplers cover the frequency range of 800 MHz to 6 GHz. They feature low insertion loss, high directivity and highly accurate coupling factors.

The LP0402/0603/0805 series of Low Pass Filters provide a rugged component in a small size package with excellent high frequency performance.

The Multilayer Organic (MLO™) series of components are based on AVX's patented multilayer organic technology (US patent 6,987,307). They are low profile with frequencies well above 1GHz.

Another major series of microwave capacitors consists of both multilayer porcelain and ceramic capacitors for frequencies from 10 MHz to 4.2 GHz (UQ and SQ Series). Six sizes of specially designed ultra-low ESR C0G (NP0) capacitors are covered for RF applications (CU and U Series).

The air core and wire wound ceramic chip inductors offer high current ratings (up to 4.4A) and quality factor (>100).

Ask the world of us. Call (864) 967-2150.

Or visit our website <http://www.avx.com>

AVX RF

**Thin-Film RF/Microwave
Capacitor Technology**

Accu-P[®]

Thin-Film Technology

THE IDEAL CAPACITOR

The non-ideal characteristics of a real capacitor can be ignored at low frequencies. Physical size imparts inductance to the capacitor and dielectric and metal electrodes result in resistive losses, but these often are of negligible effect on the circuit. At the very high frequencies of radio communication (>100MHz) and satellite systems (>1GHz), these effects become important. Recognizing that a real capacitor will exhibit inductive and resistive impedances in addition to capacitance, the ideal capacitor for these high frequencies is an ultra low loss component which can be fully characterized in all parameters with total repeatability from unit to unit.

Until recently, most high frequency/microwave capacitors were based on fired-ceramic (porcelain) technology. Layers of ceramic dielectric material and metal alloy electrode paste are interleaved and then sintered in a high temperature oven. This technology exhibits component variability in dielectric quality (losses, dielectric constant and insulation resistance), variability in electrode conductivity and variability in physical size (affecting inductance). An alternate thin-film technology has been developed which virtually eliminates these variances. It is this technology which has been fully incorporated into Accu-P® and Accu-P® to provide high frequency capacitors exhibiting truly ideal characteristics.

The main features of Accu-P® may be summarized as follows:

- High purity of electrodes for very low and repeatable ESR.
- Highly pure, low-K dielectric for high breakdown field, high insulation resistance and low losses to frequencies above 40GHz.
- Very tight dimensional control for uniform inductance, unit to unit.
- Very tight capacitance tolerances for high frequency signal applications.

This accuracy sets apart these Thin-Film capacitors from ceramic capacitors so that the term Accu has been employed as the designation for this series of devices, an abbreviation for “accurate.”

THIN-FILM TECHNOLOGY

Thin-film technology is commonly used in producing semiconductor devices. In the last two decades, this technology has developed tremendously, both in performance and in process control. Today’s techniques enable line definitions of below 1µm, and the controlling of thickness of layers at 100Å (10⁻²µm). Applying this technology to the manufacture of capacitors has enabled the development of components where both electrical and physical properties can be tightly controlled.

The thin-film production facilities at AVX consist of:

- Class 1000 clean rooms, with working areas under laminar-flow hoods of class 100, (below 100 particles per cubic foot larger than 0.5µm).
- High vacuum metal deposition systems for high-purity electrode construction.
- Photolithography equipment for line definition down to 2.0µm accuracy.
- Plasma-enhanced CVD for various dielectric depositions (CVD=Chemical Vapor Deposition).
- High accuracy, microprocessor-controlled dicing saws for chip separation.
- High speed, high accuracy sorting to ensure strict tolerance adherence.

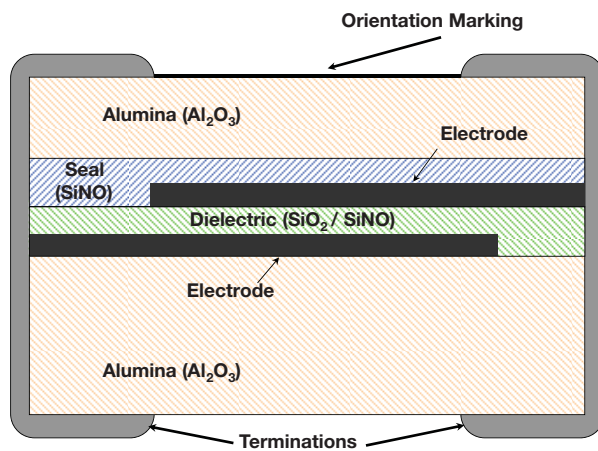

ACCU-P® CAPACITOR STRUCTURE

Thin-Film Chip Capacitors

ACCU-P® TECHNOLOGY

The use of very low-loss dielectric materials, silicon dioxide and silicon oxynitride, in conjunction with highly conductive electrode metals results in low ESR and high Q. These high-frequency characteristics change at a slower rate with increasing frequency than for ceramic microwave capacitors.

Because of the thin-film technology, the above-mentioned frequency characteristics are obtained without significant compromise of properties required for surface mounting.

The main Accu-P® properties are:

- Internationally agreed sizes with excellent dimensional control.
- Ultra small size chip capacitors (01005) are available.
- Ultra tight capacitance tolerances.
- Low ESR at VHF, UHF and microwave frequencies.
- Enhanced RF power handling capability.
- High stability with respect to time, temperature, frequency and voltage variation.
- Nickel/solder-coated terminations to provide excellent solderability and leach resistance.

ACCU-P® FEATURES

Accu-P® meets the fast-growing demand for low-loss (high-Q) capacitors for use in surface mount technology especially for the mobile communications market, such as cellular radio of 450 and 900 MHz, UHF walkie-talkies, UHF cordless telephones to 2.3 GHz, low noise blocks at 11-12.5 GHz and for other VHF, UHF and microwave applications.

Accu-P® is currently unique in its ability to offer very low capacitance values (0.05pF) and very tight capacitance tolerances ($\pm 0.01\text{pF}$).

- The RF power handling capability of the Accu-P® allows for its usage in both small signal and RF power applications.
- Thin Film Technology guarantees minimal batch to batch variability of parameters at high frequency.
- Inspection test and quality control procedures in accordance with ISO 9001, CECC, IECQ and USA MIL Standards yield products of the highest quality.
- Hand soldering Accu-P®: Due to their construction utilizing relatively high thermal conductivity materials, Accu-P's have become the preferred device in R & D labs and production environments where hand soldering is used.

APPLICATIONS

Cellular Communications
CT2/PCN (Cordless Telephone/Personal Comm. Networks)
Satellite TV
Cable TV
GPS (Global Positioning Systems)
Vehicle Location Systems
Vehicle Alarm Systems
Paging
Military Communications

Radar Systems
Video Switching
Test & Measurements
Filters
VCO's
Matching Networks
RF Amplifiers

APPROVALS

ISO 9001

Accu-P[®]

Thin-Film Chip Capacitors for RF Signal and Power Applications

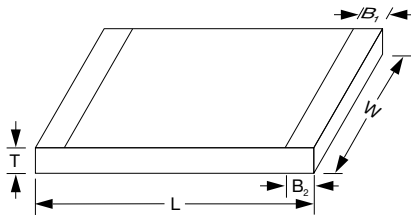

ACCU-P[®] (Signal and Power Type Capacitors)

	01005*	0201*	0402*	0603*	0805*	1210
L	0.405±0.020 (0.016±0.001)	0.60±0.05 (0.023±0.002)	1.00±0.1 (0.039±0.004)	1.60±0.1 (0.063±0.004)	2.01±0.1 (0.079±0.004)	3.02±0.1 (0.119±0.004)
W	0.215 ± 0.020 (0.0085 ± 0.001)	0.325±0.050 (0.0128±0.002)	0.55±0.07 (0.022±0.003)	0.81±0.1 (0.032±0.004)	1.27±0.1 (0.050±0.004)	2.5±0.1 (0.100±0.004)
T	0.145 ± 0.020 (0.006 ± 0.001)	0.225±0.050 (0.009±0.002)	0.40±0.1 (0.016±0.004)	0.63±0.1 (0.025±0.004)	0.93±0.2 (0.036±0.008)	0.93±0.2 (0.036±0.008)
B ₁	0.00 ^{+0.1} _{-0.0} (0.000 ^{+0.004} _{-0.000})	0.10±0.10 (0.004±0.004)	0.00 ^{+0.1} _{-0.0} (0.000 ^{+0.004} _{-0.000})	0.35±0.15 (0.014±0.006)	0.30±0.1 (0.012±0.004)	0.43±0.1 (0.017±0.004)
B ₂	0.10 ± 0.03 (0.004 ± 0.001)	0.15±0.05 (0.006±0.002)	0.20±0.1 (0.008±0.004)	0.35±0.15 (0.014±0.006)	0.30±0.1 (0.012±0.004)	0.43±0.1 (0.017±0.004)

*Mount Black Side Up

DIMENSIONS: millimeters (inches)

HOW TO ORDER

0402

Size
C005
0201
0402
0603
0805
1210*

3

Voltage
2 = 200V
1 = 100V
5 = 50V
3 = 25V
Y = 16V
Z = 10V

J

Temperature Coefficient (1)
J = 0±30ppm/°C
(-55°C to +125°C)
K = 0±60ppm/°C
(-55°C to +125°C)

4R7

Capacitance
Capacitance expressed in pF. (2 significant digits + number of zeros) **for values <10pF**, letter R denotes decimal point.
Example:
68pF = 680
8.2pF = 8R2

A

Tolerance for C≤2.0pF*
Z = ±0.01pF
P = ±0.02pF
Q = ±0.03pF
A = ±0.05pF
B = ±0.1pF
C = ±0.25pF

for C≤3.0pF
Q = ±0.03pF
A = ±0.05pF
B = ±0.1pF
C = ±0.25pF

for C≤5.6pF
A = ±0.05pF
B = ±0.1pF
C = ±0.25pF

for 5.6pF<C<10pF
B = ±0.1pF
C = ±0.25pF
D = ±0.5pF

for C≥10pF
F = ±1%
G = ±2%
J = ±5%

B

Specification Code
B = Accu-P[®] technology

S

Termination Code

W = Nickel/Solder Coated
Accu-P[®] 0402 Sn90, Pb10***
T = Nickel/High Temperature Solder Coated
Accu-P[®] 0805, 1210**** Sn96, Ag4
Nickel/Solder Coated
Accu-P[®] 0603*** Sn63, Pb37
**S = Nickel/Lead Free Solder Coated
Accu-P[®] 01005, 0201, 0402, 0603 Sn100

**RoHS compliant

*** Not RoHS Compliant

TR

Packaging Code

TR = Tape & Reel

(1) TC's shown are per EIA/IEC Specifications.

Engineering Kits Available
see pages 118-119

*Tolerances as tight as ±0.01pF are available. Please consult the factory.



LEAD-FREE
LEAD-FREE COMPATIBLE
COMPONENT



RoHS
COMPLIANT

For RoHS compliant products,
please select correct termination style.

ELECTRICAL SPECIFICATIONS

Operating and Storage Temperature Range	-55°C to +125°C
Temperature Coefficients ⁽¹⁾	0 ± 30ppm/°C dielectric code "J" / 0 ± 60ppm/°C dielectric code "K"
Capacitance Measurement	1 MHz, 1 Vrms
Insulation Resistance (IR)	≥10 ¹¹ Ohms (≥10 ¹⁰ Ohms for 0201 and 0402 size)
Proof Voltage	2.5 U _R for 5 secs.
Aging Characteristic	Zero
Dielectric Absorption	0.01%

Signal and Power Type Capacitors

Accu-P® Capacitance Ranges (pF)

TEMP. COEFFICIENT CODE

“J” = 0±30ppm/°C (-55°C to +125°C)⁽²⁾ “K” = 0±60ppm/°C (-55°C to +125°C)⁽²⁾

Size		0201					0402					0603				0805			1210				
Size Code	C005	16	100	50	25	16	10	200	100	50	25	16	10	200	100	50	25	100	50	25	100	50	
Cap in pF ⁽¹⁾	Cap code																						
0.1	— 0R1																						
0.2	— 0R2																						
0.3	— 0R3																						
0.4	— 0R4																						
0.5	— 0R5																						
0.6	— 0R6																						
0.7	— 0R7																						
0.8	— 0R8																						
0.9	— 0R9																						
1.0	— 1R0																						
1.1	— 1R1																						
1.2	— 1R2																						
1.3	— 1R3																						
1.4	— 1R4																						
1.5	— 1R5																						
1.6	— 1R6																						
1.7	— 1R7																						
1.8	— 1R8																						
1.9	— 1R9																						
2.0	— 2R0																						
2.1	— 2R1																						
2.2	— 2R2																						
2.3	— 2R3																						
2.4	— 2R4																						
2.5	— 2R5																						
2.6	— 2R6																						
2.7	— 2R7																						
2.8	— 2R8																						
2.9	— 2R9																						
3.0	— 3R0																						
3.1	— 3R1																						
3.2	— 3R2																						
3.3	— 3R3																						
3.4	— 3R4																						
3.5	— 3R5																						
3.6	— 3R6																						
3.7	— 3R7																						
3.8	— 3R8																						
3.9	— 3R9																						
4.0	— 4R0																						
4.1	— 4R1																						
4.2	— 4R2																						
4.3	— 4R3																						
4.4	— 4R4																						
4.5	— 4R5																						
4.6	— 4R6																						
4.7	— 4R7																						
5.1	— 5R1																						
5.6	— 5R6																						
6.2	— 6R2																						
6.8	— 6R8																						
7.5	— 7R5																						
8.2	— 8R2																						
9.1	— 9R1																						
10.0	— 100																						
11.0	— 110																						
12.0	— 120																						
13.0	— 130																						
14.0	— 140																						
15.0	— 150																						
16.0	— 160																						
17.0	— 170																						
18.0	— 180																						
19.0	— 190																						
20.0	— 200																						
21.0	— 210																						
22.0	— 220																						
24.0	— 240																						
27.0	— 270																						
30.0	— 300																						
33.0	— 330																						
39.0	— 390																						
47.0	— 470																						
56.0	— 560																						
68.0	— 680																						

⁽¹⁾ For capacitance values higher than listed in table, please consult factory.

⁽²⁾ TC shown is per EIA/IEC Specifications.

These values are produced with “K” temperature coefficient code only.

Intermediate values are available within the indicated range.



0201 Typical Electrical Tables

1

Capacitance @ 1MHz and Tolerance		Self Resonance Frequency (GHz) Typ.	Q Standard Value @ 1GHz		Frequency 900MHz			Frequency 1900MHz			Frequency 2400MHz		
C (pF)	Tol.		Typ.	Min.	C(eff) (pF) Typ.	Q Typ.	ESR (mOhm) Typ.	C(eff) (pF) Typ.	Q Typ.	ESR (mOhm) Typ.	C(eff) (pF) Typ.	Q Typ.	ESR (mOhm) Typ.
0.05	±0.02	20.9	599	402	0.055	650	3220	0.056	265	4010	0.057	195	4450
0.1	±0.02	19.4	574	316	0.110	614	2682	0.112	246	3036	0.113	188	3113
0.15	±0.02	17.9	510	280	0.163	550	2087	0.166	220	2404	0.168	170	2441
0.2	±0.02	16.4	445	245	0.216	520	1693	0.220	210	1971	0.223	160	1970
0.25	±0.02	15.5	436	240	0.262	510	1371	0.268	204	1604	0.272	153	1646
0.3	±0.02	14.6	427	235	0.309	500	1149	0.316	199	1337	0.320	146	1421
0.35	±0.02	14.1	423	232	0.360	494	1001	0.369	196	1177	0.374	144	1265
0.4	±0.02	12.5	418	230	0.411	489	874	0.421	193	1038	0.427	142	1129
0.45	±0.02	11.9	413	227	0.461	484	819	0.473	191	972	0.481	140	1066
0.5	±0.02	11.3	408	224	0.512	478	765	0.526	188	906	0.535	138	1003
0.55	±0.02	10.9	403	222	0.563	473	710	0.578	186	840	0.588	137	940
0.6	±0.02	10.4	398	219	0.614	468	667	0.631	183	791	0.642	135	882
0.65	±0.02	10.0	394	217	0.664	462	624	0.683	181	742	0.695	133	825
0.7	±0.02	9.5	389	214	0.715	457	580	0.735	178	693	0.749	131	767
0.75	±0.02	9.3	384	211	0.766	452	557	0.788	176	664	0.802	129	729
0.8	±0.02	9.1	379	209	0.817	446	534	0.840	173	635	0.856	127	692
0.85	±0.02	8.9	374	206	0.868	441	511	0.893	171	606	0.909	126	654
0.9	±0.02	8.8	370	203	0.918	436	487	0.945	168	577	0.963	124	616
0.95	±0.02	8.6	365	201	0.969	430	464	0.998	166	548	1.016	122	579
1	±0.02	8.4	360	198	1.020	425	441	1.050	163	519	1.070	120	541
1.05	±0.02	8.2	358	197	1.078	421	426	1.112	161	502	1.134	119	523
1.1	±0.02	8.0	355	195	1.135	418	410	1.173	159	486	1.199	117	505
1.15	±0.02	7.8	353	194	1.193	414	395	1.235	157	469	1.263	116	488
1.2	±0.02	7.6	350	193	1.251	411	379	1.296	155	452	1.327	115	470
1.25	±0.02	7.5	348	191	1.308	407	364	1.358	153	436	1.392	114	452
1.3	±0.02	7.4	345	190	1.366	403	348	1.419	151	419	1.456	112	434
1.35	±0.02	7.3	343	189	1.424	400	333	1.481	149	402	1.520	111	416
1.4	±0.02	7.2	340	187	1.481	396	317	1.542	147	386	1.585	110	398
1.45	±0.02	7.1	338	186	1.539	393	302	1.604	145	369	1.649	109	381
1.5	±0.02	7.0	335	184	1.597	389	287	1.665	144	353	1.713	107	363
1.55	±0.02	6.8	332	183	1.642	386	282	1.714	142	347	1.764	106	358
1.6	±0.02	6.7	330	181	1.687	382	277	1.762	141	342	1.815	105	352
1.65	±0.02	6.6	327	180	1.732	378	272	1.810	140	337	1.866	104	347
1.7	±0.02	6.5	324	178	1.777	375	267	1.859	138	331	1.917	103	342
1.75	±0.02	6.4	321	176	1.822	371	262	1.907	137	326	1.968	102	337
1.8	±0.02	6.3	318	175	1.866	367	257	1.955	136	321	2.018	101	331
1.85	±0.02	6.2	315	173	1.911	364	252	2.003	134	316	2.069	100	326
1.9	±0.02	6.2	312	172	1.956	360	247	2.052	133	310	2.120	99	321
1.95	±0.02	6.1	309	170	2.001	357	242	2.100	132	305	2.171	98	316
2	±0.03	6.0	306	168	2.046	353	237	2.148	131	300	2.222	97	310
2.1	±0.03	5.9	301	166	2.150	348	232	2.263	128	293	2.344	95	303
2.2	±0.03	5.7	296	163	2.254	343	227	2.377	125	287	2.467	93	296
2.3	±0.03	5.6	292	160	2.358	337	222	2.491	122	281	2.590	91	289
2.4	±0.03	5.5	287	158	2.462	332	217	2.606	120	274	2.712	89	282
2.5	±0.03	5.4	282	155	2.566	327	212	2.720	117	268	2.835	87	275
2.6	±0.03	5.3	277	152	2.670	322	207	2.834	114	262	2.958	85	268
2.7	±0.03	5.2	272	150	2.773	317	202	2.949	112	255	3.080	83	261
2.8	±0.03	5.1	269	148	2.878	312	199	3.066	110	252	3.209	81	258
2.9	±0.03	5.0	265	146	2.983	308	196	3.184	108	248	3.337	80	254
3	±0.03	4.9	261	144	3.088	304	193	3.301	106	245	3.465	78	251
3.1	±0.05	4.8	257	141	3.192	299	190	3.419	105	241	3.593	77	247
3.2	±0.05	4.7	253	139	3.297	295	187	3.536	103	238	3.722	76	244
3.3	±0.05	4.6	250	137	3.402	291	185	3.654	101	234	3.850	74	240
3.4	±0.05	4.6	246	135	3.506	286	182	3.771	99	231	3.978	73	237
3.5	±0.05	4.5	242	133	3.611	282	179	3.889	98	227	4.107	71	233
3.6	±0.05	4.5	238	131	3.716	278	176	4.006	96	224	4.235	70	230
3.7	±0.05	4.4	234	129	3.820	273	173	4.124	94	220	4.363	69	226
3.8	±0.05	4.4	230	127	3.925	269	170	4.241	92	217	4.492	67	223
3.9	±0.05	4.3	227	125	4.030	265	167	4.359	91	213	4.620	66	219

0201 Typical Electrical Tables

Capacitance @ 1MHz and Tolerance		Self Resonance Frequency (GHz) Typ.	Q Standard Value @ 1GHz		Frequency 900MHz			Frequency 1900MHz			Frequency 2400MHz		
C (pF)	Tol.		Typ.	Min.	C(eff) (pF) Typ.	Q Typ.	ESR (mOhm) Typ.	C(eff) (pF) Typ.	Q Typ.	ESR (mOhm) Typ.	C(eff) (pF) Typ.	Q Typ.	ESR (mOhm) Typ.
4	±0.05	4.3	224	123	4.138	262	165	4.484	89	210	4.760	65	216
4.1	±0.05	4.2	222	122	4.247	259	162	4.610	88	207	4.901	64	213
4.2	±0.05	4.2	220	121	4.356	257	159	4.735	87	204	5.041	63	210
4.3	±0.05	4.1	218	120	4.464	254	157	4.860	86	201	5.181	62	207
4.4	±0.05	4.1	216	119	4.573	252	154	4.986	85	198	5.322	61	204
4.5	±0.05	4.0	214	118	4.682	249	152	5.111	83	195	5.462	60	201
4.6	±0.05	4.0	212	116	4.790	246	149	5.237	82	192	5.602	59	198
4.7	±0.05	3.9	209	115	4.899	244	147	5.362	81	189	5.743	58	195
5.1	±0.05	3.8	201	110	5.334	233	136	5.863	76	178	6.304	54	183
5.6	±0.05	3.6	190	105	5.877	220	124	6.490	70	163	7.006	49	168
6.2	±0.1	3.5	177	97	6.488	208	126	7.290	65	167	7.993	45	174
6.8	±0.1	3.3	164	90	7.100	195	128	8.090	60	171	8.980	41	179
7.5	±0.1	3.2	153	84	7.901	182	125	9.129	56	166	10.27	38	173
8.2	±0.1	3.0	142	78	8.701	168	121	10.17	52	160	11.56	34	167
9.1	±0.1	2.9	135	74	9.676	159	118	11.57	49	154	13.49	32	161
10	±1%	2.8	128	70	10.65	151	114	12.96	45	148	15.41	29	155
11	±1%	2.7	120	66	11.73	141	110	14.52	42	142	17.55	27	148
12	±1%	2.5	112	62	12.82	132	105	16.07	39	135	19.68	24	141
13	±1%	2.4	105	58	13.92	124	104	17.82	36	135	22.38	22	142
14	±1%	2.4	98	54	15.02	116	103	19.57	32	135	25.08	19	142
15	±1%	2.3	91	50	16.12	108	102	21.32	29	135	27.78	17	143
16	±1%	2.2	86	47	17.37	102	103	24.04	27	135	NA	NA	NA
17	±1%	2.2	81	44	18.63	96	105	26.76	25	136	NA	NA	NA
18	±1%	2.1	76	42	19.88	90	106	29.48	23	136	NA	NA	NA
19	±1%	2.1	71	39	21.14	83	108	32.20	21	136	NA	NA	NA
20	±1%	2.1	65	36	22.39	77	109	34.92	19	136	NA	NA	NA
22	±1%	2.0	55	30	24.90	65	112	40.36	15	137	NA	NA	NA



0402 Typical Electrical Tables

1

Capacitance @ 1MHz and Tolerance		Self Resonance Frequency (GHz) Typ.	Q Standard Value @ 1GHz		Frequency 900MHz			Frequency 1900MHz			Frequency 2400MHz		
C (pF)	Tol.		Typ.	Min.	C(eff) (pF) Typ.	Q Typ.	ESR (mOhm) Typ.	C(eff) (pF) Typ.	Q Typ.	ESR (mOhm) Typ.	C(eff) (pF) Typ.	Q Typ.	ESR (mOhm) Typ.
0.05	±0.02	20.9	856	471	0.06	881	1411	0.06	562	1216	0.06	498	983
0.1	±0.02	19.4	848	466	0.11	873	1316	0.11	554	1115	0.11	490	914
0.15	±0.02	17.9	840	462	0.16	866	1222	0.16	547	1013	0.16	482	845
0.2	±0.02	16.4	832	457	0.21	858	1128	0.21	539	912	0.22	474	776
0.25	±0.02	15.5	823	453	0.26	850	1033	0.27	532	810	0.27	465	707
0.3	±0.02	14.6	815	448	0.31	842	939	0.32	525	708	0.32	457	638
0.35	±0.02	14.1	807	444	0.36	834	844	0.37	517	607	0.37	449	569
0.4	±0.02	12.5	799	439	0.41	827	750	0.42	510	505	0.42	441	500
0.45	±0.02	11.9	791	435	0.46	819	667	0.47	502	458	0.48	432	453
0.5	±0.02	11.3	783	430	0.51	811	583	0.52	495	410	0.53	424	407
0.55	±0.02	10.9	774	426	0.57	803	500	0.57	487	363	0.58	416	360
0.6	±0.02	10.4	766	421	0.62	796	465	0.62	480	343	0.63	408	339
0.65	±0.02	10.0	758	417	0.67	788	431	0.67	472	322	0.68	399	317
0.7	±0.02	9.5	750	413	0.72	780	396	0.72	465	302	0.73	391	296
0.75	±0.02	9.3	746	410	0.77	776	375	0.78	456	290	0.79	381	285
0.8	±0.02	9.1	743	408	0.82	772	354	0.83	447	277	0.84	370	273
0.85	±0.02	9.0	739	406	0.87	768	334	0.88	438	265	0.89	360	262
0.9	±0.02	8.8	735	404	0.92	764	313	0.93	429	253	0.95	350	250
0.95	±0.02	8.4	732	402	0.97	760	292	0.98	420	240	1.00	339	239
1	±0.02	8.0	728	400	1.02	756	271	1.04	411	228	1.05	329	227
1.05	±0.02	7.9	725	398	1.07	752	258	1.09	406	221	1.11	323	221
1.1	±0.02	7.8	721	397	1.12	749	245	1.14	401	214	1.16	318	214
1.15	±0.02	7.6	718	395	1.17	745	232	1.20	396	207	1.22	312	208
1.2	±0.02	7.4	714	393	1.22	742	218	1.25	391	200	1.27	306	202
1.25	±0.02	7.2	711	391	1.27	738	205	1.31	386	193	1.32	301	195
1.3	±0.02	7.0	707	389	1.32	734	192	1.36	381	185	1.38	295	189
1.35	±0.02	6.9	704	387	1.37	731	179	1.41	376	178	1.43	289	183
1.4	±0.02	6.8	700	385	1.42	727	165	1.47	371	171	1.49	283	177
1.45	±0.02	6.7	697	383	1.47	724	152	1.52	366	164	1.54	278	170
1.5	±0.02	6.5	693	381	1.52	720	139	1.58	361	157	1.60	272	164
1.55	±0.02	6.5	690	379	1.56	716	135	1.62	358	153	1.65	269	159
1.6	±0.02	6.5	686	377	1.61	713	130	1.67	355	148	1.70	267	155
1.65	±0.02	6.5	683	375	1.66	709	126	1.72	352	143	1.76	264	150
1.7	±0.02	6.4	679	373	1.71	705	122	1.77	349	139	1.81	261	146
1.75	±0.02	6.3	676	372	1.75	702	118	1.82	347	134	1.86	259	141
1.8	±0.02	6.2	672	370	1.80	698	113	1.87	344	130	1.92	256	137
1.85	±0.02	6.1	669	368	1.85	694	109	1.92	341	125	1.97	253	132
1.9	±0.02	6.0	665	366	1.90	690	105	1.97	338	121	2.02	251	128
1.95	±0.02	5.9	662	364	1.94	687	101	2.01	335	116	2.08	248	123
2	±0.03	5.7	658	362	1.99	683	96	2.06	332	112	2.13	245	119
2.1	±0.03	5.4	651	358	2.10	676	93	2.18	326	108	2.26	241	115
2.2	±0.03	5.1	643	354	2.21	669	89	2.30	321	104	2.38	236	112
2.3	±0.03	5.0	636	350	2.31	662	85	2.42	315	101	2.51	231	109
2.4	±0.03	4.9	629	346	2.42	656	81	2.54	309	97	2.64	226	106
2.5	±0.03	4.7	622	342	2.53	649	77	2.65	303	94	2.76	221	102
2.6	±0.03	4.6	614	338	2.64	642	74	2.77	298	90	2.89	216	99
2.7	±0.03	4.5	607	334	2.75	635	70	2.89	292	86	3.02	211	96
2.8	±0.03	4.5	600	330	2.85	628	68	3.01	288	83	3.15	207	92
2.9	±0.03	4.4	592	326	2.95	621	66	3.13	283	80	3.28	203	88
3	±0.03	4.4	585	322	3.06	614	64	3.24	279	76	3.41	200	84
3.1	±0.05	4.4	578	318	3.16	607	62	3.36	274	73	3.54	196	80
3.2	±0.05	4.3	570	314	3.27	600	60	3.48	270	70	3.67	192	76
3.3	±0.05	4.3	563	310	3.37	593	58	3.60	265	67	3.80	188	72
3.4	±0.05	4.3	556	306	3.47	586	57	3.71	261	63	3.93	184	68
3.5	±0.05	4.2	548	302	3.58	579	55	3.83	256	60	4.06	180	64
3.6	±0.05	4.2	541	298	3.68	572	53	3.95	252	57	4.19	177	60
3.7	±0.05	4.1	534	294	3.78	565	51	4.06	247	54	4.32	173	56
3.8	±0.05	4.0	526	289	3.89	558	49	4.18	243	50	4.45	169	52
3.9	±0.05	3.9	519	285	3.99	551	47	4.30	238	47	4.58	165	48

0402 Typical Electrical Tables

Capacitance @ 1MHz and Tolerance		Self Resonance Frequency (GHz) Typ.	Q Standard Value @ 1GHz		Frequency 900MHz			Frequency 1900MHz			Frequency 2400MHz		
C (pF)	Tol.		Typ.	Min.	C(eff) (pF) Typ.	Q Typ.	ESR (mOhm) Typ.	C(eff) (pF) Typ.	Q Typ.	ESR (mOhm) Typ.	C(eff) (pF) Typ.	Q Typ.	ESR (mOhm) Typ.
4	±0.05	3.9	513	282	4.10	545	47	4.42	235	47	4.73	162	48
4.1	±0.05	3.8	507	279	4.20	539	47	4.55	232	46	4.87	160	48
4.2	±0.05	3.8	501	275	4.30	534	46	4.67	228	46	5.01	157	48
4.3	±0.05	3.7	495	272	4.41	528	46	4.79	225	46	5.16	154	48
4.4	±0.05	3.7	489	269	4.51	522	46	4.92	222	46	5.30	151	47
4.5	±0.05	3.6	483	265	4.61	516	46	5.04	219	45	5.44	149	47
4.6	±0.05	3.6	477	262	4.72	511	45	5.16	216	45	5.59	146	47
4.7	±0.05	3.5	471	259	4.82	505	45	5.29	213	45	5.73	143	47
5.1	±0.05	3.4	446	245	5.23	482	44	5.78	200	43	6.30	133	47
5.6	±0.05	3.3	416	229	5.75	453	43	6.40	184	42	7.02	119	46
6.2	±0.1	3.0	388	213	6.41	427	44	7.26	167	44	8.11	107	47
6.8	±0.1	2.8	360	198	7.07	400	44	8.12	150	45	9.19	95	48
7.5	±0.1	2.7	338	186	7.85	378	45	9.17	139	47	10.57	86	49
8.2	±0.1	2.6	315	173	8.62	356	45	10.22	128	48	11.95	77	50
9.1	±0.1	2.5	292	160	9.63	333	45	11.75	115	47	14.23	69	50
10	±1%	2.4	268	148	10.65	310	45	13.28	103	47	16.50	61	49
11	±1%	2.3	242	133	11.77	285	44	14.98	89	46	19.04	51	49
12	±1%	2.2	217	119	12.90	259	44	16.68	75	45	21.57	42	48
13	±1%	2.2	202	111	14.03	241	44	18.83	68	47	25.73	38	49
14	±1%	2.1	187	103	15.17	223	44	20.97	62	49	29.89	33	49
15	±1%	2.1	172	94	16.30	204	45	23.12	56	51	34.05	29	50
16	±1%	2.0	157	87	17.53	187	44	25.91	50	49	41.44	25	49
17	±1%	1.9	143	79	18.75	169	43	28.70	45	46	48.82	21	47
18	±1%	1.8	129	71	19.98	152	42	31.49	39	44	56.21	17	46
19	±1%	1.8	121	67	21.11	143	42	33.51	36	44	60.92	15	47
20	±1%	1.8	110	61	22.25	131	41	35.53	33	43	65.63	14	48
22	±1%	1.8	98	54	24.51	116	41	39.57	26	42	75.05	10	51
24	±1%	1.8	87	48	27.51	104	37	54.94	21	35	NA	NA	NA
27	±1%	1.7	70	39	32.01	85	32	77.98	13	23	NA	NA	NA
30	±1%	1.7	65	36	35.89	78	28	106.50	10	12	NA	NA	NA
33	±1%	1.7	60	33	40.05	74	27	NA	NA	NA	NA	NA	NA
36	±1%	1.7	58	32	45.13	71	28	NA	NA	NA	NA	NA	NA
39	±1%	1.7	56	31	50.21	69	28	NA	NA	NA	NA	NA	NA
43	±1%	1.6	53	29	56.98	66	29	NA	NA	NA	NA	NA	NA
47	±1%	1.6	50	28	63.75	63	30	NA	NA	NA	NA	NA	NA
51	±1%	1.6	48	26	70.53	60	31	NA	NA	NA	NA	NA	NA
56	±1%	1.6	44	24	78.99	56	33	NA	NA	NA	NA	NA	NA
58	±1%	1.6	42	23	83.54	54	34	NA	NA	NA	NA	NA	NA
68	±1%	1.6	32	18	106.28	42	40	NA	NA	NA	NA	NA	NA



0603 Typical Electrical Tables

1

Capacitance @ 1MHz and Tolerance		Self Resonance Frequency (GHz) Typ.	Q Standard Value @ 1GHz		Frequency 900MHz			Frequency 1900MHz			Frequency 2400MHz		
C (pF)	Tol.		Typ.	Min.	C(eff) (pF) Typ.	Q Typ.	ESR (mOhm) Typ.	C(eff) (pF) Typ.	Q Typ.	ESR (mOhm) Typ.	C(eff) (pF) Typ.	Q Typ.	ESR (mOhm) Typ.
0.05	±0.02	25.6	1200	660	0.06	1333	945	0.06	556	832	0.06	397	880
0.1	±0.02	18.1	1156	636	0.11	1284	675	0.11	535	628	0.11	382	667
0.15	±0.02	14.8	1111	611	0.16	1235	555	0.16	514	533	0.16	367	567
0.2	±0.02	12.8	1067	587	0.21	1185	483	0.21	494	474	0.22	353	505
0.25	±0.02	11.4	1022	562	0.26	1136	433	0.27	473	433	0.27	338	462
0.3	±0.02	10.4	978	538	0.31	1086	397	0.32	453	402	0.32	323	430
0.35	±0.02	9.7	933	513	0.36	1037	368	0.37	432	378	0.37	309	404
0.4	±0.02	9.0	889	489	0.41	988	345	0.42	412	358	0.42	294	383
0.45	±0.02	8.5	844	464	0.46	938	326	0.47	391	341	0.48	279	365
0.5	±0.02	8.1	800	440	0.51	889	310	0.52	370	327	0.53	265	350
0.55	±0.02	7.7	788	434	0.57	875	296	0.57	363	315	0.58	261	337
0.6	±0.02	7.4	777	427	0.62	860	283	0.62	356	304	0.63	258	326
0.65	±0.02	7.1	765	421	0.67	846	273	0.67	348	294	0.68	255	315
0.7	±0.02	6.8	754	414	0.72	832	263	0.72	341	285	0.73	252	306
0.75	±0.02	6.6	742	408	0.77	817	254	0.78	334	277	0.79	248	298
0.8	±0.02	6.4	730	402	0.82	803	247	0.83	326	270	0.84	245	290
0.85	±0.02	6.2	719	395	0.87	789	239	0.88	319	264	0.89	242	283
0.9	±0.02	6.0	707	389	0.92	775	233	0.93	312	258	0.95	239	277
0.95	±0.02	5.9	696	383	0.97	760	227	0.98	304	252	1.00	235	271
1	±0.02	5.7	684	376	1.019	746	216	1.061	297	242	1.101	232	260
1.05	±0.02	5.6	667	367	1.076	731	213	1.126	290	239	1.171	226	256
1.1	±0.02	5.4	649	357	1.134	717	210	1.190	282	236	1.241	220	253
1.15	±0.02	5.3	632	347	1.192	702	206	1.254	275	233	1.311	214	250
1.2	±0.02	5.2	614	338	1.250	687	203	1.318	267	230	1.381	209	247
1.25	±0.02	5.1	605	333	1.307	677	200	1.382	262	227	1.451	203	244
1.3	±0.02	5.0	596	328	1.365	667	197	1.446	257	224	1.521	197	241
1.35	±0.02	4.9	587	323	1.423	658	194	1.511	252	221	1.591	191	238
1.4	±0.02	4.8	578	318	1.481	648	190	1.575	247	218	1.661	185	235
1.45	±0.02	4.8	569	313	1.538	638	187	1.639	242	215	1.731	179	232
1.5	±0.02	4.7	560	308	1.596	628	184	1.703	237	212	1.801	173	229
1.55	±0.02	4.6	551	303	1.645	620	181	1.760	233	209	1.866	170	226
1.6	±0.02	4.5	542	298	1.694	611	178	1.817	228	206	1.930	166	222
1.65	±0.02	4.5	534	293	1.743	603	175	1.874	224	203	1.995	163	219
1.7	±0.02	4.4	525	289	1.792	595	172	1.931	219	200	2.060	159	216
1.75	±0.02	4.3	516	284	1.841	587	169	1.988	215	197	2.124	156	213
1.8	±0.02	4.2	507	279	1.890	578	166	2.045	211	194	2.189	153	209
1.85	±0.02	4.2	498	274	1.939	570	163	2.102	206	191	2.253	149	206
1.9	±0.02	4.1	490	269	1.988	562	160	2.158	202	188	2.318	146	203
1.95	±0.02	4.1	481	264	2.037	553	157	2.215	197	185	2.383	142	199
2	±0.03	4.0	472	260	2.086	545	154	2.272	193	182	2.447	139	196
2.1	±0.03	3.9	462	254	2.190	535	151	2.402	187	180	2.604	134	193
2.2	±0.03	3.8	452	249	2.295	524	148	2.532	181	177	2.761	129	191
2.3	±0.03	3.8	442	243	2.400	514	145	2.662	175	175	2.917	124	188
2.4	±0.03	3.7	433	238	2.504	503	143	2.793	168	172	3.074	118	186
2.5	±0.03	3.6	423	232	2.609	493	140	2.923	162	170	3.230	113	183
2.6	±0.03	3.6	413	227	2.714	482	137	3.053	156	167	3.387	108	181
2.7	±0.03	3.5	403	222	2.818	472	134	3.183	150	165	3.543	103	178
2.8	±0.03	3.4	395	217	2.933	463	133	3.336	147	164	3.742	100	177
2.9	±0.03	3.4	388	213	3.047	453	131	3.489	144	162	3.940	97	175
3	±0.03	3.3	380	209	3.162	444	130	3.642	140	161	4.139	95	174
3.1	±0.05	3.2	372	205	3.276	435	129	3.795	137	160	4.337	92	172
3.2	±0.05	3.2	365	201	3.391	425	127	3.947	134	159	4.536	89	171
3.3	±0.05	3.1	357	196	3.506	416	126	4.100	131	157	4.734	86	169
3.4	±0.05	3.1	349	192	3.620	407	125	4.253	128	156	4.933	84	168
3.5	±0.05	3.1	342	188	3.735	397	123	4.406	125	155	5.131	81	166
3.6	±0.05	3.0	334	184	3.849	388	122	4.559	121	154	5.330	78	165
3.7	±0.05	3.0	326	179	3.964	379	121	4.712	118	152	5.528	75	164
3.8	±0.05	3.0	318	175	4.078	369	119	4.865	115	151	5.727	73	162
3.9	±0.05	2.9	311	171	4.193	360	118	5.018	112	150	5.925	70	161

0603 Typical Electrical Tables

Capacitance @ 1MHz and Tolerance		Self Resonance Frequency (GHz) Typ.	Q Standard Value @ 1GHz		Frequency 900MHz			Frequency 1900MHz			Frequency 2400MHz		
C (pF)	Tol.		Typ.	Min.	C(eff) (pF) Typ.	Q Typ.	ESR (mOhm) Typ.	C(eff) (pF) Typ.	Q Typ.	ESR (mOhm) Typ.	C(eff) (pF) Typ.	Q Typ.	ESR (mOhm) Typ.
4	±0.05	2.9	307	169	4.301	355	117	5.188	110	149	6.188	68	160
4.1	±0.05	2.8	303	167	4.410	351	116	5.358	108	148	6.450	67	159
4.2	±0.05	2.8	299	164	4.518	347	116	5.528	106	148	6.713	65	158
4.3	±0.05	2.7	295	162	4.627	342	115	5.698	104	147	6.975	64	157
4.4	±0.05	2.7	291	160	4.735	338	114	5.867	102	146	7.238	62	157
4.5	±0.05	2.7	287	158	4.843	333	113	6.037	100	146	7.500	61	156
4.6	±0.05	2.6	283	156	4.952	329	112	6.207	98	145	7.763	59	155
4.7	±0.05	2.6	279	154	5.060	324	112	6.377	96	144	8.025	58	154
5.1	±0.05	2.5	263	145	5.494	307	109	7.057	88	142	9.075	52	151
5.6	±0.05	2.4	244	134	6.035	285	105	7.906	78	138	10.39	44	147
6.2	±0.1	2.3	228	126	6.865	267	102	9.517	72	133	13.66	40	141
6.8	±0.1	2.2	213	117	7.694	250	100	11.13	66	128	16.93	35	135
7.5	±0.1	2.1	195	107	8.367	227	98	12.63	57	125	20.91	28	132
8.2	±0.1	2.0	176	97	9.041	205	96	14.14	49	123	24.88	21	129
9.1	±0.1	1.9	161	89	10.20	188	96	18.09	42	122	40.00	16	128
10	±1%	1.8	146	80	11.37	171	95	22.05	36	121	70.00	12	127
11	±1%	1.7	129	71	12.66	153	95	26.44	29	120	140.0	6	126
12	±1%	1.6	112	62	13.95	134	94	30.83	22	119	231.3	1	125
13	±1%	1.6	102	56	15.31	122	93	40.37	18	118	n/a	n/a	n/a
14	±1%	1.5	92	51	16.67	111	92	49.91	15	118	n/a	n/a	n/a
15	±1%	1.5	82	45	18.03	99	90	59.44	11	117	n/a	n/a	n/a
16	±1%	1.4	79	43	19.61	96	90	80.00	8	117	n/a	n/a	n/a
17	±1%	1.4	76	42	21.18	92	90	120.0	6	116	n/a	n/a	n/a
18	±1%	1.3	73	40	22.76	89	90	190.0	4	116	n/a	n/a	n/a
19	±1%	1.3	69	38	24.37	84	89	n/a	n/a	n/a	n/a	n/a	n/a
20	±1%	1.2	65	36	25.98	80	89	n/a	n/a	n/a	n/a	n/a	n/a
22	±1%	1.2	57	31	29.21	72	87	n/a	n/a	n/a	n/a	n/a	n/a
24	±1%	1.2	48	26	34.44	62	87	n/a	n/a	n/a	n/a	n/a	n/a
27	±1%	1.1	43	24	41.87	56	86	n/a	n/a	n/a	n/a	n/a	n/a
30	±1%	1.0	37	21	49.29	49	85	n/a	n/a	n/a	n/a	n/a	n/a
33	±1%	1.0	32	18	56.72	43	84	n/a	n/a	n/a	n/a	n/a	n/a
36	±1%	1.0	27	15	64.15	37	83	n/a	n/a	n/a	n/a	n/a	n/a
39	±1%	1.0	21	12	71.57	30	82	n/a	n/a	n/a	n/a	n/a	n/a



0805 Typical Electrical Tables

1

Capacitance @ 1MHz and Tolerance		Self Resonance Frequency (GHz) Typ.	Q Standard Value @ 1GHz		Frequency 900MHz			Frequency 1900MHz			Frequency 2400MHz		
C (pF)	Tol.		Typ.	Min.	C(eff) (pF) Typ.	Q Typ.	ESR (mOhm) Typ.	C(eff) (pF) Typ.	Q Typ.	ESR (mOhm) Typ.	C(eff) (pF) Typ.	Q Typ.	ESR (mOhm) Typ.
0.1	±0.02	17.2	880	484	0.125	890	3296	0.125	545	2417	0.126	447	2265
0.15	±0.02	14.1	872	480	0.176	885	2073	0.178	530	1626	0.181	434	1546
0.2	±0.02	12.3	864	475	0.228	880	1492	0.231	516	1227	0.235	420	1178
0.25	±0.02	11.0	857	471	0.279	874	1156	0.284	501	986	0.290	407	955
0.3	±0.02	10.1	849	467	0.331	869	938	0.337	487	825	0.344	394	804
0.35	±0.02	9.4	841	462	0.382	864	787	0.390	472	710	0.399	380	695
0.4	±0.02	8.8	833	458	0.433	859	675	0.443	458	623	0.453	367	613
0.45	±0.02	8.3	825	454	0.485	853	590	0.496	443	555	0.508	353	549
0.5	±0.02	7.9	817	450	0.536	848	523	0.549	429	501	0.562	340	497
0.55	±0.02	7.5	811	446	0.584	843	469	0.600	420	456	0.616	331	454
0.6	±0.02	7.2	805	443	0.631	838	425	0.651	411	419	0.670	322	418
0.65	±0.02	6.9	798	439	0.679	834	387	0.702	402	387	0.724	313	388
0.7	±0.02	6.7	792	436	0.726	829	356	0.753	393	360	0.778	304	362
0.75	±0.02	6.5	786	432	0.774	824	329	0.804	384	337	0.832	295	339
0.8	±0.02	6.3	779	429	0.822	819	306	0.855	375	316	0.886	286	319
0.85	±0.02	6.1	773	425	0.869	814	285	0.906	366	298	0.940	277	301
0.9	±0.02	5.9	767	422	0.917	810	267	0.957	357	282	0.994	268	285
0.95	±0.02	5.8	760	418	0.964	805	251	1.008	348	267	1.049	260	271
1	±0.02	5.6	754	415	1.012	800	231	1.059	339	235	1.103	251	242
1.05	±0.02	5.5	747	411	1.065	794	223	1.120	335	228	1.170	247	235
1.1	±0.02	5.4	740	407	1.119	788	215	1.181	330	221	1.237	244	228
1.15	±0.02	5.3	732	403	1.172	782	208	1.242	326	214	1.304	240	220
1.2	±0.02	5.1	725	399	1.225	776	200	1.304	322	207	1.371	237	213
1.25	±0.02	5.0	718	395	1.279	770	192	1.365	318	200	1.438	233	206
1.3	±0.02	4.9	711	391	1.332	764	184	1.426	313	193	1.505	230	199
1.35	±0.02	4.9	704	387	1.386	758	176	1.487	309	186	1.573	226	192
1.4	±0.02	4.8	696	383	1.439	752	169	1.548	305	179	1.640	223	184
1.45	±0.02	4.7	689	379	1.492	746	161	1.609	300	172	1.707	219	177
1.5	±0.02	4.6	682	375	1.546	740	153	1.670	296	165	1.774	216	170
1.55	±0.02	4.6	675	371	1.600	733	151	1.734	292	163	1.850	212	168
1.6	±0.02	4.5	668	367	1.654	726	148	1.799	287	161	1.927	208	165
1.65	±0.02	4.4	660	363	1.708	719	146	1.864	283	159	2.003	204	163
1.7	±0.02	4.3	653	359	1.762	712	143	1.928	278	157	2.079	200	160
1.75	±0.02	4.3	646	355	1.816	705	141	1.993	274	155	2.156	197	158
1.8	±0.02	4.2	639	351	1.870	698	139	2.058	269	152	2.232	193	155
1.85	±0.02	4.2	632	347	1.924	691	136	2.122	265	150	2.308	189	153
1.9	±0.02	4.1	624	343	1.978	684	134	2.187	260	148	2.385	185	150
1.95	±0.02	4.1	617	339	2.033	677	131	2.252	256	146	2.461	181	148
2	±0.03	4.0	610	336	2.087	670	129	2.316	251	144	2.537	177	145
2.1	±0.03	3.9	597	328	2.183	658	127	2.440	245	142	2.690	171	143
2.2	±0.03	3.8	584	321	2.280	646	124	2.563	239	139	2.843	165	141
2.3	±0.03	3.8	571	314	2.377	634	122	2.687	233	137	2.996	159	139
2.4	±0.03	3.6	557	307	2.474	623	119	2.810	227	135	3.149	154	136
2.5	±0.03	3.6	544	299	2.571	611	117	2.934	221	133	3.301	148	134
2.6	±0.03	3.6	531	292	2.668	599	114	3.057	215	130	3.454	142	132
2.7	±0.03	3.4	518	285	2.764	587	112	3.181	209	128	3.607	136	130
2.8	±0.03	3.4	507	279	2.875	575	111	3.348	204	127	3.850	132	129
2.9	±0.03	3.4	497	273	2.987	564	110	3.514	199	125	4.093	129	127
3	±0.03	3.3	486	267	3.098	552	109	3.681	194	124	4.335	125	126
3.1	±0.05	3.3	475	261	3.209	540	108	3.848	189	123	4.578	121	125
3.2	±0.05	3.2	465	256	3.320	528	107	4.014	183	122	4.821	118	123
3.3	±0.05	3.1	454	250	3.431	517	106	4.181	178	120	5.064	114	122
3.4	±0.05	3.1	443	244	3.542	505	105	4.348	173	119	5.307	110	121
3.5	±0.05	3.1	433	238	3.653	493	104	4.515	168	118	5.549	107	119
3.6	±0.05	3.0	422	232	3.764	481	103	4.681	163	116	5.792	103	118
3.7	±0.05	3.0	412	226	3.875	470	102	4.848	158	115	6.035	99	116
3.8	±0.05	3.0	401	220	3.986	458	101	5.015	153	114	6.278	96	115
3.9	±0.05	2.9	390	215	4.097	446	100	5.182	148	113	6.521	92	114

0805 Typical Electrical Tables

Capacitance @ 1MHz and Tolerance		Self Resonance Frequency (GHz) Typ.	Q Standard Value @ 1GHz		Frequency 900MHz			Frequency 1900MHz			Frequency 2400MHz		
C (pF)	Tol.		Typ.	Min.	C(eff) (pF) Typ.	Q Typ.	ESR (mOhm) Typ.	C(eff) (pF) Typ.	Q Typ.	ESR (mOhm) Typ.	C(eff) (pF) Typ.	Q Typ.	ESR (mOhm) Typ.
4	±0.05	2.9	384	211	4.214	440	99	5.378	144	112	6.861	89	113
4.1	±0.05	2.9	378	208	4.331	434	98	5.574	141	112	7.201	86	113
4.2	±0.05	2.8	372	205	4.448	428	98	5.769	138	111	7.541	84	112
4.3	±0.05	2.7	366	202	4.564	422	97	5.965	134	111	7.881	81	111
4.4	±0.05	2.7	360	198	4.681	415	96	6.161	131	110	8.222	78	111
4.5	±0.05	2.7	355	195	4.798	409	96	6.357	128	110	8.562	75	110
4.6	±0.05	2.7	349	192	4.915	403	95	6.553	124	109	8.902	72	110
4.7	±0.05	2.6	343	188	5.032	397	94	6.749	121	109	9.242	69	109
5.1	±0.05	2.5	319	175	5.499	373	91	7.533	108	107	10.60	58	107
5.6	±0.05	2.4	289	159	6.083	342	88	8.513	91	104	12.30	44	104
6.2	±0.1	2.3	264	145	6.842	313	86	10.43	79	102	18.03	36	103
6.8	±0.1	2.2	239	131	7.601	283	84	12.35	68	101	23.76	28	102
7.5	±0.1	2.1	218	120	8.468	259	83	14.84	61	100	37.25	21	101
8.2	±0.1	2.0	198	109	9.334	234	82	17.32	55	100	50.74	15	100
9.1	±0.1	1.9	179	99	10.57	213	82	24.90	46	100	n/a	n/a	n/a
10	±1%	1.8	160	88	11.80	191	81	32.48	37	100	n/a	n/a	n/a
11	±1%	1.7	139	77	13.17	167	81	40.90	26	101	n/a	n/a	n/a
12	±1%	1.6	119	65	14.54	143	80	49.32	16	101	n/a	n/a	n/a
13	±1%	1.6	110	60	16.17	134	80	n/a	n/a	n/a	n/a	n/a	n/a
14	±1%	1.5	101	55	17.79	125	80	n/a	n/a	n/a	n/a	n/a	n/a
15	±1%	1.5	92	51	19.42	116	80	n/a	n/a	n/a	n/a	n/a	n/a
16	±1%	1.4	87	48	21.13	110	79	n/a	n/a	n/a	n/a	n/a	n/a
17	±1%	1.4	83	46	22.85	104	78	n/a	n/a	n/a	n/a	n/a	n/a
18	±1%	1.3	78	43	24.57	99	77	n/a	n/a	n/a	n/a	n/a	n/a
19	±1%	1.3	73	40	26.41	92	77	n/a	n/a	n/a	n/a	n/a	n/a
20	±1%	1.3	67	37	28.26	85	76	n/a	n/a	n/a	n/a	n/a	n/a
22	±1%	1.2	57	31	31.95	72	76	n/a	n/a	n/a	n/a	n/a	n/a
24	±1%	1.2	46	25	35.64	59	75	n/a	n/a	n/a	n/a	n/a	n/a
27	±1%	1.1	41	22	44.94	54	74	n/a	n/a	n/a	n/a	n/a	n/a
30	±1%	1.0	36	20	54.24	48	73	n/a	n/a	n/a	n/a	n/a	n/a
33	±1%	1.0	30	17	63.54	42	72	n/a	n/a	n/a	n/a	n/a	n/a
36	±1%	0.9	25	14	72.84	37	71	n/a	n/a	n/a	n/a	n/a	n/a
39	±1%	0.9	20	11	82.14	31	70	n/a	n/a	n/a	n/a	n/a	n/a
43	±1%	0.9	16	9	102.9	27	66	n/a	n/a	n/a	n/a	n/a	n/a
47	±1%	0.8	12	7	123.7	23	63	n/a	n/a	n/a	n/a	n/a	n/a



1210 Typical Electrical Tables

1

Capacitance @ 1MHz and Tolerance		Self Resonance Frequency (GHz) Typ.	Q Standard Value @ 1GHz		Frequency 900MHz			Frequency 1900MHz			Frequency 2400MHz		
C (pF)	Tol.		Typ.	Min.	C(eff) (pF) Typ.	Q Typ.	ESR (mOhm) Typ.	C(eff) (pF) Typ.	Q Typ.	ESR (mOhm) Typ.	C(eff) (pF) Typ.	Q Typ.	ESR (mOhm) Typ.
0.1	±0.02	15.6	1190	654	0.136	1176	3633	0.136	606	2149	0.136	450	2068
0.15	±0.03	12.7	1179	648	0.190	1166	2129	0.190	597	1407	0.191	444	1370
0.2	±0.02	11.0	1168	642	0.244	1156	1457	0.244	589	1042	0.246	438	1023
0.25	±0.02	9.8	1156	636	0.297	1145	1086	0.299	581	826	0.301	432	816
0.3	±0.02	8.9	1145	630	0.351	1135	854	0.353	573	683	0.356	426	678
0.35	±0.02	8.3	1134	624	0.405	1125	697	0.408	565	581	0.411	421	580
0.4	±0.02	7.7	1123	618	0.459	1115	584	0.462	557	505	0.466	415	506
0.45	±0.02	7.3	1112	612	0.513	1105	500	0.516	549	447	0.521	409	449
0.5	±0.02	6.9	1101	606	0.567	1095	435	0.571	541	400	0.576	403	404
0.55	±0.02	6.6	1090	599	0.617	1084	384	0.621	532	362	0.627	397	366
0.6	±0.02	6.3	1079	593	0.666	1074	342	0.672	524	331	0.679	391	335
0.65	±0.02	6.0	1068	587	0.716	1064	308	0.723	516	304	0.731	385	309
0.7	±0.02	5.8	1057	581	0.765	1054	279	0.774	508	282	0.783	379	287
0.75	±0.02	5.6	1046	575	0.815	1044	255	0.824	500	262	0.834	374	267
0.8	±0.02	5.4	1035	569	0.864	1034	234	0.875	492	245	0.886	368	250
0.85	±0.02	5.3	1023	563	0.914	1024	216	0.926	484	230	0.938	362	236
0.9	±0.02	5.1	1012	557	0.963	1013	201	0.976	476	217	0.989	356	222
0.95	±0.02	5.0	1001	551	1.013	1003	187	1.027	467	205	1.041	350	210
1	±0.02	5.0	992	546	1.062	983	167	1.078	459	170	1.093	344	177
1.05	±0.02	4.9	981	539	1.107	975	163	1.124	451	167	1.141	338	174
1.1	±0.02	4.8	969	533	1.152	966	158	1.170	443	165	1.189	331	172
1.15	±0.02	4.7	958	527	1.196	958	154	1.217	435	162	1.236	325	169
1.2	±0.02	4.6	946	521	1.241	950	150	1.263	427	160	1.284	318	167
1.25	±0.02	4.5	935	514	1.285	942	146	1.309	419	157	1.332	312	164
1.3	±0.02	4.4	923	508	1.330	933	142	1.355	410	155	1.380	305	162
1.35	±0.02	4.3	912	502	1.375	925	138	1.402	402	152	1.428	299	159
1.4	±0.02	4.2	900	495	1.419	917	134	1.448	394	150	1.476	293	156
1.45	±0.02	4.1	889	489	1.464	908	129	1.494	386	147	1.524	286	154
1.5	±0.02	4.1	877	483	1.508	900	125	1.541	378	144	1.572	280	151
1.55	±0.02	4.0	862	474	1.567	890	123	1.618	371	143	1.638	274	150
1.6	±0.02	3.9	846	465	1.626	881	122	1.694	363	142	1.704	268	149
1.65	±0.02	3.9	831	457	1.685	871	120	1.771	356	140	1.770	262	148
1.7	±0.02	3.8	815	448	1.743	862	118	1.848	349	139	1.836	256	147
1.75	±0.02	3.7	800	440	1.802	852	116	1.925	342	138	1.902	250	145
1.8	±0.02	3.7	784	431	1.861	843	114	2.002	334	136	1.968	244	144
1.85	±0.02	3.6	769	423	1.920	833	112	2.079	327	135	2.034	239	143
1.9	±0.02	3.5	753	414	1.978	824	110	2.156	320	134	2.100	233	142
1.95	±0.02	3.4	737	406	2.037	814	108	2.233	313	132	2.167	227	141
2	±0.03	3.3	722	397	2.096	805	107	2.310	305	131	2.233	221	139
2.1	±0.03	3.2	691	380	2.213	786	103	2.464	291	128	2.365	209	137
2.2	±0.03	3.0	660	363	2.331	767	99	2.618	276	126	2.497	198	135
2.3	±0.03	2.9	644	354	2.420	747	97	2.681	268	123	2.613	191	132
2.4	±0.03	2.9	629	346	2.508	728	96	2.744	259	121	2.729	185	130
2.5	±0.03	2.8	614	338	2.597	709	94	2.807	251	118	2.845	179	128
2.6	±0.03	2.8	598	329	2.686	689	93	2.870	242	116	2.961	173	126
2.7	±0.03	2.7	583	321	2.775	670	91	2.933	234	114	3.077	167	123
2.8	±0.03	2.7	574	316	2.875	659	90	3.047	230	113	3.205	164	122
2.9	±0.03	2.7	566	311	2.975	647	89	3.162	227	112	3.334	161	121
3	±0.03	2.7	557	306	3.075	636	88	3.276	223	111	3.462	157	121
3.1	±0.05	2.7	548	302	3.174	625	87	3.390	220	110	3.590	154	120
3.2	±0.05	2.6	540	297	3.274	613	87	3.504	216	109	3.718	151	119
3.3	±0.05	2.6	531	292	3.374	602	86	3.619	213	108	3.847	148	118
3.4	±0.05	2.6	522	287	3.474	591	85	3.733	209	107	3.975	145	117
3.5	±0.05	2.6	514	283	3.574	579	84	3.847	206	106	4.103	141	116
3.6	±0.05	2.5	505	278	3.674	568	83	3.961	202	105	4.231	138	115
3.7	±0.05	2.5	496	273	3.773	556	82	4.076	198	104	4.359	135	114
3.8	±0.05	2.5	488	268	3.873	545	81	4.190	195	103	4.488	132	113
3.9	±0.05	2.4	479	264	3.973	534	80	4.304	191	102	4.616	129	112

Capacitance @ 1MHz and Tolerance		Self Resonance Frequency (GHz) Typ.	Q Standard Value @ 1GHz		Frequency 900MHz			Frequency 1900MHz			Frequency 2400MHz		
C (pF)	Tol.		Typ.	Min.	C(eff) (pF) Typ.	Q Typ.	ESR (mOhm) Typ.	C(eff) (pF) Typ.	Q Typ.	ESR (mOhm) Typ.	C(eff) (pF) Typ.	Q Typ.	ESR (mOhm) Typ.
4	±0.05	2.4	473	260	4.083	528	79	4.435	189	101	4.768	127	112
4.1	±0.05	2.4	467	257	4.192	522	78	4.565	186	100	4.919	125	111
4.2	±0.05	2.4	462	254	4.302	516	78	4.695	183	100	5.071	123	110
4.3	±0.05	2.3	456	251	4.411	511	77	4.825	180	99	5.223	121	110
4.4	±0.05	2.3	450	247	4.521	505	76	4.956	178	98	5.375	119	109
4.5	±0.05	2.3	444	244	4.630	499	75	5.086	175	98	5.526	117	108
4.6	±0.05	2.3	438	241	4.740	493	75	5.216	172	97	5.678	115	108
4.7	±0.05	2.2	432	238	4.849	487	74	5.347	170	96	5.830	113	107
5.1	±0.05	2.1	408	225	5.288	464	71	5.868	159	93	6.437	106	105
5.6	±0.05	2.0	379	208	5.835	435	67	6.519	145	90	7.195	96	102
6.2	±0.1	1.9	355	195	6.440	408	65	7.176	137	86	7.897	91	96
6.8	±0.1	1.8	330	182	7.044	380	62	7.832	129	83	8.599	85	91
7.5	±0.1	1.7	308	169	7.823	351	61	8.927	115	81	10.08	74	89
8.2	±0.1	1.7	285	157	8.601	322	60	10.02	100	78	11.55	63	87
9.1	±0.1	1.6	266	146	9.600	304	58	11.55	93	77	13.93	57	85
10	±1%	1.5	247	136	10.60	285	57	13.09	85	76	16.30	50	84
11	±1%	1.5	225	124	11.71	265	56	14.79	76	74	18.94	43	82
12	±1%	1.4	204	112	12.82	244	54	16.49	68	73	21.57	36	81
13	±1%	1.3	193	106	13.97	230	53	18.64	61	72	26.09	32	80
14	±1%	1.3	181	99	15.13	215	53	20.80	55	71	30.61	28	79
15	±1%	1.2	169	93	16.28	200	52	22.95	48	70	35.13	24	78
16	±1%	1.2	164	90	17.51	195	51	26.01	46	69	46.51	22	76
17	±1%	1.2	159	88	18.75	189	50	29.07	43	67	57.90	19	75
18	±1%	1.1	154	85	19.98	183	49	32.14	41	66	69.29	17	73
19	±1%	1.1	150	82	21.21	178	49	36.34	39	66	n/a	n/a	n/a
20	±1%	1.1	145	80	22.43	172	49	40.55	38	65	n/a	n/a	n/a
22	±1%	1.0	136	75	24.88	162	49	48.96	34	64	n/a	n/a	n/a
24	±1%	1.0	126	70	27.34	151	48	57.38	31	63	n/a	n/a	n/a
27	±1%	0.9	112	62	31.02	135	48	70.00	26	62	n/a	n/a	n/a
30	±1%	0.9	101	56	36.14	121	48	n/a	n/a	n/a	n/a	n/a	n/a
33	±1%	0.8	90	50	41.27	108	48	n/a	n/a	n/a	n/a	n/a	n/a
36	±1%	0.8	79	44	46.39	95	48	n/a	n/a	n/a	n/a	n/a	n/a
39	±1%	0.8	68	38	51.52	82	48	n/a	n/a	n/a	n/a	n/a	n/a
43	±1%	0.7	54	30	58.35	64	48	n/a	n/a	n/a	n/a	n/a	n/a
47	±1%	0.7	39	21	65.18	46	48	n/a	n/a	n/a	n/a	n/a	n/a
82	±1%	0.7	17	10	148.400	24	48	n/a	n/a	n/a	n/a	n/a	n/a

High Frequency Characteristics

1

Accu-P[®] 01005 Typical SRF vs Capacitance

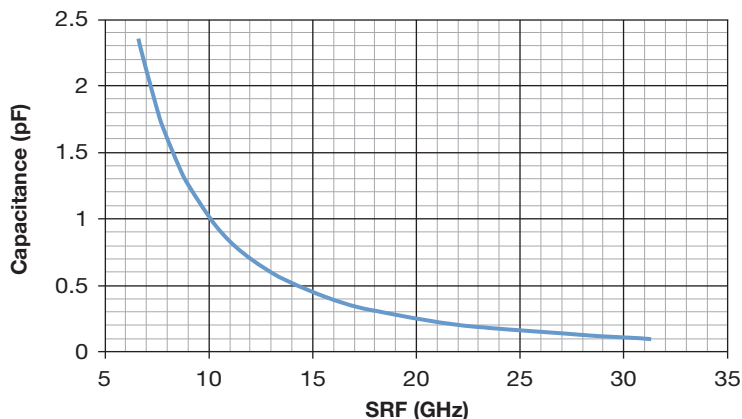

Measured on HP8720ES

Accu-P[®] 01005 Typical ESR vs Frequency

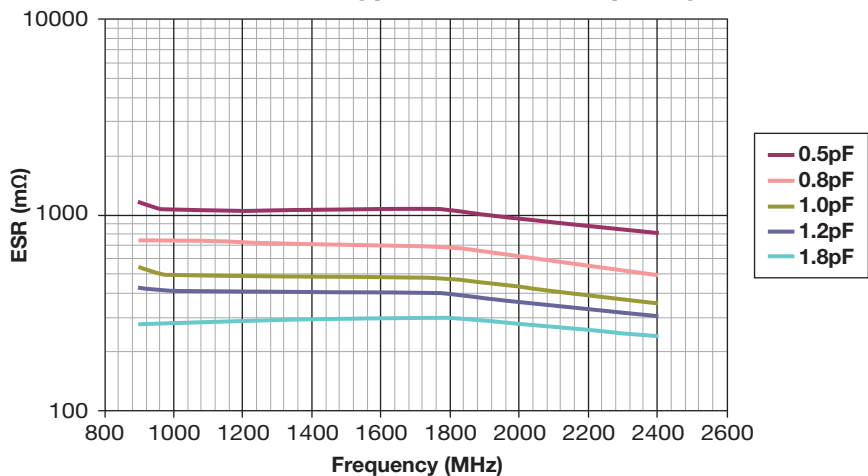

Measured on Agilent 4278A/4991A

Accu-P[®] 01005 Typical Q vs Frequency

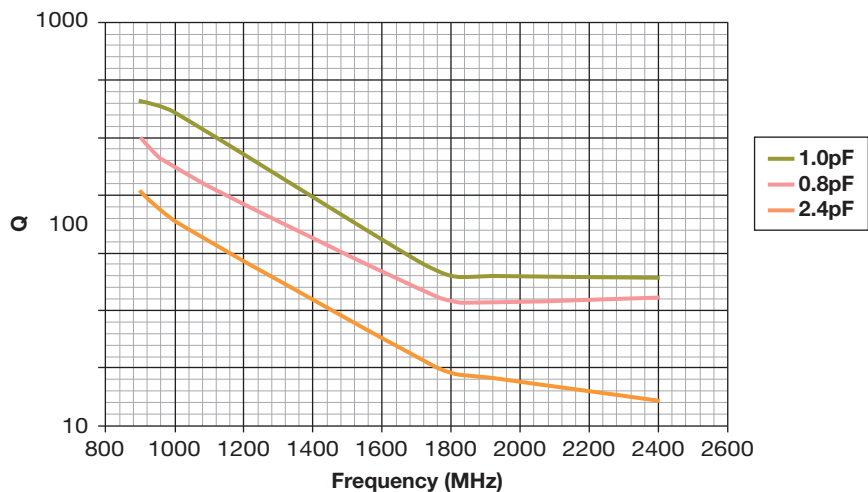

Measured on Agilent 4278A/4991A

Accu-P® 0201 Typical SRF vs Capacitance

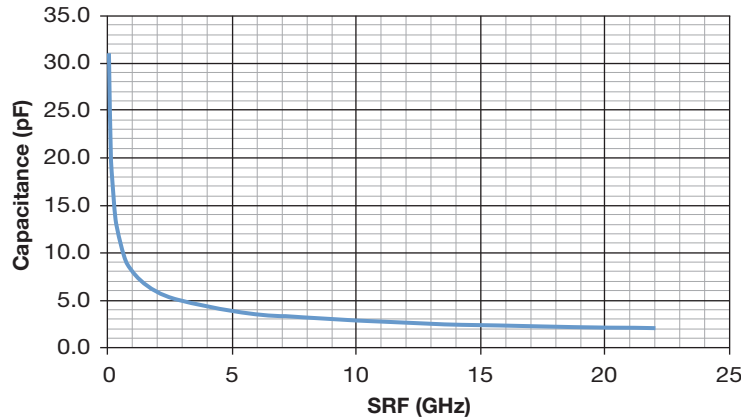

Measured on HP8720ES

Accu-P® 0201 Typical ESR vs Frequency

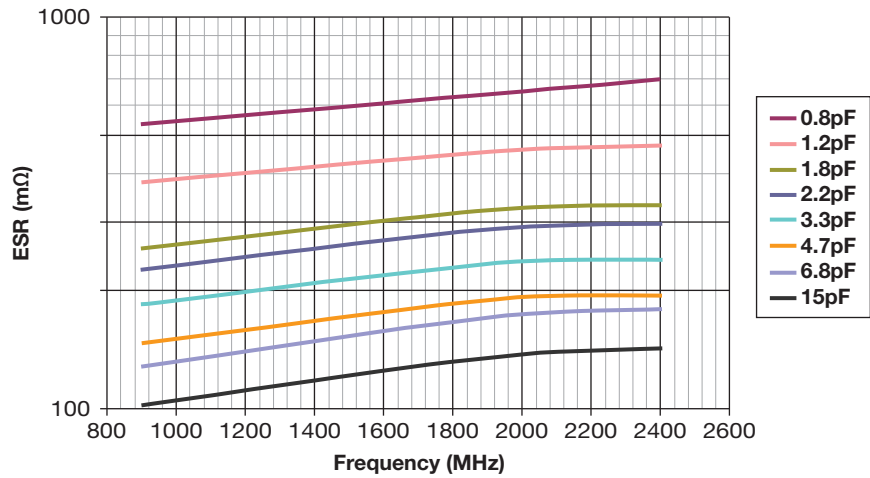

Measured on Agilent 4278A/4991A

Accu-P® 0201 Typical Q vs Frequency

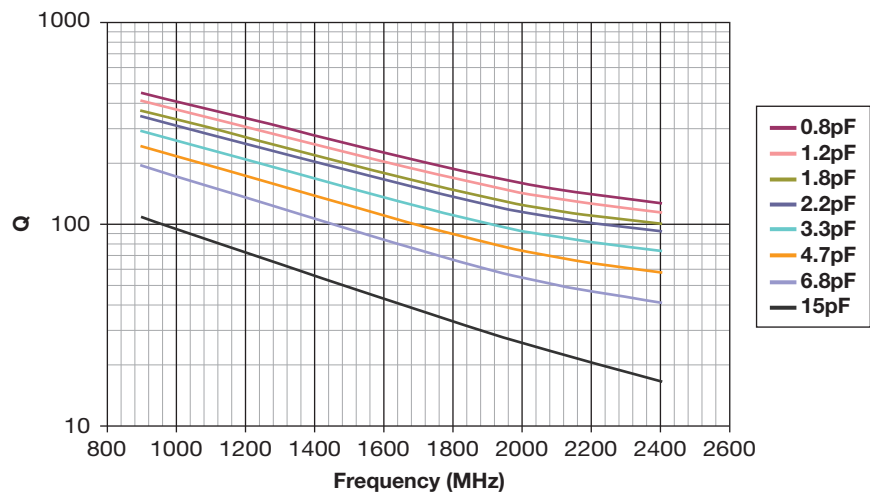

Measured on Agilent 4278A/4991A

High Frequency Characteristics

1

Accu-P® 0402 Typical SRF vs Capacitance

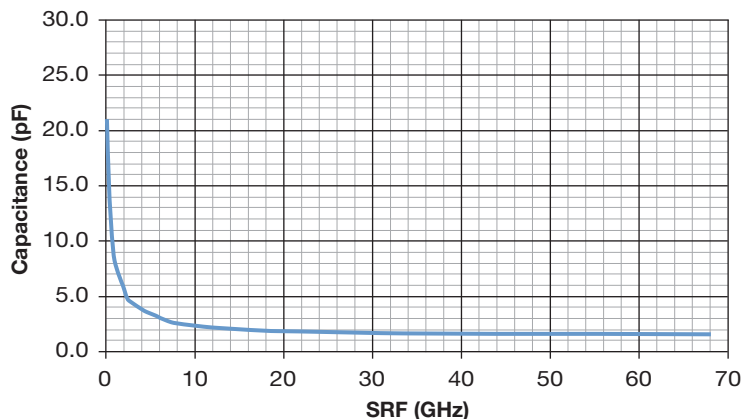

Measured on HP8720ES

Accu-P® 0402 Typical ESR vs Frequency

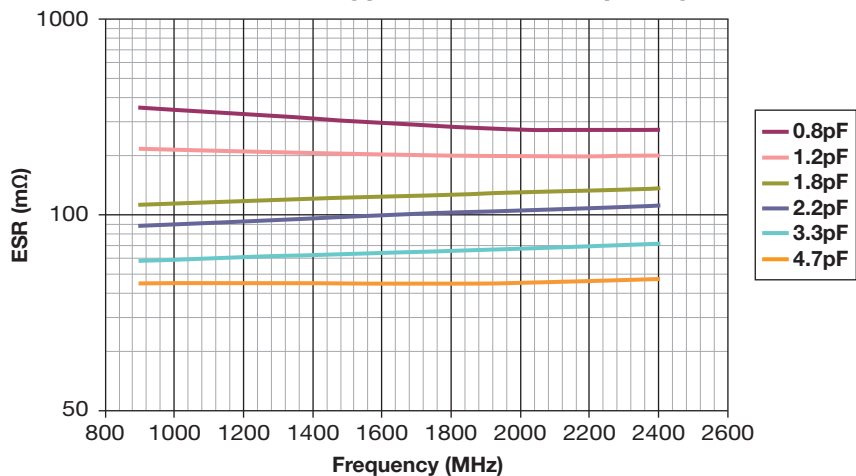

Measured on Agilent 4278A/4991A

Accu-P® 0402 Typical Q vs Frequency

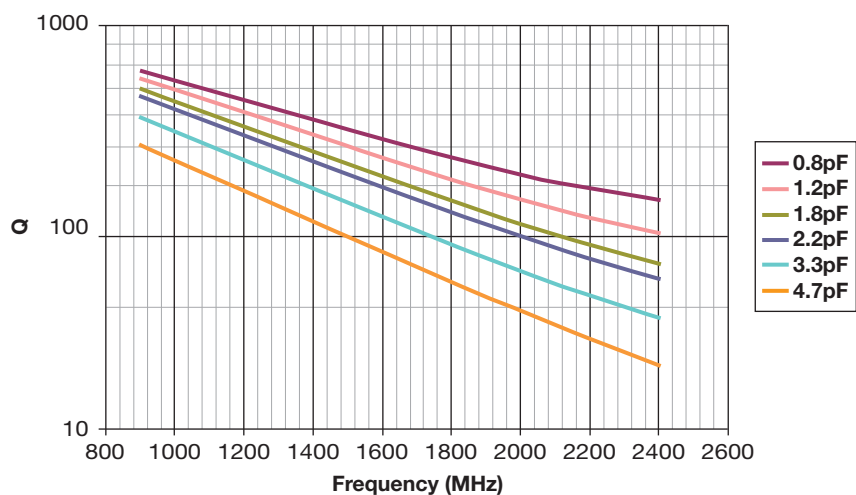

Measured on Agilent 4278A/4991A

High Frequency Characteristics

1

Accu-P® 0603 Typical SRF vs Capacitance

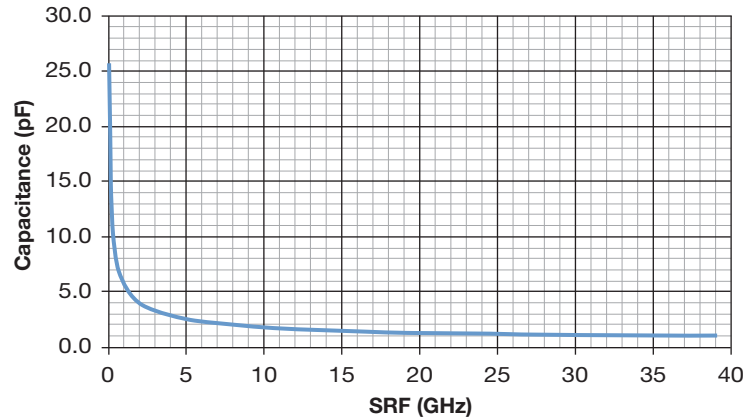

Measured on HP8720ES

Accu-P® 0603 Typical ESR vs Frequency

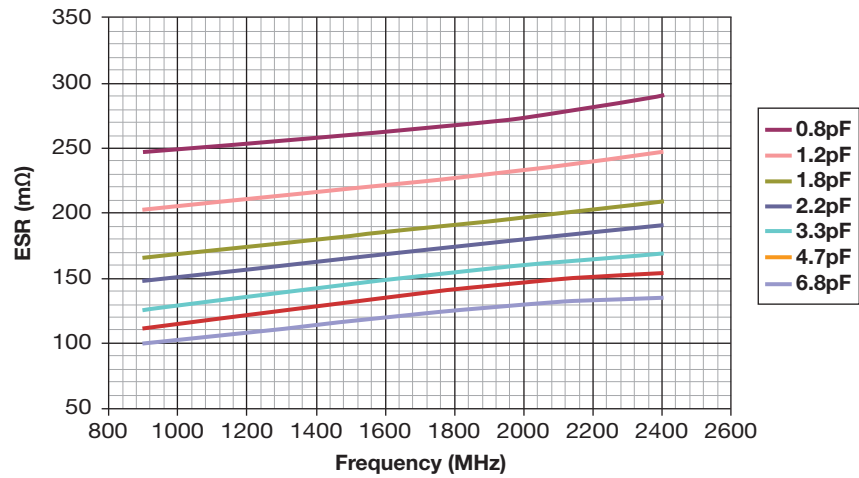

Measured on Agilent 4278A/4991A

Accu-P® 0603 Typical Q vs Frequency

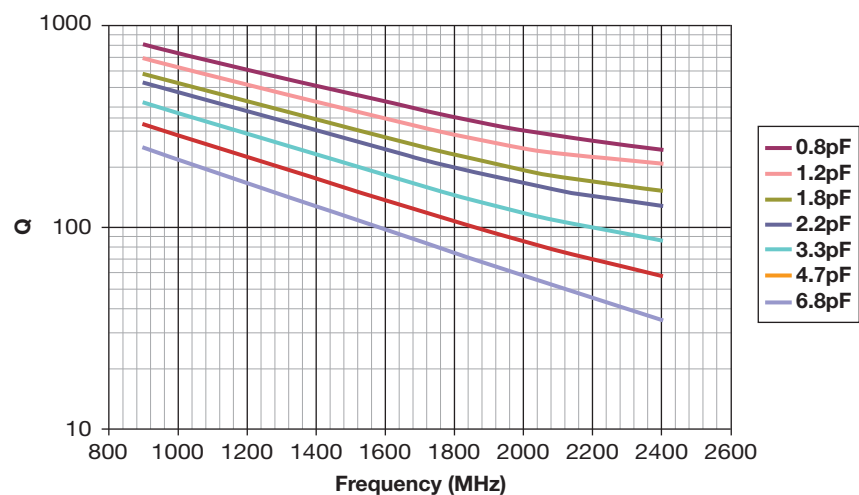

Measured on Agilent 4278A/4991A

High Frequency Characteristics

1

Accu-P[®] 0805 Typical SRF vs Capacitance

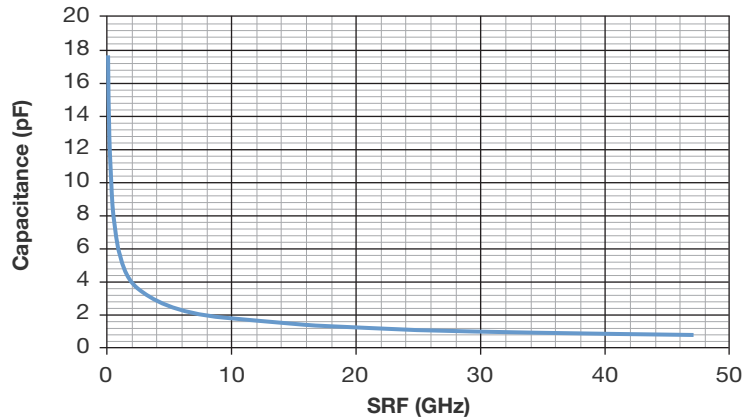

Measured on HP8720ES

Accu-P[®] 0805 Typical ESR vs Frequency

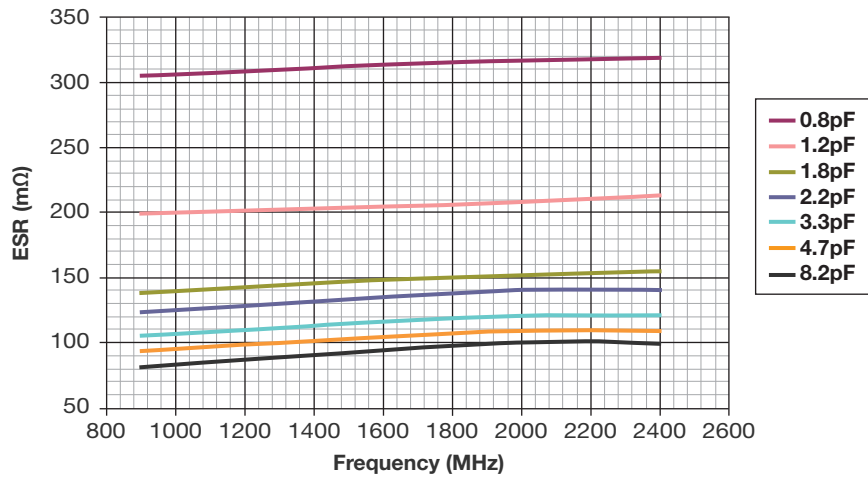

Measured on Agilent 4278A/4991A

Accu-P[®] 0805 Typical Q vs Frequency

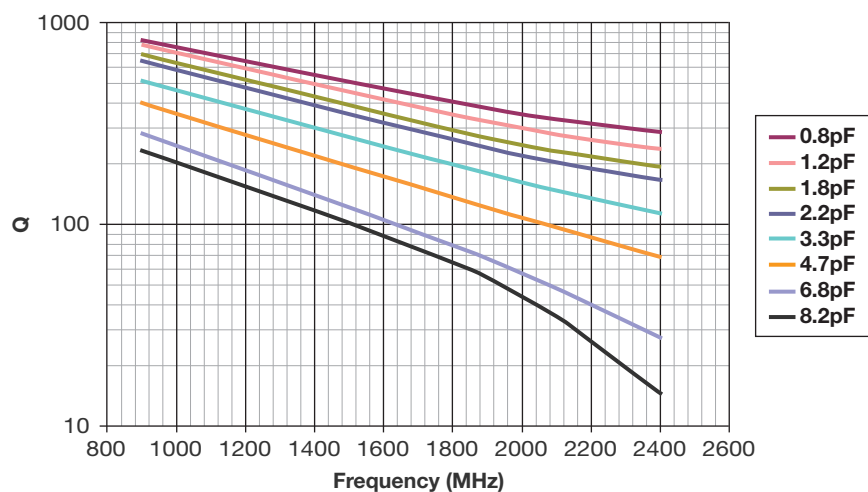

Measured on Agilent 4278A/4991A

Accu-P® 1210 Typical SRF vs Capacitance

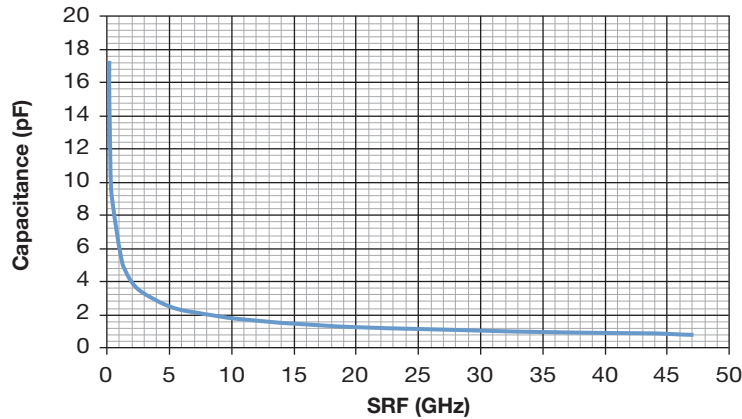

Measured on HP8720ES

Accu-P® 1210 Typical ESR vs Frequency

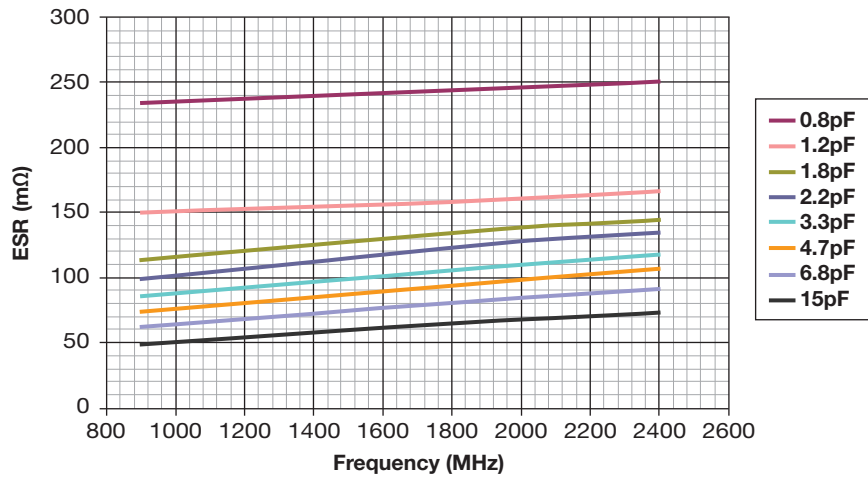

Measured on Agilent 4278A/4991A

Accu-P® 1210 Typical Q vs Frequency

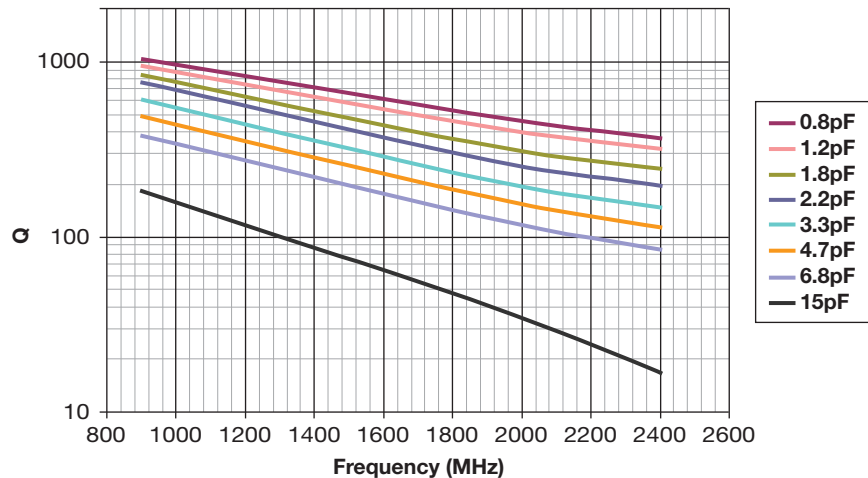

Measured on Agilent 4278A/4991A

Environmental / Mechanical Characteristics

ENVIRONMENTAL CHARACTERISTICS

TEST	CONDITIONS	REQUIREMENT
Life (Endurance) MIL-STD-202F Method 108A	125°C, 2U _R , 1000 hours	No visible damage $\Delta C/C \leq 2\%$ for $C \geq 5\text{pF}$ $\Delta C \leq 0.25\text{pF}$ for $C < 5\text{pF}$
Accelerated Damp Heat Steady State MIL-STD-202F Method 103B	85°C, 85% RH, U _R , 1000 hours	No visible damage $\Delta C/C \leq 2\%$ for $C \geq 5\text{pF}$ $\Delta C \leq 0.25\text{pF}$ for $C < 5\text{pF}$
Temperature Cycling MIL-STD-202F Method 107E MIL-STD-883D Method 1010.7	-55°C to +125°C, 15 cycles – Accu-P®	No visible damage $\Delta C/C \leq 2\%$ for $C \geq 5\text{pF}$ $\Delta C \leq 0.25\text{pF}$ for $C < 5\text{pF}$
Resistance to Solder Heat IEC-68-2-58	260°C ± 5°C for 10 secs	C remains within initial limits

MECHANICAL CHARACTERISTICS

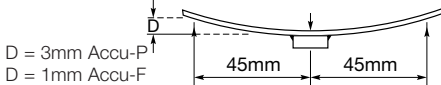
TEST	CONDITIONS	REQUIREMENT
Solderability IEC-68-2-58	Components completely immersed in a solder bath at 235°C for 2 secs.	Terminations to be well tinned, minimum 95% coverage
Leach Resistance IEC-68-2-58	Components completely immersed in a solder bath at 260±5°C for 60 secs.	Dissolution of termination faces ≤15% of area Dissolution of termination edges ≤25% of length
Adhesion MIL-STD-202F Method 211A	A force of 5N applied for 10 secs.	No visible damage
Termination Bond Strength IEC-68-2-21 Amend. 2	Tested as shown in diagram  D = 3mm Accu-P D = 1mm Accu-F	No visible damage $\Delta C/C \leq 2\%$ for $C \geq 5\text{pF}$ $\Delta C \leq 0.25\text{pF}$ for $C < 5\text{pF}$
Robustness of Termination IEC-68-2-21 Amend. 2	A force of 5N applied for 10 secs.	No visible damage
High Frequency Vibration MIL-STD-202F Method 201A, 204D (Accu-P® only)	55Hz to 2000Hz, 20G	No visible damage
Storage	12 months minimum with components stored in “as received” packaging	Good solderability

QUALITY & RELIABILITY

Accu-P® is based on well established thin-film technology and materials.

• ON-LINE PROCESS CONTROL

This program forms an integral part of the production cycle and acts as a feedback system to regulate and control production processes. The test procedures, which are integrated into the production process, were developed after long research work and are based on the highly developed semiconductor industry test procedures and equipment. These measures help AVX to produce a consistent and high yield line of products.

• FINAL QUALITY INSPECTION

Finished parts are tested for standard electrical parameters and visual/mechanical characteristics. Each production lot is 100% evaluated for: capacitance and proof voltage at 2.5 U_R. In addition, production is periodically evaluated for:

Average capacitance with histogram printout for capacitance distribution;
IR and Breakdown Voltage distribution;
Temperature Coefficient;
Solderability;
Dimensional, mechanical and temperature stability.

QUALITY ASSURANCE

The reliability of these thin-film chip capacitors has been studied intensively for several years. Various measures have been taken to obtain the high reliability required today by the industry. Quality assurance policy is based on well established international industry standards. The reliability of the capacitors is determined by accelerated testing under the following conditions:

Life (Endurance)	125°C, 2U _R , 1000 hours
Accelerated Damp Heat Steady State	85°C, 85% RH, U _R , 1000 hours.

Performance Characteristics RF Power Applications

RF POWER APPLICATIONS

In RF power applications capacitor losses generate heat. Two factors of particular importance to designers are:

- Minimizing the generation of heat.
- Dissipating heat as efficiently as possible.

CAPACITOR HEATING

- The major source of heat generation in a capacitor in RF power applications is a function of RF current (I) and ESR, from the relationship:

$$\text{Power dissipation} = I_{\text{RMS}}^2 \times \text{ESR}$$

- Accu-P® capacitors are specially designed to minimize

ESR and therefore RF heating. Values of ESR for Accu-P® capacitors are significantly less than those of ceramic MLC components currently available.

HEAT DISSIPATION

- Heat is dissipated from a capacitor through a variety of paths, but the key factor in the removal of heat is the thermal conductivity of the capacitor material.
- The higher the thermal conductivity of the capacitor, the more rapidly heat will be dissipated.
- The table below illustrates the importance of thermal conductivity to the performance of Accu-P® in power applications.

PRODUCT	MATERIAL	THERMAL CONDUCTIVITY W/mK
Accu-P®	Alumina	18.9
Microwave MLC	Magnesium Titanate	6.0

**Power Handling
Accu-P® 10pF**

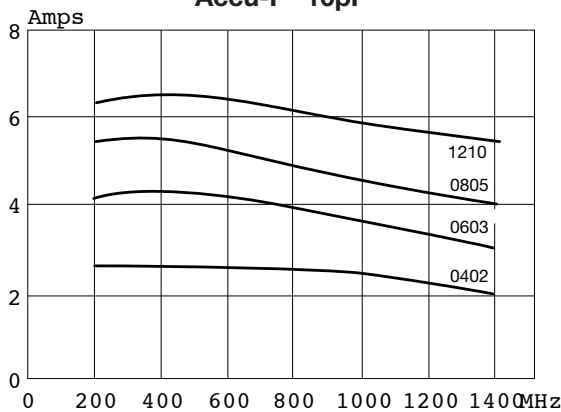

Data used in calculating the graph:

Thermal impedance of capacitors:

0402	17°C/W
0603	12°C/W
0805	6.5°C/W
1210	5°C/W

Thermal impedance measured using RF generator, amplifier and strip-line transformer.

ESR of capacitors measured on Boonton 34A

THERMAL IMPEDANCE

Thermal impedance of Accu-P® chips is shown below compared with the thermal impedance of Microwave MLC's.

CAPACITOR TYPE	CHIP SIZE	THERMAL IMPEDANCE (°C/W)
Accu-P®	0805	6.5
	1210	5
Microwave MLC	0505	12
	1210	7.5

The thermal impedance expresses the temperature difference in °C between chip center and termination caused by a power dissipation of 1 watt in the chip. It is expressed in °C/W.

ADVANTAGES OF ACCU-P® IN RF POWER CIRCUITS

The optimized design of Accu-P® offers the designer of RF power circuits the following advantages:

- Reduced power losses due to the inherently low ESR of Accu-P®.
- Increased power dissipation due to the high thermal conductivity of Accu-P®.

• THE ONLY TRUE TEST OF A CAPACITOR IN ANY PARTICULAR APPLICATION IS ITS PERFORMANCE UNDER OPERATING CONDITIONS IN THE ACTUAL CIRCUIT.

PRACTICAL APPLICATION IN RF POWER CIRCUITS

- There is a wide variety of different experimental methods for measuring the power handling performance of a capacitor in RF power circuits. Each method has its own problems and few of them exactly reproduce the conditions present in "real" circuit applications.
- Similarly, there is a very wide range of different circuit applications, all with their unique characteristics and operating conditions which cannot possibly be covered by such "theoretical" testing.



1

GENERAL

Accu-P® SMD capacitors are designed for soldering to printed circuit boards or other substrates. The construction of the components is such that they will withstand the time/temperature profiles used in both wave and reflow soldering methods.

CIRCUIT BOARD TYPE

The circuit board types which may be used with Accu-P® are as follows:

All flexible types of circuit boards (eg. FR-4, G-10) and also alumina.

For other circuit board materials, please consult factory.

HANDLING

SMD capacitors should be handled with care to avoid damage or contamination from perspiration and skin oils. The use of plastic tipped tweezers or vacuum pick-ups is strongly recommended for individual components. Bulk handling should ensure that abrasion and mechanical shock are minimized. For automatic equipment, taped and reeled product gives the ideal medium for direct presentation to the placement machine.

COMPONENT PAD DESIGN

Component pads must be designed to achieve good joints and minimize component movement during reflow soldering. Pad designs are given below for both wave and reflow soldering.

The basis of these designs is:

- Pad width equal to component width. It is permissible to decrease this to as low as 85% of component width but it is not advisable to go below this.
- Pad overlap 0.5mm beneath large components. Pad overlap about 0.3mm beneath small components.
- Pad extension of 0.5mm for reflow of large components and pad extension about 0.3mm for reflow of small components. Pad extension about 1.0mm for wave soldering.

REFLOW SOLDERING

PAD DIMENSIONS: millimeters (inches)

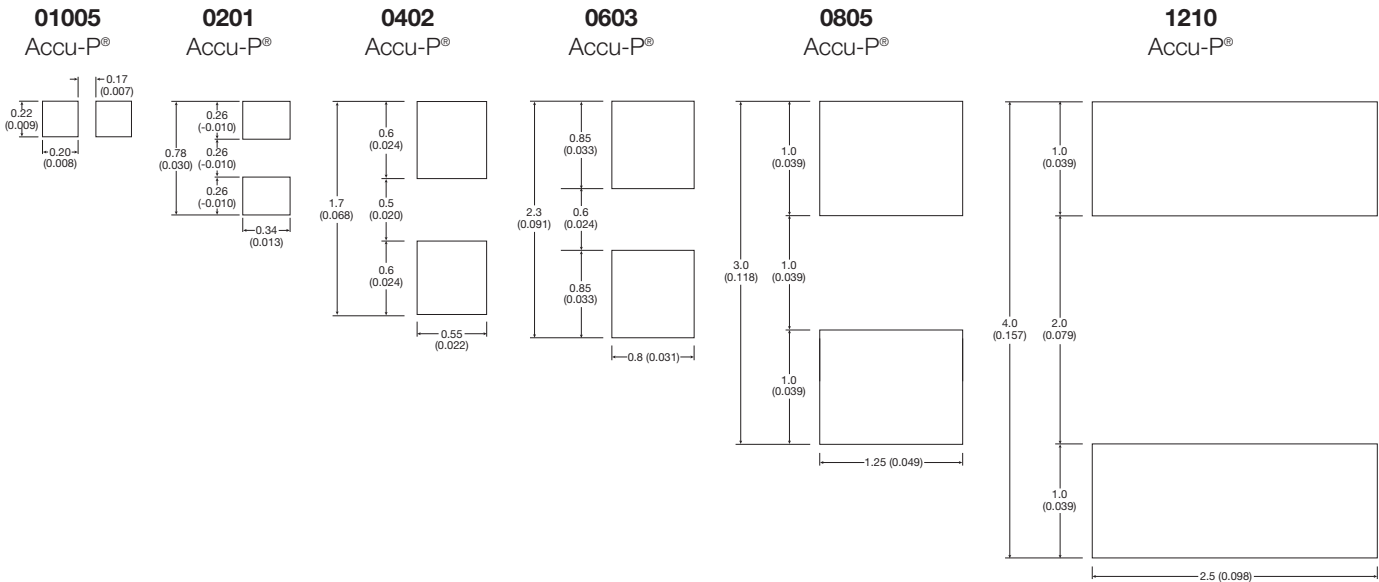

Application Notes

PREHEAT & SOLDERING

The rate of preheat in production should not exceed 4°C/second and a recommended maximum is about 2°C/second. Temperature differential from preheat to soldering should not exceed 100°C.

For further specific application or process advice, please consult AVX.

COOLING

After soldering, the assembly should preferably be allowed to cool naturally. In the event of assisted cooling, similar conditions to those recommended for preheating should be used.

HAND SOLDERING & REWORK

Hand soldering is permissible. Preheat of the PCB to 150°C is required. The most preferable technique is to use hot air soldering tools. Where a soldering iron is used, a temperature controlled model not exceeding 30 watts should be used and set to not more than 260°C.

CLEANING RECOMMENDATIONS

Care should be taken to ensure that the devices are thoroughly cleaned of flux residues, especially the space beneath the device. Such residues may otherwise become conductive and effectively offer a lossy bypass to the device. Various recommended cleaning conditions (which must be optimized for the flux system being used) are as follows:

- Cleaning liquids. i-propanol, ethanol, acetylacetone, water and other standard PCB cleaning liquids.
- Ultrasonic conditions . . power-20w/liter max.
frequency-20kHz to 45kHz.
- Temperature 80°C maximum (if not otherwise limited by chosen solvent system).
- Time 5 minutes max.

STORAGE CONDITIONS

Recommended storage conditions for Accu-P® prior to use are as follows:

- Temperature 15°C to 35°C
- Humidity ≤65%
- Air Pressure 860mbar to 1060mbar

RECOMMENDED REFLOW SOLDERING PROFILE COMPONENTS WITH SnPb TERMINATIONS

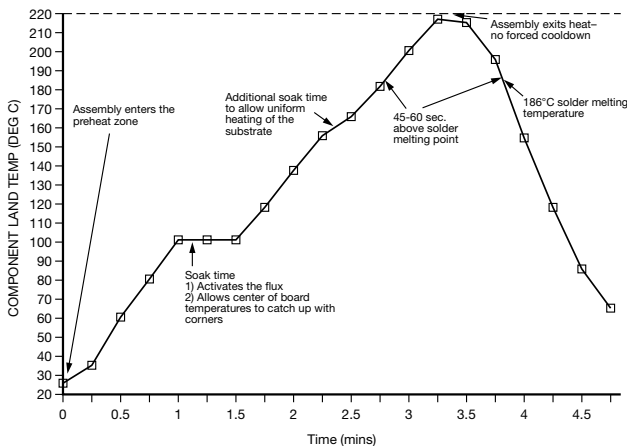

RECOMMENDED REFLOW SOLDERING PROFILE LEAD FREE COMPONENTS WITH Sn100 TERMINATIONS

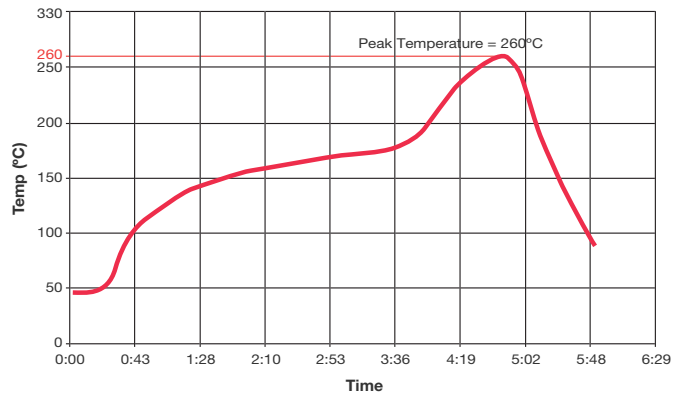

Automatic Insertion Packaging

TAPE & REEL

All tape and reel specifications are in compliance with EIA 481-1-A.
(equivalent to IEC 286 part 3).

- 8mm carrier
- Reeled quantities: Reels of 3,000 per 7" reel or 10,000 pieces per 13" reel
01005, 0201 and 0402 = 5,000 pieces per 7" reel and 20,000 pieces per 13" reel

REEL

DIMENSIONS: millimeters (inches)

A ⁽¹⁾	B	C	D	E	F	G
180±1.0 (7.087±0.039)	1.5 min. (0.059 min.)	13±0.2 (0.512 ± 0.008)	20.2 min. (0.795 min.)	50 min. (1.969 min.)	9.6±1.5 (0.370 ± 0.050)	14.4 max. (0.567 max.)

Metric dimensions will govern.
Inch measurements rounded and for reference only.

(1) 330mm (13 inch) reels are available.

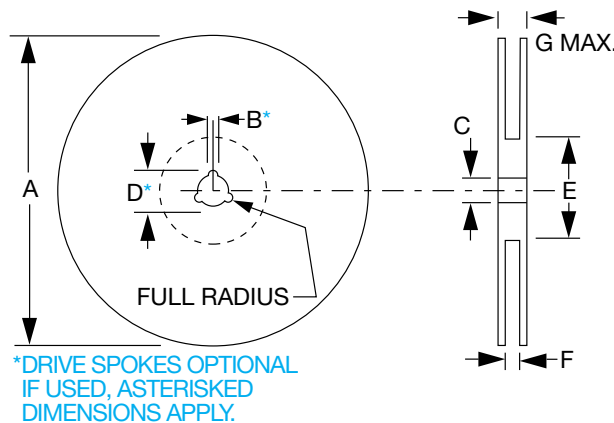

CARRIER

DIMENSIONS: millimeters (inches)

A	B	C	D	E	F
8.0 ± 0.3 (0.315 ± 0.012)	3.5 ± 0.05 (0.138 ± 0.002)	1.75±0.1 (0.069 ± 0.004)	2.0 ± 0.05 (0.079 ± 0.002)	4.0 ± 0.1 (0.157 ± 0.004)	1.5 ^{+0.1} _{-0.0} (0.059 ^{+0.004} _{-0.000})

The nominal dimensions of the component compartment (W,L) are derived from the component size.

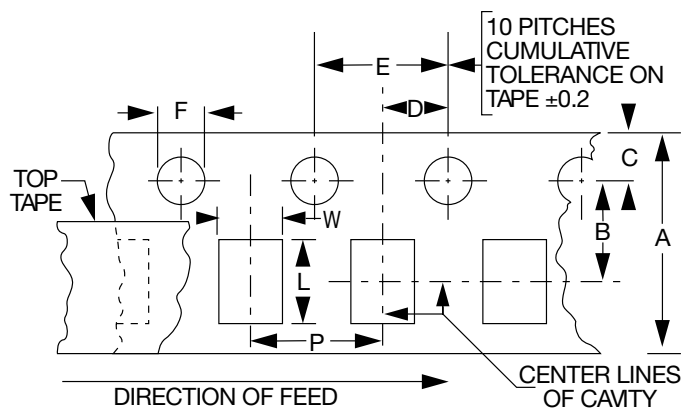

P = 4mm for 0603, 0805, 1210
P = 2mm for C005, 0201 and 0402

AVX reserves the right to change the information published herein without notice.

AVX RF

**Thin-Film RF/Microwave
Inductor Technology**

Accu-L[®]

Accu-L[®] 0201 Tight Tolerance



SMD RF Thin Film Tuning Inductor

2



ACCU-L[®] TECHNOLOGY

The L0201 SMD Tuning Inductor is based on thin-film multilayer technology. The technology provides a miniature part with excellent high frequency performance and rugged construction for reliable automatic assembly.

APPLICATIONS

- Mobile Communications
- Satellite TV Receivers
- GPS
- Vehicle Location Systems
- Wireless LAN's
- Filters
- Matching Networks

HOW TO ORDER



P/N Example: **L02013R3BHSTR**

QUALITY INSPECTION

Finished parts are 100% tested for electrical parameters and visual characteristics. Each production lot is evaluated on a sample basis for:

- Static Humidity: 85°C, 85% RH, 160 hours
- Endurance: 125°C, I_R, 4 hours

TERMINATION

Nickel/Lead Free solder coating compatible with automatic soldering technologies: reflow, wave soldering, vapor phase and manual.

DIMENSIONS: (TOP View)

millimeters (inches)

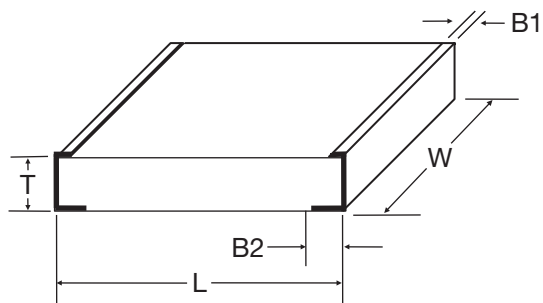

L	0.600±0.050 (0.024±0.002)
W	0.325±0.050 (0.013±0.002)
T	0.225±0.050 (0.009±0.002)

B1	0.100±0.100 (0.004±0.004)
B2	0.150±0.050 (0.006±0.002)

Recommended Pad Layout Dimensions

mm (inches)

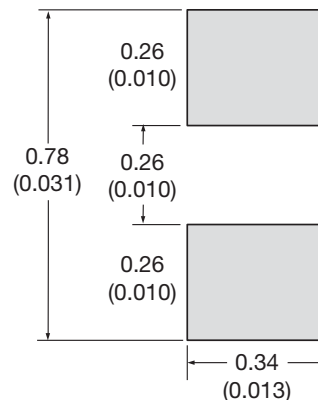

Accu-L[®] 0201 Tight Tolerance

SMD RF Thin Film Tuning Inductor



ELECTRICAL SPECIFICATIONS

L(nH)	450MHz		900MHz	1900MHz	2400MHz	SRF min. (GHz)	R _{dc} max. (Ω)	I _{dc} max. (mA)
	Tolerance A=±0.05nH, B=±0.1nH, C=±0.2nH, D=±0.5nH	Q (min)	Q (Typ)	Q (Typ)	Q (Typ)			
0.33	±0.05nH, ± 0.1nH, ± 0.2nH	13	24	36	39	35	0.1	550
0.39	±0.05nH, ± 0.1nH, ± 0.2nH	11	23	34	38	33	0.1	550
0.47	±0.05nH, ± 0.1nH, ± 0.2nH	10	18	26	30	32	0.1	550
0.56	±0.05nH, ± 0.1nH, ± 0.2nH	9	16	24	27	31	0.1	500
0.68	±0.05nH, ± 0.1nH, ± 0.2nH	8	19	28	32	30	0.2	500
0.82	±0.05nH, ± 0.1nH, ± 0.2nH	8	19	28	32	28	0.2	400
1.0	±0.05nH, ± 0.1nH, ± 0.2nH	7	16	26	30	26	0.2	400
1.2	±0.05nH, ± 0.1nH, ± 0.2nH	7	16	26	30	24	0.3	300
1.5	± 0.1nH, ± 0.2nH, ± 0.5nH	7	16	26	30	23	0.5	250
1.8	± 0.1nH, ± 0.2nH, ± 0.5nH	7	15	25	29	20	0.5	250
2.2	± 0.1nH, ± 0.2nH, ± 0.5nH	7	15	22	24	18	0.6	200
2.7	± 0.1nH, ± 0.2nH, ± 0.5nH	7	15	22	24	14	0.7	180
3.3	± 0.1nH, ± 0.2nH, ± 0.5nH	7	15	22	24	13	1.0	150

All intermediate Inductance values within the indicated range are available.



L0402 Tight Tolerance



RF Inductor

GENERAL DESCRIPTION ITF TECHNOLOGY

The L0402 LGA Inductor is based on thin-film multilayer technology. The technology provides a miniature part with excellent high frequency performance and rugged construction for reliable automatic assembly.

APPLICATIONS

- Mobile Communications
- Satellite TV Receivers
- GPS
- Vehicle Location Systems
- Wireless LAN's
- Filters
- Matching Networks

LAND GRID ARRAY ADVANTAGES

- Inherent Low Profile
- Self Alignment during Reflow
- Excellent Solderability
- Low Parasitics
- Better Heat Dissipation

DIMENSIONS: (Bottom View)

millimeters (inches)

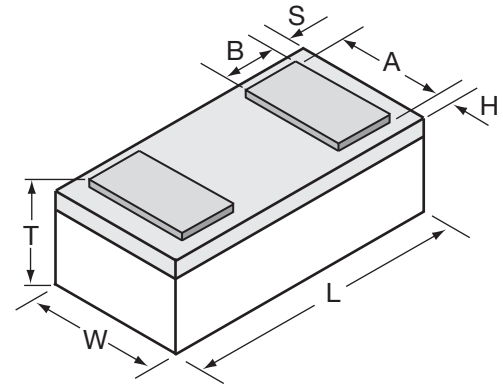

L	1.00±0.10 (0.039±0.004)
W	0.58±0.07 (0.023±0.003)
T	0.35±0.10 (0.014±0.004)

A	0.48±0.05 (0.019±0.002)
B	0.17±0.05 (0.007±0.002)
S, H	0.064±0.05 (0.003±0.002)

HOW TO ORDER



P/N Example: **L04023R3BHNTTR**



QUALITY INSPECTION

Finished parts are 100% tested for electrical parameters and visual characteristics. Each production lot is evaluated on a sample basis for:

- Static Humidity: 85°C, 85% RH, 160 hours
- Endurance: 125°C, I_R, 4 hours

TERMINATION

Nickel/Lead Free solder coating compatible with automatic soldering technologies: reflow, wave soldering, vapor phase and manual.

MAKING AND ORIENTATION IN TAPE

(Top View)

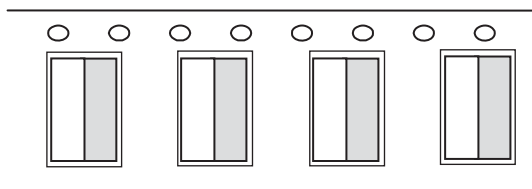

Recommended Pad Layout Dimensions mm (inches)

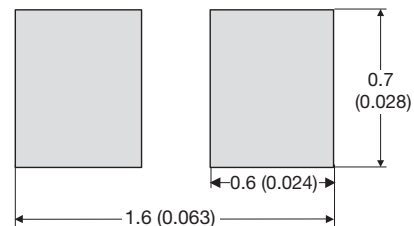

L0402 Tight Tolerance

RF Inductor



ELECTRICAL SPECIFICATIONS

L(nH)	450MHz			900MHz	1900MHz	2400MHz	SRF min. (MHz)	R _{dc} max. (Ω)	I _{dc} max. (mA)
	Tolerance A=±0.05nH, B=±0.1nH, C=±0.2nH, D=±0.5nH	Q (min)	Q (Typ)	Q (Typ)	Q (Typ)	Q (Typ)			
0.56	± 0.05nH, ± 0.1nH	35	45	55	65	75	20000	0.02	1000
0.68	± 0.05nH, ± 0.1nH	30	40	50	60	70	20000	0.04	750
0.82	± 0.05nH, ± 0.1nH	25	40	50	60	70	20000	0.06	500
1.0	± 0.05nH, ± 0.1nH	20	30	35	40	50	20000	0.15	500
1.2	± 0.05nH, ± 0.1nH, ± 0.2nH	20	30	30	40	45	20000	0.20	400
1.5	± 0.05nH, ± 0.1nH, ± 0.2nH	20	25	30	40	40	18000	0.20	400
1.8	± 0.05nH, ± 0.1nH, ± 0.2nH	18	20	30	35	40	16000	0.20	400
2.2	± 0.05nH, ± 0.1nH, ± 0.2nH	15	20	25	35	40	15000	0.20	400
2.7	± 0.05nH, ± 0.1nH, ± 0.2nH	15	20	25	35	40	9500	0.25	250
3.3	± 0.1nH, ± 0.2nH, ± 0.5nH	15	20	25	35	40	8500	0.40	250
3.9	± 0.1nH, ± 0.2nH, ± 0.5nH	13	20	20	30	30	8000	0.45	250
4.7	± 0.1nH, ± 0.2nH, ± 0.5nH	13	20	20	30	30	7500	0.45	250
5.6	± 0.1nH, ± 0.2nH, ± 0.5nH	13	20	20	30	30	7000	0.65	200
6.8	± 0.1nH, ± 0.2nH, ± 0.5nH	12	15	20	25	30	6500	0.90	200

Please contact factory for intermediate inductance values within the indicated range.



2

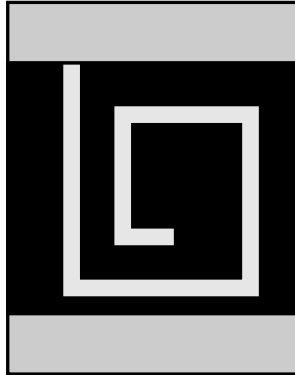

10 nH Inductor (Top View)

ACCU-L[®] TECHNOLOGY

The Accu-L[®] SMD Inductor is based on thin-film multilayer technology. This technology provides a level of control on the electrical and physical characteristics of the component which gives consistent characteristics within a lot and lot-to-lot.

The original design provides small size, excellent high-frequency performance and rugged construction for reliable automatic assembly.

The Accu-L[®] inductor is particularly suited for the telecommunications industry where there is a continuing trend towards miniaturization and increasing frequencies. The Accu-L[®] inductor meets both the performance and tolerance requirements of present cellular frequencies 450MHz and 900MHz and of future frequencies, such as 1700MHz, 1900MHz and 2400MHz.

FEATURES

- High Q
- RF Power Capability
- High SRF
- Low DC Resistance
- Ultra-Tight Tolerance on Inductance
- Standard 0603 and 0805 Chip Size
- Low Profile
- Rugged Construction
- Taped and Reeled

APPLICATIONS

- Mobile Communications
- Satellite TV Receivers
- GPS
- Vehicle Locations Systems
- Filters
- Matching Networks

DIMENSIONS: millimeters (inches)

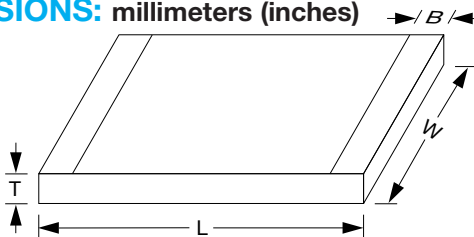

	0603	0805
L	1.6±0.10 (0.063±0.004)	2.11±0.10 (0.083±0.004)
W	0.81±0.10 (0.032±0.004)	1.5±0.10 (0.059±0.004)
T	0.61±0.10 (0.024±0.004)	0.91±0.13 (0.036±0.005)
B	top: 0.0 +0.3/-0.0 (0.0±0.012) bottom: 0.35±0.20 (0.014±0.008)	0.25±0.15 (0.010±0.006)

Operating/Storage
Temp. Range:
-55°C to +125°C

Accu-L[®] 0603 and 0805

SMD High-Q RF Inductor



HOW TO ORDER

L	0805	4R7	D	E	S	TR
Product Inductor	Size 0603 0805	Inductance Expressed in nH (2 significant digits + number of zeros) for values <10nH, letter R denotes decimal point. Example: 22nH = 220 4.7nH = 4R7	Tolerance for L ≤ 4.7nH, B = ±0.1nH C = ±0.2nH D = ±0.5nH 4.7nH < L < 10nH, C = ±0.2nH D = ±0.5nH L ≥ 10nH, G = ±2% J = ±5%	Specification Code E = Accu-L [®] 0805 technology G = Accu-L [®] 0603 technology	Termination Code W = Nickel/ solder coated (Sn 63, Pb 37) **S = Nickel/ Lead Free Solder coated (Sn100)	Packaging Code TR = Tape and Reel (3,000/reel)

Not RoHS Compliant



LEAD-FREE
LEAD-FREE COMPATIBLE
COMPONENT



RoHS
COMPLIANT

For RoHS compliant products,
please select correct termination style.

****RoHS compliant**

**Engineering Kits Available
see pages 118-119**

2

ELECTRICAL SPECIFICATIONS TABLE FOR ACCU-L[®] 0603

450 MHz Test Frequency			900 MHz Test Frequency		1900 MHz Test Frequency		2400 MHz Test Frequency		SRF min (MHz)	R _{DC} max (Ω)	I _{DC} max (mA)
Inductance L (nH)	Available Inductance Tolerance	Q Typical	L (nH)	Q Typical	L (nH)	Q Typical	L (nH)	Q Typical			
1.2	±0.1, ±0.2nH	49	1.2	70	1.2	134	1.2	170	10000	0.04	1000
1.5	±0.1, ±0.2nH	26	1.54	39	1.52	63	1.52	76	10000	0.06	1000
1.8	±0.1, ±0.2nH	20	1.74	30	1.73	50	1.72	59	10000	0.07	1000
2.2	±0.1, ±0.2nH	20	2.2	30	2.24	49	2.24	56	10000	0.08	1000
2.7	±0.1, ±0.2nH	21	2.7	30	2.75	48	2.79	54	9000	0.08	750
3.3	±0.1, ±0.2, ±0.5nH	24	3.33	35	3.39	56	3.47	64	8400	0.08	750
3.9	±0.1, ±0.2, ±0.5nH	25	3.9	57	4.06	60	4.21	69	6500	0.12	500
4.7	±0.1, ±0.2, ±0.5nH	23	4.68	32	4.92	46	5.2	49	5500	0.15	500
5.6	±0.2, ±0.5nH	26	5.65	36	5.94	54	6.23	60	5000	0.25	300
6.8	±0.2, ±0.5nH	23	6.9	33	7.3	47	8.1	39	4500	0.30	300
8.2	±0.2, ±0.5nH	23	8.4	31	10	35	12.1	31	3800	0.35	300
10.0	±2%, ±5%	28	10	39	11.8	47	14.1	41	3500	0.45	300
12.0	±2%, ±5%	28	13.2	38	14.1	30	17.2	20	3000	0.50	300
15.0	±2%, ±5%	28	16.2	38	25.9	30	49.8	15	2500	0.60	300

(1) I_{DC} measured for 15°C rise at 25°C ambient temperature when soldered to FR-4 board.

Inductance and Q measured on Agilent 4291B / 4287 using the 16196A test fixture.

ELECTRICAL SPECIFICATIONS TABLE FOR ACCU-L[®] 0805

450 MHz Test Frequency			900 MHz Test Frequency		1700 MHz Test Frequency		2400 MHz Test Frequency		SRF min (MHz)	R _{DC} max (Ω)	I _{DC} max (mA)	
Inductance L (nH)	Available Inductance Tolerance	Q Typical	L (nH)	Q Typical	L (nH)	Q Typical	L (nH)	Q Typical			ΔT = 15°C (1)	ΔT = 70°C (2)
1.2	±0.1nH, ±0.2nH, ±0.5nH	60	1.2	92	1.2	122	1.2	92	10000	0.05	1000	2000
1.5	±0.1nH, ±0.2nH, ±0.5nH	50	1.5	74	1.5	102	1.5	84	10000	0.05	1000	2000
1.8	±0.1nH, ±0.2nH, ±0.5nH	50	1.8	72	1.8	88	1.9	73	10000	0.06	1000	2000
2.2	±0.1nH, ±0.2nH, ±0.5nH	42	2.2	62	2.2	82	2.3	72	10000	0.07	1000	2000
2.7	±0.1nH, ±0.2nH, ±0.5nH	42	2.7	62	2.8	80	2.9	70	10000	0.08	1000	2000
3.3	±0.1nH, ±0.2nH, ±0.5nH	38	3.3	46	3.4	48	3.5	57	10000	0.11	750	1500
3.9	±0.1nH, ±0.2nH, ±0.5nH	27	3.9	36	4.0	38	4.1	42	10000	0.20	750	1500
4.7	±0.1nH, ±0.2nH, ±0.5nH	43	4.8	62	5.3	76	5.8	60	5500	0.10	750	1500
5.6	±0.5nH	50	5.7	68	6.3	73	7.6	62	4600	0.10	750	1500
6.8	±0.5nH	43	7.0	62	7.7	71	9.4	50	4500	0.11	750	1500
8.2	±0.5nH	43	8.5	56	10.0	55	15.2	32	3500	0.12	750	1500
10	±2%, ±5%	46	10.6	60	13.4	52	–	–	2500	0.13	750	1500
12	±2%, ±5%	40	12.9	50	17.3	40	–	–	2400	0.20	750	1500
15	±2%, ±5%	36	16.7	46	27	23	–	–	2200	0.20	750	1000
18	±2%, ±5%	30	21.9	27	–	–	–	–	1700	0.35	500	1000
22	±2%, ±5%	36	27.5	33	–	–	–	–	1400	0.40	500	1000

(1) I_{DC} measured for 15°C rise at 25°C ambient temperature

(2) I_{DC} measured for 70°C rise at 25°C ambient temperature

L, Q, SRF measured on HP 4291A, Boonton 34A and Wiltron 360 Vector Analyzer, R_{DC} measured on Keithley 580 micro-ohmmeter.



Accu-L[®] 0603 and 0805



SMD High-Q RF Inductor

L0603

Typical Q vs. Frequency
L0603

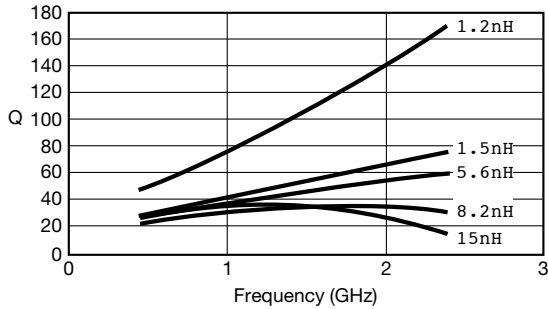

Measured on AGILENT 4291B/4287
using the 16196A test fixture

Typical Inductance vs. Frequency
L0603

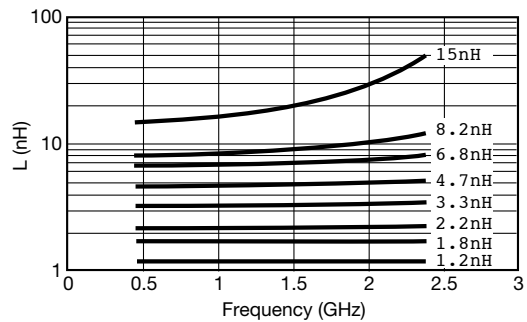

Measured on AGILENT 4291B/4287
using the 16196A test fixture

L0805

Typical Q vs. Frequency
L0805

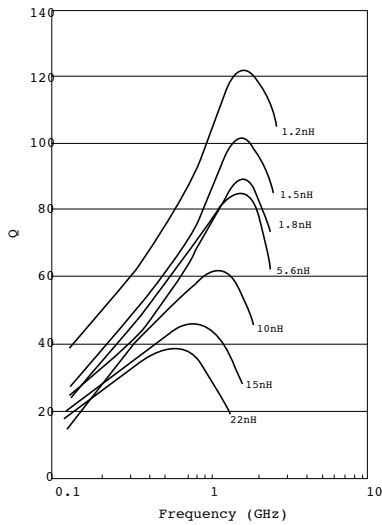

Measured on HP4291A and
Boonton 34A Coaxial Line

Typical Inductance vs. Frequency
L0805

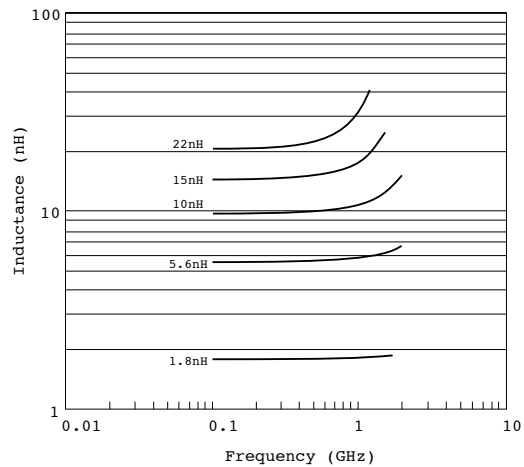

Measured on HP4291A and
Wiltron 360 Vector Analyzer

Maximum Temperature Rise
at 25°C ambient temperature (on FR-4)
L0805

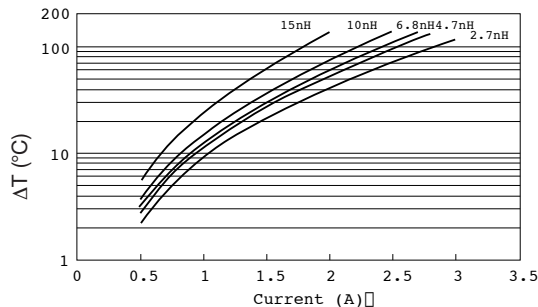

Temperature rise will typically be no higher than shown by the graph



2

Accu-L[®] 0603 and 0805



SMD High-Q RF Inductor

FINAL QUALITY INSPECTION

Finished parts are tested for electrical parameters and visual/mechanical characteristics.

Parts are 100% tested for inductance at 450MHz. Parts are 100% tested for R_{DC}. Each production lot is evaluated on a sample basis for:

- Q at test frequency
- Static Humidity Resistance: 85°C, 85% RH, 160 hours
- Endurance: 125°C, I_R, 4 hours

2

ENVIRONMENTAL CHARACTERISTICS

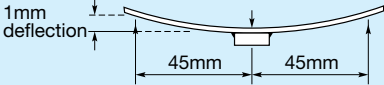
TEST	CONDITIONS	REQUIREMENT
Solderability	Components completely immersed in a solder bath at 235 ± 5°C for 2 secs.	Terminations to be well tinned. No visible damage.
Leach Resistance	Components completely immersed in a solder bath at 260 ± 5°C for 60 secs.	Dissolution of termination faces ≤ 15% of area. Dissolution of termination edges ≤ 25% of length.
Storage	12 months minimum with components stored in "as received" packaging.	Good solderability
Shear	Components mounted to a substrate. A force of 5N applied normal to the line joining the terminations and in a line parallel to the substrate.	No visible damage
Rapid Change of Temperature	Components mounted to a substrate. 5 cycles -55°C to +125°C.	No visible damage
Bend Strength	Tested as shown in diagram 	No visible damage
Temperature Coefficient of Inductance (TCL)	Component placed in environmental chamber -55°C to +125°C.	+0 to +125 ppm/°C (typical) $TCL = \frac{L_2 - L_1}{L_1 (T_2 - T_1)} \cdot 10^6$ T ₁ = 25°C

Application Notes

HANDLING

SMD chips should be handled with care to avoid damage or contamination from perspiration and skin oils. The use of plastic tipped tweezers or vacuum pick-ups is strongly recommended for individual components. Bulk handling should ensure that abrasion and mechanical shock are minimized. For automatic equipment, taped and reeled product is the ideal medium for direct presentation to the placement machine.

CIRCUIT BOARD TYPE

All flexible types of circuit boards may be used (e.g. FR-4, G-10) and also alumina.

For other circuit board materials, please consult factory.

COMPONENT PAD DESIGN

Component pads must be designed to achieve good joints and minimize component movement during soldering.

Pad designs are given below for both wave and reflow soldering.

The basis of these designs is:

- Pad width equal to component width. It is permissible to decrease this to as low as 85% of component width but it is not advisable to go below this.
- Pad overlap about 0.3mm.
- Pad extension about 0.3mm for reflow.
Pad extension about 0.8mm for wave soldering.

REFLOW SOLDERING

DIMENSIONS: millimeters (inches)

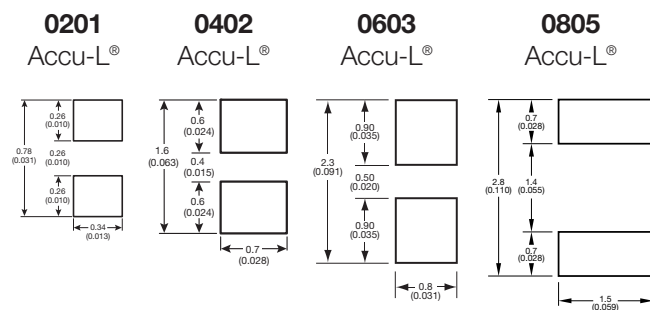

PREHEAT & SOLDERING

The rate of preheat in production should not exceed 4°C/second. It is recommended not to exceed 2°C/second.

Temperature differential from preheat to soldering should not exceed 150°C.

For further specific application or process advice, please consult AVX.

HAND SOLDERING & REWORK

Hand soldering is permissible. Preheat of the PCB to 100°C is required. The most preferable technique is to use hot air soldering tools. Where a soldering iron is used, a temperature controlled model not exceeding 30 watts should be used and set to not more than 260°C. Maximum allowed time at temperature is 1 minute. When hand soldering, the base side (white side) must be soldered to the board.

COOLING

After soldering, the assembly should preferably be allowed to cool naturally. In the event of assisted cooling, similar conditions to those recommended for preheating should be used.

CLEANING RECOMMENDATIONS

Care should be taken to ensure that the devices are thoroughly cleaned of flux residues, especially the space beneath the device. Such residues may otherwise become conductive and effectively offer a lossy bypass to the device. Various recommended cleaning conditions (which must be optimized for the flux system being used) are as follows:

- Cleaning liquids i-propanol, ethanol, acetone, water, and other standard PCB cleaning liquids.
- Ultrasonic conditions . . . power – 20w/liter max.
frequency – 20kHz to 45kHz.
- Temperature 80°C maximum (if not otherwise limited by chosen solvent system).
- Time. 5 minutes max.

STORAGE CONDITIONS

Recommended storage conditions for Accu-L[®] prior to use are as follows:

- Temperature. 15°C to 35°C
- Humidity ≤65%
- Air Pressure 860mbar to 1060mbar

RECOMMENDED SOLDERING PROFILE

For recommended soldering profile see page 29



Thin-Film RF/Microwave Directional Couplers

CP0302/CP0402/CP0603/CP0805
and DB0603N/DB0805 3dB 90°

Thin Film Directional Couplers

Wide Band High Directivity



CP0402W2700FNTR

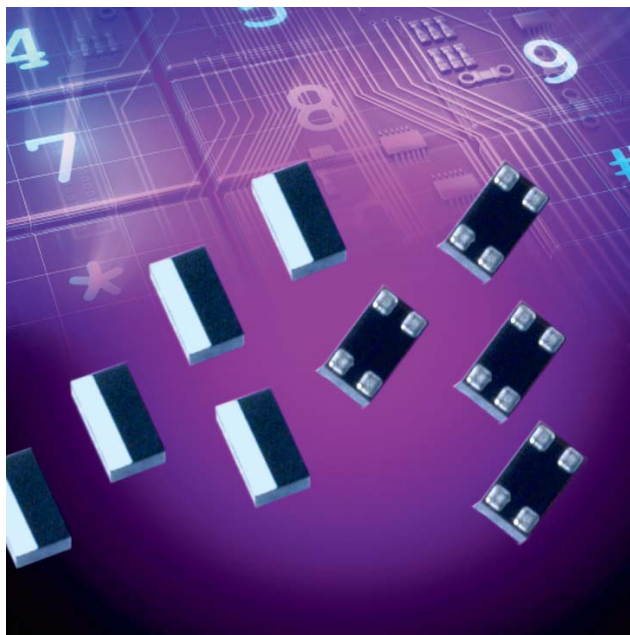

ITF TECHNOLOGY

The ITF High Directivity Wide Band LGA Coupler is based on thin-film multilayer technology. The technology provides a miniature part with excellent high frequency performance and rugged construction for reliable automatic assembly.

The Wide Band High Directivity Coupler displays a stable coupling factor over a wide frequency band.

APPLICATIONS

- Mobile communications
- Satellite TV receivers
- GPS
- Vehicle location systems
- Wireless LAN's

LAND GRID ARRAY ADVANTAGES

- Inherent Low Profile
- Self Alignment during Reflow
- Excellent Solderability
- Low Parasitics
- Better Heat Dissipation

DIMENSIONS (Bottom View)

mm (inches)

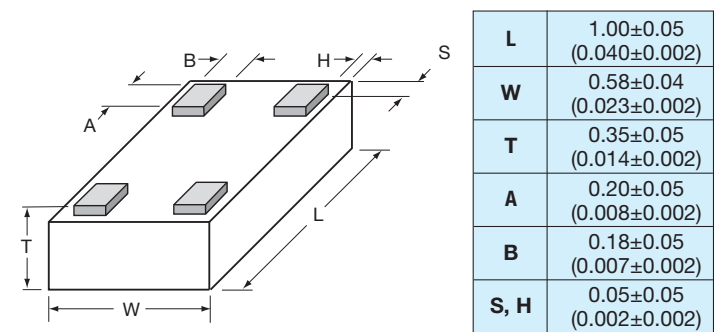

HOW TO ORDER

CP 0402 W XXXX X N TR

Type Wide Band | Frequency (MHz) | Sub-Type | LGA Termination Sn100 | Taped & Reeled

QUALITY INSPECTION

Finished parts are 100% tested for electrical parameters and visual characteristics. Each production lot is evaluated on a sample basis for:

- Static Humidity: 85°C, 85% RH, 160 hours
- Endurance: 125°C, I_R, 4 hours

TERMINATION

Nickel/Lead Free solder coating compatible with automatic soldering technologies: reflow, wave soldering, vapor phase and manual.

OPERATING TEMPERATURE

-40°C to +85°C

POWER RATING

3W RF Continuous

TERMINALS (Top View)

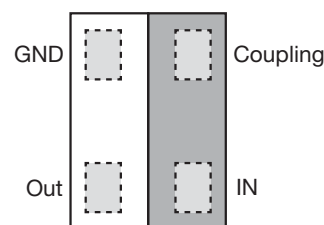

Recommended Pad Layout Dimensions mm (inches)

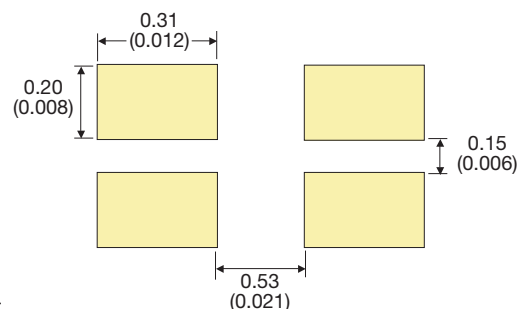

Thin Film Directional Couplers

Wide Band High Directivity



CP0402W2700FNTR

Directional Coupler Type CP0402W2700FNTR

P/N	Frequency [MHz]	Coupling [dB]	I. Loss max. [dB]	Return Loss [dB]	Directivity [dB]
CP0402W2700FNTR	700-2,700	24±2	0.3	18	20

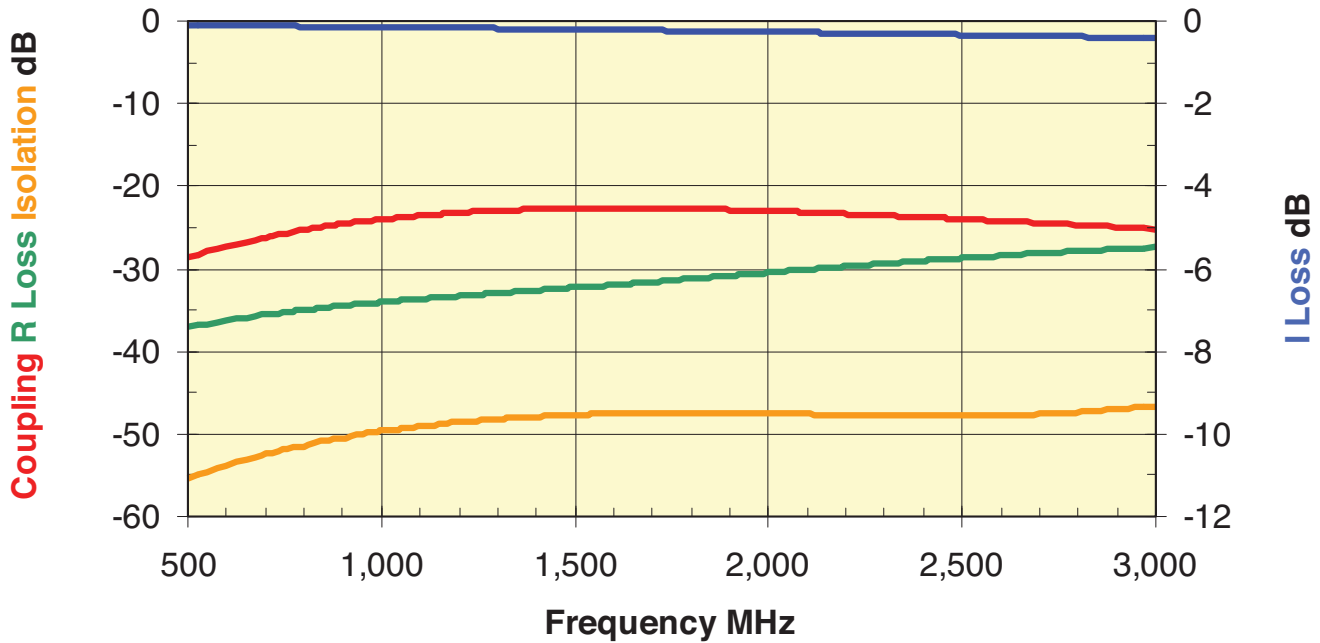

3

Thin Film Directional Couplers

Wide Band High Directivity



CP0402W2700FNTR Test Jigs

GENERAL DESCRIPTION

These jigs are designed for testing the CP0402W2700FNTR High Directivity Couplers using a Vector Network Analyzer.

They consist of a dielectric substrate, having 50Ω microstrips as conducting lines and a bottom ground plane located at a distance of 0.254mm (0.010") from the microstrips.

The substrate used is Neltec's NH9338ST0254C1BC.

The connectors are SMA type (female), 'Johnson Components Inc.' Product P/N: 142-0701-841.

Both a measurement jig and a calibration jig are provided.

The calibration jig is designed for a full 2-port calibration, and consists of an open line, short line and through line. LOAD calibration can be done by a 50Ω SMA termination.

MEASUREMENT PROCEDURE

When measuring a component, it can be either soldered or pressed using a non-metallic stick until all four ports touch the appropriate pads. Set the VNA to the relevant frequency band. Connect the VNA using a 10dB attenuator on the jig

terminal connected to port 2. Follow the VNA's instruction manual and use the [calibration jig](#) to perform a full 2-Port calibration in the required bandwidths.

3

Place the coupler on the measurement jig as follows:

- | | |
|--|-----------------------------------|
| GND (Coupler) → Connector 1 (Jig) | IN (Coupler) → Connector 3 (Jig) |
| Coupling (Coupler) → Connector 2 (Jig) | Out (Coupler) → Connector 4 (Jig) |

To measure I. Loss connect:

- | | |
|----------------------------------|-------------------------|
| Connector 3 (Jig) → Port 1 (VNA) | Connector 2 (Jig) → 50Ω |
| Connector 4 (Jig) → Port 2 (VNA) | |

To measure R. Loss and Coupling connect:

- | | |
|----------------------------------|-------------------------|
| Connector 3 (Jig) → Port 1 (VNA) | Connector 4 (Jig) → 50Ω |
| Connector 2 (Jig) → Port 2 (VNA) | |

To measure Isolation connect:

- | | |
|----------------------------------|----------------------------------|
| Connector 4 (Jig) → Port 1 (VNA) | Connector 2 (Jig) → Port 2 (VNA) |
| Connector 3 (Jig) → 50Ω | |

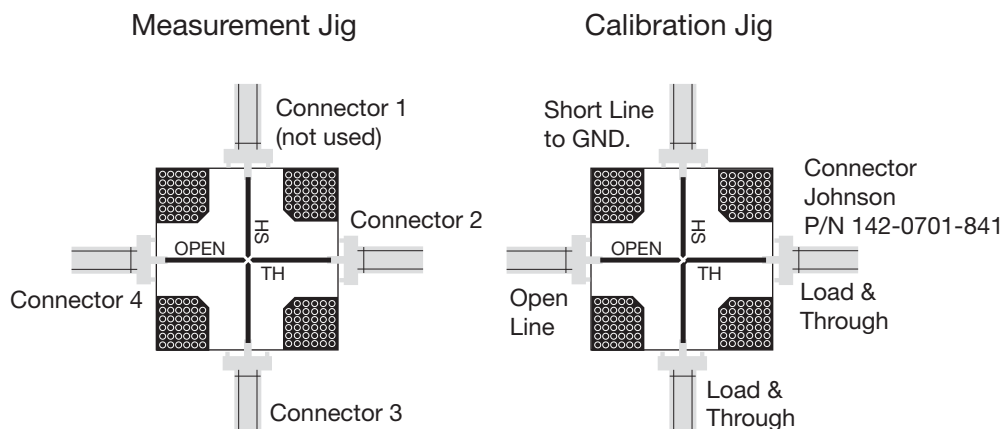

Thin Film Directional Couplers

WiFi Band High Directivity



CP0302P5425ENTR / CP0302A5425ENTR / CP0402Q5425ENTR / CP0603Q5425ENTR HIGH DIRECTIVITY DIRECTIONAL COUPLERS FOR WIFI BANDS

TECHNOLOGY

These High Directivity LGA Couplers are based on thin-film multilayer technology. The technology provides a miniature part with excellent high frequency performance and rugged construction for reliable automatic assembly. The WiFi Bands Couplers are offered in 0302, 0402 and 0603 standard sizes having identical electrical performance.



DIMENSIONS (Bottom View) mm (inches)

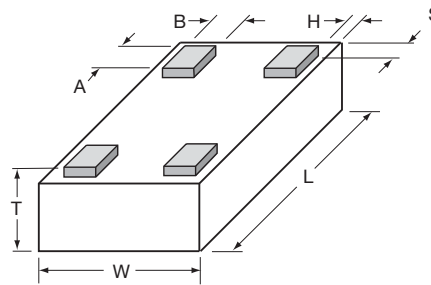

APPLICATIONS:

- WiFi

PART NUMBERS

CP0302P5425ENTR
CP0302A5425ENTR
CP0402Q5425ENTR
CP0603Q5425ENTR

QUALITY INSPECTION

Finished parts are 100% tested for electrical parameters and visual characteristics. Each production lot is evaluated on a sample basis for:

- Static Humidity: 85°C, 85% RH, 160 hours
- Endurance : 125°C, IR, 4 hours

TERMINATION

Nickel/Lead-Free Solder coating (Sn100) compatible with automatic soldering technologies: reflow, wave soldering, vapor phase and manual.

OPERATING TEMPERATURE

-40°C to +85°C

TERMINALS (Top View)

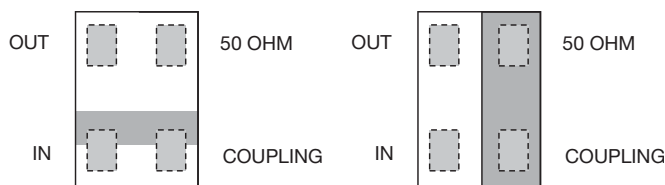

CP0302

CP0402

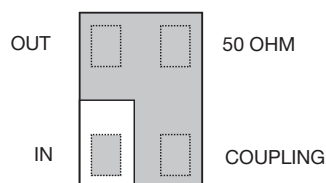

CP0603

	CP0302	CP0402	CP0603
L	0.65±0.04 (0.026±0.002)	1.0±0.05 (0.040±0.002)	1.6±0.1 (0.063±0.004)
W	0.50±0.04 (0.02±0.002)	0.58±0.04 (0.023±0.002)	0.84±0.1 (0.033±0.004)
T	0.25±0.05 (0.01±0.002)	0.35±0.05 (0.014±0.002)	0.60±0.1 (0.024±0.004)
A	0.20±0.05 (0.008±0.002)	0.20±0.05 (0.008±0.002)	0.25±0.05 (0.01±0.002)
B	0.10±0.04 (0.004±0.002)	0.18±0.05 (0.007±0.002)	0.20±0.05 (0.008±0.002)
S, H	0.025±0.025 (0.001±0.001)	0.05±0.05 (0.002±0.002)	0.05±0.05 (0.002±0.002)



RECOMMENDED PAD LAYOUT DIMENSIONS

mm (inches)

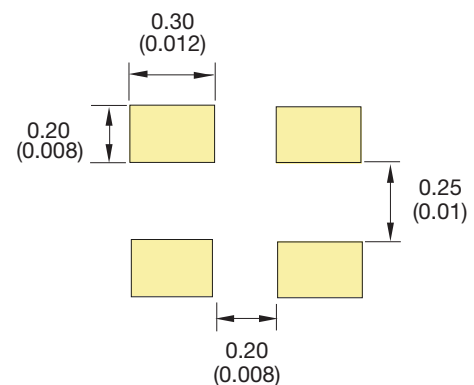

CP0302

CP0402 / CP0603: see pages 49 / 53

Thin Film Directional Couplers WiFi Band High Directivity



ELECTRICAL CHARACTERISTICS

P/N	Frequency [MHz]	Coupling [dB]	I. Loss max. [dB]	Return Loss [dB]	Directivity [dB]
CP0302P5425ENTR	2,400-2,496	-20±0.5	-0.2	-30	20
	4,900-5,950	-13±0.5	-0.4	-25	20

P/N	Frequency [MHz]	Coupling [dB]	I. Loss max. [dB]	Return Loss [dB]	Directivity [dB]
CP0302A5425ENTR	2,400-2,496	-20±1	-0.2	-30	20
	4,900-5,950	-13±1	-0.4	-25	20

P/N	Frequency [MHz]	Coupling [dB]	I. Loss max. [dB]	Return Loss [dB]	Directivity [dB]
CP0402Q5425ENTR CP0603Q5425ENTR	2,400-2,496	-20±1	-0.3	-30	20
	4,900-5,950	-13±1	-0.4	-25	20

3

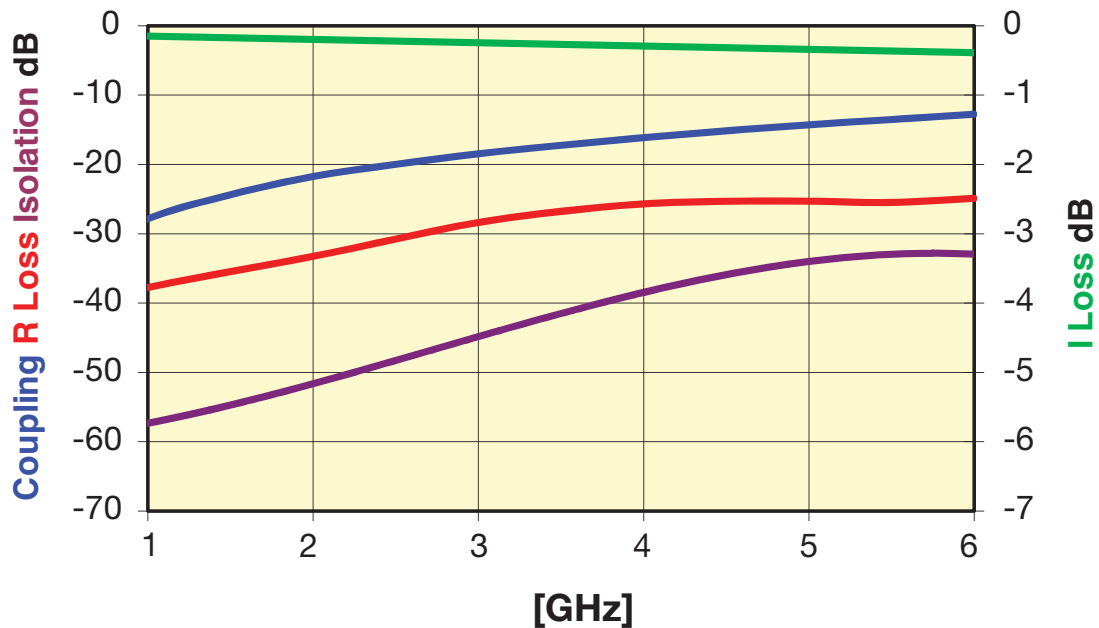

Thin Film Directional Coupler



CP0402P High Directivity, Tight Coupling Tolerance

GENERAL DESCRIPTION

ITF (Integrated Thin-Film) TECHNOLOGY

The CP0402P Series High Directivity, Tight Coupling Tolerance LGA Coupler is based on the proprietary RFAP Thin-Film multilayer technology. The technology provides a miniature part with excellent high frequency performance and rugged construction for reliable automatic assembly.

The ITF Coupler is offered in a variety of frequency bands compatible with various types of high frequency wireless systems.

APPLICATIONS

- Wireless communications
- Wireless LAN's
- GPS
- WiMAX

LAND GRID ARRAY ADVANTAGES

- Inherent Low Profile
- Self Alignment during Reflow
- Excellent Solderability
- Low Parasitics
- Better Heat Dissipation
- Power Rating 3W RF Continuous

DIMENSIONS: (Bottom View)

millimeters (inches)

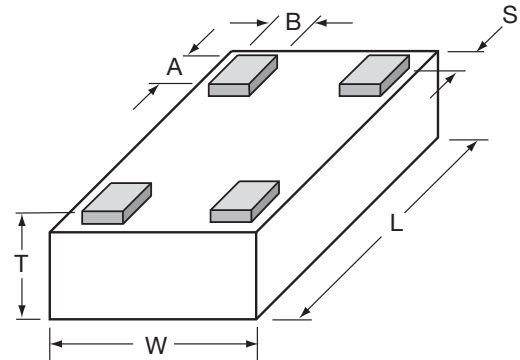

L	1.00±0.05 (0.040±0.002)	A	0.20±0.05 (0.008±0.002)
W	0.58±0.04 (0.023±0.002)	B	0.18±0.05 (0.007±0.002)
T	0.35±0.05 (0.014±0.002)	S	0.05±0.05 (0.002±0.002)

HOW TO ORDER

CP
T
Style

0402
T
Size
0402

P
T
Type
±0.5dB
Tight Tolerance

XXXX
T
Frequency
MHz

X
T
Sub-Type

N
T
Termination
LGA
Lead-Free

TR
T
Taped & Reeled

QUALITY INSPECTION

Finished parts are 100% tested for electrical parameters and visual characteristics. Each production lot is evaluated on a sample basis for:

- Static Humidity: 85°C, 85% RH, 160 hours
- Endurance: 125°C, I_b, 4 hours

TERMINATION

Nickel/Lead-Free Solder coating compatible with automatic soldering technologies: reflow, wave soldering, vapor phase and manual.

TERMINALS (Top View)

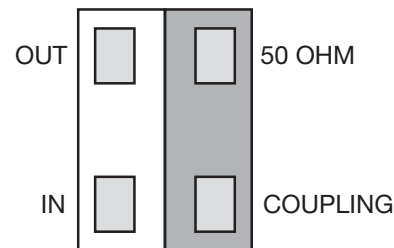

OPERATING TEMPERATURE:

-40°C to +85°C

Recommended Pad Layout Dimensions

mm (inches)

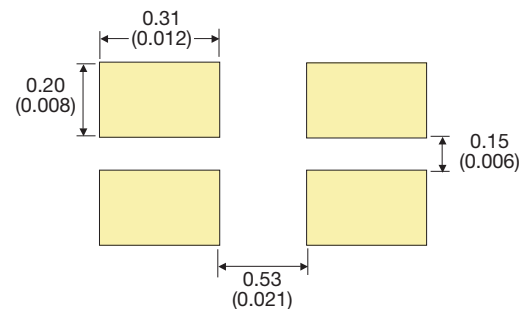

Thin Film Directional Coupler

CP0402P High Directivity, Tight Coupling Tolerance



Coupler P/N CP0402PxxxxAN

Application	P/N Examples*	Frequency Band [MHz]	Coupling [dB]	I. Loss max. [dB]	Return Loss [dB]	Directivity [dB]	
AMPS	CP0402P0836AN	824 - 849	19.10±0.5	0.25	32	21	
	CP0402P0881AN	869 - 894	18.60±0.5	0.25	31		
GSM	CP0402P0902AN	890 - 915	18.50±0.5	0.25	31		
	CP0402P0947AN	935 - 960	18.00±0.5	0.25	31		
E-GSM	CP0402P0897AN	880 - 915	18.50±0.5	0.25	31		
	CP0402P0942AN	925 - 960	18.00±0.5	0.25	31		
PDC	CP0402P1441AN	1429 - 1453	14.50±0.5	0.40	28		
PCN	CP0402P1747AN	1710 - 1785	13.00±0.5	0.50	26		
	CP0402P1842AN	1805 - 1880	12.50±0.5	0.50	26		
PCS	CP0402P1880AN	1850 - 1910	12.30±0.5	0.50	25		
	CP0402P1960AN	1930 - 1990	12.00±0.5	0.50	25		
PHP	CP0402P1907AN	1895 - 1920	12.30±0.5	0.50	25		
DECT	CP0402P1890AN	1880 - 1900	12.30±0.5	0.50	25		
Wireless LAN	CP0402P2442AN	2400 - 2484	10.30±0.5	0.70	23		
WiFi	CP0402P3500AN	3450 - 3550	7.60±0.5	1.30	15		14
	CP0402P5000AN	4950 - 5050	5.00±0.5	1.50	15		13
	CP0402P5500AN	5450 - 5550	4.60±0.5	1.50	14		13
	CP0402P6000AN	5950 - 6050	4.00±0.5	1.50	14		13

CP0402PxxxxANTR

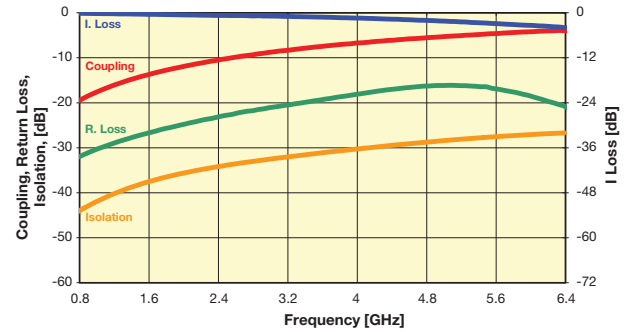

Coupler P/N CP0402PxxxxBN

Application	P/N Examples	Frequency Band [MHz]	Coupling [dB]	I. Loss max. [dB]	Return Loss [dB]	Directivity [dB]	
AMPS	CP0402P0836BN	824 - 849	22.00±0.5	0.20	28	27	
	CP0402P0881BN	869 - 894	21.70±0.5	0.20	28		
GSM	CP0402P0902BN	890 - 915	21.50±0.5	0.20	28		
	CP0402P0947BN	935 - 960	21.00±0.5	0.25	27		
E-GSM	CP0402P0897BN	880 - 915	21.50±0.5	0.20	28		
	CP0402P0942BN	925 - 960	21.00±0.5	0.25	27		
PDC	CP0402P1441BN	1429 - 1453	17.50±0.5	0.25	24		
PCN	CP0402P1747BN	1710 - 1785	16.00±0.5	0.30	23		
	CP0402P1842BN	1805 - 1880	15.50±0.5	0.35	23		
PCS	CP0402P1880BN	1850 - 1910	15.50±0.5	0.35	23		
	CP0402P1960BN	1930 - 1990	15.00±0.5	0.35	22		
PHP	CP0402P1907BN	1895 - 1920	15.50±0.5	0.35	23		
DECT	CP0402P1890BN	1880 - 1900	15.50±0.5	0.35	23		
Wireless LAN	CP0402P2442BN	2400 - 2484	13.30±0.5	0.40	21		
WiFi	CP0402P3500BN	3450 - 3550	9.40±0.5	0.80	18		14
	CP0402P5000BN	4950 - 5050	7.40±0.5	1.20	14		13
	CP0402P5500BN	5450 - 5550	6.70±0.5	1.60	14		13
	CP0402P6000BN	5950 - 6050	6.10±0.5	2.00	14		13

CP0402PxxxxBNTR

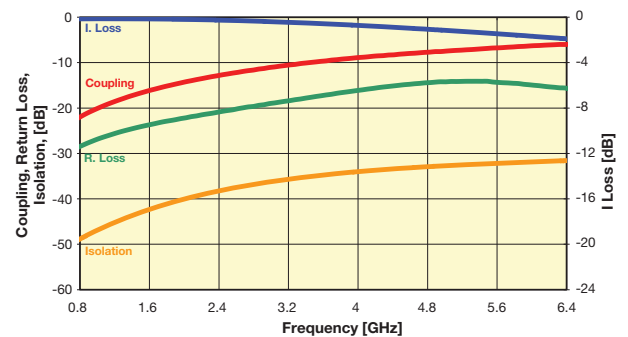

Coupler P/N CP0402PxxxxEN

Application	P/N Examples	Frequency Band [MHz]	Coupling [dB]	I. Loss max. [dB]	Return Loss [dB]	Directivity [dB]	
AMPS	CP0402P0836EN	824 - 849	27.20±0.5	0.20	35	25	
	CP0402P0881EN	869 - 894	26.80±0.5	0.20	34		
GSM	CP0402P0902EN	890 - 915	26.50±0.5	0.20	34		
	CP0402P0947EN	935 - 960	26.00±0.5	0.20	34		
E-GSM	CP0402P0897EN	880 - 915	26.50±0.5	0.20	34		
	CP0402P0942EN	925 - 960	26.00±0.5	0.20	34		
PDC	CP0402P1441EN	1429 - 1453	22.30±0.5	0.25	29		
PCN	CP0402P1747EN	1710 - 1785	20.50±0.5	0.25	27		
	CP0402P1842EN	1805 - 1880	20.30±0.5	0.25	26		
PCS	CP0402P1880EN	1850 - 1910	20.00±0.5	0.25	26		
	CP0402P1960EN	1930 - 1990	20.00±0.5	0.25	26		
PHP	CP0402P1907EN	1895 - 1920	20.00±0.5	0.25	26		
DECT	CP0402P1890EN	1880 - 1900	20.00±0.5	0.25	26		
Wireless LAN	CP0402P2442EN	2400 - 2484	18.00±0.5	0.35	23		
WiFi	CP0402P3500EN	3450 - 3550	15.00±0.5	0.37	20		16
	CP0402P5000EN	4950 - 5050	12.50±0.5	0.50	18		13
	CP0402P5500EN	5450 - 5550	11.50±0.5	0.65	16		13
	CP0402P6000EN	5950 - 6050	11.10±0.5	0.70	15		13

CP0402PxxxxENTR

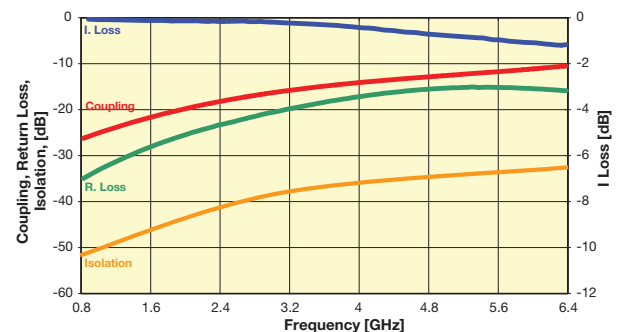

Thin-Film Directional Couplers



CP0402 High Directivity LGA Termination

GENERAL DESCRIPTION

ITF (Integrated Thin-Film) TECHNOLOGY

The ITF High Directivity LGA Coupler is based on thin-film multilayer technology. The technology provides a miniature part with excellent high frequency performance and rugged construction for reliable automatic assembly.

The ITF Coupler is offered in a variety of frequency bands compatible with various types of high frequency wireless systems.

APPLICATIONS

- Mobile Communications
- Satellite TV Receivers
- GPS
- Vehicle Location Systems
- Wireless LAN's

FEATURES

- Inherent Low Profile
- Self Alignment during Reflow
- Excellent Solderability
- Low Parasitics
- Better Heat Dissipation
- Operating/Storage Temp -40°C to +85°C
- Power Rating 3W RF Cont

DIMENSIONS: (Bottom View)

millimeters (inches)

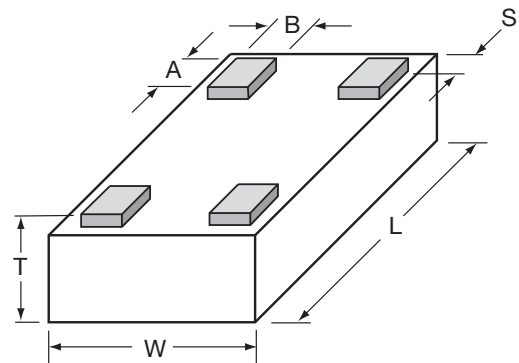

L	1.00±0.05 (0.040±0.002)
W	0.58±0.04 (0.023±0.002)
T	0.35±0.05 (0.014±0.002)

A	0.20±0.05 (0.008±0.002)
B	0.18±0.05 (0.007±0.002)
S	0.05±0.05 (0.002±0.002)

HOW TO ORDER

CP T	0402 T	X T	**** T	X T	N T	TR T
Style	Size	Type	Frequency (MHz)	Sub Type	LGA Termination	Packaging Code
Directional Coupler	0402				L = LGA Sn90, Pb10 **N = LGA Sn100	TR = Tape and Reel
					**RoHS compliant	

QUALITY INSPECTION

Finished parts are 100% tested for electrical parameters and visual characteristics. Each production lot is evaluated on a sample basis for:

- Static Humidity: 85°C, 85% RH, 160 hours
- Endurance: 125°C, I_R, 4 hours

TERMINATION

Sn90Pb10 or Lead-Free Sn100 Nickel/Solder coating compatible with automatic soldering technologies: reflow, wave soldering, vapor phase and manual.

ORIENTATION IN TAPE

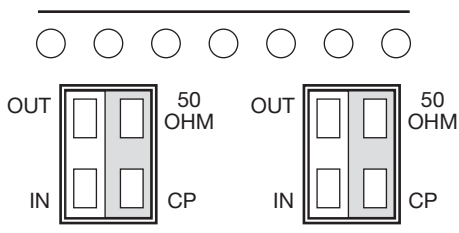

TERMINALS (Top View)

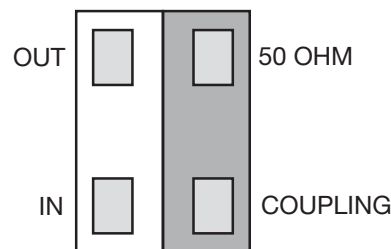

Not RoHS Compliant



For RoHS compliant products, please select correct termination style.

Recommended Pad Layout Dimensions

mm (inches)

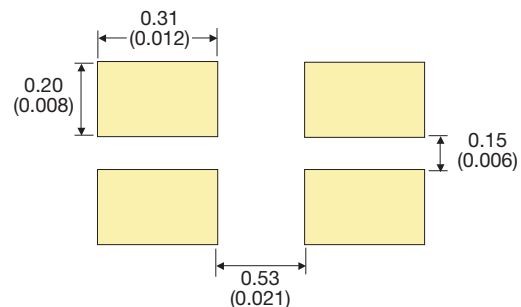

*The recommended distance to the PCB Ground Plane is 0.254mm (0.010")



Thin-Film Directional Couplers



CP0402 High Directivity LGA Termination

CP0402 - TYPE SELECTION CHART

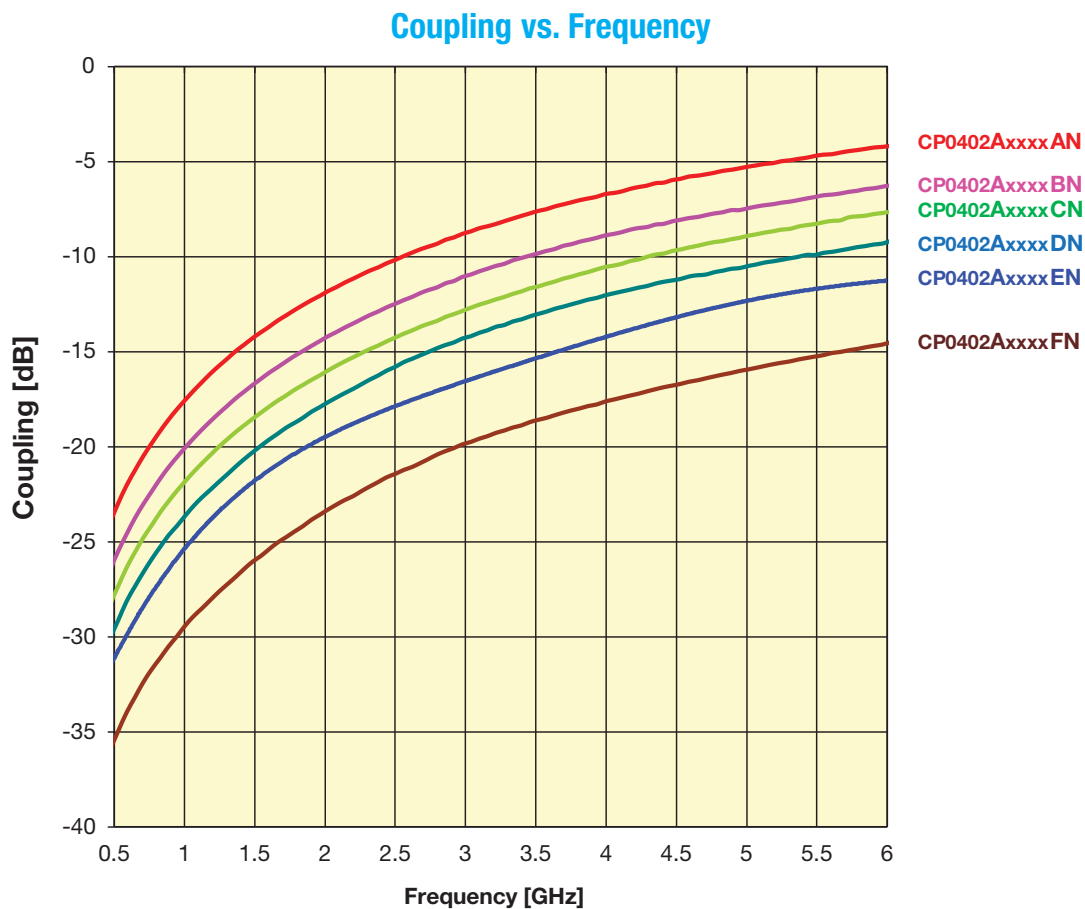

Intermediate coupling factors are readily available.
Please contact factory.

3

Thin-Film Directional Couplers



CP0402 High Directivity LGA Termination

Coupler P/N CP0402AxxxxAN

Application	P/N Examples*	Frequency Band [MHz]	Coupling [dB]	I. Loss max. [dB]	Return Loss [dB]	Directivity [dB]	
AMPS	CP0402A0836AN	824 - 849	19.10	0.25	32	21	
	CP0402A0881AN	869 - 894	18.60	0.25	31		
GSM	CP0402A0902AN	890 - 915	18.50	0.25	31		
	CP0402A0947AN	935 - 960	18.00	0.25	31		
E-GSM	CP0402A0897AN	880 ÷ 915	18.50	0.25	31		
	CP0402A0942AN	925 ÷ 960	18.00	0.25	31		
PDC	CP0402A1441AN	1429 - 1453	14.50	0.40	28		
PCN	CP0402A1747AN	1710 - 1785	13.00	0.50	26		
	CP0402A1842AN	1805 - 1880	12.50	0.50	26		
PCS	CP0402A1880AN	1850 - 1910	12.30	0.50	25		
	CP0402A1960AN	1930 - 1990	12.00	0.50	25		
PHP	CP0402A1907AN	1895 - 1920	12.30	0.50	25		
DECT	CP0402A1890AN	1880 - 1900	12.30	0.50	25		
Wireless LAN	CP0402A2442AN	2400 - 2484	10.30	0.70	23		
WiFi	CP0402A3500AN	3450 - 3550	7.60	1.30	15		14
	CP0402A5000AN	4950 - 5050	5.00	1.50	15		13
	CP0402A5500AN	5450 - 5550	4.60	1.50	14	13	
	CP0402A6000AN	5950 - 6050	4.00	1.50	14	13	

CP0402AxxxxANTR

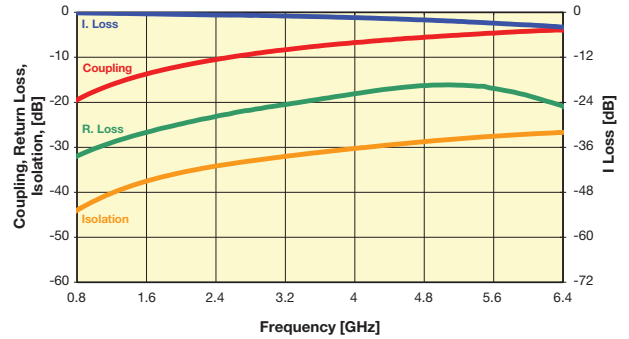

Coupler P/N CP0402AxxxxBN

Application	P/N Examples	Frequency Band [MHz]	Coupling [dB]	I. Loss max. [dB]	Return Loss [dB]	Directivity [dB]	
AMPS	CP0402A0836BN	824 - 849	22.00	0.20	28	27	
	CP0402A0881BN	869 - 894	21.70	0.20	28		
GSM	CP0402A0902BN	890 - 915	21.50	0.20	28		
	CP0402A0947BN	935 - 960	21.00	0.25	27		
E-GSM	CP0402A0897BN	880 ÷ 915	21.50	0.20	28		
	CP0402A0942BN	925 ÷ 960	21.00	0.25	27		
PDC	CP0402A1441BN	1429 - 1453	17.50	0.25	24		
PCN	CP0402A1747BN	1710 - 1785	16.00	0.30	23		
	CP0402A1842BN	1805 - 1880	15.50	0.35	23		
PCS	CP0402A1880BN	1850 - 1910	15.50	0.35	23		
	CP0402A1960BN	1930 - 1990	15.00	0.35	22		
PHP	CP0402A1907BN	1895 - 1920	15.50	0.35	23		
DECT	CP0402A1890BN	1880 - 1900	15.50	0.35	23		
Wireless LAN	CP0402A2442BN	2400 - 2484	13.30	0.40	21		
WiFi	CP0402A3500BN	3450 - 3550	9.40	0.80	18		14
	CP0402A5000BN	4950 - 5050	7.40	1.20	14		13
	CP0402A5500BN	5450 - 5550	6.70	1.60	14	13	
	CP0402A6000BN	5950 - 6050	6.10	2.00	14	13	

CP0402AxxxxBNTR

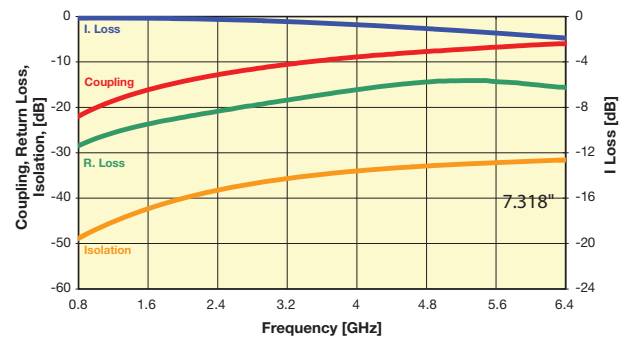

Coupler P/N CP0402AxxxxCN

Application	P/N Examples	Frequency Band [MHz]	Coupling [dB]	I. Loss max. [dB]	Return Loss [dB]	Directivity [dB]	
AMPS	CP0402A0836CN	824 - 849	23.60	0.20	33	22	
	CP0402A0881CN	869 - 894	23.00	0.20	33		
GSM	CP0402A0902CN	890 - 915	23.00	0.20	26		
	CP0402A0947CN	935 - 960	22.50	0.20	33		
E-GSM	CP0402A0897CN	880 ÷ 915	23.00	0.20	25		
	CP0402A0942CN	925 ÷ 960	22.50	0.20	32		
PDC	CP0402A1441CN	1429 - 1453	19.00	0.25	31		
PCN	CP0402A1747CN	1710 - 1785	17.20	0.25	30		
	CP0402A1842CN	1805 - 1880	17.00	0.25	30		
PCS	CP0402A1880CN	1850 - 1910	16.80	0.25	30		
	CP0402A1960CN	1930 - 1990	16.50	0.25	29		
PHP	CP0402A1907CN	1895 - 1920	16.80	0.25	29		
DECT	CP0402A1890CN	1880 - 1900	16.80	0.25	30		
Wireless LAN	CP0402A2442CN	2400 - 2484	14.70	0.45	28		
WiFi	CP0402A3500CN	3450 - 3550	10.97	0.67	23		17
	CP0402A5000CN	4950 - 5050	8.00	1.00	21		16
	CP0402A5500CN	5450 - 5550	7.50	1.10	21	15	
	CP0402A6000CN	5950 - 6050	7.10	1.30	23	15	

CP0402AxxxxCNTR

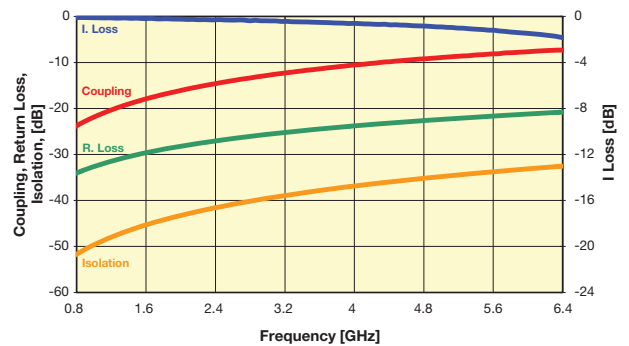

Important: Couplers can be used at any frequency within the indicated range.



Thin-Film Directional Couplers



CP0402 High Directivity LGA Termination

Coupler P/N CP0402AxxxxDN

Application	P/N Examples*	Frequency Band [MHz]	Coupling [dB]	I. Loss max. [dB]	Return Loss [dB]	Directivity [dB]
AMPS	CP0402A0836DN	824 - 849	25.20	0.20	29	20
	CP0402A0881DN	869 - 894	24.80	0.20	28	
GSM	CP0402A0902DN	890 - 915	24.70	0.20	28	
	CP0402A0947DN	935 - 960	24.10	0.20	28	
E-GSM	CP0402A0897DN	880 ÷ 915	24.70	0.20	28	
	CP0402A0942DN	925 ÷ 960	24.10	0.20	28	
PDC	CP0402A1441DN	1429 - 1453	20.50	0.20	25	18
PCN	CP0402A1747DN	1710 - 1785	19.00	0.20	24	
	CP0402A1842DN	1805 - 1880	18.50	0.25	23	
PCS	CP0402A1880DN	1850 - 1910	18.20	0.25	23	
	CP0402A1960DN	1930 - 1990	18.00	0.25	23	
PHP	CP0402A1907DN	1895 - 1920	18.10	0.25	23	
DECT	CP0402A1890DN	1880 - 1900	18.20	0.25	23	
Wireless LAN	CP0402A2442DN	2400 - 2484	16.00	0.35	22	17
WiFi	CP0402A3500DN	3450 - 3550	12.50	0.46	21	
	CP0402A5000DN	4950 - 5050	10.00	0.65	21	
	CP0402A5500DN	5450 - 5550	9.60	0.76	20	
	CP0402A6000DN	5950 - 6050	9.10	0.84	20	

CP0402AxxxxDNTR

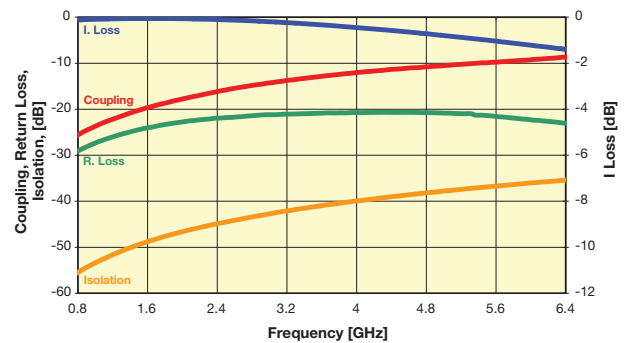

Coupler P/N CP0402AxxxxEN

Application	P/N Examples	Frequency Band [MHz]	Coupling [dB]	I. Loss max. [dB]	Return Loss [dB]	Directivity [dB]
AMPS	CP0402A0836EN	824 - 849	27.20	0.20	35	25
	CP0402A0881EN	869 - 894	26.80	0.20	34	
GSM	CP0402A0902EN	890 - 915	26.50	0.20	34	
	CP0402A0947EN	935 - 960	26.00	0.20	34	
E-GSM	CP0402A0897EN	880 ÷ 915	26.50	0.20	34	
	CP0402A0942EN	925 ÷ 960	26.00	0.20	34	
PDC	CP0402A1441EN	1429 - 1453	22.30	0.25	29	23
PCN	CP0402A1747EN	1710 - 1785	20.50	0.25	27	
	CP0402A1842EN	1805 - 1880	20.30	0.25	26	
PCS	CP0402A1880EN	1850 - 1910	20.00	0.25	26	
	CP0402A1960EN	1930 - 1990	20.00	0.25	26	
PHP	CP0402A1907EN	1895 - 1920	20.00	0.25	26	
DECT	CP0402A1890EN	1880 - 1900	20.00	0.25	26	
Wireless LAN	CP0402A2442EN	2400 - 2484	18.00	0.35	23	16
WiFi	CP0402A3500EN	3450 - 3550	15.00	0.37	20	
	CP0402A5000EN	4950 - 5050	12.50	0.50	18	
	CP0402A5500EN	5450 - 5550	11.50	0.65	16	
	CP0402A6000EN	5950 - 6050	11.10	0.70	15	

CP0402AxxxxENTR

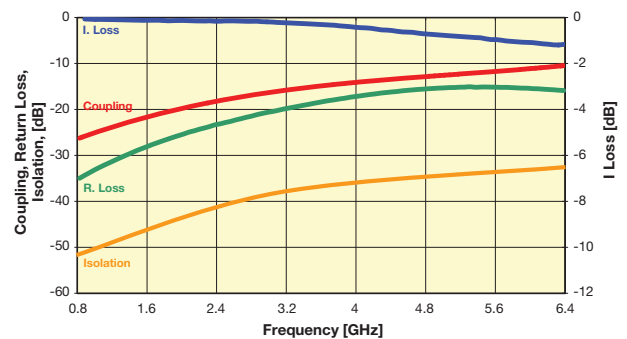

Coupler P/N CP0402AxxxxFN

Application	P/N Examples	Frequency Band [MHz]	Coupling [dB]	I. Loss max. [dB]	Return Loss [dB]	Directivity [dB]
AMPS	CP0402A0836FN	824 - 849	31.00	0.20	29.10	11
	CP0402A0881FN	869 - 894	30.70	0.20	28.60	
GSM	CP0402A0902FN	890 - 915	30.60	0.20	28.50	
	CP0402A0947FN	935 - 960	30.00	0.20	28.10	
E-GSM	CP0402A0897FN	880 ÷ 915	30.60	0.20	28.50	
	CP0402A0942FN	925 ÷ 960	30.00	0.20	28.10	
PDC	CP0402A1441FN	1429 - 1453	26.50	0.20	25.00	9
PCN	CP0402A1747FN	1710 - 1785	25.00	0.20	23.80	
	CP0402A1842FN	1805 - 1880	24.50	0.20	23.60	
PCS	CP0402A1880FN	1850 - 1910	24.20	0.20	23.50	
	CP0402A1960FN	1930 - 1990	24.00	0.20	23.30	
PHP	CP0402A1907FN	1895 - 1920	24.20	0.20	23.40	
DECT	CP0402A1890FN	1880 - 1900	24.20	0.20	23.50	
Wireless LAN	CP0402A2442FN	2400 - 2484	22.00	0.25	22.60	8
WiFi	CP0402A3500FN	3450 - 3550	18.00	0.27	22.00	
	CP0402A5000FN	4950 - 5050	15.70	0.30	23.01	
	CP0402A5500FN	5450 - 5550	15.20	0.30	20.36	
	CP0402A6000FN	5950 - 6050	14.50	0.30	18.94	

CP0402AxxxxFNTR

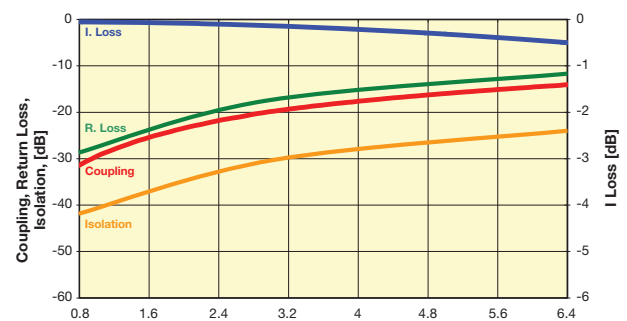

Important: Couplers can be used at any frequency within the indicated range.



Thin-Film Directional Couplers



CP0603 High Directivity LGA Termination

GENERAL DESCRIPTION ITF (Integrated Thin-Film) TECHNOLOGY

The ITF LGA Coupler is based on thin-film multilayer technology. The technology provides a miniature part with excellent high frequency performance and rugged construction for reliable automatic assembly. The ITF Coupler is offered in a variety of frequency bands compatible with various types of high frequency wireless systems.

APPLICATIONS

- Mobile Communications
- Satellite TV Receivers
- GPS
- Vehicle Location Systems
- Wireless LAN's

FEATURES

- Inherent Low Profile
- Self Alignment during Reflow
- Excellent Solderability
- Low Parasitics
- Better Heat Dissipation
- Operating/Storage Temp -40°C to +85°C
- Power Rating 3W RF Cont

HOW TO ORDER

CP T Style Directional Coupler	0603 T Size 0603	X T Type	**** T Frequency (MHz)	X T Sub Type	N T Termination Code L = LGA Sn90, Pb10 **N = LGA Sn100	TR T Packaging Code TR = Tape and Reel
---	---	------------------------------	---	----------------------------------	---	---

****RoHS compliant**

QUALITY INSPECTION

Finished parts are 100% tested for electrical parameters and visual characteristics. Each production lot is evaluated on a sample basis for:

- Static Humidity: 85°C, 85% RH, 160 hours
- Endurance: 125°C, I_R, 4 hours

TERMINATION

Sn90Pb10 or Lead-Free Sn100 Nickel/Solder coating compatible with automatic soldering technologies: reflow, wave soldering, vapor phase and manual.

ORIENTATION IN TAPE

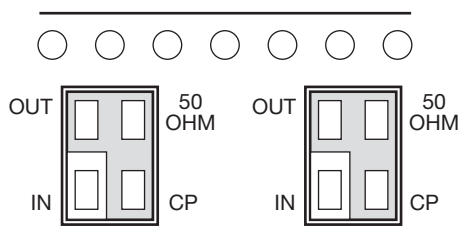

DIMENSIONS: (Bottom View)

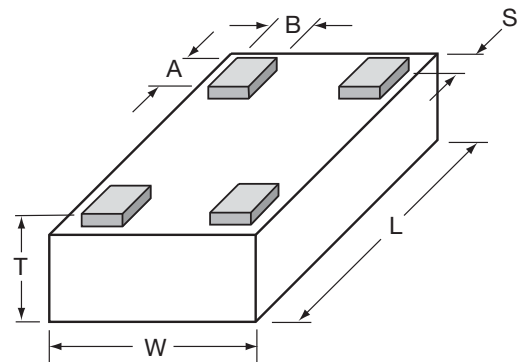

L	1.60±0.10 (0.063±0.004)	A	0.25±0.05 (0.010±0.002)
W	0.84±0.10 (0.033±0.004)	B	0.20±0.05 (0.008±0.002)
T	0.60±0.10 (0.024±0.004)	S	0.05±0.05 (0.002±0.002)

TERMINALS (Top View)

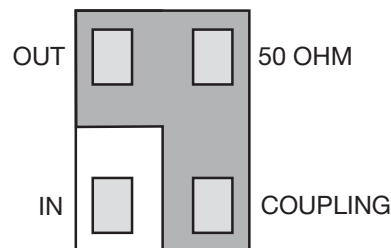

Not RoHS Compliant



For RoHS compliant products, please select correct termination style.

Recommended Pad Layout Dimensions

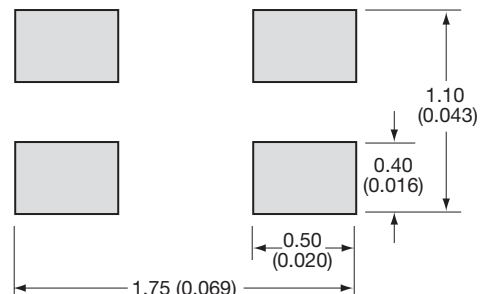

*The recommended distance to the PCB Ground Plane is 0.254mm (0.010")



Thin-Film Directional Couplers



CP0603 High Directivity LGA Termination

CP0603 - TYPE SELECTION CHART

Coupling vs. Frequency

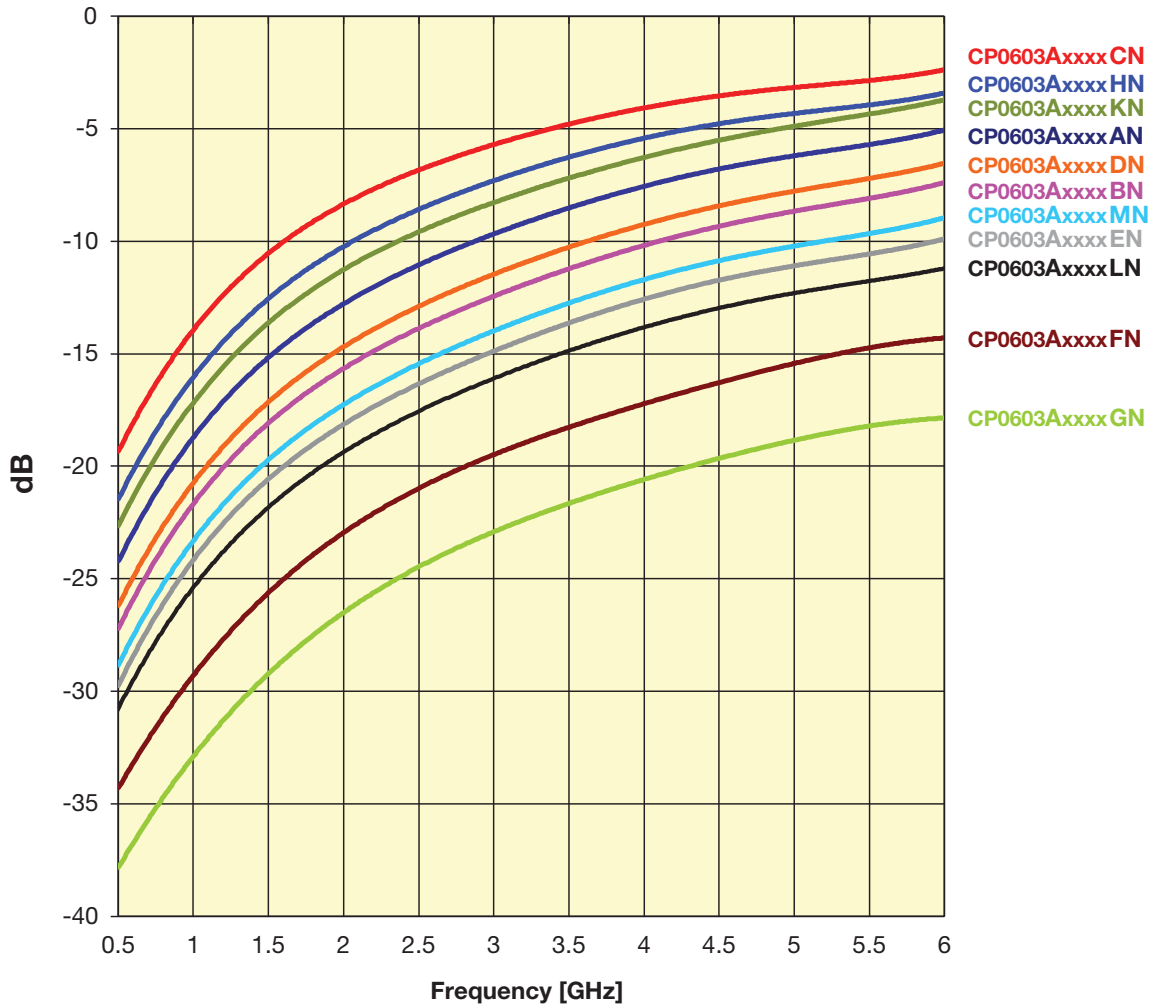

Intermediate coupling factors are readily available.
Please contact factory.

3

Thin-Film Directional Couplers



CP0603 High Directivity LGA Type

Coupler P/N CP0603AxxxxAN

Application	P/N Examples*	Frequency Band [MHz]	Coupling [dB]	I. Loss max. [dB]	Return Loss [dB]	Directivity [dB]
AMPS	CP0603A0836AN	824 - 849	20.0	0.25	28	22
	CP0603A0881AN	869 - 894	19.7	0.25	28	
GSM	CP0603A0902AN	890 - 915	19.4	0.25	27	
	CP0603A0947AN	935 - 960	19.0	0.25	27	
E-GSM	CP0603A0897AN	880 - 915	19.4	0.25	28	
	CP0603A0942AN	925 - 960	19.0	0.25	27	
PDC	CP0603A1441AN	1429 - 1453	15.5	0.40	24	
PCN	CP0603A1747AN	1710 - 1785	14.0	0.50	22	
	CP0603A1842AN	1805 - 1880	13.5	0.50	22	
PCS	CP0603A1880AN	1850 - 1910	13.2	0.50	22	
	CP0603A1960AN	1930 - 1990	13.0	0.55	21	
PHP	CP0603A1907AN	1895 - 1920	13.2	0.50	22	
DECT	CP0603A1890AN	1880 - 1900	13.2	0.50	22	
Wireless LAN	CP0603A2442AN	2400 - 2484	11.5	0.75	20	
	CP0603A3500AN	3450 - 3550	8.6	1.3	17	
WiFi	CP0603A5000AN	4950 - 5050	6.1	2.2	13	
	CP0603A5500AN	5450 - 5550	5.5	2.5	15	
	CP0603A6000AN	5950 - 6050	5	3	11.6	

CP0603AxxxxANTR

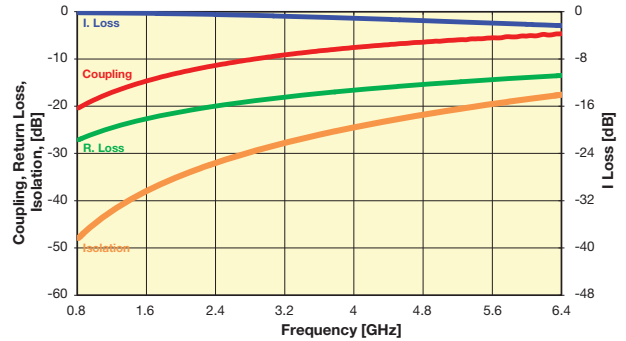

Coupler P/N CP0603AxxxxBN

Application	P/N Examples*	Frequency Band [MHz]	Coupling [dB]	I. Loss max. [dB]	Return Loss [dB]	Directivity [dB]
AMPS	CP0603A0836BN	824 - 849	23.0	0.20	31	24
	CP0603A0881BN	869 - 894	22.7	0.20	31	
GSM	CP0603A0902BN	890 - 915	22.5	0.20	31	
	CP0603A0947BN	935 - 960	22.0	0.20	30	
E-GSM	CP0603A0897BN	880 - 915	22.5	0.20	31	
	CP0603A0942BN	925 - 960	22.0	0.20	30	
PDC	CP0603A1441BN	1429 - 1453	18.5	0.25	27	
PCN	CP0603A1747BN	1710 - 1785	17.0	0.25	25	
	CP0603A1842BN	1805 - 1880	16.4	0.25	25	
PCS	CP0603A1880BN	1850 - 1910	16.2	0.25	25	
	CP0603A1960BN	1930 - 1990	16.0	0.25	24	
PHP	CP0603A1907BN	1895 - 1920	16.1	0.25	25	
DECT	CP0603A1890BN	1880 - 1900	16.2	0.25	25	
Wireless LAN	CP0603A2442BN	2400 - 2484	14.2	0.35	23	
	CP0603A3500BN	3450 - 3550	11.2	0.6	20	
WiFi	CP0603A5000BN	4950 - 5050	8.4	1.1	16.7	
	CP0603A5500BN	5450 - 5550	7.8	1.4	15.7	
	CP0603A6000BN	5950 - 6050	7.2	1.6	15	

CP0603AxxxxBNTR

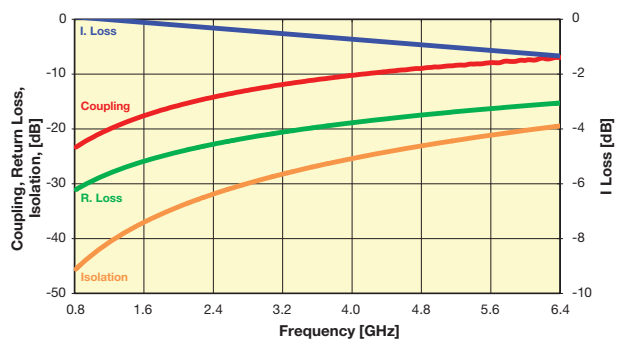

Coupler P/N CP0603AxxxxCN

Application	P/N Examples*	Frequency Band [MHz]	Coupling [dB]	I. Loss max. [dB]	Return Loss [dB]	Directivity [dB]
AMPS	CP0603A0836CN	824 - 849	15.2	0.35	23	23
	CP0603A0881CN	869 - 894	15.0	0.35	23	
GSM	CP0603A0902CN	890 - 915	14.7	0.35	23	
	CP0603A0947CN	935 - 960	14.3	0.40	22	
E-GSM	CP0603A0897CN	880 - 915	14.7	0.35	23	
	CP0603A0942CN	925 - 960	14.3	0.40	22	
PDC	CP0603A1441CN	1429 - 1453	11.0	0.70	19	
PCN	CP0603A1747CN	1710 - 1785	9.5	0.80	18	
	CP0603A1842CN	1805 - 1880	9.0	0.90	17	
PCS	CP0603A1880CN	1850 - 1910	8.8	0.90	17	
	CP0603A1960CN	1930 - 1990	8.5	1.00	17	
PHP	CP0603A1907CN	1895 - 1920	8.8	0.90	17	
DECT	CP0603A1890CN	1880 - 1900	8.8	0.90	17	
Wireless LAN	CP0603A2442CN	2400 - 2484	7.0	1.40	15	
	CP0603A3500CN	3450 - 3550	4.8	2.0	23	
WiFi	CP0603A5000CN	4950 - 5050	3.0	3.6	21	
	CP0603A5500CN	5450 - 5550	3.0	4.0	20.6	
	CP0603A6000CN	5950 - 6050	2.5	4.5	20.5	

CP0603AxxxxCNTR

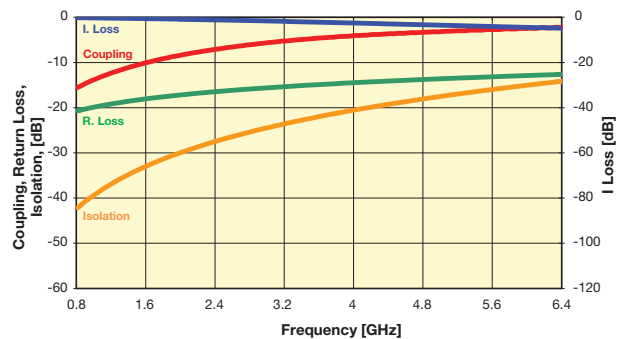

Important: Couplers can be used at any frequency within the indicated range.



Thin-Film Directional Couplers



CP0603 High Directivity LGA Type

Coupler P/N CP0603AxxxxDN

Application	P/N Examples*	Frequency Band [MHz]	Coupling [dB]	I. Loss max. [dB]	Return Loss [dB]	Directivity [dB]	
AMPS	CP0603A0836DN	824 - 849	22.0	0.25	31	30	
	CP0603A0881DN	869 - 894	21.8	0.25	30		
GSM	CP0603A0902DN	890 - 915	21.3	0.25	30		
	CP0603A0947DN	935 - 960	21.0	0.30	30		
E-GSM	CP0603A0897DN	880 - 915	21.3	0.25	30		
	CP0603A0942DN	925 - 960	21.0	0.30	30		
PDC	CP0603A1441DN	1429 - 1453	17.7	0.40	27		25
PCN	CP0603A1747DN	1710 - 1785	16.0	0.40	25		
	CP0603A1842DN	1805 - 1880	15.4	0.40	25		
PCS	CP0603A1880DN	1850 - 1910	15.2	0.40	24		
	CP0603A1960DN	1930 - 1990	15.0	0.40	24		
PHP	CP0603A1907DN	1895 - 1920	15.2	0.40	24		
DECT	CP0603A1890DN	1880 - 1900	15.2	0.40	24		
Wireless LAN	CP0603A2442DN	2400 - 2484	13.3	0.55	22		
WiFi	CP0603A3500DN	3450 - 3550	10.1	0.66	25.3	20	
	CP0603A5000DN	4950 - 5050	7.8	1.17	21.1	18	
	CP0603A5500DN	5450 - 5550	6.8	1.39	19.9	18	
	CP0603A6000DN	5950 - 6050	6.3	1.64	18.8	17	

CP0603AxxxxDNTR

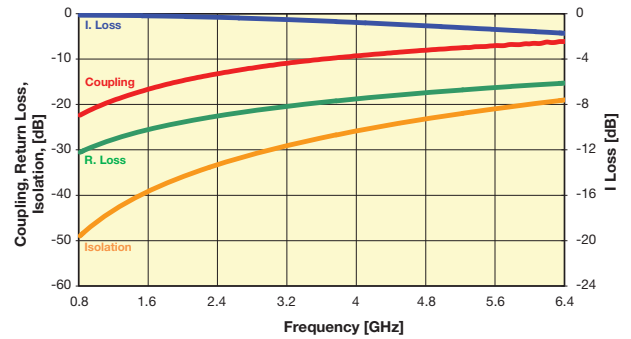

Coupler P/N CP603AxxxxEN

Application	P/N Examples*	Frequency Band [MHz]	Coupling [dB]	I. Loss max. [dB]	Return Loss [dB]	Directivity [dB]	
AMPS	CP0603A0836EN	824 - 849	25.8	0.20	32	21	
	CP0603A0881EN	869 - 894	25.3	0.20	32		
GSM	CP0603A0902EN	890 - 915	25.0	0.20	32		
	CP0603A0947EN	935 - 960	24.7	0.20	31		
E-GSM	CP0603A0897EN	880 - 915	26.0	0.20	32		
	CP0603A0942EN	925 - 960	24.7	0.20	31		
PDC	CP0603A1441EN	1429 - 1453	22.0	0.25	28		20
PCN	CP0603A1747EN	1710 - 1785	19.5	0.30	26		
	CP0603A1842EN	1805 - 1880	19.0	0.30	26		
PCS	CP0603A1880EN	1850 - 1910	18.8	0.30	26		
	CP0603A1960EN	1930 - 1990	18.5	0.30	26		
PHP	CP0603A1907EN	1895 - 1920	18.7	0.30	26		
DECT	CP0603A1890EN	1880 - 1900	18.8	0.30	26		
Wireless LAN	CP0603A2442EN	2400 - 2484	17.0	0.40	24		
WiFi	CP0603A3500EN	3450 - 3550	13.2	0.5	18	16	
	CP0603A5000EN	4950 - 5050	10.7	0.9	13	15	
	CP0603A5500EN	5450 - 5550	10.2	1.2	12	15	
	CP0603A6000EN	5950 - 6050	9.7	1.4	12	14	

CP0603AxxxxENTR

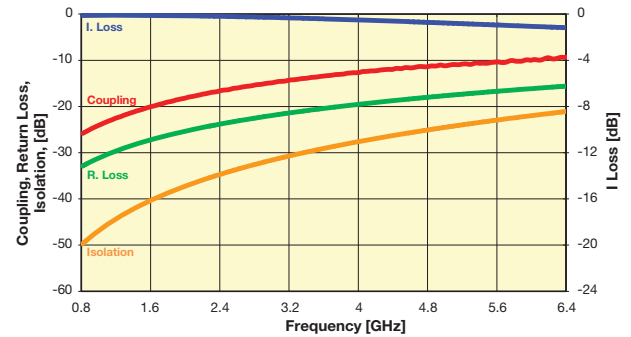

Coupler P/N CP603AxxxxFN

Application	P/N Examples*	Frequency Band [MHz]	Coupling [dB]	I. Loss max. [dB]	Return Loss [dB]	Directivity [dB]	
AMPS	CP0603A0836FN	824 - 849	31.2	0.20	32	12	
	CP0603A0881FN	869 - 894	30.8	0.20	32		
GSM	CP0603A0902FN	890 - 915	30.5	0.20	30		
	CP0603A0947FN	935 - 960	30.2	0.20	30		
E-GSM	CP0603A0897FN	880 - 915	30.5	0.20	30		
	CP0603A0942FN	925 - 960	30.2	0.20	30		
PDC	CP0603A1441FN	1429 - 1453	27.0	0.25	28		13
PCN	CP0603A1747FN	1710 - 1785	25.0	0.25	27		
	CP0603A1842FN	1805 - 1880	26.5	0.25	27		
PCS	CP0603A1880FN	1850 - 1910	24.3	0.25	27		
	CP0603A1960FN	1930 - 1990	24.0	0.25	28		
PHP	CP0603A1907FN	1895 - 1920	24.2	0.25	27		
DECT	CP0603A1890FN	1880 - 1900	24.2	0.25	27		
Wireless LAN	CP0603A2442FN	2400 - 2484	21.5	0.25	25		
WiFi	CP0603A3500FN	3450 - 3550	17.8	0.33	20.0	12	
	CP0603A5000FN	4950 - 5050	15.4	0.62	14.86	12	
	CP0603A5500FN	5450 - 5550	14.8	0.86	13.58	12	
	CP0603A6000FN	5950 - 6050	14.3	1.02	12.58	11	

CP0603AxxxxFNTR

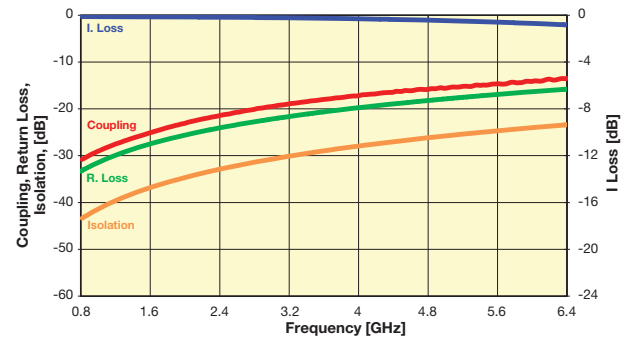

Important: Couplers can be used at any frequency within the indicated range.

Thin-Film Directional Couplers



CP0603 High Directivity LGA Type

Coupler P/N CP603AxxxxGN

Application	P/N Examples*	Frequency Band [MHz]	Coupling [dB]	I. Loss max. [dB]	Return Loss [dB]	Directivity [dB]
AMPS	CP0603A0836GN	824 - 849	34.2	0.20	30	13
	CP0603A0881GN	869 - 894	33.8	0.20	30	
GSM	CP0603A0902GN	890 - 915	33.6	0.20	30	
	CP0603A0947GN	935 - 960	33.2	0.20	29	
E-GSM	CP0603A0897GN	880 - 915	33.6	0.20	30	
	CP0603A0942GN	925 - 960	33.2	0.20	29	
PDC	CP0603A1441GN	1429 - 1453	30.0	0.25	25	
PCN	CP0603A1747GN	1710 - 1785	28.5	0.25	24	
	CP0603A1842GN	1805 - 1880	28.0	0.25	24	
PCS	CP0603A1880GN	1850 - 1910	27.7	0.25	24	
	CP0603A1960GN	1930 - 1990	27.5	0.25	23	
PHP	CP0603A1907GN	1895 - 1920	27.6	0.25	24	
DECT	CP0603A1890GN	1880 - 1900	27.7	0.25	24	
Wireless LAN	CP0603A2442GN	2400 - 2484	25.5	0.25	22	
WiFi	CP0603A3500GN	3450 - 3550	21.6	0.31	20	13
	CP0603A5000GN	4950 - 5050	19	0.39	16	12
	CP0603A5500GN	5450 - 5550	18.5	0.57	15	12
	CP0603A6000GN	5950 - 6050	18.0	0.74	14	11

CP0603AxxxxGNTR

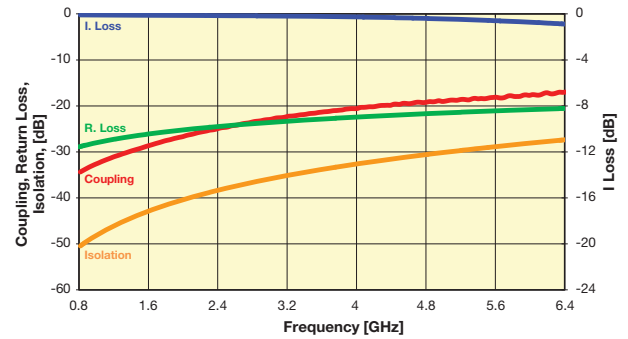

Coupler P/N CP603AxxxxHN

Application	P/N Examples*	Frequency Band [MHz]	Coupling [dB]	I. Loss max. [dB]	Return Loss [dB]	Directivity [dB]
AMPS	CP0603A0836HN	824 - 849	17.3	0.30	26	26
	CP0603A0881HN	869 - 894	17.0	0.30	25	
GSM	CP0603A0902HN	890 - 915	16.7	0.30	25	
	CP0603A0947HN	935 - 960	16.3	0.35	25	
E-GSM	CP0603A0897HN	880 - 915	17.0	0.35	25	
	CP0603A0942HN	925 - 960	16.3	0.35	25	
PDC	CP0603A1441HN	1429 - 1453	13.0	0.55	22	
PCN	CP0603A1747HN	1710 - 1785	11.4	0.75	20	
	CP0603A1842HN	1805 - 1880	11.0	0.75	20	
PCS	CP0603A1880HN	1850 - 1910	10.8	0.75	19	
	CP0603A1960HN	1930 - 1990	10.5	0.75	19	
PHP	CP0603A1907HN	1895 - 1920	10.7	0.75	19	
DECT	CP0603A1890HN	1880 - 1900	10.8	0.75	19	
Wireless LAN	CP0603A2442HN	2400 - 2484	8.8	1.00	17	
WiFi	CP0603A3500HN	3450 - 3550	5.9	1.48	25	21
	CP0603A5000HN	4950 - 5050	4.4	2.59	22	18
	CP0603A5500HN	5450 - 5550	4	2.95	22	17
	CP0603A6000HN	5950 - 6050	3.5	3.37	21	17

CP0603AxxxxHNTR

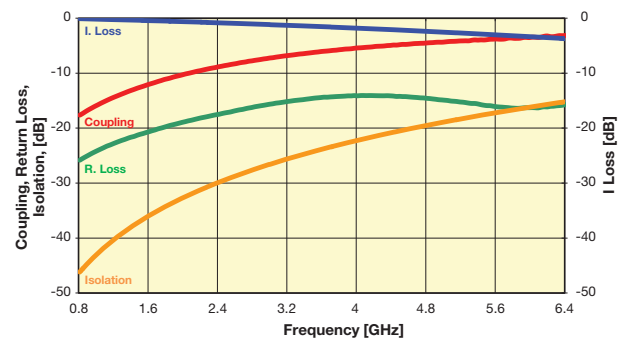

Coupler P/N CP603AxxxxMN

Application	P/N Examples*	Frequency Band [MHz]	Coupling [dB]	I. Loss max. [dB]	Return Loss [dB]	Directivity [dB]
AMPS	CP0603A0836MN	824 - 849	24.2	0.20	33	23
	CP0603A0881MN	869 - 894	23.8	0.20	32	
GSM	CP0603A0902MN	890 - 915	23.4	0.20	32	
	CP0603A0947MN	935 - 960	23.2	0.20	32	
E-GSM	CP0603A0897MN	880 - 915	23.4	0.20	32	
	CP0603A0942MN	925 - 960	23.2	0.20	32	
PDC	CP0603A1441MN	1429 - 1453	20.0	0.25	28	
PCN	CP0603A1747MN	1710 - 1785	18.4	0.25	27	
	CP0603A1842MN	1805 - 1880	18.0	0.25	26	
PCS	CP0603A1880MN	1850 - 1910	17.8	0.25	26	
	CP0603A1960MN	1930 - 1990	17.5	0.25	26	
PHP	CP0603A1907MN	1895 - 1920	17.7	0.25	26	
DECT	CP0603A1890MN	1880 - 1900	17.8	0.25	26	
Wireless LAN	CP0603A2442MN	2400 - 2484	15.6	0.35	24	
WiFi	CP0603A3500MN	3450 - 3550	12.8	0.58	18	20
	CP0603A5000MN	4950 - 5050	10.2	1.0	15	16
	CP0603A5500MN	5450 - 5550	9.7	1.2	15	14
	CP0603A6000MN	5950 - 6050	8.9	1.5	13.5	9

CP0603AxxxxMNTR

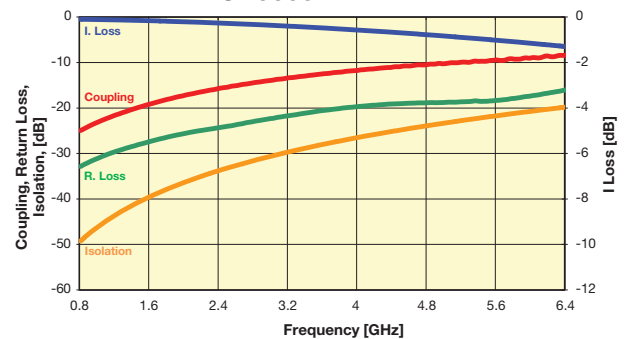

Important: Couplers can be used at any frequency within the indicated range.



Thin-Film Directional Couplers



CP0603 High Directivity LGA Type

Coupler P/N CP603AxxxxLN

Application	P/N Examples*	Frequency Band [MHz]	Coupling [dB]	I. Loss max. [dB]	Return Loss [dB]	Directivity [dB]
AMPS	CP0603A0836LN	824 - 849	26.89	0.08	32.5	18
	CP0603A0881LN	869 - 894	26.55	0.08	32.2	
GSM	CP0603A0902LN	890 - 915	26.2	0.09	31.9	
	CP0603A0947LN	935 - 960	25.87	0.09	31.5	
E-GSM	CP0603A0897LN	880 - 915	26.2	0.09	31.9	
	CP0603A0942LN	925 - 960	25.87	0.09	31.5	
PDC	CP0603A1441LN	1429 - 1453	22.31	0.12	28.1	17.5
PCN	CP0603A1747LN	1710 - 1785	20.51	0.15	26.4	
		CP0603A1842LN	1805 - 1880	20.03	0.15	26
PCS	CP0603A1880LN	1850 - 1910	19.87	0.16	26	
		CP0603A1960LN	1930 - 1990	19.57	0.17	25.5
PHP	CP0603A1907LN	1895 - 1920	19.77	0.16	25.7	
DECT	CP0603A1890LN	1880 - 1900	19.87	0.16	25.8	16
Wireless LAN	CP0603A2442LN	2400 - 2484	17.7	0.22	23.9	
WiFi	CP0603A3500LN	3450 - 3550	14.85	0.56	20.6	16
	CP0603A5000LN	4950 - 5050	12.4	0.95	17.8	11
	CP0603A5500LN	5450 - 5550	11.83	1.2	17.1	9
	CP0603A6000LN	5950 - 6050	11.08	1.33	15.9	

CP0603AxxxxLNTR

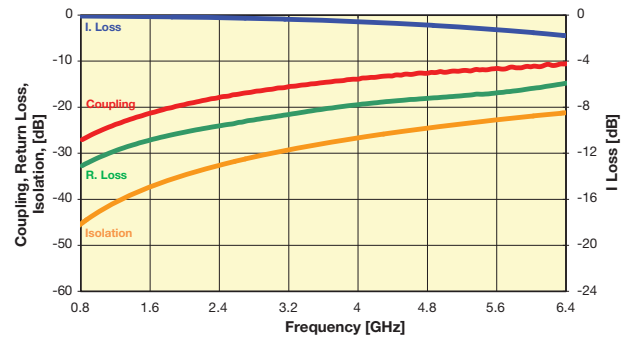

Coupler P/N CP603AxxxxKN

Application	P/N Examples*	Frequency Band [MHz]	Coupling [dB]	I. Loss max. [dB]	Return Loss [dB]	Directivity [dB]
AMPS	CP0603A0836KN	824 - 849	18.5	0.14	30	26
	CP0603A0881KN	869 - 894	18.1	0.14	29	
GSM	CP0603A0902KN	890 - 915	17.6	0.15	29	25
	CP0603A0947KN	935 - 960	17.3	0.15	29	
E-GSM	CP0603A0897KN	880 - 915	17.9	0.147	29	
	CP0603A0942KN	925 - 960	17.6	0.15	29	
PDC	CP0603A1441KN	1429 - 1453	14	0.27	25	24
PCN	CP0603A1747KN	1710 - 1785	12.4	0.36	23	
		CP0603A1842KN	1805 - 1880	12	0.39	
PCS	CP0603A1880KN	1850 - 1910	11.8	0.4	22	
	CP0603A1960KN	1930 - 1990	11.4	0.44	22	
PHP	CP0603A1907KN	1895 - 1920	11.5	0.43	22	23
DECT	CP0603A1890KN	1880 - 1900	11.7	0.41	22	
Wireless LAN	CP0603A2442KN	2400 - 2484	9.7	0.6	19	19
WiFi	CP0603A3500KN	3450 - 3550	7.2	1.15	15	
	CP0603A5000KN	4950 - 5050	4.7	2.15	15	
	CP0603A5500KN	5450 - 5550	4.2	2.5	17	
	CP0603A6000KN	5950 - 6050	3.7	2.8	19	

CP0603AxxxxKNTR

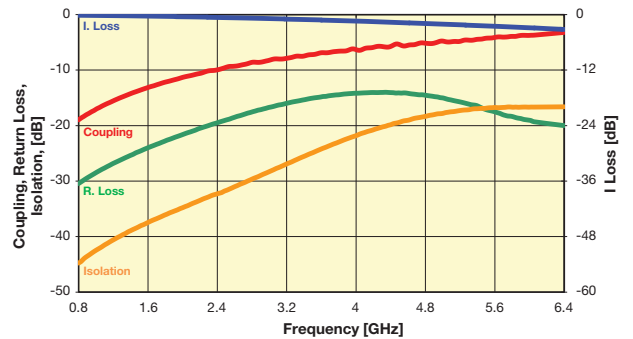

Important: Couplers can be used at any frequency within the indicated range.

Thin-Film Directional Couplers



CP0402 / CP0603 High Directivity Couplers Test Jigs

GENERAL DESCRIPTION

These jigs are designed for testing the CP0402 and CP0603 High Directivity Couplers using a Vector Network Analyzer.

They consist of a dielectric substrate, having 50Ω microstrips as conducting lines and a bottom ground plane located at a distance of 0.254mm (0.010") from the microstrips.

The substrate used is Neltec's NH9338ST0254C1BC.

The connectors are SMA type (female), 'Johnson Components Inc.' Product P/N: 142-0701-841.

Both a measurement jig and a calibration jig are provided.

The calibration jig is designed for a full 2-port calibration, and consists of an open line, short line and through line. LOAD calibration can be done by a 50Ω SMA termination.

MEASUREMENT PROCEDURE

When measuring a component, it can be either soldered or pressed using a non-metallic stick until all four ports touch the appropriate pads. Set the VNA to the relevant frequency band. Connect the VNA using a 10dB attenuator on the jig

terminal connected to port 2. Follow the VNA's instruction manual and use the [calibration jig](#) to perform a full 2-Port calibration in the required bandwidths.

Place the coupler on the [measurement jig](#) as follows:

Input (Coupler) → Connector 1 (Jig) Termination (Coupler) → Connector 3 (Jig)
Output (Coupler) → Connector 2 (Jig) Coupling (Coupler) → Connector 4 (Jig)

To measure I. Loss connect:

Connector 1 (Jig) → Port 1 (VNA) Connector 3 (Jig) → 50Ω
Connector 2 (Jig) → Port 2 (VNA) Connector 4 (Jig) → 50Ω

To measure R. Loss and Coupling connect:

Connector 1 (Jig) → Port 1 (VNA) Connector 3 (Jig) → 50Ω
Connector 2 (Jig) → 50Ω Connector 4 (Jig) → Port 2 (VNA)

To measure Isolation connect:

Connector 1 (Jig) → 50Ω Connector 3 (Jig) → 50Ω
Connector 2 (Jig) → Port 1 (VNA) Connector 4 (Jig) → Port 2 (VNA)

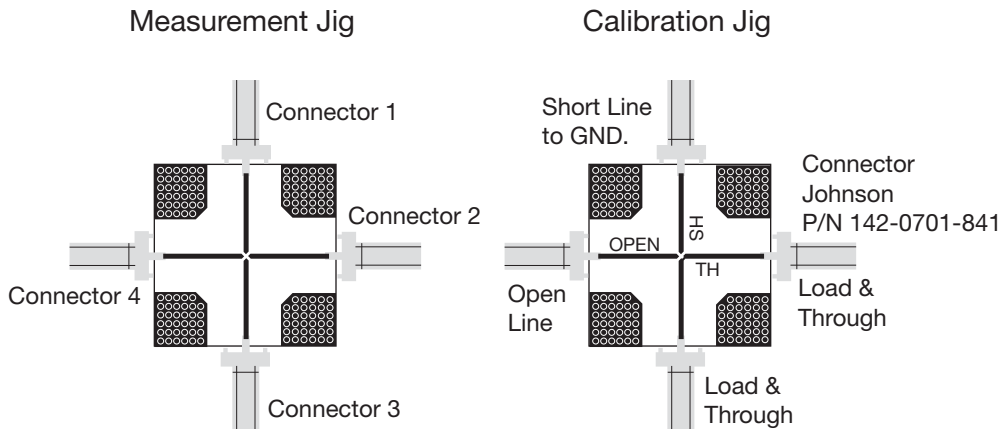

Thin-Film Directional Couplers



CP0603 SMD Type

GENERAL DESCRIPTION ITF (Integrated Thin-Film) TECHNOLOGY

The ITF SMD Coupler is based on thin-film multilayer technology. The technology provides a miniature part with excellent high frequency performance and rugged construction for reliable automatic assembly. The ITF Coupler is offered in a variety of frequency bands compatible with various types of high frequency wireless systems.

DIMENSIONS: millimeters (inches)

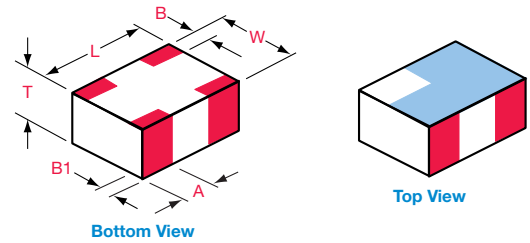

	0603
L	1.6±0.1 (0.063±0.004)
W	0.84±0.1 (0.033±0.004)
T	0.60±0.1 (0.028±0.004)
A	0.35±0.15 (0.014±0.006)
B	0.175±0.1 (0.007±0.004)
B1	0.00+0.1/0-0.0 (0.00+0.004/-0.0)

APPLICATIONS

- Mobile Communications
- Satellite TV Receivers
- GPS
- Vehicle Location Systems
- Wireless LAN's

FEATURES

- Miniature Size: 0603
- Frequency Range: 800MHz - 3GHz
- Characteristic Impedance: 50Ω
- Operating / Storage Temp.: -40°C to +85°C
- Power Rating: 3W Continuous
- Low Profile
- Rugged Construction
- Taped and Reeled

HOW TO ORDER

CP Style Directional Coupler	0603 Size 0603	X Type	**** Frequency MHz	X Sub Type	S Termination Code W = Sn90, Pb10 **S = Sn100	TR Packaging Code TR = Tape and Reel
--	--	-----------------------------	--	---------------------------------	--	--

****RoHS compliant**

QUALITY INSPECTION

Finished parts are 100% tested for electrical parameters and visual characteristics. Each production lot is evaluated on a sample basis for:

- Static Humidity: 85°C, 85% RH, 160 hours
- Endurance: 125°C, I_R, 4 hours

TERMINATION

Nickel/Solder coating compatible with automatic soldering technologies: reflow, wave soldering, vapor phase and manual.

Recommended Pad Layout Dimensions mm (inches)

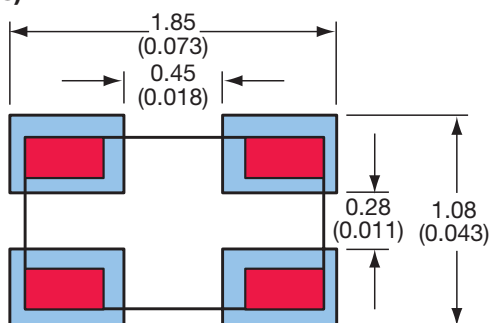

TERMINALS (Top View)

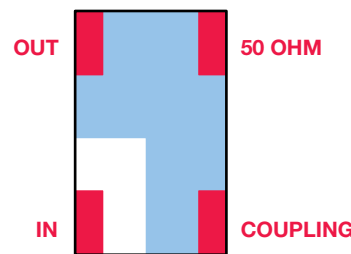

Not RoHS Compliant



For RoHS compliant products, please select correct termination style.

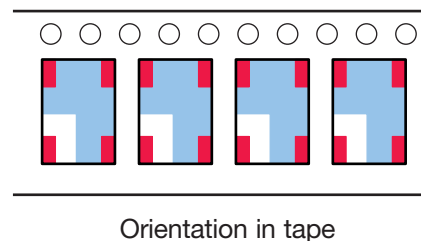

Thin-Film Directional Couplers



CP0603 SMD Type

Coupler P/N CP0603A****AS

Application	P/N Examples	Frequency Band [MHz]	Coupling [dB]	I. Loss max	VSWR max
AMPS	CP0603A0836AS	824 - 849	18.5±1	0.25	1.2
	CP0603A0881AS	869 - 894	18.5±1		
GSM	CP0603A0902AS	890 - 915	18±1	0.25	
	CP0603A0947AS	935 - 960	17.5±1		
E-GSM	CP0603A0897AS	880 - 915	18±1	0.25	
	CP0603A0942AS	925 - 960	17.5±1		
PDC	CP0603A1441AS	1429 - 1453	14±1	0.4	
PCN	CP0603A1747AS	1710 - 1785	12.5±1	0.6	
	CP0603A1842AS	1805 - 1880	12±1		
PCS	CP0603A1880AS	1850 - 1910	12±1	0.65	
	CP0603A1960AS	1930 - 1990	11.5±1		
PHP	CP0603A1907AS	1895 - 1920	12±1	0.6	
DECT	CP0603A1890AS	1880 - 1900	12±1	0.6	
Wireless LAN	CP0603A2442AS	2400 - 2484	10±1	0.85	

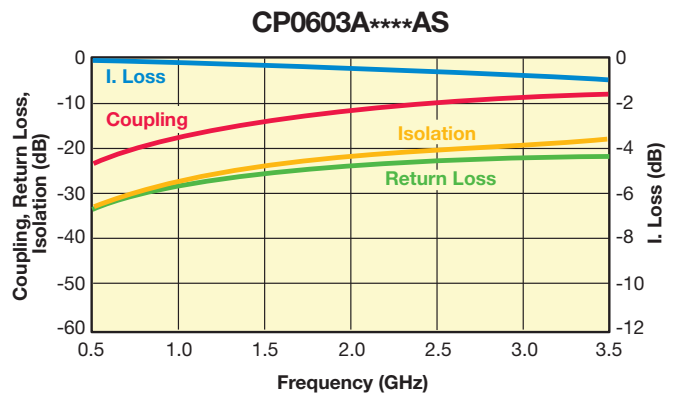

Coupler P/N CP0603A****BS

Application	P/N Examples	Frequency Band [MHz]	Coupling [dB]	I. Loss max	VSWR max
AMPS	CP0603A0836BS	824 - 849	16±1	0.25	1.2
	CP0603A0881BS	869 - 894	15.5±1		
GSM	CP0603A0902BS	890 - 915	15.5±1	0.25	
	CP0603A0947BS	935 - 960	15±1		
E-GSM	CP0603A0897BS	880 - 915	15.5±1	0.55	
	CP0603A0942BS	925 - 960	15±1		
PDC	CP0603A1441BS	1429 - 1453	11.5±1	0.55	
PCN	CP0603A1747BS	1710 - 1785	10±1	0.8	
	CP0603A1842BS	1805 - 1880	9.5±1		
PCS	CP0603A1880BS	1850 - 1910	9±1	0.8	
	CP0603A1960BS	1930 - 1990	9±1		
PHP	CP0603A1907BS	1895 - 1920	9±1	0.8	
DECT	CP0603A1890BS	1880 - 1900	9±1	0.8	
Wireless LAN	CP0603A2442BS	2400 - 2484	7.5±1	1.1	

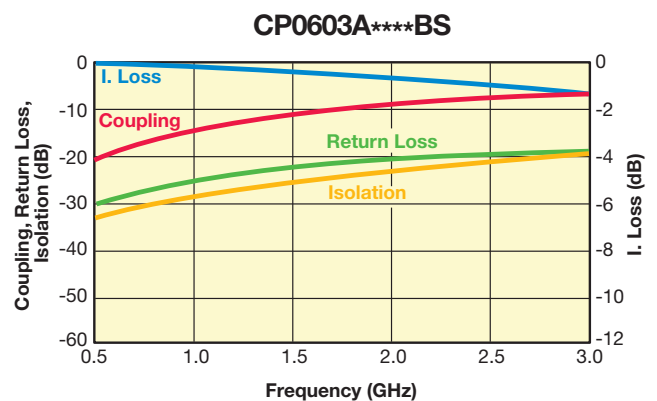

Coupler P/N CP0603A****CS

Application	P/N Examples	Frequency Band [MHz]	Coupling [dB]	I. Loss max	VSWR max
AMPS	CP0603A0836CS	824 - 849	21±1	0.25	1.2
	CP0603A0881CS	869 - 894	20.5±1		
GSM	CP0603A0902CS	890 - 915	20.5±1	0.25	
	CP0603A0947CS	935 - 960	20±1		
E-GSM	CP0603A0897CS	880 - 915	20.5±1	0.25	
	CP0603A0942CS	925 - 960	20±1		
PDC	CP0603A1441CS	1429 - 1453	16.5±1	0.40	
PCN	CP0603A1747CS	1710 - 1785	15±1	0.5	
	CP0603A1842CS	1805 - 1880	14.5±1		
PCS	CP0603A1880CS	1850 - 1910	14.5±1	0.5	
	CP0603A1960CS	1930 - 1990	14±1		
PHP	CP0603A1907CS	1895 - 1920	14.5±1	0.5	
DECT	CP0603A1890CS	1880 - 1900	14.5±1	0.5	
Wireless LAN	CP0603A2442CS	2400 - 2484	12.5±1	0.65	

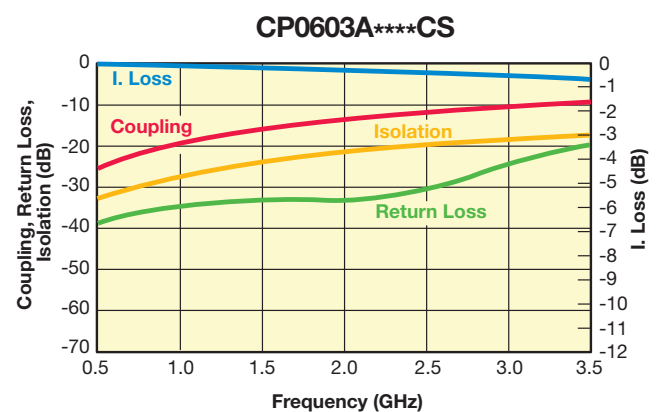

Coupler P/N CP0603A****DS

Application	P/N Examples	Frequency Band [MHz]	Coupling [dB]	I. Loss max	VSWR max
AMPS	CP0603A0836DS	824 - 849	15.0±1	0.40	1.2
	CP0603A0881DS	869 - 894	14.5±1		
GSM	CP0603A0902DS	890 - 915	14.5±1	0.40	
	CP0603A0947DS	935 - 960	14±1		
E-GSM	CP0603A0897DS	880 - 915	14.5±1	0.40	
	CP0603A0942DS	925 - 960	14±1		
PDC	CP0603A1441DS	1429 - 1453	10.5±1	0.7	
PCN	CP0603A1747DS	1710 - 1785	9±1	0.9	
	CP0603A1842DS	1805 - 1880	8.5±1		
PCS	CP0603A1880DS	1850 - 1910	8.5±1	1.0	
	CP0603A1960DS	1930 - 1990	8±1		
PHP	CP0603A1907DS	1895 - 1920	8.5±1	1.0	
DECT	CP0603A1890DS	1880 - 1900	8.5±1	1.0	
Wireless LAN	CP0603A2442DS	2400 - 2484	6.5±1	1.5	

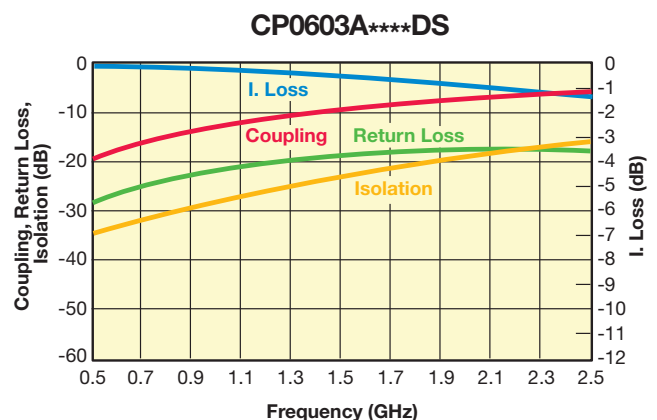

Important: Couplers can be used at any frequency within the indicated range.



Thin-Film Directional Couplers



CP0603 SMD Type

Coupler P/N CP0603B****AS

Application	P/N Examples	Frequency Band [MHz]	Coupling [dB]	I. Loss max	VSWR max	
AMPS	CP0603B0836AS	824 - 849	24.5±1	0.2	1.2	
	CP0603B0881AS	869 - 894	24±1			
GSM	CP0603B0902AS	890 - 915	24±1			
	CP0603B0947AS	935 - 960	23.5±1			
E-GSM	CP0603B0897AS	880 - 915	24±1			
	CP0603B0942AS	925 - 960	23.5±1			
PDC	CP0603B1441AS	1429 - 1453	20±1			0.25
PCN	CP0603B1747AS	1710 - 1785	18±1			
PCS	CP0603B1842AS	1805 - 1880	17.5±1			0.3
	CP0603B1880AS	1850 - 1910	17.5±1			
	CP0603B1960AS	1930 - 1990	17.5±1			
PHP	CP0603B1907AS	1895 - 1920	17.5±1			
DECT	CP0603B1890AS	1880 - 1900	17.5±1	0.45		
Wireless LAN	CP0603B2442AS	2400 - 2484	15.5±1			

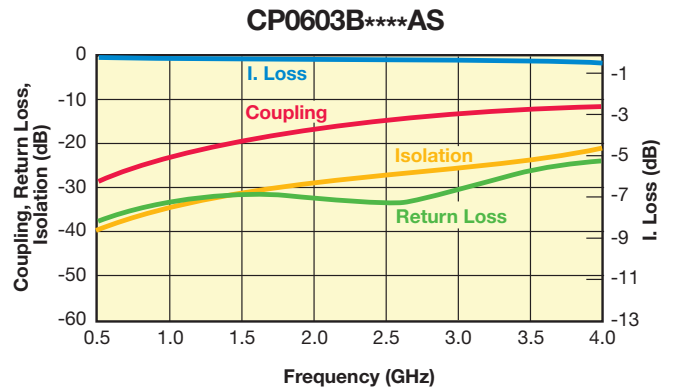

Coupler P/N CP0603B****BS

Application	P/N Examples	Frequency Band [MHz]	Coupling [dB]	I. Loss max	VSWR max	
AMPS	CP0603B0836BS	824 - 849	25.5±1	0.2	1.2	
	CP0603B0881BS	869 - 894	25±1			
GSM	CP0603B0902BS	890 - 915	25±1			
	CP0603B0947BS	935 - 960	24.5±1			
E-GSM	CP0603B0897BS	880 - 915	25±1			
	CP0603B0942BS	925 - 960	24.5±1			
PDC	CP0603B1441BS	1429 - 1453	21±1			0.25
PCN	CP0603B1747BS	1710 - 1785	19±1			
PCS	CP0603B1842BS	1805 - 1880	19±1			0.25
	CP0603B1880BS	1850 - 1910	18.5±1			
	CP0603B1960BS	1930 - 1990	18.5±1			
PHP	CP0603B1907BS	1895 - 1920	18.5±1			
DECT	CP0603B1890BS	1880 - 1900	18.5±1	0.35		
Wireless LAN	CP0603B2442BS	2400 - 2484	16.5±1			

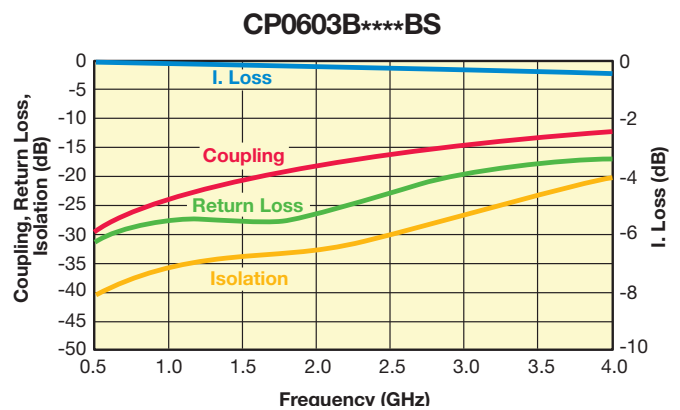

Coupler P/N CP0603B****CS

Application	P/N Examples	Frequency Band [MHz]	Coupling [dB]	I. Loss max	VSWR max	
AMPS	CP0603B0836CS	824 - 849	26.5±1	0.2	1.2	
	CP0603B0881CS	869 - 894	26±1			
GSM	CP0603B0902CS	890 - 915	26±1			
	CP0603B0947CS	935 - 960	25.5±1			
E-GSM	CP0603B0897CS	880 - 915	26±1			
	CP0603B0942CS	925 - 960	25.5±1			
PDC	CP0603B1441CS	1429 - 1453	22±1			0.25
PCN	CP0603B1747CS	1710 - 1785	20.5±1			
PCS	CP0603B1842CS	1805 - 1880	20±1			0.25
	CP0603B1880CS	1850 - 1910	20±1			
	CP0603B1960CS	1930 - 1990	19.5±1			
PHP	CP0603B1907CS	1895 - 1920	20±1			
DECT	CP0603B1890CS	1880 - 1900	20±1	0.35		
Wireless LAN	CP0603B2442CS	2400 - 2484	18±1			

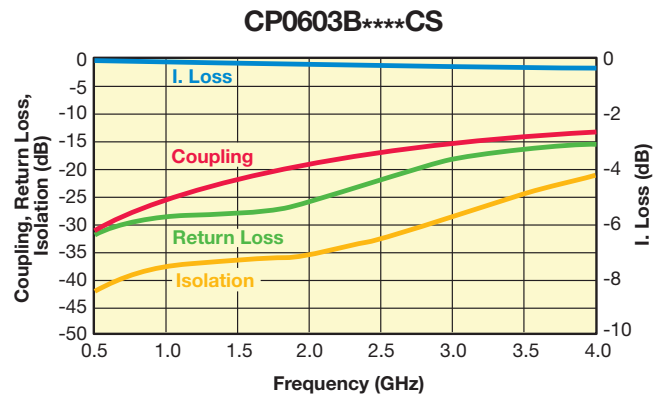

Important: Couplers can be used at any frequency within the indicated range.

Thin-Film Directional Couplers



CP0603 SMD Type – High Directivity

Coupler P/N CP0603D****AS

Application	P/N Examples	Frequency Band [MHz]	Coupling [dB]	I. Loss max. [dB]	Return Loss [dB]	Directivity [dB]
AMPS	CP0603D0836AS	824 - 849	13.50	0.50	23	21
	CP0603D0881AS	869 - 894	13.00			
GSM	CP0603D0902AS	890 - 915	12.50	13.00	22	21
	CP0603D0947AS	935 - 960				
E-GSM	CP0603D0897AS	880 - 915	12.50	1.00	18	19
	CP0603D0942AS	925 - 960				
PDC	CP0603D1441AS	1429 - 1453	9.00	8.00	17	18
PCN	CP0603D1747AS	1710 - 1785	7.50	1.40	16	17
	CP0603D1842AS	1805 - 1880				
PCS	CP0603D1880AS	1850 - 1910	7.00	2.00	15	15
	CP0603D1960AS	1930 - 1990				
PHP	CP0603D1907AS	1895 - 1920				
DECT	CP0603D1890AS	1880 - 1900				
Wireless LAN	CP0603D2442AS	2400 - 2484				

CP0603D****AS

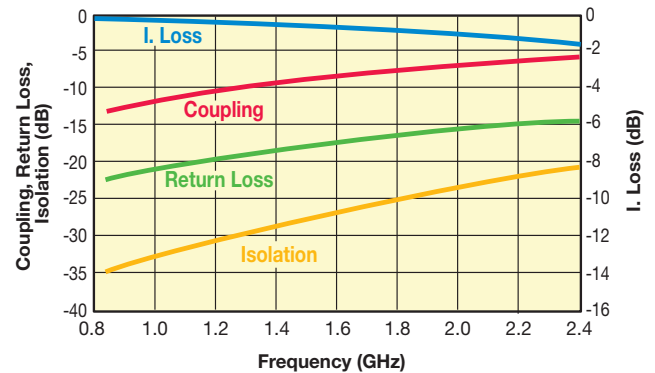

Coupler P/N CP0603D****BS

Application	P/N Examples	Frequency Band [MHz]	Coupling [dB]	I. Loss max. [dB]	Return Loss [dB]	Directivity [dB]
AMPS	CP0603D0836BS	824 - 849	20.00	0.25	36	19
	CP0603D0881BS	869 - 894	19.50			
GSM	CP0603D0902BS	890 - 915	19.00	0.40	35	19
	CP0603D0947BS	935 - 960				
E-GSM	CP0603D0897BS	880 - 915	19.00	0.50	36	19
	CP0603D0942BS	925 - 960				
PDC	CP0603D1441BS	1429 - 1453	15.50	28	27	28
PCN	CP0603D1747BS	1710 - 1785	14.00	0.55	27	27
	CP0603D1842BS	1805 - 1880				
PCS	CP0603D1880BS	1850 - 1910	13.00	0.70	24	24
	CP0603D1960BS	1930 - 1990				
PHP	CP0603D1907BS	1895 - 1920				
DECT	CP0603D1890BS	1880 - 1900				
Wireless LAN	CP0603D2442BS	2400 - 2484				

CP0603D****BS

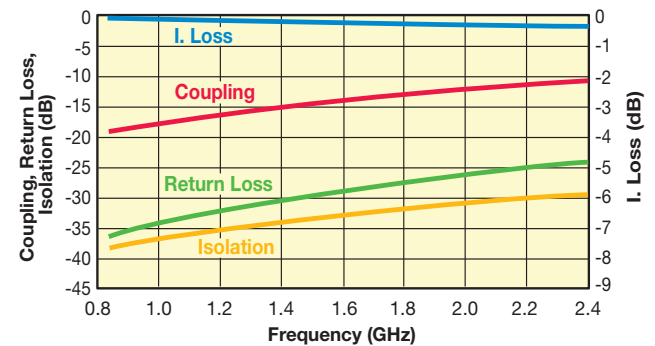

Important: Couplers can be used at any frequency within the indicated range.



Thin-Film Directional Couplers



CP0805 SMD Type

GENERAL DESCRIPTION ITF (Integrated Thin-Film) TECHNOLOGY

The ITF SMD Coupler is based on thin-film multilayer technology. The technology provides a miniature part with excellent high frequency performance and rugged construction for reliable automatic assembly.

The ITF Coupler is offered in a variety of frequency bands compatible with various types of high frequency wireless systems.

FEATURES

- Small Size: 0805
- Frequency Range: 800MHz - 3GHz
- Characteristic Impedance: 50Ω
- Operating / Storage Temp.: -40°C to +85°C
- Power Rating: 3W Continuous
- Low Profile
- Rugged Construction
- Taped and Reeled

APPLICATIONS

- Mobile Communications
- Satellite TV Receivers
- GPS
- Vehicle Location Systems
- Wireless LAN's

DIMENSIONS: (Top View)



	0805
L	2.03±0.1 (0.080±0.004)
W	1.55±0.1 (0.061±0.004)
T	0.98±0.1 (0.039±0.004)
A	0.56±0.25 (0.022±0.010)
B	0.35±0.15 (0.014±0.006)

HOW TO ORDER

CP T	0805 T	A T	0902 T	A T	S T	TR T
Style Directional Coupler	Size 0805	Layout Type (see layout types)	Frequency MHz	Sub Type (see layout sub-types)	Termination Code W = Nickel/Solder (Sn/Pb) **S = Nickel / Lead Free Solder (Sn100)	Packaging Code TR = Tape and Reel

Not RoHS Compliant



For RoHS compliant products, please select correct termination style.

****RoHS compliant**

QUALITY INSPECTION

Finished parts are 100% tested for electrical parameters and visual characteristics. Each production lot is evaluated on a sample basis for:

- Static Humidity: 85°C, 85% RH, 160 hours
- Endurance: 125°C, I_R, 4 hours

TERMINATION

Nickel/Solder coating (Sn, Pb) compatible with automatic soldering technologies: reflow, wave soldering, vapor phase and manual.

Recommended Pad Layout Dimensions mm (inches)

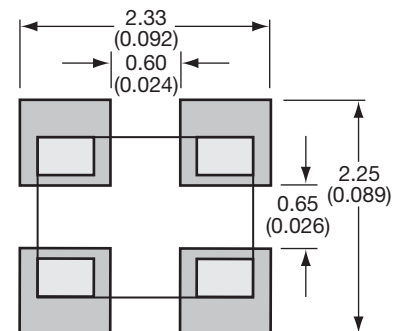

NOTE: Components must be mounted on the board with the white (Alumina) side DOWN.

Thin-Film Directional Couplers



CP0805 Layout Types

LAYOUT



Sn100 LAYOUT



Type: A
Sub-Type: A



LAYOUT



Sn100 LAYOUT



Type: A
Sub-Type: B



Application	P/N Examples	Frequency Band [MHz]	Coupling [dB]	I. Loss max	VSWR max
AMPS	CP0805A0836AW	824 - 849	16.5±1	0.25	1.2
	CP0805A0881AW	869 - 894	16±1		
GSM	CP0805A0902AW	890 - 915	16±1		
	CP0805A0947AW	935 - 960	15.5±1		
E-GSM	CP0805A0897AW	880 - 915	16±1		
	CP0805A0942AW	925 - 960	15.5±1		
PDC	CP0805A1441AW	1429 - 1453	12±1	0.5	1.3
PCN	CP0805A1747AW	1710 - 1785	10.5±1	0.8	1.4
	CP0805A1842AW	1805 - 1880	10±1		
PCS	CP0805A1880AW	1850 - 1910	9.5±1	0.7	1.4
	CP0805A1960AW	1930 - 1990	9.5±1		
PHP	CP0805A1907AW	1895 - 1920	9.5±1	0.6	
DECT	CP0805A1890AW	1880 - 1900	9.5±1	0.6	

Application	P/N Examples	Frequency Band [MHz]	Coupling [dB]	I. Loss max	VSWR max
AMPS	CP0805A0836BW	824 - 849	19±1	0.25	1.2
	CP0805A0881BW	869 - 894	18.5±1		
GSM	CP0805A0902BW	890 - 915	18±1		
	CP0805A0947BW	935 - 960	18±1		
E-GSM	CP0805A0897BW	880 - 915	18.5±1		
	CP0805A0942BW	925 - 960	18±1		
PDC	CP0805A1441BW	1429 - 1453	14.5±1	0.35	
PCN	CP0805A1747BW	1710 - 1785	12.5±1	0.5	1.4
	CP0805A1842BW	1805 - 1880	12.5±1		
PCS	CP0805A1880BW	1850 - 1910	12±1	0.6	1.4
	CP0805A1960BW	1930 - 1990	11.5±1		
PHP	CP0805A1907BW	1895 - 1920	12±1	0.6	
DECT	CP0805A1890BW	1880 - 1900	12±1	0.6	
Wireless LAN	CP0805A2442BW	2400 - 2484	10±1	0.9	

LAYOUT



Sn100 LAYOUT



Type: A
Sub-Type: C



Application	P/N Examples	Frequency Band [MHz]	Coupling [dB]	I. Loss max	VSWR max
AMPS	CP0805A0836CW	824 - 849	14±1	0.5	1.4
	CP0805A0881CW	869 - 894	13.5±1		
GSM	CP0805A0902CW	890 - 915	13.5±1		
	CP0805A0947CW	935 - 960	13±1		
E-GSM	CP0805A0897CW	880 - 915	13.5±1		
	CP0805A0942CW	925 - 960	13±1		
PDC	CP0805A1441CW	1429 - 1453	9.5±1	1.15	1.8
PCN	CP0805A1747CW	1710 - 1785	8±1	1.6	2.2
	CP0805A1842CW	1805 - 1880	8±1		
PCS	CP0805A1880CW	1850 - 1910	7.5±1	1.75	2.2
	CP0805A1960CW	1930 - 1990	7.5±1		
PHP	CP0805A1907CW	1895 - 1920	7.5±1	2.5	
DECT	CP0805A1890CW	1880 - 1900	7.5±1	2.5	
Wireless LAN	CP0805A2442CW	2400 - 2484	6±1	2.5	

Important: Couplers can be used at any frequency within the indicated range.



Thin-Film Directional Couplers



CP0805 Layout Types

LAYOUT



Sn100 LAYOUT

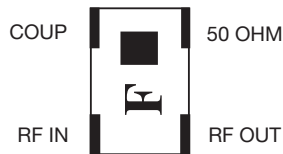

Type: A
Sub-Type: D



Application	P/N Examples	Frequency Band [MHz]	Coupling [dB]	I. Loss max	VSWR max
AMPS	CP0805A0836DW	824 - 849	13.0±1	0.5	1.4
	CP0805A0881DW	869 - 894	12.5±1		
GSM	CP0805A0902DW	890 - 915	12.5±1	0.5	1.4
	CP0805A0947DW	935 - 960	12±1		
E-GSM	CP0805A0897DW	880 - 915	12.5±1	0.5	1.4
	CP0805A0942DW	925 - 960	12±1		
PDC	CP0805A1441DW	1429 - 1453	8.5±1	1.25	1.8
PCN	CP0805A1747DW	1710 - 1785	7±1	1.85	2.1
	CP0805A1842DW	1805 - 1880	7±1		
PCS	CP0805A1880DW	1850 - 1910	7±1	2.15	2.1
	Cp0805A1960DW	1930 - 1990	6.5±1		
PHP	CP0805A1907DW	1895 - 1920	6.5±1	1.85	1.8
DECT	CP0805A1890DW	1880 - 1900	7±1	1.85	1.8
Wireless LAN	CP0805A2442DW	2400 - 2484	5.5±1	2.4	2.1

LAYOUT



Sn100 LAYOUT



Type: A
Sub-Type: E



Application	P/N Examples	Frequency Band [MHz]	Coupling [dB]	I. Loss max	VSWR max
AMPS	CP0805A0836EW	824 - 849	11±1	0.85	1.4
	CP0805A0881EW	869 - 894	10.5±1		
GSM	CP0805A0902EW	890 - 915	10.5±1	0.85	1.4
	CP0805A0947EW	935 - 960	10±1		
E-GSM	CP0805A0897EW	880 - 915	10.5±1	0.85	1.4
	CP0805A0942EW	925 - 960	10±1		
PDC	CP0805A1441EW	1429 - 1453	7±1	1.8	1.8
PCN	CP0805A1747EW	1710 - 1785	5.5±1	2.7	2.2
	CP0805A1842EW	1805 - 1880	5.5±1		
PCS	CP0805A1880EW	1850 - 1910	5±1	3.15	2.4
	Cp0805A1960EW	1930 - 1990	5±1		
PHP	CP0805A1907EW	1895 - 1920	5±1	3.15	2.4
DECT	CP0805A1890EW	1880 - 1900	5±1	3.15	2.4
Wireless LAN	CP0805A2442EW	2400 - 2484	4±1	4.2	2.4

Type: B
Sub-Type: A



LAYOUT

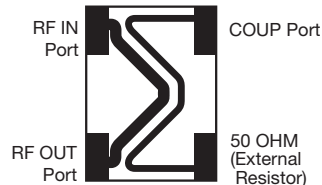

Sn100 LAYOUT

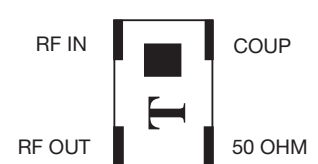

Application	P/N Examples	Frequency Band [MHz]	Coupling [dB]	I. Loss max	VSWR max
AMPS	CP0805B0836AW	824 - 849	21.5±1	0.25	1.2
	CP0805B0881AW	869 - 894	21±1		
GSM	CP0805B0902AW	890 - 915	21±1	0.25	1.2
	CP0805B0947AW	935 - 960	20.5±1		
E-GSM	CP0805B0897AW	880 - 915	21±1	0.25	1.2
	CP0805B0942AW	925 - 960	20.5±1		
PDC	CP0805B1441AW	1429 - 1453	17±1	0.3	1.2
PCN	CP0805B1747AW	1710 - 1785	15.5±1	0.3	1.2
	Cp0805B1842AW	1805 - 1880	15.5±1		
PCS	CP0805B1880AW	1850 - 1910	15±1	0.3	1.2
	CP0805B1960AW	1930 - 1990	14.5±1		
PHP	CP0805B1907AW	1895 - 1920	15±1	0.3	1.2
DECT	CP0805B1890AW	1880 - 1900	15±1	0.3	1.2
Wireless LAN	CP0805B2442AW	2400 - 2484	13±1	0.4	1.2

Important: Couplers can be used at any frequency within the indicated range.



Thin-Film Directional Couplers



CP0805 Layout Types

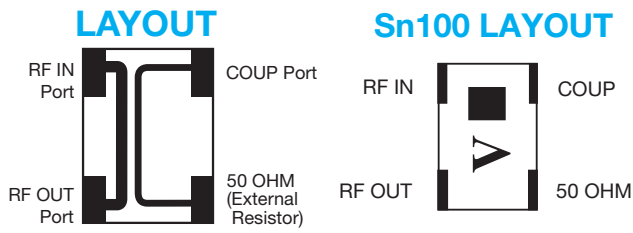

Type: B
Sub-Type: B

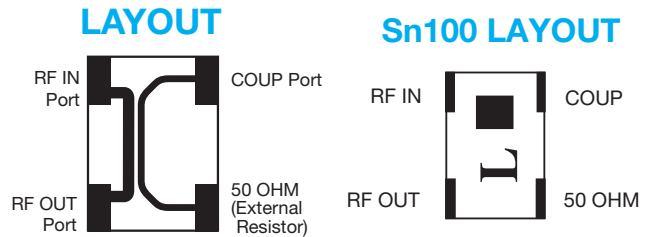

Type: B
Sub-Type: C



Application	P/N Examples	Frequency Band [MHz]	Coupling [dB]	I. Loss max	VSWR max
AMPS	CP0805B0836BW	824 - 849	23.5±1	0.25	1.2
	CP0805B0881BW	869 - 894	23±1		
GSM	CP0805B0902BW	890 - 915	22.5±1		
	CP0805B0947BW	935 - 960	22±1		
E-GSM	CP0805B0897BW	880 - 915	23±1		
	CP0805B0942BW	925 - 960	22±1		
PDC	CP0805B1441BW	1429 - 1453	18.5±1		
PCN	CP0805B1747BW	1710 - 1785	17±1		
	CP0805B1842BW	1805 - 1880	16.5±1		
PCS	CP0805B1880BW	1850 - 1910	16.5±1		
	CP0805B1960BW	1930 - 1990	16±1		
PHP	CP0805B1907BW	1895 - 1920	16±1		
DECT	CP0805B1890BW	1880 - 1900	16±1		
Wireless LAN	CP0805B2442BW	2400 - 2484	14±1	0.4	

Application	P/N Examples	Frequency Band [MHz]	Coupling [dB]	I. Loss max	VSWR max
AMPS	CP0805B0836CW	824 - 849	25±1	0.25	1.2
	CP0805B0881CW	869 - 894	24.5±1		
GSM	CP0805B0902CW	890 - 915	24±1		
	CP0805B0947CW	935 - 960	24±1		
E-GSM	CP0805B0897CW	880 - 915	24.5±1		
	CP0805B0942CW	925 - 960	24±1		
PDC	CP0805B1441CW	1429 - 1453	20±1		
PCN	CP0805B1747CW	1710 - 1785	18.5±1		
	CP0805B1842CW	1805 - 1880	18.5±1		
PCS	CP0805B1880CW	1850 - 1910	18±1		
	CP0805B1960CW	1930 - 1990	17.5±1		
PHP	CP0805B1907CW	1895 - 1920	18±1		
DECT	CP0805B1890CW	1880 - 1900	18±1		
Wireless LAN	CP0805B2442CW	2400 - 2484	16±1	0.4	

Important: Couplers can be used at any frequency within the indicated range.



Thin-Film Directional Couplers



CP0805 Layout Types

VHF DIRECTIONAL COUPLER

CP0805L0155ASTR

Sn100 LAYOUT



P/N	Frequency [MHz]	Coupling [dB]	R. Loss [dB]	I. Loss max [dB]	Directivity [dB]
CP0805L0155ASTR	155	17.1±1	24	0.35	22



UHF DIRECTIONAL COUPLER

CP0805L0436BSTR

Sn100 LAYOUT



P/N	Frequency [MHz]	Coupling [dB]	R. Loss [dB]	I. Loss max [dB]	Directivity [dB]
CP0805L0436BSTR	403-470	15.85±1	35	0.25	22



3

Important: Couplers can be used at any frequency within the indicated range.



Thin-Film Directional Couplers



CP0805 and CP0603 Test Jig

ITF TEST JIG FOR COUPLER TYPES 0805 AND 0603 SMD

GENERAL DESCRIPTION

This jig is designed for the testing of CP0805 and CP0603 series Directional Couplers using a vector network analyzer. It consists of a FR4 multi-layer substrate, having 50Ω microstrips as conducting lines and a ground plane in the middle layer, located at a distance of 0.2mm from the microstrips.

The connectors are SMA type (female), 'Johnson Components Inc.' Product P/N: 142-0701-881.

The jig is designed for a full 2-port calibration. LOAD calibration can be done either by a 50Ω SMA termination, or by soldering a 50Ω chip resistor at the 50Ω ports.

MEASUREMENT PROCEDURE

When measuring a component, it can be either soldered or pressed by a non-metallic stick until all four ports touch the appropriate pads. To measure the coupling (and the R. Loss) place the component on the Port 1 & Port 2 pads. Use two SMA 50Ω terminations (male) to terminate the ports, which are not connected to the network analyzer, and connect the network analyzer to the two ports. A 90° rotation of the component on its pads allows measuring a second parameter (I. Loss).

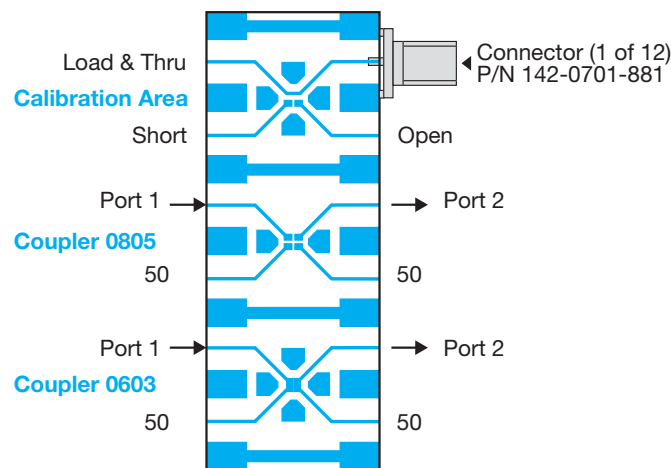

CP0805 SERIES DIRECTIONAL COUPLERS

Orientation and Tape and Reel Packaging Specification (Top View)

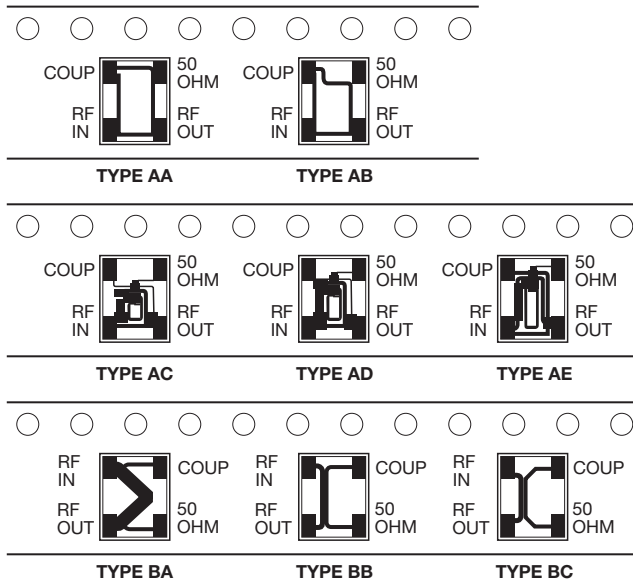

The parts should be mounted on the PCB with White (Alumina) side down and the "dark" side up.

CP0805xxxxxxSTR (Sn100) (Top View)

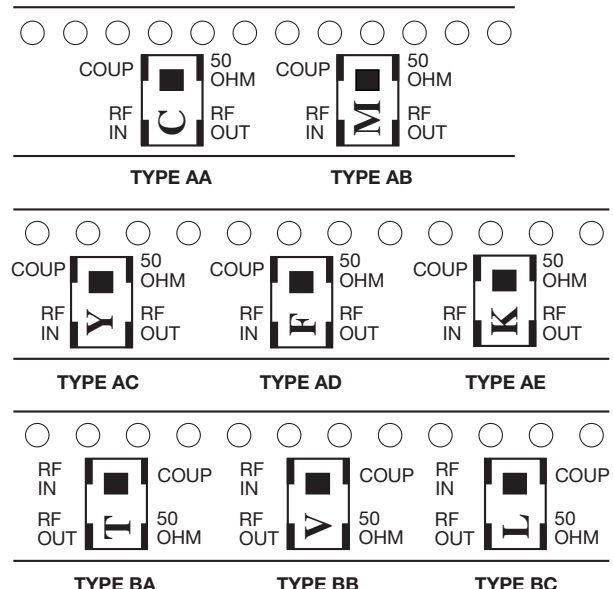

The parts should be mounted on the PCB with printed side up.



Thin-Film Directional Couplers

DB0603N 3dB 90° Couplers



GENERAL DESCRIPTION RFAP TECHNOLOGY

The DB0603N 3dB 90° Coupler is based on thin-film multilayer technology. The technology provides a miniature part with excellent high frequency performance and rugged construction for reliable automatic assembly. The RFAP LGA 3dB 90° Coupler will be offered in a variety of frequency bands compatible with various types of high frequency wireless systems.



APPLICATIONS

- Balanced Amplifiers and Signal Distribution in Wireless Communications

FEATURES

- Miniature 0603 size
- Low I. Loss
- High Isolation
- Surface Mountable
- RoHS Compliant
- Supplied on T&R
- Power Rating:
10W RF
Continuous

LAND GRID ARRAY ADVANTAGES:

- Inherent Low Profile
- Self Alignment during Reflow
- Excellent Solderability
- Low Parasitics
- Better Heat Dissipation

DIMENSIONS:

millimeters (inches)

L	1.60±0.10 (0.063±0.004)
W	0.84±0.10 (0.033±0.004)
T	0.60±0.10 (0.024±0.004)
A	0.25±0.05 (0.010±0.002)
B	0.20±0.05 (0.008±0.002)
S	0.05±0.05 (0.002±0.002)

Bottom View

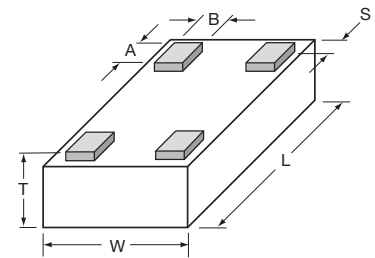

Recommended Pad Layout Dimensions mm (inches)

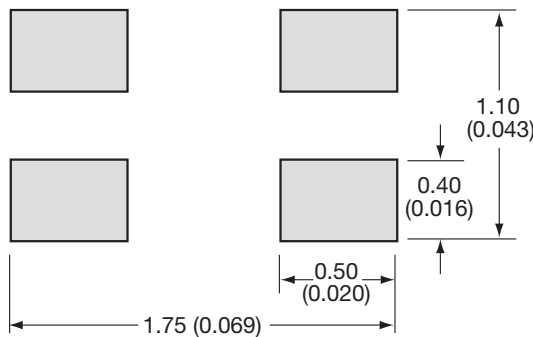

ORIENTATION IN TAPE

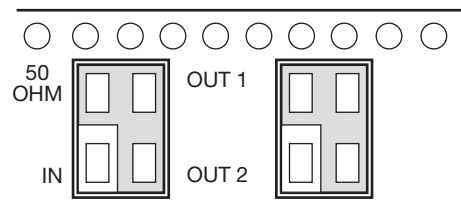

ELECTRICAL PARAMETERS

Part Number	Frequency MHz		Port Impedance Ω	Return Loss [dB]		Isolation [dB]		Insertion Loss [dB]		Amplitude Balance [dB]		Phase Balance (Relative to 90°) Deg		Power Handling Watts
	Min.	Max.		Typ.	Min.	Typ.	Min.	Typ.	Typ.	Max.	Typ.	Max.	Typ.	
DB0603N2140ANTR	2040	2240	50	15	26	15	23	0.30	0.40	0.50	0.80	2	3	10
DB0603N2400ANTR	2300	2500	50	12	17	15	23	0.25	0.35	0.30	0.80	2	3	10
DB0603N2600ANTR	2400	2800	50	12	17	15	23	0.25	0.35	0.30	0.80	2	3	10
DB0603N3000ANTR	2850	3150	50	12	15	15	26	0.20	0.30	0.30	0.80	2	3	10
DB0603N3500ANTR	3300	3700	50	12	15	15	26	0.20	0.30	0.30	0.80	2	3	10
DB0603N4600ANTR	4200	5000	50	12	16	12	15	0.50	0.70	0.40	1.00	1.5	3	10
DB0603N5500ANTR	5100	5900	50	12	16	10	14	0.60	0.80	0.80	1.50	1	3	10
DB0603N5800ANTR	5600	6000	50	12	16	12	17	0.40	0.90	0.30	0.90	2	3	10

NOTE: Additional Frequencies Available Upon Request

Thin-Film Directional Couplers

DB0603N 3dB 90° Couplers



2040MHz to 2240MHz DB0603N2140ANTR

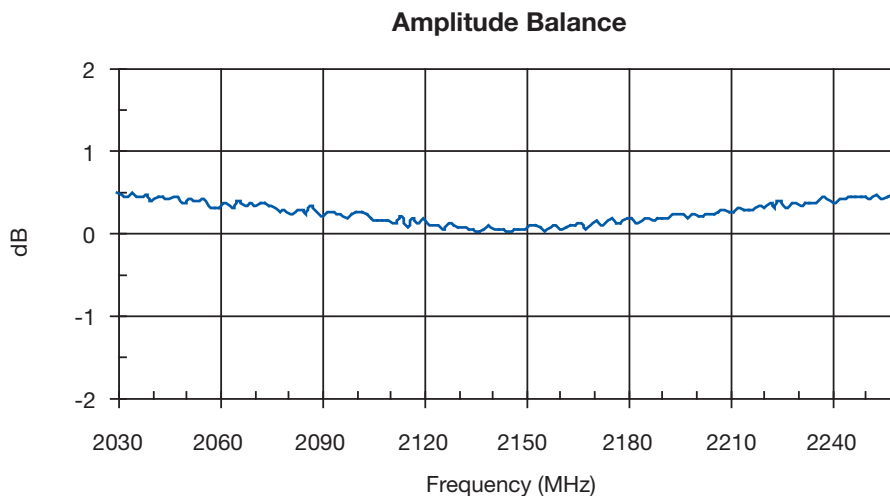
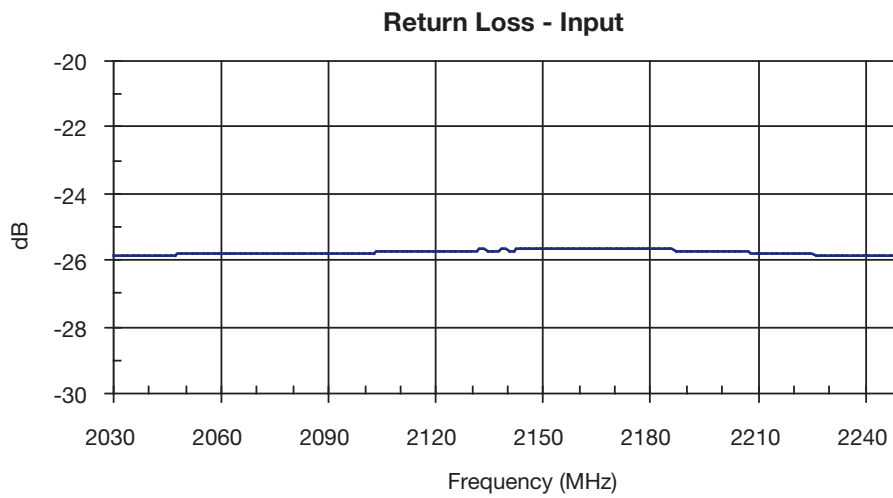

3

Thin-Film Directional Couplers

DB0603N 3dB 90° Couplers



2040MHz to 2240MHz DB0603N2140ANTR

Phase Balance

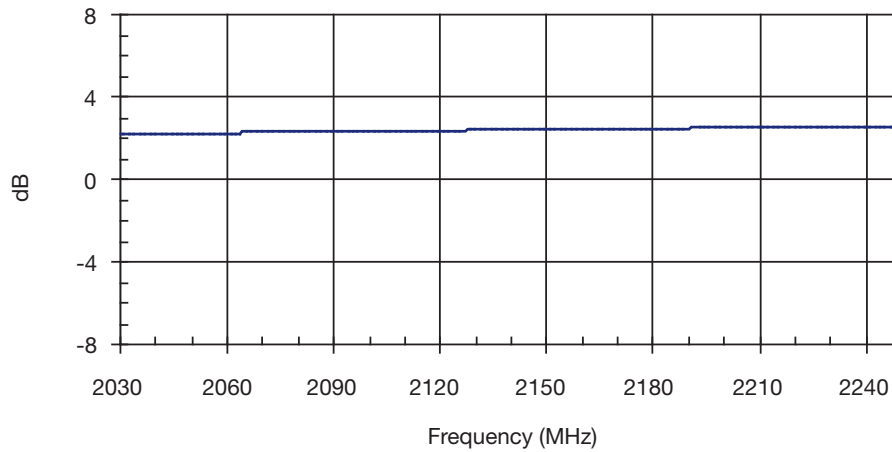

Isolation

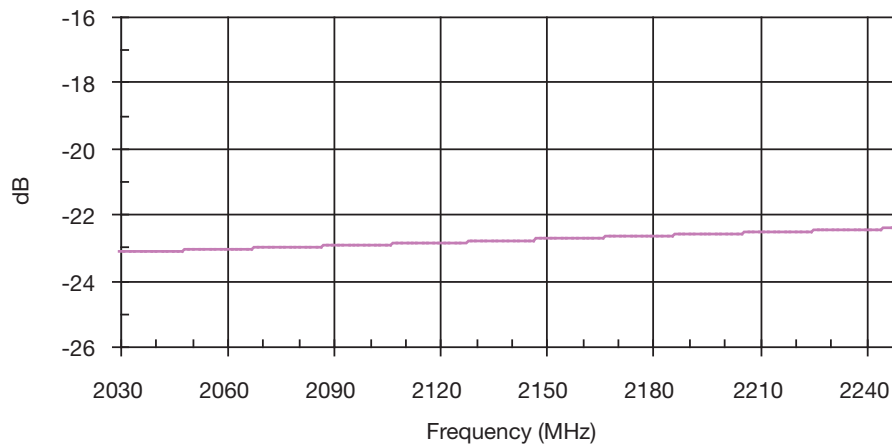

3



Thin-Film Directional Couplers

DB0603N 3dB 90° Couplers



2200MHz to 2600MHz DB0603N2400ANTR

Return Loss - Input

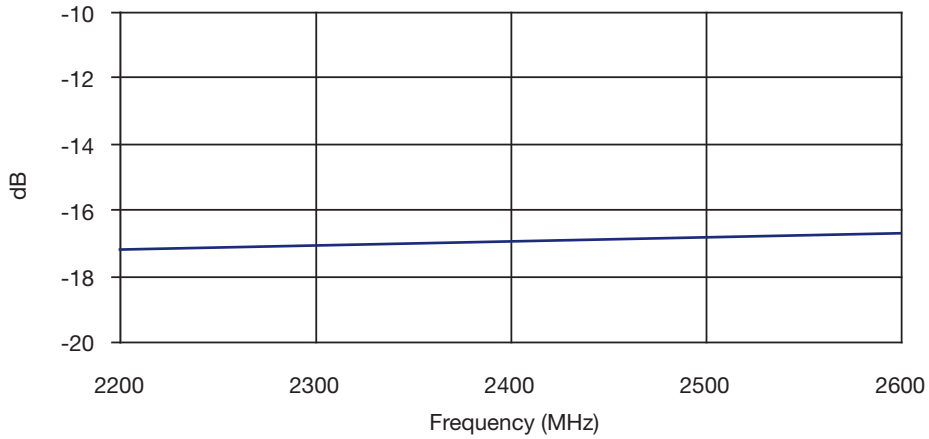

Insertion Loss

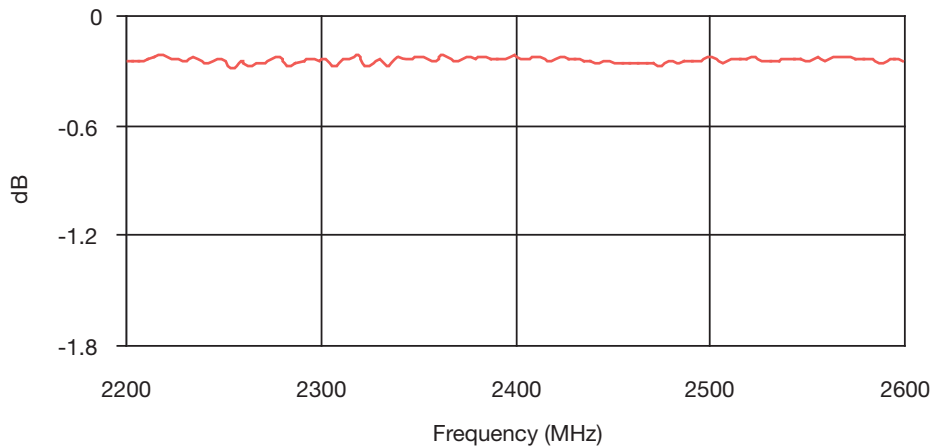

Amplitude Balance

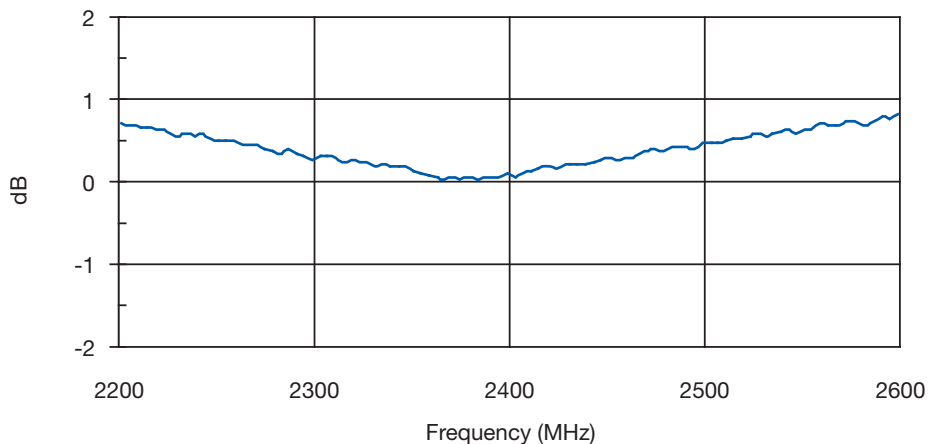

3

Thin-Film Directional Couplers

DB0603N 3dB 90° Couplers



2200MHz to 2600MHz DB0603N2400ANTR

Phase Balance

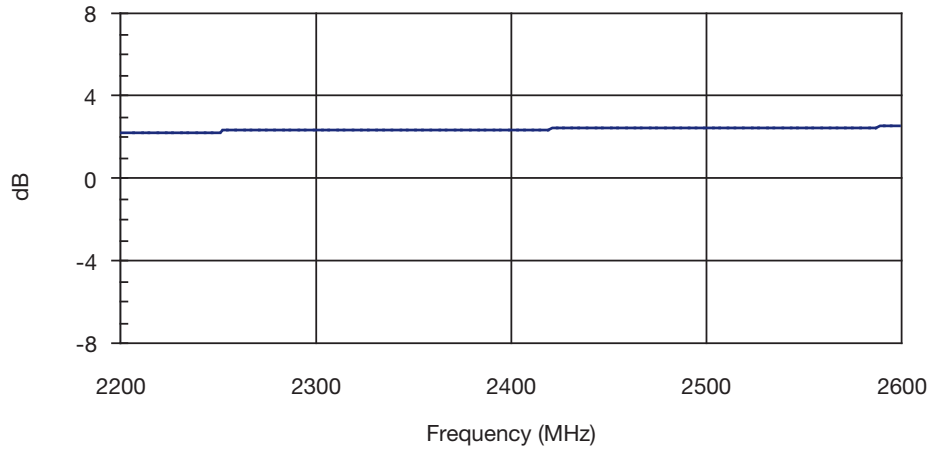

Isolation

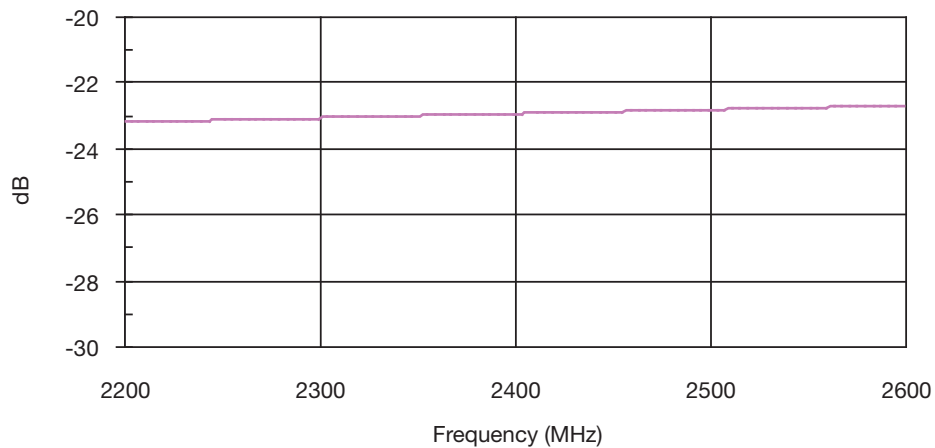

3



Thin-Film Directional Couplers

DB0603N 3dB 90° Couplers



2400MHz TO 2800MHz DB0603N2600ANTR

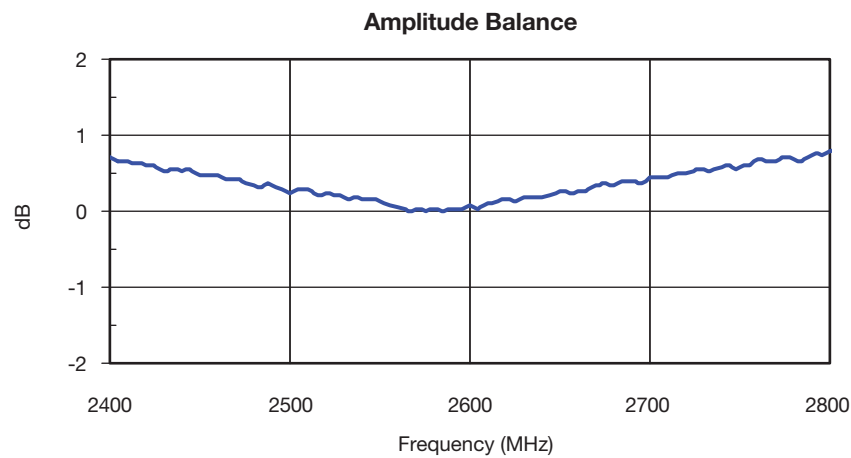
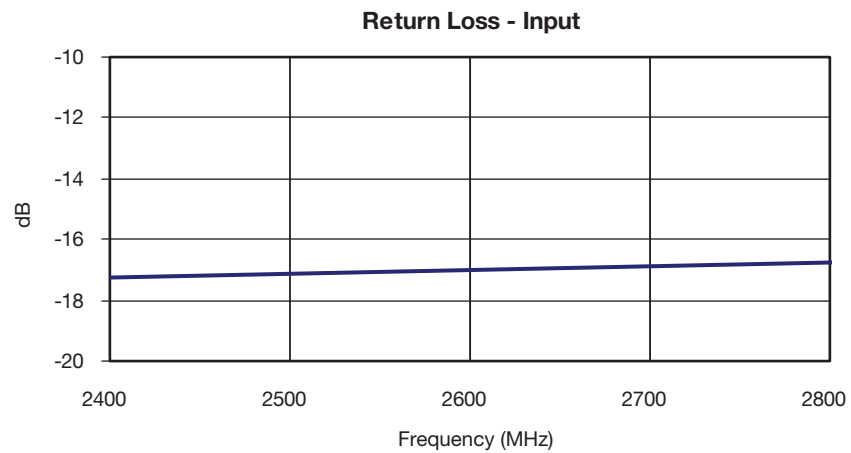

3

Thin-Film Directional Couplers

DB0603N 3dB 90° Couplers



2400MHz TO 2800MHz DB0603N2600ANTR

Phase Balance

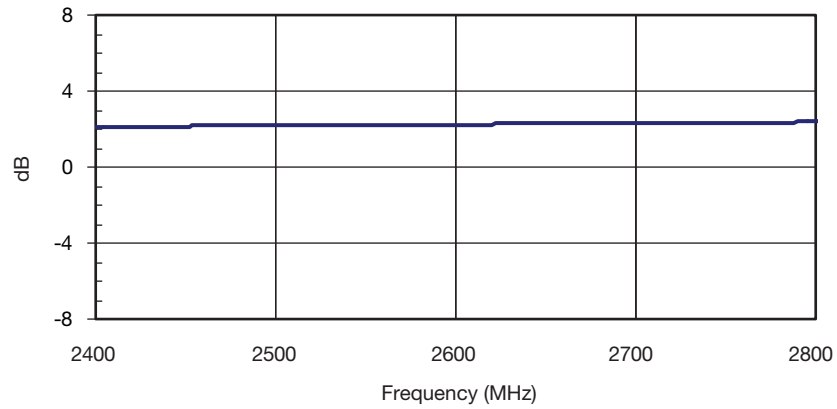

Isolation

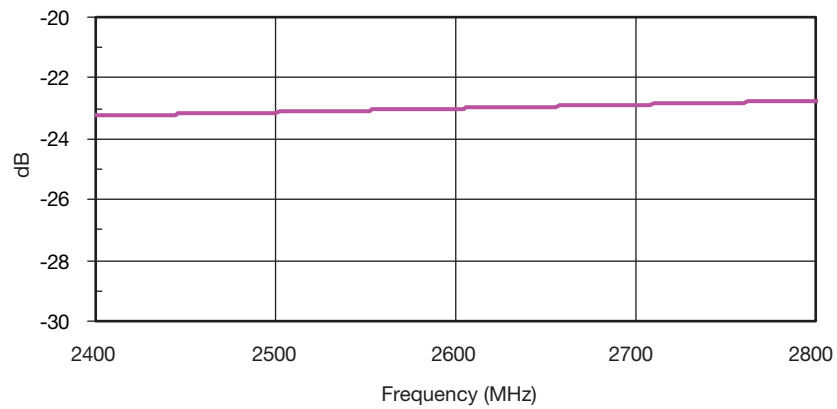

3



Thin-Film Directional Couplers

DB0603N 3dB 90° Couplers



2850MHz to 3150MHz DB0603N3000ANTR

Return Loss - Input

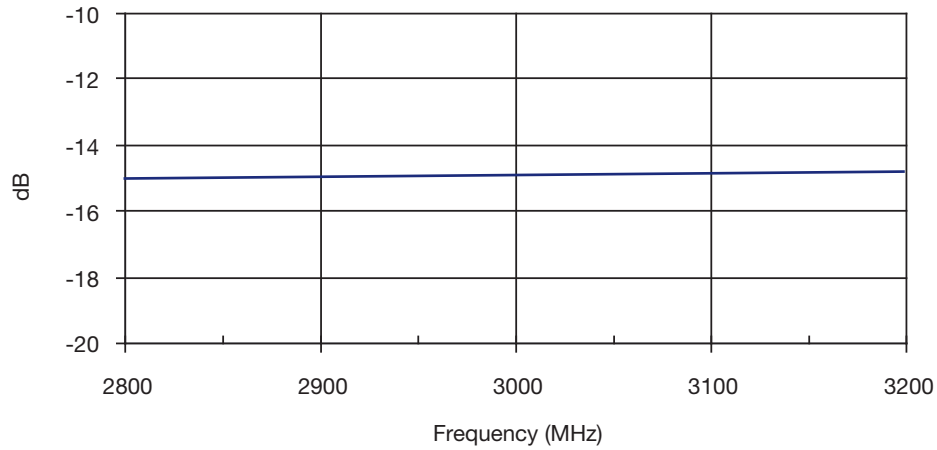

Insertion Loss

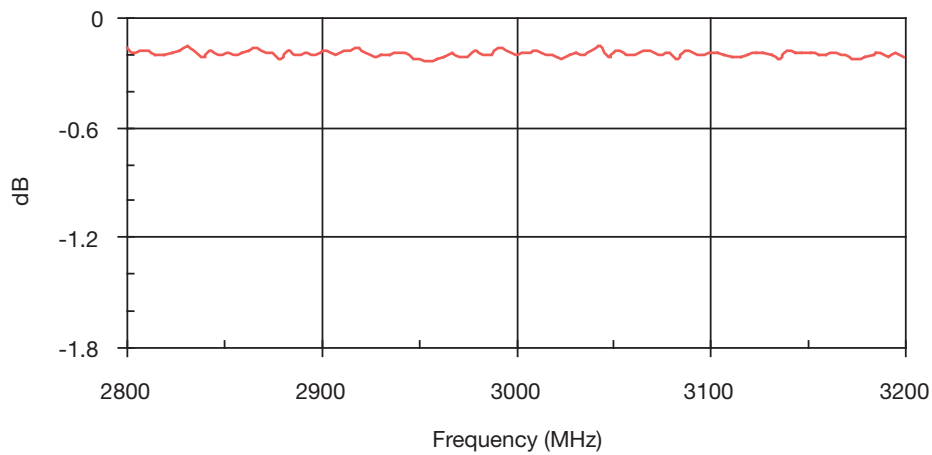

Amplitude Balance

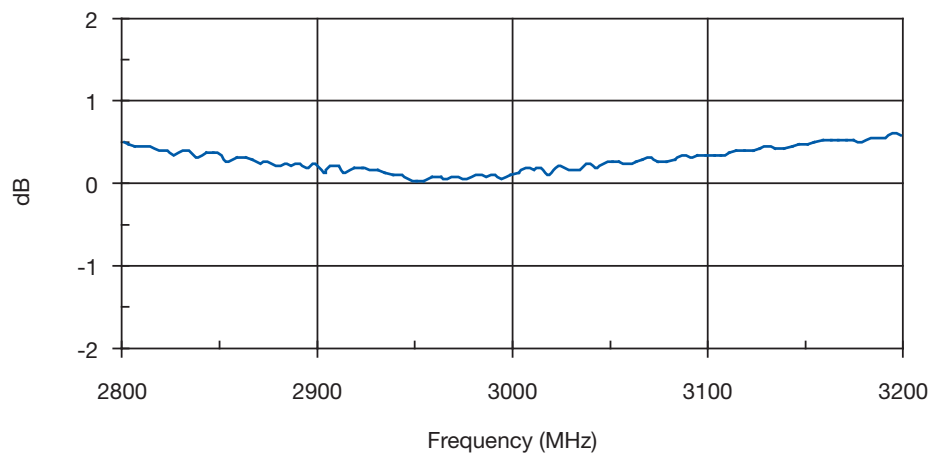

3



Thin-Film Directional Couplers

DB0603N 3dB 90° Couplers



2850MHz to 3150MHz DB0603N3000ANTR

Phase Balance

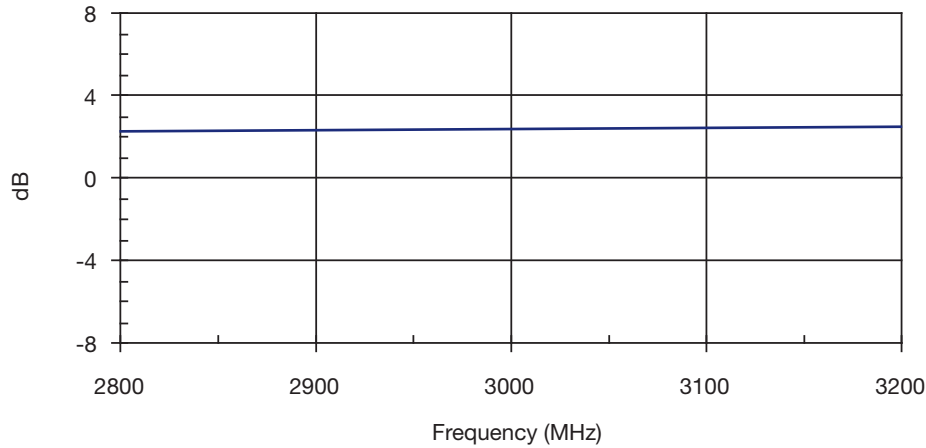

Isolation

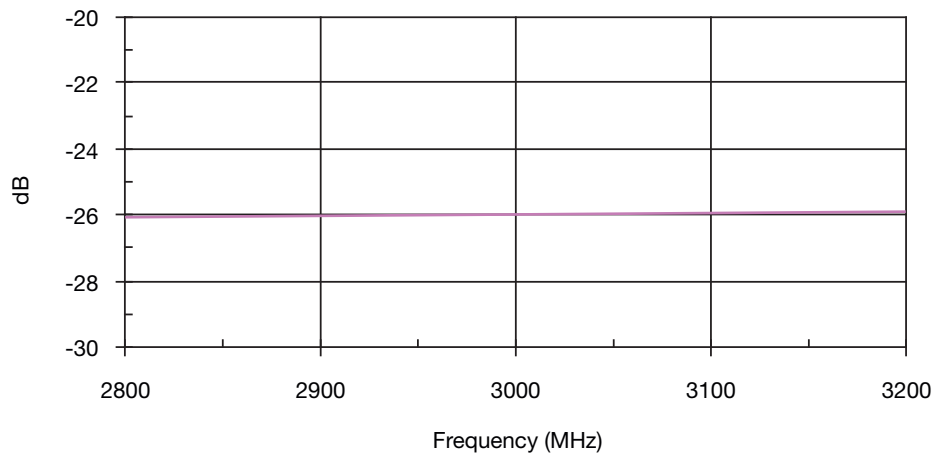

3



Thin-Film Directional Couplers

DB0603N 3dB 90° Couplers



3200MHz to 3800MHz DB0603N3500ANTR

Return Loss - Input

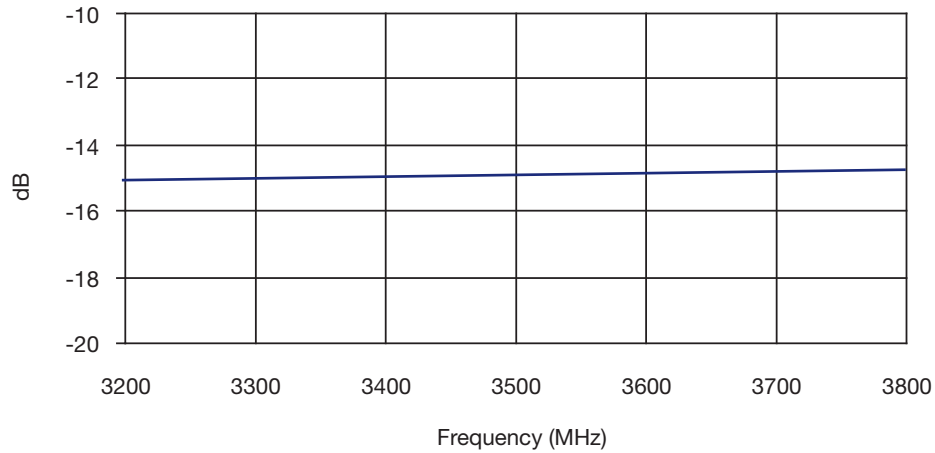

Insertion Loss

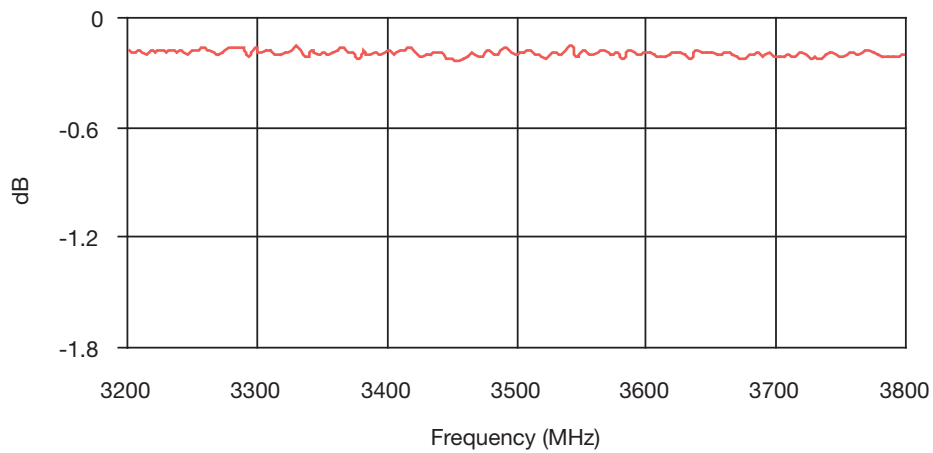

Amplitude Balance

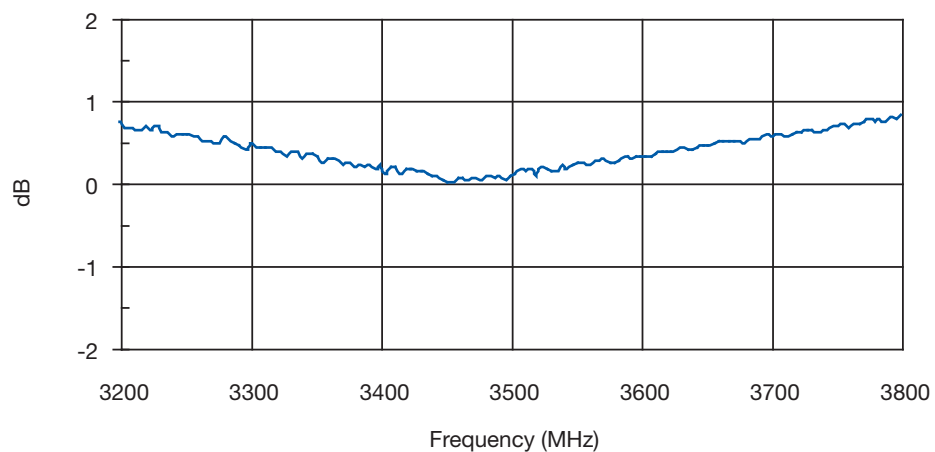

3

Thin-Film Directional Couplers

DB0603N 3dB 90° Couplers



3200MHz to 3800MHz DB0603N3500ANTR

Phase Balance

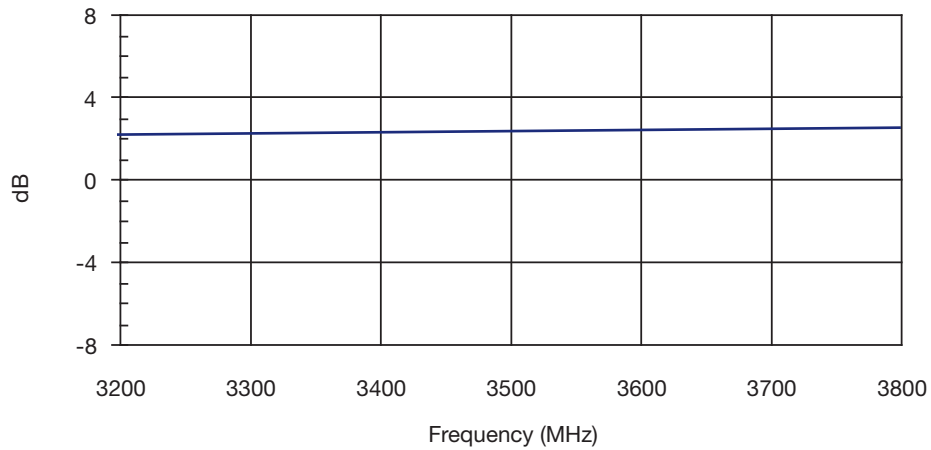

Isolation

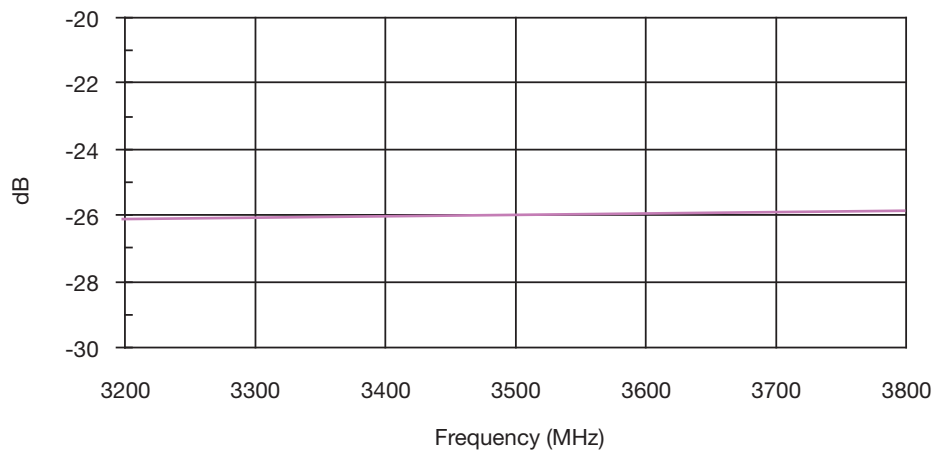

3



Thin-Film Directional Couplers

DB0603N 3dB 90° Couplers



4200MHz TO 5000MHz DB0603N4600ANTR

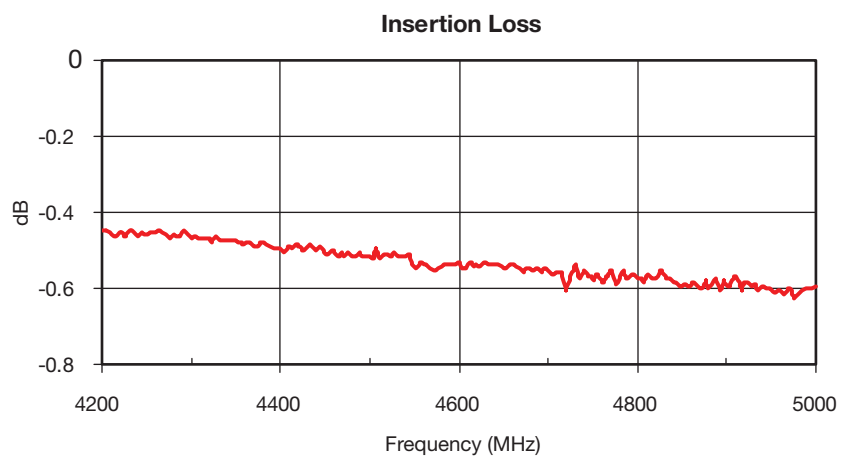
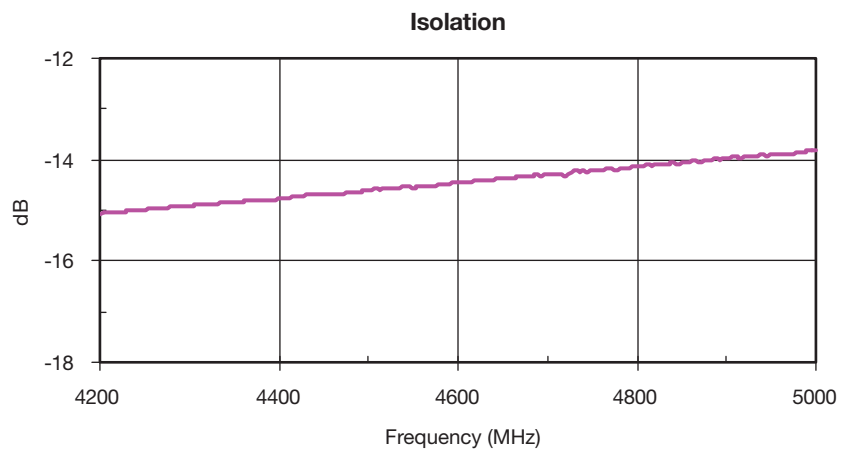
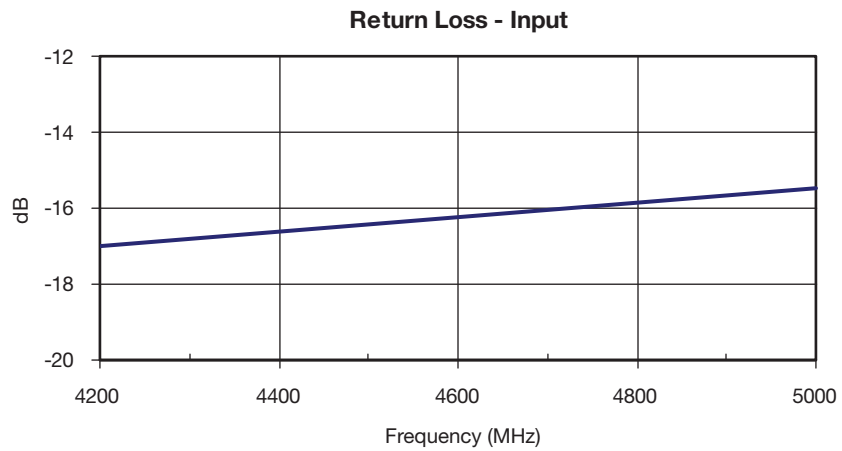

3

Thin-Film Directional Couplers

DB0603N 3dB 90° Couplers



4200MHz TO 5000MHz DB0603N4600ANTR

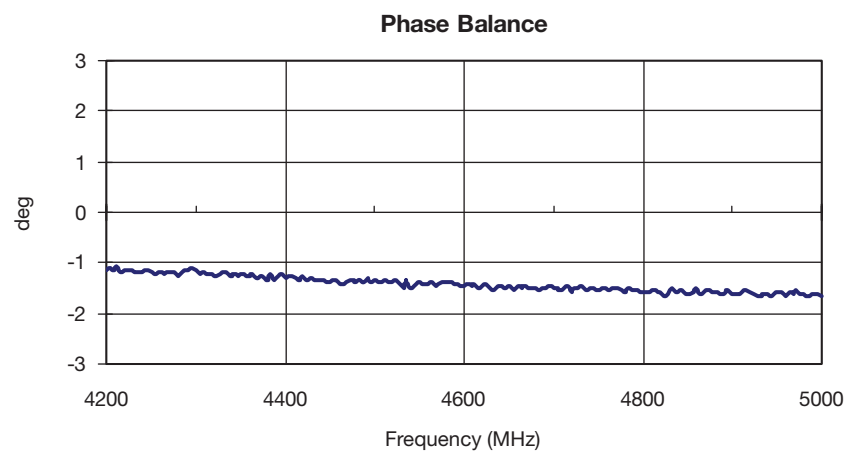
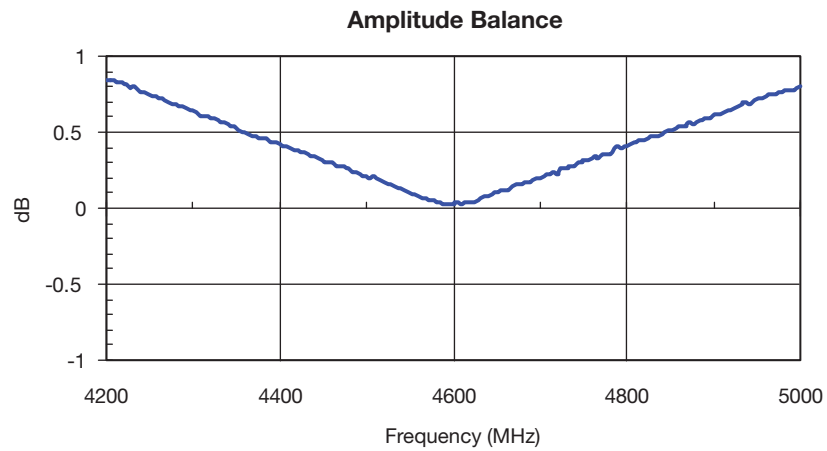

3

Thin-Film Directional Couplers

DB0603N 3dB 90° Couplers



5100MHz TO 5900MHz DB0603N5500ANTR

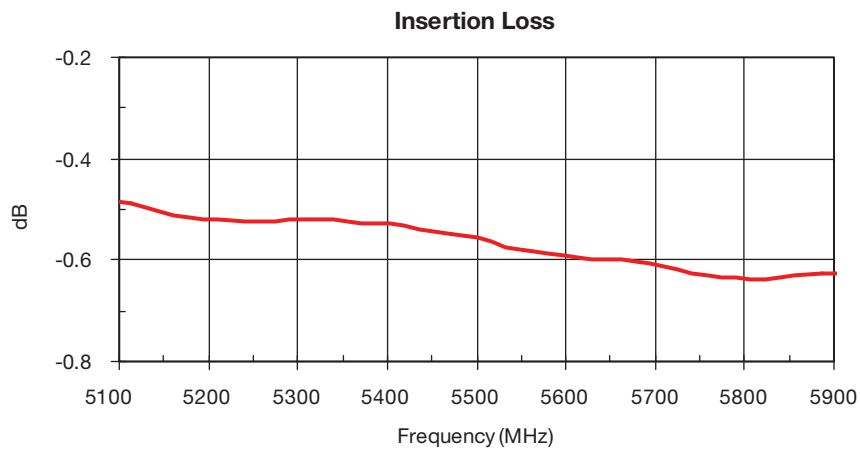
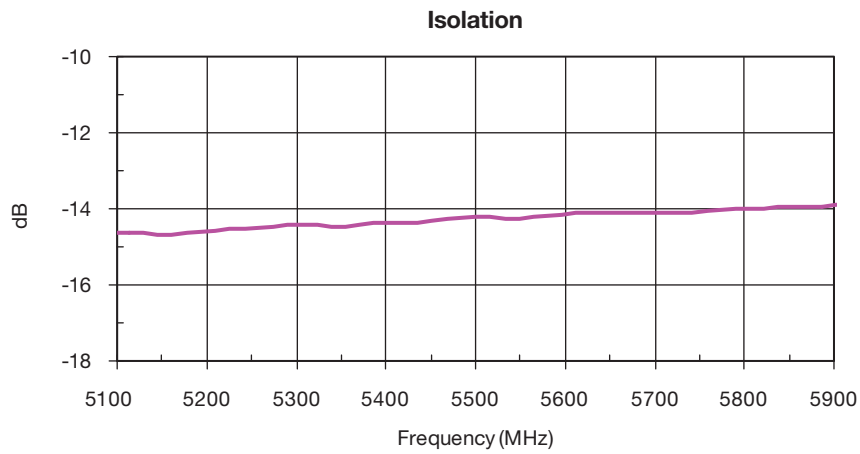
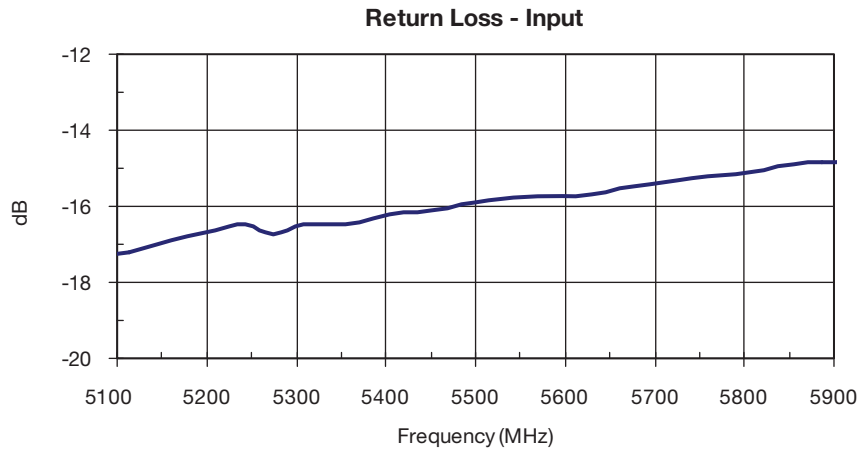

3

Thin-Film Directional Couplers

DB0603N 3dB 90° Couplers



5100MHz TO 5900MHz DB0603N5500ANTR

Amplitude Balance

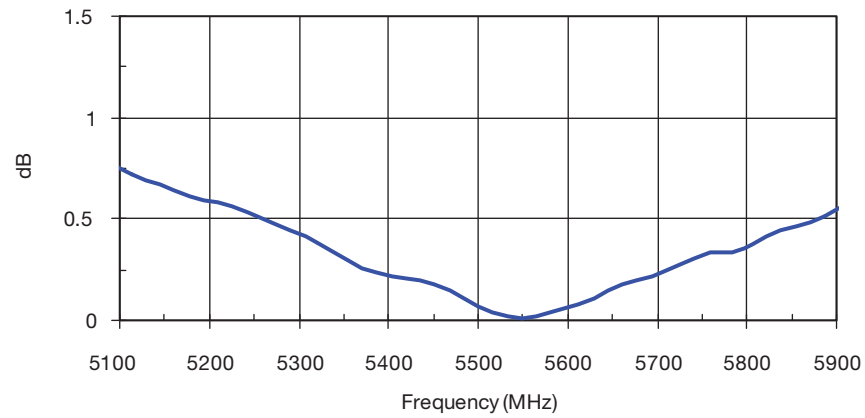

Phase Balance

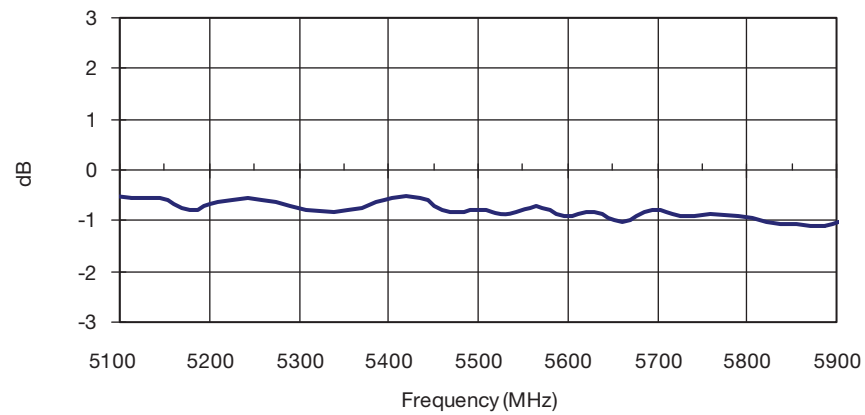

3

Thin-Film Directional Couplers

DB0603N 3dB 90° Couplers



5600MHz TO 6000MHz DB0603N5800ANTR

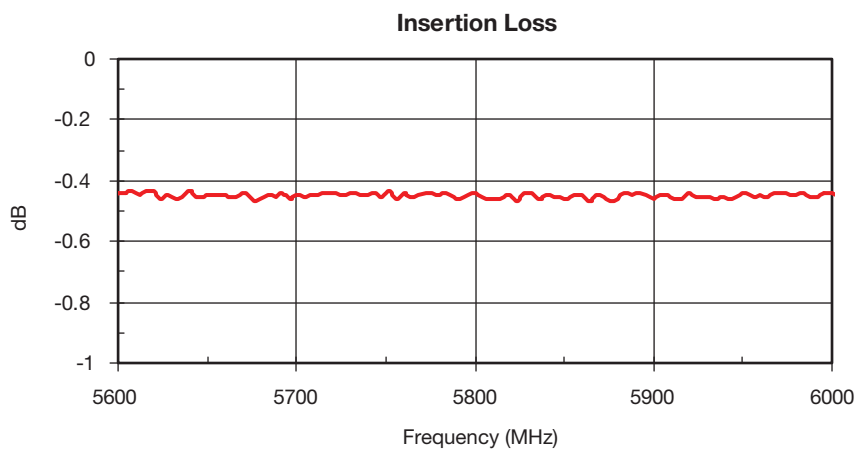
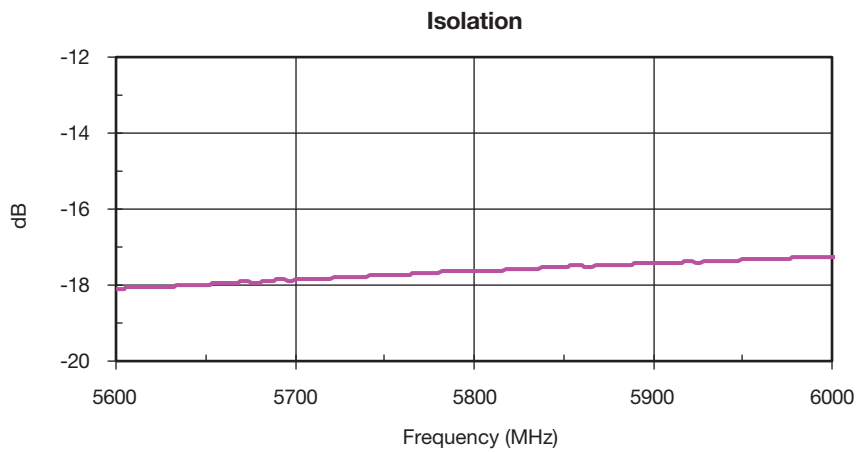
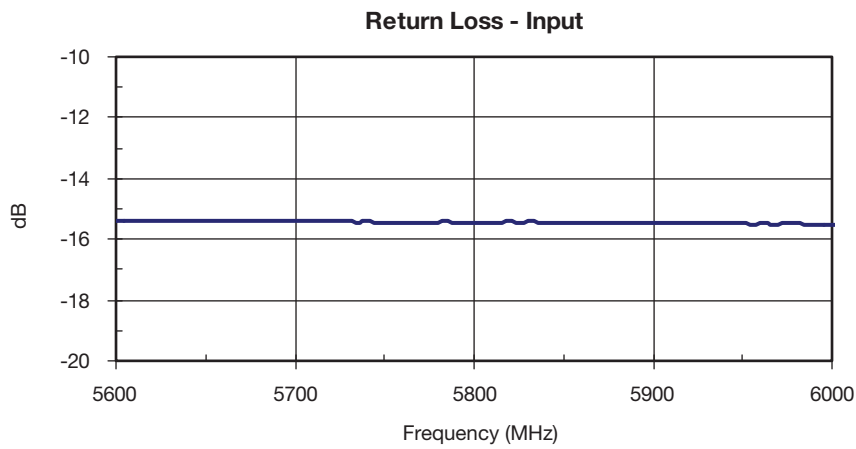

3

Thin-Film Directional Couplers

DB0603N 3dB 90° Couplers



5600MHz TO 6000MHz DB0603N5800ANTR

Amplitude Balance

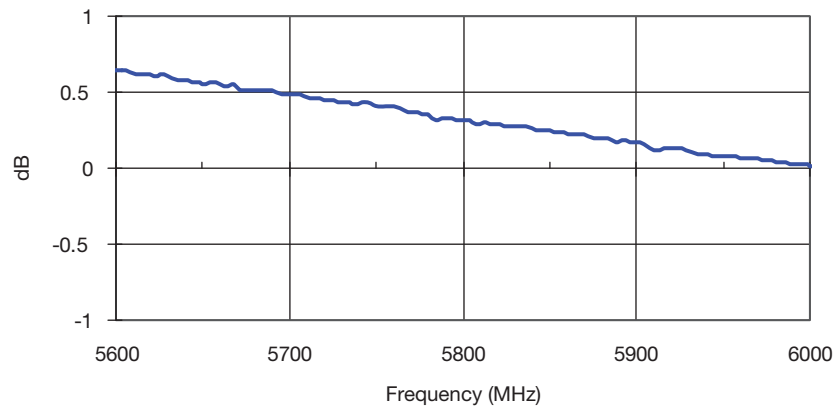

Phase Balance

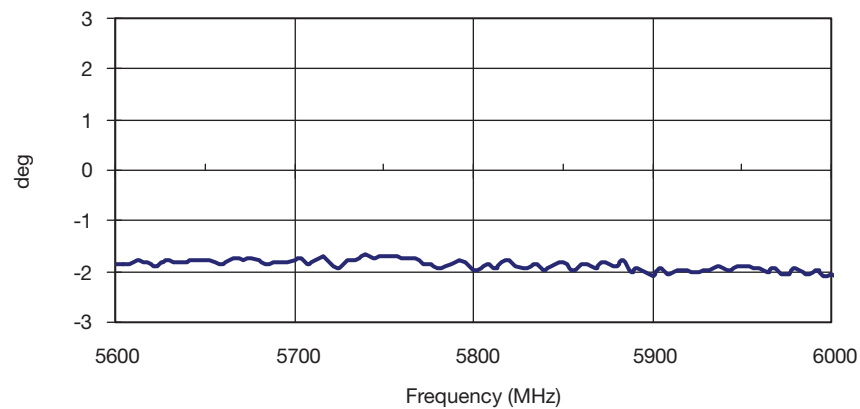

3



Thin-Film Directional Couplers

DB0805 3dB 90° Couplers



GENERAL DESCRIPTION ITF TECHNOLOGY

The ITF SMD 3dB 90° Coupler is based on thin-film multilayer technology. The technology provides a miniature part with excellent high frequency performance and rugged construction for reliable automatic assembly.

The ITF 3dB 90° Coupler is offered in a variety of frequency bands compatible with various types of high frequency wireless systems.

Recommended Pad Layout Dimensions mm (inches)

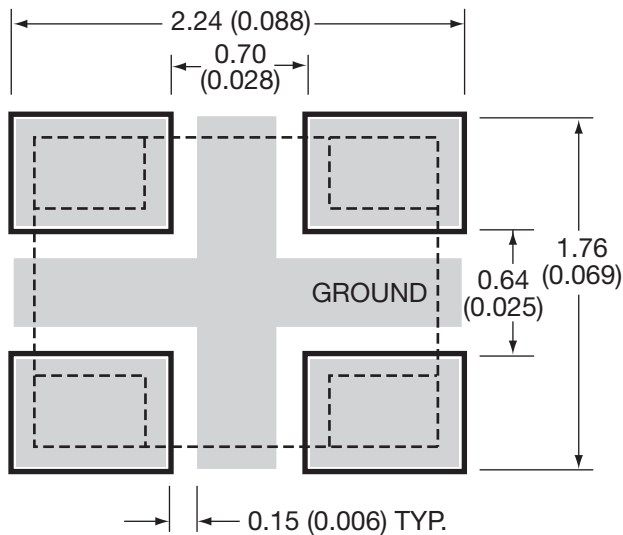

APPLICATIONS

- Balanced Amplifiers and Signal Distribution in Mobile Communications

FEATURES

- Miniature 0805 size
- Low I. Loss
- High Isolation
- Power Handling: 10W RF CW
- Surface Mountable
- Supplied on Tape and Reel
- Operating Temperature -40°C to +85°C

DIMENSIONS:

millimeters (inches)

L	2.03±0.10 (0.080±0.004)
W	1.55±0.10 (0.061±0.004)
T	0.98±0.15 (0.037±0.006)
A	0.56±0.25 (0.022±0.010)
B	0.35±0.15 (0.014±0.006)

Bottom View

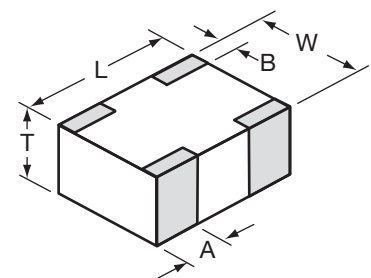

TERMINALS (Top View) Orientation in Tape

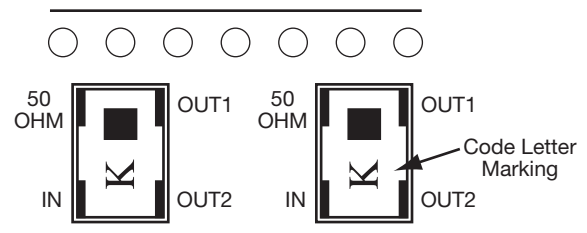

ELECTRICAL PARAMETERS*

Part Number**	Frequency F ₀ [MHz]	I. Loss @ F ₀ [dB]	Phase Balance [deg] max.	Code Letter Marking
DB0805A0880ASTR	880±30	0.35	3	Y
DB0805A0915ASTR	915±30	0.35	3	V
DB0805A0967ASTR	967±30	0.35	3	V
DB0805A1350ASTR	1350±50	0.35	3	C
DB0805A1650ASTR	1650±50	0.35	3	F
DB0805A1800ASTR	1800±50	0.30	3	F
DB0805A1850ASTR	1850±50	0.30	3	K
DB0805A1900ASTR	1900±50	0.30	3	K
DB0805A1950ASTR	1950±50	0.25	3	K
DB0805A2140ASTR	2140±50	0.25	3	L
DB0805A2325ASTR	2325±50	0.25	3	T

*With Recommended Pad Layout

NOTE: Additional Frequencies Available Upon Request

****LEAD FREE TERMINATION
PART NUMBERS:
DB0805AxxxxASTR**



Thin-Film Directional Couplers

DB0805 3dB 90° Couplers



880 ± 30MHz DB0805A0880ASTR

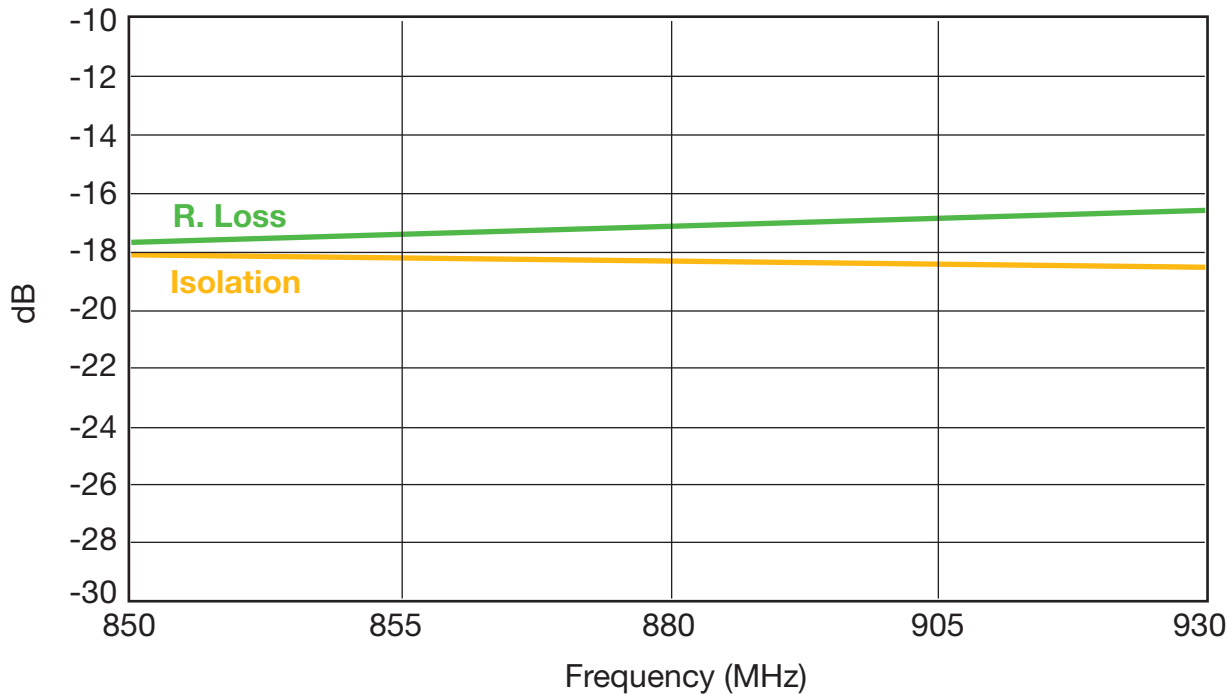
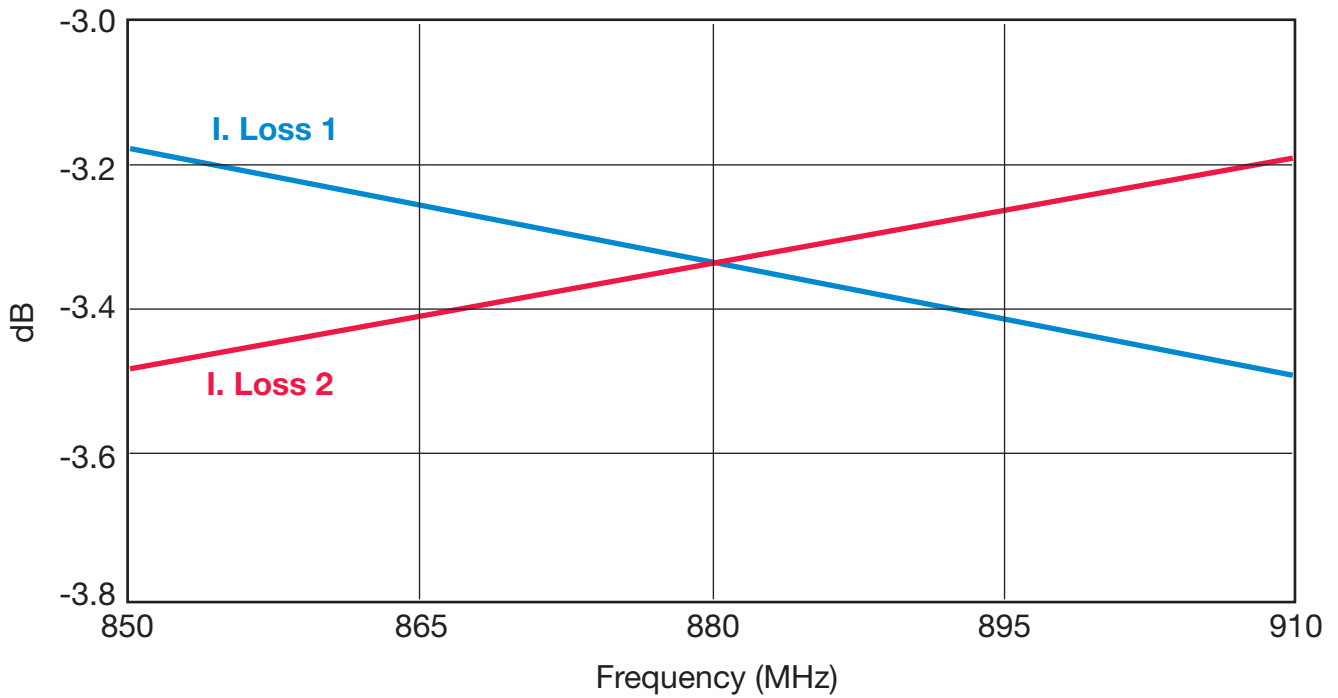

3



Thin-Film Directional Couplers

DB0805 3dB 90° Couplers



915 ± 30MHz DB0805A0915ASTR

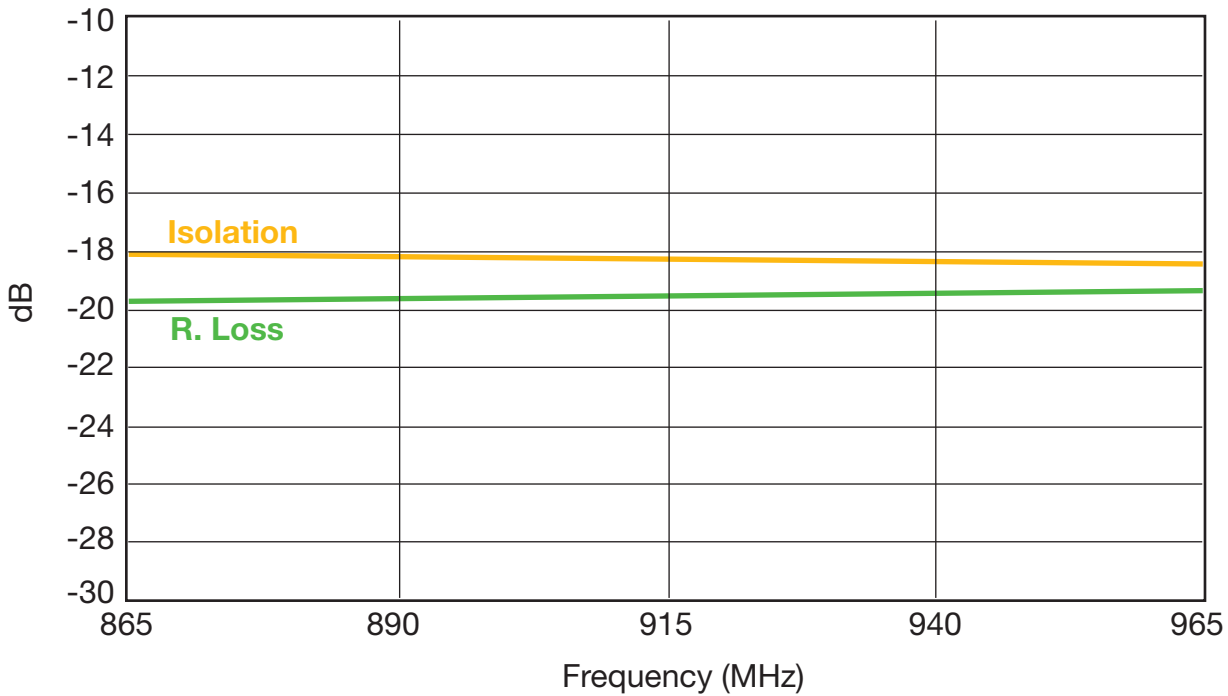
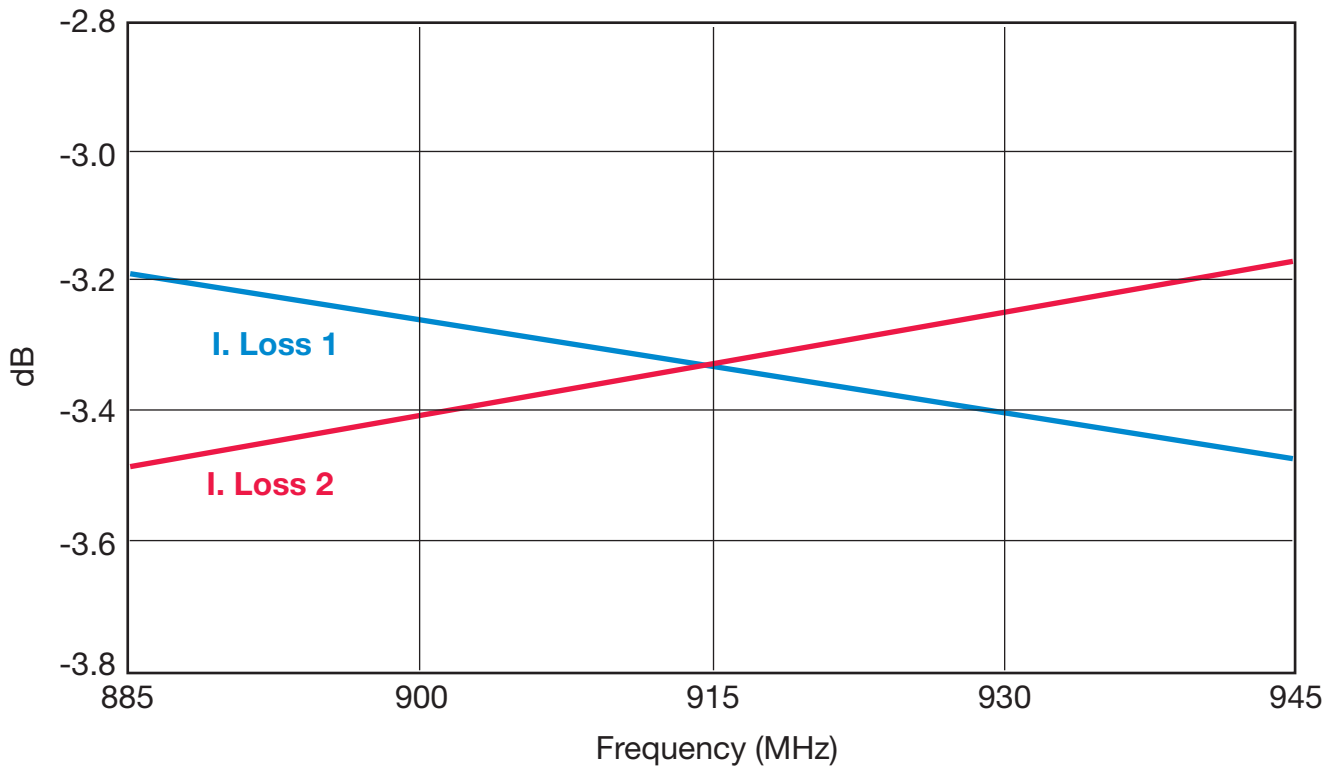

3

Thin-Film Directional Couplers

DB0805 3dB 90° Couplers



967± 30MHz DB0805A0967ASTR

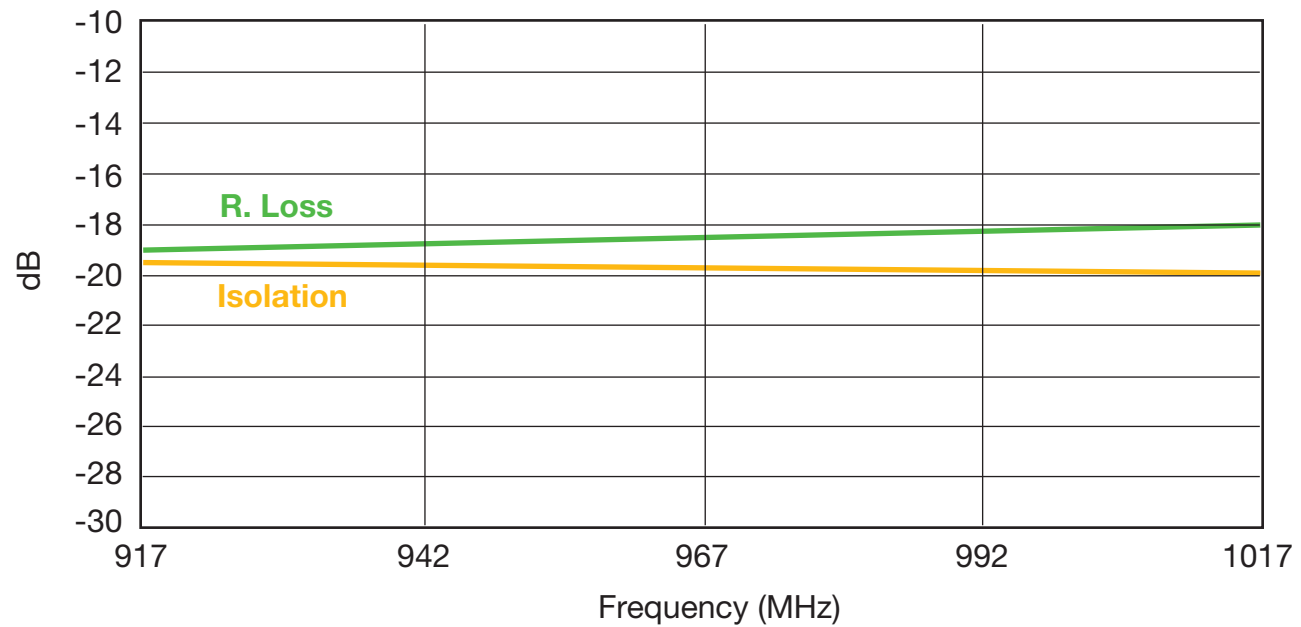
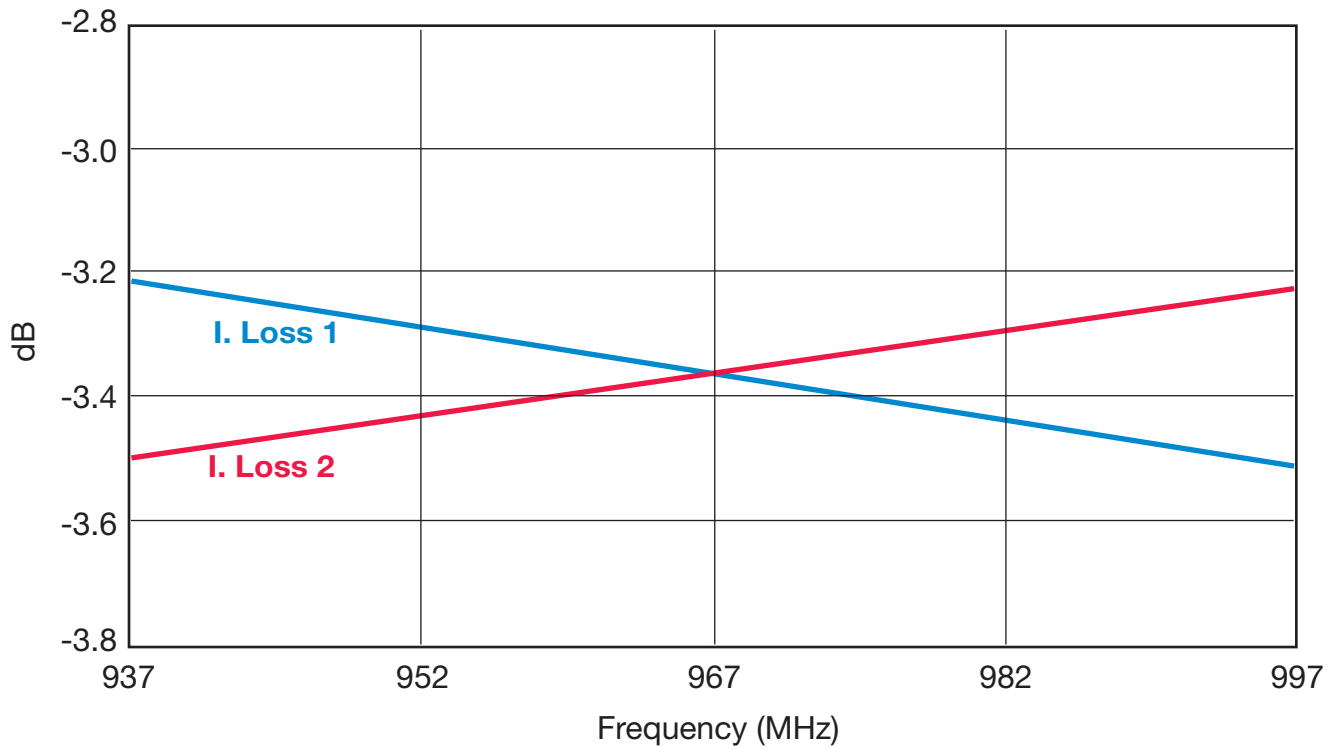

3



Thin-Film Directional Couplers

DB0805 3dB 90° Couplers



1350 ± 50MHz DB0805A1350ASTR

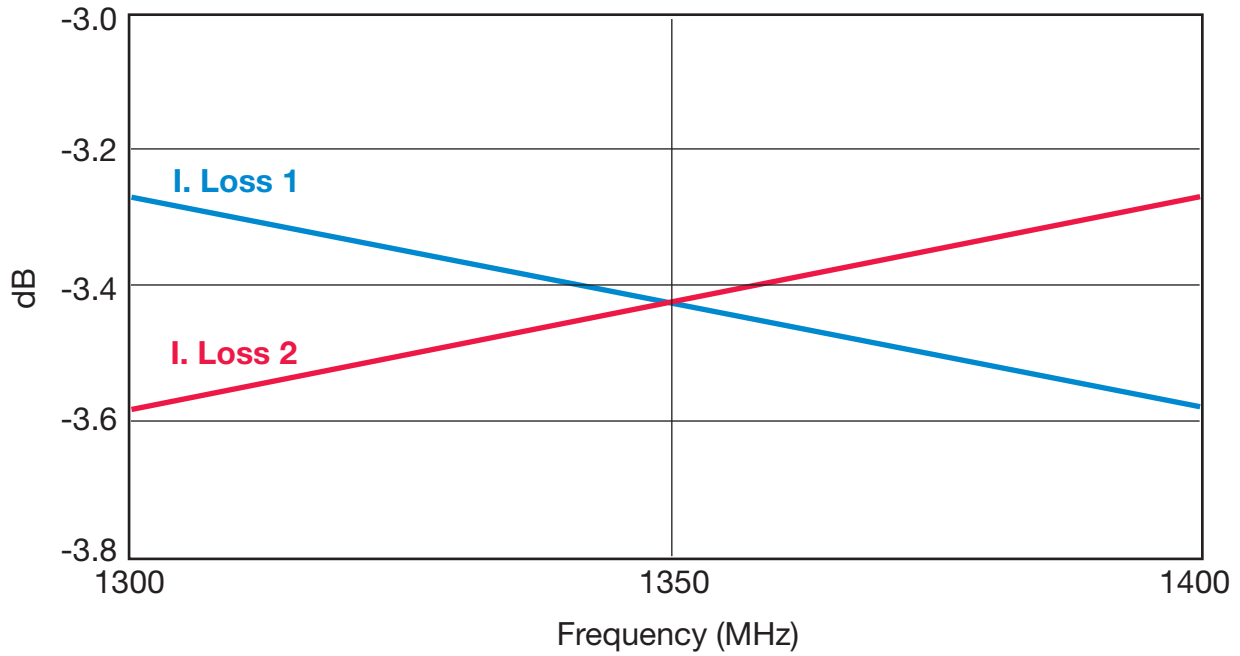

3

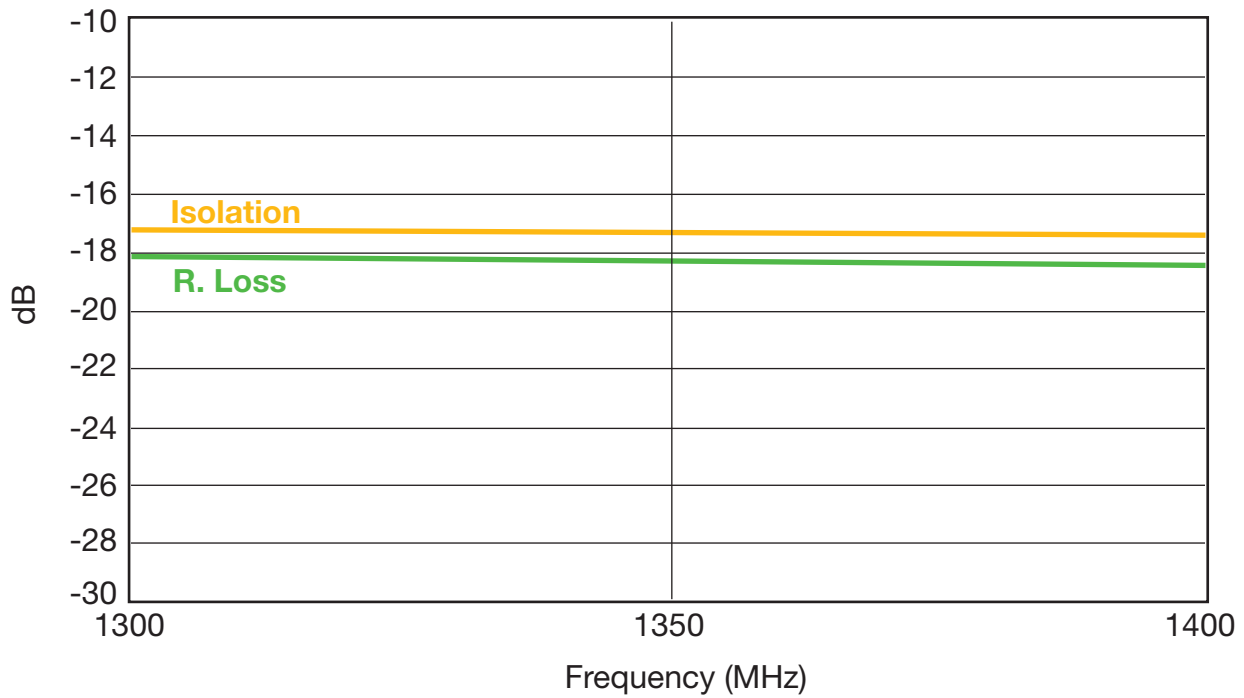

Thin-Film Directional Couplers

DB0805 3dB 90° Couplers



1650 ± 50MHz DB0805A1650ASTR

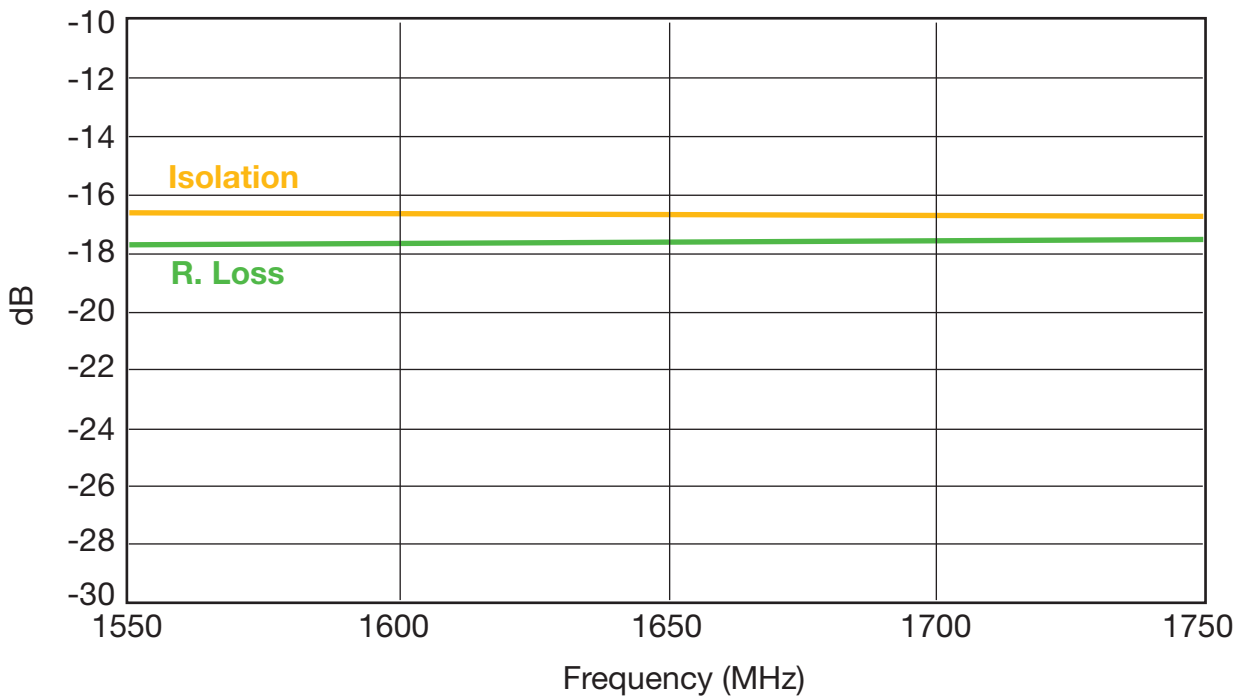
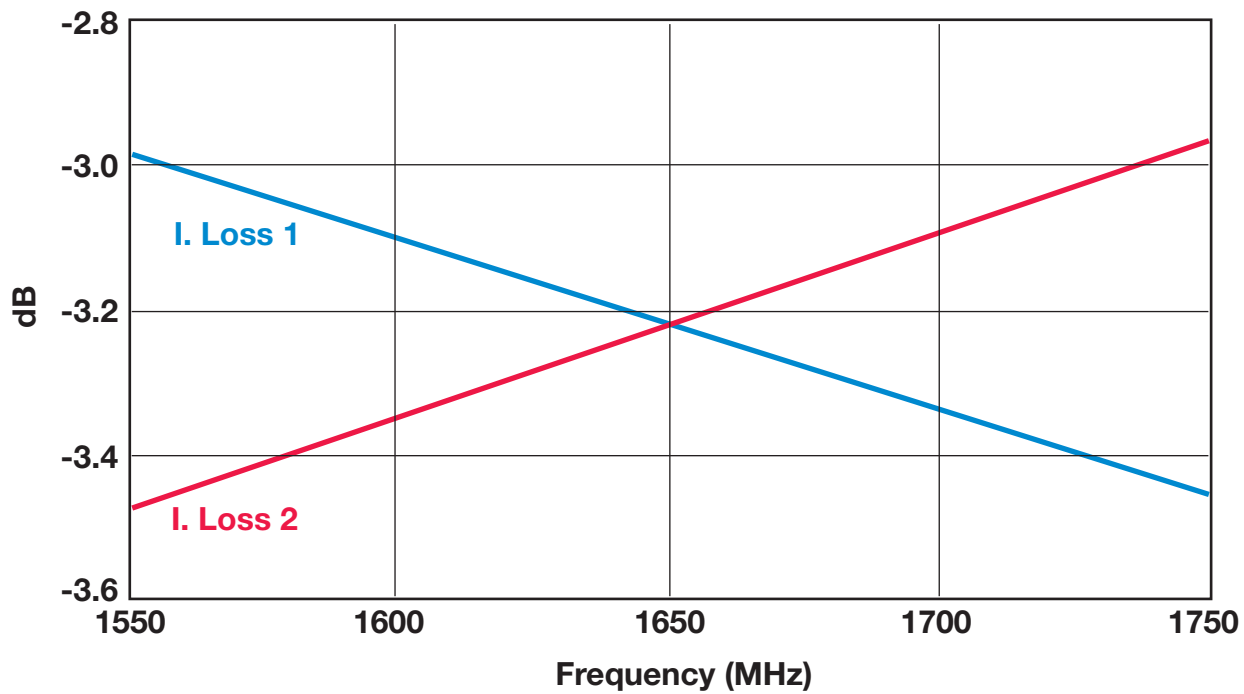

3

Thin-Film Directional Couplers

DB0805 3dB 90° Couplers



1800 ± 50MHz DB0805A1800ASTR

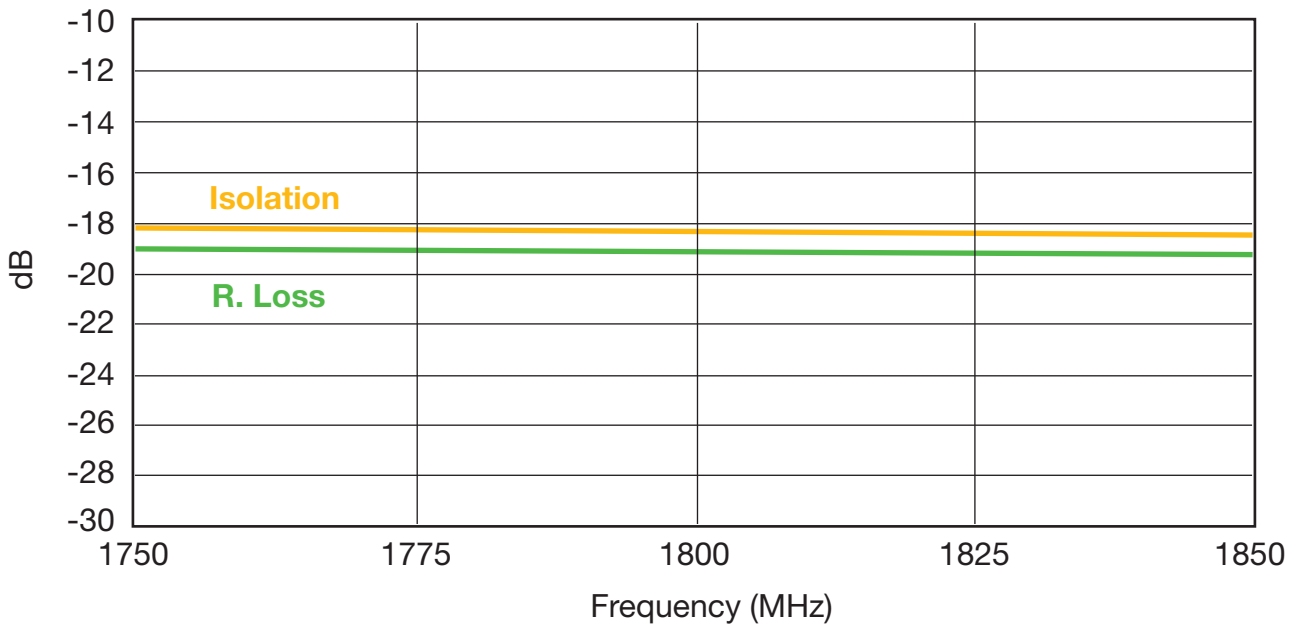
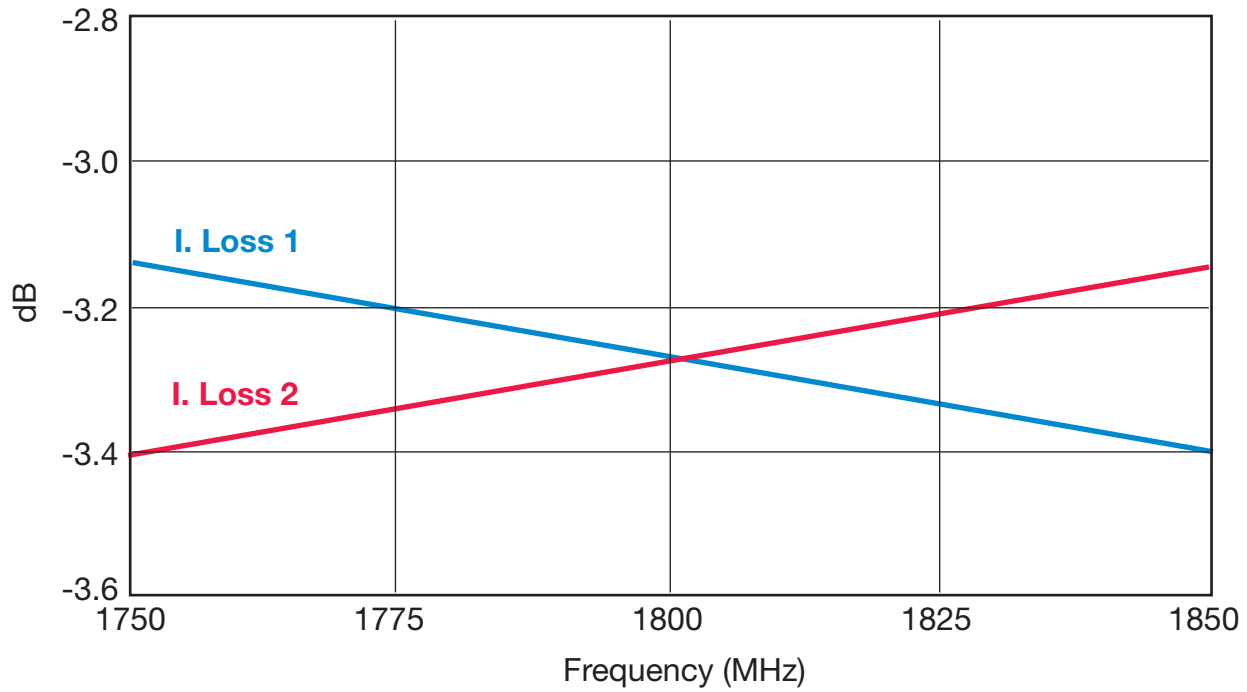

3

Thin-Film Directional Couplers

DB0805 3dB 90° Couplers



1850 ± 50MHz DB0805A1850ASTR

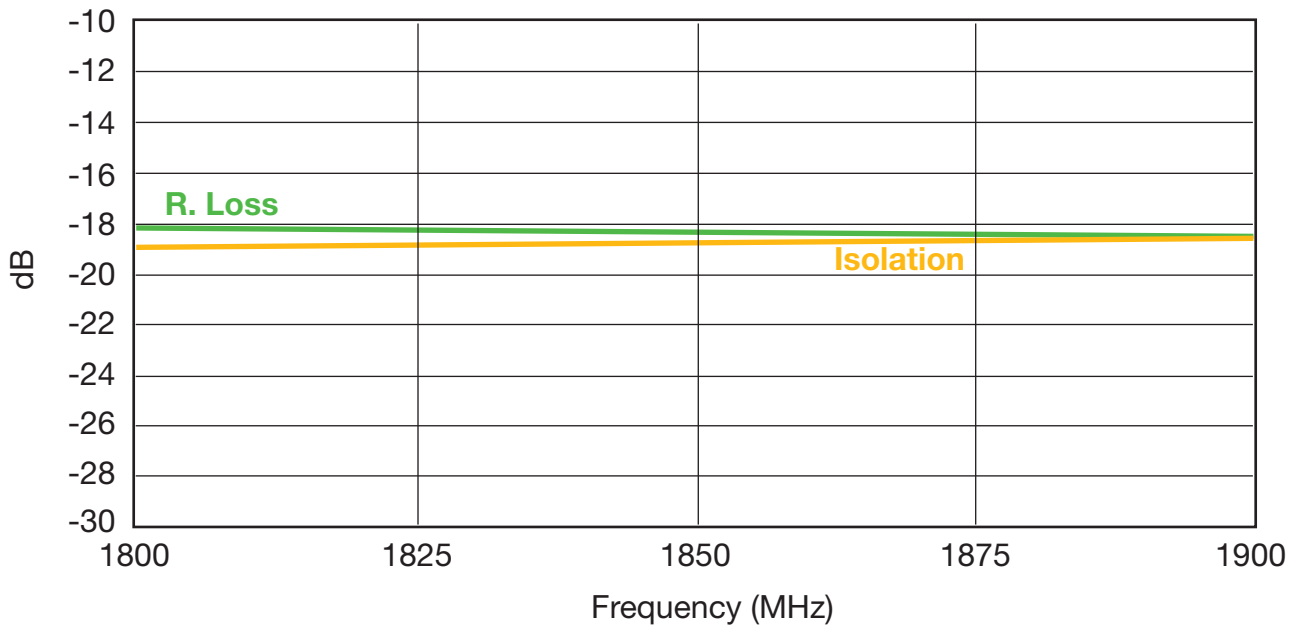
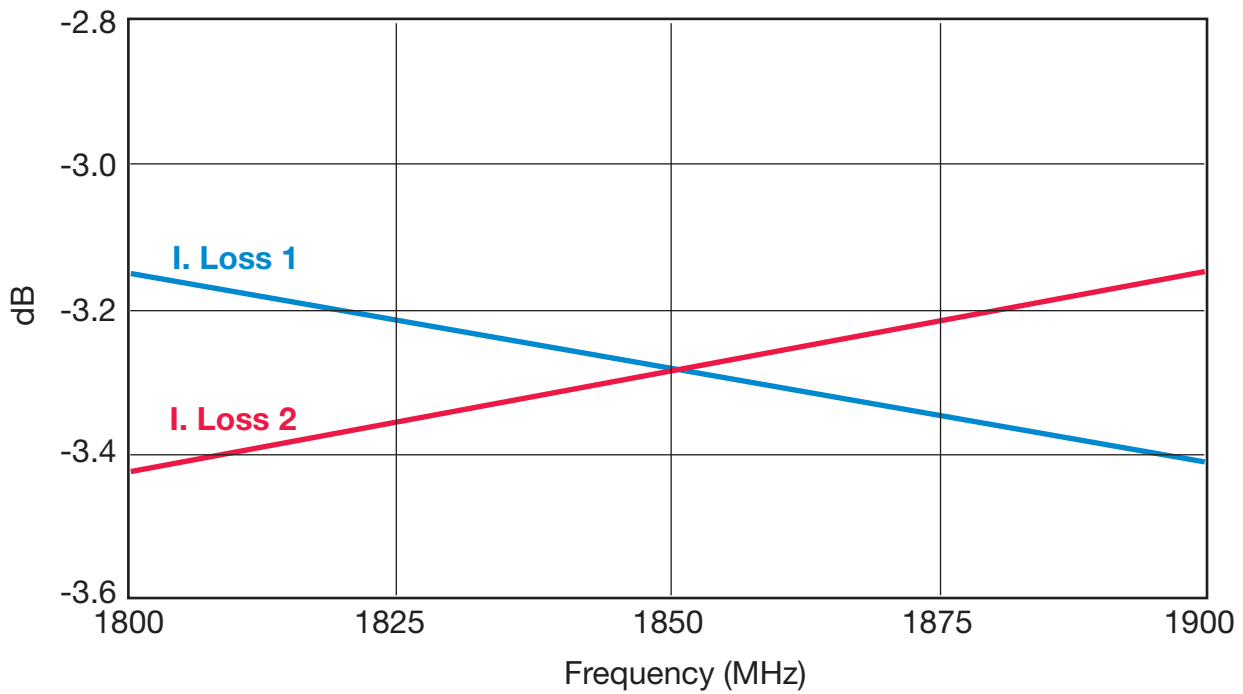

3

Thin-Film Directional Couplers

DB0805 3dB 90° Couplers



1900 ± 50MHz DB0805A1900ASTR

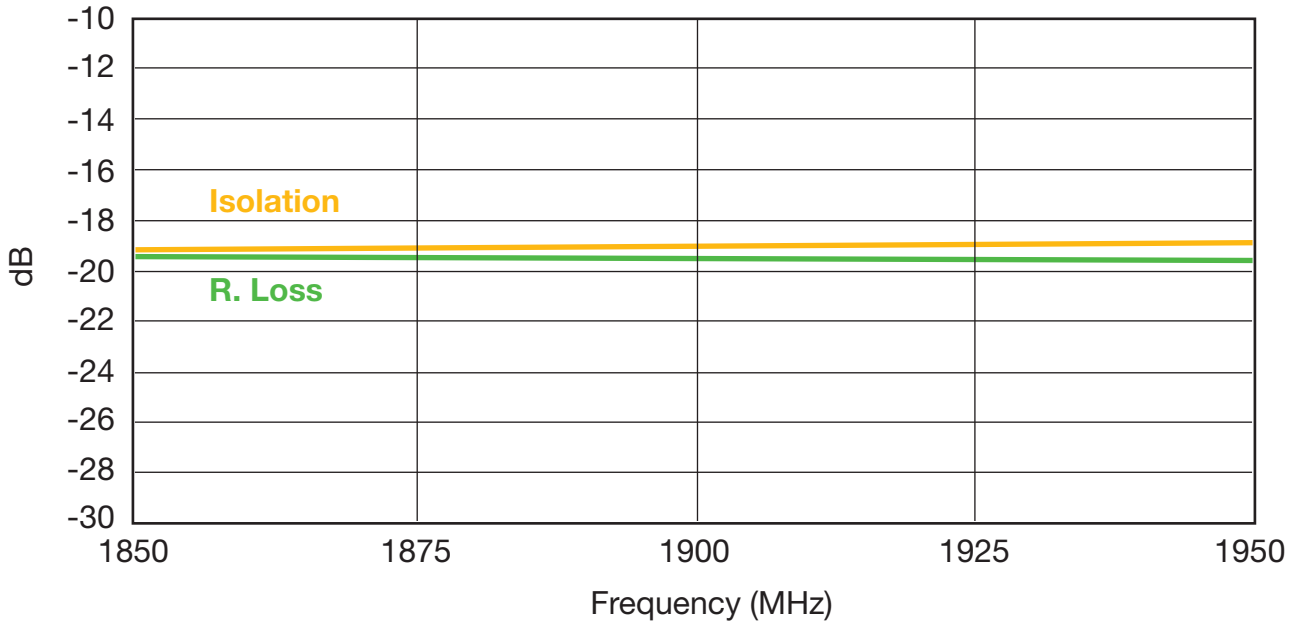
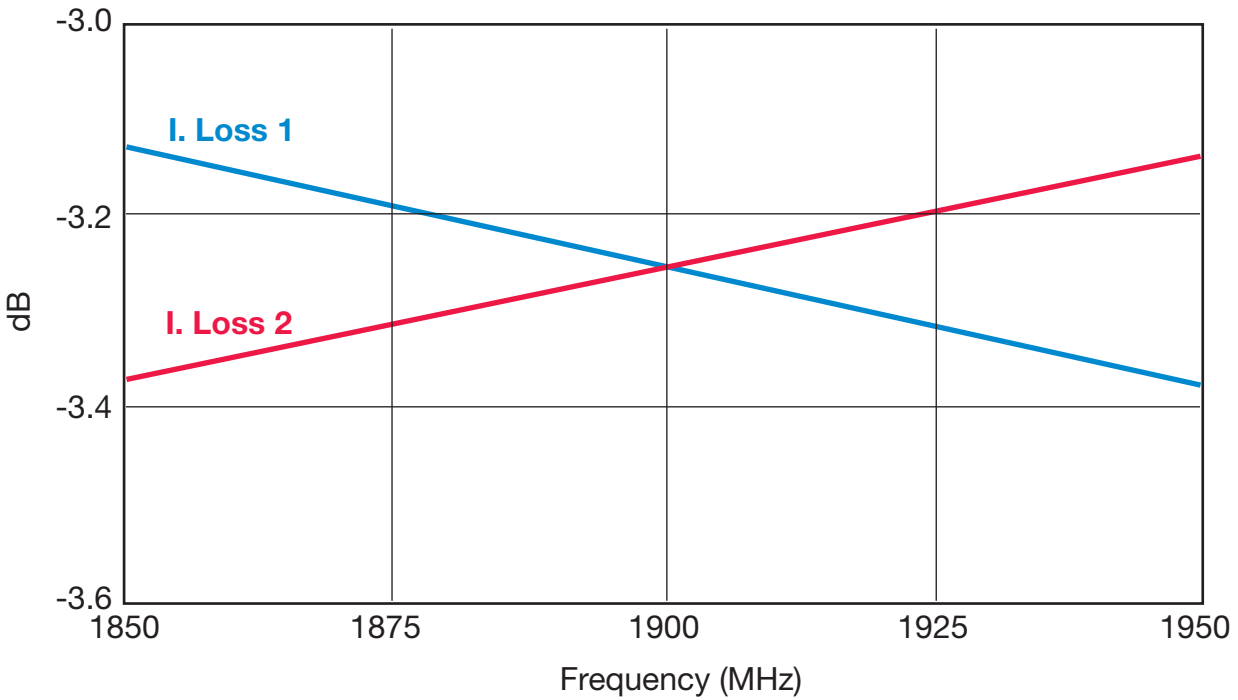

3

Thin-Film Directional Couplers

DB0805 3dB 90° Couplers



1950 ± 50MHz DB0805A1950ASTR

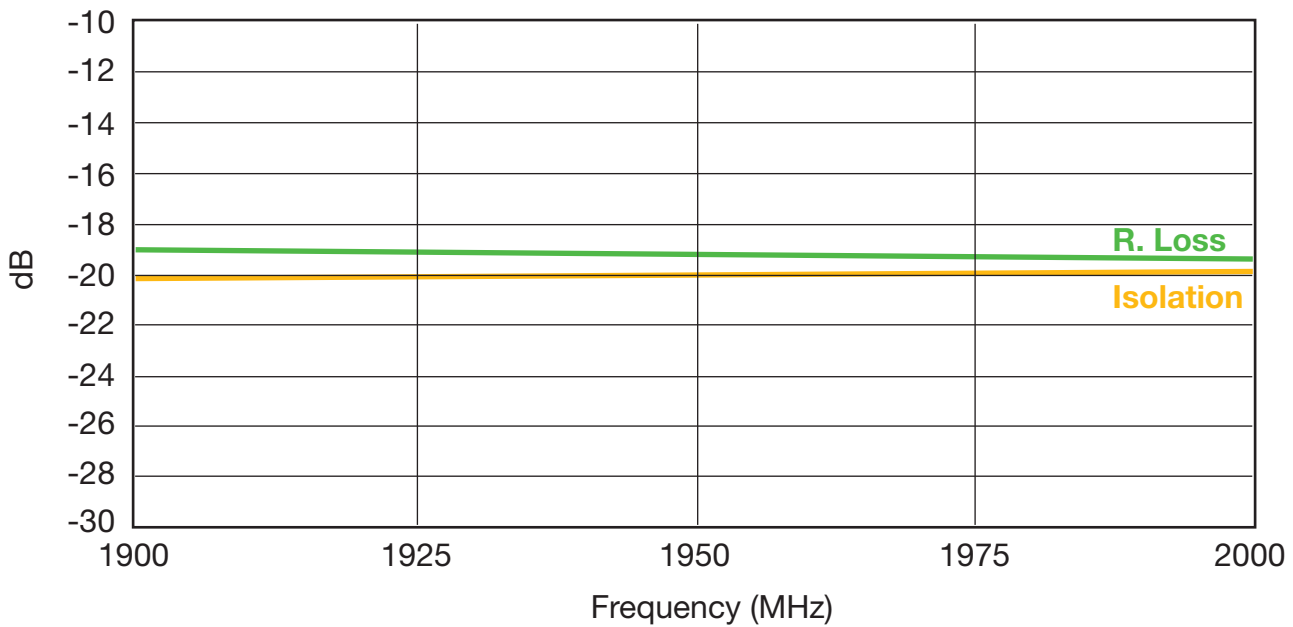
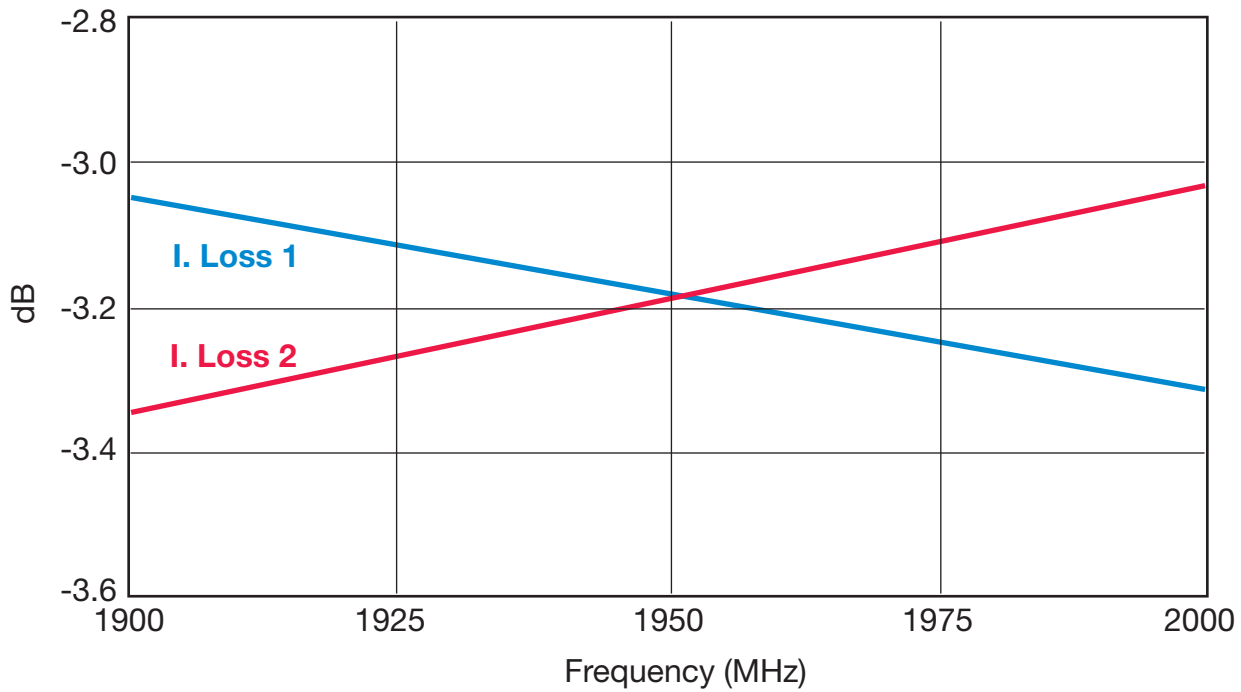

3



Thin-Film Directional Couplers

DB0805 3dB 90° Couplers



2140 ± 50MHz DB0805A2140ASTR

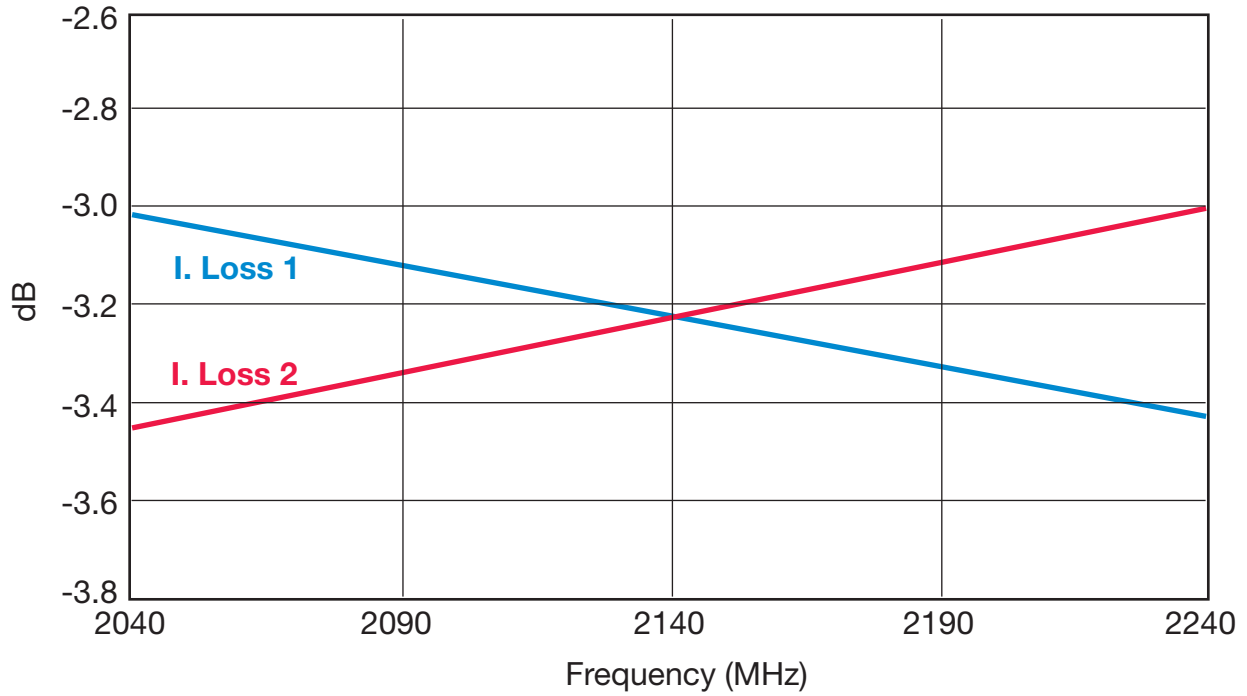

3

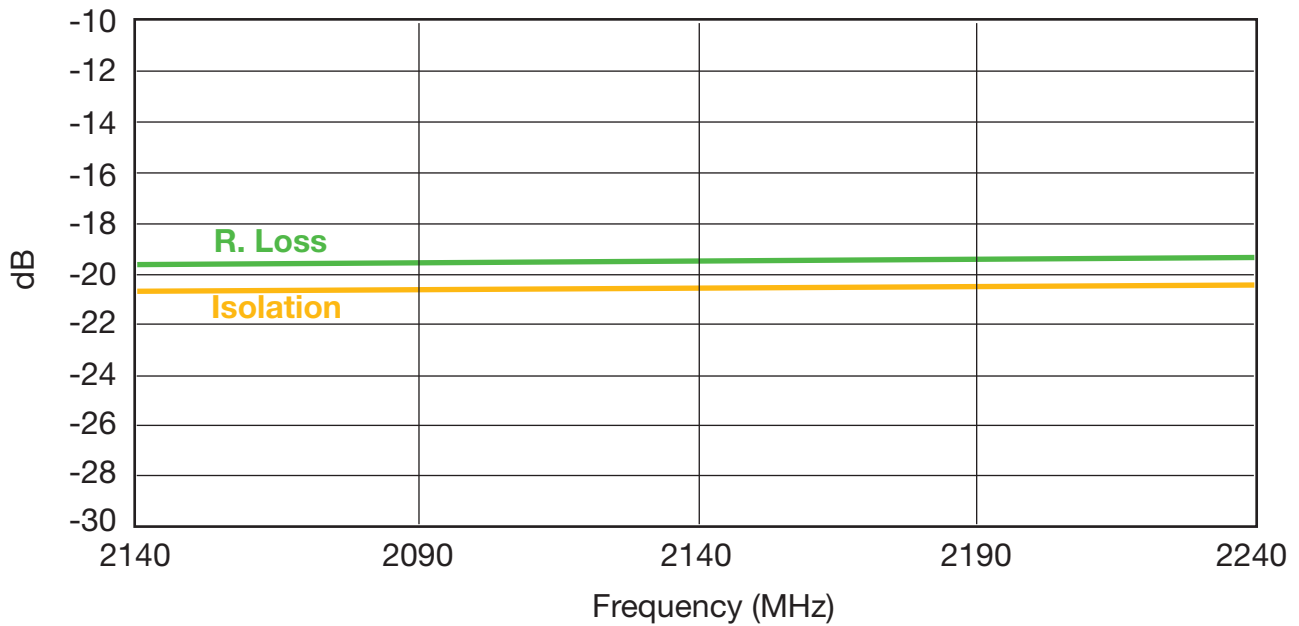

Thin-Film Directional Couplers

DB0805 3dB 90° Couplers



2325 ± 50MHz DB0805A2325ASTR

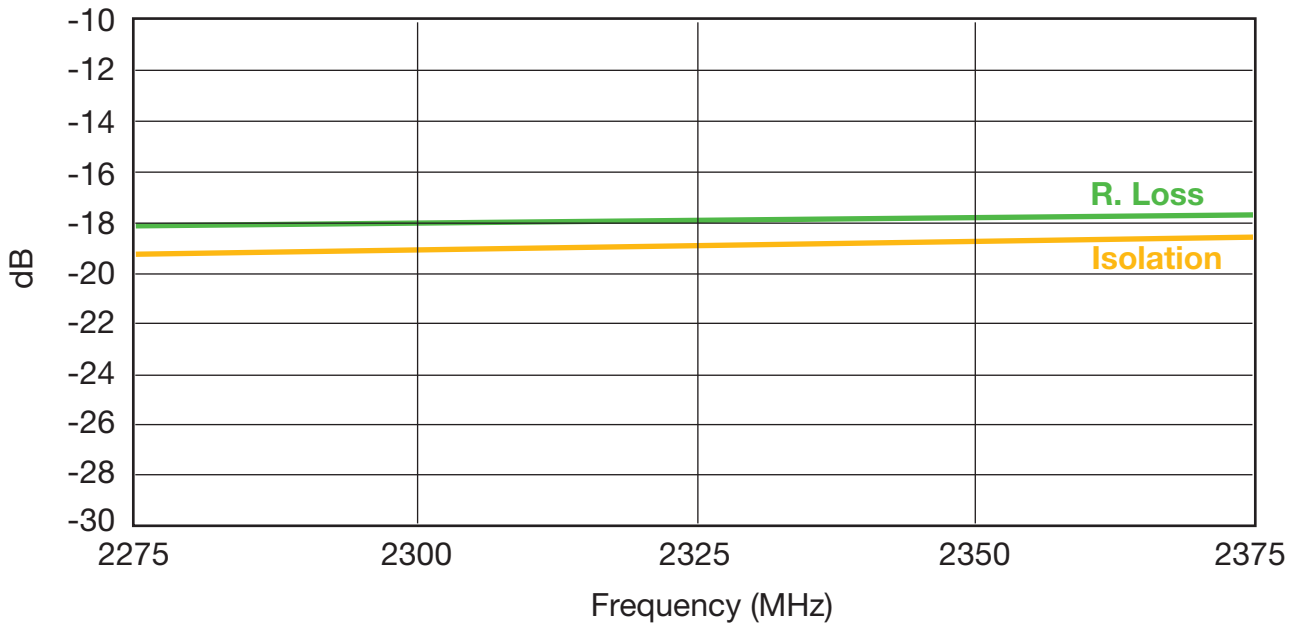
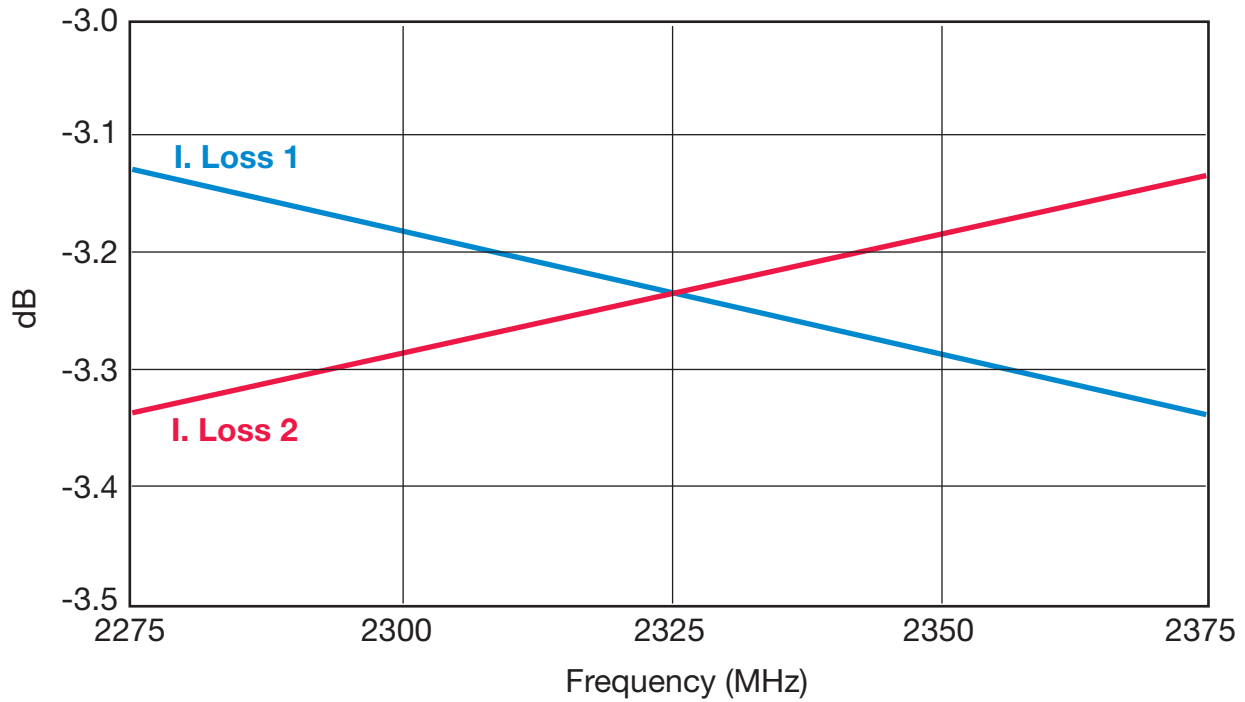

3



DB0805 3dB 90° Test Jigs

GENERAL DESCRIPTION

These jigs are designed for testing the DB0805 3dB 90° Couplers using a Vector Network Analyzer.

They consist of a dielectric substrate, having 50Ω microstrips as conducting lines and a bottom ground plane located at a distance of 0.254mm from the microstrips.

The substrate used is Neltec's NH9338ST0254C1BC.

The connectors are SMA type (female), 'Johnson Components Inc.' Product P/N: 142-0701-841.

Both a measurement jig and a calibration jig are provided.

The calibration jig is designed for a full 2-port calibration, and consists of an open line, short line and through line. LOAD calibration can be done by a 50Ω SMA termination.

MEASUREMENT PROCEDURE

When measuring a component, it can be either soldered or pressed using a non-metallic stick until all four ports touch the appropriate pads. Set the VNA to the relevant frequency band. Connect the VNA using a 10dB attenuator on the jig

terminal connected to port 2. Follow the VNA's instruction manual and use the [calibration jig](#) to perform a full 2-port calibration in the required bandwidths.

Place the coupler on the [measurement jig](#) as follows:

Input (Coupler) → Connector 1 (Jig) Output 1 (Coupler) → Connector 3 (Jig)
50Ω (Coupler) → Connector 2 (Jig) Output 2 (Coupler) → Connector 4 (Jig)

To measure [R. Loss](#) and [I. Loss 1](#) connect:

Connector 1 (Jig) → Port 1 (VNA) Connector 3 (Jig) → Port 2 (VNA)
Connector 2 (Jig) → 50Ω Connector 4 (Jig) → 50Ω

To measure [R. Loss](#) and [I. Loss 2](#) connect:

Connector 1 (Jig) → Port 1 (VNA) Connector 3 (Jig) → 50Ω
Connector 2 (Jig) → 50Ω Connector 4 (Jig) → Port 2 (VNA)

To measure [Isolation](#) connect:

Connector 1 (Jig) → 50Ω Connector 3 (Jig) → Port 1 (VNA)
Connector 2 (Jig) → 50Ω Connector 4 (Jig) → Port 2 (VNA)

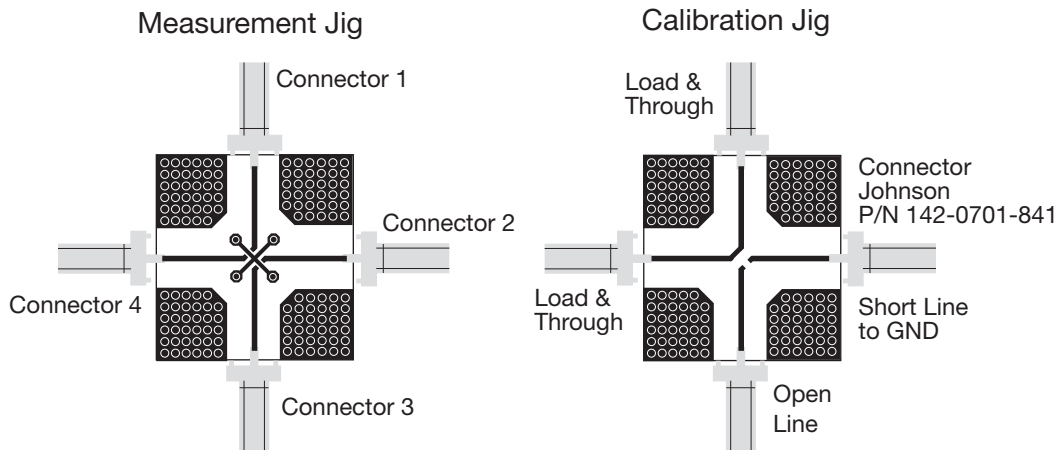



Thin-Film RF/Microwave Harmonic Low Pass Filter

LP0402/LP0603/LP0805

Thin-Film Low Pass Filter



LP0402N Series Harmonic Lead-Free LGA Termination

RFAP TECHNOLOGY

The LP0402N Series Harmonic Low Pass Filter is based on the proprietary RFAP Thin-Film multilayer technology. The technology provides a miniature part with excellent high frequency performance and rugged construction for reliable automatic assembly.

The RFAP Harmonic Low Pass Filter is offered in a variety of frequency bands compatible with various types of high frequency wireless systems.

APPLICATIONS

- Wireless communications
- Wireless LAN's
- GPS
- WiMAX

LAND GRID ARRAY ADVANTAGES

- Inherent Low Profile
- Self Alignment during Reflow
- Excellent Solderability
- Low Parasitics
- Better Heat Dissipation

HOW TO ORDER

LP
T
Style

0402
T
Size

N
T
Type

XXXX
T
Frequency
MHz

X
T
Sub-Type

N
T
Termination
LGA
Lead Free

TR
T
Taped & Reeled

QUALITY INSPECTION

Finished parts are 100% tested for electrical parameters and visual characteristics. Each production lot is evaluated on a sample basis for:

- Static Humidity: 85°C, 85% RH, 160 hours
- Endurance: 125°C, IR, 4 hours

TERMINATION

Nickel/Lead-Free solder coating compatible with automatic soldering technologies: reflow, wave soldering, vapor phase and manual.



Thin-Film Low Pass Filter



LP0402N Series Harmonic Lead-Free LGA Termination

DIMENSIONS: millimeters (inches) (Bottom View)

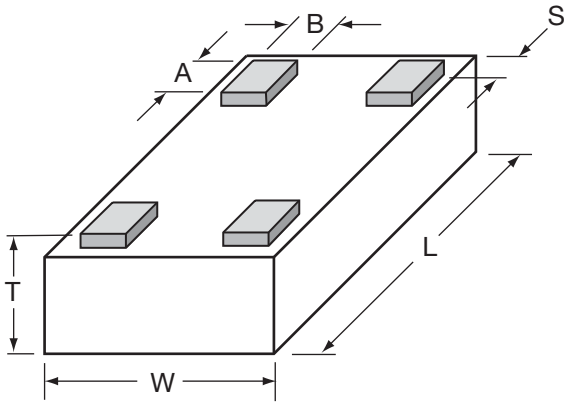

L	1.0±0.05 (0.040±0.002)	A	0.20±0.06 (0.008±0.002)
W	0.58±0.04 (0.023±0.002)	B	0.18±0.05 (0.007±0.002)
T	0.35±0.5 (0.014±0.002)	S	0.05±0.05 (0.002±0.002)

TERMINALS (Top View)

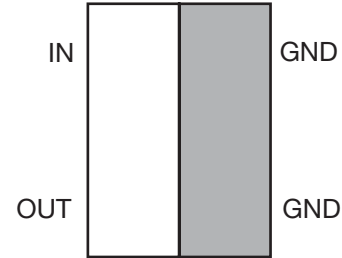

RECOMMENDED PAD LAYOUT (mm)

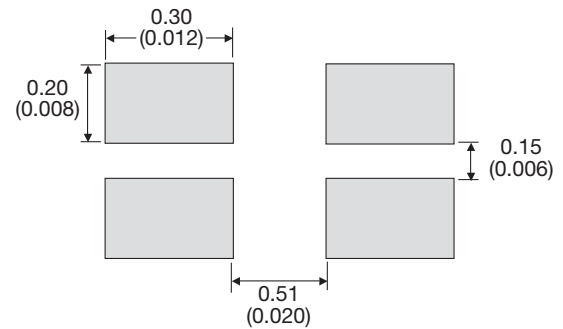

ELECTRICAL CHARACTERISTICS

(Guaranteed over -40°C to $+85^{\circ}\text{C}$ Operating Temperature Range)

P/N	Frequency Band [MHz]	I. Loss [dB]	R. Loss [dB]	Attenuation @ $2x F_0$ [dB]	Attenuation @ $3x F_0$ [dB]
LP0402N2442ANTR	2400-2484	0.35 typ 0.5 max	20	30	17
LP0402N2690ANTR	2640-2740	0.35 typ 0.5 max	20	30	20
LP0402N3500ANTR	3400-3600	0.3 typ 0.5 max	19	30	20
LP0402N5200ANTR	5500-5350	0.2 typ 0.5 max	19	30	20
LP0402N5500ANTR	5350-5650	0.2 typ 0.5 max	15	30	-
LP0402N5800ANTR	5600-6000	0.2 typ 0.5 max	16	25	-

NOTE: Additional Frequencies Available Upon Request



Thin-Film Low Pass Filter



LP0402N Series Harmonic Lead-Free LGA Termination

LP0402N2442ANTR

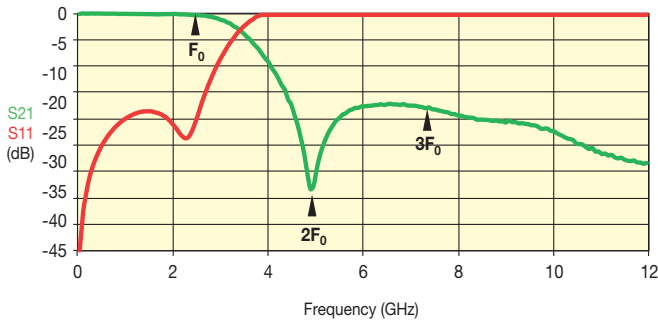

LP0402N5800ANTR

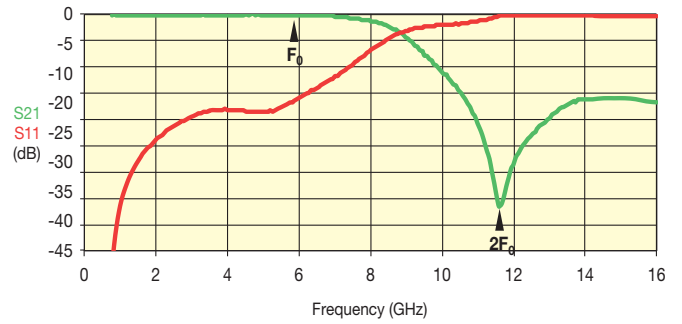

LP0402N2690ANTR

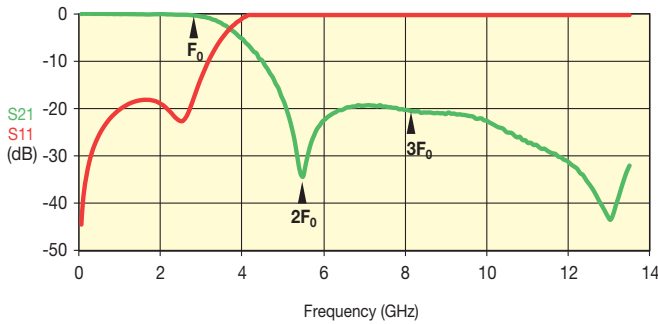

LP0402N3500ANTR

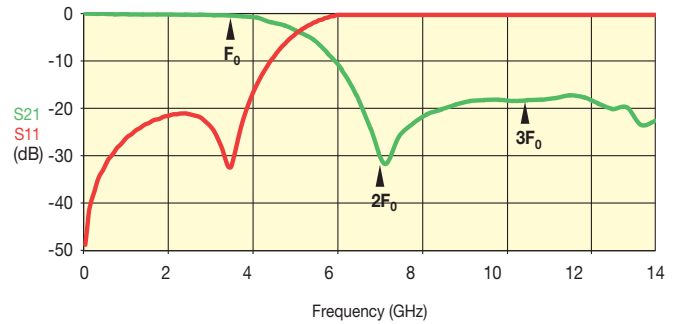

LP0402N5500ANTR

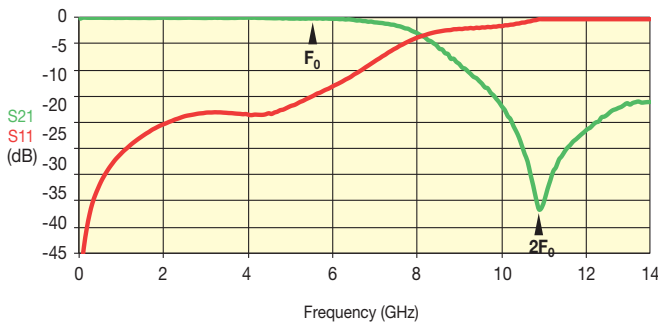

LP0402N5200ANTR

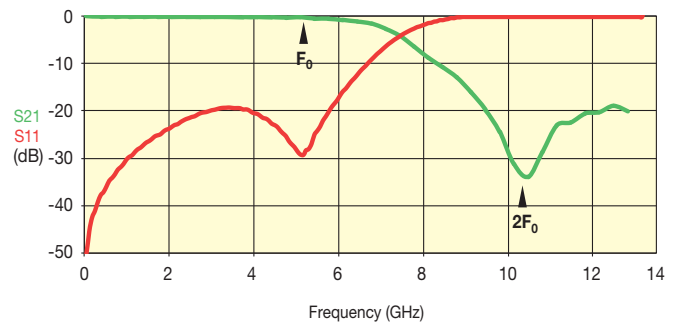

4

Thin-Film Low Pass Filter

LP0402N Series Harmonic Lead-Free LGA Termination Test Jig

TEST JIG FOR LP0402 LOW PASS FILTER

GENERAL DESCRIPTION

These jigs are designed for testing the LP0603 LGA Low Pass Filters using a Vector Network Analyzer.

They consist of a dielectric substrate, having 50Ω microstrips as conducting lines and a bottom ground plane located at a distance of 0.127mm from the microstrips.

The substrate used is Neltec's NH9338ST0127C1BC (or similar).

The connectors are SMA type (female), 'Johnson Components Inc.' Product P/N: 142-0701-841 (or similar).

Both a measurement jig and a calibration jig are provided.

The calibration jig is designed for a full 2-port calibration, and consists of an open line, short line and through line. LOAD calibration can be done by a 50Ω SMA termination.

MEASUREMENT PROCEDURE

Follow the VNA's instruction manual and use the [calibration jig](#) to perform a full 2-Port calibration in the required bandwidths.

Solder the filter to the [measurement jig](#) as follows:

- | | | | |
|-----------------|---------------------|--------------|-------------|
| Input (Filter) | ➔ Connector 1 (Jig) | GND (Filter) | ➔ GND (Jig) |
| Output (Filter) | ➔ Connector 2 (Jig) | GND (Filter) | ➔ GND (Jig) |

Set the VNA to the relevant frequency band. Connect the VNA using a 10dB attenuator on the jig terminal connected to port 2 (using an RF cable).

Measurement

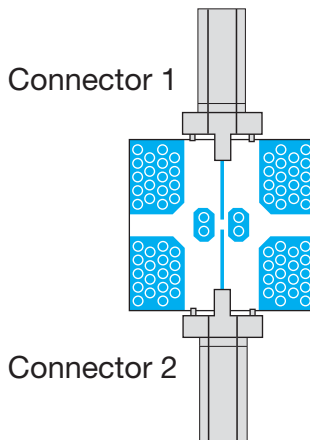

Calibration Jig

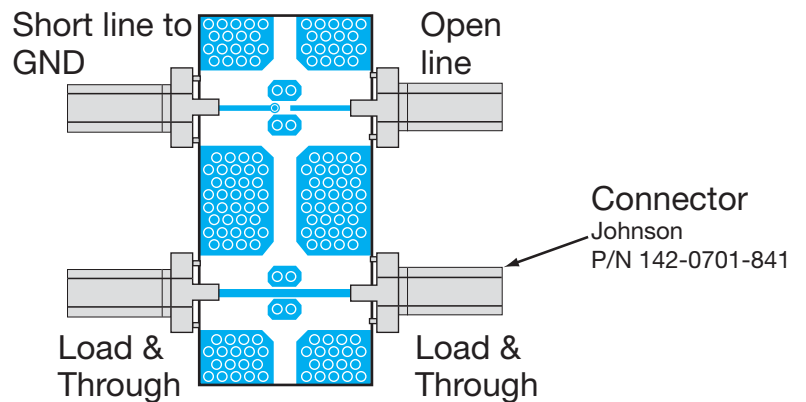

4

Thin-Film Low Pass Filter



LP0603 Lead-Free LGA Type

GENERAL DESCRIPTION

The LP0603 ITF (Integrated Thin Film) Lead-Free LGA Low Pass Filter is based on thin-film multilayer technology. The technology provides a miniature part with excellent high frequency performance and rugged construction for reliable automatic assembly.

The ITF Low Pass Filters are offered in a variety of frequency bands compatible with various types of high frequency wireless systems.

FEATURES

- Miniature Size: 0603
- Frequency Range: 900MHz-5.5GHz
- Characteristic Impedance: 50 Ohm
- Operating/Storage Temperature: -40°C to +85°C
- Power Rating: 3W Continuous
- Low Profile
- Rugged Construction
- Lead Free
- Taped and Reeled

APPLICATIONS

- Mobile communications
- Satellite TV receivers
- GPS
- Vehicle location systems
- Wireless LANs
- RFID

LAND GRID ARRAY ADVANTAGES

- Inherent Low Profile
- Self Alignment during Reflow
- Excellent Solderability
- Low Parasitics
- Better Heat Dissipation

HOW TO ORDER

LP
T
Style

0603
T
Size
0603

A
T
Type
A or N

XXXX
T
Frequency
MHz

A
T
Sub-Type

N
T
Termination
LGA
**Ni/Lead Free Solder

TR
T
Taped & Reeled

**RoHS compliant

FINAL QUALITY INSPECTION

Finished parts are 100% tested for electrical parameters and visual characteristics. Each production lot is evaluated on a sample basis for:

- Static Humidity: 85°C, 85% RH, 160 hours
- Endurance: 125°C, IR, 4 hours

TERMINATION

Nickel/Lead-Free Solder coating compatible with automatic soldering technologies: reflow, wave soldering, vapor phase and manual.



Thin-Film Low Pass Filter



LP0603 Lead-Free LGA Type

DIMENSIONS: millimeters (inches) (Bottom View)

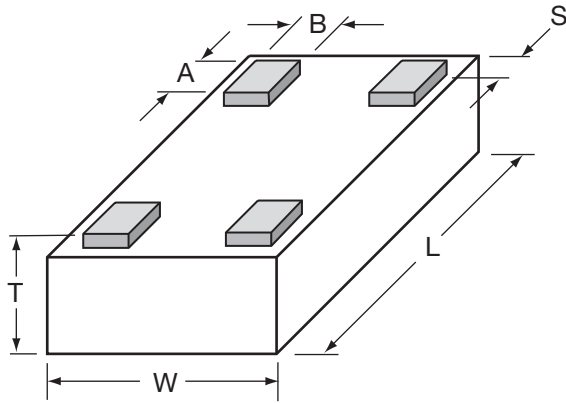

L	1.6±0.1 (0.063±0.004)	A	0.25±0.05 (0.010±0.002)
W	0.84±0.1 (0.033±0.004)	B	0.20±0.05 (0.008±0.002)
T	0.60±0.1 (0.024±0.004)	S	0.05±0.05 (0.002±0.002)

TERMINALS AND ORIENTATION IN TAPE (Top View)

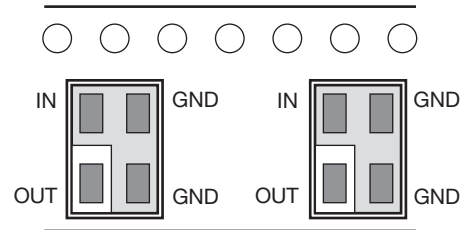

RECOMMENDED PAD LAYOUT (mm)

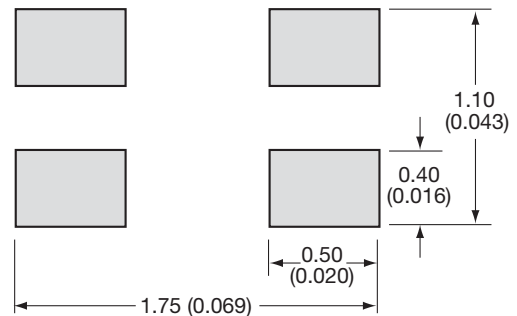

ELECTRICAL CHARACTERISTICS

(Guaranteed over -40°C to $+85^{\circ}\text{C}$ Operating Temperature Range)

P/N	Frequency Band [MHz]	I. Loss [dB]	VSWR max [dB]	Attenuation typ. [dB]
LP0603A0902ANTR	890-915	0.35 typ (0.5 max)	1.4	25 @ 2xF ₀ 14 @ 3xF ₀
LP0603A0947ANTR	935-960	0.35 typ (0.5 max)	1.4	25 @ 2xF ₀ 17 @ 3xF ₀
LP0603A1747ANTR	1710-1785	0.3 typ (0.5 max)	1.4	25 @ 2xF ₀ 17 @ 3xF ₀
LP0603A1842ANTR	1805-1880	0.3 typ (0.5 max)	1.4	27 @ 2xF ₀ 15 @ 3xF ₀
LP0603A1880ANTR	1840-1920	0.3 typ (0.5 max)	1.4	25 @ 2xF ₀ 17 @ 3xF ₀
LP0603A1950ANTR	1920-1980	0.3 typ (0.5 max)	1.4	27 @ 2xF ₀ 15 @ 3xF ₀
LP0603A2140ANTR	2110-2170	0.3 typ (0.5 max)	1.4	27 @ 2xF ₀ 17 @ 3xF ₀
LP0603A2442ANTR	2412-2472	0.3 typ (0.5 max)	1.4	25 @ 2xF ₀ 17 @ 3xF ₀
LP0603N3500ANTR	3400-3600	-0.3 typ. -0.5 max.	1.4	30 @ 2xF ₀ 20 @ 3xF ₀
LP0603N5200ANTR	5050-5350	-0.2 typ. -0.5 max.	1.4	30 @ 2xF ₀ 20 @ 3xF ₀
LP0603N5500ANTR	5350-5650	-0.2 typ. -0.5 max.	1.4	30 @ 2xF ₀ 20 @ 3xF ₀

NOTE: Additional Frequencies Available Upon Request

Thin-Film Low Pass Filter

LP0603 Lead-Free LGA Type

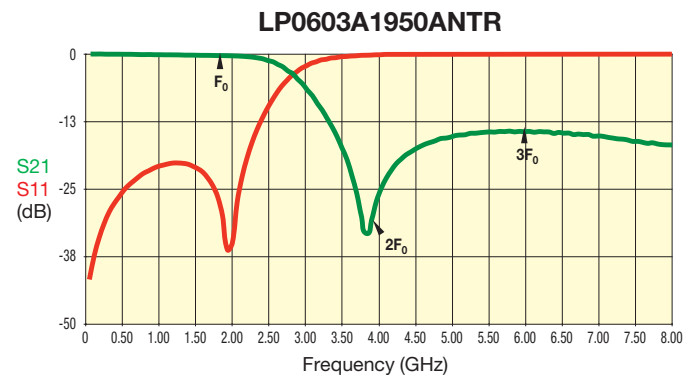
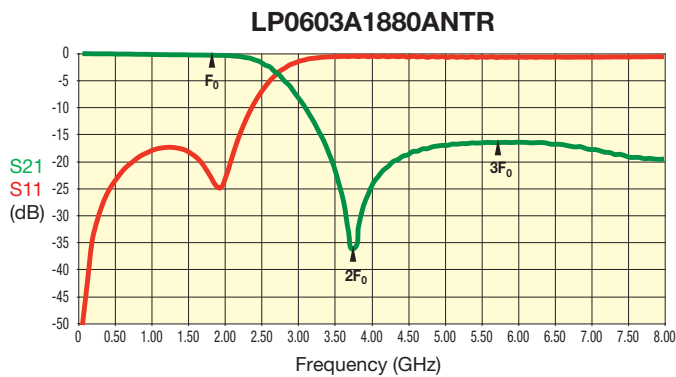
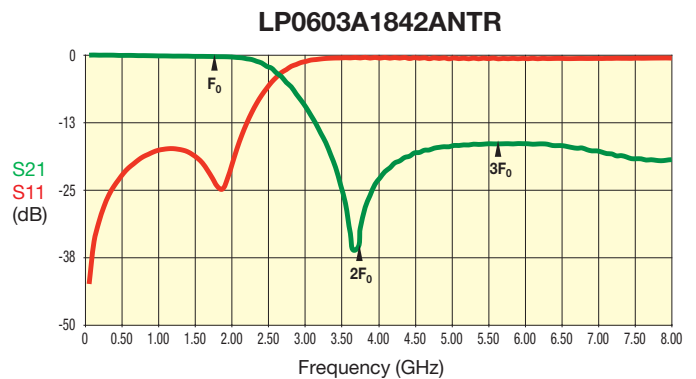
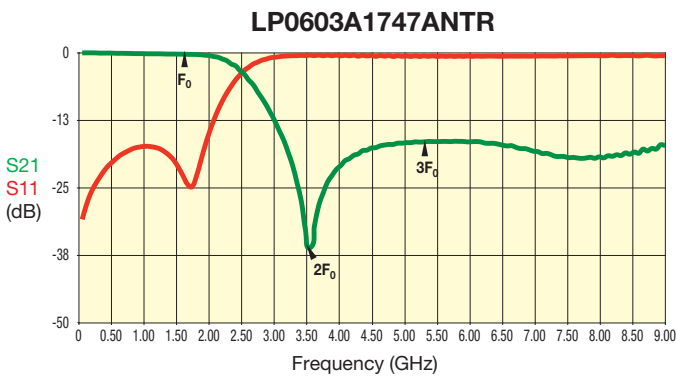
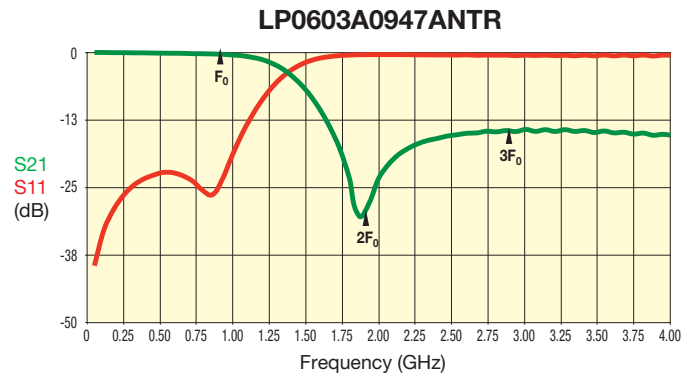
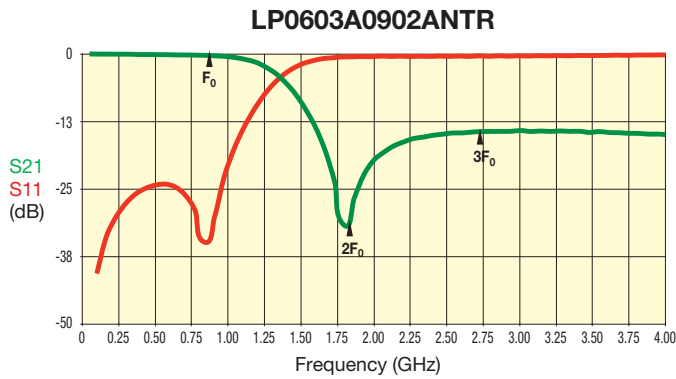

4

Thin-Film Low Pass Filter

LP0603 Lead-Free LGA Type



LP0603A2140ANTR

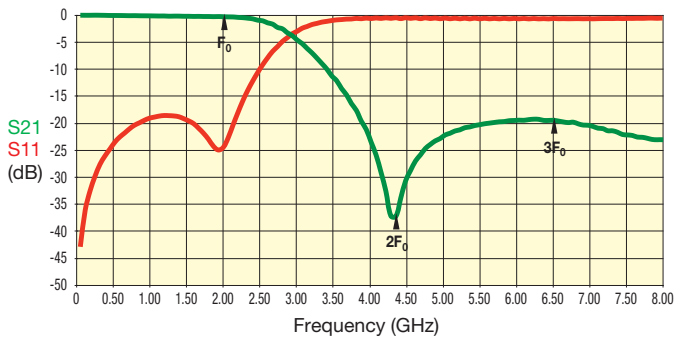

LP0603A2442ANTR

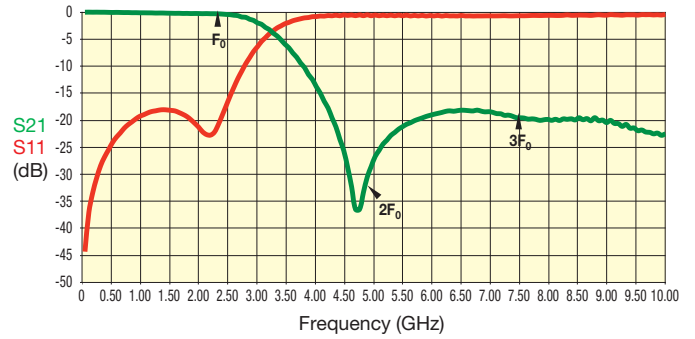

LP0603N3500ANTR

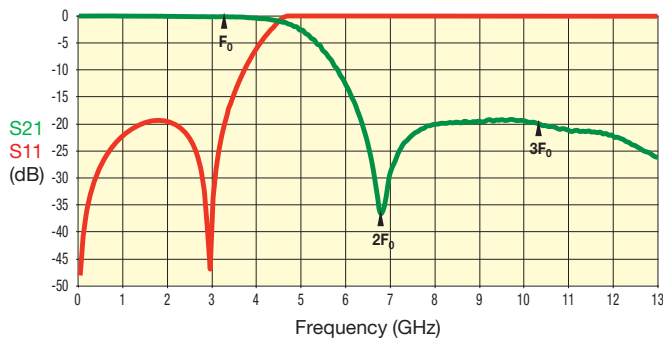

LP0603N5200ANTR

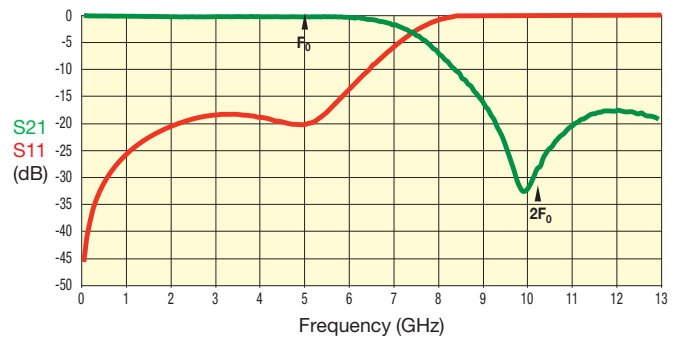

LP0603N5500ANTR

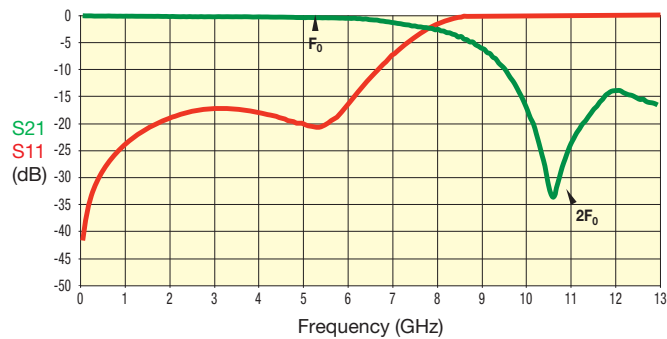

4

Thin-Film Low Pass Filter

LP0603 Lead-Free LGA Type Test Jig

TEST JIG FOR LP0603 LEAD-FREE LGA LOW PASS FILTER

GENERAL DESCRIPTION

These jigs are designed for testing the LP0603 LGA Low Pass Filters using a Vector Network Analyzer.

They consist of a dielectric substrate, having 50Ω microstrips as conducting lines and a bottom ground plane located at a distance of 0.127mm from the microstrips.

The substrate used is Neltec's NH9338ST0127C1BC (or similar).

The connectors are SMA type (female), 'Johnson Components Inc.' Product P/N: 142-0701-841 (or similar).

Both a measurement jig and a calibration jig are provided.

The calibration jig is designed for a full 2-port calibration, and consists of an open line, short line and through line. LOAD calibration can be done by a 50Ω SMA termination.

MEASUREMENT PROCEDURE

Follow the VNA's instruction manual and use the [calibration jig](#) to perform a full 2-Port calibration in the required bandwidths.

Solder the filter to the [measurement jig](#) as follows:

- | | | | |
|-----------------|---------------------|--------------|-------------|
| Input (Filter) | ➔ Connector 1 (Jig) | GND (Filter) | ➔ GND (Jig) |
| Output (Filter) | ➔ Connector 2 (Jig) | GND (Filter) | ➔ GND (Jig) |

Set the VNA to the relevant frequency band. Connect the VNA using a 10dB attenuator on the jig terminal connected to port 2 (using an RF cable).

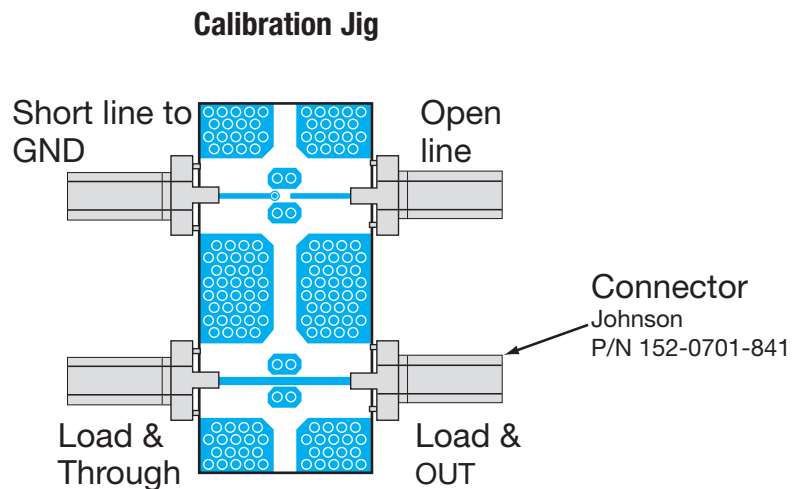
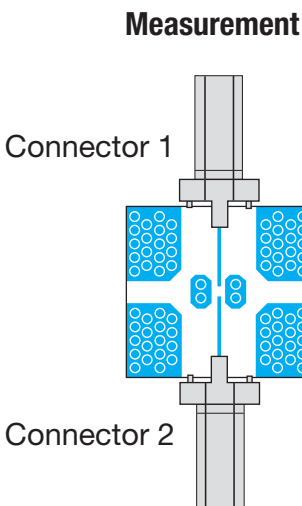

Thin-Film Low Pass Filter



LP0805 Type Harmonic

GENERAL DESCRIPTION

The ITF (Integrated Thin-Film) SMD Filter is based on thin-film multilayer technology. The technology provides a miniature part with excellent high frequency performance and rugged construction for reliable automatic assembly.

The ITF Filter is offered in a variety of frequency bands compatible with various types of high frequency wireless systems.

FEATURES

- Small Size: 0805
- Frequency Range: 800MHz - 3.5GHz
- Characteristic Impedance: 50Ω
- Operating / Storage Temp.: -40°C to +85°C
- Power Rating: 3W Continuous
- Low Profile
- Rugged Construction
- Taped and Reeled

APPLICATIONS

- Mobile Communications
- Satellite TV Receivers
- GPS
- Vehicle Location Systems
- Wireless LAN's

DIMENSIONS: millimeters (inches)

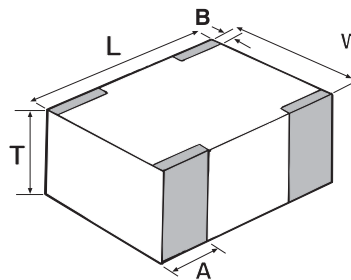

L	2.03±0.1 (0.080±0.004)
W	1.55±0.1 (0.061±0.004)
T	1.02±0.1 (0.040±0.004)
A	0.56±0.25 (0.022±0.010)
B	0.35±0.15 (0.014±0.006)

PAD LAYOUT

See CP0805 pad layout on page 64.

FINAL QUALITY INSPECTION

Finished parts are 100% tested for electrical parameters and visual/mechanical characteristics. Each production lot is evaluated on a sample basis for:

- Static Humidity: 85°C, 85% RH, 160 hours
- Endurance: 125°C, I_R 4 hours

TERMINATION

Nickel/Solder coating (Sn, Pb) compatible with automatic soldering technologies: reflow, wave soldering, vapor phase and manual.

HOW TO ORDER

LP
T
Style
Low Pass

0805A
T
Size
0805

0902
T
Frequency
MHz

AW
T
Termination
AW= Nickel/Solder (SnPb)
**AS = Nickel/ Lead Free
Solder (Sn100)

TR
T
Packaging Code
TR = Tape and Reel

**RoHS compliant

Not RoHS Compliant



TERMINALS AND LAYOUT (Top View)

Orientation in Tape

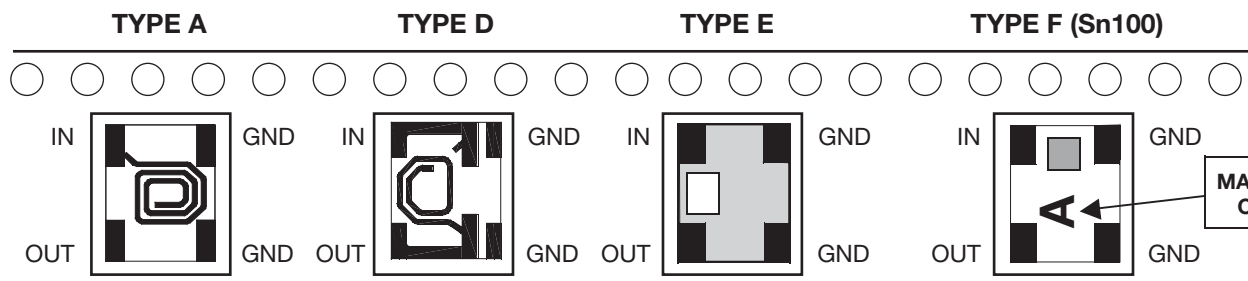

For RoHS compliant products,
please select correct termination style.

Thin-Film Low Pass Filter



LP0805 Type Harmonic

ELECTRICAL CHARACTERISTICS

Application	Part Number	Frequency Band (MHz)	I. Loss max	VSWR max	Attenuation (dB) Typical	Layout Type (SnPb)	Layout Type F Marking Code
E-GSM	LP0805A0897AS	880 - 915	0.4dB (0.3dB typ)	1.7	30 @ 2X F_o 20 @ 3X F_o	A	E
	LP0805A0942AS	925 - 960				A	F
GSM	LP0805A0902AS	890 - 915				A	E
	LP0805A0947AS	935 - 960				A	F
LP0805A1119AS	1101 - 1137	A				H	
	LP0805A0836AS	824 - 849				A	A
AMPS	LP0805A0881AS	869 - 894				A	C
	LP0805A1747AS	1710 - 1785				D	I
PCN	LP0805A1842AS	1805 - 1880				D	J
	LP0805A1880AS	1850 - 1910				D	K
PCS	LP0805A1960AS	1930 - 1990				D	M
	LP0805A1907AS	1895 - 1920				D	L
PHP	LP0805A1890AS	1880 - 1900				D	K
DECT	LP0805A1890AS	1880 - 1900				D	K
3G	LP0805A2150AS	1905 - 2180				D	N
Wireless LAN	LP0805A2442AS	2400 - 2484				D	S
WLL	LP0805A3500AS	3400 ~ 3600	E	X			

Typical Electrical Performance

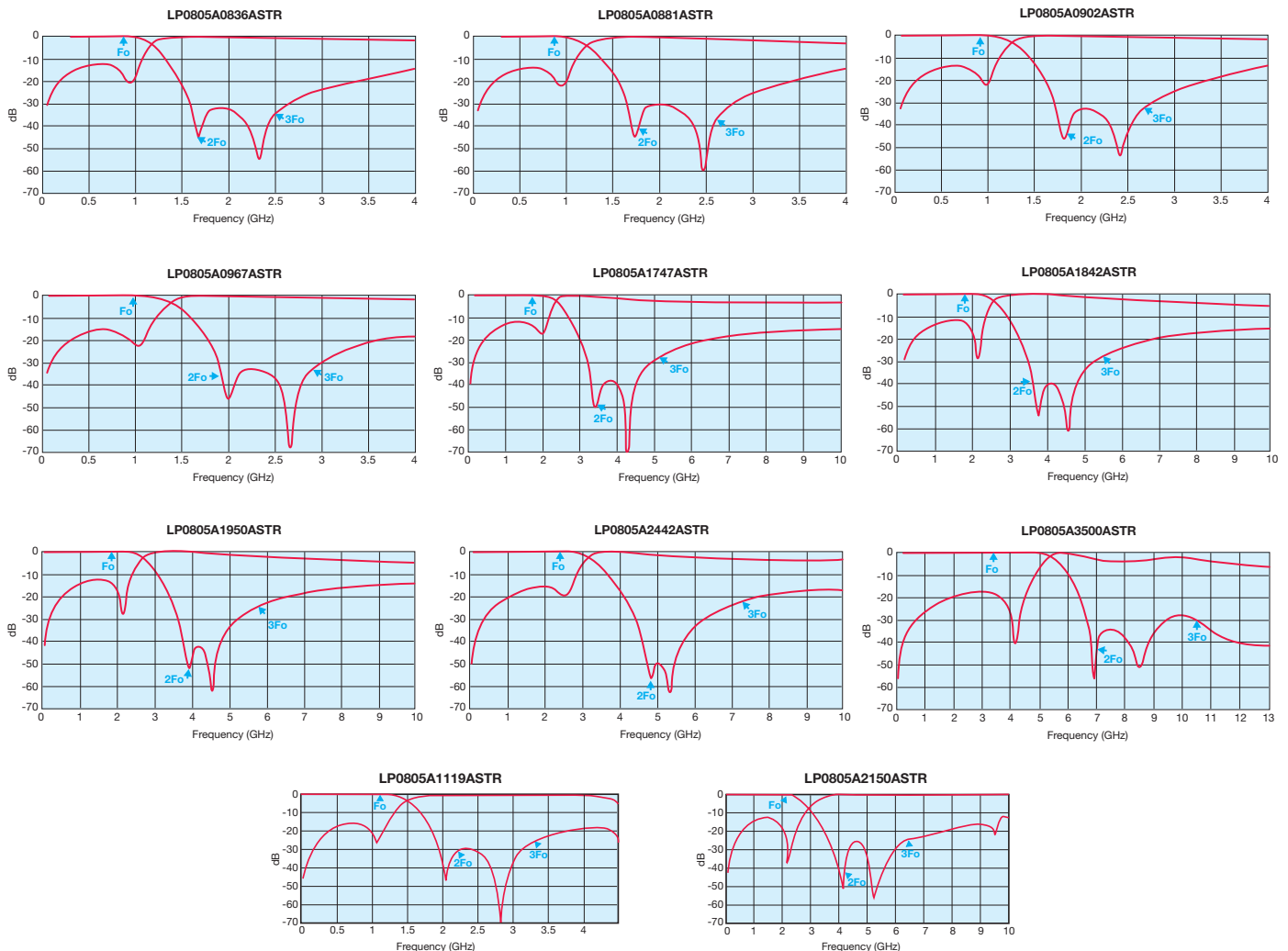

4

Thin-Film Low Pass Filter

LP0805 Test Jig

ITF TEST JIG FOR LOW PASS FILTER 0805

GENERAL DESCRIPTION

These jigs are designed for testing the LPF0805 Low Pass Filters using a Vector Network Analyzer.

They consist of a dielectric substrate, having 50W microstrips as conducting lines and a bottom ground plane located at a distance of 0.254 mm from the microstrips.

The substrate used is RF-35-0100-C1B107 (or similar).

The connectors are SMA type (female), 'Johnson Components Inc.' Product P/N: 142-0701-841(or similar).

Both a measurement jig and a calibration jig are provided.

The calibration jig is designed for a full 2-port calibration, and consists of an open line, short line and through line. LOAD calibration can be done by a 50W SMA termination.

MEASUREMENT PROCEDURE

Follow the VNA's instruction manual and use the [calibration jig](#) to perform a full 2-Port calibration in the required bandwidths.

Solder the filter to the [measurement jig](#) as follows:

Input (Filter) ➔ Connector 1 (Jig) GND (Filter) ➔ GND (Jig)

Output (Filter) ➔ Connector 2 (Jig) GND (Filter) ➔ GND (Jig)

Set the VNA to the relevant frequency band. Connect the VNA using a 10dB attenuator on the jig terminal connected to port 2 (using an RF cable).

Measurement

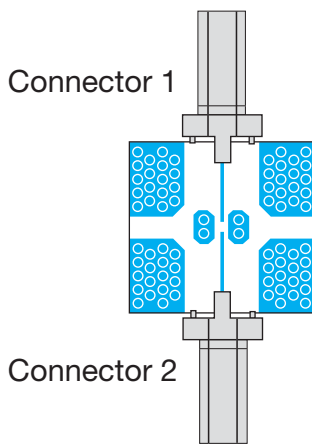

Calibration Jig

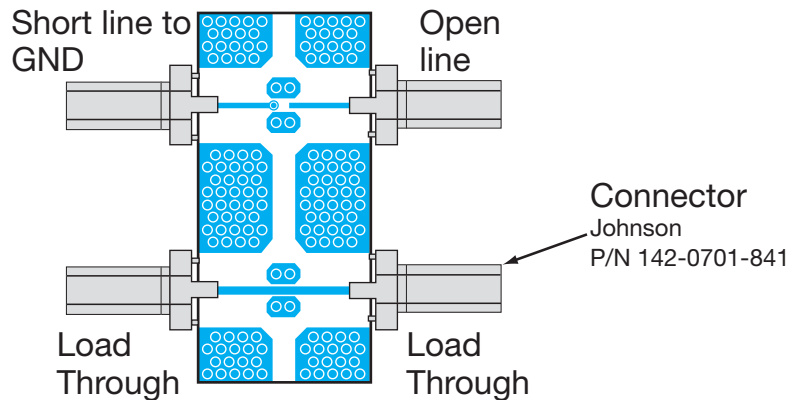

4

High Performance Harmonic Low Pass Filter



LP1206A0512BNTR



ITF TECHNOLOGY

The ITF LGA Filter is based on thin-film multilayer technology. The technology provides a miniature part with excellent high frequency performance and rugged construction for reliable automatic assembly. The ITF Filter is offered in a variety of frequency bands compatible with various types of high frequency wireless systems.

FEATURES

- Small size: 1206
- Frequency: 512MHz
- Characteristic impedance: 50Ω
- Operating/Storage temp: -40°C to +85°C
- Low profile
- Rugged construction
- Taped and reeled
- RoHS compliant

APPLICATIONS

- Mobile communications
- Satellite TV receivers
- GPS
- Vehicle location systems
- Wireless LAN's

HOW TO ORDER

LP 1206 **A** **XXXX** **B** **N** **TR**
 Type Frequency (MHz) Sub-Type Termination Taped & Reeled

FINAL QUALITY INSPECTION

Finished parts are 100% tested for electrical parameters and visual/mechanical characteristics. Each production lot is evaluated on a sample basis for:

- Static Humidity: 85°C, 85% RH, 160 hours
- Endurance: 125°C, I_B, 4 hours



TERMINATION

Nickel/ Lead free Solder coating (Sn100) compatible with automatic soldering technologies: reflow, wave soldering, vapor phase and manual.

POWER RATING

3W RF Continuous

ORIENTATION IN TAPE

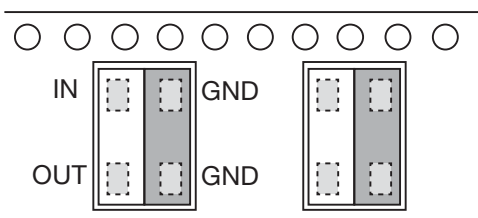

DIMENSIONS (Bottom View)

mm (inches)

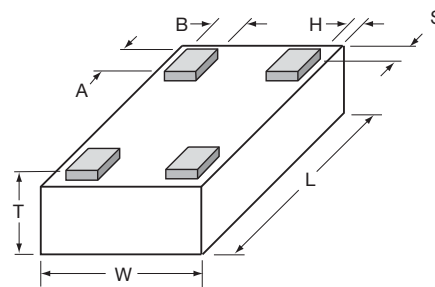

L	3.10±0.10 (0.122±0.004)
W	1.60±0.10 (0.063±0.004)
T	0.60±0.30 (0.024±0.012)
A	0.39±0.10 0.015±0.004
B	0.33±0.10 0.013±0.004
H, S	0.05±0.05 (0.002±0.002)

TERMINALS (Top View)

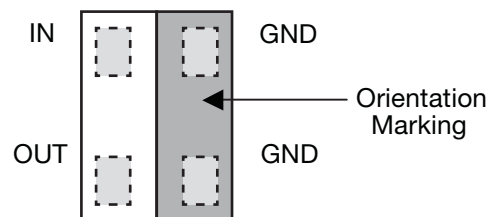

Recommended Pad Layout Dimensions mm (inches)

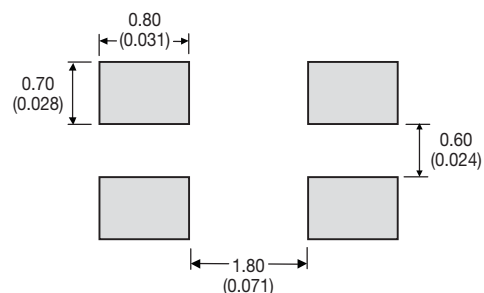

High Performance Harmonic Low Pass Filter



LP1206A0512BNTR

TERMINALS (Top View)

Parameter	Value	Unit	Notes
Fc	512	MHz	
Rejection @ 900MHz	-35	dB	Min. (720MHz to 2GHz)
Insertion Loss	0.8	dB	Max.
VSWR	2.3: 1		Max. (all ports)
Power Handling	3	W	Continuous
Impedance	50	Ohm	
Operating Temp.	-40 to +85	°C	
Size	1206		

TYPICAL ELECTRICAL PERFORMANCE

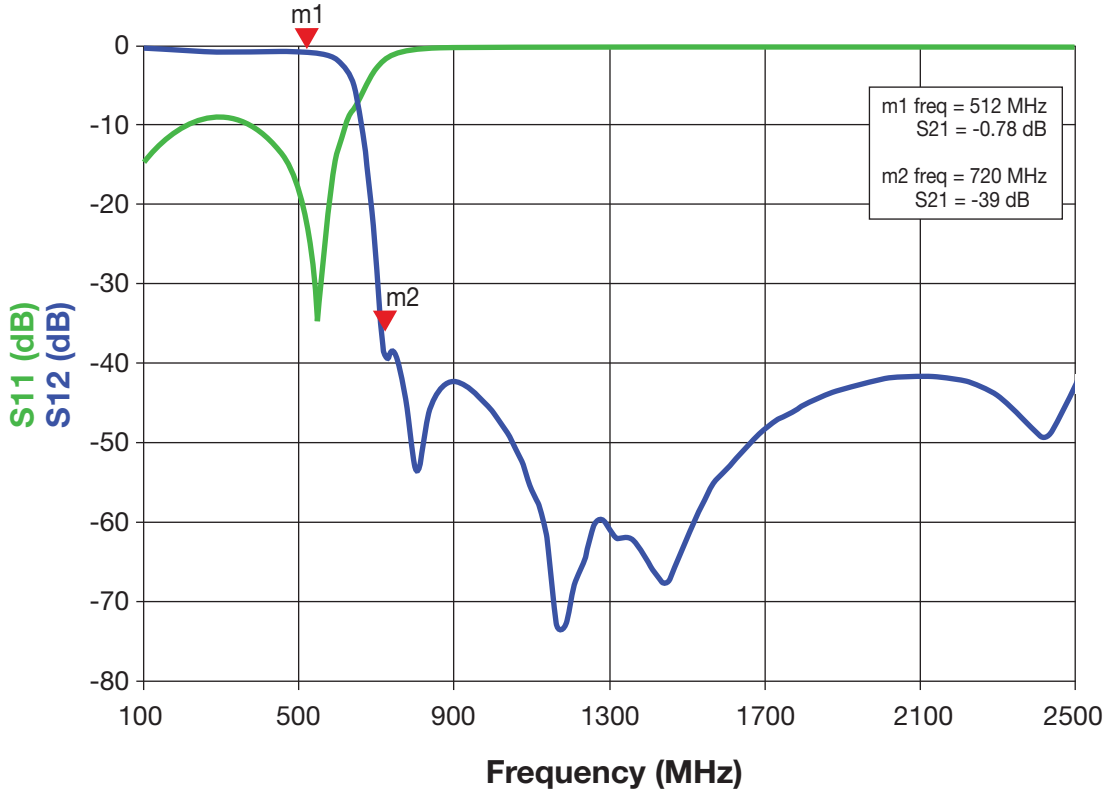

4



High Performance Low Pass Filter



LP1206A0700ANTR



ITF TECHNOLOGY

The ITF LGA Filter is based on thin-film multilayer technology. The technology provides a miniature part with excellent high frequency performance and rugged construction for reliable automatic assembly. The ITF Filter is offered in a variety of frequency bands compatible with various types of high frequency wireless systems.

FEATURES

- Small size: 1206
- Frequency: 700MHz
- Characteristic impedance: 50Ω
- Operating/Storage temp: -40°C to +85°C
- Low profile
- Rugged construction
- Taped and reeled
- RoHS compliant

APPLICATIONS

- Mobile communications
- Satellite TV receivers
- GPS
- Vehicle location systems
- Wireless LAN's

HOW TO ORDER

LP 1206 **A** **XXXX** **A** **N** **TR**
 Type Frequency (MHz) Sub-Type Termination Taped & Reeled



FINAL QUALITY INSPECTION

Finished parts are 100% tested for electrical parameters and visual/mechanical characteristics. Each production lot is evaluated on a sample basis for:

- Static Humidity: 85°C, 85% RH, 160 hours
- Endurance: 125°C, I_B, 4 hours

TERMINATION

Nickel/ Lead free Solder coating (Sn100) compatible with automatic soldering technologies: reflow, wave soldering, vapor phase and manual.

POWER RATING

3W RF Continuous

ORIENTATION IN TAPE

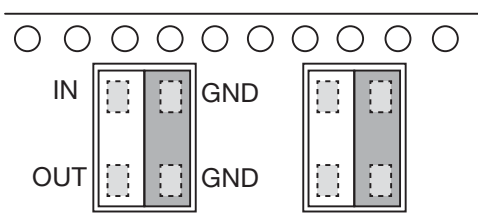

DIMENSIONS (Bottom View)

mm (inches)

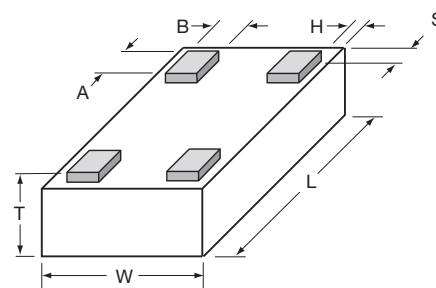

L	3.10±0.10 (0.122±0.004)
W	1.60±0.10 (0.063±0.004)
T	0.60±0.30 (0.024±0.012)
A	0.39±0.10 0.015±0.004
B	0.33±0.10 0.013±0.004
H, S	0.05±0.05 (0.002±0.002)

TERMINALS (Top View)

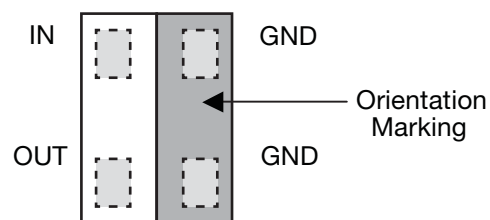

Recommended Pad Layout Dimensions mm (inches)

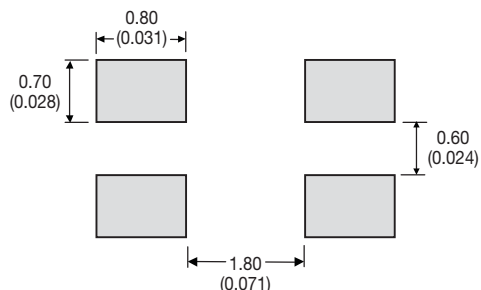

High Performance Low Pass Filter



LP1206A0700ANTR

TERMINALS (Top View)

Parameter	Value	Unit	Notes
Fc	700	MHz	
Rejection @ 900MHz	-35	dB	Min. (900MHz to 2GHz)
Insertion Loss	0.9	dB	Max.
VSWR	2.3: 1		Max. (all ports)
Power Handling	3	W	Continuous
Impedance	50	Ohm	
Operating Temp.	-40 to +85	°C	
Size	1206		

TYPICAL ELECTRICAL PERFORMANCE

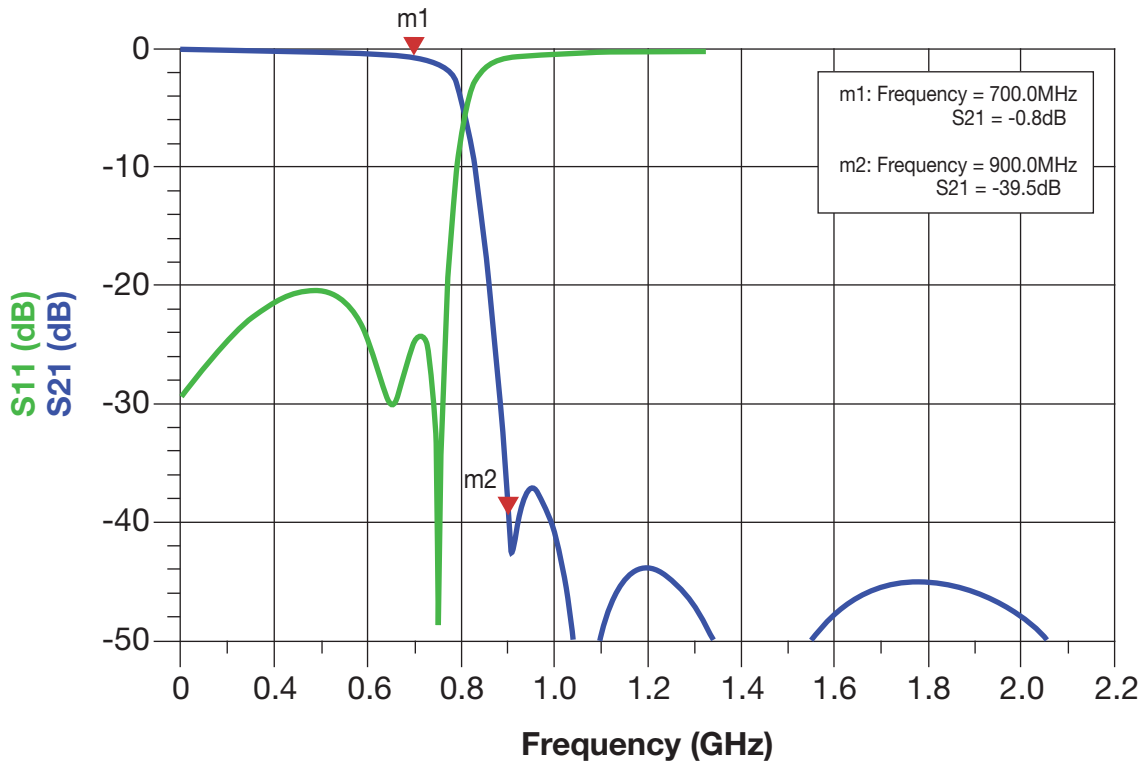



Thin-Film RF/Microwave Products Designer Kits

Accu-P[®]/Accu-L[®] Kits

RF/Microwave Thin-Film Products



Designer Kits *(Special Kits Available Upon Request)*

Accu-P®
Designer Kit Type 1700LF
Order Number: Accu-P®0201KITL2

Volts	Capacitors Value (pF)	Tolerance
100	0.1	P
	0.2	P
	0.3	P
	0.4	P
	0.5	P
50	0.6	P
	0.7	P
	0.8	P
	0.9	P
	1.0	P
	1.1	A
	1.2	A
	1.3	A
	1.5	A
	25	1.8
2.0		B
2.2		B
2.4		B
2.7		B
3.0		B
3.3		B
3.6		B
3.9		B
4.7		B
5.6		B
6.8		B
16	7.5	B
	8.2	B
	10.0	G
	12.0	G

600 Capacitors, 20 each of 30 values
Tolerance P = ±0.02pF A = ±0.05pF
B = ±0.1pF G = ±2%

Accu-P®
Designer Kit Type 1800LF
Order Number: Accu-P®0201KITL3

Volts	Capacitors Value (pF)	Tolerance
50	1.0	A
	1.1	A
	1.2	A
	1.3	A
	1.4	A
	1.5	A
	1.6	A
25	1.7	A
	1.8	A
	1.9	A
	2.0	A
	2.1	B
	2.2	B
	2.3	B
	2.4	B
	2.5	B
	2.6	B
	2.7	B
	2.8	B
	2.9	B
3.0	B	
3.1	B	
3.3	B	
3.4	B	
3.6	B	
3.9	B	
4.1	B	
4.3	B	
4.5	B	
4.7	B	

600 Capacitors, 20 each of 30 values
Tolerance A = ±0.05pF
B = ±0.1pF

Accu-P®
Designer Kit Type 1300LF
Order Number: Accu-P®0402KITL1

Volts	Capacitors Value (pF)	Tolerance
100	0.1	P
	0.2	P
	0.3	P
	0.4	P
	0.5	P
	0.6	P
	0.7	P
	0.8	P
	0.9	P
	1.0	P
	1.1	A
	1.2	A
	1.5	A
50	1.8	A
	2.0	A
	2.2	B
	2.4	B
	2.7	B
	3.0	B
	3.3	B
	3.9	B
	4.7	B
	5.6	B
25	6.8	B
	8.2	B
	10.0	G
	12.0	G
	15.0	G
16	18.0	G
	22.0	G

600 Capacitors, 20 each of 30 values
Tolerance P = ±0.02pF A = ±0.05pF
B = ±0.1pF G = ±2%

Accu-P®
Designer Kit Type 1400LF
Order Number: Accu-P®0402KITL2

Volts	Capacitors Value (pF)	Tolerance
100	1.0	A
	1.1	A
	1.2	A
	1.3	A
	1.4	A
	1.5	A
	1.6	A
	1.7	A
	1.8	A
	50	1.9
2.0		A
2.1		B
2.2		B
2.3		B
2.4		B
2.5		B
2.6		B
2.7		B
2.8		B
2.9		B
3.0		B
3.1		B
3.3		B
3.4		B
3.6		B
3.9		B
4.1		B
4.3		B
4.5	B	
4.7	B	

600 Capacitors, 20 each of 30 values
Tolerance A = ±0.05pF
B = ±0.1pF

Accu-P®
Designer Kit Type 900LF
Order Number: Accu-P®0603KITL1

Volts	Capacitors Value (pF)	Tolerance
100	0.1	A
	0.2	A
	0.3	A
	0.4	B
	0.5	B
	0.6	B
	0.7	B
	0.8	B
	0.9	B
	1.0	B
	1.1	B
	1.2	B
	1.5	B
	1.8	B
	2.0	B
	2.2	B
	2.4	B
	2.7	B
	50	3.0
3.3		B
3.9		B
4.7		B
5.6		B
6.8		B
8.2		B
10.0		G
12.0		G
15.0		G
25	18.0	G
	22.0	G

600 Capacitors, 20 each of 30 values
Tolerance A = ±0.05pF
B = ±0.1pF
G = ±2%

Accu-P®
Designer Kit Type 800LF
Order Number: Accu-P®0805KITL2

Volts	Capacitors Value (pF)	Tolerance
100	0.1	A
	0.2	A
	0.3	A
	0.4	A
	0.5	B
	0.7	B
	0.8	B
	0.9	B
	1.0	B
	1.2	B
	1.5	B
	1.8	B
	2.0	B
	2.2	B
	50	2.7
3.3		B
3.9		B
4.7		B
5.6		B
6.8		B
8.2		B
10.0		G
12.0		G
15.0		G
25	18.0	G
	22.0	G
	27.0	J
	33.0	J
	39.0	J
47.0	J	

300 Capacitors, 10 each of 30 values
Tolerance A = ±0.05pF G = ±2%
B = ±0.1pF J = ±5%

Accu-P®
Designer Kit Type 2800LF
Order Number: Accu-P®0201KITL5

Volts	Capacitors Value (pF)	Tolerance	
100	0.05	Z	
	0.10	Z	
	0.15	Z	
	0.20	Z	
	0.25	Z	
	0.30	Z	
	0.35	Z	
	0.40	Z	
	0.45	Z	
	0.50	Z	
	50	0.55	P
		0.60	P
		0.65	P
0.70		P	
0.75		P	
0.80		P	
0.85		P	
0.90		P	
0.95		P	
1.0		P	
1.1		P	
1.2		P	
1.3		P	
1.4		P	
1.5		P	
25	1.6	P	
	1.7	P	
	1.8	P	
	1.9	P	
	2.0	P	

600 Capacitors, 20 each of 30 values
Tolerance Z = ±0.01pF
P = ±0.02pF

Accu-P®
Designer Kit Type 2700LF
Order Number: Accu-P®0402KITL4

Volts	Capacitors Value (pF)	Tolerance
100	0.05	Z
	0.10	Z
	0.15	Z
	0.20	Z
	0.25	Z
	0.30	Z
	0.35	Z
	0.40	Z
	0.45	Z
	0.50	Z
	0.55	P
	0.60	P
	0.65	P
	0.70	P
	0.75	P
	0.80	P
	0.85	P
	0.90	P
	50	0.95
1.0		P
1.1		P
1.2		P
1.3		P
1.4		P
1.5		P
1.6		P
1.7		P
1.8		P

600 Capacitors, 20 each of 30 values
Tolerance Z = ±0.01pF
P = ±0.02pF

5



Accu-P®
Designer Kit Type 2200LF
Order Number: Accu-P® 0603KITL2

Volts	Capacitors Value (pF)	Tolerance
100	0.05	P
	0.10	P
	0.15	P
	0.20	P
	0.25	P
	0.30	P
	0.35	P
	0.40	P
	0.45	P
	0.50	P
	0.55	P
	0.60	P
	0.65	P
	0.70	P
	0.75	P

300 Capacitors, 20 each of 15 values
Tolerance P = ± 0.02pF

Accu-P®
Designer Kit Type 700
Order Number: Accu-P® 1210KIT02

Volts	Capacitors Value (pF)	Tolerance
100	1.0	B
	1.5	B
	1.8	B
	2.2	B
	2.7	B
	3.3	B
	4.7	B
	5.6	B
	6.8	B
	10.0	G
	12.0	G
	18.0	G
	22.0	G
	27.0	G
	33.0	G

150 Capacitors, 10 each of 15 values
Tolerance B = ± 0.1pF
 G = ± 2%

Accu-P® 01005
Designer Kit Type 3100LF
Order Number: Accu-P® C005KITL1

Volts	Capacitors Value (pF)	Tolerance
16	0.05	P
	0.1	P
	0.2	P
	0.3	P
	0.4	P
	0.5	P
	0.6	P
	0.7	P
	0.8	P
	0.9	P
	1.0	Q
	1.2	Q
	1.5	Q
	1.8	Q
	2.2	Q

7500 Capacitors, 500 each of 15 values
Tolerance P = ± 0.02pF
 Q = ± 0.03pF

Accu-L® 0201
Designer Kit Type 3200
Order Number: Accu-L® 0201KIT1

Inductance Value (nH)	Tolerance
0.33	A
0.39	A
0.47	A
0.56	A
0.68	A
0.82	A
1.0	A
1.2	A
1.5	B
1.8	B
2.2	B
2.7	B
3.3	B

260 Inductors, 20 each of 13 values
Tolerance A = ±0.05nH
 B = ±0.1nH

Accu-L®
Designer Kit Type 2500
Order Number: Accu-L® L0402KIT01

Inductance Value (nH)	Tolerance
0.82	A
1.0	A
1.2	A
1.5	A
1.8	A
2.2	A
2.7	A
3.3	B
3.9	B
4.7	B
5.6	B
6.8	B

240 Inductors, 20 each of 12 values
Tolerance A = ±0.05nH
 B = ±0.1nH

Accu-L®
Designer Kit Type 1600LF
Order Number: Accu-L® 0603KITL2

Inductance Value (nH)	Tolerance
1.2	C
1.5	C
1.8	C
2.2	C
2.7	C
3.3	C
3.9	C
4.7	C
5.6	C
6.8	C
8.2	C
10	G
12	G
15	G

280 Inductors, 20 each of 14 values
Tolerance C = ±0.2nH
 G = ±2%

Accu-L®
Designer Kit Type 1100LF
Order Number: Accu-L® 0805KITL2

Inductance Value (nH)	Tolerance
1.8	C
2.2	C
2.7	C
3.3	C
3.9	C
4.7	C
5.6	C
6.8	D
8.2	D
10.0	J
12.0	J
15.0	J
18.0	J
22.0	J

280 Inductors, 20 each of 14 values
Tolerance C = ±0.2nH
 D = ±0.5nH
 J = ±5%



Multilayer Organic (MLO™) Technology

MLO™ Capacitors

MLO™ Diplexers

MLO™ Inductors

MLO™ SMT Crossovers

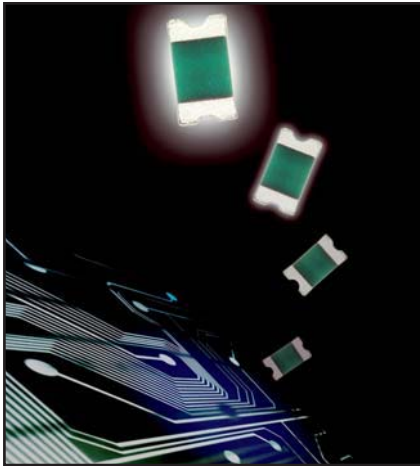

Based on its patented multilayer low loss organic (MLO™) technology. These new capacitors represent a paradigm shift from traditional ceramic and thin film passive SMD components. Multilayer Organic Capacitors (MLOC) are polymer based capacitors that use high conductivity copper interconnects in a multilayer fashion. The ability to fabricate these components on large area substrates and state of the art laser direct imaging allow for improved cost benefits and tolerance control. The end result is a state of the art low ESR and high SRF low profile RF capacitor that can support frequencies well above one GHz. Additionally MLOCs are expansion matched to printed circuit boards to allow for improved reliability.

FEATURES

- Low ESR
- Hi-Q®
- High Self Resonance
- Tight Tolerance
- Low Dielectric Absorption (0.0015%)

APPLICATIONS

- RF Power Amplifiers
- Low Noise Amplifiers
- Filter Networks
- Instrumentation

HOW TO ORDER

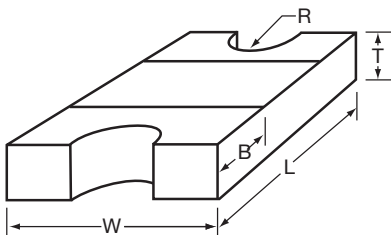
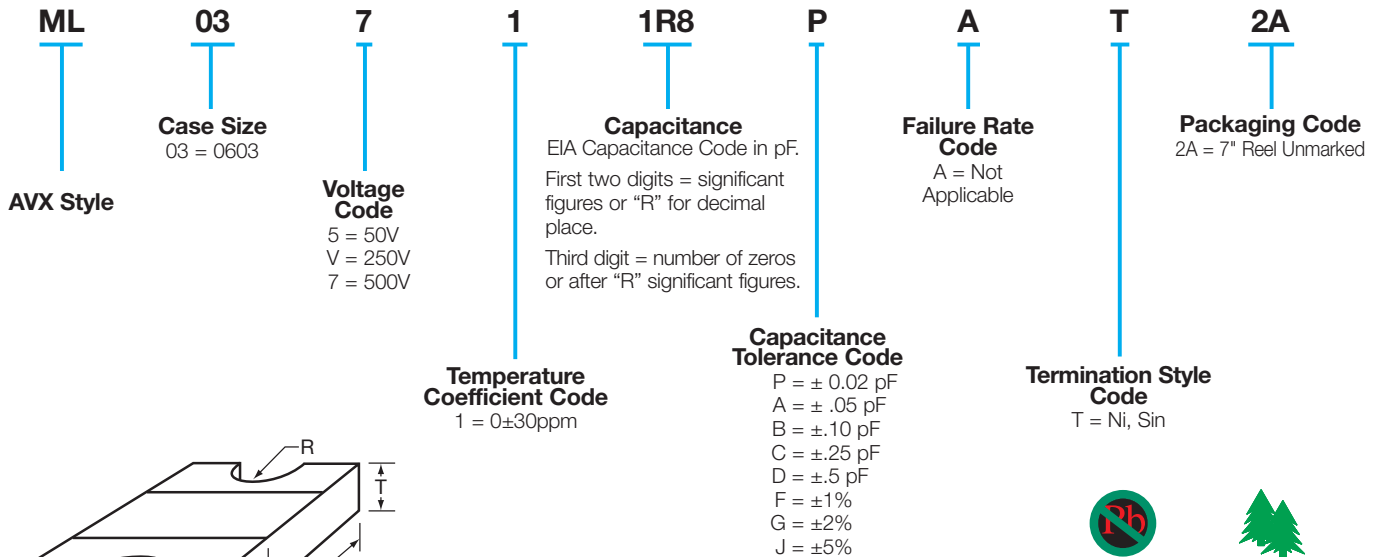

MECHANICAL DIMENSIONS: inches (millimeters)

Case	Length (L)	Width (W)	Thickness (T)	Band Width (B)	Castellation Radius (R)
0603	0.063 ± 0.004 (1.600 ± 0.102)	0.033 ± 0.004 (0.838 ± 0.102)	0.025 ± 0.004 (0.635 ± 0.102)	0.015 ± 0.005 (0.381 ± 0.127)	0.008 ± 0.002 (0.203 ± 0.051)

TAPE & REEL: All tape and reel specifications are in compliance with EIA RS481 (equivalent to IEC 286 part 3).

- 8mm carrier
- 7" reel, 3,000 pcs per reel

ENVIRONMENTAL CHARACTERISTICS

TEST	CONDITIONS	REQUIREMENT
Life (Endurance) MIL-STD-202F Method 108A	125°C, 2U _R , 1000 hours	No visible damage $\Delta C/C \leq 2\%$ for $C \geq 5\text{pF}$ $\Delta C/C \leq 0.25\text{pF}$ for $C < 5\text{pF}$
Accelerated Damp Heat Steady State MIL-STD-202F Method 103B	85°C, 85% RH, U _R , 1000 hours	No visible damage $\Delta C/C \leq 2\%$ for $C \geq 5\text{pF}$ $\Delta C/C \leq 0.25\text{pF}$ for $C < 5\text{pF}$
Temperature Cycling MIL-STD-202F Method 107E MIL-STD-883D Method 1010.7	-55°C to +125°C, 15 cycles – MLO™	No visible damage $\Delta C/C \leq 2\%$ for $C \geq 5\text{pF}$ $\Delta C/C \leq 0.25\text{pF}$ for $C < 5\text{pF}$
Resistance to Solder Heat IEC-68-2-58	260°C ± 5°C for 10 secs.	C remains within initial limits

MECHANICAL SPECIFICATIONS

TEST	CONDITIONS	REQUIREMENT
Solderability IEC-68-2-58	Components completely immersed in a solder bath at 235°C for 2 secs.	Terminations to be well tinned, minimum 95% coverage
Leach Resistance IEC-68-2-58	Components completely immersed in a solder bath at 260±5°C for 60 secs.	Dissolution of termination faces ≤15% of area Dissolution of termination edges ≤25% of length
Adhesion MIL-STD-202F Method 211A	A force of 5N applied for 10 secs.	No visible damage
Termination Bond Strength IEC-68-2-21 Amend. 2	Tested as shown in diagram	No visible damage $\Delta C/C \leq 2\%$ for $C \geq 5\text{pF}$ $\Delta C/C \leq 0.25\text{pF}$ for $C < 5\text{pF}$
Robustness of Termination IEC-68-2-21 Amend. 2	A force of 5N applied for 10 secs.	No visible damage
Storage	12 months minimum with components stored in “as received” packaging	Good solderability

QUALITY & RELIABILITY

MLO™ capacitors utilize high density interconnect wiring technology on well established low loss organic materials.

- Solderability;
- Dimensional, mechanical and temperature stability.

FINAL QUALITY INSPECTION

Finished parts are tested for standard electrical parameters and visual/mechanical characteristics. Each production lot is 100% evaluated for: capacitance and proof voltage at 2.5 U_R. In addition, production is periodically evaluated for:

- Average capacitance with histogram printout for capacitance distribution;
- IR and Breakdown Voltage distribution;
- Temperature Coefficient;

QUALITY ASSURANCE

The reliability of these multilayer organic capacitors has been extensively studied. Various methods and standards have been used to ensure a high quality component including JEDEC, Mil Spec and IPC testing. AVX's quality assurance policy is based on well established international industry standards. The reliability of the capacitors is determined by accelerated testing under the following conditions:

Life (Endurance)	125°C, 2U _R , 1000 hours
Accelerated Damp Heat Steady State	85°C, 85% RH, U _R , 1000 hours.

TABLE I: CASE SIZE ML03

Cap. pF	Cap. Tol.	WVDC	Cap. pF	Cap. Tol.	WVDC	Cap. pF	Cap. Tol.	WVDC
0.1	P, A, B	50, 250, 500	1.3	P, A, B, C	50, 250, 500	3.0	P, A, B, C	50, 250
0.2	P, A, B	50, 250, 500	1.4	P, A, B, C	50, 250, 500	3.3	P, A, B, C	50, 250
0.3	P, A, B	50, 250, 500	1.5	P, A, B, C	50, 250, 500	3.6	P, A, B, C	50, 250
0.4	P, A, B	50, 250, 500	1.6	P, A, B, C	50, 250, 500	3.9	P, A, B, C	50, 250
0.5	P, A, B, C	50, 250, 500	1.7	P, A, B, C	50, 250, 500			
0.6	P, A, B, C	50, 250, 500	1.8	P, A, B, C	50, 250, 500			
0.7	P, A, B, C	50, 250, 500	1.9	P, A, B, C	50, 250, 500			
0.8	P, A, B, C	50, 250, 500	2.0	P, A, B, C	50, 250, 500			
0.9	P, A, B, C	50, 250, 500	2.2	P, A, B, C	50, 250, 500			
1.0	P, A, B, C	50, 250, 500	2.4	P, A, B, C	50, 250, 500			
1.1	P, A, B, C	50, 250, 500	2.5	P, A, B, C	50, 250, 500			
1.2	P, A, B, C	50, 250, 500	2.7	P, A, B, C	50, 250			

Typical ESR vs. Frequency
MLO™ 0603

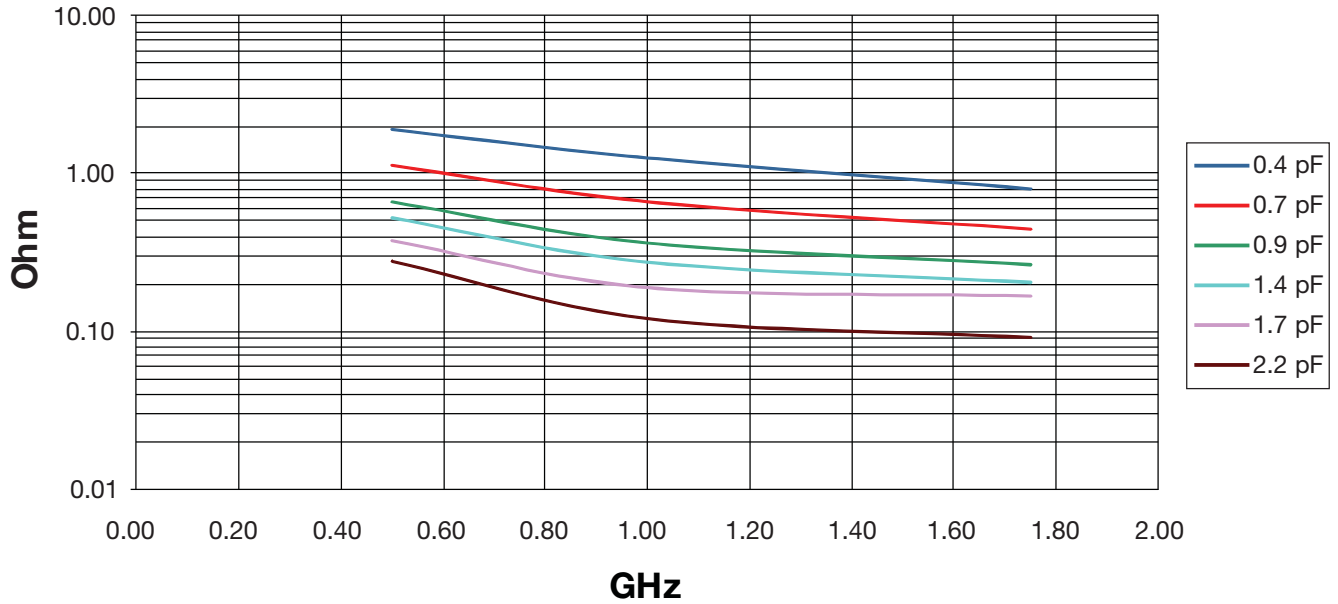

Typical Q vs. Frequency
MLO™ 0603

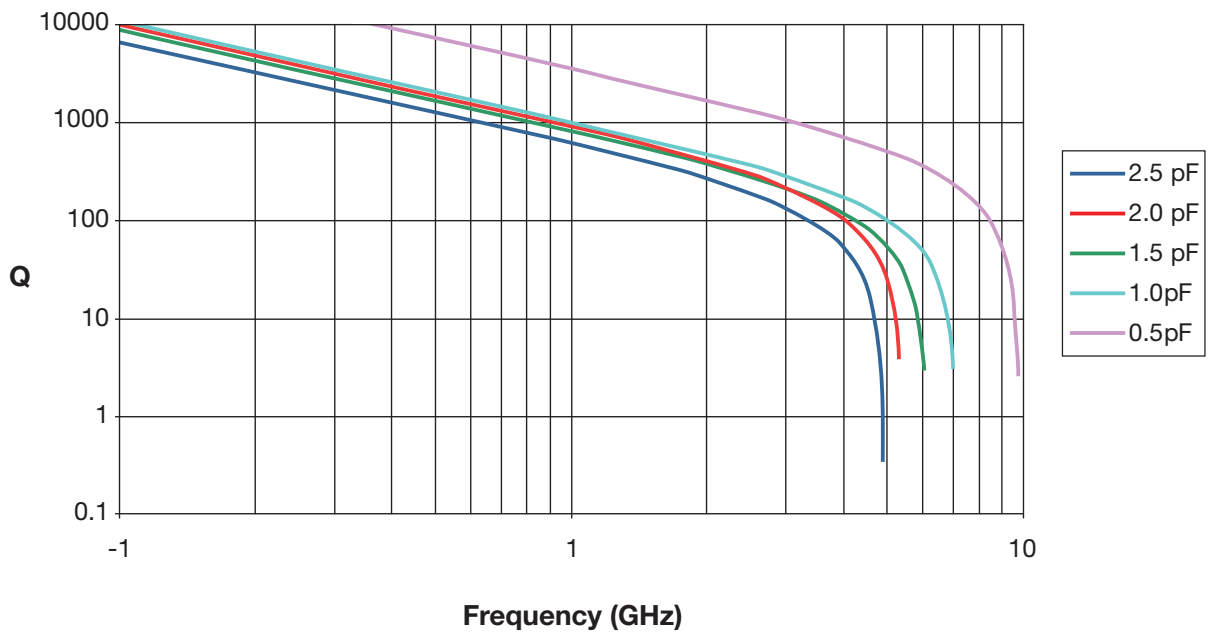

Typical Self Resonant Frequency vs. Capacitance
MLO™ 0603

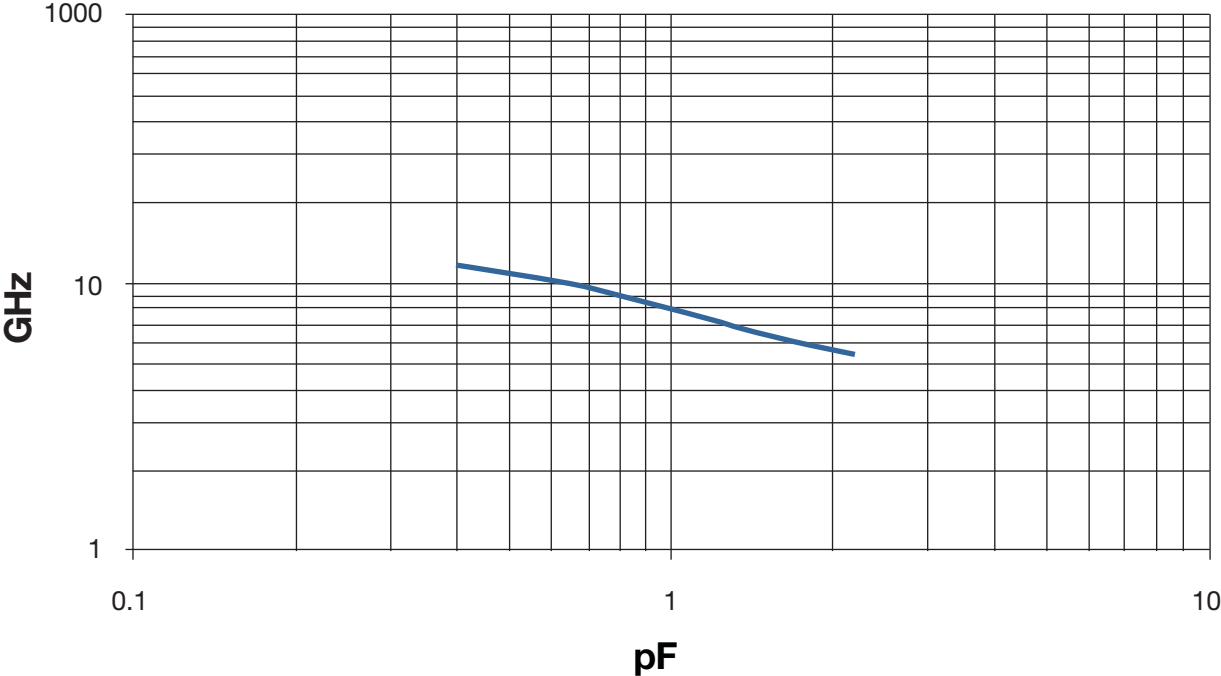

6

Multilayer Organic (MLO™)



0603 WLAN/BT Diplexer



MLO™ TECHNOLOGY

The 0603 diplexer is a best in class low profile multilayer organic passive device that is based on AVX's patented multilayer organic high density interconnect technology. The MLO™ diplexer uses high dielectric constant and low loss materials to realize high Q passive printed elements such as inductors, and capacitors in a multilayer stack up. The MLO™ diplexers can support multiple wireless standards such as WCDMA, CDMA, WLAN, GSM, and BT. These diplexers are less than 0.5mm in height and are ideally suited for band switching for dual band systems. All diplexers are expansion matched to printed circuit boards thereby resulting in improved reliability vs. ceramic and Si components.

APPLICATIONS

Multiband applications including WiFi, WiMax, GPS, and cellular bands

LAND GRID ARRAY ADVANTAGES

- Inherent Low Profile
- Excellent Solderability
- Low Parasitics
- High Heat Dissipation

HOW TO ORDER

DP **03** **B** **5425** **7** **TR**
 Type Size Design Frequency (MHz) Finish Packaging
 7 = Au
 T = NiSn
 Tape & Reel



COMPONENT DIMENSIONS AND FUNCTIONS

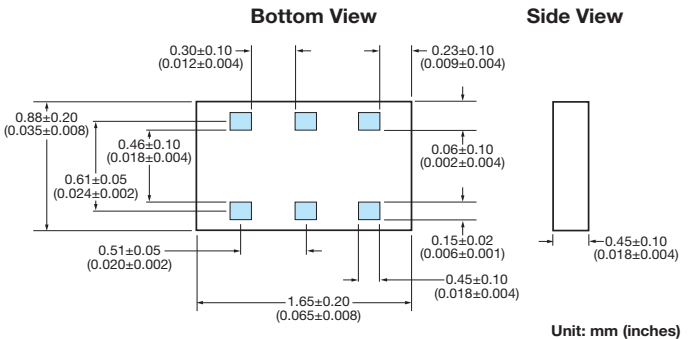

QUALITY INSPECTION

Finished parts are 100% tested for electrical parameters and visual characteristics.

OPERATING TEMPERATURE

-40°C to +85°C

TERMINATION

Finishes available in Ni Au, Ni Sn and OSP coatings which are compatible with automatic soldering technologies which include reflow, wave soldering, vapor phase and manual.

Terminal No.	Terminal Name
1	GND
2	Common
3	GND
4	Low Frequency Port
5	GND
6	High Frequency Port

PART NUMBER: DP03B54257TR

Electrical Characteristics @ 25°C

No.	Parameter	Freq. (MHz)	Port	Specification	Typ. value	Unit
1	Insertion Loss	2400-2496	Low	0.55 max	0.40	dB
2		4900-5950	High	1.2 max	0.80	dB
3	Attenuation	500-2700	High	28 min	35	dB
4		9800-11900	High	10 min	14	dB
6	Attenuation	4800-4992	Low	20 min	25	dB
7		4900-5950	Low	23 min	27	dB
8	Isolation	7200-7500	Low	26 min	30	dB
9		500-2700	Low-High	28 min	35	dB
10	4900-5950	Low-High	22 min	25	dB	
11	VSWR	2400-2500	Ant	2.0 max	1.5	-
12	VSWR	4900-5950	Ant	2.0 max	1.3	-
13	VSWR	2400-2500	Low	2.0 max	1.5	-
14	VSWR	4900-5950	High	2.0 max	1.3	-

ORIENTATION IN TAPE

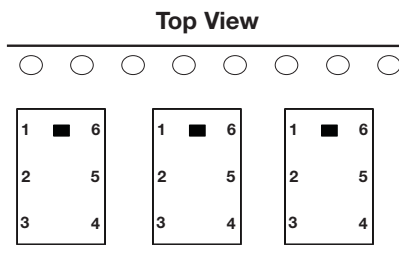

POWER CAPACITY

4.5W Maximum

Mechanical Characteristics @ 25°C

Size [mm(inches)]	1.65 x 0.88 (0.065 x 0.035)
Height [mm(inches)]	0.42 (0.017)
Volume (mm ³)	0.77



S PARAMETER MEASUREMENTS

LOW BAND PORT ATTENUATION

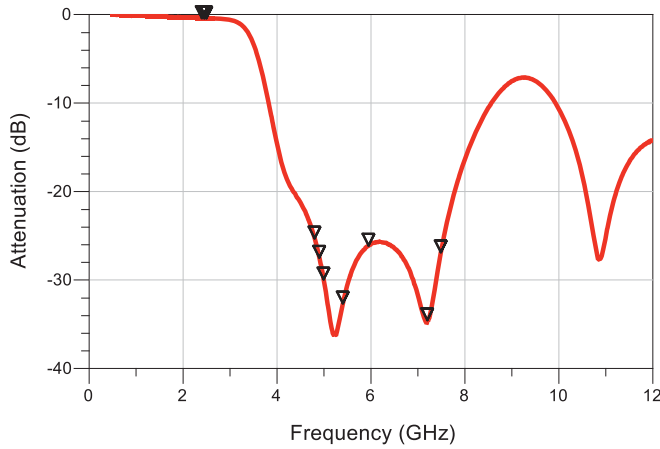

Low Band Attenuation

Frequency	Attenuation
4.800 GHz	25.302
4.992 GHz	29.935
4.900 GHz	27.471
5.400 GHz	32.647
5.590 GHz	26.099
7.200 GHz	34.531
7.488 GHz	26.860

HIGH BAND PORT ATTENUATION

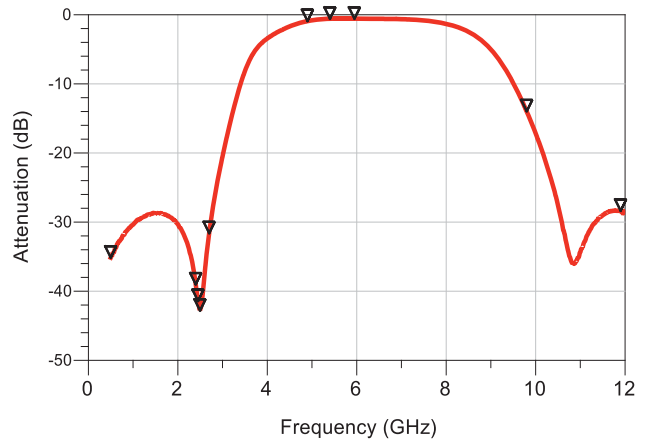

High Band Attenuation

Frequency	Attenuation
0.500 GHz	35.133
2.400 GHz	39.019
2.450 GHz	41.406
2.496 GHz	42.793
2.700 GHz	31.607
9.800 GHz	13.967
11.90 GHz	28.352

LOW BAND INSERTION LOSS

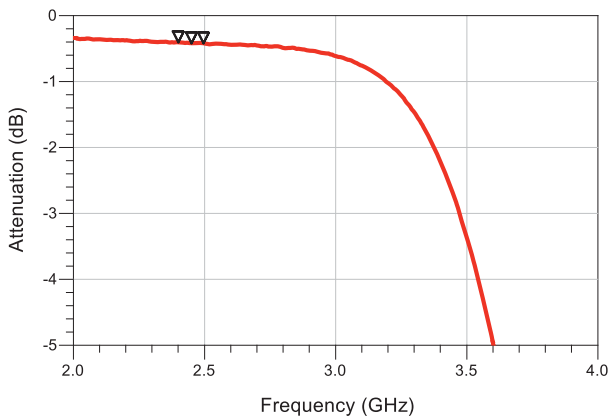

Low Band Insertion Loss

Frequency	Insertion Loss
2.400 GHz	0.404
2.450 GHz	0.418
2.496 GHz	0.420

HIGH BAND INSERTION LOSS

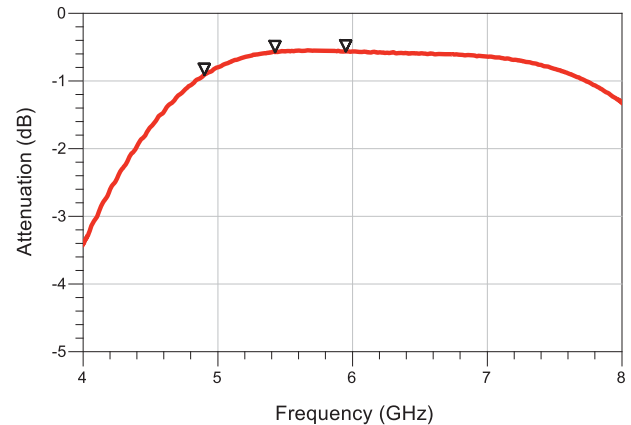

High Band Insertion Loss

Frequency	Insertion Loss
4.900 GHz	0.909
5.400 GHz	0.577
5.950 GHz	0.562

6

S PARAMETER MEASUREMENTS

COMMON PORT RETURN LOSS

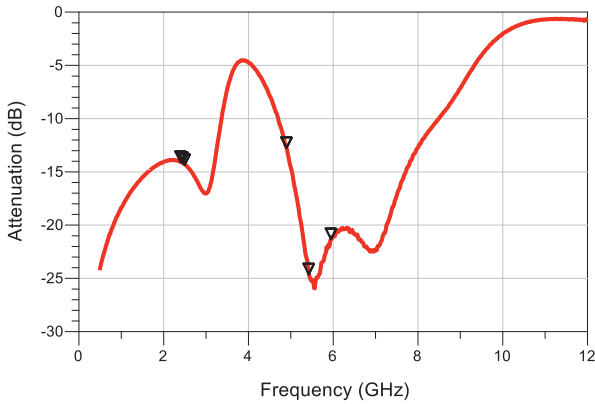

Common Return Loss

Frequency	Return Loss	VSWR
2.400 GHz	14.066	1.494
2.450 GHz	14.162	1.487
2.496 GHz	14.325	1.476
4.900 GHz	12.750	1.599
5.400 GHz	24.603	1.125
5.950 GHz	21.310	1.188

ISOLATION

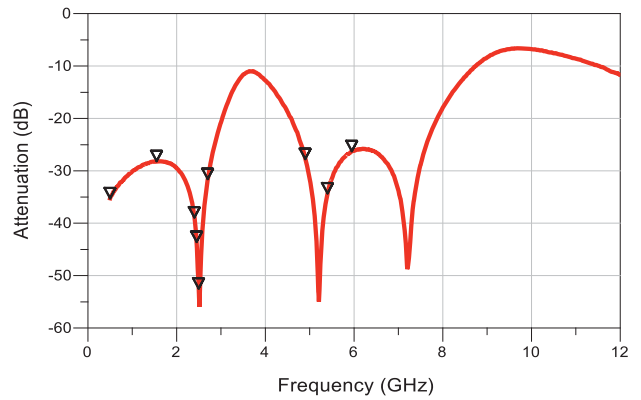

Isolation

Frequency	Attenuation
0.500 GHz	32.253
1.550 GHz	28.144
2.400 GHz	28.913
2.450 GHz	43.562
2.496 GHz	52.470
2.700 GHz	31.566
4.900 GHz	27.731
5.400 GHz	34.304
5.950 GHz	26.249

LOW BAND RETURN LOSS

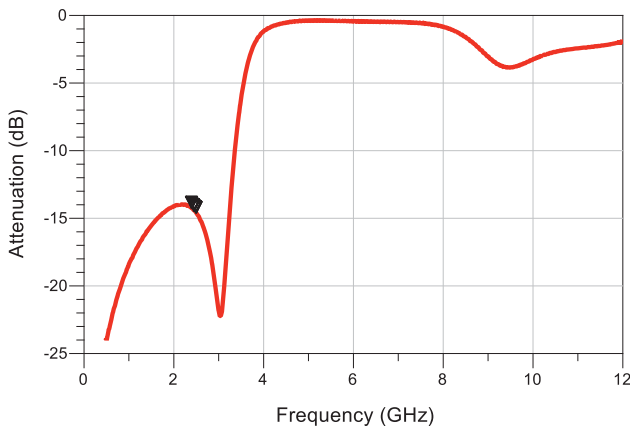

Low Band Return Loss

Frequency	Return Loss	VSWR
2.400 GHz	14.232	1.482
2.450 GHz	14.429	1.469
2.496 GHz	14.572	1.459

HIGH BAND RETURN LOSS

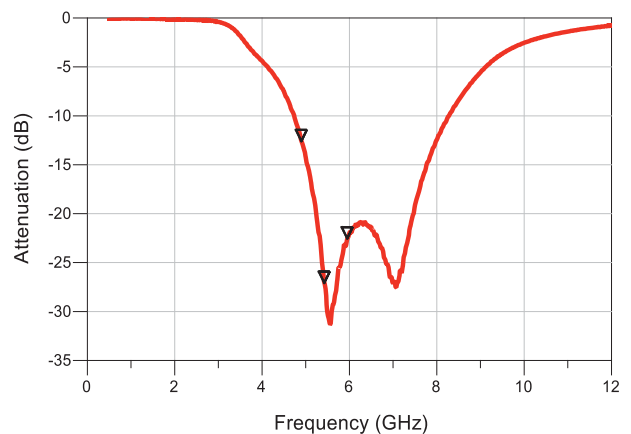

High Band Return Loss

Frequency	Return Loss	VSWR
4.900 GHz	12.587	
5.400 GHz	27.577	1.087
5.950 GHz	22.533	1.161

Multilayer Organic (MLO™)



0603 WLAN/BT Diplexer



MLO™ TECHNOLOGY

The 0603 diplexer is a best in class low profile multilayer organic passive device that is based on AVX's patented multilayer organic high density interconnect technology. The MLO™ diplexer uses high dielectric constant and low loss materials to realize high Q passive printed elements such as inductors, and capacitors in a multilayer stack up. The MLO™ diplexers can support multiple wireless standards such as WCDMA, CDMA, WLAN, GSM, and BT. These diplexers are less than 0.5mm in height and are ideally suited for band switching for dual band systems. All diplexers are expansion matched to printed circuit boards thereby resulting in improved reliability vs. ceramic and Si components.

APPLICATIONS

Multiband applications including WiFi, WiMax, GPS, and cellular bands

LAND GRID ARRAY ADVANTAGES

- Inherent Low Profile
- Excellent Solderability
- Low Parasitics
- High Heat Dissipation

HOW TO ORDER

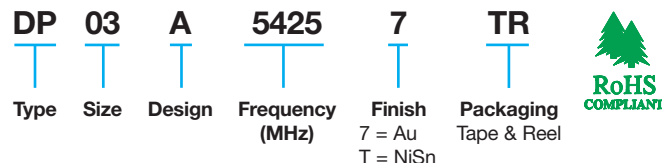

QUALITY INSPECTION

Finished parts are 100% tested for electrical parameters and visual characteristics.

OPERATING TEMPERATURE

-40°C to +85°C

TERMINATION

Finishes available in Ni Au, Ni Sn and OSP coatings which are compatible with automatic soldering technologies which include reflow, wave soldering, vapor phase and manual.

ORIENTATION IN TAPE

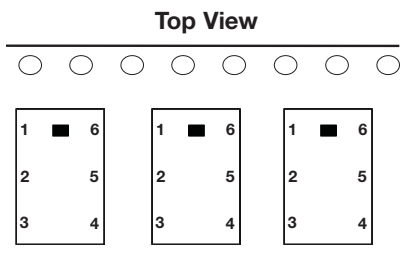

POWER CAPACITY

4.5W Maximum

COMPONENT DIMENSIONS AND FUNCTIONS

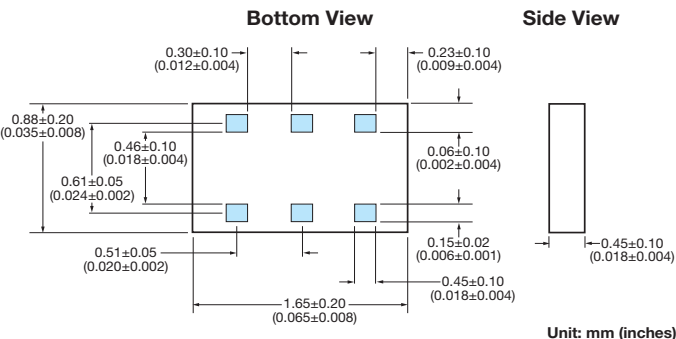

Terminal No.	Terminal Name
1	Low Frequency Port
2	GND
3	High Frequency Port
4	GND
5	Common
6	GND

PART NUMBER: DP03A54257TR

Electrical Characteristics @ 25°C

No.	Parameter	Freq. (MHz)	Port	Specification	Typ. value	Unit
1	Insertion Loss	2400-2496	Low	0.55 max	0.40	dB
2		4900-5950	High	1.2 max	0.80	dB
3	Attenuation	500-2700	High	28 min	35	dB
4		9800-11900	High	10 min	14	dB
6	Attenuation	4800-4992	Low	20 min	25	dB
7		4900-5950	Low	23 min	27	dB
8	Attenuation	7200-7500	Low	26 min	30	dB
9	Isolation	500-2700	Low-High	28 min	35	dB
10		4900-5950	Low-High	22 min	25	dB
11	VSWR	2400-2500	Ant	2.0 max	1.5	-
12	VSWR	4900-5950	Ant	2.0 max	1.3	-
13	VSWR	2400-2500	Low	2.0 max	1.5	-
14	VSWR	4900-5950	High	2.0 max	1.3	-

Mechanical Characteristics @ 25°C

Size [mm(inches)]	1.65 x 0.88 (0.065 x 0.035)
Height [mm(inches)]	0.42 (0.017)
Volume (mm ³)	0.77



S PARAMETER MEASUREMENTS

LOW BAND PORT ATTENUATION

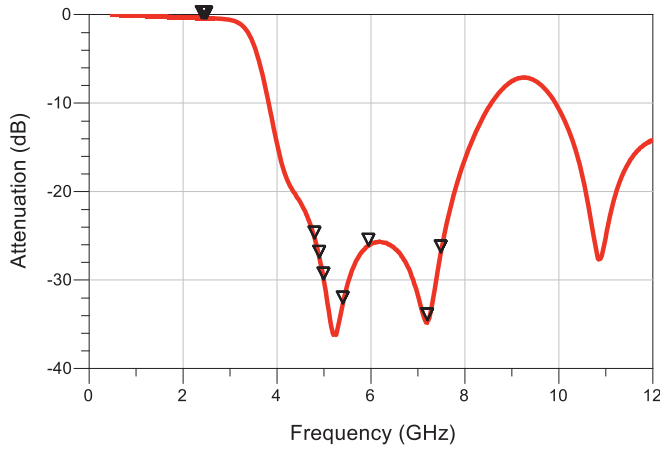

Low Band Attenuation

Frequency	Attenuation
4.800 GHz	25.302
4.992 GHz	29.935
4.900 GHz	27.471
5.400 GHz	32.647
5.590 GHz	26.099
7.200 GHz	34.531
7.488 GHz	26.860

HIGH BAND PORT ATTENUATION

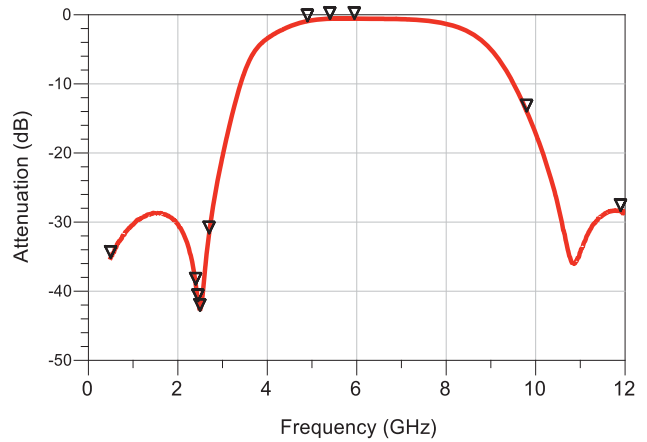

High Band Attenuation

Frequency	Attenuation
0.500 GHz	35.133
2.400 GHz	39.019
2.450 GHz	41.406
2.496 GHz	42.793
2.700 GHz	31.607
9.800 GHz	13.967
11.90 GHz	28.352

LOW BAND INSERTION LOSS

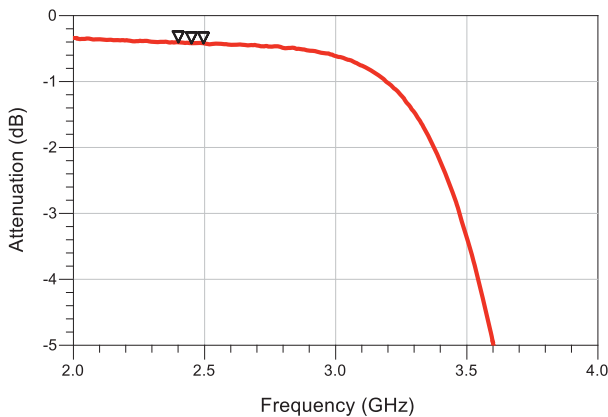

Low Band Insertion Loss

Frequency	Insertion Loss
2.400 GHz	0.404
2.450 GHz	0.418
2.496 GHz	0.420

HIGH BAND INSERTION LOSS

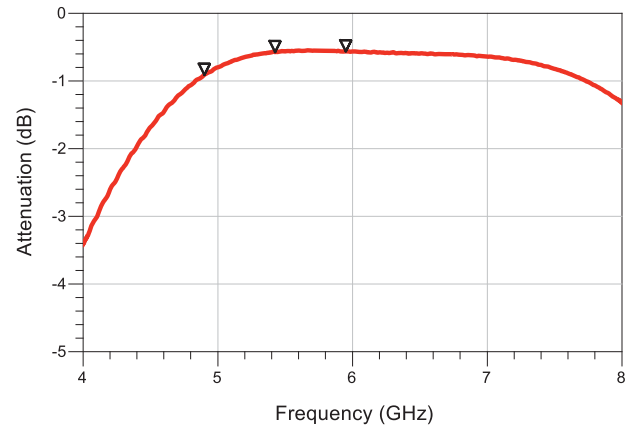

High Band Insertion Loss

Frequency	Insertion Loss
4.900 GHz	0.909
5.400 GHz	0.577
5.950 GHz	0.562

S PARAMETER MEASUREMENTS

COMMON PORT RETURN LOSS

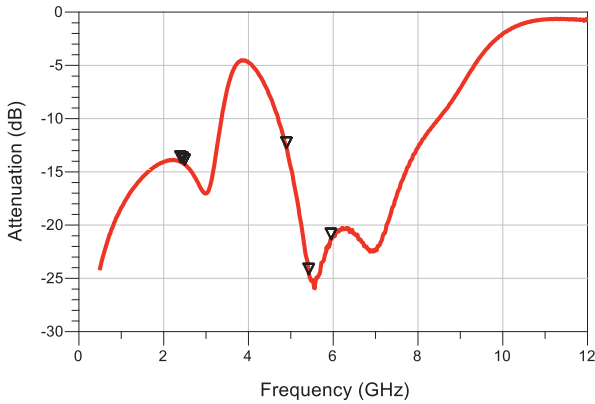

Common Return Loss

Frequency	Return Loss	VSWR
2.400 GHz	14.066	1.494
2.450 GHz	14.162	1.487
2.496 GHz	14.325	1.476
4.900 GHz	12.750	1.599
5.400 GHz	24.603	1.125
5.950 GHz	21.310	1.188

ISOLATION

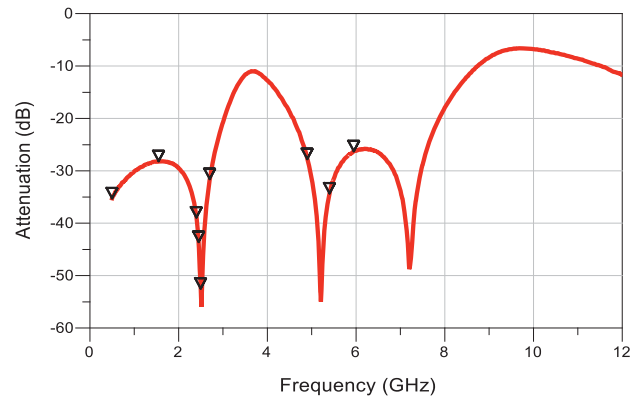

Isolation

Frequency	Attenuation
0.500 GHz	32.253
1.550 GHz	28.144
2.400 GHz	28.913
2.450 GHz	43.562
2.496 GHz	52.470
2.700 GHz	31.566
4.900 GHz	27.731
5.400 GHz	34.304
5.950 GHz	26.249

LOW BAND RETURN LOSS

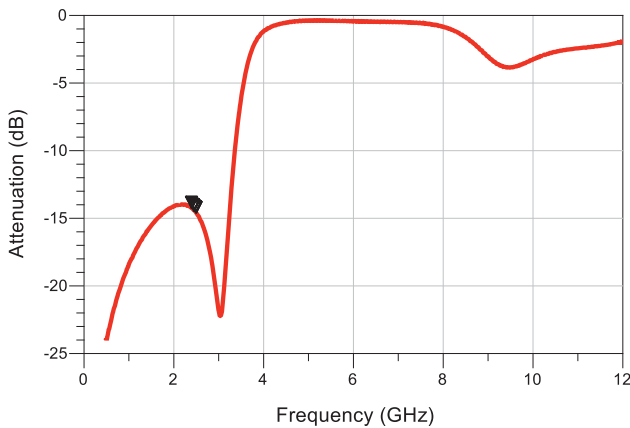

Low Band Return Loss

Frequency	Return Loss	VSWR
2.400 GHz	14.232	1.482
2.450 GHz	14.429	1.469
2.496 GHz	14.572	1.459

HIGH BAND RETURN LOSS

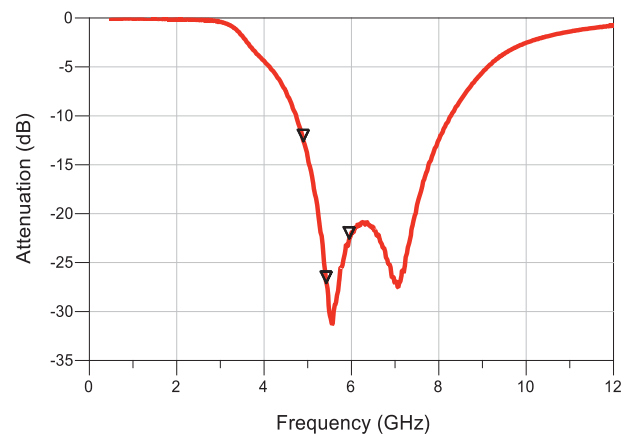

High Band Return Loss

Frequency	Return Loss	VSWR
4.900 GHz	12.587	
5.400 GHz	27.577	1.087
5.950 GHz	22.533	1.161

6

Multilayer Organic (MLO™)



0805 CDMA Diplexer



MLO™ TECHNOLOGY

The 0805 diplexer is a best in class low profile multilayer organic passive device that is based on AVX's patented multilayer organic high density interconnect technology. The MLO™ diplexer uses high dielectric constant and low loss materials to realize high Q passive printed passive elements such as inductors and capacitors in a multilayer stack up. The MLO™ diplexers can support multiple wireless standards such as WCDMA, CDMA, WLAN, and GSM and are less than 0.6mm in thickness. These components are ideally suited for band switching for dual band systems. All diplexers are expansion matched to FR4 thereby resulting in improved reliability over standard Si and ceramic devices.

APPLICATIONS

Multiband applications including WCDMA, WLAN, WiMax, GPS, and cellular bands

LAND GRID ARRAY ADVANTAGES

- Low Insertion Loss
- Excellent Solderability
- Low Parasitics
- Low Profile

HOW TO ORDER

DP **05** **A** **1920** **7** **TR**
 Type Size Design Frequency (MHz) Finish Packaging
 7 = Au TR = 3 Kpcs
 T = NiSn TR/500 = 500 pcs



COMPONENT DIMENSIONS AND FUNCTIONS

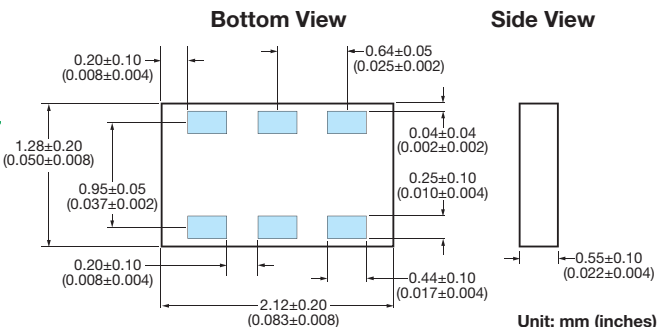

QUALITY INSPECTION

Finished parts are 100% tested for electrical parameters and visual characteristics.

OPERATING TEMPERATURE

-40°C to +85°C

TERMINATION

Finishes available in Ni/Sn, Immersion Sn, Immersion Au and OSP coatings which are compatible with automatic soldering technologies which include reflow, wave soldering, vapor phase and manual.

Terminal No.	Terminal Name
1	High Frequency Port
2	GND
3	Low Frequency Port
4	GND
5	Common Port
6	GND

ORIENTATION IN TAPE

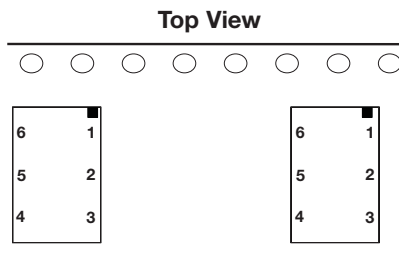

PART NUMBER: DP05A19207TR

POWER CAPACITY

4.5W Maximum

Specification @ 25°C	
Size [mm(inches)]	2.12 x 1.28 (0.083 x 0.050)
Height [mm(inches)]	0.55 (0.021)
Volume (mm ³)	1.5
Frequency Range (F1) (MHz)	859±35
Frequency Range (F2) (MHz)	1920±70
Insertion Loss (F1, at Fc) (dB)	-0.4
Insertion Loss (F2, at Fc) (dB)	-0.6
Attenuation (F1) at (F2) (dB)	-23
Attenuation (F2) at (F1) (dB)	-23
VSWR (Input @ F1)	1.4
VSWR (Input @ F2)	1.3
VSWR (Lowband @ F1)	1.4
VSWR (Highband @ F2)	1.4



S PARAMETER MEASUREMENTS

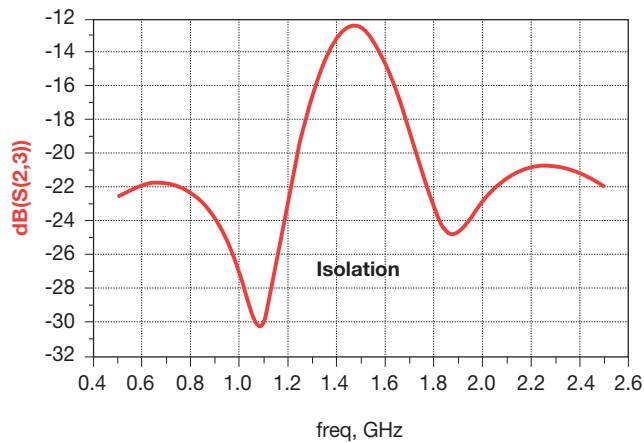
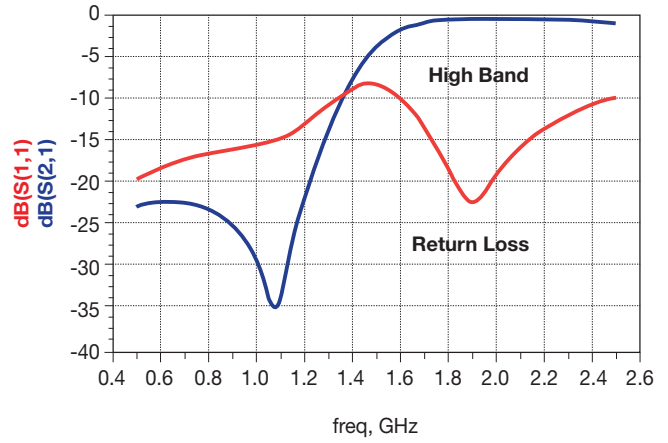
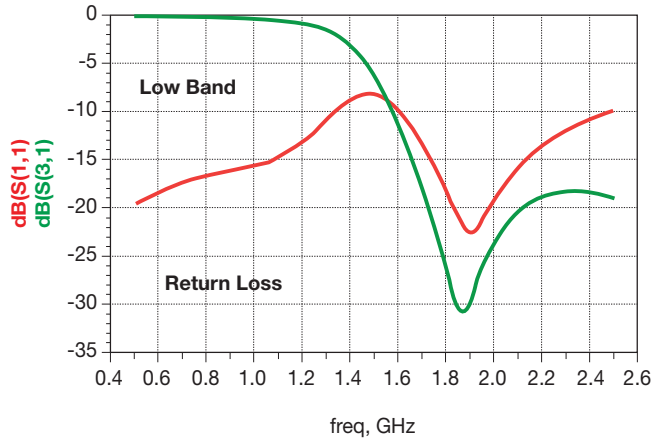

Note: Measurements were taken using an Anritsu 4 port VNA; Diplexer was mounted on a custom evaluation board. To reduce systematic errors from the VNA, the coaxial measurement cables, and evaluation board, a Short-Open-Load-Thru (SOLT) calibration was performed, using a custom fabricated calibration substrate. This is the most common coaxial calibration methods.

6

Multilayer Organic (MLO™)



0805 WCDMA Diplexer



MLO™ TECHNOLOGY

The 0805 diplexer is a best in class low profile multilayer organic passive device that is based on AVX's patented multilayer organic high density interconnect technology. The MLO™ diplexer uses high dielectric constant and low loss materials to realize high Q passive printed passive elements such as inductors and capacitors in a multilayer stack up. The MLO™ diplexers can support multiple wireless standards such as WCDMA, CDMA, WLAN, and GSM and are less than 0.6mm in thickness. These components are ideally suited for band switching for dual band systems. All diplexers are expansion matched to FR4 thereby resulting in improved reliability over standard Si and ceramic devices.

APPLICATIONS

Multiband applications including WCDMA, WLAN, WiMax, GPS, and cellular bands

LAND GRID ARRAY ADVANTAGES

- Low Insertion Loss
- Excellent Solderability
- Low Parasitics
- Low Profile

HOW TO ORDER

DP | **05** | **A** | **1940** | **7** | **TR**
 Type | Size | Design | Frequency (MHz) | Finish | Packaging
 7 = Au | TR = 3 Kpcs
 T = NiSn | TR/500 = 500 pcs



COMPONENT DIMENSIONS AND FUNCTIONS

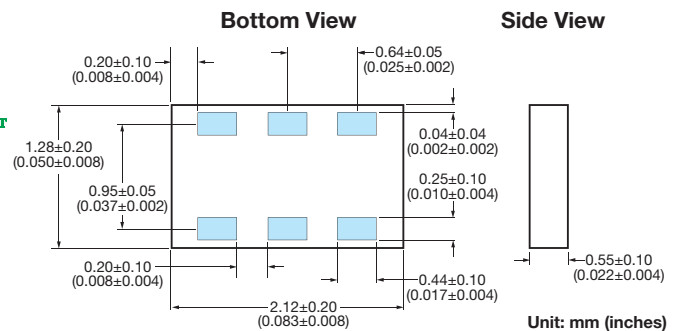

QUALITY INSPECTION

Finished parts are 100% tested for electrical parameters and visual characteristics.

OPERATING TEMPERATURE

-40°C to +85°C

TERMINATION

Finishes available in Ni/Sn, Immersion Sn, Immersion Au and OSP coatings which are compatible with automatic soldering technologies which include reflow, wave soldering, vapor phase and manual.

ORIENTATION IN TAPE

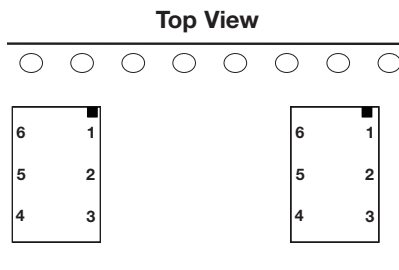

Terminal No.	Terminal Name
1	High Frequency Port
2	GND
3	Low Frequency Port
4	GND
5	Common Port
6	GND

PART NUMBER: DP05A19407TR

Specification @ 25°C	
Size [mm(inches)]	2.12 x 1.28 (0.083 x 0.050)
Height [mm(inches)]	0.55 (0.021)
Volume (mm ³)	1.5
Frequency Range (F1) (MHz)	892±68
Frequency Range (F2) (MHz)	1940±230
Insertion Loss (F1, at Fc) (dB)	-0.4
Insertion Loss (F2, at Fc) (dB)	-0.65
Attenuation (F1) at (F2) (dB)	-23
Attenuation (F2) at (F1) (dB)	-20
VSWR (Input @ F1)	1.3
VSWR (Input @ F2)	1.4
VSWR (Lowband @ F1)	1.4
VSWR (Highband @ F2)	1.2

POWER CAPACITY

4.5W Maximum



S PARAMETER MEASUREMENTS

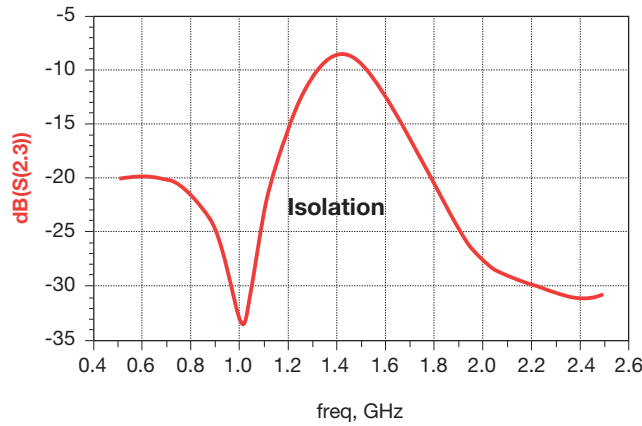
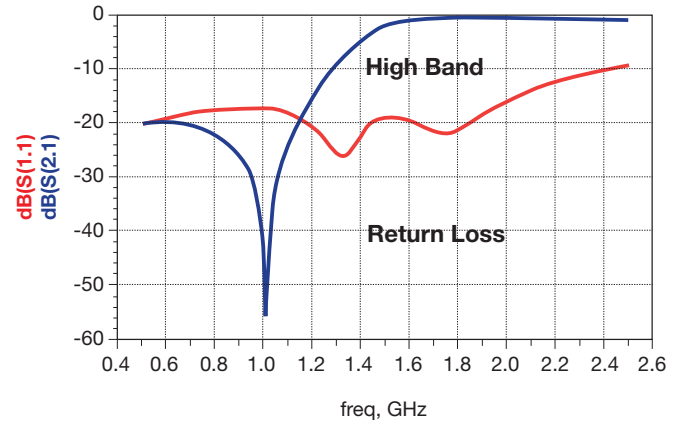
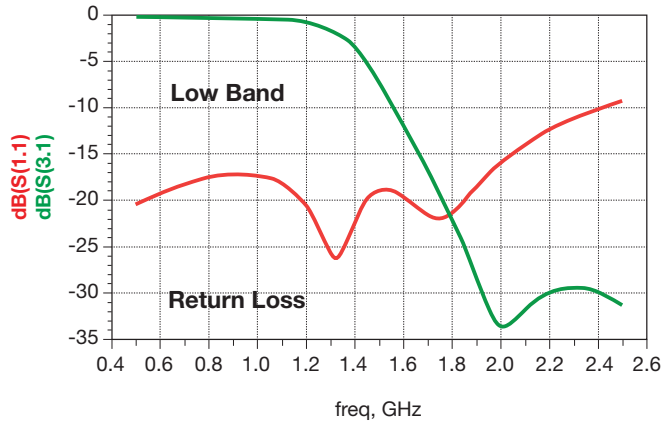

Note: Measurements were taken using an Anritsu 4 port VNA; Diplexer was mounted on a custom evaluation board. To reduce systematic errors from the VNA, the coaxial measurement cables, and evaluation board, a Short-Open-Load-Thru (SOLT) calibration was performed, using a custom fabricated calibration substrate. This is the most common coaxial calibration methods.

6

0805 WLAN Diplexer



MLO™ TECHNOLOGY

The 0805 diplexer is a best in class low profile multilayer organic passive device that is based on AVX's patented multilayer organic high density interconnect technology. The MLO™ diplexer uses high dielectric constant and low loss materials to realize high Q passive printed elements such as inductors and capacitors in a multilayer stack up. The MLO™ diplexers can support multiple wireless standards such as WCDMA, CDMA, WLAN and GSM. These components which are less than 0.6mm in thickness are ideally suited for band switching for dual band systems. All diplexers are expansion matched to FR4 thereby resulting in improved reliability over standard Si and ceramic devices.

APPLICATIONS

Multiband applications including WiFi, WiMax, GPS, and cellular bands

LAND GRID ARRAY ADVANTAGES

- Low Insertion Loss
- Excellent Solderability
- Low Parasitics
- Low Profile

HOW TO ORDER

DP	05	A	5250	7	TR	
Type	Size	Design	Frequency (MHz)	Finish 7 = Au T = NiSn	Packaging Tape & Reel TR = 3 Kpcs TR/500 = 500 pcs	

QUALITY INSPECTION

Finished parts are 100% tested for electrical parameters and visual characteristics.

OPERATING TEMPERATURE

-40°C to +85°C

TERMINATION

Finishes available in Ni/Sn, Immersion Sn, Immersion Au and OSP coatings which are compatible with automatic soldering technologies which include reflow, wave soldering, vapor phase and manual.

ORIENTATION IN TAPE

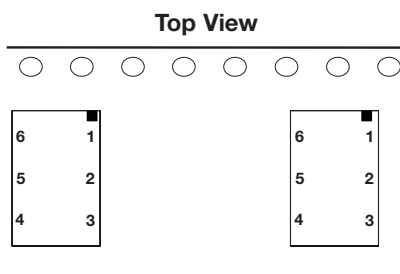

POWER CAPACITY

4.5W Maximum

COMPONENT DIMENSIONS AND FUNCTIONS

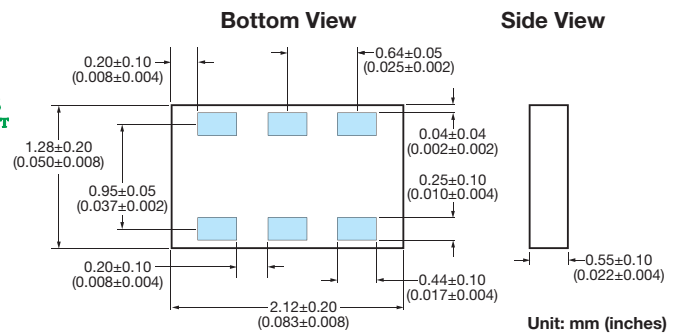

Terminal No.	Terminal Name
1	High Frequency Port
2	GND
3	Low Frequency Port
4	GND
5	Common Port
6	GND

PART NUMBER: DP05A52507TR

Specification @ 25°C	
Size [mm(inches)]	2.12 x 1.28 (0.083 x 0.050)
Height [mm(inches)]	0.55 (0.021)
Volume (mm^3)	1.5
Frequency Range (F1) (MHz)	2450±50
Frequency Range (F2) (MHz)	5250±100
Insertion Loss (F1) (dB)	-0.5
Insertion Loss (F2) (dB)	-0.5
Attenuation (F1) at (F2) (dB)	-20
Attenuation (F2) at (F1) (dB)	-20
Return Loss (Lowband @ F1) (dB)	-12
Return Loss (Highband @ F2) (dB)	-12
Isolation (Lowband @ F1) (dB)	-25
Isolation (Highband @ F2) (dB)	-21

S PARAMETER MEASUREMENTS

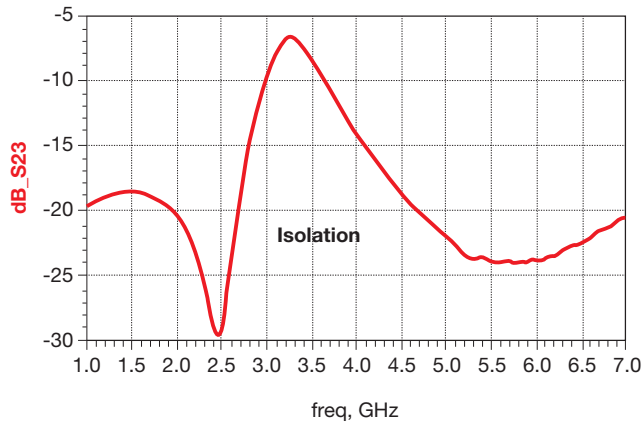
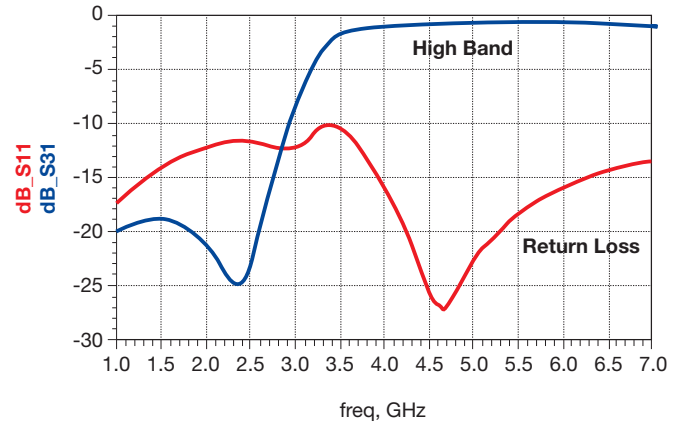
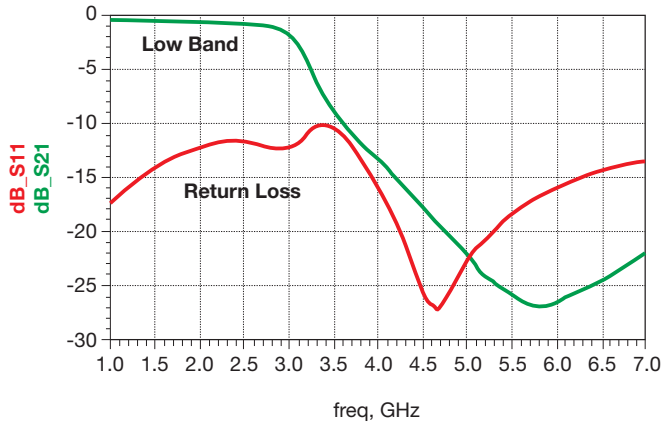

6

Multilayer Organic (MLO™)



0805 WLAN/BT Diplexer



MLO™ TECHNOLOGY

The 0805 MLO™ diplexer is best in class low profile multilayer organic passive device that is based on AVX's patented multilayer organic high density interconnect technology. The MLO™ diplexer uses high dielectric constant and low loss materials to realize high Q passive printed elements such as inductors and capacitors in a multilayer stack up. The MLO™ diplexers can support multiple wireless standards such as WCDMA, CDMA, WLAN and GSM. These components which are less than 0.5mm in thickness are ideally suited for band switching for dual band systems. All MLO™ diplexers are expansion matched to FR4 thereby resulting in improved reliability over standard Si and ceramic devices.

APPLICATIONS

Multiband applications including WiFi, BT, WiMax, GPS, and cellular bands

LAND GRID ARRAY ADVANTAGES

- Low Insertion Loss
- Excellent Solderability
- Low Parasitics
- Matched CTE to PCB

HOW TO ORDER

DP **05** **B** **5425** **7** **TR**
 Type Size Design Frequency (MHz) Finish Packaging
 7 = Au TR = 3 Kpcs
 T = NiSn TR/500 = 500 pcs



COMPONENT DIMENSIONS AND FUNCTIONS

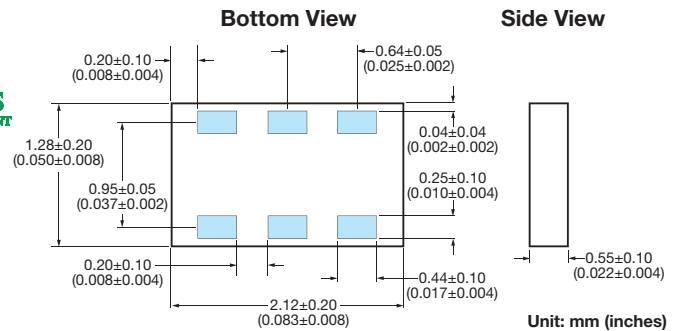

QUALITY INSPECTION

Finished parts are 100% tested for electrical parameters and visual characteristics.

OPERATING TEMPERATURE

-40°C to +85°C

TERMINATION

Finishes available in Ni/Sn, Immersion Sn, Immersion Au and OSP coatings which are compatible with automatic soldering technologies which include reflow, wave soldering, vapor phase and manual.

Terminal No.	Terminal Name
1	Low Frequency Port
2	GND
3	High Frequency Port
4	GND
5	Common Port
6	GND

PART NUMBER: DP05B54257TR

ORIENTATION IN TAPE

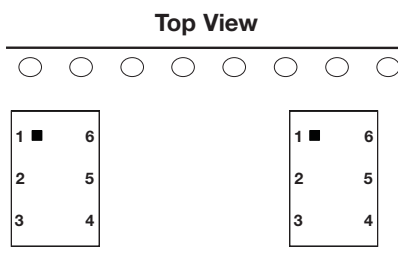

POWER CAPACITY

4.5W Maximum

Specification @ 25°C	
Size [mm(inches)]	2.12 x 1.28 (0.083 x 0.050)
Height [mm(inches)]	0.55 (0.021)
Volume (mm ³)	1.5
Pass Band Range (F1) (MHz)	2450 +/-50MHz
Pass Band Range (F2) (MHz)	5425 +/-525MHz
Insertion Loss (F1) (dB)	-0.5
Insertion Loss (F2) (dB)	-1.0
Attenuation (F1) 4800MHz - 6000MHz (dB)	-36
Attenuation 3 x (F1) (dB)	-31
Attenuation (F2) 1800MHz - 2500MHz (dB)	-26
Attenuation 2 x (F2) (dB)	-13
Attenuation 3 x (F2) (dB)	-15
VSWR (Input @ F1)	1.2
VSWR (Input @ F2)	1.7
VSWR (Lowband @ F1)	1.2
VSWR (Highband @ F2)	1.7



S PARAMETER MEASUREMENTS

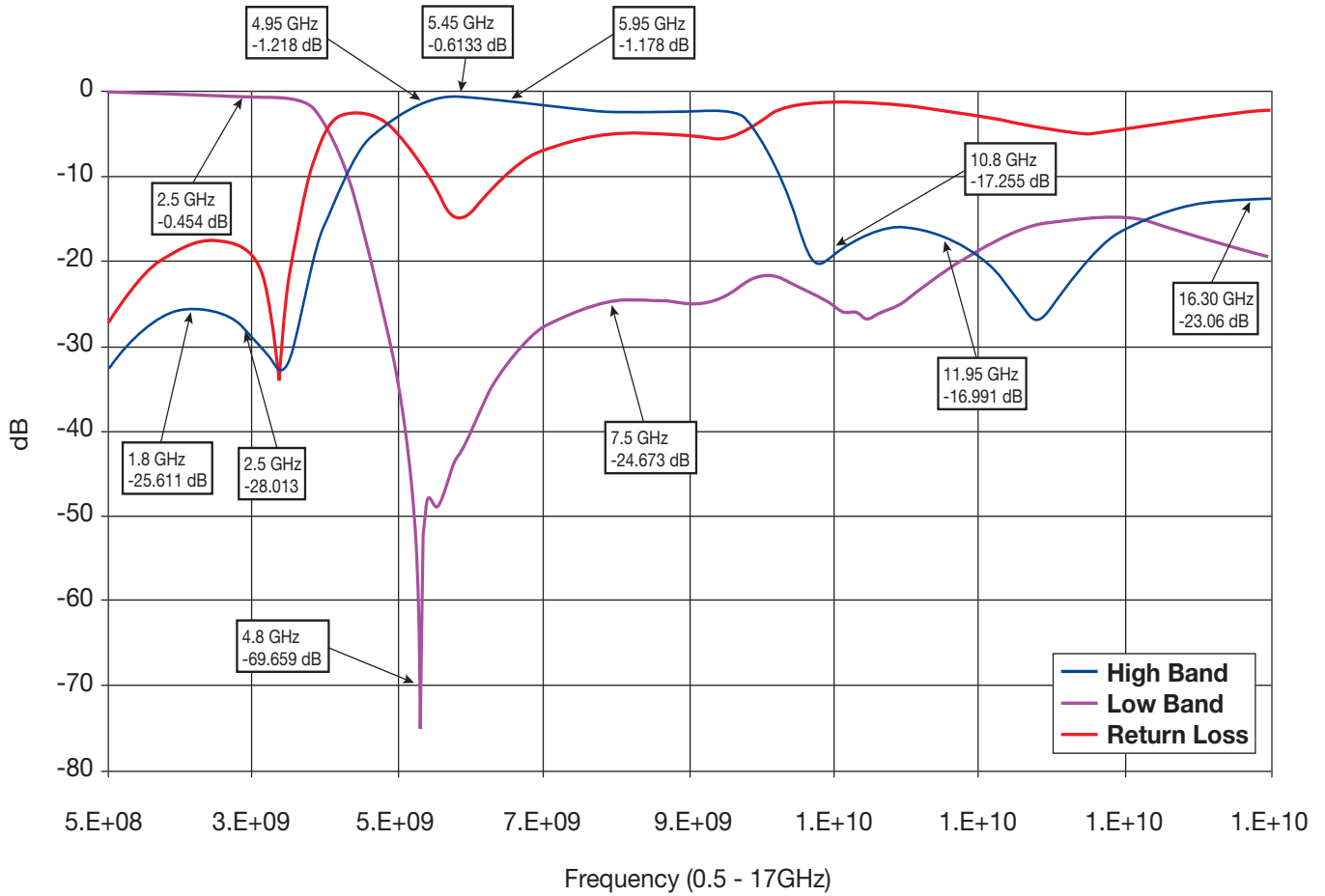

6

AUTOMATED SMT ASSEMBLY

The following section describes the guidelines for automated SMT assembly of MLO™ RF devices which are typically Land Grid Array (LGA) packages or side termination SMT packages. Control of solder and solder paste volume is critical for surface mount assembly of MLO™ RF devices onto the PCB.

Stencil thickness and aperture openings should be adjusted according to the optimal solder volume. The following are general recommendations for SMT mounting of MLO™ devices onto the PCB.

SMT REFLOW PROFILE

Common IR or convection reflow SMT processes shall be used for the assembly. Standard SMT reflow profiles, for eutectic and Pb free solders, can be used to surface mount the MLO™ devices onto the PCB. In all cases, a temperature gradient of 3°C/sec, or less, should be maintained to prevent warpage of the package and to ensure that all joints reflow properly. Additional soak time and slower preheating time

may be required to improve the out-gassing of solder paste. In addition, the reflow profile depends on the PCB density and the type of solder paste used. Standard no-clean solder paste is generally recommended. If another type of flux is used, complete removal of flux residual may be necessary. Example of a typical lead free reflow profile is shown below.

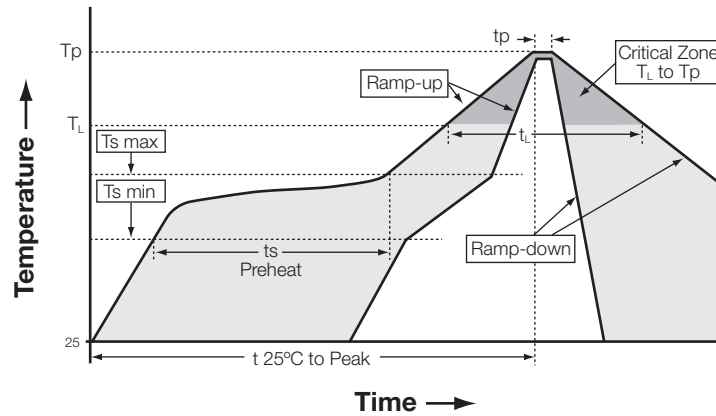

Figure A. Typical Lead Free Profile and Parameters

Profile Parameter	Pb free, Convection, IR/Convection
Ramp-up rate (T _s max to T _p)	3°C/second max.
Preheat temperature (T _s min to T _s max)	150°C to 200°C
Preheat time (t _s)	60 – 180 seconds
Time above T _L , 217°C (t _L)	60 – 120 seconds
Peak temperature (T _p)	260°C
Time within 5°C of peak temperature (t _p)	10 – 20 seconds
Ramp-down rate	4°C/second max.
Time 25°C to peak temperature	6 minutes max.

MLO™ Tight Tolerance Inductors **AVX RF**



The Multilayer Organic Tight Tolerance Inductor is a low profile organic based inductor that can support mobile communications, satellite applications, GPS, matching networks, and collision avoidance. The MLO™ Tight Tolerance Inductor series of components are based on AVX's patented multilayer organic technology (US patent 6,987,307). MLO™ Tight Tolerance Inductors incorporate very low loss organic materials which allow for high Q and high stability over frequency. MLO™ Tight Tolerance Inductors are surface mountable and are expansion matched to FR4 printed wiring boards. MLO™ Tight Tolerance Inductors utilize fine line high density interconnect technology thereby allowing for tight tolerance control and high repeatability. Reliability testing is performed to JEDEC and mil standards. Finishes are available in RoHS compliant Sn.

APPLICATIONS

- Mobile communications
- Satellite Applications
- GPS
- Collision Avoidance
- Wireless LAN's

FEATURES

- Tight Tolerance
- High Frequency
- High Withstanding Voltage
- Low DC Resistance
- Surface Mountable
- 0402 Case Size
- RoHS Compliant Finishes
- Available in Tape and Reel

SURFACE MOUNT ADVANTAGES

- Inherent Low Profile
- Excellent Solderability
- Low Parasitics
- Better Heat Dissipation
- Expansion Matched to PCB

HOW TO ORDER

HL Style Tight Tolerance	02 Size 02 = 0402	XXX Inductance Expressed in nH (2 significant digits + number of zeros) for values <10nH, letter R denotes decimal point. Example: 22nH = 220 4.7nH = 4R7	X Tolerance A = ±0.05nH B = ±0.1nH G = ±2%	T Termination Sn100	TR Packaging 5000pcs T&R
---	-------------------------------------	---	--	---------------------------------------	---



DIMENSIONS

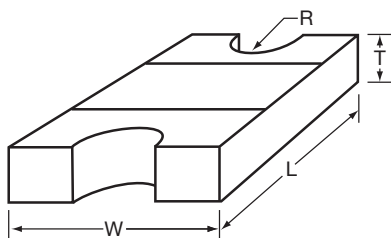

mm (inches)

L	W	T	R
1.00±0.10 (0.040±0.004)	0.58±0.075 (0.023±0.003)	0.35±0.10 (0.014±0.004)	0.125±0.050 (0.005±0.002)

QUALITY INSPECTION

Finished parts are 100% tested for electrical parameters and visual characteristics.

TERMINATION

RoHS compliant Sn finish.

OPERATING TEMPERATURE

-55°C to +125°C



0402 ELECTRICAL SPECIFICATIONS

L (nH) 450MHz	Available Inductance Tolerance A = ±0.05nH, B = ±0.1nH G = ±2%	Q 450MHz	Idc max (mA)	Rdc max (mΩ)	SRF min (GHz)
0.8	±0.05nH, ±0.1nH	15	450	100	7
0.9	±0.05nH, ±0.1nH	15	450	100	7
1	±0.05nH, ±0.1nH	15	420	100	7
1.1	±0.05nH, ±0.1nH	15	410	100	7
1.2	±0.05nH, ±0.1nH	15	410	110	7
1.3	±0.05nH, ±0.1nH	15	295	13	7
1.5	±0.05nH, ±0.1nH	15	295	150	7
1.6	±0.05nH, ±0.1nH	15	230	150	7
1.8	±0.05nH, ±0.1nH	15	295	160	7
2	±0.05nH, ±0.1nH	15	230	18	7
2.2	±0.05nH, ±0.1nH	15	230	200	7
2.4	±0.05nH, ±0.1nH	15	230	200	7
2.7	±0.05nH, ±0.1nH	15	230	250	7
3	±0.05nH, ±0.1nH	15	200	300	7
3.3	±0.05nH, ±0.1nH	15	200	340	7
3.6	±0.05nH, ±0.1nH	15	180	350	7
3.9	±0.05nH, ±0.1nH	15	180	400	7
4.7	±0.1nH	15	170	480	7
5.6	±0.1nH	15	150	500	7
6.8	±0.1nH	15	140	600	7
8.2	±0.1nH	15	115	800	6
10	±2%	15	105	1000	5
12	±2%	15	95	1100	4
15	±2%	15	95	1200	4
18	±2%	15	85	1500	3
22	±2%	15	75	1900	3
27	±2%	15	75	2100	3
30	±2%	15	65	2200	2
32	±2%	15	65	2200	2

Specifications based on performance of component assembled properly on printed circuit board with 50Ω nominal impedance.



The Multilayer Organic High Current Inductor is a low profile organic based inductor that can support mobile communications, satellite applications, GPS, matching networks, and collision avoidance. Based on AVX's patented multilayer organic technology (US patent 6,987,307), the 0402 size Multilayer Organic High Current Inductor allows for much higher current handling over similar multilayer ceramic chip inductors, a 50% average increase in current handling over comparable thin film products with similar Q, and current handling approaching that of wire wound ceramic chip inductors. MLO™ High Current Inductors incorporate very low loss organic materials which allow for high Q and high stability over frequency. They are surface mountable and are expansion matched to FR4 printed wiring boards. MLO™ High Current Inductors utilize fine line high density interconnect technology thereby allowing for tight tolerance control and high repeatability. Reliability testing is performed to JEDEC and mil standards. Finishes are available in RoHS compliant Sn.

APPLICATIONS

- Mobile communications
- Satellite Applications
- GPS
- Collision Avoidance
- Wireless LAN's

FEATURES

- High Q
- High SRF
- High Frequency
- High Current Handling
- Low DC Resistance
- Surface Mountable
- 0402 Case Size
- RoHS Compliant Finishes
- Available in Tape and Reel

SURFACE MOUNT ADVANTAGES

- Inherent Low Profile
- Excellent Solderability
- Low Parasitics
- Better Heat Dissipation
- Expansion Matched to PCB

HOW TO ORDER

HLC	02	XXX	X	T	TR	
Type	Size	Inductance	Tolerance	Termination	Packaging	
HLC = High Current	02 = 0402	Expressed in nH (2 significant digits + number of zeros) for values <10nH, letter R denotes decimal point. Example: 22nH = 220 4.7nH = 4R7	B = ±0.1nH C = ±0.2nH D = ±0.5nH G = ±2% H = ±3% J = ±5%	Sn100	5000pcs T&R	

DIMENSIONS

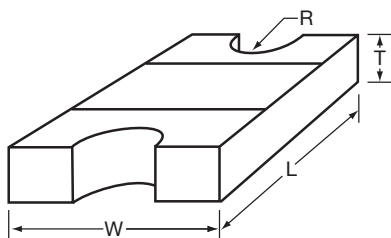

mm (inches)

L	W	T	R
1.00±0.10 (0.040±0.004)	0.58±0.075 (0.023±0.003)	0.35±0.10 (0.014±0.004)	0.125±0.050 (0.005±0.002)

QUALITY INSPECTION

Finished parts are 100% tested for electrical parameters and visual characteristics.

TERMINATION

RoHS compliant Sn finish.

OPERATING TEMPERATURE

-55°C to +125°C

0402 ELECTRICAL SPECIFICATIONS

450 MHz Test Frequency			900 MHz Test Frequency		1900 MHz Test Frequency		2400 MHz Test Frequency		SRF Min (GHz)	Rdc Max (mΩ)	Idc Max (mA)
L (nH) 450 MHz	Available Inductance Tolerance B = ±0.1nH, C = ±0.2nH D = ±0.5nH, G = ±2% H = ±3%, J = ±5%	Q 450 MHz	L (nH) 900 MHz	Q 900 MHz	L (nH) 1900 MHz	Q 1900 MHz	L (nH) 2400 MHz	Q 2400 MHz			
0.8	±0.1nH, ±0.2nH, ±0.5nH	30	0.8	42	0.8	55	0.8	61	>20	100	875
0.9	±0.1nH, ±0.2nH, ±0.5nH	26	0.9	36	0.9	47	0.9	52	>20	100	835
1	±0.1nH, ±0.2nH, ±0.5nH	25	1.0	34	1.0	45	1.0	50	>20	100	800
1.1	±0.1nH, ±0.2nH, ±0.5nH	24	1.1	33	1.1	43	1.1	48	20	100	782
1.2	±0.1nH, ±0.2nH, ±0.5nH	24	1.2	33	1.2	44	1.2	48	20	110	751
1.3	±0.1nH, ±0.2nH, ±0.5nH	25	1.3	34	1.3	44	1.3	49	19	130	725
1.5	±0.1nH, ±0.2nH, ±0.5nH	25	1.5	35	1.5	45	1.5	50	19	150	679
1.6	±0.1nH, ±0.2nH, ±0.5nH	25	1.6	35	1.6	45	1.6	49	18	150	660
1.8	±0.1nH, ±0.2nH, ±0.5nH	25	1.8	35	1.8	45	1.8	49	18	160	626
2	±0.1nH, ±0.2nH, ±0.5nH	26	2.0	35	2.0	45	2.1	49	17	180	596
2.2	±0.1nH, ±0.2nH, ±0.5nH	27	2.2	36	2.2	46	2.2	50	16	200	571
2.4	±0.1nH, ±0.2nH, ±0.5nH	27	2.4	37	2.4	47	2.4	50	15	200	549
2.7	±0.1nH, ±0.2nH, ±0.5nH	27	2.7	36	2.7	46	2.7	48	14	250	521
3	±0.1nH, ±0.2nH, ±0.5nH	27	3.0	36	3.0	44	3.1	46	12	300	497
3.3	±0.1nH, ±0.2nH, ±0.5nH	27	3.3	36	3.3	44	3.4	46	11	340	476
3.6	±0.1nH, ±0.2nH, ±0.5nH	27	3.6	37	3.7	45	3.8	46	10	350	457
3.9	±0.1nH, ±0.2nH, ±0.5nH	28	3.9	38	4.0	46	4.1	47	10	400	441
4.7	±0.1nH, ±0.2nH, ±0.5nH	29	4.7	39	4.9	45	5.1	44	9	480	405
5.6	±0.1nH, ±0.2nH, ±0.5nH	30	5.7	40	6.0	44	6.3	42	8	500	375
6.8	±2%, ±3%, ±5%	30	6.9	39	7.5	41	8.0	37	7	600	343
8.2	±2%, ±3%, ±5%	29	8.4	37	9.4	37	10.4	31	6	800	315
10	±2%, ±3%, ±5%	30	10.3	38	12.0	35	13.9	27	5	1000	290
12	±2%, ±3%, ±5%	32	12.5	40	15.7	31	19.8	19	4	1100	265
15	±2%, ±3%, ±5%	32	15.9	38	22.3	24	33.0	9	4	1200	240
18	±2%, ±3%, ±5%	28	19.4	32	31.1	15	60.0	0.3	3	1500	210
22	±2%, ±3%, ±5%	30	24.0	34	44.7	11	n/a	n/a	3	1900	202
27	±2%, ±3%, ±5%	29	30.5	30	n/a	n/a	n/a	n/a	3	2100	184
30	±2%, ±3%, ±5%	28	34.0	27	n/a	n/a	n/a	n/a	2	2200	180
32	±2%, ±3%, ±5%	28	37.7	27	n/a	n/a	n/a	n/a	2	2200	175

Specifications based on performance of component assembled properly on printed circuit board with 50Ω nominal impedance.

Idc max: Maximum 15°C rise in component temperature over ambient.



The Multilayer Organic Hi-Q Inductor is a low profile organic based inductor that can support mobile communications, satellite applications, GPS, matching networks, and collision avoidance. The MLO™ Hi-Q Inductor series of components are based on AVX's patented multilayer organic technology (US patent 6,987,307 and 7,439,840). MLO™ Hi-Q Inductors incorporate very low loss organic materials and low profile copper which allow for high Q and high stability over frequency. MLO™ Hi-Q Inductors are surface mountable and are expansion matched to FR4 printed wiring boards. MLO™ Hi-Q Inductors utilize fine line high density interconnect technology thereby allowing for tight tolerance control and high repeatability. Reliability testing is performed to JEDEC and mil standards. Finishes are available in RoHS compliant Sn.

APPLICATIONS

- Mobile communications
- Satellite Applications
- GPS
- Collision Avoidance
- Wireless LAN's

FEATURES

- High Q
- High SRF
- High Frequency
- Low DC Resistance
- Surface Mountable
- 0402 Case Size
- RoHS Compliant Finishes
- Available in Tape and Reel

SURFACE MOUNT ADVANTAGES

- Inherent Low Profile
- Excellent Solderability
- Low Parasitics
- Better Heat Dissipation
- Expansion Matched to PCB

HOW TO ORDER

HLQ	02	XXX	X	T	TR	
Type	Size	Inductance	Tolerance	Termination	Packaging	
HLQ = High Q	02 = 0402	Expressed in nH (2 significant digits + number of zeros) for values <10nH, letter R denotes decimal point. Example: 22nH = 220 4.7nH = 4R7	B = ±0.1nH C = ±0.2nH H = ±3%	Sn100	5000pcs T&R	

DIMENSIONS

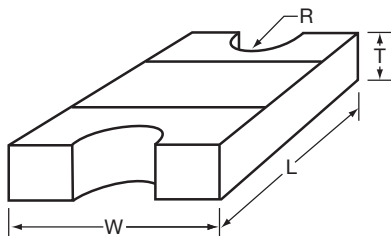

mm (inches)

L	W	T	R
1.00±0.10 (0.040±0.004)	0.58±0.075 (0.023±0.003)	0.35±0.10 (0.014±0.004)	0.125±0.050 (0.005±0.002)

QUALITY INSPECTION

Finished parts are 100% tested for electrical parameters and visual characteristics.

TERMINATION

RoHS compliant Sn finish.

OPERATING TEMPERATURE

-55°C to +125°C

0402 ELECTRICAL SPECIFICATIONS

L (nH) 450MHz	Available Inductance Tolerance B = ±0.1nH, C = ±0.2nH H = ±3%	Q min 450MHz	SRF min (GHz)	Rdc max (mΩ)	Idc max (mA)
0.8	±0.1nH, ±0.2nH	17	7	100	350
0.9	±0.1nH, ±0.2nH	17	7	100	350
1	±0.1nH, ±0.2nH	17	7	100	330
1.1	±0.1nH, ±0.2nH	17	7	100	330
1.2	±0.1nH, ±0.2nH	17	7	110	330
1.3	±0.1nH, ±0.2nH	17	7	130	330
1.5	±0.1nH, ±0.2nH	17	7	150	330
1.6	±0.1nH, ±0.2nH	17	7	150	300
1.8	±0.1nH, ±0.2nH	17	7	160	300
2	±0.1nH, ±0.2nH	17	7	180	245
2.2	±0.1nH, ±0.2nH	17	7	200	245
2.4	±0.1nH, ±0.2nH	17	7	200	245
2.7	±0.1nH, ±0.2nH	17	7	250	245
3	±0.1nH, ±0.2nH	17	7	300	225
3.3	±0.1nH, ±0.2nH	17	7	340	225
3.6	±0.1nH, ±0.2nH	17	7	350	200
3.9	±0.1nH, ±0.2nH	17	7	400	200
4.7	±0.1nH, ±0.2nH	17	7	480	195
5.6	±0.1nH, ±0.2nH	17	7	500	170
6.8	±3%	17	7	600	160
8.2	±3%	17	6	800	130
10	±3%	17	5	1000	120
12	±3%	17	4	1100	110
15	±3%	17	4	1200	110
18	±3%	17	3	1500	110
22	±3%	17	3	1900	95
27	±3%	17	3	2100	95
30	±3%	17	2	2200	85
32	±3%	17	2	2200	85

Specifications based on performance of component assembled properly on printed circuit board with 50Ω nominal impedance.

Idc max: Maximum 15°C rise in component temperature over ambient.

MLO™ INDUCTOR PERFORMANCE CHARACTERISTICS

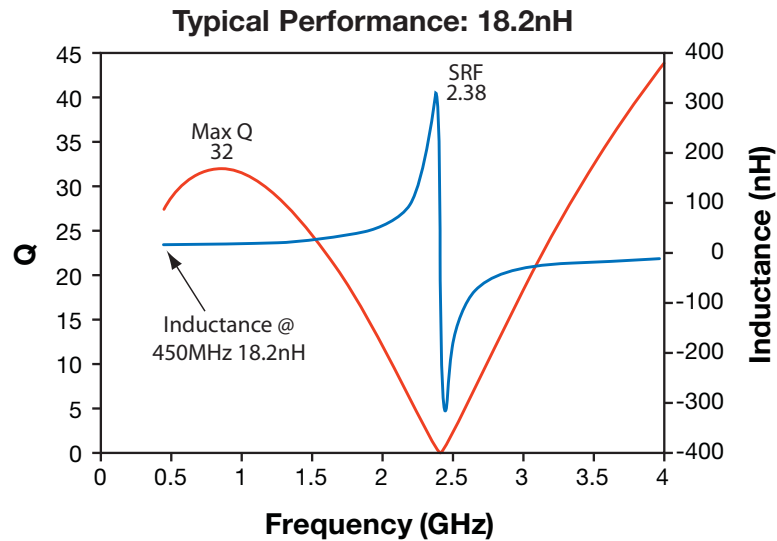
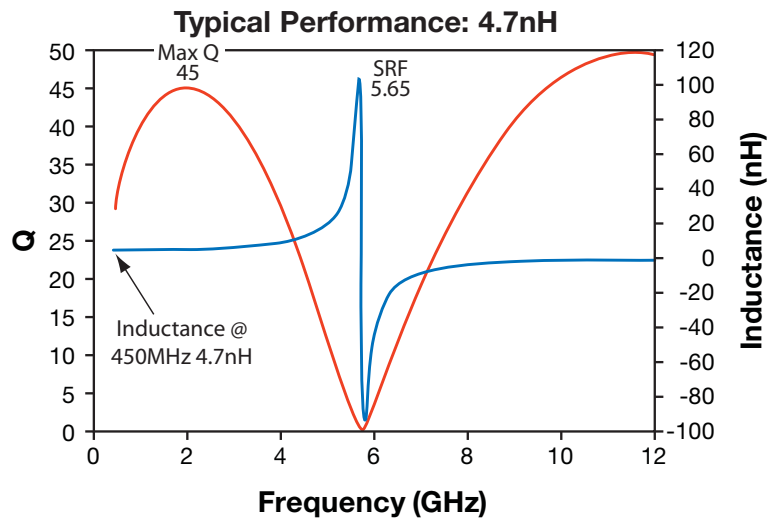
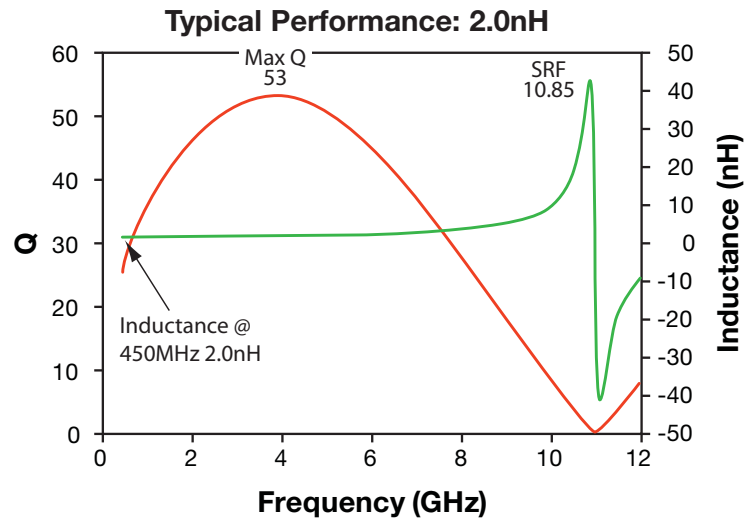

6

AUTOMATED SMT ASSEMBLY

The following section describes the guidelines for automated SMT assembly of MLO™ RF devices which are typically Land Grid Array (LGA) packages or side termination SMT packages. Control of solder and solder paste volume is critical for surface mount assembly of MLO™ RF devices onto the PCB.

Stencil thickness and aperture openings should be adjusted according to the optimal solder volume. The following are general recommendations for SMT mounting of MLO™ devices onto the PCB.

SMT REFLOW PROFILE

Common IR or convection reflow SMT processes shall be used for the assembly. Standard SMT reflow profiles, for eutectic and Pb free solders, can be used to surface mount the MLO™ devices onto the PCB. In all cases, a temperature gradient of 3°C/sec, or less, should be maintained to prevent warpage of the package and to ensure that all joints reflow properly. Additional soak time and slower preheating time

may be required to improve the out-gassing of solder paste. In addition, the reflow profile depends on the PCB density and the type of solder paste used. Standard no-clean solder paste is generally recommended. If another type of flux is used, complete removal of flux residual may be necessary. Example of a typical lead free reflow profile is shown below.

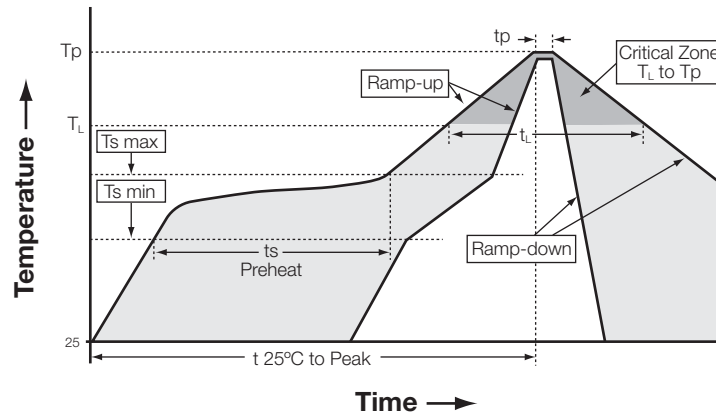
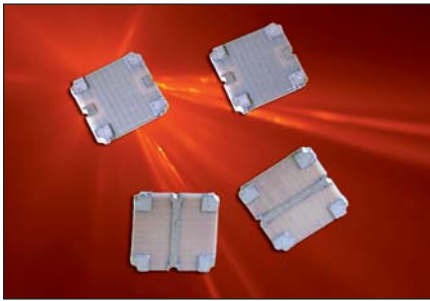

Figure A. Typical Lead Free Profile and Parameters

Profile Parameter	Pb free, Convection, IR/Convection
Ramp-up rate (T _s max to T _p)	3°C/second max.
Preheat temperature (T _s min to T _s max)	150°C to 200°C
Preheat time (t _s)	60 – 180 seconds
Time above T _L , 217°C (t _L)	60 – 120 seconds
Peak temperature (T _p)	260°C
Time within 5°C of peak temperature (t _p)	10 – 20 seconds
Ramp-down rate	4°C/second max.
Time 25°C to peak temperature	6 minutes max.



GENERAL DESCRIPTION

The MLO™ SMT RF-DC Crossover is a very low profile crossover that intersects an RF and DC circuit trace in an SMT package. The RF-DC Crossover is a low cost solution for applications where a critical RF circuit trace intersects a DC circuit precluding the need for an expensive multilayer printed circuit board. The SMT package can support frequencies up to 6 GHz. MLO™ crossovers have been subjected to JEDEC reliability standards and 100% electrically tested. The RF-DC crossovers are available in NiSn.

FEATURES

- DC – 6.0 GHz
- RF – DC Crossover
- Low Loss
- DC Isolation
- Surface Mountable
- Tape and Reel
- 100% Tested

APPLICATIONS

- Mobile communications
- GPS
- Vehicle location systems
- Wireless LAN's

LAND GRID ARRAY ADVANTAGES

- Inherent Low Profile
- Excellent Solderability
- Low Parasitics
- Better Heat Dissipation

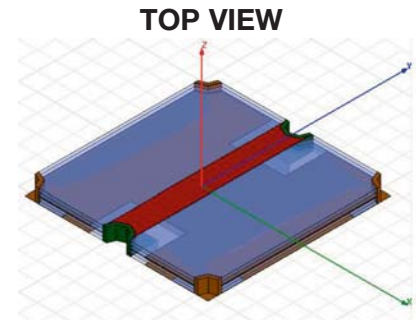

HOW TO ORDER

X2A

Series

2020

Size

RFDC

Type

T

Packaging

T = 1000pcs T&R
T/250 = 250pcs T&R
B = Bulk



Frequency (GHz)	Port Impedance (ohms)	Ins. Loss (dB max)	Return Loss (dB min)	Power (Watts)	θJC (°C /Watts)	Operating Temperature (°C)
DC -2.5	50	0.05	20	30	140	-55 to +85
2.5 – 4.0	50	0.10	20	19	140	-55 to +85
4.0 – 6.0	50	0.15	15	9	140	-55 to +85

* Specification based on performance of component assembled properly on printed circuit board with 50Ω nominal impedance.

6

QUALITY INSPECTION

Finished parts are 100% tested for electrical parameters and visual characteristics.

TERMINATION

NiSn compatible with automatic soldering technologies: Pb free reflow, wave soldering, vapor phase and manual.

OPERATING TEMPERATURE

- 55°C to +85°C

MECHANICAL OUTLINE

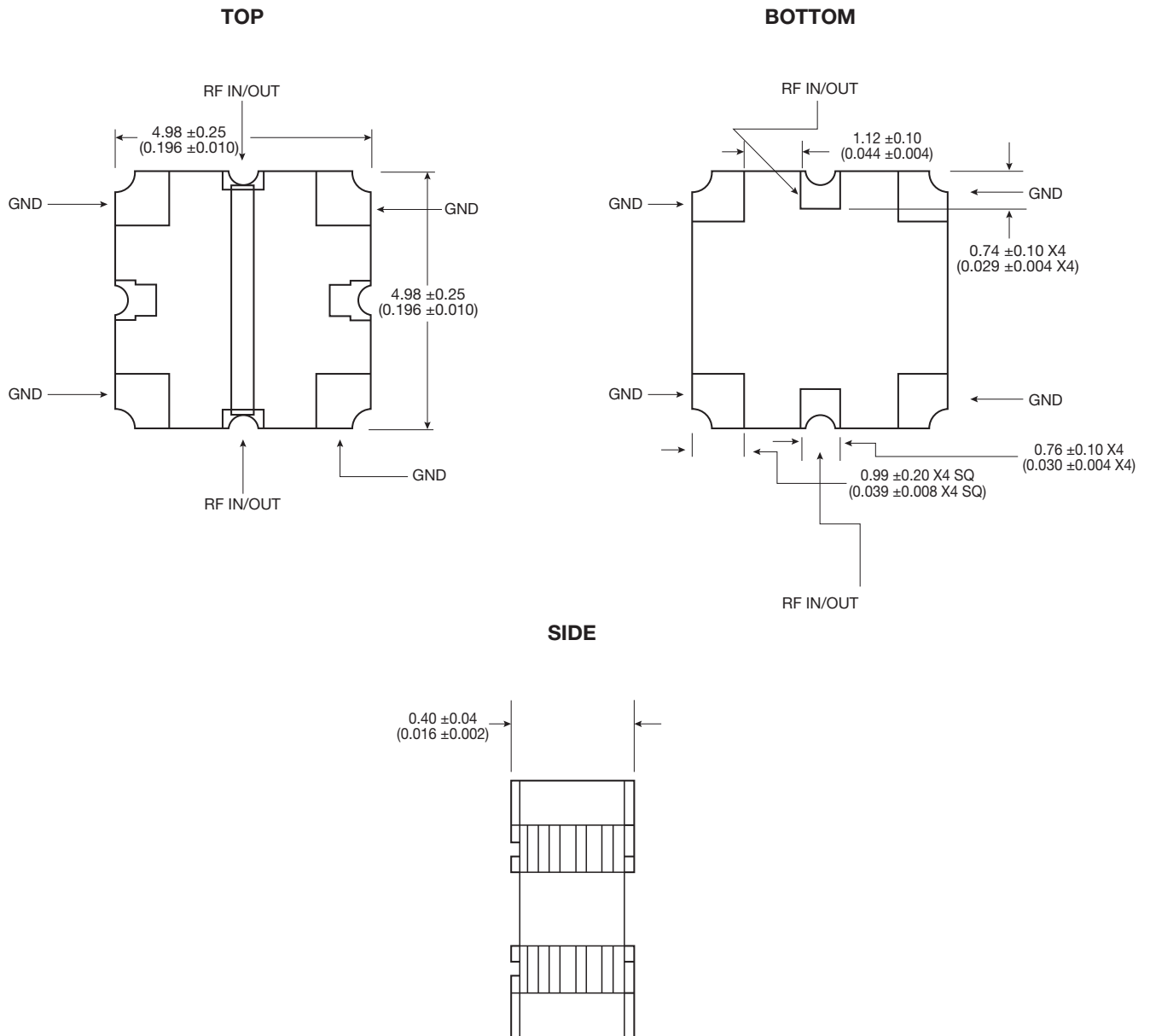

RF-DC SMT CROSSOVER PERFORMANCE: 0.3 GHz TO 6 GHz

RF/DC Crossover – Insertion Loss

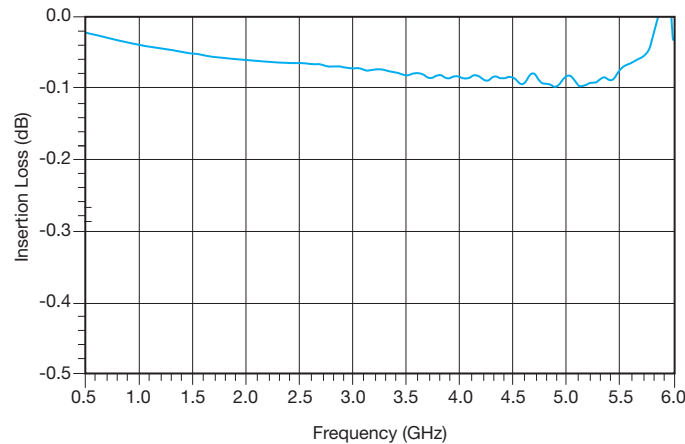

RF/DC Crossover – Return Loss

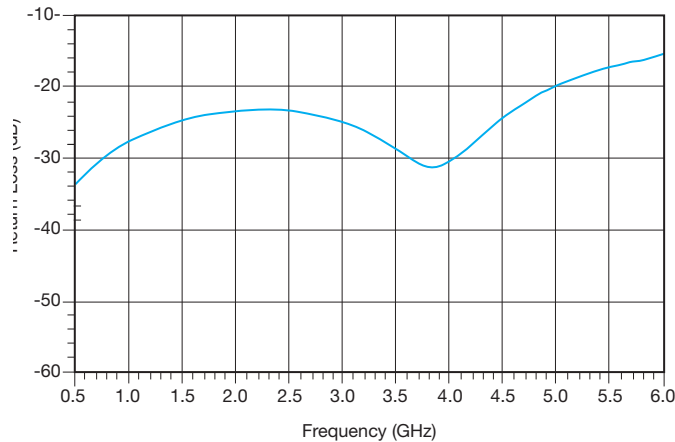

MOUNTING PROCEDURE

MLO™ SMT crossovers require 50Ω transmission lines leading to and from all of the RF ports. Proper grounding is required in order to ensure optimal device performance. If these conditions are not met then performance parameters including insertion loss, return loss and any isolation may not meet published values. All of the MLO™ components utilize castellated interconnects which allow for high yield assembly, expansion matched and halogen free dielectric. When mounting the user must be mindful of the following: a) ensure the RF pads of the device are in contact with the circuit trace of the printed circuit board and b) the ground plane of neither the component nor the PCB is in contact with the RF signal. Parts are specifically oriented in the tape and reel.

MOUNTING FOOTPRINT

To ensure proper electrical and thermal performance there must be a ground plane with 100% solder connection underneath the part.

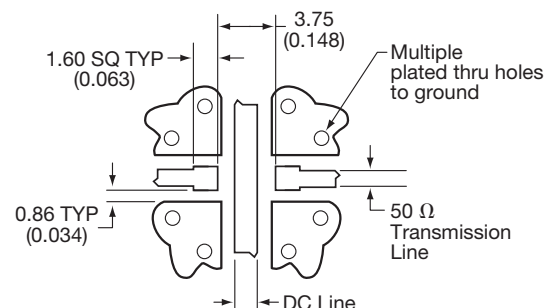
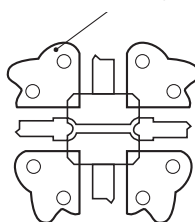

Dimensions are in mm (inches)

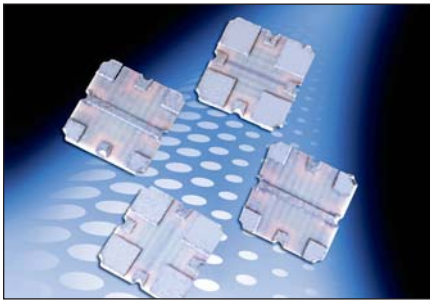

GENERAL DESCRIPTION

The MLO™ SMT RF-RF Crossover is a very low profile crossover that intersects an RF and RF circuit trace in an SMT package. The RF-RF Crossover is a low cost solution for applications where a critical RF circuit trace intersects a RF circuit precluding the need for an expensive multilayer printed circuit board. The SMT package can support frequencies up to 6 GHz. MLO™ crossovers have been subjected to JEDEC reliability standards and 100% electrically tested. The RF-RF crossovers are available in NiSn.

FEATURES

- DC – 6.0 GHz
- RF – RF Crossover
- Low Loss
- High Isolation
- Surface Mountable
- Tape and Reel
- 100% Tested

APPLICATIONS

- Mobile communications
- GPS
- Vehicle location systems
- Wireless LAN's

LAND GRID ARRAY ADVANTAGES

- Inherent Low Profile
- Excellent Solderability
- Low Parasitics
- Better Heat Dissipation

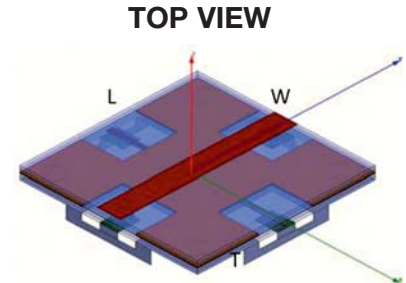

HOW TO ORDER

X2B

Series

2020

Size

RFRF

Type

T

Packaging

T = 1000pcs T&R
T/250 = 250pcs T&R
B = Bulk



Frequency (GHz)	Port Impedance (ohms)	Ins. Loss (dB max)	Return Loss (dB min)	Isolation (dB min)	Power (Watts)	θJC (°C /Watts)	Operating Temperature (°C)
DC -2.5	50	0.05	20	50	30	150	-55 to +85
2.5 – 4.0	50	0.10	18	30	19	150	-55 to +85
4.0 – 6.0	50	0.15	10	20	9	150	-55 to +85

* Specification based on performance of component assembled properly on printed circuit board with 50Ω nominal impedance.

QUALITY INSPECTION

Finished parts are 100% tested for electrical parameters and visual characteristics.

TERMINATION

NiSn compatible with automatic soldering technologies: Pb free reflow, wave soldering, vapor phase and manual.

OPERATING TEMPERATURE

- 55°C to +85°C

MECHANICAL OUTLINE

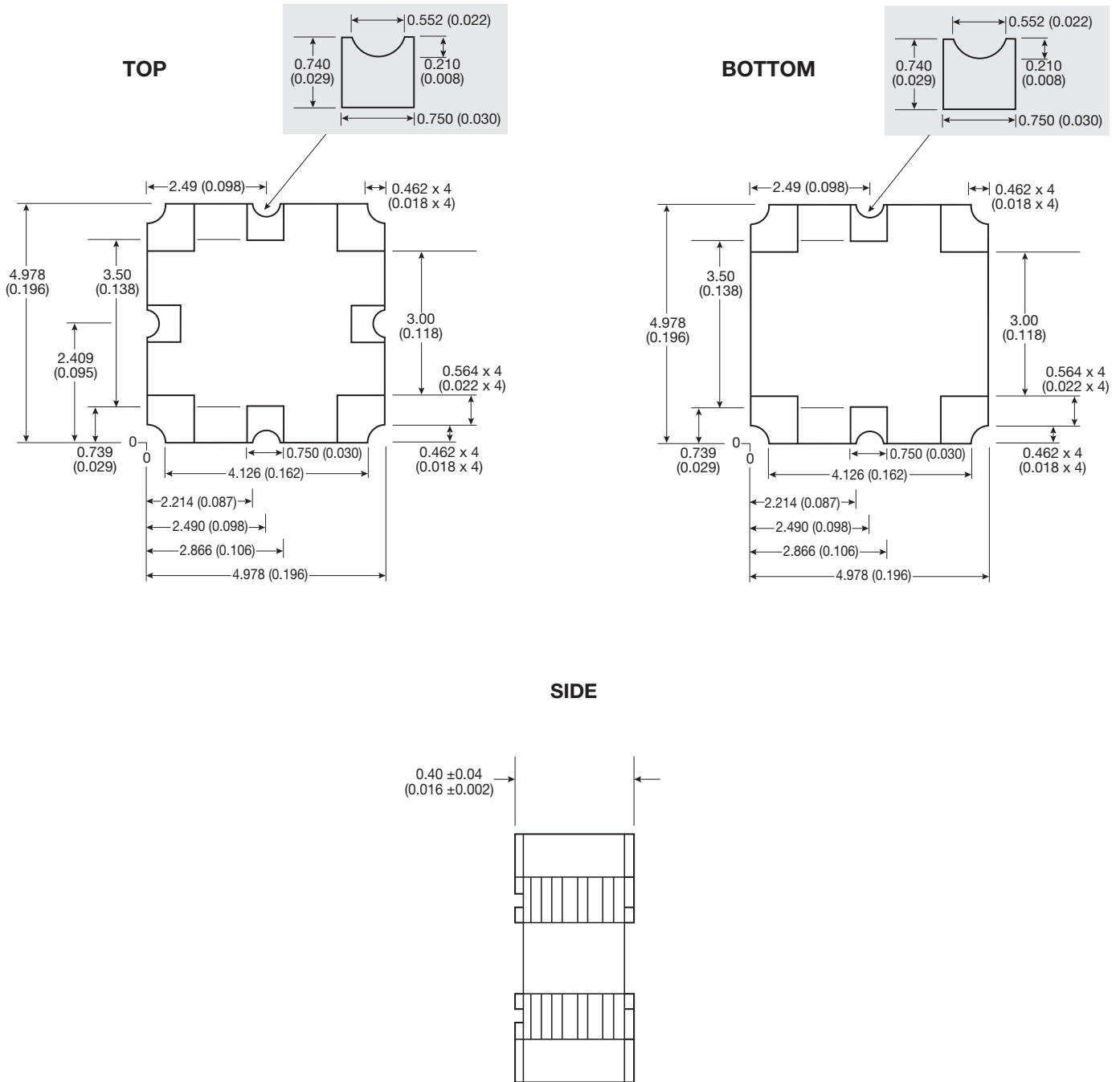

6

RF-RF SMT CROSSOVER PERFORMANCE: 0.3 GHz TO 6 GHz

RF/RF Crossover – Insertion Loss

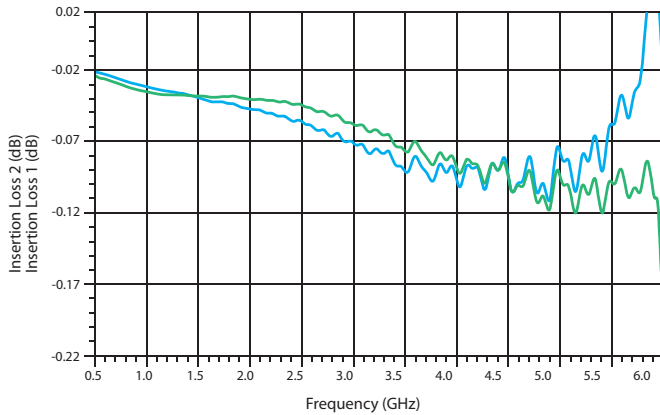

RF/RF Crossover – Return Loss

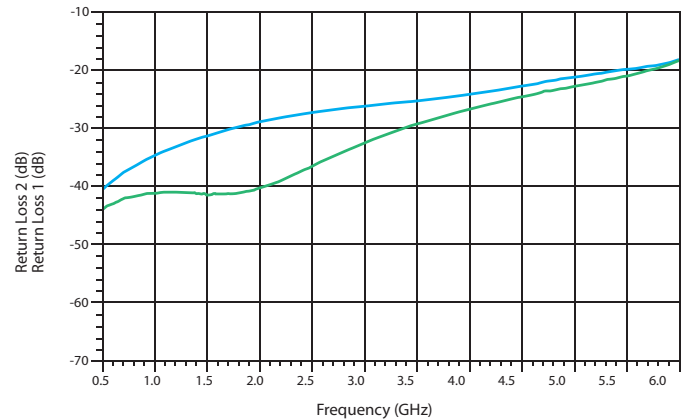

RF/RF Crossover – Isolation

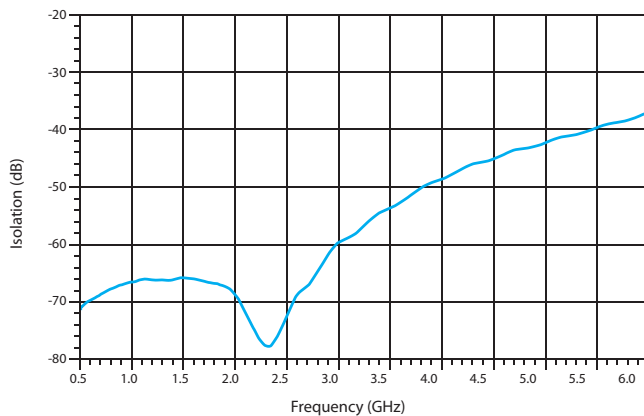

RF/RF Crossover – Phase Balance

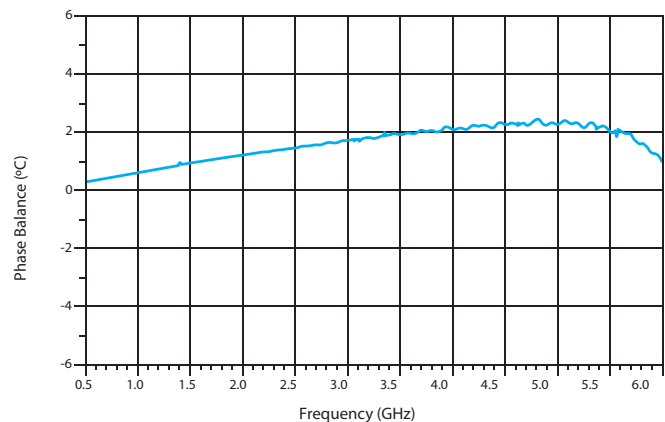

MOUNTING PROCEDURE

MLO™ SMT crossovers require 50Ω transmission lines leading to and from all of the RF ports. Proper grounding is required in order to ensure optimal device performance. If these conditions are not met then performance parameters including insertion loss, return loss and any isolation may not meet published values. All of the MLO™ components utilize castellated interconnects which allow for high yield assembly, expansion matched and halogen free dielectric. When mounting the user must be mindful of the following: a) ensure the RF pads of the device are in contact with the circuit trace of the printed circuit board and b) the ground plane of neither the component nor the PCB is in contact with the RF signal. Parts are specifically oriented in the tape and reel.

MOUNTING FOOTPRINT

To ensure proper electrical and thermal performance there must be a ground plane with 100% solder connection underneath the part.

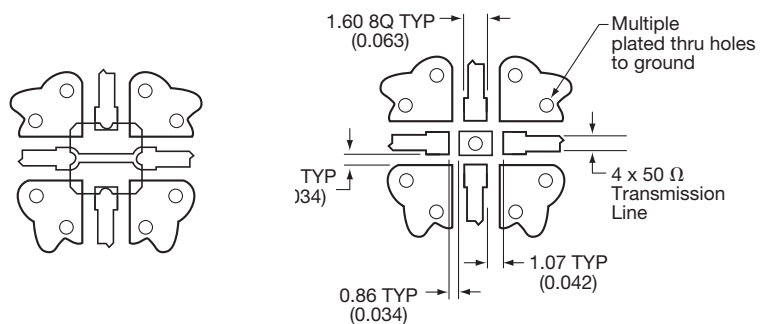

Dimensions are in mm (inches)

AUTOMATED SMT ASSEMBLY

The following section describes the guidelines for automated SMT assembly of MLO™ RF devices which are typically Land Grid Array (LGA) packages or side termination SMT packages.

Control of solder and solder paste volume is critical for

surface mount assembly of MLO™ RF devices onto the PCB. Stencil thickness and aperture openings should be adjusted according to the optimal solder volume. The following are general recommendations for SMT mounting of MLO™ devices onto the PCB.

SMT REFLOW PROFILE

Common IR or convection reflow SMT processes shall be used for the assembly. Standard SMT reflow profiles, for eutectic and Pb free solders, can be used to surface mount the MLO™ devices onto the PCB. In all cases, a temperature gradient of 3°C/sec, or less, should be maintained to prevent warpage of the package and to ensure that all joints reflow properly. Additional soak time and slower preheating time

may be required to improve the out-gassing of solder paste. In addition, the reflow profile depends on the PCB density and the type of solder paste used. Standard no-clean solder paste is generally recommended. If another type of flux is used, complete removal of flux residual may be necessary. Example of a typical lead free reflow profile is shown below:

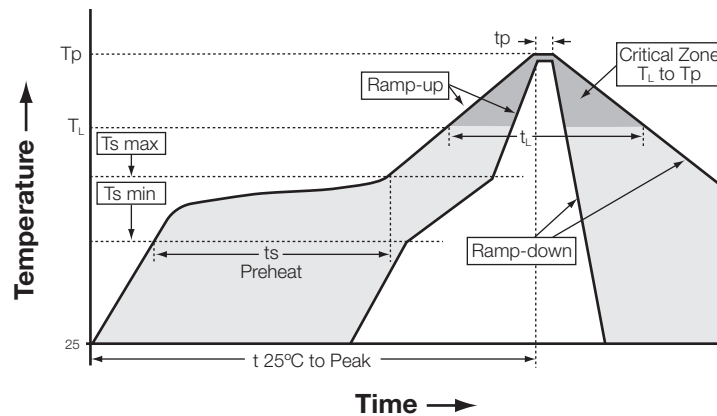

Profile Parameter	Pb free, Convection, IR/Convection
Ramp-up rate (Tsmax to Tp)	3°C/second max.
Preheat temperature (Ts min to Ts max)	150°C to 200°C
Preheat time (ts)	60 – 180 seconds
Time above T _L , 217°C (t _L)	60 – 120 seconds
Peak temperature (Tp)	260°C
Time within 5°C of peak temperature (tp)	10 – 20 seconds
Ramp-down rate	4°C/second max.
Time 25°C to peak temperature	6 minutes max.

6

AVX RF

RF Inductors

AL Series - Air Core Inductors

AS Series - Square Air Core Inductors

LCWC - Wire Wound Chip Inductors

Air Core RF Inductors



AL Series

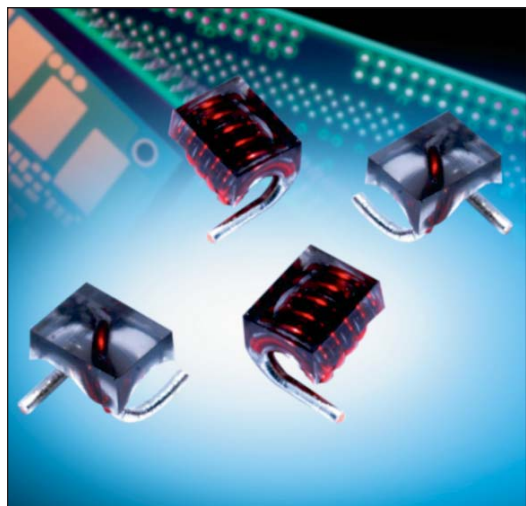

GENERAL DESCRIPTION

AVX Air Core RF Inductors, part of the wound air core inductor family, are ideal for RF circuits, broadband I/O filtering, frequency selection, or impedance matching. The air core inductor provides better performance over solid core inductors with higher Q, and better current handling capabilities.



FEATURES

- Air Core Construction
- High Q
- High Current
- Excellent SRF
- Many inductance values ranging from 1.65nH to 538nH

APPLICATIONS

- RF Applications
- RF Circuits
- Broadband I/O Filtering
- Impedance Matching/Tuning
- Decoupling/Bypassing

HOW TO ORDER

AL └	05A └	02N5 └	G └	T └	R └		
Air Core Inductor	Size	Inductance	Tolerance	Termination	Packaging		
	05A = 0605 05B = 0605 12A = 1212 12B = 1212 016 = 1516 023 = 2523	02N5 = 2.5nH 12N5 = 12.5nH 130N = 130nH	G = 2% J = 5% K = 10%	T = Sn/Ag over Cu (96.5% Sn, 3% Ag, 0.5% Cu)	R = 7" reel S = 13" reel*		
					*AL016 & AL023 Only		

ELECTRICAL SPECIFICATIONS

Technical Data	All technical data related to an ambient temperature of +25°C
Inductance Range	1.65nH to 538nH
Inductance Tolerance	2%, 5%, 10%
Rated Current	1.5A to 4.0A
Operating Temperature	-40°C to +125°C
Termination	96.5% Tin/3% Silver over 0.5% Copper

Air Core RF Inductors



AL Series

ELECTRICAL SPECIFICATIONS

AVX P/N	Turns	Inductance (nH)	Tolerance (%)	Q min.	Q typ.	Test Freq. (MHz)	DCR max (mΩ)	SRF GHz (min.)	Ir max Amps
AL05A1N65KTR	2	1.65	K	100	-	800	4	10	1.60
AL05A2N55*TR	3	2.55	J, K	100	-	800	5	8.2	1.60
AL05A3N85*TR	4	3.85	G, J, K	100	-	800	6	7.5	1.60
AL05A5N45*TR	5	5.45	G, J	100	-	800	8	7	1.60
AL05B05N6*TR	6	5.6	G, J	100	-	800	9	6.5	1.60
AL05B7N15*TR	7	7.15	G, J	100	-	800	10	6	1.60
AL05B08N8*TR	8	8.8	G, J	100	-	800	12	6	1.60
AL05B9N85*TR	9	9.85	G, J	100	-	800	13	5.2	1.60
AL05B12N5*TR	10	12.55	G, J	100	-	800	14	4.6	1.60
AL12A02N5KTR	1	2.5	K	145	-	150	1.1	12.5	4.00
AL12A05N0*TR	2	5	J, K	140	-	150	1.8	6.5	4.00
AL12A08N0*TR	3	8	G, J	140	-	150	2.6	5	4.00
AL12A12N5*TR	4	12.5	G, J	137	-	150	3.4	3.3	4.00
AL12A18N5*TR	5	18.5	G, J	132	-	150	3.9	2.5	4.00
AL12B17N5*TR	6	17.5	G, J	100	-	150	4.5	2.2	4.00
AL12B22N0*TR	7	22	G, J	102	-	150	5.2	2.1	4.00
AL12B28N0*TR	8	28	G, J	105	-	150	6	1.8	4.00
AL12B35N5*TR	9	35.5	G, J	112	-	150	6.8	1.5	4.00
AL12B43N0*TR	10	43	G, J	106	-	150	7.9	1.2	4.00
AL01622N0*TS	4	22	G, J	100	135	150	4.2	3.2	3.00
AL01627N0*TS	5	27	G, J	100	135	150	4	2.7	3.50
AL01633N0*TS	5	33	G, J	100	130	150	4.8	2.5	3.00
AL01639N0*TS	6	39	G, J	100	135	150	4.4	2.1	3.00
AL01647N0*TS	6	47	G, J	100	135	150	5.6	2.1	3.00
AL01656N0*TS	7	56	G, J	100	125	150	6.2	1.5	3.00
AL01668N0*TS	7	68	G, J	100	120	150	8.2	1.5	2.50
AL01682N0*TS	8	82	G, J	100	120	150	9.4	1.3	2.50
AL016100N*TS	9	100	G, J	100	115	150	12.3	1.2	1.70
AL016120N*TS	9	120	G, J	100	125	150	17.3	1.1	1.50
AL02390N0*TS	9	90	G, J	95	114	50	15	1.140	3.50
AL023111N*TS	10	111	G, J	87	104	50	15	1.020	3.50
AL023130N*TS	11	130	G, J	87	104	50	20	0.900	3.00
AL023169N*TS	12	169	G, J	95	114	50	25	0.875	3.00
AL023206N*TS	13	206	G, J	95	114	50	30	0.800	3.00
AL023222N*TS	14	222	G, J	92	110	50	35	0.730	3.00
AL023246N*TS	15	246	G, J	95	114	50	35	0.685	3.00
AL023307N*TS	16	307	G, J	95	114	50	35	0.660	3.00
AL023380N*TS	17	380	G, J	95	114	50	50	0.590	2.50
AL023422N*TS	18	422	G, J	95	114	50	60	0.540	2.50
AL023491N*TS	19	491	G, J	95	114	50	65	0.535	2.00
AL023538N*TS	20	538	G, J	87	104	50	90	0.490	2.00

*Tolerance: G= ± 2%, J: ± 5%, K: ± 10%

a. Test Equipment:

L/Q: HP-4291B With HP16193A test fixture or equivalent.

SRF: HP8753E /HP8720D or equivalent.

RDC: Chroma 16502 or equivalent.

b. Operating temperature range: -40°C to +125°C.

c. For Temperature Rise: 15°C

d. Storage Temp.: -40°C to +85°C.

f. MSL: Level 1

AL Series

PHYSICAL DIMENSIONS

AL12A, AL12B, AL016, AL023

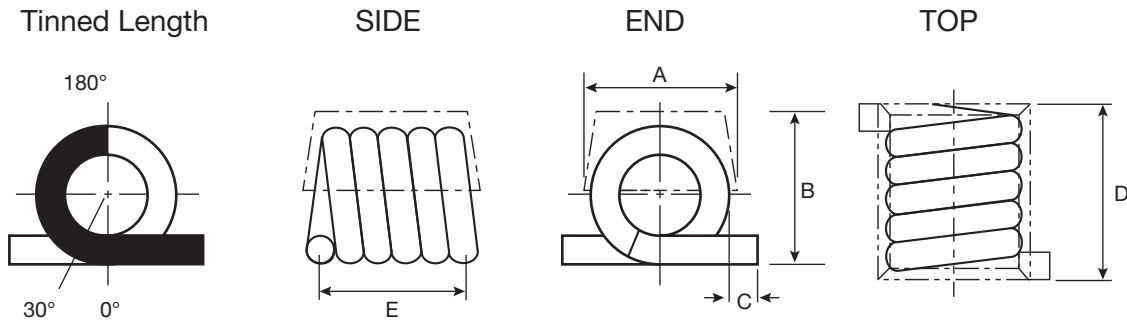

AL05A, AL05B

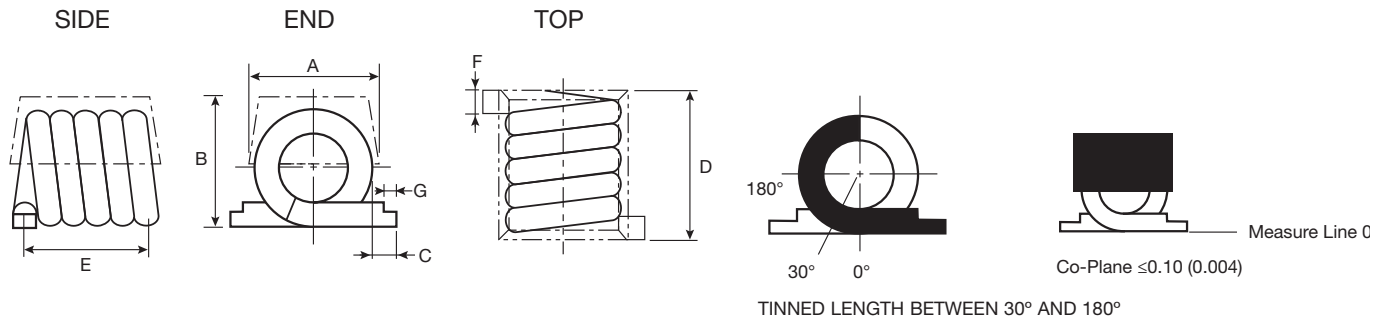

mm (inches)

Part Number	A	B	C	D	E	F	G
AL05A	1.42 ± 0.13 (0.056 ± 0.005)	1.37 ± 0.15 (0.056 ± 0.005)	0.89 ± 0.25 (0.035 ± 0.010)	2.21 ± 0.25 (0.087 ± 0.010)	1.83 ± 0.25 (0.072 ± 0.010)	0.51 max. (0.200 max.)	0.35 min. (0.014 min.)
AL05B	1.42 ± 0.13 (0.056 ± 0.005)	1.37 ± 0.15 (0.056 ± 0.005)	0.89 ± 0.25 (0.035 ± 0.010)	4.04 ± 0.30 (0.159 ± 0.012)	3.66 ± 0.30 (0.144 ± 0.012)	0.51 max. 0.200 max.	0.35 min. 0.014 min.
AL12A	3.05 max. (0.120 max.)	3.18 max. (0.125 max.)	0.58 ± 0.38 (0.023 ± 0.015)	3.68 max. (0.145 max.)	2.92 ± 0.25 (0.115 ± 0.010)	-	-
AL12B	3.05 max. (0.120 max.)	3.18 max. (0.125 max.)	0.58 ± 0.38 (0.023 ± 0.015)	6.86 max. (0.270 max.)	5.84 ± 0.25 (0.230 ± 0.010)	-	-
AL016	3.81 (0.150)	4.20 max. (0.165 max.)	1.53 ± 0.39 (0.060 ± 0.015)	4.83 max. (0.190 max.)	4.32 ± 0.39 (0.170 ± 0.015)	-	-
AL023	6.35 max. (0.250 max.)	5.90 max. (0.232 max.)	1.02 ± 0.39 (0.040 ± 0.015)	10.55 max. (0.415 max.)	7.98 ± 0.51 (0.314 ± 0.020)	-	-

RECOMMENDED LAND PATTERNS

mm (inches)

Part Number	A	B	C	D	E
AL05A	2.62 (0.103)	2.46 (0.097)	1.04 (0.041)	1.02 (0.040)	0.79 (0.031)
AL05B	4.45 (0.175)	2.46 (0.097)	2.87 (0.113)	1.02 (0.040)	0.79 (0.031)
AL12A	4.19 (0.165)	3.30 (0.130)	1.65 (0.065)	2.79 (0.110)	1.27 (0.050)
AL12B	7.24 (0.285)	3.30 (0.130)	4.70 (0.185)	2.79 (0.110)	1.27 (0.050)
AL016	5.80 (0.228)	5.16 (0.203)	2.85 (0.112)	2.62 (0.103)	1.48 (0.058)
AL023	10.0 (0.394)	4.70 (0.185)	5.95 (0.234)	2.42 (0.095)	2.04 (0.080)

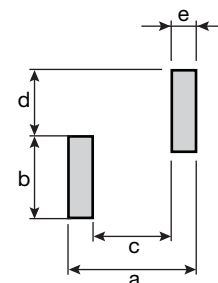

PERFORMANCE SPECIFICATIONS

AL05A

Inductance vs. Frequency

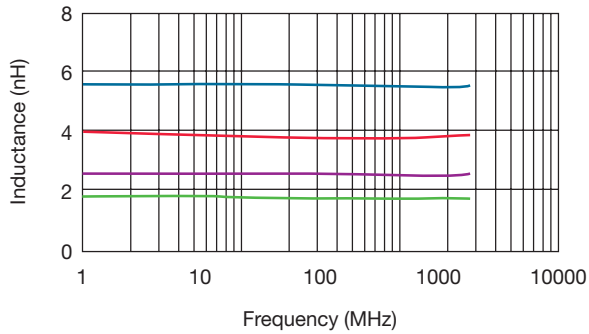

Typical Q vs. Frequency

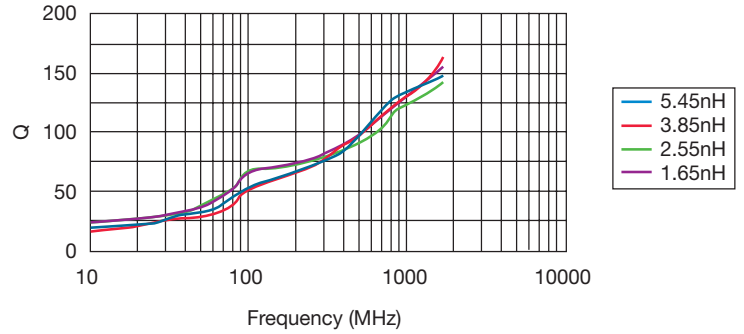

AL05B

Inductance vs. Frequency

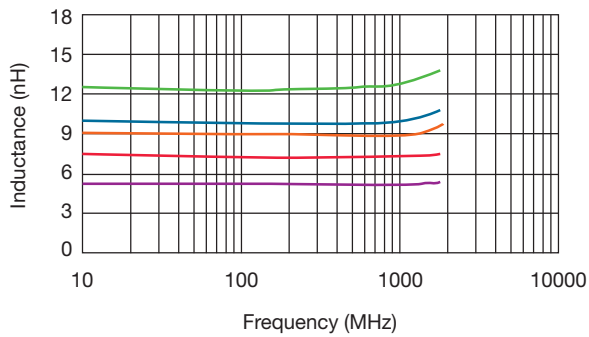

Typical Q vs. Frequency

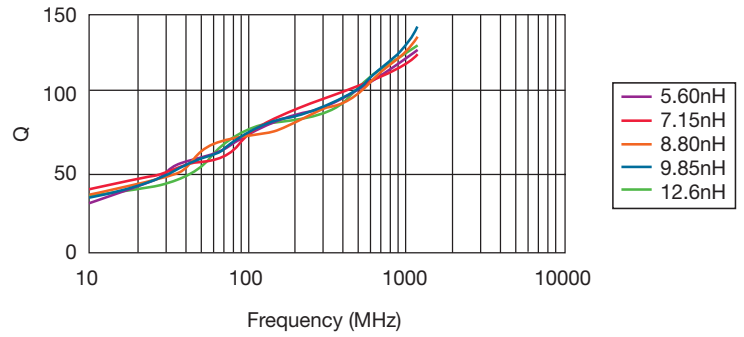

AL12A

Inductance vs. Frequency

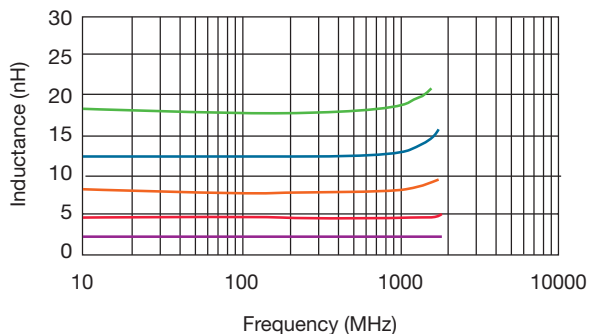

Typical Q vs. Frequency

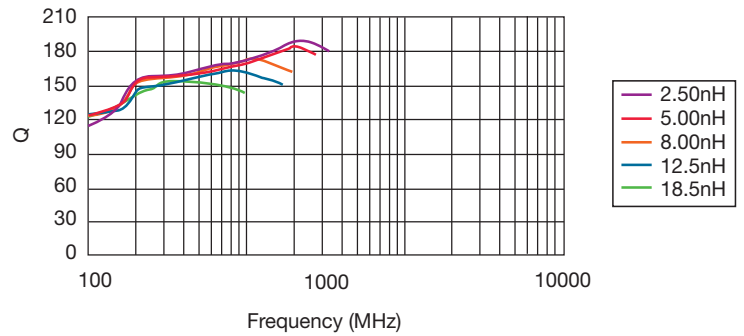

PERFORMANCE SPECIFICATIONS

AL12B

Inductance vs. Frequency

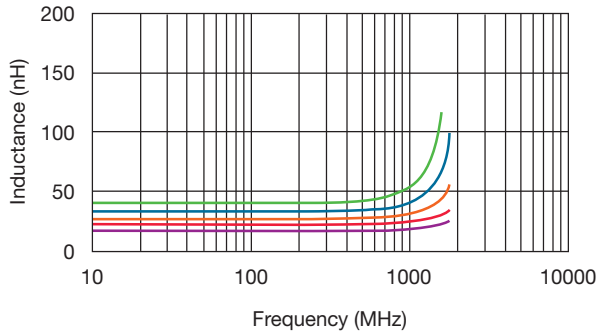

Typical Q vs. Frequency

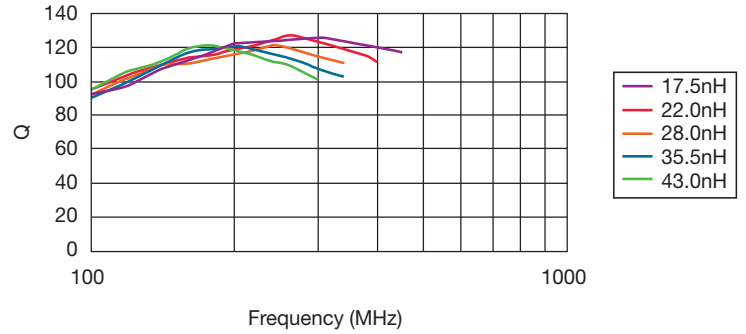

AL016

Inductance vs. Frequency

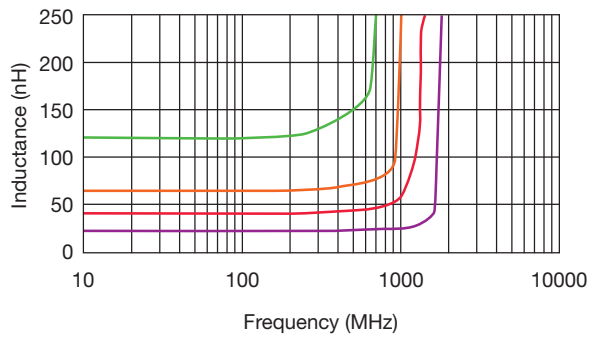

Typical Q vs. Frequency

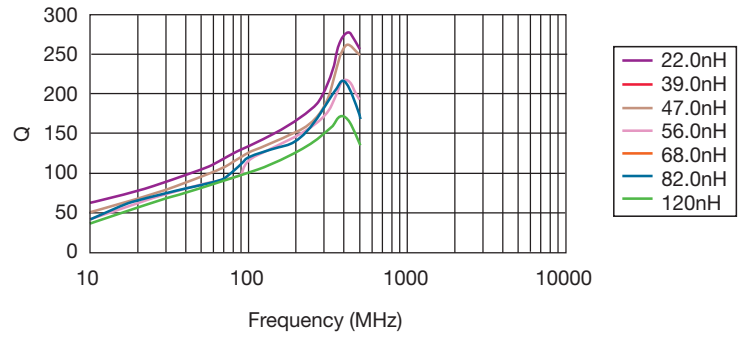

AL023

Inductance vs. Frequency

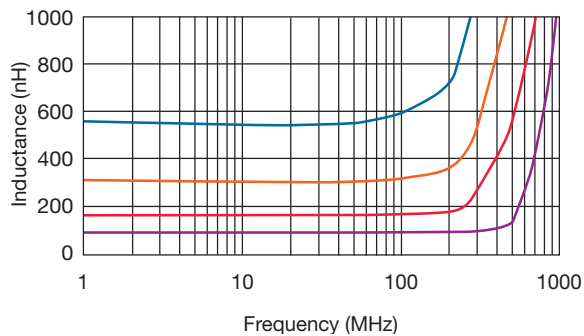

Typical Q vs. Frequency

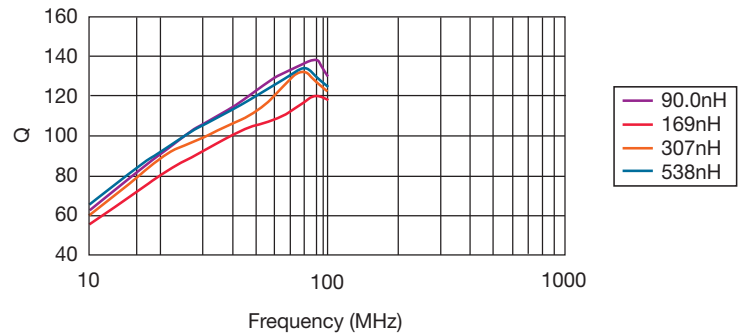

7

TYPICAL RoHS REFLOW PROFILE

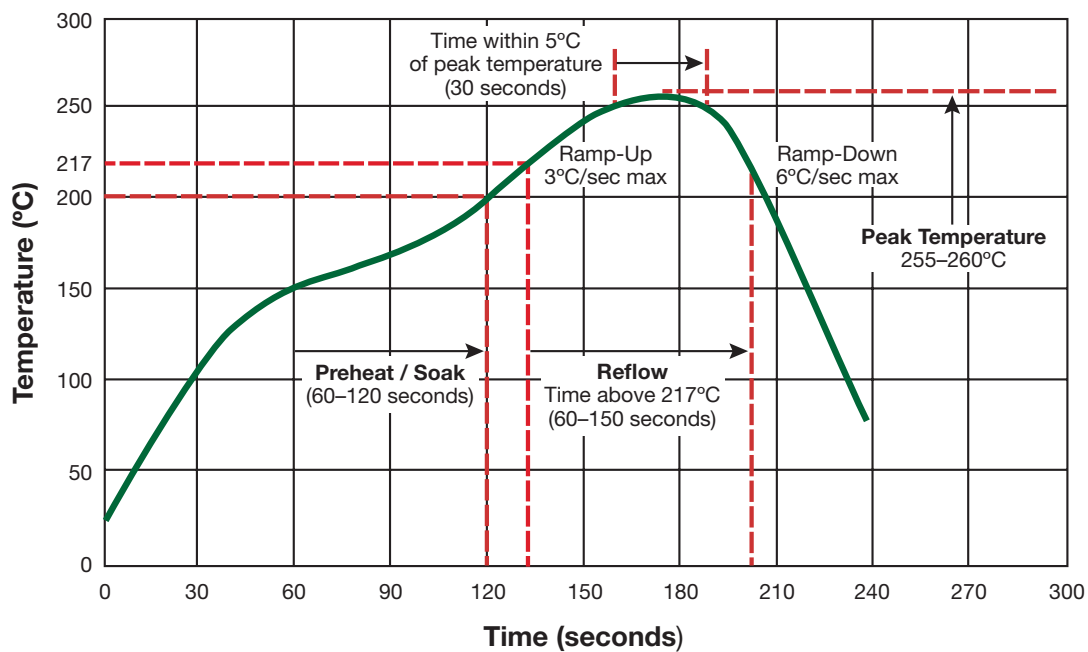

PACKAGING SPECIFICATIONS

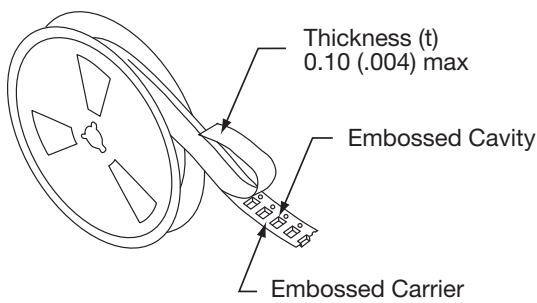

- The force for tearing off cover tape is 10 to 130 grams in the arrow direction

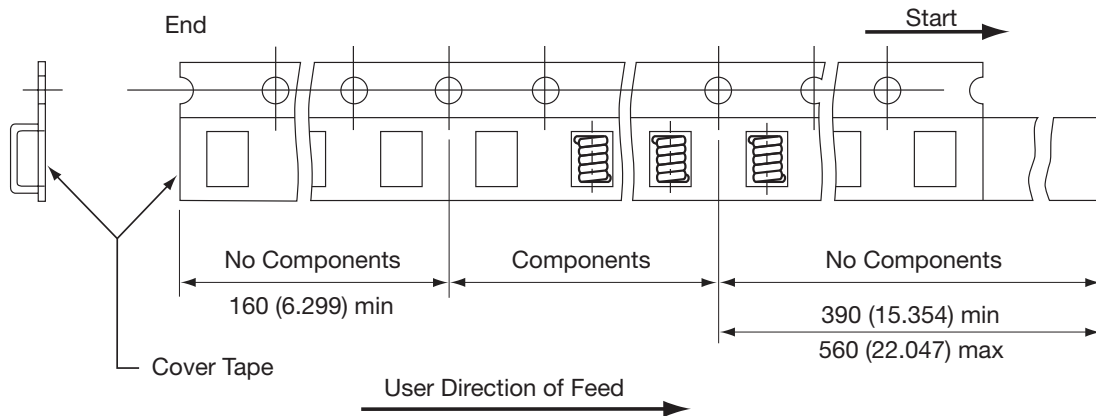
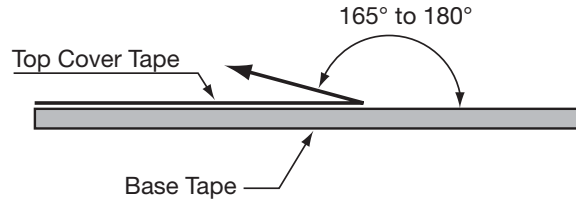

CARRIER TAPE REELS

MATERIAL: PLASTIC

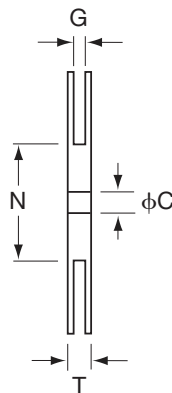
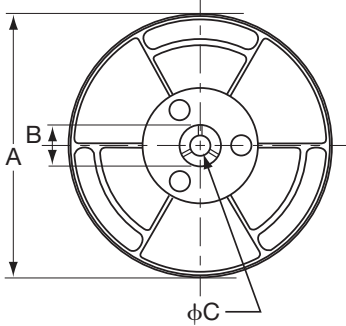

DIMENSIONS OF CARRIER TAPE

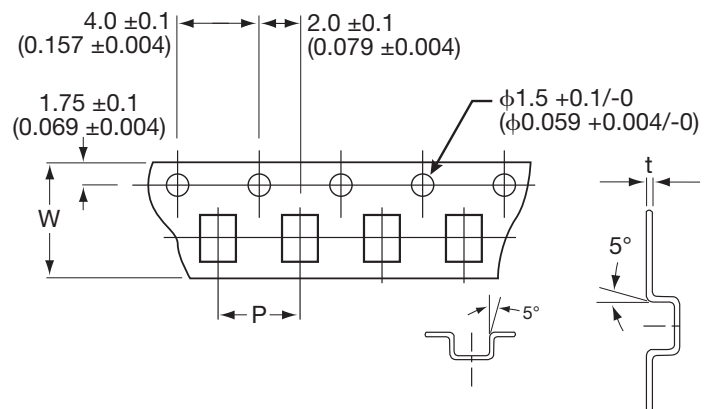

mm (inches)

Series	ITEM	A	B	C	N	G	T	W	P	t
AL05A	DIM.	178	21	13	75	8.4	12.5	8	4	0.30
	TOL.	\pm 2.0	\pm 0.8	\pm 0.8	\pm 2.0	+1.5	+1.5	\pm 0.3	\pm 0.1	\pm 0.05
AL05B	DIM.	180	21	13	50	12.4	18.4	12	4	0.35
	TOL.	MAX	\pm 0.8	+0.5/-0.2	MIN	+2.0	MAX	\pm 0.30	\pm 0.10	\pm 0.05
AL12A	DIM.	178	25	15	75	12.5	16.4	12	8	0.25
	TOL.	\pm 2.0	\pm 1.0	\pm 0.5	\pm 2.0	+1.5	+1.5	\pm 0.2	\pm 0.1	\pm 0.05
AL12B	DIM.	178	50	15	75	16.5	20.4	16	8	0.25
	TOL.	\pm 2.0	\pm 1.0	\pm 0.5	\pm 2.0	+1.5	+1.5	\pm 0.2	\pm 0.1	\pm 0.05
AL016	DIM.	340	20.2	13	100	16.5	25.5	16	12	0.30
	TOL.	MAX	MIN	\pm 0.5	REF	\pm 0.5	\pm 0.5	\pm 0.30	\pm 0.10	\pm 0.05
AL023	DIM.	340	20.2	13	100	24.5	30.4	24.0	12.0	0.35
	TOL.	MAX	MIN	\pm 0.5	REF	\pm 0.5	\pm 0.5	\pm 0.30	\pm 0.10	\pm 0.05

Square Air Core RF Inductors



AS Series

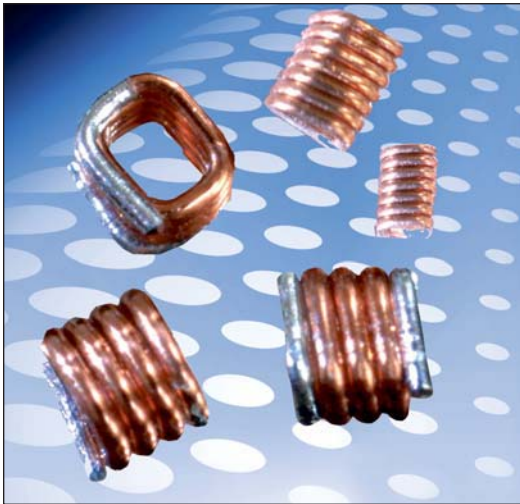

GENERAL DESCRIPTION

AVX Square Air Core RF Inductors, part of the wound air core inductor family, are ideal for RF circuits, broadband I/O filtering, frequency selection, or impedance matching. The unique square cross section of the air core inductor provides better performance, and offers manufacturing advantages over toroidal coils.

FEATURES

- Square cross section construction
- Available in 0806, 0807, and 0908 sizes
- 20 Inductance values ranging from 5.5nH to 27.3nH
- High Q
- High Current
- Excellent SRF

APPLICATIONS

- RF Applications
- RF Circuits
- Broadband I/O Filtering
- Impedance Matching

HOW TO ORDER

AS ┆	06 ┆	05N5 ┆	J ┆	T ┆	R ┆
Air Core Inductor (Square Cross Section)	Size Size	Inductance	Tolerance	Termination	Packaging
	06 = 0806 07 = 0807 08 = 0908	05N5 = 5.5nH 06N0 = 6.0nH 12N3 = 12.3nH	G = 2% J = 5% K = 10%	T = Sn/Ag over Cu (96.5% Sn, 3% Ag, 0.5% Cu)	R = 7 inch reel (2000 pieces per reel)



ELECTRICAL SPECIFICATIONS

Technical Data	All technical data related to an ambient temperature of +25°C
Inductance Range	5.5nH to 27.3nH
Inductance Tolerance	2%, 5%, 10%
Rated Current	2.7A, 2.9A, 4.4A
Operating Temperature	-40°C to +125°C
Termination	96.5% Tin/3% Silver over 0.5% Copper

ELECTRICAL SPECIFICATIONS

AVX P/N	Turns	Inductance (nH)	Tolerance (%)	Q min.	Test Freq. (MHz)	DCR max (mΩ)	SRF (GHz)	I _r max (A)
AS0605N5*TR	3	5.5	G, J, K	60	400	3.4	4.9	2.9
AS0606N0*TR	3	6	G, J, K	64	400	6	5.2	2.9
AS0608N9*TR	4	8.9	G, J, K	90	400	7	4.3	2.9
AS0612N3*TR	5	12.3	G, J, K	90	400	8	4.8	2.9
AS0615N7*TR	6	15.7	G, J, K	90	400	9	4.4	2.9
AS0619N4*TR	7	19.4	G, J, K	90	400	10	4	2.9
AS0706N9*TR	3	6.9	G, J, K	100	400	6	4.6	2.7
AS0710N2*TR	4	10.2	G, J, K	100	400	7	4	2.7
AS0711N2*TR	4	11.2	G, J, K	90	400	6.3	3.6	2.7
AS0713N7*TR	5	13.7	G, J, K	100	400	8	4.3	2.7
AS0717N0*TR	6	17	G, J, K	100	400	9	4	2.7
AS0722N0*TR	7	22	G, J, K	100	400	10	3.5	2.7
AS0808N1*TR	3	8.1	G, J, K	130	400	6	5.2	4.4
AS0812N1*TR	4	12.1	G, J, K	130	400	7	4.3	4.4
AS0814N7*TR	4	14.7	G, J, K	90	400	7.2	3	4.4
AS0816N6*TR	5	16.6	G, J, K	130	400	8	3.4	4.4
AS0821N5*TR	6	21.5	G, J, K	130	400	9	3.7	4.4
AS0823N0*TR	6	23	G, J, K	130	400	10	2.6	4.4
AS0825N0*TR	7	25	G, J, K	130	400	10	2.5	4.4
AS0827N3*TR	7	27.3	G, J, K	130	400	10	3.2	4.4

- Note: 1. *Tolerance: G=±2%, J=±5%, K=±10%
 2. Inductance & Q measured on the HP4291B. With HP16193A test fixture.
 3. SRF measured using the HP8753E
 4. Operating Temperature range: -40°C to +125°C
 5. Electrical Specifications at 25°C
 6. MSL: Level 1



Square Air Core RF Inductors



AS Series

PHYSICAL DIMENSIONS

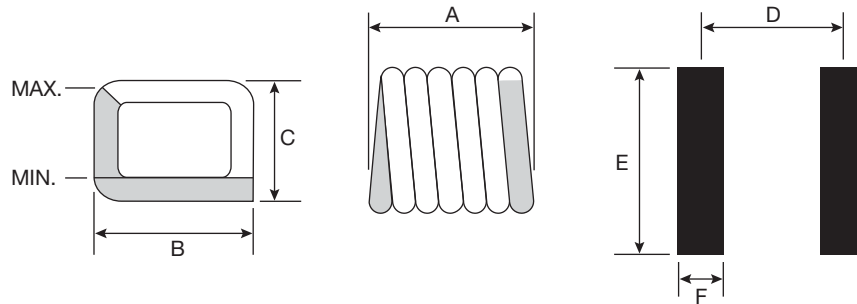

mm (inches)

Part Number	A	B	C	D	E	F
AS0605N5*TR	1.346±0.102 (0.053±0.004)	1.829±0.254 (0.072±0.01)	1.397±0.102 (0.055±0.004)	0.962 (0.038)	2.60 (0.102)	0.51 (0.020)
AS0606N0*TR	1.295±0.102 (0.051±0.004)	1.829±0.254 (0.072±0.01)	1.397±0.102 (0.055±0.004)	0.99 (0.390)	2.60 (0.102)	0.51 (0.020)
AS0608N9*TR	1.626±0.152 (0.640±0.006)	1.829±0.254 (0.072±0.01)	1.397±0.102 (0.055±0.004)	1.27 (0.050)	2.60 (0.102)	0.51 (0.020)
AS0612N3*TR	1.930±0.152 (0.076±0.006)	1.829±0.254 (0.072±0.01)	1.397±0.102 (0.055±0.004)	1.63 (0.064)	2.60 (0.102)	0.51 (0.020)
AS0615N7*TR	2.286±0.152 (0.09±0.006)	1.829±0.254 (0.072±0.01)	1.397±0.102 (0.055±0.004)	1.96 (0.070)	2.60 (0.102)	0.51 (0.020)
AS0619N4*TR	2.591±0.152 (0.102±0.006)	1.829±0.254 (0.072±0.01)	1.397±0.102 (0.055±0.004)	2.29 (0.090)	2.60 (0.102)	0.51 (0.020)
AS0706N9*TR	1.295±0.102 (0.051±0.004)	1.829±0.254 (0.072±0.01)	1.524±0.254 (0.060±0.010)	1.02 (0.040)	2.60 (0.102)	0.51 (0.020)
AS0710N2*TR	1.626±0.152 (0.064±0.006)	1.829±0.254 (0.072±0.01)	1.524±0.254 (0.060±0.010)	1.32 (0.052)	2.60 (0.102)	0.51 (0.020)
AS0711N2*TR	1.549±0.152 (0.061±0.006)	1.829±0.254 (0.072±0.01)	1.524±0.254 (0.060±0.010)	1.24 (0.049)	2.60 (0.102)	0.51 (0.020)
AS0713N7*TR	1.930±0.152 (0.076±0.006)	1.829±0.254 (0.072±0.01)	1.524±0.254 (0.060±0.010)	1.57 (0.062)	2.60 (0.102)	0.51 (0.020)
AS0717N0*TR	2.286±0.152 (0.09±0.006)	1.829±0.254 (0.072±0.01)	1.524±0.254 (0.060±0.010)	1.93 (0.076)	2.60 (0.102)	0.51 (0.020)
AS0722N0*TR	2.591±0.152 (0.102±0.006)	1.829±0.254 (0.072±0.01)	1.524±0.254 (0.060±0.010)	2.29 (0.090)	2.60 (0.102)	0.51 (0.020)
AS0808N1*TR	1.473±0.152 (0.058±0.006)	2.134±0.152 (0.084±0.006)	1.829±0.152 (0.072±0.006)	1.12 (0.044)	2.80 (0.110)	0.64 (0.025)
AS0812N0*TR	1.854±0.152 (0.073±0.006)	2.134±0.152 (0.084±0.006)	1.829±0.152 (0.072±0.006)	1.45 (0.570)	2.80 (0.110)	0.64 (0.025)
AS0814N7*TR	1.549±0.152 (0.061±0.006)	2.134±0.152 (0.084±0.006)	1.829±0.152 (0.072±0.006)	1.24 (0.049)	2.80 (0.110)	0.64 (0.025)
AS0816N6*TR	2.210±0.152 (0.087±0.006)	2.134±0.152 (0.084±0.006)	1.829±0.152 (0.072±0.006)	1.83 (0.072)	2.80 (0.110)	0.64 (0.025)
AS0821N5*TR	2.565±0.152 (0.101±0.006)	2.134±0.152 (0.084±0.006)	1.829±0.152 (0.072±0.006)	2.18 (0.086)	2.80 (0.110)	0.64 (0.025)
AS0823N0*TR	2.235±0.152 (0.088±0.006)	2.134±0.152 (0.084±0.006)	1.829±0.152 (0.072±0.006)	1.90 (0.075)	2.80 (0.110)	0.64 (0.025)
AS0825N0*TR	2.972±0.152 (0.117±0.006)	2.134±0.152 (0.084±0.006)	1.829±0.152 (0.072±0.006)	2.57 (0.101)	2.80 (0.110)	0.64 (0.025)
AS0827N3*TR	2.972±0.152 (0.117±0.006)	2.134±0.152 (0.084±0.006)	1.829±0.152 (0.072±0.006)	2.57 (0.101)	2.80 (0.110)	0.64 (0.025)

7

PERFORMANCE SPECIFICATIONS

AS06

Inductance vs. Frequency

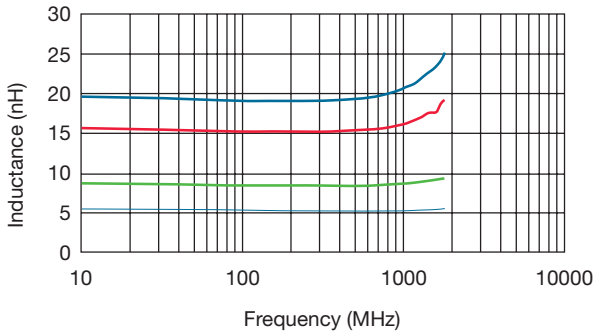

Typical Q vs. Frequency

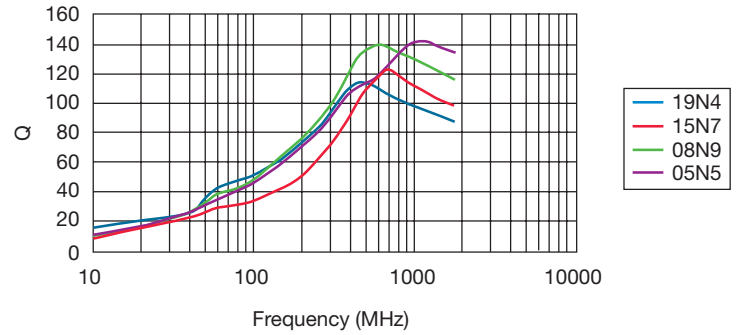

AS07

Inductance vs. Frequency

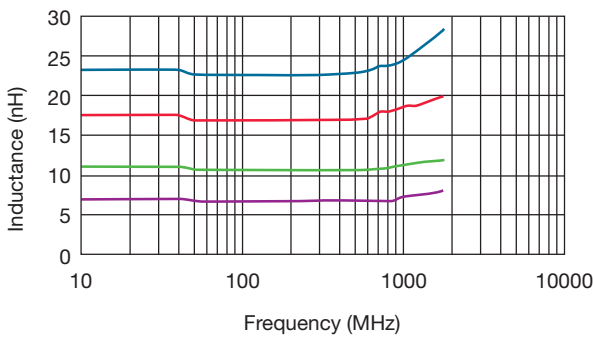

Typical Q vs. Frequency

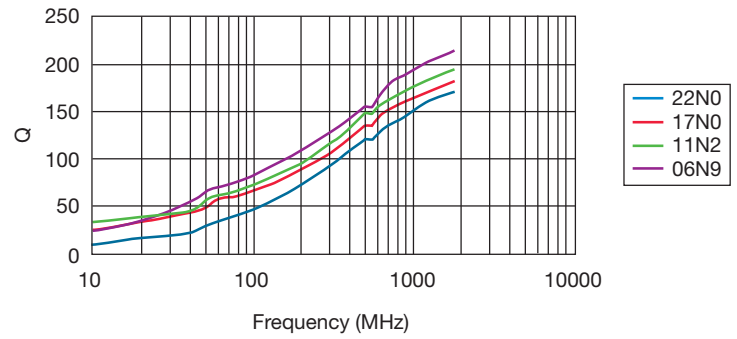

AS08

Inductance vs. Frequency

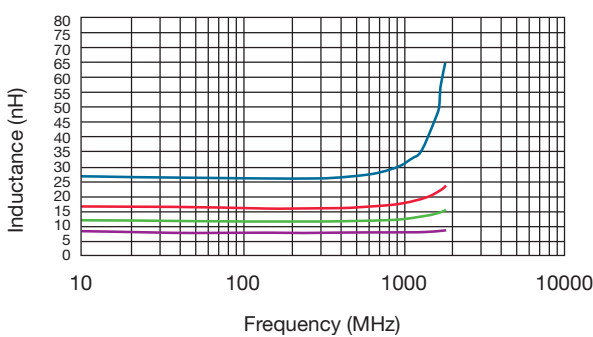

Typical Q vs. Frequency

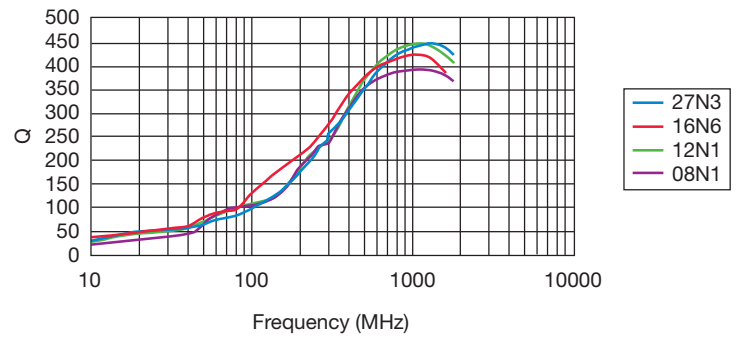

Square Air Core RF Inductors



AS Series

TYPICAL RoHS REFLOW PROFILE

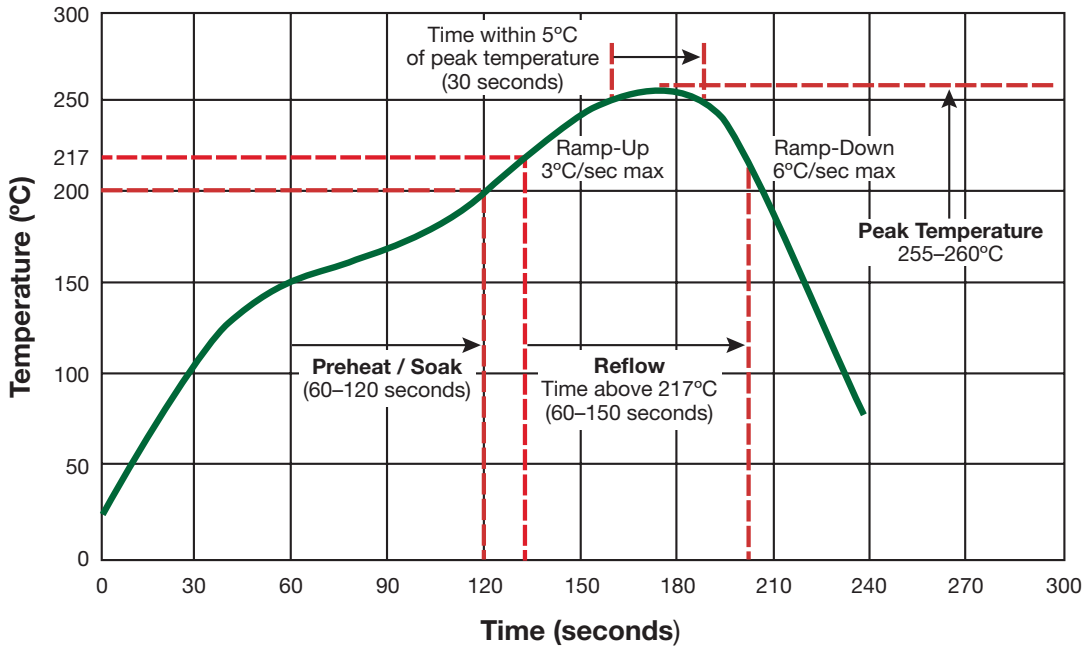

7



PACKAGING SPECIFICATIONS

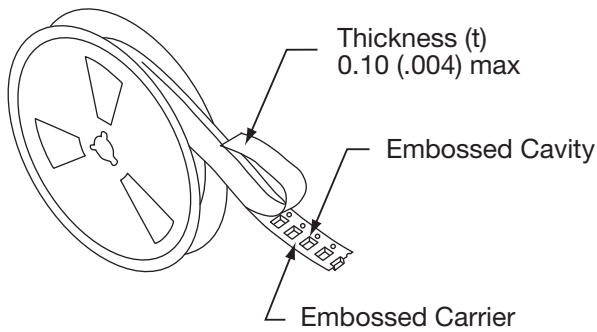

- The force for tearing off cover tape is 10 to 130 grams in the arrow direction

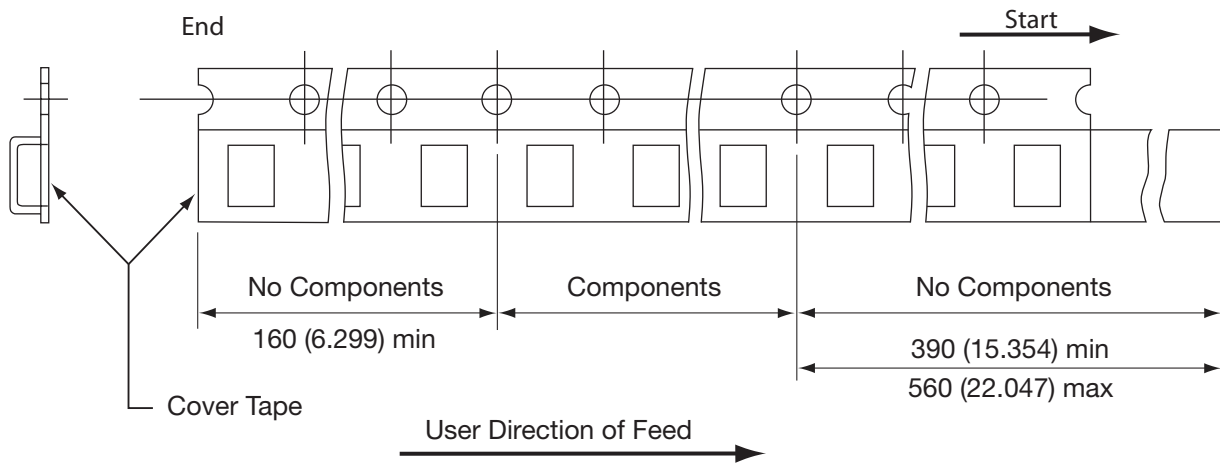
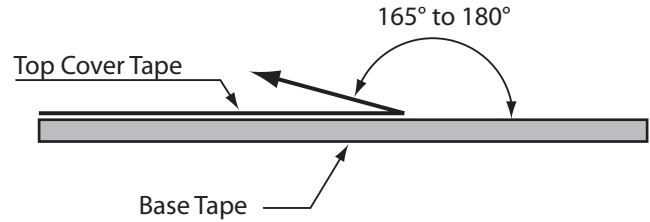

CARRIER TAPE REELS

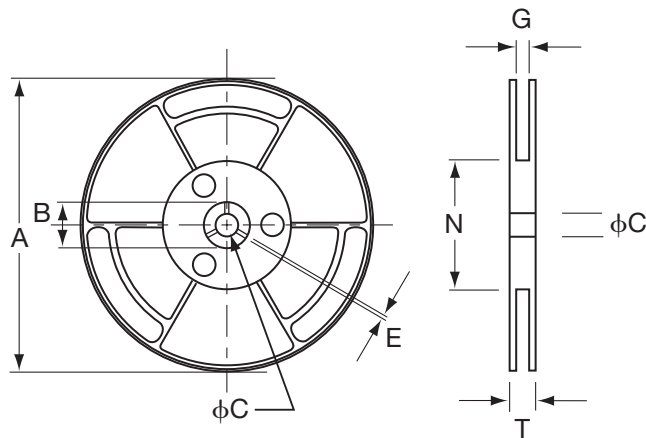

DIMENSIONS OF CARRIER TAPE

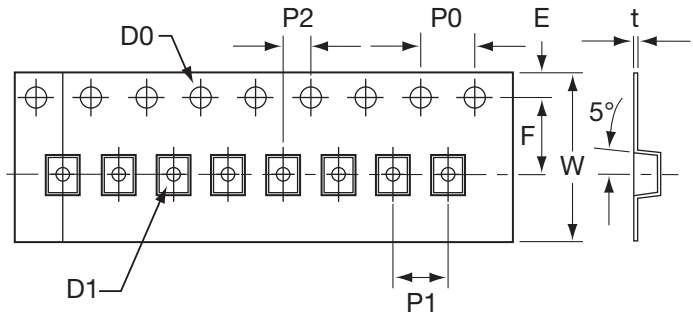

mm (inches)

ITEM	A	B	C	G	N	T	W	E	F	P1	P2	P0	D0	D1	t
DIM.	178 (7.008)	25 (0.984)	15 (0.591)	12.5 (0.492)	75 (2.953)	16.4 (0.646)	12.0 (0.472)	1.75 (0.069)	5.50 (0.217)	4.00 (0.157)	2.0 (0.079)	4.0 (0.157)	1.5 (0.059)	1.0 (0.039)	0.23 (0.009)
TOL.	±2.0 (0.079)	±1.0 (0.039)	±0.5 (0.020)	±1.5 (0.059)	±2.0 (0.079)	±1.5 (0.059)	±0.2 (0.008)	±0.1 (0.004)	±0.1 (0.004)	±0.1 (0.004)	±0.1 (0.004)	±0.1 (0.004)	±0.1 (0.004)	±0.1 (0.004)	±0.05 (0.020)

Wire Wound Chip Inductor



LCWC Series

FEATURES

- Ceramic base provide high SRF
- Ultra-compact inductors provide high Q factors
- Low profile, high current are available
- Miniature SMD chip inductor for fully automated assembly
- Outstanding endurance from Pull-up force, mechanical shock and pressure
- Tighter tolerance down to $\pm 2\%$
- Smaller size of 0402 (1005)

APPLICATIONS

RF Products:

- Cellular Phone (CDMA/GSM/PHS)
- Cordless Phone (DECT/CT1CT2)
- Remote Control, Security System
- Wireless PDA
- Smart Phone
- WLL, Wireless LAN / Mouse / Keyboard / Earphone
- VCO, RF Module & Other Wireless Products

- Base Station, Repeater

- GPS Receiver

Broad Band Applications:

- CATV Filter, Tuner
- Cable Modem/ XDSL Tuner
- Set Top Box

IT Applications:

- USB 2.0
- IEEE 1394

DIMENSIONS

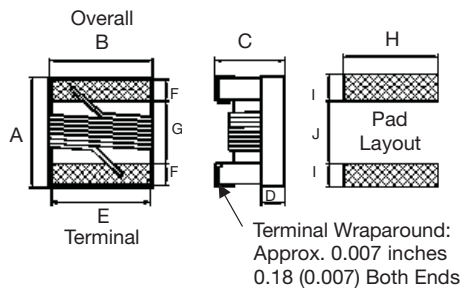

CONSTRUCTION

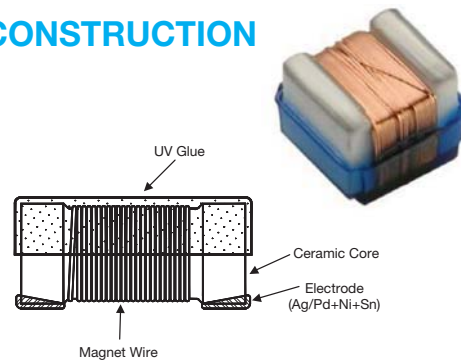

COLOR CODING

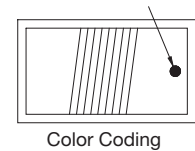

STANDARD

Type	Size (inch)	A Max.	B Max.	C Max.	D Ref.	E	F	G	H	I	J	Weight (g) (1000pcs)
0402	0402	1.27 (0.050)	0.76 (0.030)	0.61 (0.024)	0.15 (0.006)	0.51 (0.020)	0.23 (0.009)	0.56 (0.022)	0.66 (0.026)	0.50 (0.020)	0.46 (0.018)	0.8
0603	0603	1.80 (0.071)	1.12 (0.044)	1.02 (0.040)	0.38 (0.015)	0.76 (0.030)	0.33 (0.013)	0.86 (0.034)	1.02 (0.040)	0.64 (0.025)	0.64 (0.025)	3.46
0805	0805	2.29 (0.090)	1.73 (0.068)	1.52 (0.060)	0.51 (0.020)	1.27 (0.050)	0.44 (0.017)	1.02 (0.040)	1.78 (0.070)	1.02 (0.040)	0.76 (0.030)	12.13
1008	1008	2.92 (0.115)	2.79 (0.110)	2.13 (0.084)	0.65 (0.026)	2.03 (0.080)	0.51 (0.020)	1.52 (0.060)	2.54 (0.100)	1.02 (0.040)	1.27 (0.050)	30.73
1206	1206	3.45 (0.136)	1.90 (0.075)	1.40 (0.055)	0.50 (0.020)	1.60 (0.063)	0.50 (0.020)	2.20 (0.087)	1.93 (0.076)	1.02 (0.040)	1.78 (0.070)	40

LOW PROFILE

Type	Size (inch)	A Max.	B Max.	C Max.	D Ref.	E	F	G	H	I	J
0805	0805	2.29 (0.090)	1.73 (0.068)	1.03 (0.041)	0.51 (0.020)	1.27 (0.050)	0.44 (0.017)	1.02 (0.040)	1.78 (0.070)	1.02 (0.040)	0.76 (0.030)
1008	1008	2.92 (0.115)	2.79 (0.110)	1.40 (0.055)	0.65 (0.026)	2.03 (0.080)	0.51 (0.020)	1.52 (0.060)	2.54 (0.100)	1.02 (0.040)	1.27 (0.050)

HIGH CURRENT/HIGH Q

Type	Size (inch)	A Max.	B Max.	C Max.	D Ref.	E	F	G	H	I	J
0603	0603	1.80 (0.071)	1.12 (0.044)	1.02 (0.040)	0.38 (0.015)	0.76 (0.030)	0.33 (0.013)	0.86 (0.034)	1.02 (0.040)	0.64 (0.025)	0.64 (0.025)
0805	0805	2.29 (0.090)	1.73 (0.068)	1.52 (0.060)	0.51 (0.020)	1.27 (0.050)	0.44 (0.017)	1.02 (0.040)	1.78 (0.070)	1.02 (0.040)	0.76 (0.030)
1008	1008	2.92 (0.115)	2.79 (0.110)	2.03 (0.080)	0.65 (0.026)	2.03 (0.080)	0.51 (0.020)	1.52 (0.060)	2.54 (0.100)	1.02 (0.040)	1.27 (0.050)

Wire Wound Chip Inductor



LCWC Series

HOW TO ORDER

LC	WC	0402	K	101	G	T	A	R
Family	Series	Size	Tolerance	Inductance	Style	Termination	Special	Packaging
LC = Chip Inductor	WC = WW Ceramic	0402 0603 0805 1008 1206	G = 2% J = 5% K = 10%	3N9 = 3.9nH 39N = 39nH R39 = 390nH 3R9 = 3900nH 153 = 15000nH	G = Standard Q = High Q/ Current R = Low Profile	T = Sn Plate	A = Standard	R = 7" Reel



STANDARD ELECTRICAL SPECIFICATIONS

0402										
Inductance (nH)	Tolerance	L Freq. (MHz)	Quality Factor Min.	SRF Factor	DCR (Ω) max.	IDC (mA) max.	900MHz		1.7GHz	
							L	Q	L	Q
1.0	±10%	250	16	12.70	0.045	1360	1.02	77	1.02	69
1.9	±10%	250	16	11.30	0.070	1040	1.72	68	1.74	82
2.0	±10%	250	16	11.10	0.070	1040	1.93	54	1.93	75
2.2	±10%	250	19	10.80	0.070	960	2.19	59	2.23	100
2.4	±10%	250	15	10.50	0.070	790	2.24	51	2.27	68
2.7	±10%	250	16	10.40	0.120	640	2.23	42	2.25	61
3.3	±10%	250	19	7.00	0.066	840	3.10	65	3.12	87
3.6	±5, ±10%	250	19	6.80	0.066	840	3.56	45	3.62	71
3.9	±5, ±10%	250	19	5.80	0.066	840	3.89	50	4.00	75
4.3	±5, ±10%	250	18	6.00	0.091	700	4.19	47	4.30	71
4.7	±5, ±10%	250	18	4.70	0.130	640	4.55	48	4.68	68
5.1	±5, ±10%	250	20	4.80	0.083	800	5.15	56	5.25	82
5.6	±5, ±10%	250	20	4.80	0.083	760	5.16	54	5.28	81
6.2	±5, ±10%	250	20	4.80	0.083	760	6.16	52	6.37	76
6.8	±5, ±10%	250	20	4.80	0.083	680	6.56	63	6.93	78
7.5	±5, ±10%	250	22	4.80	0.104	680	7.91	60	8.22	88
8.2	±5, ±10%	250	22	4.40	0.104	680	8.50	57	8.85	84
8.7	±5, ±10%	250	18	4.10	0.200	480	8.78	54	9.21	73
9.0	±5, ±10%	250	22	4.16	0.104	680	9.07	62	9.53	78
9.5	±5, ±10%	250	18	4.00	0.200	480	9.42	54	9.98	69
10	±2, ±5, ±10%	250	21	3.90	0.195	480	9.80	50	10.10	67
11	±2, ±5, ±10%	250	24	3.68	0.120	640	10.70	52	11.20	78
12	±2, ±5, ±10%	250	24	3.60	0.120	640	11.90	53	12.70	71
13	±2, ±5, ±10%	250	24	3.45	0.210	440	13.40	51	14.60	57
15	±2, ±5, ±10%	250	24	3.28	0.172	560	14.60	55	15.50	77
16	±2, ±5, ±10%	250	24	3.10	0.220	560	16.60	46	18.80	47
18	±2, ±5, ±10%	250	25	3.10	0.230	420	18.30	57	20.30	62
19	±2, ±5, ±10%	250	24	3.04	0.202	480	19.10	50	21.10	67
20	±2, ±5, ±10%	250	25	3.00	0.250	420	20.70	52	23.70	53
22	±2, ±5, ±10%	250	25	2.80	0.300	400	23.20	53	26.80	53
23	±2, ±5, ±10%	250	24	2.72	0.300	400	23.80	49	26.90	64
24	±2, ±5, ±10%	250	25	2.70	0.300	400	25.10	51	29.50	50
27	±2, ±5, ±10%	250	24	2.48	0.300	400	28.70	49	33.50	63
30	±2, ±5, ±10%	250	25	2.35	0.350	400	31.10	46	38.50	39
33	±2, ±5, ±10%	250	24	2.35	0.350	400	34.90	31	41.70	32
36	±2, ±5, ±10%	250	24	2.32	0.440	320	39.50	44	48.40	53
39	±2, ±5, ±10%	250	25	2.10	0.550	200	41.70	47	50.20	45
40	±2, ±5, ±10%	250	24	2.24	0.500	320	39.00	44	47.40	33
43	±2, ±5, ±10%	250	25	2.03	0.810	100	45.80	46	61.60	34
47	±2, ±5, ±10%	250	25	2.10	0.830	150	50.00	38	55.80	37
51	±2, ±5, ±10%	250	25	1.75	0.820	100	50.40	47	59.40	37
56	±2, ±5, ±10%	250	25	1.76	0.970	100	57.40	49	72.40	40
68	±2, ±5, ±10%	250	22	1.62	1.120	100	69.60	45	83.40	38

Wire Wound Chip Inductor



LCWC Series

0603

Inductance (nH)	Tolerance	L Freq. (MHz)	Quality Factor Min.	SRF Factor	DCR (Ω) max.	IDC (mA) max.	900MHz		1.7GHz		Color Code
							L	Q	L	Q	
1.6	±5, ±10%	250	24	12.5	0.030	700	1.53	35	1.58	55	Blue
1.8	±5, ±10%	250	16	12.5	0.045	700	1.63	35	1.66	50	Black
2.2	±5, ±10%	250	15	6.00	0.100	700	2.18	41	2.20	64	White
2.3	±5, ±10%	250	16	>4.00	0.140	700	2.32	32	2.35	40	Yellow
3.3	±2, ±5, ±10%	250	22	>6.00	0.080	700	3.35	47	3.40	65	Red
3.6	±2, ±5, ±10%	250	22	5.80	0.063	700	3.53	49	3.58	65	Violet
3.9	±2, ±5, ±10%	250	22	>6.00	0.080	700	3.95	49	3.96	67	Brown
4.3	±2, ±5, ±10%	250	22	5.80	0.063	700	4.32	49	4.43	67	Orange
4.5	±2, ±5, ±10%	250	20	5.80	0.120	700	4.74	55	4.87	92	Gray
4.7	±2, ±5, ±10%	250	25	5.80	0.120	700	4.65	53	4.80	67	Violet
5.1	±2, ±5, ±10%	250	20	5.80	0.160	700	5.13	47	5.36	56	Green
5.6	±2, ±5, ±10%	250	20	5.80	0.170	700	5.53	56	5.86	77	Yellow
6.2	±2, ±5, ±10%	250	25	5.80	0.110	700	6.28	60	6.40	85	Black
6.3	±2, ±5, ±10%	250	25	5.80	0.110	700	6.67	41	6.86	61	Black
6.8	±2, ±5, ±10%	250	27	5.80	0.110	700	6.75	60	7.10	81	Red
7.5	±2, ±5, ±10%	250	28	4.80	0.106	700	7.70	60	7.82	65	Brown
8.2	±2, ±5, ±10%	250	27	4.80	0.110	700	8.25	64	8.40	81	Green
8.7	±2, ±5, ±10%	250	28	4.80	0.109	700	8.86	62	9.32	58	Yellow
9.1	±2, ±5, ±10%	250	35	4.80	0.130	700	9.20	70	9.70	80	Black
9.5	±2, ±5, ±10%	250	28	5.40	0.135	700	9.70	59	9.92	61	Blue
10	±2, ±5, ±10%	250	31	4.80	0.130	700	10.0	66	10.6	83	Orange
11	±2, ±5, ±10%	250	31	4.00	0.086	700	11.3	53	12.1	56	Gray
12	±2, ±5, ±10%	250	35	4.00	0.130	700	12.3	72	13.5	83	Yellow
15	±2, ±5, ±10%	250	35	4.00	0.170	700	15.4	64	16.8	89	Green
16	±2, ±5, ±10%	250	35	3.30	0.110	700	16.5	55	18.0	52	White
17	±2, ±5, ±10%	250	35	3.20	0.170	700	17.6	56	19.4	44	Red
18	±2, ±5, ±10%	250	35	3.10	0.170	700	18.7	70	21.4	69	Blue
20	±2, ±5, ±10%	250	40	3.00	0.190	700	20.7	80	23.5	30	Green
22	±2, ±5, ±10%	250	38	3.00	0.190	700	22.8	73	26.1	71	Violet
23	±2, ±5, ±10%	250	38	2.85	0.190	700	24.1	71	28.0	71	Orange
24	±2, ±5, ±10%	250	38	2.80	0.130	700	25.7	45	30.9	40	Black
27	±2, ±5, ±10%	250	40	2.80	0.220	600	29.2	74	34.6	65	Gray
30	±2, ±5, ±10%	250	40	2.80	0.150	600	31.4	47	39.8	28	Brown
33	±2, ±5, ±10%	250	40	2.30	0.220	600	36.0	67	49.5	42	White
36	±2, ±5, ±10%	250	37	2.30	0.250	600	39.1	47	48.9	24	Red
39	±2, ±5, ±10%	250	40	2.20	0.250	600	42.7	60	60.2	40	Black
43	±2, ±5, ±10%	200	38	2.00	0.280	600	46.9	44	60.3	21	Orange
47	±2, ±5, ±10%	200	38	2.00	0.280	600	52.2	62	77.2	35	Brown
51	±2, ±5, ±10%	200	38	1.90	0.280	600	55.5	69	82.2	34	Blue
56	±2, ±5, ±10%	200	38	1.90	0.310	600	62.5	56	97.0	26	Red
62	±2, ±5, ±10%	200	37	1.80	0.340	600	68.0	40	110	10	Gray
68	±2, ±5, ±10%	200	37	1.70	0.340	600	80.5	54	168	21	Orange
72	±2, ±5, ±10%	150	34	1.70	0.490	600	82.0	53	135	20	Yellow
82	±2, ±5, ±10%	150	34	1.70	0.540	400	96.2	54	177	21	Green
91	±2, ±5, ±10%	150	30	1.70	0.500	400	110.0	50	416.4	6	Brown
100	±2, ±5, ±10%	150	34	1.40	0.580	400	124.0	49	319.5	13	Blue
110	±2, ±5, ±10%	150	32	1.35	0.610	300	138.0	43	342.7	15	Violet
120	±2, ±5, ±10%	150	32	1.30	0.650	300	166.0	39	529.3	8	Gray
130	±2, ±5, ±10%	150	30	1.40	0.720	300	185.0	60	-	-	White
140	±2, ±5, ±10%	100	28	1.30	0.870	280	190.0	80	-	-	Blue
150	±2, ±5, ±10%	100	28	1.30	0.950	280	230.0	25	-	-	White
160	±2, ±5, ±10%	100	25	1.30	1.400	280	215.0	20	-	-	Yellow
180	±2, ±5, ±10%	100	25	1.25	1.400	250	305.0	22	-	-	Black
220	±2, ±5, ±10%	100	25	1.20	1.600	250	377.0	21	-	-	Brown
260	±2, ±5, ±10%	100	25	1.00	2.000	200	469.0	21	-	-	Violet
270	±2, ±5, ±10%	100	25	0.90	2.100	200	523.0	19	-	-	Red
280	±2, ±5, ±10%	100	25	1.00	2.400	100	524.0	18	-	-	Green
300	±2, ±5, ±10%	100	25	0.75	2.500	150	539.7	21	-	-	Orange
330	±2, ±5, ±10%	100	25	0.90	3.800	100	680.4	20	-	-	Blue
390	±2, ±5, ±10%	100	25	0.90	4.350	100	734.5	29	-	-	Yellow
470	±2, ±5, ±10%	100	23	0.60	3.600	80	-	-	-	-	White

7



Wire Wound Chip Inductor

LCWC Series



0805

Inductance (nH)	Tolerance	L Freq. (MHz)	Quality Factor min.	SRF (GHz) min.	DCR (Ω) max.	IDC (mA) max.	Color Code
2.7	$\pm 5, \pm 10\%$	250	80 @ 1500MHz	7.900	0.06	800	Brown
2.8	$\pm 5, \pm 10\%$	250	80 @ 1500MHz	7.900	0.06	800	Gray
3.0	$\pm 5, \pm 10\%$	250	65 @ 1500MHz	7.900	0.06	800	White
3.3	$\pm 5, \pm 10\%$	250	50 @ 1500MHz	6.000	0.08	600	Black
5.6	$\pm 5, \pm 10\%$	250	65 @ 1000MHz	5.500	0.08	600	Orange
6.2	$\pm 5, \pm 10\%$	250	50 @ 1000MHz	5.500	0.11	600	Green
6.8	$\pm 5, \pm 10\%$	250	50 @ 1000MHz	5.500	0.11	600	Brown
7.5	$\pm 5, \pm 10\%$	250	50 @ 1000MHz	4.500	0.14	600	Green
8.2	$\pm 5, \pm 10\%$	250	50 @ 1000MHz	4.700	0.12	600	Red
8.7	$\pm 5, \pm 10\%$	250	50 @ 1000MHz	4.000	0.21	400	White
10	$\pm 2, \pm 5, \pm 10\%$	250	60 @ 500MHz	4.200	0.10	600	Blue
12	$\pm 2, \pm 5, \pm 10\%$	250	50 @ 500MHz	4.000	0.15	600	Orange
15	$\pm 2, \pm 5, \pm 10\%$	250	50 @ 500MHz	3.400	0.17	600	Yellow
18	$\pm 2, \pm 5, \pm 10\%$	250	50 @ 500MHz	3.300	0.20	600	Green
22	$\pm 2, \pm 5, \pm 10\%$	250	55 @ 500MHz	2.600	0.22	500	Blue
24	$\pm 2, \pm 5, \pm 10\%$	250	50 @ 500MHz	2.000	0.22	500	Gray
27	$\pm 2, \pm 5, \pm 10\%$	250	55 @ 500MHz	2.500	0.25	500	Violet
33	$\pm 2, \pm 5, \pm 10\%$	250	60 @ 500MHz	2.050	0.27	500	Gray
36	$\pm 2, \pm 5, \pm 10\%$	250	55 @ 500MHz	1.700	0.27	500	Orange
39	$\pm 2, \pm 5, \pm 10\%$	250	60 @ 500MHz	2.000	0.29	500	White
43	$\pm 2, \pm 5, \pm 10\%$	200	60 @ 500MHz	1.650	0.34	500	Yellow
47	$\pm 2, \pm 5, \pm 10\%$	200	60 @ 500MHz	1.650	0.31	500	Black
56	$\pm 2, \pm 5, \pm 10\%$	200	60 @ 500MHz	1.550	0.34	500	Brown
68	$\pm 2, \pm 5, \pm 10\%$	200	60 @ 500MHz	1.450	0.38	500	Red
72	$\pm 2, \pm 5, \pm 10\%$	150	65 @ 500MHz	1.400	0.40	500	Green
82	$\pm 2, \pm 5, \pm 10\%$	150	65 @ 500MHz	1.300	0.42	400	Orange
91	$\pm 2, \pm 5, \pm 10\%$	150	65 @ 500MHz	1.200	0.48	400	Black
100	$\pm 2, \pm 5, \pm 10\%$	150	65 @ 500MHz	1.200	0.46	400	Yellow
110	$\pm 2, \pm 5, \pm 10\%$	150	50 @ 250MHz	1.000	0.48	400	Brown
120	$\pm 2, \pm 5, \pm 10\%$	150	50 @ 250MHz	1.100	0.51	400	Green
150	$\pm 2, \pm 5, \pm 10\%$	100	50 @ 250MHz	0.920	0.56	400	Blue
180	$\pm 2, \pm 5, \pm 10\%$	100	50 @ 250MHz	0.870	0.64	400	Violet
200	$\pm 2, \pm 5, \pm 10\%$	100	50 @ 250MHz	0.860	0.66	400	Orange
220	$\pm 2, \pm 5, \pm 10\%$	100	50 @ 250MHz	0.850	0.70	400	Gray
240	$\pm 2, \pm 5, \pm 10\%$	100	44 @ 250MHz	0.690	1.00	350	Red
250	$\pm 2, \pm 5, \pm 10\%$	100	50 @ 250MHz	0.680	1.00	350	Green
270	$\pm 2, \pm 5, \pm 10\%$	100	48 @ 250MHz	0.650	1.00	350	White
300	$\pm 2, \pm 5, \pm 10\%$	100	48 @ 250MHz	0.620	1.20	330	Yellow
330	$\pm 2, \pm 5, \pm 10\%$	100	48 @ 250MHz	0.600	1.40	310	Black
360	$\pm 2, \pm 5, \pm 10\%$	100	48 @ 250MHz	0.580	1.45	300	Green
390	$\pm 2, \pm 5, \pm 10\%$	100	48 @ 250MHz	0.560	1.50	290	Brown
430	$\pm 2, \pm 5, \pm 10\%$	50	33 @ 100MHz	0.430	1.70	230	Blue
470	$\pm 2, \pm 5, \pm 10\%$	50	33 @ 100MHz	0.375	1.70	250	Red
560	$\pm 2, \pm 5, \pm 10\%$	25	23 @ 50MHz	0.340	1.90	230	Orange
600	$\pm 2, \pm 5, \pm 10\%$	25	23 @ 50MHz	0.260	1.60	450	White
620	$\pm 2, \pm 5, \pm 10\%$	25	23 @ 50MHz	0.220	2.20	210	Yellow
680	$\pm 2, \pm 5, \pm 10\%$	25	23 @ 50MHz	0.200	2.20	190	Green
750	$\pm 2, \pm 5, \pm 10\%$	25	23 @ 50MHz	0.200	2.30	180	Blue
820	$\pm 2, \pm 5, \pm 10\%$	25	23 @ 50MHz	0.200	2.35	180	Violet
1000	$\pm 2, \pm 5, \pm 10\%$	25	20 @ 50MHz	0.100	2.50	170	Gray
1200	$\pm 2, \pm 5, \pm 10\%$	7.9	18 @ 25MHz	0.100	2.50	170	White
1500	$\pm 2, \pm 5, \pm 10\%$	7.9	16 @ 25MHz	0.100	2.50	170	Black
1800	$\pm 2, \pm 5, \pm 10\%$	7.9	16 @ 7.9MHz	0.080	2.50	170	Brown
2200	$\pm 2, \pm 5, \pm 10\%$	7.9	16 @ 7.9MHz	0.060	2.70	160	Red
2700	$\pm 2, \pm 5, \pm 10\%$	7.9	16 @ 7.9MHz	0.050	3.10	150	Orange
3300	$\pm 2, \pm 5, \pm 10\%$	7.9	15 @ 7.9MHz	0.040	4.40	90	Blue
4700	$\pm 2, \pm 5, \pm 10\%$	7.9	15 @ 7.9MHz	0.040	6.40	90	Green

Wire Wound Chip Inductor

LCWC Series



1008

Inductance (nH)	Tolerance	L Freq. (MHz)	Quality Factor min.	SRF (GHz) min.	DCR (Ω) max.	IDC (mA) max.	Color Code
*5.6	$\pm 5, \pm 10\%$	50	50 @ 1500MHz	4.000	0.15	1000	Black
*10	$\pm 2, \pm 5, \pm 10\%$	50	50 @ 500MHz	4.100	0.08	1000	Brown
*12	$\pm 2, \pm 5, \pm 10\%$	50	50 @ 500MHz	3.300	0.09	1000	Red
*15	$\pm 2, \pm 5, \pm 10\%$	50	50 @ 500MHz	2.500	0.11	1000	Orange
*18	$\pm 2, \pm 5, \pm 10\%$	50	50 @ 350MHz	2.400	0.12	1000	Yellow
*22	$\pm 2, \pm 5, \pm 10\%$	50	55 @ 350MHz	2.400	0.12	1000	Green
24	$\pm 2, \pm 5, \pm 10\%$	50	55 @ 350MHz	1.900	0.13	1000	Blue
*27	$\pm 2, \pm 5, \pm 10\%$	50	55 @ 350MHz	1.600	0.13	1000	Violet
*33	$\pm 2, \pm 5, \pm 10\%$	50	60 @ 350MHz	1.600	0.14	1000	Gray
36	$\pm 2, \pm 5, \pm 10\%$	50	60 @ 350MHz	1.600	0.15	1000	Orange
*39	$\pm 2, \pm 5, \pm 10\%$	50	60 @ 350MHz	1.500	0.15	1000	White
*47	$\pm 2, \pm 5, \pm 10\%$	50	65 @ 350MHz	1.500	0.16	1000	Black
*56	$\pm 2, \pm 5, \pm 10\%$	50	65 @ 350MHz	1.300	0.18	1000	Brown
*62	$\pm 2, \pm 5, \pm 10\%$	50	65 @ 350MHz	1.250	0.20	1000	Blue
*68	$\pm 2, \pm 5, \pm 10\%$	50	65 @ 350MHz	1.300	0.20	1000	Red
75	$\pm 2, \pm 5, \pm 10\%$	50	60 @ 350MHz	1.100	0.21	1000	White
*82	$\pm 2, \pm 5, \pm 10\%$	50	60 @ 350MHz	1.000	0.22	1000	Orange
91	$\pm 2, \pm 5, \pm 10\%$	50	50 @ 350MHz	1.000	0.45	1000	White
*100	$\pm 2, \pm 5, \pm 10\%$	25	60 @ 350MHz	1.000	0.56	650	Yellow
*120	$\pm 2, \pm 5, \pm 10\%$	25	60 @ 350MHz	0.950	0.63	650	Green
*150	$\pm 2, \pm 5, \pm 10\%$	25	45 @ 100MHz	0.850	0.70	800	Blue
*180	$\pm 2, \pm 5, \pm 10\%$	25	45 @ 100MHz	0.750	0.77	620	Violet
*220	$\pm 2, \pm 5, \pm 10\%$	25	45 @ 100MHz	0.700	0.84	500	Gray
*240	$\pm 2, \pm 5, \pm 10\%$	25	45 @ 100MHz	0.650	0.88	500	White
*270	$\pm 2, \pm 5, \pm 10\%$	25	45 @ 100MHz	0.600	0.91	690	Black
*300	$\pm 2, \pm 5, \pm 10\%$	25	45 @ 100MHz	0.585	1.00	450	Brown
*330	$\pm 2, \pm 5, \pm 10\%$	25	45 @ 100MHz	0.570	1.05	450	Red
*360	$\pm 2, \pm 5, \pm 10\%$	25	45 @ 100MHz	0.530	1.10	470	Orange
*390	$\pm 2, \pm 5, \pm 10\%$	25	45 @ 100MHz	0.500	1.12	630	Yellow
*430	$\pm 2, \pm 5, \pm 10\%$	25	45 @ 100MHz	0.480	1.15	470	Green
*470	$\pm 2, \pm 5, \pm 10\%$	25	45 @ 100MHz	0.450	1.19	470	Blue
*560	$\pm 2, \pm 5, \pm 10\%$	25	45 @ 100MHz	0.415	1.33	580	Violet
*620	$\pm 2, \pm 5, \pm 10\%$	25	45 @ 100MHz	0.375	1.40	300	Gray
*680	$\pm 2, \pm 5, \pm 10\%$	25	45 @ 100MHz	0.375	1.47	540	White
*750	$\pm 2, \pm 5, \pm 10\%$	25	45 @ 100MHz	0.360	1.54	360	Black
*820	$\pm 2, \pm 5, \pm 10\%$	25	45 @ 100MHz	0.350	1.61	400	Brown
*910	$\pm 2, \pm 5, \pm 10\%$	25	35 @ 50MHz	0.320	1.68	380	Red
*1000	$\pm 2, \pm 5, \pm 10\%$	25	35 @ 50MHz	0.290	1.75	370	Orange
*1200	$\pm 2, \pm 5, \pm 10\%$	7.9	35 @ 50MHz	0.250	2.00	310	Yellow
*1500	$\pm 2, \pm 5, \pm 10\%$	7.9	28 @ 50MHz	0.200	2.30	330	Green
*1800	$\pm 2, \pm 5, \pm 10\%$	7.9	28 @ 50MHz	0.160	2.60	300	Blue
*2200	$\pm 2, \pm 5, \pm 10\%$	7.9	28 @ 50MHz	0.160	2.80	280	Violet
*2700	$\pm 2, \pm 5, \pm 10\%$	7.9	22 @ 25MHz	0.140	3.20	290	Gray
*3300	$\pm 2, \pm 5, \pm 10\%$	7.9	22 @ 25MHz	0.110	3.40	290	White
*3900	$\pm 2, \pm 5, \pm 10\%$	7.9	18 @ 25MHz	0.100	3.60	260	Black
*4700	$\pm 2, \pm 5, \pm 10\%$	7.9	18 @ 25MHz	0.090	4.00	260	Brown
5600	$\pm 2, \pm 5, \pm 10\%$	7.9	16 @ 7.96MHz	0.020	4.00	240	Red
6800	$\pm 2, \pm 5, \pm 10\%$	7.9	15 @ 7.96MHz	0.040	4.90	200	Orange
8200	$\pm 2, \pm 5, \pm 10\%$	7.9	15 @ 7.96MHz	0.025	6.00	170	Yellow
10000	$\pm 2, \pm 5, \pm 10\%$	2.52	15 @ 7.96MHz	0.020	9.00	150	Green
12000	$\pm 2, \pm 5, \pm 10\%$	2.52	15 @ 7.96MHz	0.018	10.5	130	Blue
15000	$\pm 2, \pm 5, \pm 10\%$	2.52	15 @ 7.96MHz	0.015	11.5	120	Violet

*Test Methods | Instrument: Network | Spectrum Analyzer

7



Wire Wound Chip Inductor

LCWC Series



1206

Inductance (nH)	Tolerance	L Freq. (MHz)	Quality Factor min.	SRF (GHz) min.	DCR (Ω) max.	IDC (mA) max.	Color Code
6.8	$\pm 5, \pm 10\%$	100	30 @ 300MHz	5.50	0.07	1000	Brown
10	$\pm 5, \pm 10\%$	100	40 @ 300MHz	4.00	0.08	1000	Red
12	$\pm 5, \pm 10\%$	100	40 @ 300MHz	3.20	0.08	1000	Orange
15	$\pm 5, \pm 10\%$	100	40 @ 300MHz	3.20	0.10	1000	Yellow
18	$\pm 5, \pm 10\%$	100	50 @ 300MHz	2.80	0.10	1000	Green
22	$\pm 5, \pm 10\%$	100	50 @ 300MHz	2.20	0.10	1000	Blue
24	$\pm 5, \pm 10\%$	100	50 @ 300MHz	2.00	0.10	1000	Red
27	$\pm 2, \pm 5, \pm 10\%$	100	50 @ 300MHz	1.80	0.11	1000	Violet
33	$\pm 2, \pm 5, \pm 10\%$	100	55 @ 300MHz	1.80	0.11	1000	Gray
39	$\pm 2, \pm 5, \pm 10\%$	100	55 @ 300MHz	1.80	0.12	1000	White
47	$\pm 2, \pm 5, \pm 10\%$	100	55 @ 300MHz	1.50	0.13	1000	Black
56	$\pm 2, \pm 5, \pm 10\%$	100	55 @ 300MHz	1.45	0.14	1000	Brown
62	$\pm 2, \pm 5, \pm 10\%$	100	55 @ 300MHz	1.20	0.20	1000	Violet
68	$\pm 2, \pm 5, \pm 10\%$	100	55 @ 300MHz	1.20	0.26	950	Red
82	$\pm 2, \pm 5, \pm 10\%$	100	55 @ 300MHz	1.20	0.21	920	Orange
91	$\pm 2, \pm 5, \pm 10\%$	100	55 @ 300MHz	1.10	0.24	900	White
100	$\pm 2, \pm 5, \pm 10\%$	100	55 @ 300MHz	1.10	0.26	850	Yellow
120	$\pm 2, \pm 5, \pm 10\%$	100	55 @ 300MHz	0.75	0.26	800	Green
150	$\pm 2, \pm 5, \pm 10\%$	100	60 @ 300MHz	0.95	0.31	750	Blue
180	$\pm 2, \pm 5, \pm 10\%$	50	55 @ 300MHz	0.90	0.43	700	Violet
220	$\pm 2, \pm 5, \pm 10\%$	50	55 @ 300MHz	0.76	0.50	670	Gray
270	$\pm 2, \pm 5, \pm 10\%$	50	55 @ 300MHz	0.74	0.56	630	White
300	$\pm 2, \pm 5, \pm 10\%$	50	50 @ 150MHz	0.68	0.60	600	Green
330	$\pm 2, \pm 5, \pm 10\%$	50	45 @ 150MHz	0.65	0.62	590	Black
360	$\pm 2, \pm 5, \pm 10\%$	50	45 @ 150MHz	0.60	0.65	550	Blue
390	$\pm 2, \pm 5, \pm 10\%$	50	45 @ 150MHz	0.60	0.75	530	Brown
470	$\pm 2, \pm 5, \pm 10\%$	50	45 @ 150MHz	0.55	1.30	490	Red
560	$\pm 2, \pm 5, \pm 10\%$	35	45 @ 150MHz	0.47	1.34	460	Orange
620	$\pm 2, \pm 5, \pm 10\%$	35	45 @ 150MHz	0.47	1.58	460	Gray
680	$\pm 2, \pm 5, \pm 10\%$	35	45 @ 150MHz	0.45	1.58	430	Yellow
750	$\pm 2, \pm 5, \pm 10\%$	35	45 @ 150MHz	0.44	2.25	320	White
820	$\pm 2, \pm 5, \pm 10\%$	35	45 @ 150MHz	0.42	1.82	400	Green
910	$\pm 2, \pm 5, \pm 10\%$	35	45 @ 150MHz	0.41	2.95	310	Green
1000	$\pm 2, \pm 5, \pm 10\%$	35	45 @ 150MHz	0.40	2.80	320	Blue
1200	$\pm 2, \pm 5, \pm 10\%$	35	45 @ 150MHz	0.38	3.20	300	Violet

Wire Wound Chip Inductor

LCWC Series



LOW PROFILE ELECTRICAL SPECIFICATIONS

0805

Inductance (nH)	Tolerance	L Freq. (MHz)	Quality Factor min.	SRF (GHz) min.	DCR (Ω) max.	IDC (mA) max.	Color Code
1.8	$\pm 5\%$	250	55 @ 1500MHz	9.40	0.03	800	Black
3.9	$\pm 5, \pm 10\%$	250	60 @ 1000MHz	6.10	0.06	800	Brown
4.7	$\pm 5, \pm 10\%$	250	50 @ 1000MHz	5.50	0.06	800	Red
6.8	$\pm 5, \pm 10\%$	250	50 @ 1000MHz	5.50	0.08	800	Orange
8.2	$\pm 5, \pm 10\%$	250	50 @ 1000MHz	4.80	0.08	800	Yellow
10	$\pm 2, \pm 5, \pm 10\%$	250	55 @ 750MHz	3.30	0.08	800	Green
12	$\pm 2, \pm 5, \pm 10\%$	250	55 @ 750MHz	3.80	0.10	800	Blue
15	$\pm 2, \pm 5, \pm 10\%$	250	50 @ 500MHz	2.95	0.10	800	Violet
18	$\pm 2, \pm 5, \pm 10\%$	250	50 @ 500MHz	3.10	0.13	800	Gray
22	$\pm 2, \pm 5, \pm 10\%$	250	50 @ 500MHz	2.90	0.15	800	Whit
27	$\pm 2, \pm 5, \pm 10\%$	250	50 @ 500MHz	2.45	0.23	600	Black
33	$\pm 2, \pm 5, \pm 10\%$	250	50 @ 500MHz	2.35	0.28	600	Brown
39	$\pm 2, \pm 5, \pm 10\%$	250	50 @ 500MHz	2.20	0.33	600	Red
47	$\pm 2, \pm 5, \pm 10\%$	200	50 @ 500MHz	2.00	0.39	600	Orange
56	$\pm 2, \pm 5, \pm 10\%$	200	50 @ 500MHz	1.85	0.39	500	Yellow
68	$\pm 2, \pm 5, \pm 10\%$	200	50 @ 500MHz	1.50	0.40	500	Green
82	$\pm 2, \pm 5, \pm 10\%$	150	50 @ 500MHz	1.50	0.44	500	Blue
100	$\pm 2, \pm 5, \pm 10\%$	150	50 @ 500MHz	1.20	0.64	400	Violet
120	$\pm 2, \pm 5, \pm 10\%$	150	40 @ 250MHz	1.15	0.68	300	Gray
150	$\pm 2, \pm 5, \pm 10\%$	150	40 @ 250MHz	1.05	0.80	300	Whit
1000	$\pm 2, \pm 5, \pm 10\%$	25	16 @ 50MHz	0.08	3.50	170	Black

1008

Inductance (nH)	Tolerance	L Freq. (MHz)	Quality Factor min.	SRF (GHz) min.	DCR (Ω) max.	IDC (mA) max.	Color Code
3.3	$\pm 5, \pm 10\%$	50	42 @ 1500MHz	6.00	0.03	1000	White
4.2	$\pm 5, \pm 10\%$	50	42 @ 1500MHz	6.00	0.15	1000	Black
6.8	$\pm 5, \pm 10\%$	50	50 @ 1500MHz	5.40	0.17	1000	Brown
8.2	$\pm 5, \pm 10\%$	50	50 @ 1500MHz	5.00	0.22	1000	Red
15	$\pm 5, \pm 10\%$	50	57 @ 500MHz	3.00	0.22	1000	Orange
18	$\pm 5, \pm 10\%$	50	50 @ 350MHz	2.40	0.12	1000	Gray
20	$\pm 5, \pm 10\%$	50	72 @ 500MHz	2.40	0.33	1000	Yellow
27	$\pm 5, \pm 10\%$	50	50 @ 350MHz	1.60	0.13	850	Green
30	$\pm 5, \pm 10\%$	50	69 @ 500MHz	2.40	0.38	600	Blue
40	$\pm 5, \pm 10\%$	50	67 @ 500MHz	2.00	0.43	600	Violet
50	$\pm 2, \pm 5, \pm 10\%$	50	72 @ 500MHz	1.90	0.48	600	Gray
60	$\pm 2, \pm 5, \pm 10\%$	50	75 @ 500MHz	1.80	0.52	600	White
70	$\pm 2, \pm 5, \pm 10\%$	50	68 @ 500MHz	1.70	0.55	510	Black
80	$\pm 2, \pm 5, \pm 10\%$	50	75 @ 500MHz	1.40	0.56	510	Brown
180	$\pm 2, \pm 5, \pm 10\%$	50	50 @ 350MHz	0.90	0.40	450	Blue
560	$\pm 2, \pm 5, \pm 10\%$	25	40 @ 100MHz	0.415	1.33	400	Red

7

Wire Wound Chip Inductor

LCWC Series



HIGH CURRENT ELECTRICAL SPECIFICATIONS

0603

Inductance (nH)	Tolerance	L Freq. (MHz)	Quality Factor min.	SRF (GHz) min.	DCR (Ω) max.	IDC (mA) max.	Color Code
1.6	$\pm 5, \pm 10\%$	250	24	12.50	0.030	2400	Black
3.6	$\pm 5, \pm 10\%$	250	24	5.90	0.048	2300	Brown
3.9	$\pm 5, \pm 10\%$	250	25	5.90	0.054	2200	Red
6.8	$\pm 5, \pm 10\%$	250	35	5.80	0.054	2100	Orange
7.5	$\pm 5, \pm 10\%$	250	38	3.70	0.059	2100	Yellow
8.2	$\pm 5, \pm 10\%$	250	38	3.70	0.060	2000	White
10	$\pm 2, \pm 5, \pm 10\%$	250	38	3.70	0.071	2000	Green
12	$\pm 2, \pm 5, \pm 10\%$	250	38	3.00	0.075	2000	Blue
15	$\pm 2, \pm 5, \pm 10\%$	250	38	2.80	0.080	1900	Violet
18	$\pm 2, \pm 5, \pm 10\%$	250	40	2.80	0.099	1900	Gray
22	$\pm 2, \pm 5, \pm 10\%$	250	42	2.40	0.099	1800	White
24	$\pm 2, \pm 5, \pm 10\%$	250	42	2.40	0.105	1800	Black

HIGH Q ELECTRICAL SPECIFICATIONS

0805

Inductance (nH)	Tolerance	L Freq. (MHz)	Quality Factor min.	SRF (GHz) min.	DCR (Ω) max.	IDC (mA) max.	Color Code
2.5	$\pm 5, \pm 10\%$	250	80 @ 1500MHz	6.00	0.020	1600	Black
5.6	$\pm 5, \pm 10\%$	250	98 @ 1500MHz	6.00	0.035	1600	Brown
6.2	$\pm 5, \pm 10\%$	250	88 @ 1000MHz	4.75	0.035	1600	Red
6.8	$\pm 5, \pm 10\%$	250	80 @ 1000MHz	4.40	0.035	1600	White
8.2	$\pm 5, \pm 10\%$	250	75 @ 1000MHz	3.00	0.075	1000	Gray
10	$\pm 5, \pm 10\%$	250	80 @ 1000MHz	3.00	0.060	1600	Black
12	$\pm 5, \pm 10\%$	250	80 @ 1000MHz	3.00	0.045	1600	Orange
15	$\pm 2, \pm 5, \pm 10\%$	250	80 @ 1000MHz	2.80	0.100	1200	Black
16	$\pm 2, \pm 5, \pm 10\%$	250	72 @ 500MHz	2.95	0.060	1500	Yellow
18	$\pm 2, \pm 5, \pm 10\%$	250	75 @ 500MHz	2.55	0.060	1400	Green
20	$\pm 2, \pm 5, \pm 10\%$	250	70 @ 500MHz	2.05	0.055	1400	Blue
22	$\pm 2, \pm 5, \pm 10\%$	250	80 @ 500MHz	2.00	0.100	1200	Black
27	$\pm 2, \pm 5, \pm 10\%$	250	75 @ 500MHz	2.00	0.070	1300	Violet
30	$\pm 2, \pm 5, \pm 10\%$	250	65 @ 500MHz	1.95	0.095	1200	Gray
39	$\pm 2, \pm 5, \pm 10\%$	250	65 @ 500MHz	1.60	0.110	1100	White
48	$\pm 2, \pm 5, \pm 10\%$	200	65 @ 500MHz	1.40	0.095	1200	Black
51	$\pm 2, \pm 5, \pm 10\%$	200	65 @ 500MHz	1.40	0.120	1000	Brown

1008

Inductance (nH)	Tolerance	L Freq. (MHz)	Quality Factor min.	SRF (GHz) min.	DCR (Ω) max.	IDC (mA) max.	Color Code
3.0	$\pm 5, \pm 10\%$	50	70 @ 1500MHz	6.00	0.04	1600	Black
3.9	$\pm 5, \pm 10\%$	50	75 @ 1500MHz	6.00	0.05	1600	White
4.1	$\pm 5, \pm 10\%$	50	75 @ 1500MHz	6.00	0.05	1600	Brown
7.8	$\pm 5, \pm 10\%$	50	75 @ 500MHz	3.80	0.05	1600	Red
10	$\pm 2, \pm 5, \pm 10\%$	50	60 @ 500MHz	3.60	0.06	1600	Orange
12	$\pm 2, \pm 5, \pm 10\%$	50	70 @ 500MHz	2.80	0.06	1500	Yellow
18	$\pm 2, \pm 5, \pm 10\%$	50	62 @ 350MHz	2.70	0.07	1400	Green
22	$\pm 2, \pm 5, \pm 10\%$	50	62 @ 350MHz	2.05	0.07	1400	Blue
33	$\pm 2, \pm 5, \pm 10\%$	50	75 @ 350MHz	1.70	0.09	1300	Violet
39	$\pm 2, \pm 5, \pm 10\%$	50	75 @ 350MHz	1.30	0.09	1300	Gray
47	$\pm 2, \pm 5, \pm 10\%$	50	75 @ 350MHz	1.45	0.12	1200	White
56	$\pm 2, \pm 5, \pm 10\%$	50	75 @ 350MHz	1.23	0.12	1200	Black
68	$\pm 2, \pm 5, \pm 10\%$	50	80 @ 350MHz	1.15	0.13	1100	Brown
82	$\pm 2, \pm 5, \pm 10\%$	50	80 @ 350MHz	1.06	0.16	1100	Red
100	$\pm 2, \pm 5, \pm 10\%$	50	50 @ 350MHz	0.82	0.16	1000	Orange

Wire Wound Chip Inductor



LCWC Series

ENVIRONMENTAL CHARACTERISTICS

MECHANICAL PERFORMANCE TEST

Items	Requirement	Test Methods
Inductance	Refer to standard electrical characteristic spec.	HP4286
Q		HP4286
SRF		HP4287
DC Resistance RDC		Micro-Ohm meter (Gom-801G)
Rated Current IDC		Applied the current to coils, The inductance change should be less than 10% to initial value
Over Load	Inductors shall have no evidence of electrical and mechanical damage	Applied 2 times of rated allowed DC current to inductor for a period of 5 minutes
Withstanding Voltage	Inductors shall be no evidence of electrical and mechanical damage.	AC voltage of 500 VAC applied between inductors terminal and case for 1 min.
Insulation Resistance	1000M ohm min.	100 VDC applied between inductor terminal and case and case

MECHANICAL PERFORMANCE TEST

Items	Requirement	Test Methods
Vibration	Appearance: No damage L change: within $\pm 5\%$ Q change: within $\pm 10\%$	Test device shall be soldered on the substrate Oscillation Frequency: 10 to 55 to 10Hz for 1 min. Amplitude: 1.5 mm Time: 2 hrs for each axis (X, Y & Z), total 6 hrs
Resistance to Soldering Heat		Solder Temperature: $260 \pm 50^\circ\text{C}$ Immersion Time: 10 ± 2 seconds
Component Adhesion (Push Test)	1 lbs. For 0402 2 lbs. For 0603 3 lbs. For the rest	The device should be soldered (260 ± 5 for 10 seconds) to a tinned copper subs rate. A dynamiter force gauge should be applied to the side of the component. The device must with stand a minimum force of 2 or 4 pounds without a failure of adhesion on termination
Drop	No damage	Dropping chip by each side and each corner. Drop 10 times in total Drop height: 100 cm Drop weight: 125 g
Solderability	90% covered with solder	Inductor shall be dipped in a melted solder bath at 245 ± 5 for 3 seconds
Resistance to Solvent	No damage on appearance and marking	MIL-STD202F, Method 215D

CLIMATIC TEST

Items	Requirement	Test Methods															
Temperature Characteristic	Appearance: No damage L change: within $\pm 10\%$ Q change: within $\pm 20\%$	$-40 \sim +125^\circ\text{C}$															
Humidity		Temperature: $40 \pm 2^\circ\text{C}$ Relative Humidity: 90 ~ 95% Time: 96 ± 2 hrs Measured after exposure in the room condition for 2 hrs															
Low Temperature Storage		Temperature: $-40 \pm 2^\circ\text{C}$ Time: 96 ± 2 hrs Inductors are tested after 1 hour at room temperature															
Thermal Shock		One cycle: <table border="1" style="margin-left: 20px;"> <thead> <tr> <th>Step</th> <th>Temperature ($^\circ\text{C}$)</th> <th>Time (min.)</th> </tr> </thead> <tbody> <tr> <td>1</td> <td>-25 ± 3</td> <td>30</td> </tr> <tr> <td>2</td> <td>25 ± 2</td> <td>15</td> </tr> <tr> <td>3</td> <td>125 ± 3</td> <td>30</td> </tr> <tr> <td>4</td> <td>25 ± 2</td> <td>15</td> </tr> </tbody> </table>	Step	Temperature ($^\circ\text{C}$)	Time (min.)	1	-25 ± 3	30	2	25 ± 2	15	3	125 ± 3	30	4	25 ± 2	15
Step		Temperature ($^\circ\text{C}$)	Time (min.)														
1		-25 ± 3	30														
2		25 ± 2	15														
3	125 ± 3	30															
4	25 ± 2	15															
High Temperature Storage	Temperature: $125 \pm 2^\circ\text{C}$ Time: 96 ± 2 hrs Measured after exposure in the room condition for 1 hour																
High Temperature Load Life	Temperature: $85 \pm 2^\circ\text{C}$ Time: 1000 ± 12 hrs Load: Allowed DC current																
Damp Heat with Load	Temperature: $40 \pm 2^\circ\text{C}$ Relative Humidity: 90 ~ 95% Time: 1000 ± 12 hrs Load: Allowed DC current																

7

Wire Wound Chip Inductor

LCWC Series



REEL DIMENSIONS AND PACKAGING QUANTITY

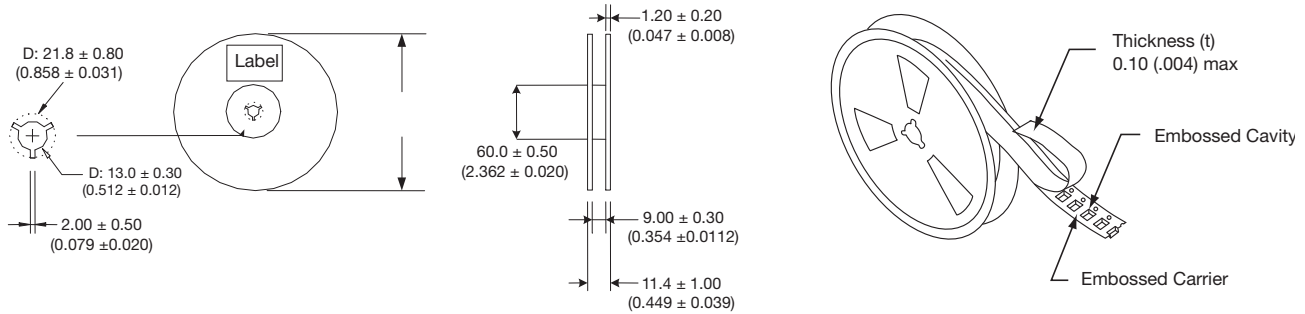

PAPER TAPE SPECIFICATION AND PACKAGING QUANTITY

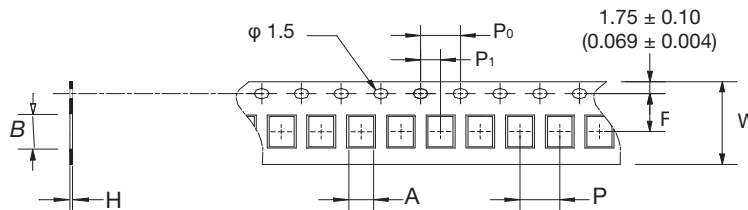

mm (inches)

Type	A	B	H	F	P	P ₀	P ₁	W	Reel (EA)
LCWC0402	0.72 (0.028)	1.19 (0.047)	0.60 (0.024)	3.50 (0.138)	4.00 (0.157)	4.00 (0.147)	2.00 (0.079)	8.00 (0.315)	4,000
LCWC0603	1.35 (0.053)	1.95 (0.077)	0.95 (0.037)	3.50 (0.138)	4.00 (0.157)	4.00 (0.147)	2.00 (0.079)	8.00 (0.315)	4,000

EMBOSSED PLASTIC PAPER TAPE SPECIFICATION AND PACKAGING QUANTITY

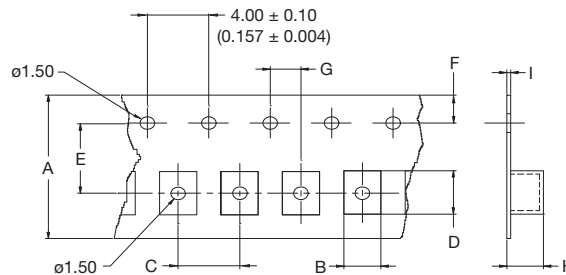

mm (inches)

Type	A	B	C	D	E	F	G	H	I	Reel (EA)
LCWC0805	8.00 ± 0.20 (0.315 ± 0.008)	1.85 ± 0.10 (0.073 ± 0.073)	4.00 ± 0.10 (0.157 ± 0.073)	2.30 ± 0.10 (0.091 ± 0.073)	3.50 ± 0.05 (0.138 ± 0.002)	1.75 ± 0.10 (0.069 ± 0.073)	2.00 ± 0.05 (0.079 ± 0.002)	1.45 ± 0.05 (0.057 ± 0.002)	0.23 ± 0.05 (0.009 ± 0.002)	2,000
LCWC0805 (R)	8.00 ± 0.20 (0.315 ± 0.008)	1.80 ± 0.10 (0.071 ± 0.073)	4.00 ± 0.10 (0.157 ± 0.073)	2.30 ± 0.10 (0.091 ± 0.073)	3.50 ± 0.05 (0.138 ± 0.002)	1.75 ± 0.10 (0.069 ± 0.073)	2.00 ± 0.05 (0.079 ± 0.002)	0.90 ± 0.05 (0.035 ± 0.002)	0.23 ± 0.05 (0.009 ± 0.002)	2,000
LCWC0805 (Q)	8.00 ± 0.20 (0.315 ± 0.008)	1.85 ± 0.10 (0.073 ± 0.073)	4.00 ± 0.10 (0.157 ± 0.073)	2.30 ± 0.10 (0.091 ± 0.073)	3.50 ± 0.05 (0.138 ± 0.002)	1.75 ± 0.10 (0.069 ± 0.073)	2.00 ± 0.05 (0.079 ± 0.002)	1.45 ± 0.05 (0.057 ± 0.002)	0.23 ± 0.05 (0.009 ± 0.002)	2,000
LCWC1206	8.00 ± 0.20 (0.315 ± 0.008)	1.95 ± 0.10 (0.077 ± 0.073)	4.00 ± 0.10 (0.157 ± 0.073)	3.50 ± 0.10 (0.138 ± 0.073)	3.50 ± 0.05 (0.138 ± 0.002)	1.75 ± 0.10 (0.069 ± 0.073)	2.00 ± 0.05 (0.079 ± 0.002)	1.50 ± 0.05 (0.059 ± 0.002)	0.23 ± 0.05 (0.009 ± 0.002)	2,000
LCWC1008	8.00 ± 0.20 (0.315 ± 0.008)	2.70 ± 0.10 (0.106 ± 0.073)	4.00 ± 0.10 (0.157 ± 0.073)	2.80 ± 0.10 (0.110 ± 0.073)	3.50 ± 0.05 (0.138 ± 0.002)	1.75 ± 0.10 (0.069 ± 0.073)	2.00 ± 0.05 (0.079 ± 0.002)	2.00 ± 0.05 (0.079 ± 0.002)	0.23 ± 0.05 (0.009 ± 0.002)	2,000
LCWC1008 (R)	8.00 ± 0.20 (0.315 ± 0.008)	2.70 ± 0.10 (0.106 ± 0.073)	4.00 ± 0.10 (0.157 ± 0.073)	2.80 ± 0.10 (0.110 ± 0.073)	3.50 ± 0.05 (0.138 ± 0.002)	1.75 ± 0.10 (0.069 ± 0.073)	2.00 ± 0.05 (0.079 ± 0.002)	1.50 ± 0.05 (0.059 ± 0.002)	0.23 ± 0.05 (0.009 ± 0.002)	2,000
LCWC1008 (Q)	8.00 ± 0.20 (0.315 ± 0.008)	2.70 ± 0.10 (0.106 ± 0.073)	4.00 ± 0.10 (0.157 ± 0.073)	2.80 ± 0.10 (0.110 ± 0.073)	3.50 ± 0.05 (0.138 ± 0.002)	1.75 ± 0.10 (0.069 ± 0.073)	2.00 ± 0.05 (0.079 ± 0.002)	2.00 ± 0.05 (0.079 ± 0.002)	0.23 ± 0.05 (0.009 ± 0.002)	2,000



RF/Microwave Capacitors

RF/Microwave Multilayer Capacitors (MLC)
RF/Microwave C0G (NP0) Capacitors
RF/Microwave “U” Series Designer Kits

Microwave MLCs

UQ Series High Q Ultra Low ESR MLC

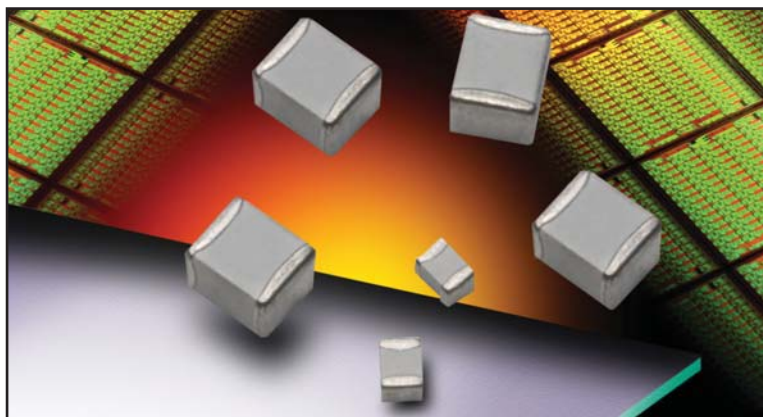

FEATURES:

- Ultra Low ESR
- High Q
- High Self Resonance
- Capacitance Range 0.1 pF to 1000 pF

APPLICATIONS:

- RF Power Amplifiers
- Low Noise Amplifiers
- Filter Networks
- MRI Systems

HOW TO ORDER

UQ ↓ AVX Style	CB ↓ Case Size CA = 0605 CB = 1210 CR = 0709 CL = 0402 CS = 0603 CF = 0805 See mechanical dimensions below	7 ↓ Voltage Code 5 = 50V 1 = 100V 2 = 200V V = 250V 9 = 300V 7 = 500V	A ↓ Temperature Coefficient Code A = 0±30ppm/°C	100 ↓ Capacitance EIA Capacitance Code in pF. First two digits = significant figures or "R" for decimal place. Third digit = number of zeros or after "R" significant figures.	J ↓ Capacitance Tolerance Code A = ±.05 pF B = ±.1 pF C = ±.25 pF D = ±.5 pF F = ±1% G = ±2% J = ±5% K = ±10% M = ±20%	A ↓ Failure Rate Code A = Not Applicable	T ↓ Termination Style Code J = Nickel Barrier Sn/Pb (60/40) **T = 100% Tin **C = Non-Magnetic Barrier/Tin	ME ↓ Packaging Code ME = 7" Reel Marked (0605, 1210 & 0709 only) 2A = 7" Unmarked (0402, 0603, & 0805 only) * Vertical T&R available
------------------------------------	---	---	--	---	---	---	--	---

****RoHS compliant**

MECHANICAL DIMENSIONS: inches (millimeters)

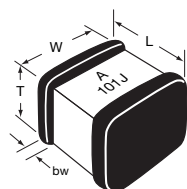

Case	Length (L)	Width (W)	Thickness (T)	Band Width (bw)
UQCA	.055 + .015 - .010 (1.40+ .381 - .254)	.055±.015 (1.40±.381)	.057 (1.45) max.	.010 + .010 - .005 (.254 +.254 - .127)
UQCB	.110 + .020 - .010 (2.79 +.508 -.254)	.110±.015 (2.79±.381)	.102 (2.59) max.	.015±.010 (.381±.254)
UQCR	.070 ± .015 (1.78 ± .381)	.090±.010 (2.29±.254)	.115 (2.92) max.	.010 + .010 - .005 (.254 +.254 - .127)
UQCL	.040 ± .004 (1.02 ± .100)	.020±.004 (0.51±.100)	.024 (.600) max.	.010 ± .006 (0.25 ± 0.15)
UQCS	.063 ± .006 (1.60 ± 0.15)	.032±.006 (0.81±0.15)	.035 (.890) max.	.014 ± .006 (0.36 ± 0.15)
UQCF	.079 ± .008 (2.01 ± 0.20)	.049±.008 (1.24±0.20)	.051 (1.30) max.	.020 ± 0.01 (0.51 ± 0.25)

TAPE & REEL: All tape and reel specifications are in compliance with EIA RS481 (equivalent to IEC 286 part 3).

- 8mm carrier
- 7" reel: UQCA = 500 or 4000 pc T&R
- UQCB = 500 or 1000 pc T&R
- UQCR = 500 or 1000 pc T&R

- UQCL = 500, 4000 or 10,000 pc T&R
- UQCS = 500 or 4000 pc T&R
- UQCF = 500 or 4000 pc T&R



For RoHS compliant products, please select correct termination style.

Also available in:
Not RoHS Compliant



ELECTRICAL SPECIFICATIONS

	Temperature Characteristic Code A
Temperature Coefficient (TCC)	(A) 0 ± 30 PPM/°C
Capacitance Range	(A) 0.1 pF to 1000 pF
Operating Temperature	0.1 pF to 1000 pF: from -55°C to +125°C
Quality Factor (Q)	Greater than 2,000 at 1 MHz
Insulation Resistance (IR)	0.1 pF to 1000 pF 10 ⁵ Megohms min. @ 25°C at rated WVDC 10 ⁴ Megohms min. @ 125°C at rated WVDC
Working Voltage (WVDC)	See Capacitance Values table
Dielectric Withstanding Voltage (DWW)	250% of rated WVDC for 5 secs
Aging Effects	None
Piezoelectric Effects	None
Capacitance Drift	\pm (0.02% or 0.02 pF), whichever is greater

ENVIRONMENTAL CHARACTERISTICS

AVX UQ will meet and exceed the requirements of EIA-198, MIL-PRF-55681 and MIL-PRF-123

Thermal Shock	Mil-STD-202, Method 107, Condition A
Moisture Resistance	Mil-STD-202, Method 106
Low Voltage Humidity	Mil-STD-202, Method 103, condition A, with 1.5 VDC applied while subjected to an environment of 85°C with 85% relative humidity for 240 hours
Life Test	Mil-STD-202, Method 108, for 2000 hours at 125°C 200% WVDC
Shock	Mil-STD-202, Method 213, Condition J
Vibration	Mil-STD-202, Method 204, Condition B
Immersion	Mil-STD-202, Method 104, Condition B
Salt Spray	Mil-STD-202, Method 101, Condition B
Solderability	Mil-STD-202, Method 208
Terminal Strength	Mil-STD-202, Method 211
Temperature Cycling	Mil-STD-202, Method 102, Condition C
Barometric Pressure	Mil-STD-202, Method 105, Condition B
Resistance to Solder Heat	Mil-STD-202, Method 210, Condition C

Microwave MLCs



UQ Series High Q Ultra Low ESR MLC

Case Size A

TABLE I: TC: A (0±30PPM/°C)

Cap. pF	Cap. Tol.	WVDC	Cap. pF	Cap. Tol.	WVDC	Cap. pF	Cap. Tol.	WVDC	Cap. pF	Cap. Tol.	WVDC
0.1	B	250	1.6	B, C, D	250	5.6	B, C, D	250	24	F, G, J, K, M	250
0.2	B	250	1.7	B, C, D	250	6.2	B, C, D	250	27	F, G, J, K, M	250
0.3	B,C	250	1.8	B, C, D	250	6.8	B, C, J, K	250	30	F, G, J, K, M	250
0.4	B,C	250	1.9	B, C, D	250	7.5	B, C, J, K	250	33	F, G, J, K, M	250
0.5	B, C, D	250	2.0	B, C, D	250	8.2	B, C, J, K	250	36	F, G, J, K, M	250
0.6	B, C, D	250	2.2	B, C, D	250	9.1	B, C, J, K	250	39	F, G, J, K, M	250
0.7	B, C, D	250	2.4	B, C, D	250	10	F, G, J, K, M	250	43	F, G, J, K, M	250
0.8	B, C, D	250	2.7	B, C, D	250	11	F, G, J, K, M	250	47	F, G, J, K, M	250
0.9	B, C, D	250	3.0	B, C, D	250	12	F, G, J, K, M	250	51	F, G, J, K, M	250
1.0	B, C, D	250	3.3	B, C, D	250	13	F, G, J, K, M	250	56	F, G, J, K, M	250
1.1	B, C, D	250	3.6	B, C, D	250	15	F, G, J, K, M	250	62	F, G, J, K, M	250
1.2	B, C, D	250	3.9	B, C, D	250	16	F, G, J, K, M	250	68	F, G, J, K, M	250
1.3	B, C, D	250	4.3	B, C, D	250	18	F, G, J, K, M	250	75	F, G, J, K, M	250
1.4	B, C, D	250	4.7	B, C, D	250	20	F, G, J, K, M	250	82	F, G, J, K, M	250
1.5	B, C, D	250	5.1	B, C, D	250	22	F, G, J, K, M	250	91	F, G, J, K, M	250
									100	F, G, J, K, M	250

Case Size B

TABLE II: TC: A (0±30PPM/°C)

Cap. pF	Cap. Tol.	WVDC	Cap. pF	Cap. Tol.	WVDC	Cap. pF	Cap. Tol.	WVDC	Cap. pF	Cap. Tol.	WVDC
0.1	B	500	3.6	B, C, D	500	39	F, G, J, K, M	500	430	F, G, J, K, M	200
0.2	B	500	3.9	B, C, D	500	43	F, G, J, K, M	500	470	F, G, J, K, M	200
0.3	B,C	500	4.3	B, C, D	500	47	F, G, J, K, M	500	510	F, G, J, K, M	100
0.4	B,C	500	4.7	B, C, D	500	51	F, G, J, K, M	500	560	F, G, J, K, M	100
0.5	B, C, D	500	5.1	B, C, D	500	56	F, G, J, K, M	500	620	F, G, J, K, M	100
0.6	B, C, D	500	5.6	B, C, D	500	62	F, G, J, K, M	500	680	F, G, J, K, M	50
0.7	B, C, D	500	6.2	B, C, D	500	68	F, G, J, K, M	500	750	F, G, J, K, M	50
0.8	B, C, D	500	6.8	B, C, J, K	500	75	F, G, J, K, M	500	820	F, G, J, K, M	50
0.9	B, C, D	500	7.5	B, C, J, K	500	82	F, G, J, K, M	500	910	F, G, J, K, M	50
1.0	B, C, D	500	8.2	B, C, J, K	500	91	F, G, J, K, M	500	1000	F, G, J, K, M	50
1.1	B, C, D	500	9.1	B, C, J, K	500	100	F, G, J, K, M	500			
1.2	B, C, D	500	10	F, G, J, K, M	500	110	F, G, J, K, M	300			
1.3	B, C, D	500	11	F, G, J, K, M	500	120	F, G, J, K, M	300			
1.4	B, C, D	500	12	F, G, J, K, M	500	130	F, G, J, K, M	300			
1.5	B, C, D	500	13	F, G, J, K, M	500	150	F, G, J, K, M	300			
1.6	B, C, D	500	15	F, G, J, K, M	500	160	F, G, J, K, M	300			
1.7	B, C, D	500	16	F, G, J, K, M	500	180	F, G, J, K, M	300			
1.8	B, C, D	500	18	F, G, J, K, M	500	200	F, G, J, K, M	300			
1.9	B, C, D	500	20	F, G, J, K, M	500	220	F, G, J, K, M	200			
2.0	B, C, D	500	22	F, G, J, K, M	500	240	F, G, J, K, M	200			
2.2	B, C, D	500	24	F, G, J, K, M	500	270	F, G, J, K, M	200			
2.4	B, C, D	500	27	F, G, J, K, M	500	300	F, G, J, K, M	200			
2.7	B, C, D	500	30	F, G, J, K, M	500	330	F, G, J, K, M	200			
3.0	B, C, D	500	33	F, G, J, K, M	500	360	F, G, J, K, M	200			
3.3	B, C, D	500	36	F, G, J, K, M	500	390	F, G, J, K, M	200			

Case Size R

TABLE III: TC: A (0±30PPM/°C)

Cap. pF	Cap. Tol.	WVDC	Cap. pF	Cap. Tol.	WVDC	Cap. pF	Cap. Tol.	WVDC	Cap. pF	Cap. Tol.	WVDC
1.0	B, C, D	500	3.0	B, C, D	500	12	G, J, K, M	500	51	G, J, K, M	500
1.1	B, C, D	500	3.3	B, C, D	500	13	G, J, K, M	500	56	G, J, K, M	500
1.2	B, C, D	500	3.6	B, C, D	500	15	G, J, K, M	500	62	G, J, K, M	500
1.3	B, C, D	500	3.9	B, C, D	500	16	G, J, K, M	500	68	G, J, K, M	500
1.4	B, C, D	500	4.3	B, C, D	500	18	G, J, K, M	500	75	G, J, K, M	500
1.5	B, C, D	500	4.7	B, C, D	500	20	G, J, K, M	500	82	G, J, K, M	500
1.6	B, C, D	500	5.1	B, C, D	500	22	G, J, K, M	500	91	G, J, K, M	500
1.7	B, C, D	500	5.6	G, J, K, M	500	24	G, J, K, M	500	100	G, J, K, M	500
1.8	B, C, D	500	6.2	G, J, K, M	500	27	G, J, K, M	500			
1.9	B, C, D	500	6.8	G, J, K, M	500	30	G, J, K, M	500			
2.0	B, C, D	500	7.5	G, J, K, M	500	33	G, J, K, M	500			
2.1	B, C, D	500	8.2	G, J, K, M	500	36	G, J, K, M	500			
2.2	B, C, D	500	9.1	G, J, K, M	500	39	G, J, K, M	500			
2.4	B, C, D	500	10	G, J, K, M	500	43	G, J, K, M	500			
2.7	B, C, D	500	11	G, J, K, M	500	47	G, J, K, M	500			



Case Size L

TABLE IV: TC: A (0±30PPM/°C)

Cap. pF	Cap. Tol.	WVDC	Cap. pF	Cap. Tol.	WVDC	Cap. pF	Cap. Tol.	WVDC
0.1	A, B	200	1.6	A, B, C, D	200	6.2	A, B, C, D	200
0.2	A, B	200	1.8	A, B, C, D	200	6.8	B, C, J, K	200
0.3	A, B, C	200	2.0	A, B, C, D	200	7.5	B, C, J, K	200
0.4	A, B, C	200	2.2	A, B, C, D	200	8.2	B, C, J, K	200
0.5	A, B, C	200	2.4	A, B, C, D	200	9.1	B, C, J, K	200
0.6	A, B, C	200	2.7	A, B, C, D	200	10	F, G, J, K, M	200
0.7	A, B, C	200	3.0	A, B, C, D	200	11	F, G, J, K, M	200
0.8	A, B, C	200	3.3	A, B, C, D	200	12	F, G, J, K, M	200
0.9	A, B, C	200	3.6	A, B, C, D	200	15	F, G, J, K, M	200
1.0	A, B, C, D	200	3.9	A, B, C, D	200	18	F, G, J, K, M	200
1.1	A, B, C, D	200	4.3	A, B, C, D	200	20	F, G, J, K, M	200
1.2	A, B, C, D	200	4.7	A, B, C, D	200	22	F, G, J, K, M	200
1.3	A, B, C, D	200	5.1	A, B, C, D	200	24	F, G, J, K, M	200
1.5	A, B, C, D	200	5.6	A, B, C, D	200	27	F, G, J, K, M	200

Case Size S

TABLE V:

Cap. pF	Cap. Tol.	WVDC	Cap. pF	Cap. Tol.	WVDC	Cap. pF	Cap. Tol.	WVDC
0.1	A, B	250	2.7	A, B, C, D	250	20	F, G, J, K, M	250
0.2	A, B	250	3.0	A, B, C, D	250	22	F, G, J, K, M	250
0.3	A, B, C	250	3.3	A, B, C, D	250	24	F, G, J, K, M	250
0.4	A, B, C	250	3.6	A, B, C, D	250	27	F, G, J, K, M	250
0.5	A, B, C	250	3.9	A, B, C, D	250	30	F, G, J, K, M	250
0.6	A, B, C	250	4.3	A, B, C, D	250	33	F, G, J, K, M	250
0.7	A, B, C	250	4.7	A, B, C, D	250	36	F, G, J, K, M	250
0.8	A, B, C	250	5.1	A, B, C, D	250	39	F, G, J, K, M	250
0.9	A, B, C	250	5.6	A, B, C, D	250	43	F, G, J, K, M	250
1.0	A, B, C, D	250	6.2	A, B, C, D	250	47	F, G, J, K, M	250
1.1	A, B, C, D	250	6.8	B, C, J, K	250	51	F, G, J, K, M	250
1.2	A, B, C, D	250	7.5	B, C, J, K	250	56	F, G, J, K, M	250
1.3	A, B, C, D	250	8.2	B, C, J, K	250	62	F, G, J, K, M	250
1.5	A, B, C, D	250	9.1	B, C, J, K	250	68	F, G, J, K, M	250
1.6	A, B, C, D	250	10	F, G, J, K, M	250	75	F, G, J, K, M	250
1.8	A, B, C, D	250	11	F, G, J, K, M	250	82	F, G, J, K, M	250
2.0	A, B, C, D	250	12	F, G, J, K, M	250	91	F, G, J, K, M	250
2.2	A, B, C, D	250	15	F, G, J, K, M	250	100	F, G, J, K, M	250
2.4	A, B, C, D	250	18	F, G, J, K, M	250			

Case Size F

TABLE VI:

Cap. pF	Cap. Tol.	WVDC	Cap. pF	Cap. Tol.	WVDC	Cap. pF	Cap. Tol.	WVDC
0.1	A, B	250	3.3	A, B, C, D	250	30	F, G, J, K, M	250
0.2	A, B	250	3.6	A, B, C, D	250	33	F, G, J, K, M	250
0.3	A, B, C	250	3.9	A, B, C, D	250	36	F, G, J, K, M	250
0.4	A, B, C	250	4.3	A, B, C, D	250	39	F, G, J, K, M	250
0.5	A, B, C	250	4.7	A, B, C, D	250	43	F, G, J, K, M	250
0.6	A, B, C	250	5.1	A, B, C, D	250	47	F, G, J, K, M	250
0.7	A, B, C	250	5.6	A, B, C, D	250	51	F, G, J, K, M	250
0.8	A, B, C	250	6.2	A, B, C, D	250	56	F, G, J, K, M	250
0.9	A, B, C	250	6.8	B, C, J, K	250	62	F, G, J, K, M	250
1.0	A, B, C, D	250	7.5	B, C, J, K	250	68	F, G, J, K, M	250
1.1	A, B, C, D	250	8.2	B, C, J, K	250	75	F, G, J, K, M	250
1.2	A, B, C, D	250	9.1	B, C, J, K	250	82	F, G, J, K, M	250
1.3	A, B, C, D	250	10	F, G, J, K, M	250	91	F, G, J, K, M	250
1.5	A, B, C, D	250	11	F, G, J, K, M	250	100	F, G, J, K, M	250
1.6	A, B, C, D	250	12	F, G, J, K, M	250	110	F, G, J, K, M	250
1.8	A, B, C, D	250	15	F, G, J, K, M	250	120	F, G, J, K, M	250
2.0	A, B, C, D	250	18	F, G, J, K, M	250	150	F, G, J, K, M	250
2.2	A, B, C, D	250	20	F, G, J, K, M	250	180	F, G, J, K, M	250
2.4	A, B, C, D	250	22	F, G, J, K, M	250	200	F, G, J, K, M	250
2.7	A, B, C, D	250	24	F, G, J, K, M	250	220	F, G, J, K, M	250
3.0	A, B, C, D	250	27	F, G, J, K, M	250	240	F, G, J, K, M	250

UQ CA ESR vs. Frequency

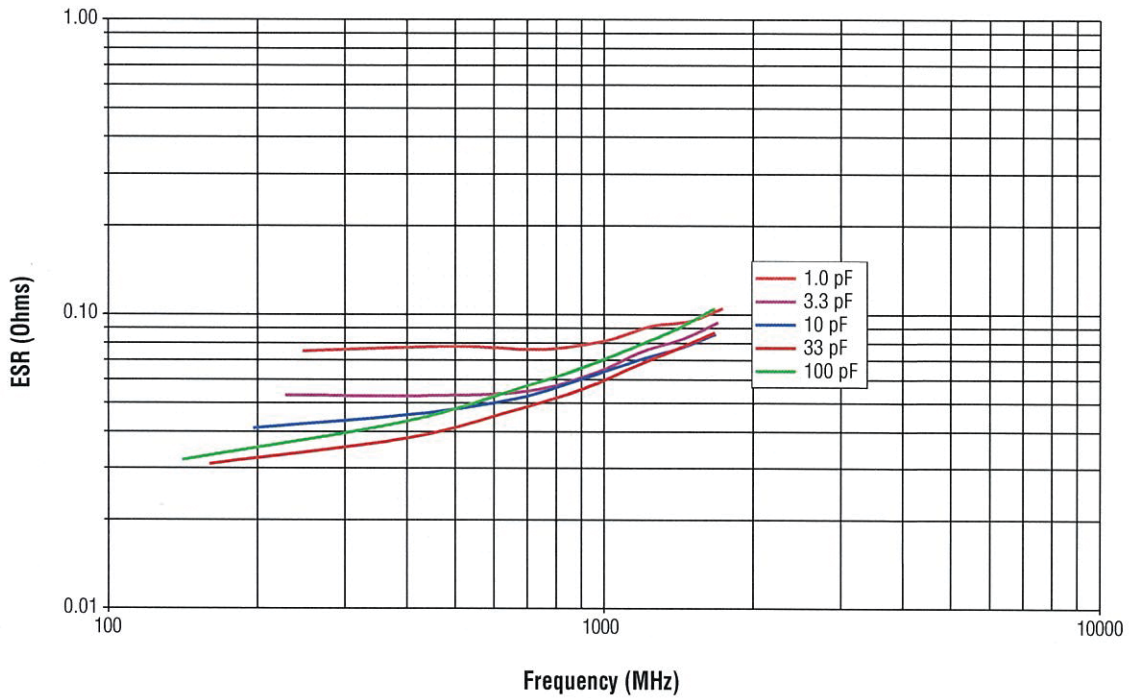

UQ CA FSR & FPR vs. Capacitance

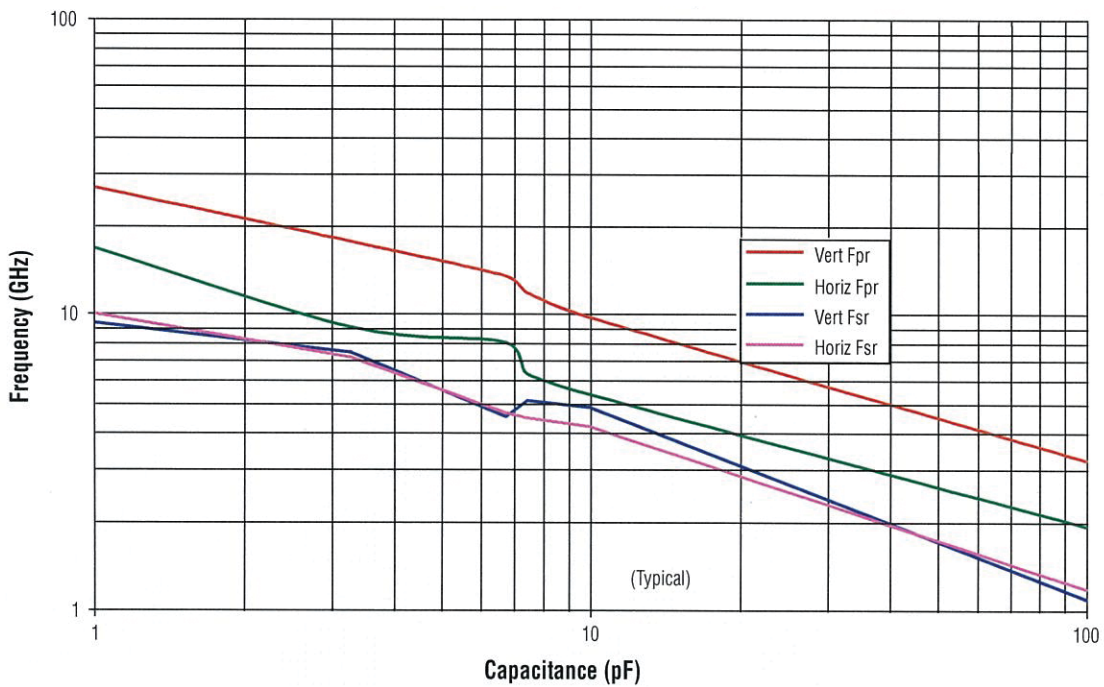

UQ CB ESR vs. Frequency

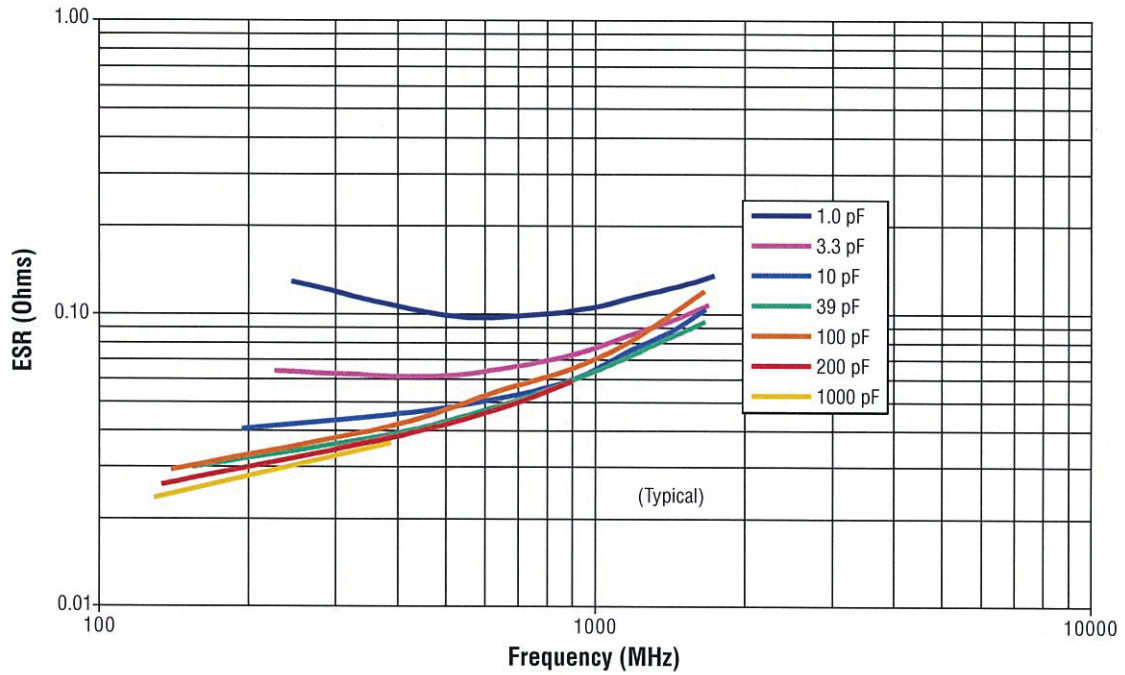

UQ CB FSR & FPR vs. Capacitance

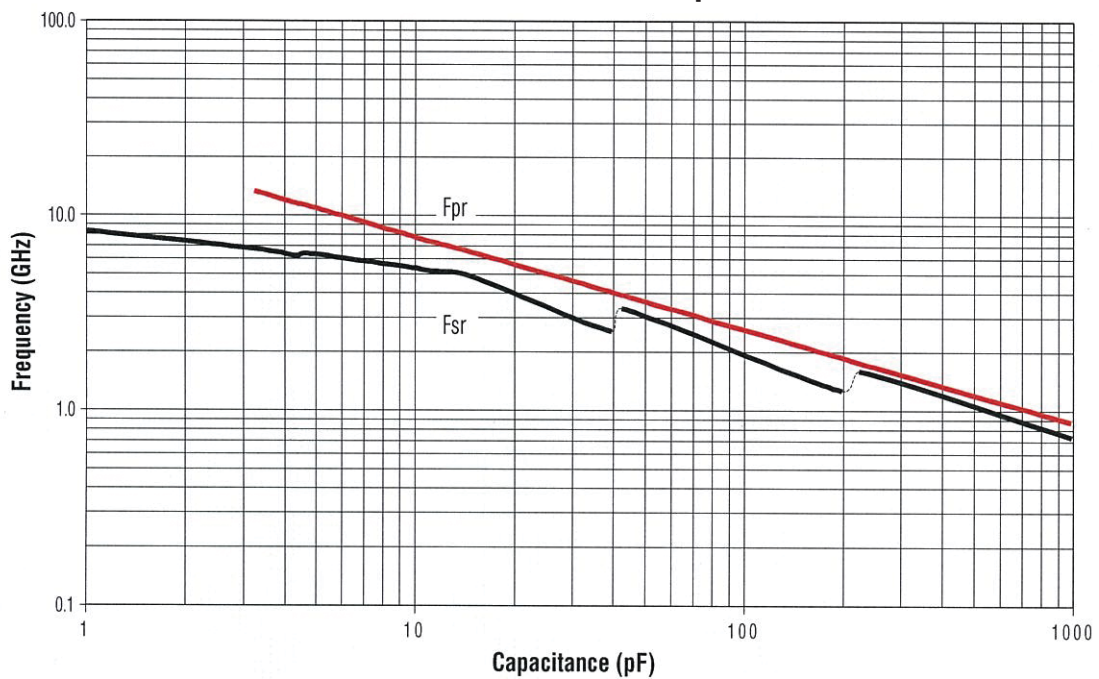

UQ CR ESR vs. Frequency

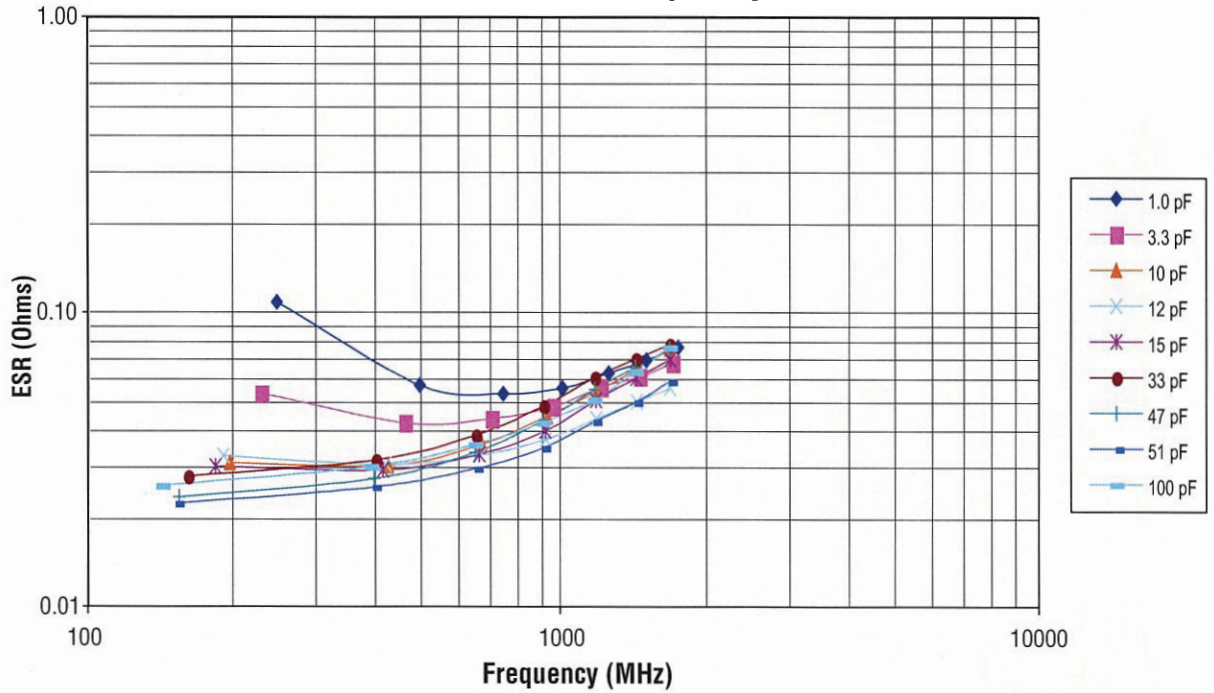

UQ CR Resonance Horizontal Orientation

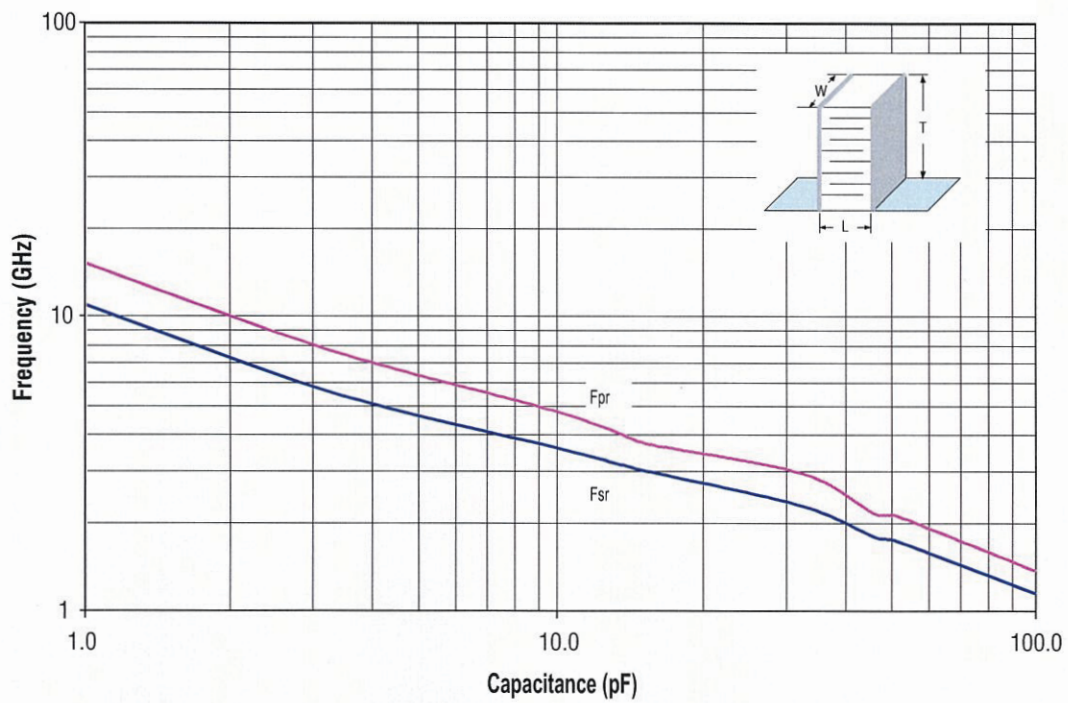

UQ CL ESR vs. Frequency

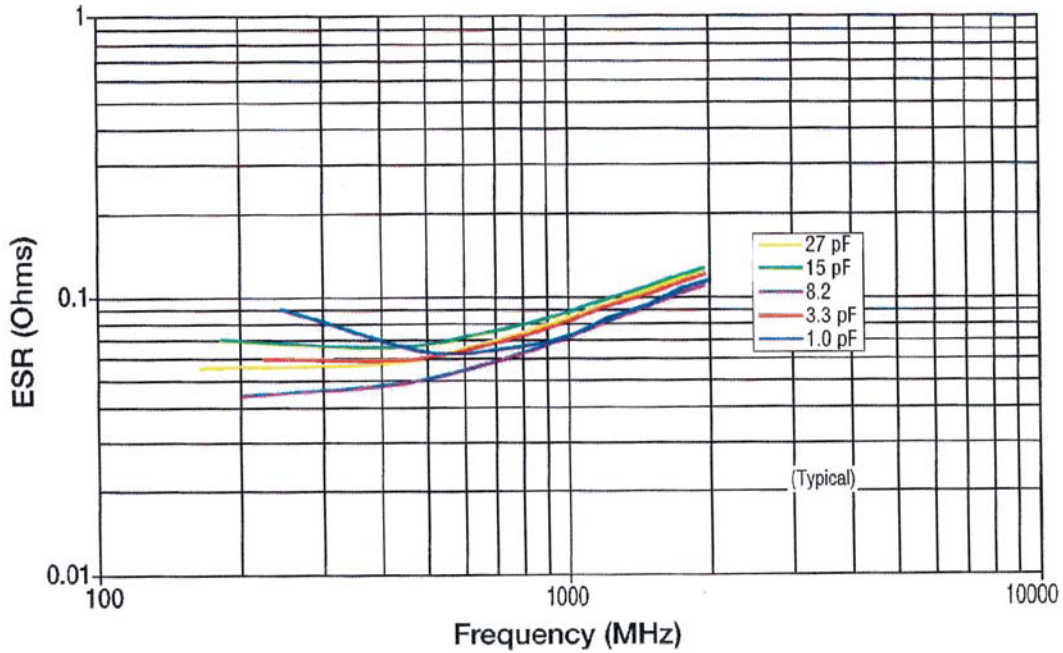

UQ CL Resonance Frequency

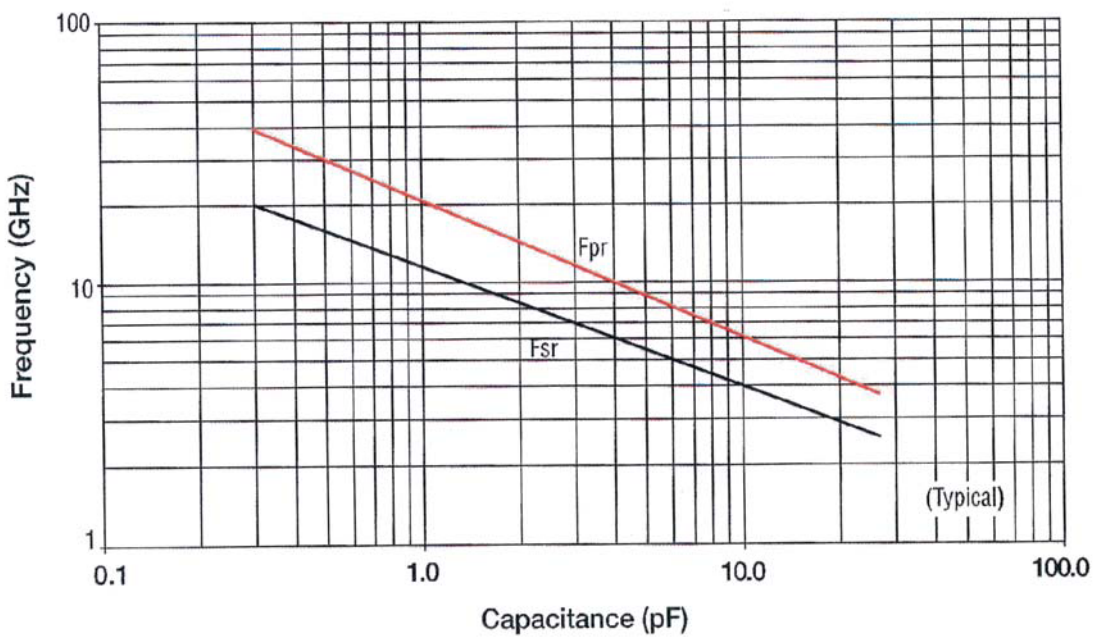

UQ CS ESR vs. Frequency

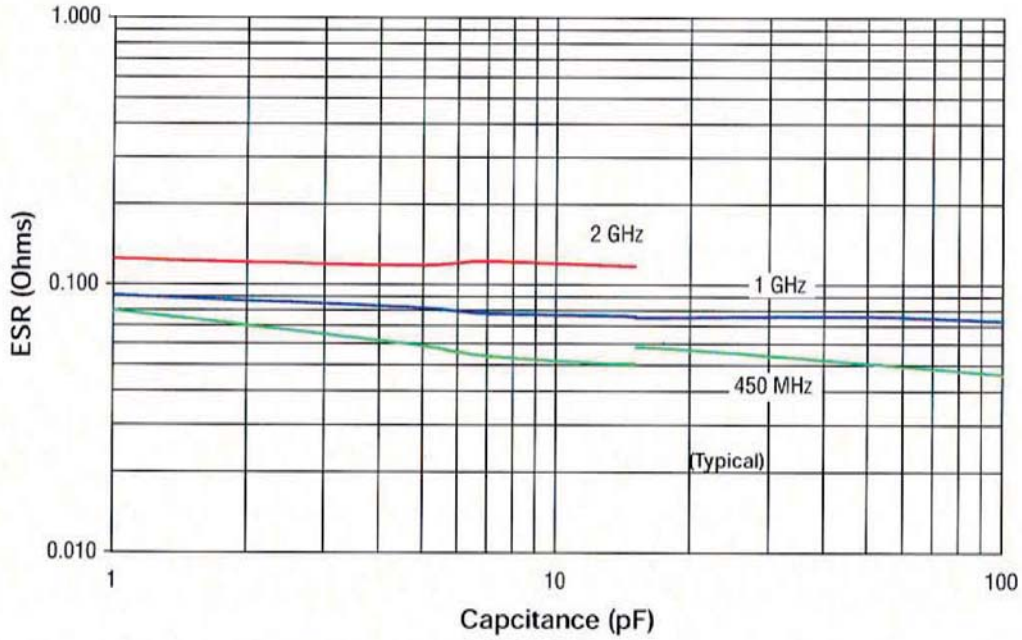

UQ CS ESR vs. Frequency

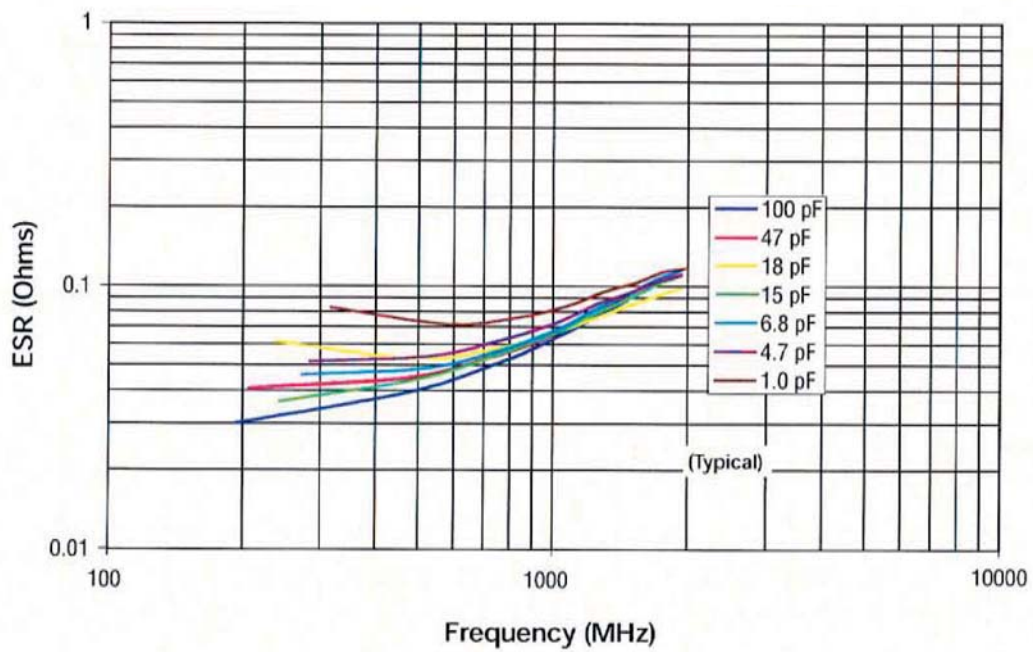

UQ CS Q vs. Capacitance

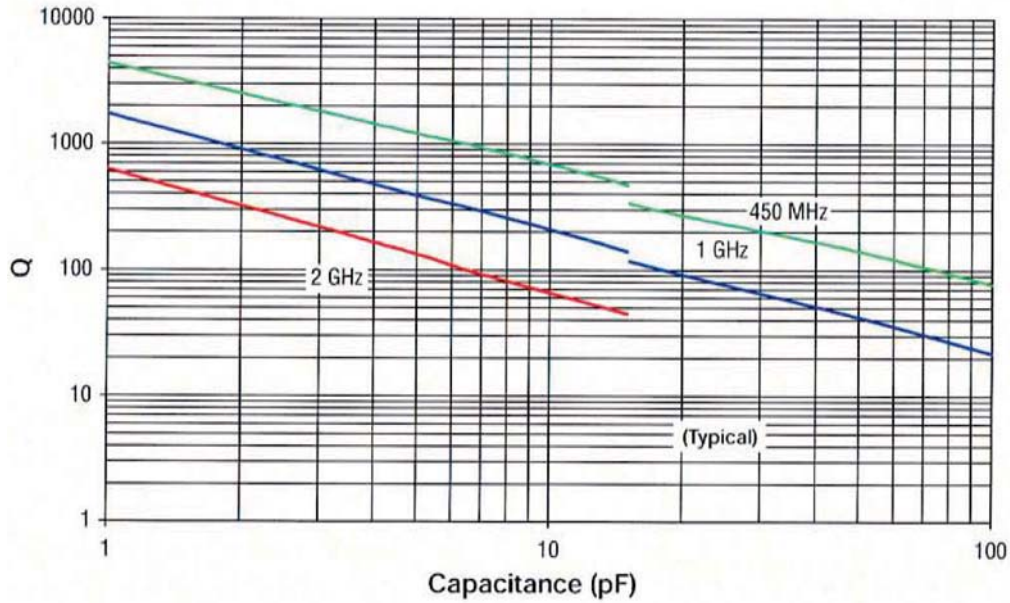

UQ CS Resonant Frequency

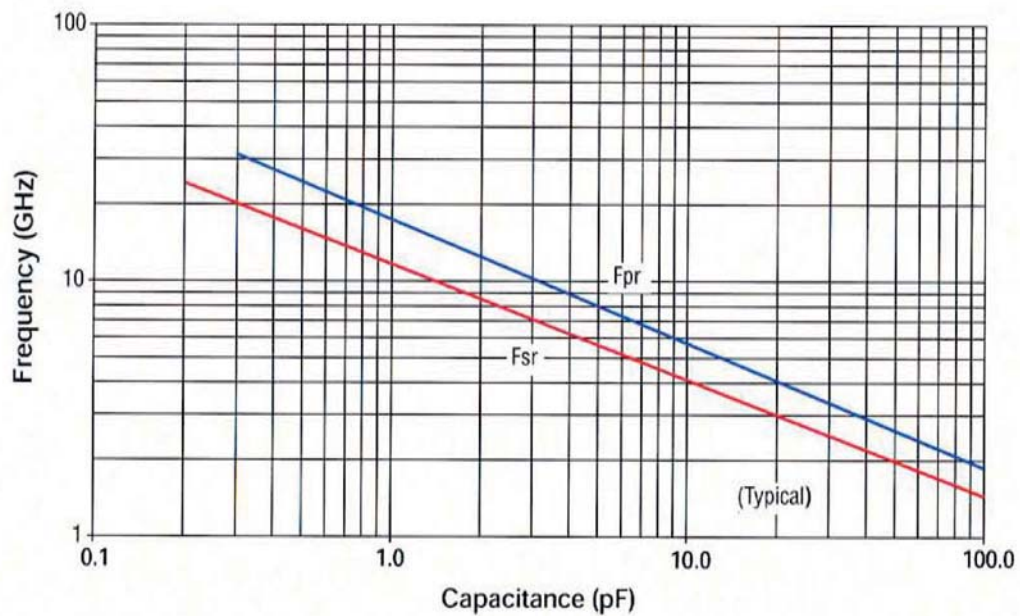

UQ CF ESR vs. Frequency

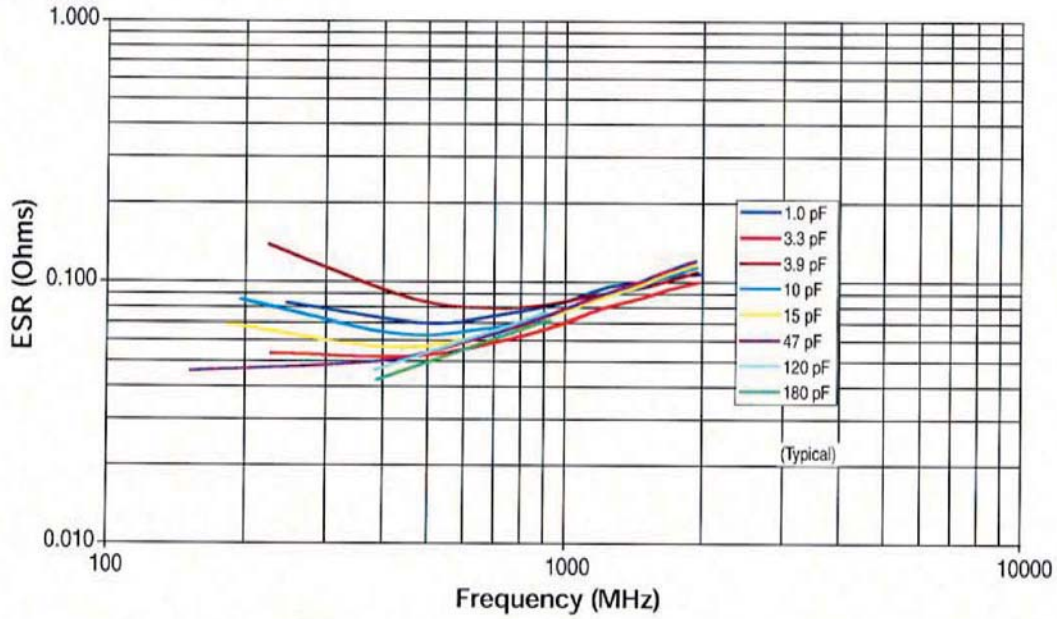

UQ CF Resonant Frequency

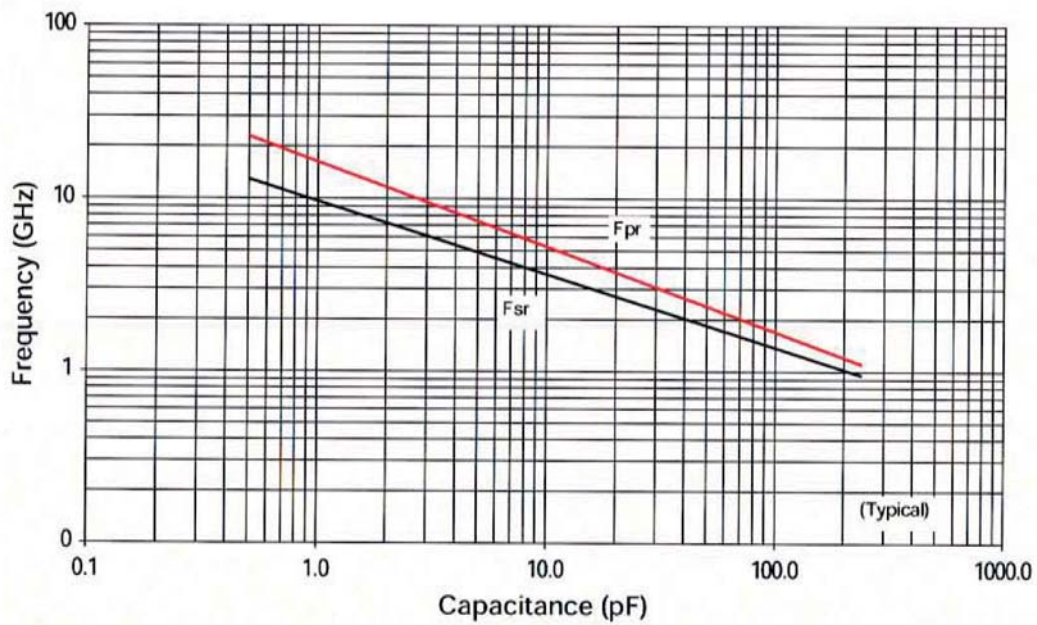

Microwave MLCs



UQ Series High Q Ultra Low ESR MLC

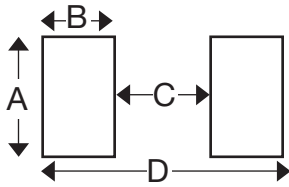

MOUNTING PAD DIMENSIONS CASE CA: inches (millimeters)

	Pad Size	A min	B min	C min	D min
Vertical Mount	Normal	0.070 (1.778)	0.050 (1.270)	0.030 (0.762)	0.130 (3.302)
	High Density	0.050 (1.270)	0.030 (0.762)	0.030 (0.762)	0.090 (2.286)
Horizontal Mount	Normal	0.080 (2.032)	0.050 (1.270)	0.030 (0.762)	0.130 (3.302)
	High Density	0.060 (1.524)	0.030 (0.762)	0.030 (0.762)	0.090 (2.286)

MOUNTING PAD DIMENSIONS CASE CB: inches (millimeters)

	Cap Value	Pad Size	A min	B min	C min	D min
Vertical Mount	0.1 pF	Normal	0.065 (1.651)	0.050 (1.270)	0.075 (1.905)	0.175 (4.445)
		High Density	0.045 (1.143)	0.030 (0.762)	0.075 (1.905)	0.135 (3.429)
	0.2 pF	Normal	0.090 (2.286)	0.050 (1.270)	0.075 (1.905)	0.175 (4.445)
		High Density	0.070 (1.778)	0.030 (0.762)	0.075 (1.905)	0.135 (3.429)
	0.3 to 510 pF	Normal	0.110 (2.794)	0.050 (1.270)	0.075 (1.905)	0.175 (4.445)
		High Density	0.090 (2.286)	0.030 (0.762)	0.075 (1.905)	0.135 (3.429)
Horizontal Mount	> 510 pF	Normal	0.120 (3.048)	0.050 (1.270)	0.075 (1.905)	0.175 (4.445)
		High Density	0.100 (2.540)	0.030 (0.762)	0.075 (1.905)	0.135 (3.429)
	All Values	Normal	0.130 (3.302)	0.050 (1.270)	0.075 (1.905)	0.175 (4.445)
		High Density	0.110 (2.794)	0.030 (0.762)	0.075 (1.905)	0.135 (3.429)

MOUNTING PAD DIMENSIONS CASE CL, CS & CF: inches (millimeters)

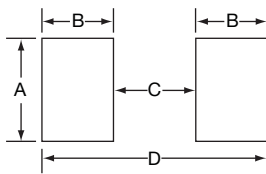
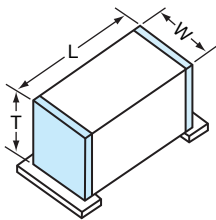

Case	A min.	B min.	C min.	D min.
0402 (1005)	.0275 (0.70)	.0354 (0.90)	.0157 (0.40)	.0866 (2.20)
0603 (1608)	.0393 (1.00)	.0433 (1.10)	.03236 (0.60)	.110 (2.80)
0805 (2012)	.0590 (1.50)	.0512 (1.30)	.0236 (0.60)	.1259 (3.20)

Microwave MLCs



UQ Series High Q Ultra Low ESR MLC

DESIGN KITS

Kit #	Compliance	Description	Cap Value	Cap. Values (pF)	Tol. (pF)
KITUQ800LF		UQCA 0605 Series Ultra-Low ESR High Q Microwave Capacitors 16 different values, 15 pcs min. per value	0.1 to 2.0	0.1, 0.2, 0.3, 0.4, 0.5, 0.6, 0.7, 0.8, 0.9, 1.0, 1.1, 1.2, 1.5	±0.1
				1.6, 1.8, 2.0	±0.25
KITUQ810LF		UQCA 0605 Series Ultra-Low ESR High Q Microwave Capacitors 16 different values, 15 pcs min. per value	1.0 to 10 pF	1.0, 1.2, 1.5, 1.8, 2.0, 2.2, 2.4, 2.7, 3.0, 3.3	±0.1
				3.9, 4.7, 5.6, 6.8, 8.0	±0.25
				10	±5%
KITUQ820LF		UQCA 0605 Series Ultra-Low ESR High Q Microwave Capacitors 16 different values, 15 pcs min. per value	10 to 100 pF	10, 12, 15, 18, 20, 22, 24, 27, 30, 33, 39, 47, 56, 68, 82, 100	±5%
KITUQ830LF		UQCB 1210 Series Ultra-Low ESR High Q Microwave Capacitors 16 different values, 15 pcs min. per value	1.0 to 10 pF	1.0, 1.2, 1.5, 1.8, 2.0, 2.2, 2.4, 2.7, 3.0, 3.3	±0.1
				3.9, 4.7, 5.6, 6.8, 8.0	±0.25
				10	±5%
KITUQ840LF		UQCB 1210 Series Ultra-Low ESR High Q Microwave Capacitors 16 different values, 15 pcs min. per value	10 to 100 pF	10, 12, 15, 18, 20, 22, 24, 27, 30, 33, 39, 47, 56, 68, 82, 100	±5%
KITUQ850LF		UQCB 1210 Series Ultra-Low ESR High Q Microwave Capacitors 16 different values, 15 pcs min. per value	100 to 1000 pF	100, 120, 150, 180, 200, 220, 240, 270, 300, 330, 390, 470	±5%
				560, 680, 820, 1000	±10%
KITUQ360LF		UQCL 0402 Series Ultra-Low ESR High Q Microwave Capacitors 16 different values, 15 pcs min. per value	0.1 to 2.0	0.1, 0.2, 0.3, 0.4, 0.5, 0.6, 0.7, 0.8, 0.9, 1.0, 1.1, 1.2, 1.5	±0.1
				1.6, 1.8, 2.0	±0.25
KITUQ370LF		UQCL 0402 Series Ultra-Low ESR High Q Microwave Capacitors 16 different values, 15 pcs min. per value	1.0 to 10	1.0, 1.2, 1.5, 1.8, 2.0, 2.2, 2.4, 2.7, 3.0, 3.3	±0.1
				3.9, 4.7, 5.6, 6.8, 8.2	±0.25
				10	±5%
KITUQ380LF		UQCL 0402 Series Ultra-Low ESR High Q Microwave Capacitors 8 different values, 15 pcs min. per value	10 to 27	10, 12, 15, 18, 20, 22, 24, 27	±5%
KITUQ250LF		UQCS 0603 Series Ultra-Low ESR High Q Microwave Capacitors 16 different values, 15 pcs min. per value	0.1 to 2.0	0.1, 0.2, 0.3, 0.4, 0.5, 0.6, 0.7, 0.8, 0.9, 1.0, 1.1, 1.2, 1.5	±0.1
				1.6, 1.8, 2.0	±0.25
KITUQ260LF		UQCS 0603 Series Ultra-Low ESR High Q Microwave Capacitors 16 different values, 15 pcs min. per value	1.0 to 10	1.0, 1.2, 1.5, 1.8, 2.0, 2.2, 2.4, 2.7, 3.0, 3.3	±0.1
				3.9, 4.7, 5.6, 6.8, 8.2	±0.25
				10	±5%
KITUQ270LF		UQCS 0603 Series Ultra-Low ESR High Q Microwave Capacitors 16 different values, 15 pcs min. per value	10 to 100	10, 12, 15, 18, 20, 22, 24, 27, 30, 33, 39, 47, 56, 68, 82, 100	±5%
KITUQ320LF		UQCF 0805 Series Ultra-Low ESR High Q Microwave Capacitors 16 different values, 15 pcs min. per value	0.1 to 2.0	0.1, 0.2, 0.3, 0.4, 0.5, 0.6, 0.7, 0.8, 0.9, 1.0, 1.1, 1.2, 1.5	±0.1
				1.6, 1.8, 2.0	±0.25
KITUQ330LF		UQCF 0805 Series Ultra-Low ESR High Q Microwave Capacitors 16 different values, 15 pcs min. per value	1.0 to 10	1.0, 1.2, 1.5, 1.8, 2.0, 2.2, 2.4, 2.7, 3.0, 3.3	±0.1
				3.9, 4.7, 5.6, 6.8, 8.2	±0.25
				10	±5%
KITUQ340LF		UQCF 0805 Series Ultra-Low ESR High Q Microwave Capacitors 16 different values, 15 pcs min. per value	10 to 100	10, 12, 15, 18, 20, 22, 24, 27, 30, 33, 39, 47, 56, 68, 82, 100	±5%
KITUQ350LF		UQCF 0805 Series Ultra-Low ESR High Q Microwave Capacitors 7 different values, 15 pcs min. per value	100 to 240	100, 120, 150, 180, 200, 220, 250	±5%

Microwave MLC's

SQ Series Ultra Low ESR MLC

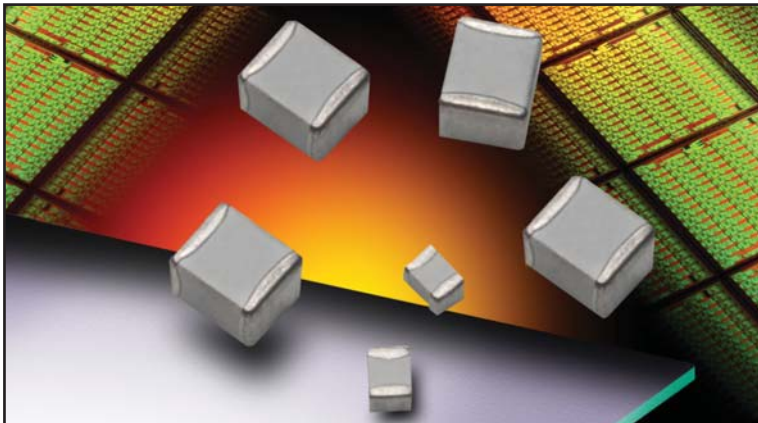

FEATURES:

- Low ESR
- High Q
- High Self Resonance
- Capacitance Range 0.1 pF to 5100 pF
- 175°C Capability SQCB

APPLICATIONS:

- RF Power Amplifiers
- Low Noise Amplifiers
- Filter Networks
- MRI Systems

HOW TO ORDER

<p>SQ</p> <p>AVX Style</p>	<p>CA</p> <p>Case Size CA = 0605 CB = 1210</p> <p>See mechanical dimensions below</p>	<p>7</p> <p>Voltage Code</p> <p>5 = 50V 1 = 100V E = 150V 2 = 200V V = 250V 9 = 300V 7 = 500V</p>	<p>M</p> <p>Temperature Coefficient Code</p> <p>M = +90±20ppm/°C A = 0±30ppm/°C C = 15% ("J" Termination only)</p>	<p>100</p> <p>Capacitance</p> <p>EIA Capacitance Code in pF. First two digits = significant figures or "R" for decimal place. Third digit = number of zeros or after "R" significant figures.</p>	<p>J</p> <p>Capacitance Tolerance Code</p> <p>B = ±.1 pF C = ±.25 pF D = ±.5 pF F = ±1% G = ±2% J = ±5% K = ±10% M = ±20% N = ±30%</p>	<p>A</p> <p>Failure Rate Code</p> <p>A = Not Applicable</p>	<p>T</p> <p>Termination Style Code</p> <p>**1 = Pd/Ag **7 = Ag/Ni/Au J = Nickel Barrier Sn/Pb (60/40) **T = 100% Tin H = Cu/Sn (Non-Magnetic)</p>	<p>1A</p> <p>Packaging Code</p> <p>1A = 7" Reel Unmarked 6A = Waffle Pack Unmarked ME = 7" Reel Marked WE = Waffle Pack Marked</p> <p>* Vertical T&R available</p>
-----------------------------------	---	---	--	---	--	---	---	--

****RoHS compliant**

MECHANICAL DIMENSIONS: inches (millimeters)

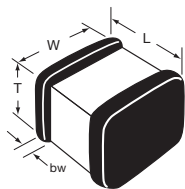

Case	Length (L)	Width (W)	Thickness (T)	Band Width (bw)
SQCA*	.055 + .015 - .010 (1.40+ .381 - .254)	.055±.015 (1.40±.381)	.020/.057 (.508/1.45)	.010 + .010 - .005 (.254 + .254 - .127)
SQCB*	.110 + .020 - .010 (2.79 + .508 - .254)	.110±.010 (2.79±.254)	.030/.102 (.762/2.59)	.015±.010 (.381±.254)

TAPE & REEL: All tape and reel specifications are in compliance with EIA RS481 (equivalent to IEC 286 part 3).

- 8mm carrier
- 7" reel: SQCA/SQCB = 1000 pcs

WAFFLE PACK

SQCA 100 pcs
SQCB 100 pcs

Not RoHS Compliant



For RoHS compliant products, please select correct termination style.

Microwave MLC's

SQ Series Ultra Low ESR MLC



ELECTRICAL SPECIFICATIONS

		M & A	C
Temperature Coefficient (TCC)		(M) $+90 \pm 20$ PPM/°C (-55°C to +125°C) (M) $+90 \pm 30$ PPM/°C (+125°C to +175°C)* (A) 0 ± 30 PPM/°C	$\pm 15\%$ (-55°C to 125°C)
Capacitance Range		(M) 0.1 pF to 1000 pF (A) 0.1 pF to 5100 pF	0.001 μ F to 0.1 μ F
Operating Temperature		0.1 pF to 330 pF: from -55°C to +175°C* 360 pF to 5100 pF: from -55°C to +125°C	-55°C to +125°C
Quality Factor (Q)	M Dielectric A & B Case	Greater than 10,000 at 1 MHz	2.5% @ 1kHz
	A Dielectric B Case	Greater than 10,000 at 1 MHz Greater than 2,000 at 1 MHz Greater than 2,000 at 1 KHz	0.1 - 200 pF 220 - 1000 pF 1100 - 5100 pF
	A Dielectric A Case	Greater than 10,000 at 1 MHz Greater than 2,000 at 1 MHz	0.1 - 100 pF 110 - 1000 pF
Insulation Resistance (IR)		0.2 pF to 470 pF 10 ⁹ Megohms min. @ 25°C at rated WVDC 10 ⁹ Megohms min. @ 125°C at rated WVDC 510 pF to 5100 pF 10 ⁹ Megohms min. @ 25°C at rated WVDC 10 ⁹ Megohms min. @ 125°C at rated WVDC	10 ⁴ Megohms min. @ 25°C at rated WVDC 10 ³ Megohms min. @ 125°C at rated WVDC
Working Voltage (WVDC)		See Capacitance Values table	See Capacitance Values table
Dielectric Withstanding Voltage (DWW)		250% of rated WVDC for 5 secs (for 500V rated 150% of rated voltage)	250% of rated WVDC for 5 secs
Aging Effects		None	<3% per decade hour
Piezoelectric Effects		None	None
Capacitance Drift		\pm (0.02% or 0.02 pF), whichever is greater	Not Applicable

* 175 SQCB & SQLB only

ENVIRONMENTAL CHARACTERISTICS

AVX SQ will meet and exceed the requirements of EIA-198, MIL-PRF-55681 and MIL-PRF-123

Thermal Shock	Mil-STD-202, Method 107, Condition A
Moisture Resistance	Mil-STD-202, Method 106
Low Voltage Humidity	Mil-STD-202, Method 103, condition A, with 1.5 VDC applied while subjected to an environment of 85°C with 85% relative humidity for 240 hours
Life Test	Mil-STD-202, Method 108, for 2000 hours at 125°C
Shock	Mil-STD-202, Method 213, Condition J
Vibration	Mil-STD-202, Method 204, Condition B
Immersion	Mil-STD-202, Method 104, Condition B
Salt Spray	Mil-STD-202, Method 101, Condition B
Solderability	Mil-STD-202, Method 208
Terminal Strength	Mil-STD-202, Method 211
Temperature Cycling	Mil-STD-202, Method 102, Condition C
Barometric Pressure	Mil-STD-202, Method 105, Condition B
Resistance to Solder Heat	Mil-STD-202, Method 210, Condition C

Case Size A

TABLE I: TC: M (+90±20PPM/°C)

Cap. pF	Cap. Tol.	WVDC	Cap. pF	Cap. Tol.	WVDC	Cap. pF	Cap. Tol.	WVDC	Cap. pF	Cap. Tol.	WVDC
0.1	B	150, 250	1.7	B, C, D	150, 250	6.2	B, C, D	150, 250	27	F, G, J, K	150, 250
0.2	B	150, 250	1.8	B, C, D	150, 250	6.8	B, C, J, K	150, 250	30	F, G, J, K	150, 250
0.3	B,C	150, 250	1.9	B, C, D	150, 250	7.5	B, C, J, K	150, 250	33	F, G, J, K	150, 250
0.4	B,C	150, 250	2.0	B, C, D	150, 250	8.2	B, C, J, K	150, 250	36	F, G, J, K	150, 250
0.5	B, C, D	150, 250	2.2	B, C, D	150, 250	9.1	B, C, J, K	150, 250	39	F, G, J, K	150, 250
0.6	B, C, D	150, 250	2.4	B, C, D	150, 250	10	F, G, J, K	150, 250	43	F, G, J, K	150, 250
0.7	B, C, D	150, 250	2.7	B, C, D	150, 250	11	F, G, J, K	150, 250	47	F, G, J, K	150, 250
0.8	B, C, D	150, 250	3.0	B, C, D	150, 250	12	F, G, J, K	150, 250	51	F, G, J, K	150, 250
0.9	B, C, D	150, 250	3.3	B, C, D	150, 250	13	F, G, J, K	150, 250	56	F, G, J, K	150, 250
1.0	B, C, D	150, 250	3.6	B, C, D	150, 250	15	F, G, J, K	150, 250	62	F, G, J, K	150, 250
1.1	B, C, D	150, 250	3.9	B, C, D	150, 250	16	F, G, J, K	150, 250	68	F, G, J, K	150, 250
1.2	B, C, D	150, 250	4.3	B, C, D	150, 250	18	F, G, J, K	150, 250	75	F, G, J, K	150, 250
1.3	B, C, D	150, 250	4.7	B, C, D	150, 250	20	F, G, J, K	150, 250	82	F, G, J, K	150, 250
1.4	B, C, D	150, 250	5.1	B, C, D	150, 250	22	F, G, J, K	150, 250	91	F, G, J, K	150, 250
1.5	B, C, D	150, 250	5.6	B, C, D	150, 250	24	F, G, J, K	150, 250	100	F, G, J, K	150, 250
1.6	B, C, D	150, 250									

TABLE II: TC: A (0±30PPM/°C)

Cap. pF	Cap. Tol.	WVDC	Cap. pF	Cap. Tol.	WVDC	Cap. pF	Cap. Tol.	WVDC	Cap. pF	Cap. Tol.	WVDC
0.1	B	150, 250	2.7	B, C, D	150, 250	20	F, G, J, K	150, 250	150	F, G, J, K	150
0.2	B	150, 250	3.0	B, C, D	150, 250	22	F, G, J, K	150, 250	160	F, G, J, K	150
0.3	B,C	150, 250	3.3	B, C, D	150, 250	24	F, G, J, K	150, 250	180	F, G, J, K	150
0.4	B,C	150, 250	3.6	B, C, D	150, 250	27	F, G, J, K	150, 250	200	F, G, J, K	150
0.5	B, C, D	150, 250	3.9	B, C, D	150, 250	30	F, G, J, K	150, 250	220	F, G, J, K	150
0.6	B, C, D	150, 250	4.3	B, C, D	150, 250	33	F, G, J, K	150, 250	240	F, G, J, K	150
0.7	B, C, D	150, 250	4.7	B, C, D	150, 250	36	F, G, J, K	150, 250	270	F, G, J, K	150
0.8	B, C, D	150, 250	5.1	B, C, D	150, 250	39	F, G, J, K	150, 250	300	F, G, J, K	150
0.9	B, C, D	150, 250	5.6	B, C, D	150, 250	43	F, G, J, K	150, 250	330	F, G, J, K	150
1.0	B, C, D	150, 250	6.2	B, C, D	150, 250	47	F, G, J, K	150, 250	360	F, G, J, K	150
1.1	B, C, D	150, 250	6.8	B, C, J, K	150, 250	51	F, G, J, K	150, 250	390	F, G, J, K	150
1.2	B, C, D	150, 250	7.5	B, C, J, K	150, 250	56	F, G, J, K	150, 250	430	F, G, J, K	150
1.3	B, C, D	150, 250	8.2	B, C, J, K	150, 250	62	F, G, J, K	150, 200	470	F, G, J, K	150
1.4	B, C, D	150, 250	9.1	B, C, J, K	150, 250	68	F, G, J, K	150, 200	510	F, G, J, K	150
1.5	B, C, D	150, 250	10	F, G, J, K	150, 250	75	F, G, J, K	150, 200	560	F, G, J, K	150
1.6	B, C, D	150, 250	11	F, G, J, K	150, 250	82	F, G, J, K	150, 200	620	F, G, J, K	150
1.7	B, C, D	150, 250	12	F, G, J, K	150, 250	91	F, G, J, K	150, 200	680	F, G, J, K	50
1.8	B, C, D	150, 250	13	F, G, J, K	150, 250	100	F, G, J, K	150	750	F, G, J, K	50
1.9	B, C, D	150, 250	15	F, G, J, K	150, 250	110	F, G, J, K	150	820	F, G, J, K	50
2.0	B, C, D	150, 250	16	F, G, J, K	150, 250	120	F, G, J, K	150	910	F, G, J, K	50
2.2	B, C, D	150, 250	18	F, G, J, K	150, 250	130	F, G, J, K	150	1000	F, G, J, K	50
2.4	B, C, D	150, 250									

TABLE III: TC: C (±15%)

Cap. pF	Cap. Tol.	WVDC	Cap. pF	Cap. Tol.	WVDC	Cap. pF	Cap. Tol.	WVDC
1000	K, M, N	50	2200	K, M, N	50	5100	K, M, N	50
1200	K, M, N	50	2700	K, M, N	50	5600	K, M, N	50
1500	K, M, N	50	3300	K, M, N	50	6800	K, M, N	50
1800	K, M, N	50	3900	K, M, N	50	8200	K, M, N	50
2000	K, M, N	50	4700	K, M, N	50	10000	K, M, N	50

Case Size B

TABLE IV: TC: M (+90±20PPM/°C)

Cap. pF	Cap. Tol.	WVDC	Cap. pF	Cap. Tol.	WVDC	Cap. pF	Cap. Tol.	WVDC	Cap. pF	Cap. Tol.	WVDC
0.1	B	500	2.7	B, C, D	500	20	F, G, J, K	500	150	F, G, J, K	300
0.2	B	500	3.0	B, C, D	500	22	F, G, J, K	500	160	F, G, J, K	300
0.3	B,C	500	3.3	B, C, D	500	24	F, G, J, K	500	180	F, G, J, K	300
0.4	B,C	500	3.6	B, C, D	500	27	F, G, J, K	500	200	F, G, J, K	300
0.5	B, C, D	500	3.9	B, C, D	500	30	F, G, J, K	500	220	F, G, J, K	200
0.6	B, C, D	500	4.3	B, C, D	500	33	F, G, J, K	500	240	F, G, J, K	200
0.7	B, C, D	500	4.7	B, C, D	500	36	F, G, J, K	500	270	F, G, J, K	200
0.8	B, C, D	500	5.1	B, C, D	500	39	F, G, J, K	500	300	F, G, J, K	200
0.9	B, C, D	500	5.6	B, C, D	500	43	F, G, J, K	500	330	F, G, J, K	200
1.0	B, C, D	500	6.2	B, C, D	500	47	F, G, J, K	500	360	F, G, J, K	200
1.1	B, C, D	500	6.8	B, C, J, K	500	51	F, G, J, K	500	390	F, G, J, K	200
1.2	B, C, D	500	7.5	B, C, J, K	500	56	F, G, J, K	500	430	F, G, J, K	200
1.3	B, C, D	500	8.2	B, C, J, K	500	62	F, G, J, K	500	470	F, G, J, K	200
1.4	B, C, D	500	9.1	B, C, J, K	500	68	F, G, J, K	500	510	F, G, J, K	150
1.5	B, C, D	500	10	F, G, J, K	500	75	F, G, J, K	500	560	F, G, J, K	150
1.6	B, C, D	500	11	F, G, J, K	500	82	F, G, J, K	500	620	F, G, J, K	150
1.7	B, C, D	500	12	F, G, J, K	500	91	F, G, J, K	500	680	F, G, J, K	150
1.8	B, C, D	500	13	F, G, J, K	500	100	F, G, J, K	500	750	F, G, J, K	150
1.9	B, C, D	500	15	F, G, J, K	500	110	F, G, J, K	300	820	F, G, J, K	150
2.0	B, C, D	500	16	F, G, J, K	500	120	F, G, J, K	300	910	F, G, J, K	150
2.2	B, C, D	500	18	F, G, J, K	500	130	F, G, J, K	300	1000	F, G, J, K	150
2.4	B, C, D	500									

TABLE V: TC: A (0±30PPM/°C)

Cap. pF	Cap. Tol.	WVDC	Cap. pF	Cap. Tol.	WVDC	Cap. pF	Cap. Tol.	WVDC	Cap. pF	Cap. Tol.	WVDC
0.1	B	500	3.9	B, C, D	500	47	F, G, J, K	500	560	F, G, J, K	150
0.2	B	500	4.3	B, C, D	500	51	F, G, J, K	500	620	F, G, J, K	150
0.3	B,C	500	4.7	B, C, D	500	56	F, G, J, K	500	680	F, G, J, K	150
0.4	B,C	500	5.1	B, C, D	500	62	F, G, J, K	500	750	F, G, J, K	150
0.5	B, C, D	500	5.6	B, C, D	500	68	F, G, J, K	500	820	F, G, J, K	150
0.6	B, C, D	500	6.2	B, C, D	500	75	F, G, J, K	500	910	F, G, J, K	150
0.7	B, C, D	500	6.8	B, C, J, K	500	82	F, G, J, K	500	1000	F, G, J, K	150
0.8	B, C, D	500	7.5	B, C, J, K	500	91	F, G, J, K	500	1100	F, G, J, K	50
0.9	B, C, D	500	8.2	B, C, J, K	500	100	F, G, J, K	500	1200	F, G, J, K	50
1.0	B, C, D	500	9.1	B, C, J, K	500	110	F, G, J, K	300	1300	F, G, J, K	50
1.1	B, C, D	500	10	F, G, J, K	500	120	F, G, J, K	300	1500	F, G, J, K	50
1.2	B, C, D	500	11	F, G, J, K	500	130	F, G, J, K	300	1600	F, G, J, K	50
1.3	B, C, D	500	12	F, G, J, K	500	150	F, G, J, K	300	1800	F, G, J, K	50
1.4	B, C, D	500	13	F, G, J, K	500	160	F, G, J, K	300	2000	F, G, J, K	50
1.5	B, C, D	500	15	F, G, J, K	500	180	F, G, J, K	300	2200	F, G, J, K	50
1.6	B, C, D	500	16	F, G, J, K	500	200	F, G, J, K	300	2400	F, G, J, K	50
1.7	B, C, D	500	18	F, G, J, K	500	220	F, G, J, K	200	2700	F, G, J, K	50
1.8	B, C, D	500	20	F, G, J, K	500	240	F, G, J, K	200	3000	F, G, J, K	50
1.9	B, C, D	500	22	F, G, J, K	500	270	F, G, J, K	200	3300	F, G, J, K	50
2.0	B, C, D	500	24	F, G, J, K	500	300	F, G, J, K	200	3600	F, G, J, K	50
2.2	B, C, D	500	27	F, G, J, K	500	330	F, G, J, K	200	3900	F, G, J, K	50
2.4	B, C, D	500	30	F, G, J, K	500	360	F, G, J, K	200	4300	F, G, J, K	50
2.7	B, C, D	500	33	F, G, J, K	500	390	F, G, J, K	200	4700	F, G, J, K	50
3.0	B, C, D	500	36	F, G, J, K	500	430	F, G, J, K	200	5000	F, G, J, K	50
3.3	B, C, D	500	39	F, G, J, K	500	470	F, G, J, K	200	5100	F, G, J, K	50
3.6	B, C, D	500	43	F, G, J, K	500	510	F, G, J, K	150			

TABLE VI: TC: C (±15%)

Cap. pF	Cap. Tol.	WVDC	Cap. pF	Cap. Tol.	WVDC	Cap. pF	Cap. Tol.	WVDC
5000	K, M, N	50	15000	K, M, N	50	47000	K, M, N	50
6800	K, M, N	50	18000	K, M, N	50	68000	K, M, N	50
8200	K, M, N	50				82000	K, M, N	50
10000	K, M, N	50	27000	K, M, N	50	100000	K, M, N	50
12000	K, M, N	50	33000	K, M, N	50			
			39000	K, M, N	50			

Microwave MLC's

SQ Series Ultra Low ESR MLC

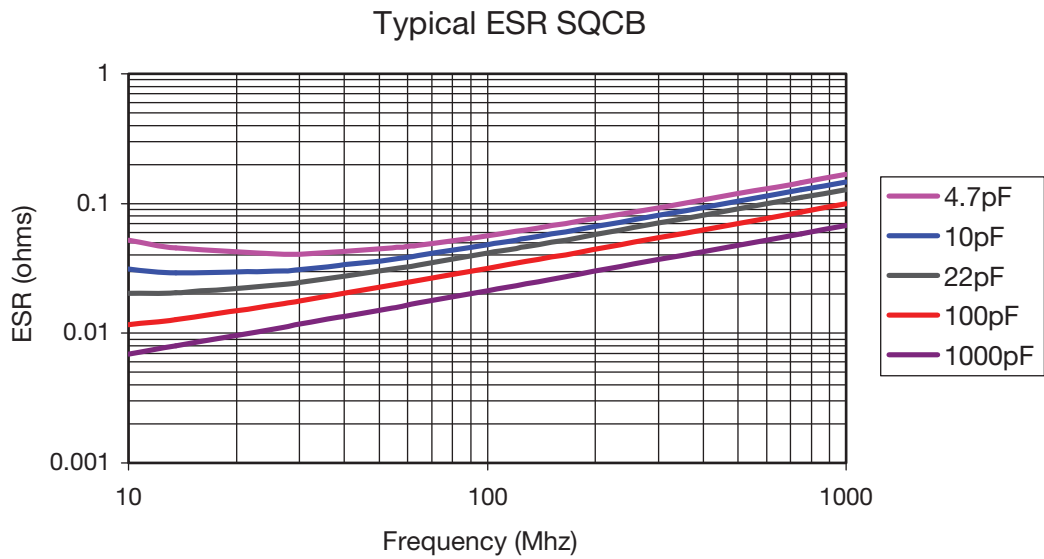
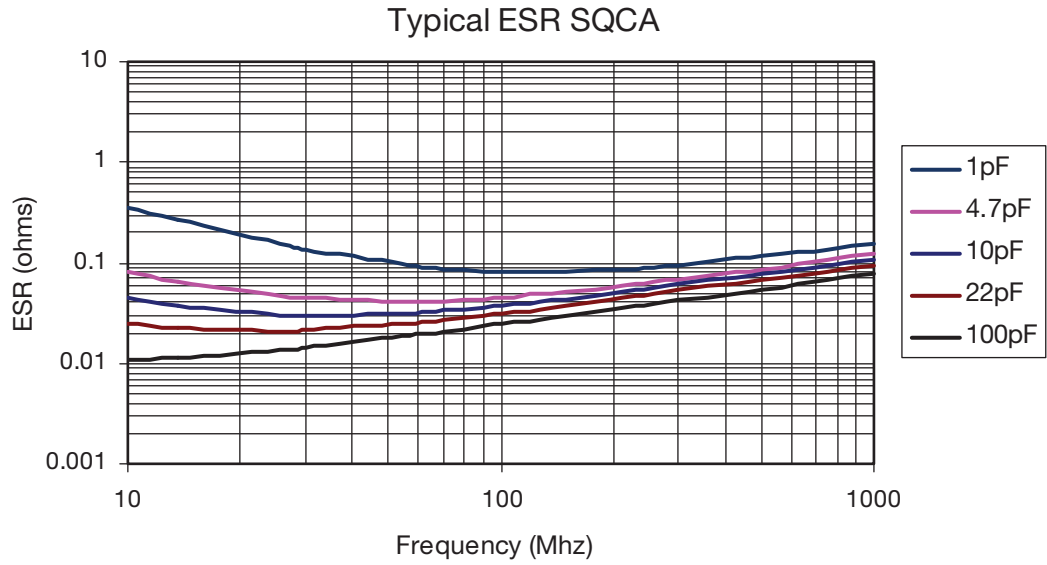

Microwave MLC's

SQ Series Ultra Low ESR MLC

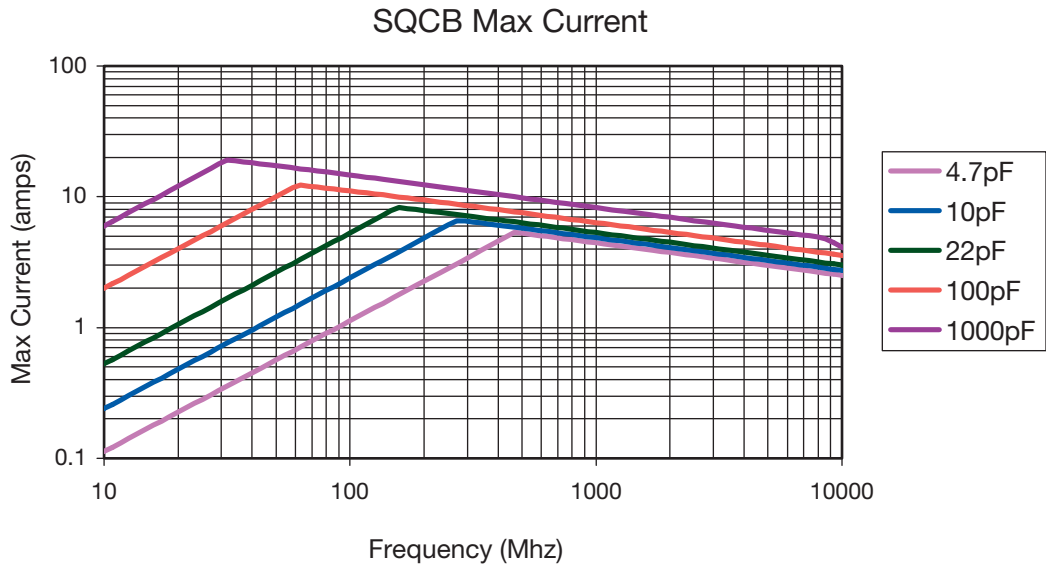
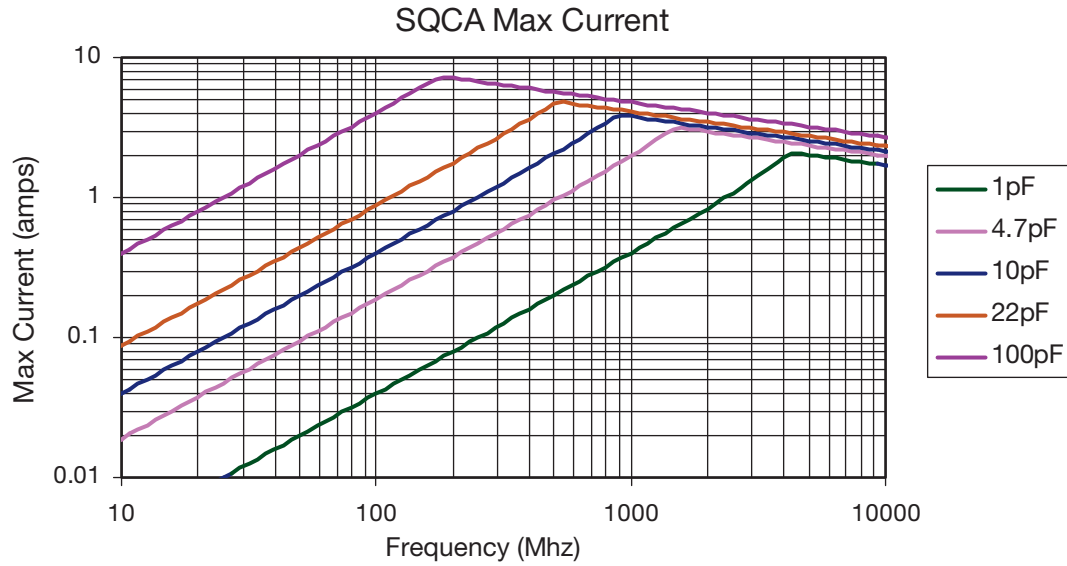

Microwave MLC's

SQ Series Ultra Low ESR MLC

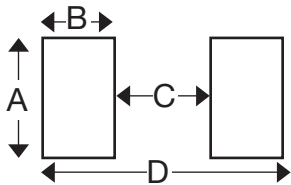
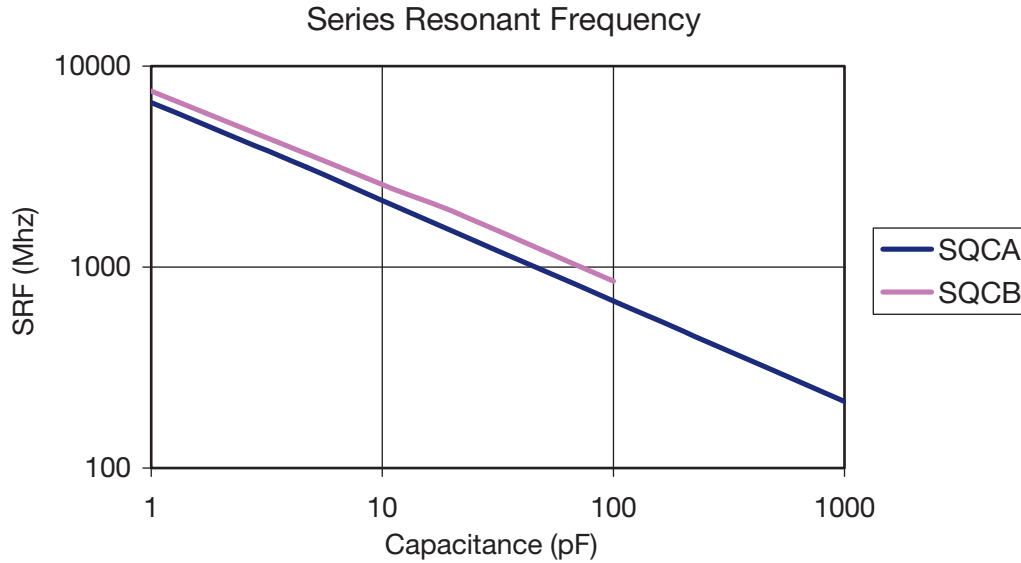

MOUNTING PAD DIMENSIONS: inches (millimeters)

Case	A min	B min	C min	D min
SQCA	0.082 (2.083)	0.051 (1.295)	0.032 (0.813)	0.130 (3.302)
SQCB	0.131 (3.327)	0.051 (1.295)	0.074 (1.880)	0.177 (4.496)
SQCS	0.038 (0.965)	0.043 (1.092)	0.025 (0.635)	0.112 (2.845)
SQCF	0.059 (1.499)	0.051 (1.295)	0.024 (0.610)	0.125 (3.175)

SQCA & SQCB DESIGN KITS

PN	Series	Diel	Term	Range	Different Values	# per value
KITSQ100LF	SQCA	P90	100% Tin RoHS	.1 to 2pF	16	15
KITSQ400LF		C0G				
KITSQ200LF	SQCA	P90	100% Tin RoHS	1 to 10pF	16	15
KITSQ500LF		C0G				
KITSQ300LF	SQCA	P90	100% Tin RoHS	10 to 100pF	16	15
KITSQ600LF		C0G				
KITSQ700LF	SQCA	C0G	100% Tin RoHS	100 to 1000pF	16	15
KITSQ800LF	SQCB	P90	100% Tin RoHS	1 to 10pF	16	15
KITSQ1100LF		C0G				
KITSQ900LF	SQCB	P90	100% Tin RoHS	10 to 100pF	16	15
KITSQ1200LF		C0G				
KITSQ1000LF	SQCB	P90	100% Tin RoHS	100 to 1000pF	16	15
KITSQ1300LF		C0G				
KITSQ1400LF	SQCB	C0G	100% Tin RoHS	1000 to 5100 pF	11	15

Microwave MLC's



SQCS (0603) SQCF (0805) Ultra Low ESR MLC

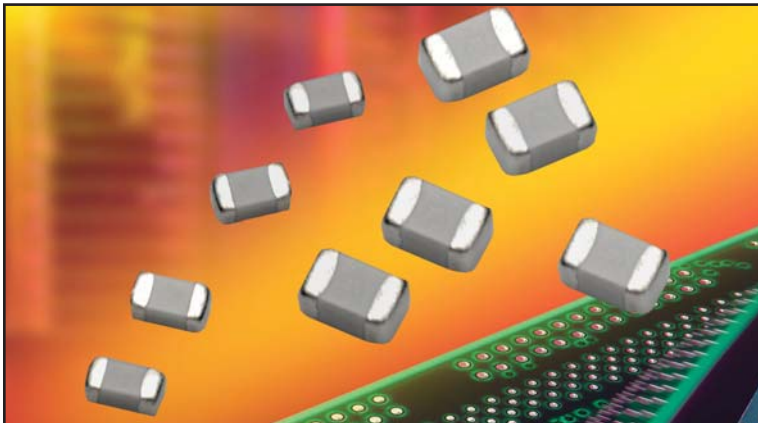

FEATURES:

- Low ESR
- High Q
- High Self Resonance
- Capacitance Range 0.1 pF to 240 pF
- EIA Size

APPLICATIONS:

- RF Power Amplifiers
- Low Noise Amplifiers
- Filter Networks
- Point to Point Radios

HOW TO ORDER

<p>SQ</p> <p>AVX Style</p>	<p>CS</p> <p>Case Size CS = 0603 CF = 0805</p>	<p>V</p> <p>Voltage Code V = 250V</p>	<p>A</p> <p>Temperature Coefficient Code A = 0±30ppm/°C</p>	<p>100</p> <p>Capacitance EIA Capacitance Code in pF. First two digits = significant figures or "R" for decimal place. Third digit = number of zeros or after "R" significant figures.</p>	<p>J</p> <p>Capacitance Tolerance Code A = ±.05 pF B = ±.1 pF C = ±.25 pF D = ±.5 pF F = ±1% G = ±2% J = ±5%</p>	<p>A</p> <p>Failure Rate Code A = Not Applicable</p>	<p>T</p> <p>Termination Style Code **1 = Pd/Ag **7 = Ag/Ni/Au J = Nickel Barrier Sn/Pb (60/40) **T = 100% Tin (Standard)</p>	<p>1A</p> <p>Packaging Code 1A = 7" Reel Unmarked ME = 7" Reel Marked</p> <p>* Vertical T&R available * 500 piece reels available</p>
-----------------------------------	---	--	--	---	---	---	---	--

****RoHS compliant**

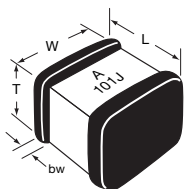

MECHANICAL DIMENSIONS: inches (millimeters)

Case	Length (L)	Width (W)	Thickness (T)	Band Width (bw)
SQCS	.063±.006 (1.60±.152)	.032±.006 (.813±.152)	.030 Max. (.762)	.014±.006 (.357±.152)
SQCF	.079±.008 (2.01±.200)	.049±.008 (1.24±.200)	.045 Max. (1.14)	.014±.006 (.357±.152)

TAPE & REEL: All tape and reel specifications are in compliance with EIA RS481 (equivalent to IEC 286 part 3).

- 8mm carrier
- 7" reel = 4000 pcs (500 piece options)

Not RoHS Compliant



For RoHS compliant products, please select correct termination style.



Microwave MLC's

Low ESR MLC Capacitors



ELECTRICAL SPECIFICATIONS

Temperature Coefficient (TCC)	(A) 0 ± 30 PPM/°C
Operating Temperature	-55°C to +125°C
Quality Factor (Q)	Greater than 10,000 at 1 MHz
Insulation Resistance (IR)	0.1 pF to 240 pF 10 ⁸ Megohms min. @ 25°C at rated WVDC 10 ⁴ Megohms min. @ 125°C at rated WVDC
Working Voltage (WVDC)	See Capacitance Values table
Dielectric Withstanding Voltage (DWW)	250% of rated WVDC for 5 secs
Aging Effects	None
Piezoelectric Effects	None
Capacitance Drift	± (0.02% or 0.02 pF), whichever is greater

ENVIRONMENTAL CHARACTERISTICS

AVX SQ will meet and exceed the requirements of EIA-198, MIL-PRF-55681 and MIL-PRF-123

Thermal Shock	Mil-STD-202, Method 107, Condition A
Moisture Resistance	Mil-STD-202, Method 106
Low Voltage Humidity	Mil-STD-202, Method 103, condition A, with 1.5 VDC applied while subjected to an environment of 85°C with 85% relative humidity for 240 hours
Life Test	Mil-STD-202, Method 108, for 2000 hours at 125°C
Shock	Mil-STD-202, Method 213, Condition J
Vibration	Mil-STD-202, Method 204, Condition B
Immersion	Mil-STD-202, Method 104, Condition B
Salt Spray	Mil-STD-202, Method 101, Condition B
Solderability	Mil-STD-202, Method 208
Terminal Strength	Mil-STD-202, Method 211
Temperature Cycling	Mil-STD-202, Method 102, Condition C
Barometric Pressure	Mil-STD-202, Method 105, Condition B
Resistance to Solder Heat	Mil-STD-202, Method 210, Condition C

Microwave MLC's



SQ Series Available Capacitance/Size/WVDC/T.C.

TABLE I: TC: A (0±30PPM/°C) CASE SIZE S

Cap. pF	Cap. Tol.	WVDC	Cap. pF	Cap. Tol.	WVDC	Cap. pF	Cap. Tol.	WVDC
0.1	A, B	250	2.4	A, B, C	250	18	F, G, J	250
0.2	A, B	250	2.7	A, B, C	250	20	F, G, J	250
0.3	A, B	250	3.0	A, B, C	250	22	F, G, J	250
0.4	A, B	250	3.3	A, B, C	250	24	F, G, J	250
0.5	A, B, C	250	3.6	A, B, C	250	27	F, G, J	250
0.6	A, B, C	250	3.9	A, B, C	250	30	F, G, J	250
0.7	A, B, C	250	4.3	A, B, C	250	33	F, G, J	250
0.8	A, B, C	250	4.7	A, B, C	250	36	F, G, J	250
0.9	A, B, C	250	5.1	A, B, C	250	39	F, G, J	250
1.0	A, B, C	250	5.6	A, B, C	250	43	F, G, J	250
1.1	A, B, C	250	6.2	A, B, C	250	47	F, G, J	250
1.2	A, B, C	250	6.8	B, C, D	250	51	F, G, J	250
1.3	A, B, C	250	7.5	B, C, D	250	56	F, G, J	250
1.4	A, B, C	250	8.2	B, C, D	250	62	F, G, J	250
1.5	A, B, C	250	9.1	B, C, D	250	68	F, G, J	250
1.6	A, B, C	250	10	F, G, J	250	75	F, G, J	250
1.7	A, B, C	250	11	F, G, J	250	82	F, G, J	250
1.8	A, B, C	250	12	F, G, J	250	91	F, G, J	250
1.9	A, B, C	250	13	F, G, J	250	100	F, G, J	250
2.0	A, B, C	250	15	F, G, J	250			
2.2	A, B, C	250	16	F, G, J	250			

TABLE II: TC: A (0±30PPM/°C) CASE SIZE F

Cap. pF	Cap. Tol.	WVDC	Cap. pF	Cap. Tol.	WVDC	Cap. pF	Cap. Tol.	WVDC	Cap. pF	Cap. Tol.	WVDC
0.1	A, B	250	2.4	A, B, C	250	18	F, G, J	250	150	F, G, J	250
0.2	A, B	250	2.7	A, B, C	250	20	F, G, J	250	180	F, G, J	250
0.3	A, B	250	3.0	A, B, C	250	22	F, G, J	250	200	F, G, J	250
0.4	A, B	250	3.3	A, B, C	250	24	F, G, J	250	220	F, G, J	250
0.5	A, B, C	250	3.6	A, B, C	250	27	F, G, J	250	240	F, G, J	250
0.6	A, B, C	250	3.9	A, B, C	250	30	F, G, J	250			
0.7	A, B, C	250	4.3	A, B, C	250	33	F, G, J	250			
0.8	A, B, C	250	4.7	A, B, C	250	36	F, G, J	250			
0.9	A, B, C	250	5.1	A, B, C	250	39	F, G, J	250			
1.0	A, B, C	250	5.6	A, B, C	250	43	F, G, J	250			
1.1	A, B, C	250	6.2	A, B, C	250	47	F, G, J	250			
1.2	A, B, C	250	6.8	B, C, D	250	51	F, G, J	250			
1.3	A, B, C	250	7.5	B, C, D	250	56	F, G, J	250			
1.4	A, B, C	250	8.2	B, C, D	250	62	F, G, J	250			
1.5	A, B, C	250	9.1	B, C, D	250	68	F, G, J	250			
1.6	A, B, C	250	10	F, G, J	250	75	F, G, J	250			
1.7	A, B, C	250	11	F, G, J	250	82	F, G, J	250			
1.8	A, B, C	250	12	F, G, J	250	91	F, G, J	250			
1.9	A, B, C	250	13	F, G, J	250	100	F, G, J	250			
2.0	A, B, C	250	15	F, G, J	250	110	F, G, J	250			
2.2	A, B, C	250	16	F, G, J	250	120	F, G, J	250			

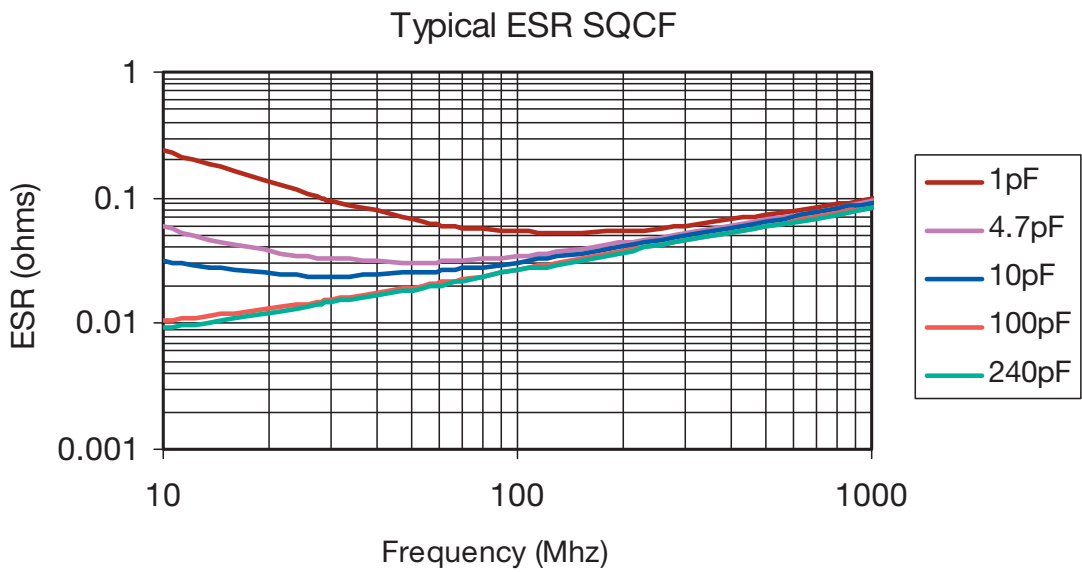
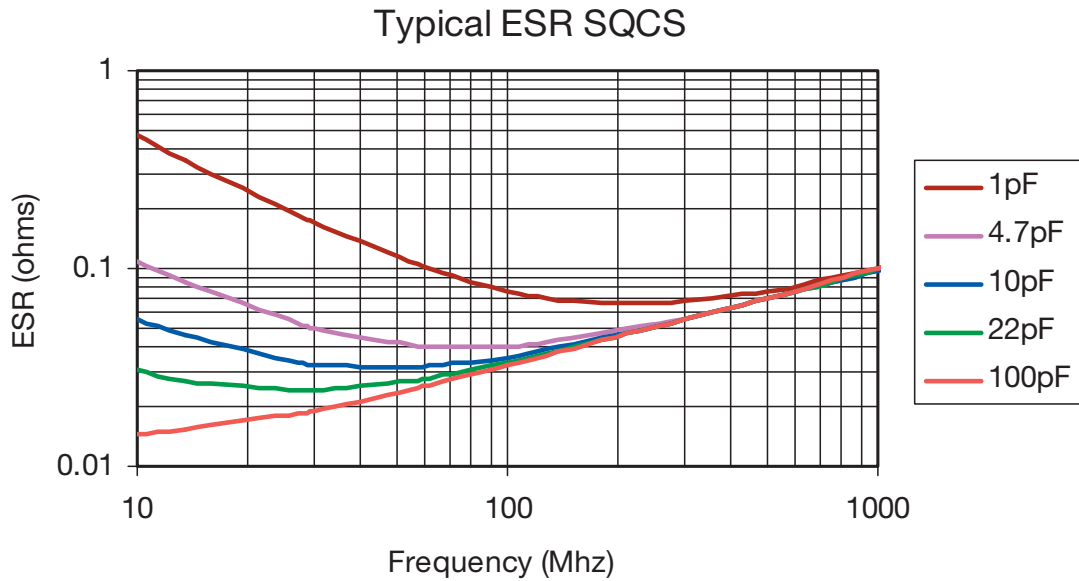

Microwave MLC's

SQCS (0603) SQCF (0805) Ultra Low ESR MLC



Max Current SQCS

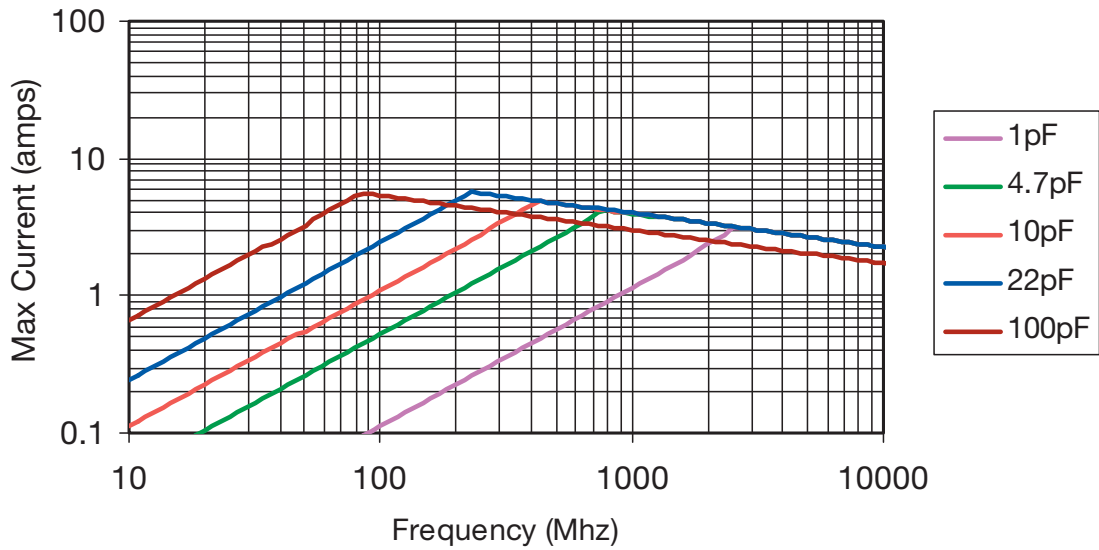

Max Current SQCF

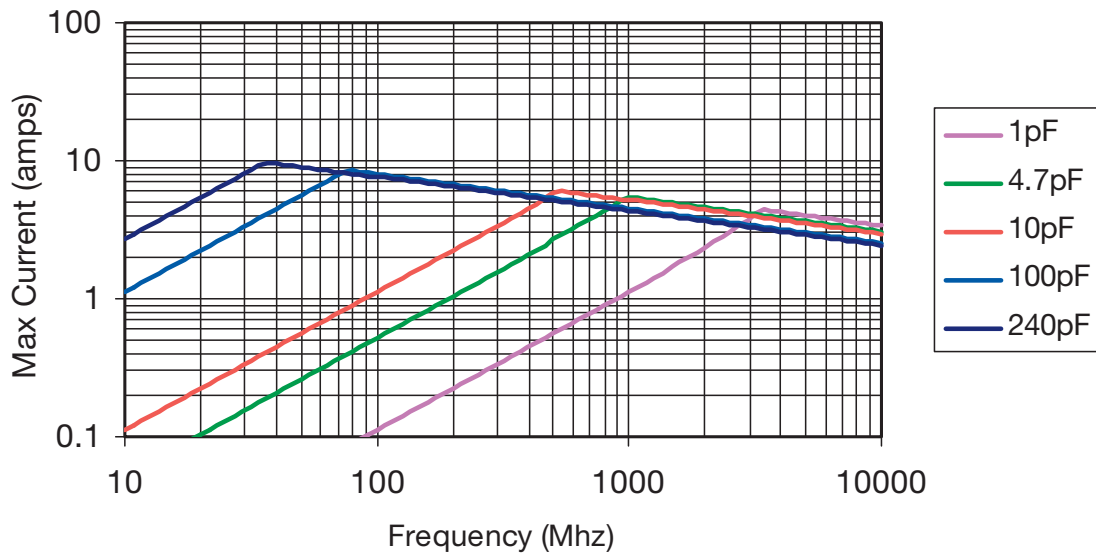

Microwave MLC's

SQCS (0603) SQCF (0805) Ultra Low ESR MLC

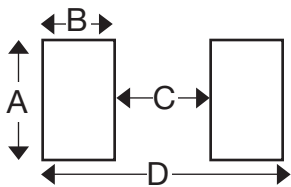
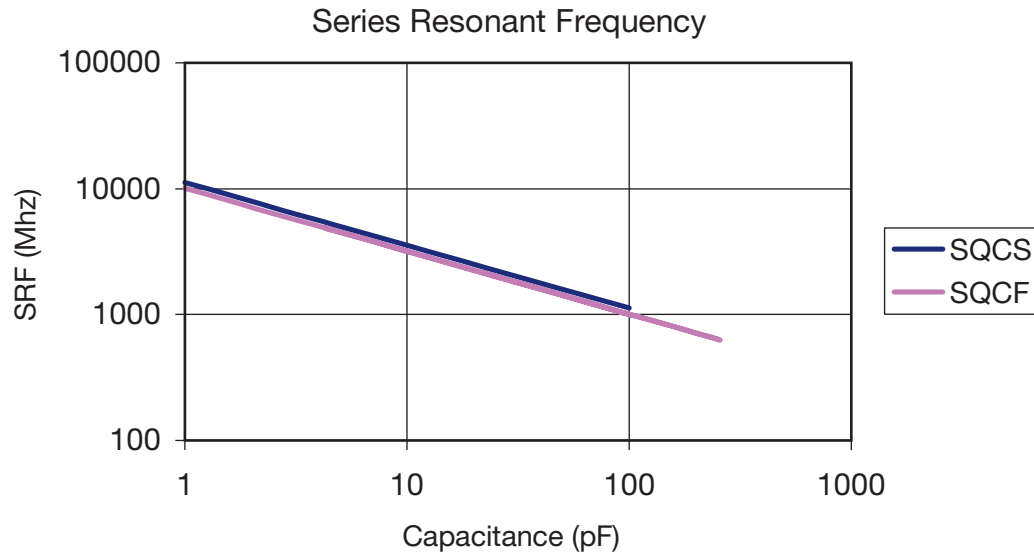

MOUNTING PAD DIMENSIONS: inches (millimeters)

Case	A min	B min	C min	D min
SQCA	0.082 (2.083)	0.051 (1.295)	0.032 (0.813)	0.130 (3.302)
SQCB	0.131 (3.327)	0.051 (1.295)	0.074 (1.880)	0.177 (4.496)
SQCS	0.038 (0.965)	0.043 (1.092)	0.025 (0.635)	0.112 (2.845)
SQCF	0.059 (1.499)	0.051 (1.295)	0.024 (0.610)	0.125 (3.175)

SQCS & SQCF ENGINEERING KITS

PN	Series	Diel	Term	Range	Different Values	# per value
Kit SQ1800LF	SQCF	C0G	100% Tin	.1 to 10pF	27	15
Kit SQ1900LF			RoHS	10 to 240pF	22	
Kit SQ1500LF	SQCS	C0G	100% Tin	.1 to 10pF	27	15
Kit SQ1600LF			RoHS	10 to 100pF	16	

Tolerance per PF:	
B from .1 to 3.3	J from 10 to 240
C from 3.9 to 8.2	

MK Series Capacitors



Ultra Low ESR, C0G (NP0) Chip Capacitors

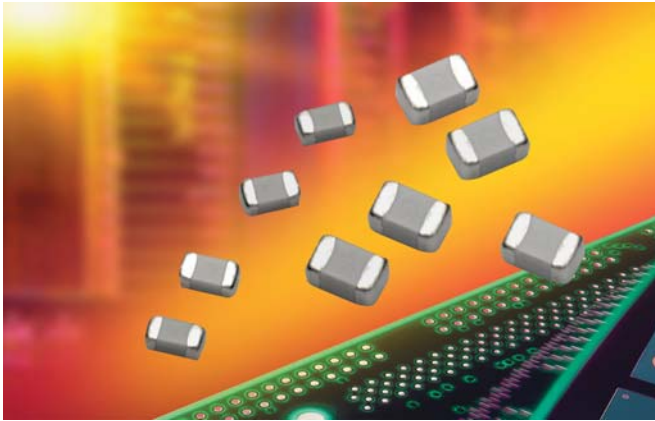

GENERAL INFORMATION

Capacitors are C0G (NP0) chip capacitors specially designed for "Ultra" low ESR for applications in the communications market. Max ESR and effective capacitance are met on each value producing lot to lot uniformity. Sizes available are EIA chip sizes 0402, 0603, 0805, and 1210.

DIMENSIONS: inches (millimeters)

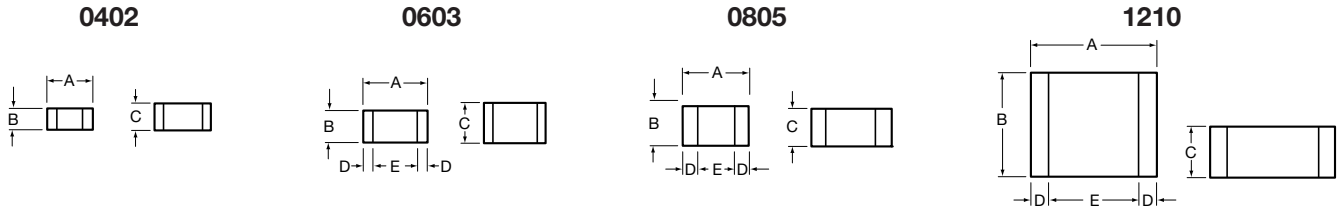

Size	A	B	C	D	E
0402	0.039±0.004 (1.00±0.1)	0.020±0.004 (0.50±0.1)	0.024 (0.6) max	N/A	N/A
0603	0.060±0.010 (1.52±0.25)	0.030±0.010 (0.76±0.25)	0.036 (0.91) max	0.010±0.005 (0.25±0.13)	0.030 (0.76) min
0805	0.079±0.008 (2.01±0.2)	0.049±0.008 (1.25±0.2)	0.040±0.005 (1.02±0.127)	0.020±0.010 (0.51±0.254)	0.020 (0.51) min
1210	0.126±0.008 (3.2±0.2)	0.098±0.008 (2.49±0.2)	0.050±0.005 (1.27±0.127)	0.025±0.015 (0.635±0.381)	0.040 (1.02) min

HOW TO ORDER

<p>MK05</p> <p>Case Size MK02 = 0402 MK03 = 0603 MK05 = 0805 MK10 = 1210</p>	<p>V</p> <p>Voltage Code 3 = 25V 5 = 50V 1 = 100V 2 = 200V V = 250V 7 = 500V</p>	<p>7</p> <p>Dielectric = Ultra Low ESR</p>	<p>100</p> <p>Capacitance EIA Capacitance Code in pF. First two digits = significant figures or "R" for decimal place. Third digit = number of zeros or after "R" significant figures.</p>	<p>J</p> <p>Capacitance Tolerance Code B = ±0.1pF C = ±0.25pF D = ±0.5pF F = ±1% G = ±2% J = ±5% K = ±10% M = ±20%</p>	<p>A</p> <p>Failure Rate Code A = Not Applicable</p>	<p>T</p> <p>Termination T = 100% Tin</p>	<p>2</p> <p>Packaging Code 2 = 7" Reel 4 = 13" Reel 9 = Bulk</p>	<p>A</p> <p>Special Code A = Standard</p>
--	--	--	---	--	---	---	---	--



MK Series Capacitors



Ultra Low ESR, C0G (NP0) Chip Capacitors

ELECTRICAL CHARACTERISTICS

Capacitance Values and Tolerances:

- Size MK02 - 0.2 pF to 30 pF @ 1 MHz
- Size MK03 - 0.2 pF to 120 pF @ 1 MHz
- Size MK05 - 1.0 pF to 160 pF @ 1 MHz
- Size MK10 - 1.0 pF to 1000 pF @ 1 MHz

Temperature Coefficient of Capacitance (TC):

0±30 ppm/°C (-55° to +125°C)

Insulation Resistance (IR):

- 10¹² Ω min. @ 25°C and rated WVDC
- 10¹¹ Ω min. @ 125°C and rated WVDC

Working Voltage (WVDC):

- Size Working Voltage
- MK02 - 50, 25 WVDC
- MK03 - 250, 200, 100, 50 WVDC
- MK05 - 250 WVDC
- MK10 - 500, 200, 100 WVDC

Dielectric Working Voltage (DWV):

250% of rated WVDC

Equivalent Series Resistance Typical (ESR):

- MK02 - See Performance Curve, page 207
- MK03 - See Performance Curve, page 207
- MK05 - See Performance Curve, page 207
- MK10 - See Performance Curve, page 207

MILITARY SPECIFICATIONS

Meets or exceeds the requirements of MIL-C-55681

CAPACITANCE RANGE

Cap (pF)	Available	Size			
	Tolerance	MK02	MK03	MK05	MK10
0.2	B,C	50V	250V	N/A	N/A
0.3	↓	↓	↓	↓	↓
0.4	B,C	↓	↓	↓	↓
0.5	↓	↓	↓	↓	↓
0.6	B,C,D	↓	↓	↓	↓
0.7	↓	↓	↓	↓	↓
0.8	↓	↓	↓	↓	↓
0.9	B,C,D	↓	↓	↓	↓

Cap (pF)	Available	Size			
	Tolerance	MK02	MK03	MK05	MK10
1.0	B,C,D	50V	250V	250V	500V
1.1	↓	↓	↓	↓	↓
1.2	↓	↓	↓	↓	↓
1.3	↓	↓	↓	↓	↓
1.4	↓	↓	↓	↓	↓
1.5	↓	↓	↓	↓	↓
1.6	↓	↓	↓	↓	↓
1.7	↓	↓	↓	↓	↓
1.8	↓	↓	↓	↓	↓
1.9	↓	↓	↓	↓	↓
2.0	↓	↓	↓	↓	↓
2.1	↓	↓	↓	↓	↓
2.2	↓	↓	↓	↓	↓
2.4	↓	↓	↓	↓	↓
2.7	↓	↓	↓	↓	↓
3.0	↓	↓	↓	↓	↓
3.3	↓	↓	↓	↓	↓
3.6	↓	↓	↓	↓	↓
3.9	↓	↓	↓	↓	↓
4.3	↓	↓	↓	↓	↓
4.7	↓	↓	↓	↓	↓
5.1	↓	↓	↓	↓	↓
5.6	↓	↓	↓	↓	↓
6.2	B,C,D	↓	↓	↓	↓
6.8	B,C,J,K,M	↓	↓	↓	↓

Cap (pF)	Available	Size			
	Tolerance	MK02	MK03	MK05	MK10
7.5	B,C,J,K,M	50V	250V	250V	500V
8.2	↓	↓	↓	↓	↓
9.1	B,C,J,K,M	↓	↓	↓	↓
10	F,G,J,K,M	↓	↓	↓	↓
11	↓	↓	↓	↓	↓
12	↓	↓	↓	↓	↓
13	↓	↓	↓	↓	↓
15	↓	↓	↓	↓	↓
18	↓	↓	↓	↓	↓
20	↓	↓	↓	↓	↓
22	↓	↓	↓	↓	↓
24	↓	↓	↓	↓	↓
27	↓	↓	↓	↓	↓
30	↓	↓	↓	↓	↓
33	↓	↓	↓	↓	↓
36	↓	↓	↓	↓	↓
39	↓	↓	↓	↓	↓
43	↓	↓	↓	↓	↓
47	↓	↓	↓	↓	↓
51	↓	↓	↓	↓	↓
56	↓	↓	↓	↓	↓
68	↓	↓	↓	↓	↓
75	↓	↓	↓	↓	↓
82	↓	↓	↓	↓	↓
91	↓	↓	↓	↓	↓

Cap (pF)	Available	Size			
	Tolerance	MK02	MK03	MK05	MK10
100	F,G,J,K,M	N/A	100V	250V	500V
110	↓	↓	↓	↓	↓
120	↓	↓	↓	↓	↓
130	↓	↓	↓	↓	↓
140	↓	↓	↓	↓	↓
150	↓	↓	↓	↓	↓
160	↓	↓	↓	↓	↓
180	↓	↓	↓	↓	↓
200	↓	↓	↓	↓	↓
220	↓	↓	↓	↓	↓
270	↓	↓	↓	↓	↓
300	↓	↓	↓	↓	↓
330	↓	↓	↓	↓	↓
360	↓	↓	↓	↓	↓
390	↓	↓	↓	↓	↓
430	↓	↓	↓	↓	↓
470	↓	↓	↓	↓	↓
510	↓	↓	↓	↓	↓
560	↓	↓	↓	↓	↓
620	↓	↓	↓	↓	↓
680	↓	↓	↓	↓	↓
750	↓	↓	↓	↓	↓
820	↓	↓	↓	↓	↓
910	↓	↓	↓	↓	↓
1000	F,G,J,K,M	↓	↓	↓	↓



MK Series Capacitors

Ultra Low ESR, C0G (NP0) Chip Capacitors

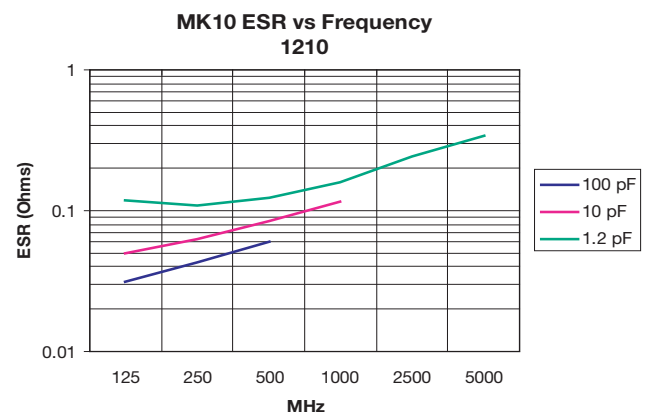
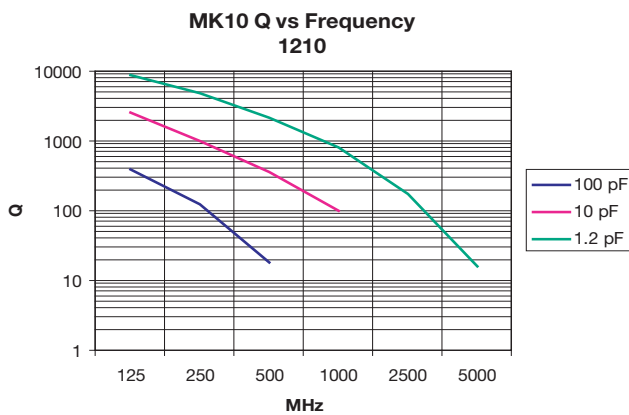
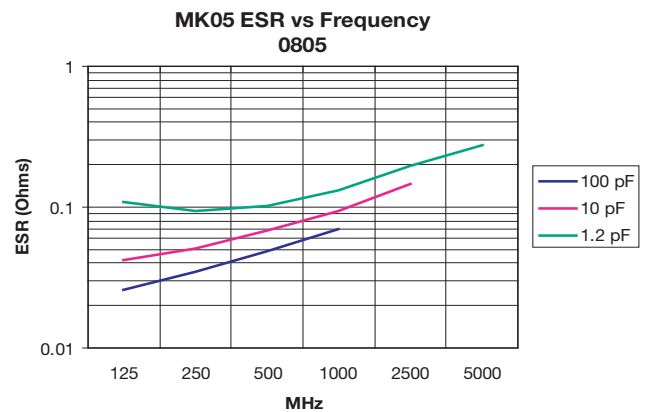
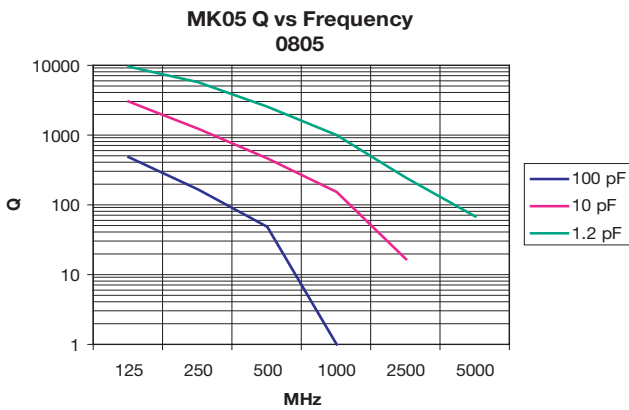
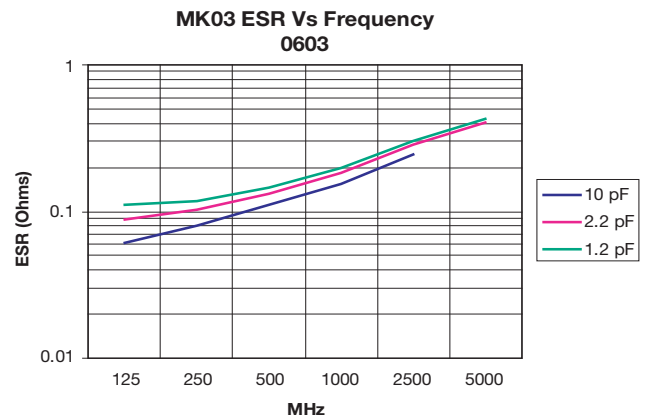
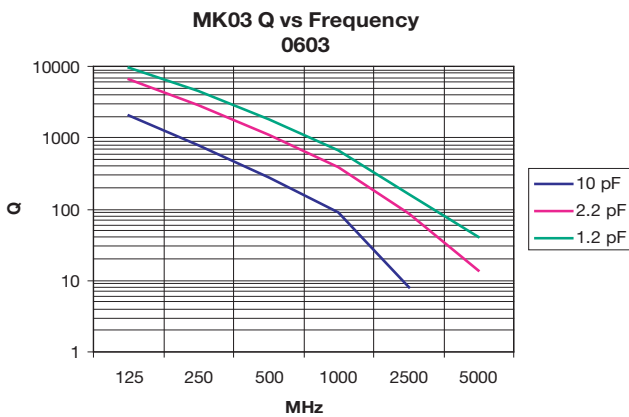
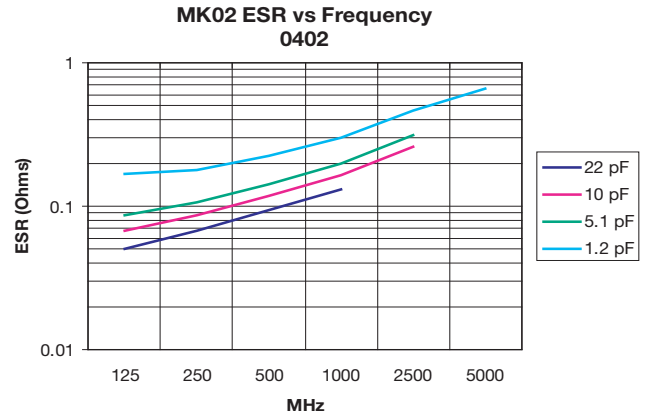
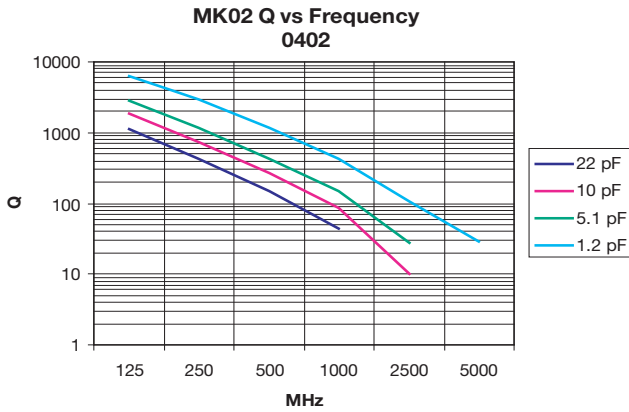

Microwave MLC's



AQ Series

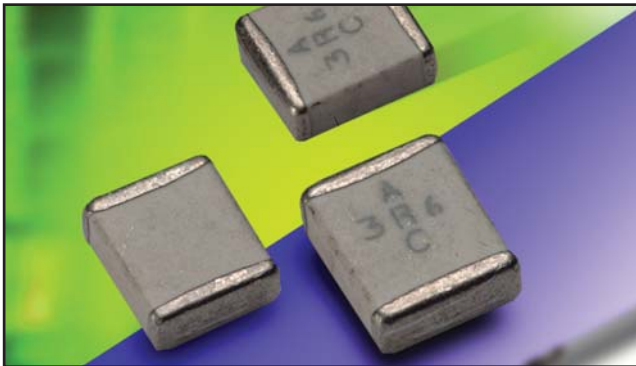

These porcelain and ceramic dielectric multilayer capacitor (MLC) chips are best suited for RF/ Microwave applications typically ranging from 10 MHz to 4.2 GHz. Characteristic is a fine grained, high density, high purity dielectric material impervious to moisture with heavy internal palladium electrodes.

These characteristics lend well to applications requiring:

- 1) high current carrying capabilities;
- 2) high quality factors;
- 3) very low equivalent series resistance;
- 4) very high series resonance;
- 5) excellent stability under stresses of changing voltage, frequency, time and temperature.

MECHANICAL DIMENSIONS: inches (millimeters)

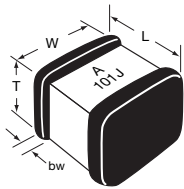

Case	Length (L)	Width (W)	Thickness (T)	Band Width (bw)
AQ11	.055±.015 (1.40±.381)	.055±.015 (1.40±.381)	.020/.057 (.508/1.45)	.010 + .010 -.005 (.254 +.254 -.127)
AQ12	.055 + .015 - .010 (1.40+ .381 - .254)	.055±.015 (1.40±.381)	.020/.057 (.508/1.45)	.010 + .010 -.005 (.254 +.254 -.127)
AQ13	.110±.020 (2.79±.508)	.110±.020 (2.79±.508)	.030/.102 (.762/2.59)	.015±.010 (.381±.254)
AQ14	.110 + .020 - .010 (2.79 +.889 -.254)	.110±.010 (2.79±.508)	.030/.102 (.762/2.59)	.015±.010 (.381±.254)

HOW TO ORDER

<p>AQ</p> <p>AVX Style AQ11, AQ12, AQ13, AQ14</p>	<p>11</p> <p>Case Size (See Chart)</p>	<p>E</p> <p>Voltage Code 5 = 50V 1 = 100V E = 150V 2 = 200V 9 = 300V 7 = 500V</p>	<p>M</p> <p>Temperature Coefficient Code M = +90±20ppm/°C (AQ11/12/13/14) A = 0±30ppm/°C (AQ11/12/13/14) C = 15% ("J" Termination only) (AQ12/14)</p>	<p>100</p> <p>Capacitance EIA Capacitance Code in pF. First two digits = significant figures or "R" for decimal place. Third digit = number of zeros or after "R" significant figures.</p>	<p>J</p> <p>Capacitance Tolerance Code B = ±.1 pF C = ±.25 pF D = ±.5 pF F = ±1% G = ±2% J = ±5% K = ±10% M = ±20% N = ±30%</p>	<p>A</p> <p>Failure Rate Code A = Not Applicable</p>	<p>1</p> <p>Termination Style Code 1 = Pd/Ag (AQ11/13 only) 7 = Ag/Ni/Au (AQ11/13 only) J = Nickel Barrier Sn/Pb (60/40) - (AQ12/14 only) T = 100% Tin (AQ12/14 only)</p>	<p>ME</p> <p>Packaging* Code 3A = 13" Reel Unmarked ME = 7" Reel Marked RE = 13" Reel Marked WE = Waffle Pack Marked BE = Bulk Marked</p>
--	---	--	--	---	--	---	--	--

PACKAGING

Standard Packaging = Waffle Pack (maximum quantity is 80)

TAPE & REEL: All tape and reel specifications are in compliance with EIA RS481 (equivalent to IEC 286 part 3).

Sizes SQCA through SQCB, CDR11/12 through 13/14.

- 8mm carrier
- 7" reel: ≤0.040" thickness = 2000 pcs
 ≤0.075" thickness = 2000 pcs
- 13" reel: ≤0.075" thickness = 10,000 pcs

Not RoHS Compliant



For RoHS compliant products, please select correct termination style.



ELECTRICAL SPECIFICATIONS

AQ11, AQ12, AQ13, AQ14			
		M & A	C
Temperature Coefficient (TCC)		(M) +90 ± 20 PPM/°C (-55°C to +125°C) (M) +90 ± 30 PPM/°C (+125°C to +175°C) (A) 0 ± 30 PPM/°C	±15% (-55°C to 125°C)
Capacitance Range		(M) 0.1 pF to 1000 pF (A) 0.1 pF to 5100 pF	0.001µF to 0.1µF
Operating Temperature		0.1 pF to 330 pF: from -55°C to +175°C 360 pF to 5100 pF: from -55°C to +125°C	-55°C to +125°C
Quality Factor (Q)	M Dielectric A & B Case	Greater than 10,000 at 1 MHz	2.5% @ 1kHz
	A Dielectric B Case	Greater than 10,000 at 1 MHz Greater than 2,000 at 1 MHz Greater than 2,000 at 1 KHz	0.1 - 200 pF 220 - 1000 pF 1100 - 5100 pF
	A Dielectric A Case	Greater than 10,000 at 1 MHz Greater than 2,000 at 1 MHz	0.1 - 100 pF 110 - 1000 pF
Insulation Resistance (IR)		0.1 pF to 470 pF 10 ⁹ Megohms min. @ 25°C at rated WVDC 10 ⁹ Megohms min. @ 125°C at rated WVDC 510 pF to 5100 pF 10 ⁹ Megohms min. @ 25°C at rated WVDC 10 ⁹ Megohms min. @ 125°C at rated WVDC	10 ⁴ Megohms min. @ 25°C at rated WVDC 10 ³ Megohms min. @ 125°C at rated WVDC
Working Voltage (WVDC)		See Capacitance Values table	See Capacitance Values table
Dielectric Withstanding Voltage (DWW)		250% of rated WVDC for 5 secs (for 500V rated 150% of rated voltage)	250% of rated WVDC for 5 secs
Aging Effects		None	<3% per decade hour
Piezoelectric Effects		None	None
Capacitance Drift		± (0.02% or 0.02 pF), whichever is greater	Not Applicable

ENVIRONMENTAL CHARACTERISTICS

AVX SQLB will meet and exceed the requirements of EIA-198, MIL-PRF-55681 and MIL-PRF-123

Thermal Shock	Mil-STD-202, Method 107, Condition A
Moisture Resistance	Mil-STD-202, Method 106
Low Voltage Humidity	Mil-STD-202, Method 103, condition A, with 1.5 VDC applied while subjected to an environment of 85°C with 85% relative humidity for 240 hours
Life Test	Mil-STD-202, Method 108, for 2000 hours at 125°C
Shock	Mil-STD-202, Method 213, Condition J
Vibration	Mil-STD-202, Method 204, Condition B
Immersion	Mil-STD-202, Method 104, Condition B
Salt Spray	Mil-STD-202, Method 101, Condition B
Solderability	Mil-STD-202, Method 208
Terminal Strength	Mil-STD-202, Method 211
Temperature Cycling	Mil-STD-202, Method 102, Condition C
Barometric Pressure	Mil-STD-202, Method 105, Condition B
Resistance to Solder Heat	Mil-STD-202, Method 210, Condition C

Microwave MLC's



AQ Series Available Capacitance/Size/WVDC/T.C.

TABLE I: TC: M (+90±20PPM/°C)

CASE SIZE 11, 12, 13 & 14

DIMENSIONS: inches (millimeters)

Case	Length	Width	Thickness	Band Width	Avail. Term.
11	.055±.015 (1.40±.381)	.055±.015 (1.40±.381)	.020/.057 (.508/1.45)	.010 +.010 -.005 (.254 +.254 -.127)	1 & 7
12	.055±.025 (1.40±.635)	.055±.015 (1.40±.381)	.020/.057 (.508/1.45)	.010 +.010 -.005 (.254 +.254 -.127)	J
13	.110±.020 (2.79±.508)	.110±.020 (2.79±.508)	.030/.102 (.762/2.59)	.015±.010 (.381±.254)	1 & 7
14	.110 +0.035 -0.020 (2.79 +.889 -.508)	.110±.020 (2.79±.508)	.030/.102 (.762/2.59)	.015±.010 (.381±.254)	J

Case: AQ11, AQ12		
Cap. pF	Cap. Tol.	WVDC
0.1	B	150
0.2	B	150
0.3	B,C	150
0.4	B,C	150
0.5	B, C, D	150
0.6	B, C, D	150
0.7	B, C, D	150
0.8	B, C, D	150
0.9	B, C, D	150
1.0	B, C, D	150
1.1	B, C, D	150
1.2	B, C, D	150
1.3	B, C, D	150
1.4	B, C, D	150
1.5	B, C, D	150
1.6	B, C, D	150
1.7	B, C, D	150
1.8	B, C, D	150
1.9	B, C, D	150
2.0	B, C, D	150
2.2	B, C, D	150
2.4	B, C, D	150
2.7	B, C, D	150
3.0	B, C, D	150
3.3	B, C, D	150
3.6	B, C, D	150
3.9	B, C, D	150
4.3	B, C, D	150
4.7	B, C, D	150
5.1	B, C, D	150
5.6	B, C, D	150
6.2	B, C, D	150
6.8	B, C, J, K, M	150
7.5	B, C, J, K, M	150
8.2	B, C, J, K, M	150
9.1	B, C, J, K, M	150
10	F, G, J, K, M	150
11	F, G, J, K, M	150
12	F, G, J, K, M	150
13	F, G, J, K, M	150
15	F, G, J, K, M	150
16	F, G, J, K, M	150
18	F, G, J, K, M	150
20	F, G, J, K, M	150
22	F, G, J, K, M	150
24	F, G, J, K, M	150
27	F, G, J, K, M	150
30	F, G, J, K, M	150
33	F, G, J, K, M	150
36	F, G, J, K, M	150
39	F, G, J, K, M	150
43	F, G, J, K, M	150
47	F, G, J, K, M	150
51	F, G, J, K, M	150
56	F, G, J, K, M	150
62	F, G, J, K, M	150
68	F, G, J, K, M	150
75	F, G, J, K, M	150
82	F, G, J, K, M	150
91	F, G, J, K, M	150
100	F, G, J, K, M	150

Case: AQ13, AQ14		
Cap. pF	Cap. Tol.	WVDC
0.1	B	500
0.2	B	500
0.3	B,C	500
0.4	B,C	500
0.5	B, C, D	500
0.6	B, C, D	500
0.7	B, C, D	500
0.8	B, C, D	500
0.9	B, C, D	500
1.0	B, C, D	500
1.1	B, C, D	500
1.2	B, C, D	500
1.3	B, C, D	500
1.4	B, C, D	500
1.5	B, C, D	500
1.6	B, C, D	500
1.7	B, C, D	500
1.8	B, C, D	500
1.9	B, C, D	500
2.0	B, C, D	500
2.2	B, C, D	500
2.4	B, C, D	500
2.7	B, C, D	500
3.0	B, C, D	500
3.3	B, C, D	500
3.6	B, C, D	500
3.9	B, C, D	500
4.3	B, C, D	500
4.7	B, C, D	500
5.1	B, C, D	500
5.6	B, C, D	500
6.2	B, C, D	500
6.8	B, C, J, K, M	500
7.5	B, C, J, K, M	500
8.2	B, C, J, K, M	500
9.1	B, C, J, K, M	500
10	F, G, J, K, M	500
11	F, G, J, K, M	500
12	F, G, J, K, M	500
13	F, G, J, K, M	500
15	F, G, J, K, M	500
16	F, G, J, K, M	500
18	F, G, J, K, M	500
20	F, G, J, K, M	500
22	F, G, J, K, M	500
24	F, G, J, K, M	500
27	F, G, J, K, M	500
30	F, G, J, K, M	500
33	F, G, J, K, M	500
36	F, G, J, K, M	500
39	F, G, J, K, M	500
43	F, G, J, K, M	500
47	F, G, J, K, M	500
51	F, G, J, K, M	500
56	F, G, J, K, M	500
62	F, G, J, K, M	500
68	F, G, J, K, M	500
75	F, G, J, K, M	500
82	F, G, J, K, M	500
91	F, G, J, K, M	500

Cap. pF	Cap. Tol.	WVDC
100	F, G, J, K, M	500
110	F, G, J, K, M	300
120	F, G, J, K, M	300
130	F, G, J, K, M	300
150	F, G, J, K, M	300
160	F, G, J, K, M	300
180	F, G, J, K, M	300
200	F, G, J, K, M	300
220	F, G, J, K, M	200
240	F, G, J, K, M	200
270	F, G, J, K, M	200
300	F, G, J, K, M	200
330	F, G, J, K, M	200
360	F, G, J, K, M	200
390	F, G, J, K, M	200
430	F, G, J, K, M	200
470	F, G, J, K, M	200
510	F, G, J, K, M	150
560	F, G, J, K, M	150
620	F, G, J, K, M	150
680	F, G, J, K, M	150
750	F, G, J, K, M	150
820	F, G, J, K, M	150
910	F, G, J, K, M	150
1000	F, G, J, K, M	150



Microwave MLC's



AQ Series Available Capacitance/Size/WVDC/T.C.

**TABLE II: TC: A (0±30PPM/°C)
CASE SIZE 11, 12, 13 & 14**

DIMENSIONS: inches (millimeters)

Case	Length	Width	Thickness	Band Width	Avail. Term.
11	.055±.015 (1.40±.381)	.055±.015 (1.40±.381)	.020/.057 (.508/1.45)	.010 +.010 -.005 (.254 +.254 -.127)	1 & 7
12	.055±.025 (1.40±.635)	.055±.015 (1.40±.381)	.020/.057 (.508/1.45)	.010 +.010 -.005 (.254 +.254 -.127)	J
13	.110±.020 (2.79±.508)	.110±.020 (2.79±.508)	.030/.102 (.762/2.59)	.015±.010 (.381±.254)	1 & 7
14	.110 +0.035 -0.020 (2.79 +.889 -.508)	.110±.020 (2.79±.508)	.030/.102 (.762/2.59)	.015±.010 (.381±.254)	J

Case: AQ11, AQ12					
Cap. pF	Cap. Tol.	WVDC	Cap. pF	Cap. Tol.	WVDC
0.1	B	150	24	F, G, J, K, M	150
0.2	B	150	27	F, G, J, K, M	150
0.3	B,C	150	30	F, G, J, K, M	150
0.4	B,C	150	33	F, G, J, K, M	150
0.5	B, C, D	150	36	F, G, J, K, M	150
0.6	B, C, D	150	39	F, G, J, K, M	150
0.7	B, C, D	150	43	F, G, J, K, M	150
0.8	B, C, D	150	47	F, G, J, K, M	150
0.9	B, C, D	150	51	F, G, J, K, M	150
1.0	B, C, D	150	56	F, G, J, K, M	150
1.1	B, C, D	150	62	F, G, J, K, M	150
1.2	B, C, D	150	68	F, G, J, K, M	150
1.3	B, C, D	150	75	F, G, J, K, M	150
1.4	B, C, D	150	82	F, G, J, K, M	150
1.5	B, C, D	150	91	F, G, J, K, M	150
1.6	B, C, D	150	100	F, G, J, K, M	150
1.7	B, C, D	150	110	F, G, J, K, M	50
1.8	B, C, D	150	120	F, G, J, K, M	50
1.9	B, C, D	150	130	F, G, J, K, M	50
2.0	B, C, D	150	150	F, G, J, K, M	50
2.2	B, C, D	150	160	F, G, J, K, M	50
2.4	B, C, D	150	180	F, G, J, K, M	50
2.7	B, C, D	150	200	F, G, J, K, M	50
3.0	B, C, D	150	220	F, G, J, K, M	50
3.3	B, C, D	150	240	F, G, J, K, M	50
3.6	B, C, D	150	270	F, G, J, K, M	50
3.9	B, C, D	150	300	F, G, J, K, M	50
4.3	B, C, D	150	330	F, G, J, K, M	50
4.7	B, C, D	150	360	F, G, J, K, M	50
5.1	B, C, D	150	390	F, G, J, K, M	50
5.6	B, C, D	150	430	F, G, J, K, M	50
6.2	B, C, D	150	470	F, G, J, K, M	50
6.8	B, C, J, K, M	150	510	F, G, J, K, M	50
7.5	B, C, J, K, M	150	560	F, G, J, K, M	50
8.2	B, C, J, K, M	150	620	F, G, J, K, M	50
9.1	B, C, J, K, M	150	680	F, G, J, K, M	50
10	F, G, J, K, M	150	750	F, G, J, K, M	50
11	F, G, J, K, M	150	820	F, G, J, K, M	50
12	F, G, J, K, M	150	910	F, G, J, K, M	50
13	F, G, J, K, M	150	1000	F, G, J, K, M	50
15	F, G, J, K, M	150			
16	F, G, J, K, M	150			
18	F, G, J, K, M	150			
20	F, G, J, K, M	150			
22	F, G, J, K, M	150			

Case: AQ13, AQ14					
Cap. pF	Cap. Tol.	WVDC	Cap. pF	Cap. Tol.	WVDC
0.1	B	500	51	F, G, J, K, M	500
0.2	B	500	56	F, G, J, K, M	500
0.3	B,C	500	62	F, G, J, K, M	500
0.4	B,C	500	68	F, G, J, K, M	500
0.5	B, C, D	500	75	F, G, J, K, M	500
0.6	B, C, D	500	82	F, G, J, K, M	500
0.7	B, C, D	500	91	F, G, J, K, M	500
0.8	B, C, D	500	100	F, G, J, K, M	500
0.9	B, C, D	500	110	F, G, J, K, M	300
1.0	B, C, D	500	120	F, G, J, K, M	300
1.1	B, C, D	500	130	F, G, J, K, M	300
1.2	B, C, D	500	150	F, G, J, K, M	300
1.3	B, C, D	500	160	F, G, J, K, M	300
1.4	B, C, D	500	180	F, G, J, K, M	300
1.5	B, C, D	500	200	F, G, J, K, M	300
1.6	B, C, D	500	220	F, G, J, K, M	200
1.7	B, C, D	500	240	F, G, J, K, M	200
1.8	B, C, D	500	270	F, G, J, K, M	200
1.9	B, C, D	500	300	F, G, J, K, M	200
2.0	B, C, D	500	330	F, G, J, K, M	200
2.2	B, C, D	500	360	F, G, J, K, M	200
2.4	B, C, D	500	390	F, G, J, K, M	200
2.7	B, C, D	500	430	F, G, J, K, M	200
3.0	B, C, D	500	470	F, G, J, K, M	200
3.3	B, C, D	500	510	F, G, J, K, M	150
3.6	B, C, D	500	560	F, G, J, K, M	150
3.9	B, C, D	500	620	F, G, J, K, M	150
4.3	B, C, D	500	680	F, G, J, K, M	150
4.7	B, C, D	500	750	F, G, J, K, M	150
5.1	B, C, D	500	820	F, G, J, K, M	150
5.6	B, C, D	500	910	F, G, J, K, M	150
6.2	B, C, D	500	1000	F, G, J, K, M	150
6.8	B, C, J, K, M	500	1100	F, G, J, K, M	50
7.5	B, C, J, K, M	500	1200	F, G, J, K, M	50
8.2	B, C, J, K, M	500	1300	F, G, J, K, M	50
9.1	B, C, J, K, M	500	1500	F, G, J, K, M	50
10	F, G, J, K, M	500	1600	F, G, J, K, M	50
11	F, G, J, K, M	500	1800	F, G, J, K, M	50
12	F, G, J, K, M	500	2000	F, G, J, K, M	50
13	F, G, J, K, M	500	2200	F, G, J, K, M	50
15	F, G, J, K, M	500	2400	F, G, J, K, M	50
16	F, G, J, K, M	500	2700	F, G, J, K, M	50
18	F, G, J, K, M	500	3000	F, G, J, K, M	50
20	F, G, J, K, M	500	3300	F, G, J, K, M	50
22	F, G, J, K, M	500	3600	F, G, J, K, M	50
24	F, G, J, K, M	500	3900	F, G, J, K, M	50
27	F, G, J, K, M	500	4300	F, G, J, K, M	50
30	F, G, J, K, M	500	4700	F, G, J, K, M	50
33	F, G, J, K, M	500	5000	F, G, J, K, M	50
36	F, G, J, K, M	500	5100	F, G, J, K, M	50
39	F, G, J, K, M	500			
43	F, G, J, K, M	500			
47	F, G, J, K, M	500			

TABLE III: TC: C (±15%) CASE SIZE 12 & 14

Case: AQ12									Case: AQ14								
Cap. pF	Cap. Tol.	WVDC	Cap. pF	Cap. Tol.	WVDC	Cap. pF	Cap. Tol.	WVDC	Cap. pF	Cap. Tol.	WVDC	Cap. pF	Cap. Tol.	WVDC	Cap. pF	Cap. Tol.	WVDC
1000	K, M, N	50	2200	K, M, N	50	5100	K, M, N	50	5000	K, M, N	50	15000	K, M, N	50	47000	K, M, N	50
1200	K, M, N	50	2700	K, M, N	50	5600	K, M, N	50	6800	K, M, N	50	18000	K, M, N	50	68000	K, M, N	50
1500	K, M, N	50	3300	K, M, N	50	6800	K, M, N	50	8200	K, M, N	50	27000	K, M, N	50	82000	K, M, N	50
1800	K, M, N	50	3900	K, M, N	50	8200	K, M, N	50	10000	K, M, N	50	33000	K, M, N	50	100000	K, M, N	50
2000	K, M, N	50	4700	K, M, N	50	10000	K, M, N	50	12000	K, M, N	50	39000	K, M, N	50			



Microwave MLC's



CDR Series — MIL-PRF-55681 (RF/Microwave Chips)

MILITARY DESIGNATION PER MIL-PRF-55681

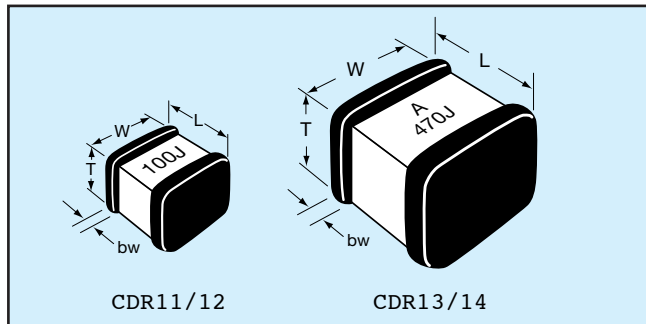

CROSS REFERENCE: AVX/MIL-PRF-55681

Per MIL-C-55681	AVX Style	Length (L)	Width (W)	Thickness (T)		Termination Band (bw)	
				Max	Min	Max	Min
CDR11	AQ11	.055±.015 (1.40±.381)	.055±.015 (1.40±.381)	.057 (1.45)	.020 (.508)	.020 (.508)	.005 (.127)
CDR12	AQ12	.055±.025 (1.40±.635)	.055±.015 (1.40±.381)	.057 (1.45)	.020 (.508)	.020 (.508)	.005 (.127)
CDR13	AQ13	.110±.020 (2.79±.508)	.110±.020 (2.79±.508)	.102 (2.59)	.030 (.762)	.025 (.635)	.005 (.127)
CDR14	AQ14	.110 +.035 -0.020 (2.79 +.889 -.508)	.110±.020 (2.79±.508)	.102 (2.59)	.030 (.762)	.025 (.635)	.005 (.127)

HOW TO ORDER

CDR12

MIL Style
CDR11, CDR12,
CDR13, CDR14

BG

Voltage Temperature Limits

BG = +90±20 ppm/°C with and without rated voltage from -55°C to +125°C
BP = 0±30ppm/°C with and without rated voltage from -55°C to +125°C

101

Capacitance

EIA Capacitance Code in pF.
First two digits = significant figures or "R" for decimal place.
Third digit = number of zeros or after "R" significant figures.

A

Rated Voltage Code

A = 50V
B = 100V
C = 200V
D = 300V
E = 500V

K

Capacitance Tolerance Code

B = ±.1 pF
C = ±.25 pF
D = ±.5 pF
F = ±1%
G = ±2%
J = ±5%
K = ±10%
M = ±20%

U

Termination Finish (Military Designations) Code

M = Palladium silver
N = Silver-nickel-gold
S = Solder coated final with a minimum of 4 percent lead
T = Silver
U = Base metallization-barrier metal-solder coated (tin/lead alloy, with a minimum of 4 percent lead)
W = Base metallization-barrier metal-tinned (tin or tin/lead alloy)
Y = Base metallization-barrier metal-tin (100 percent)
Z = Base metallization-barrier metal-tinned (tin/lead alloy, with a minimum of 4 percent lead)
*See MIL-PRF-55681 Specification for more details

S

Failure Rate Level

M = 1.0%
P = .1%
R = .01%
S = .001%

PACKAGING

Standard Packaging Quantity

CDR11-12 = 100 pcs per waffle pack

CDR13-14 = 80 pcs per waffle pack

TAPE & REEL: All tape and reel specifications are in compliance with EIA RS481 (equivalent to IEC 286 part 3).

Sizes SQCA through SQCB, CDR11/12 through 13/14.

—8mm carrier

—7" reel: ≤0.040" thickness = 2000 pcs
≤0.075" thickness = 2000 pcs

—13" reel: ≤0.075" thickness = 10,000 pcs

Not RoHS Compliant



For RoHS compliant products, please select correct termination style.



Microwave MLC's



CDR Series — MIL-PRF-55681 (RF/Microwave Chips)

TABLE I: STYLES CDR11 AND CDR12 CAPACITOR CHARACTERISTICS

Type Designation 1/	Capacitance in pF	Capacitance tolerance	Rated temperature and V/Temperature	WVDC	Type Designation 1/	Capacitance in pF	Capacitance tolerance	Rated temperature and V/Temperature	WVDC
CDR1 -B-0R1AB--	0.1	B	BG, BP	50	CDR1 -B-300A--	30	F, G, J, K, M	BG, BP	50
CDR1 -B-0R2AB--	0.2	B	BG, BP	50	CDR1 -B-330A--	33	F, G, J, K, M	BG, BP	50
CDR1 -B-0R3A---	0.3	B, C	BG, BP	50	CDR1 -B-360A--	36	F, G, J, K, M	BG, BP	50
CDR1 -B-0R4A---	0.4	B, C	BG, BP	50	CDR1 -B-390A--	39	F, G, J, K, M	BG, BP	50
CDR1 -B-0R5A---	0.5	B, C, D	BG, BP	50	CDR1 -B-430A--	43	F, G, J, K, M	BG, BP	50
CDR1 -B-0R6A---	0.6	B, C, D	BG, BP	50	CDR1 -B-470A--	47	F, G, J, K, M	BG, BP	50
CDR1 -B-0R7A---	0.7	B, C, D	BG, BP	50	CDR1 -B-510A--	51	F, G, J, K, M	BG, BP	50
CDR1 -B-0R8A---	0.8	B, C, D	BG, BP	50	CDR1 -B-560A--	56	F, G, J, K, M	BG, BP	50
CDR1 -B-0R9A---	0.9	B, C, D	BG, BP	50	CDR1 -B-620A--	62	F, G, J, K, M	BG, BP	50
CDR1 -B-1R0A---	1.0	B, C, D	BG, BP	50	CDR1 -B-680A--	68	F, G, J, K, M	BG, BP	50
CDR1 -B-1R1A---	1.1	B, C, D	BG, BP	50	CDR1 -B-750A--	75	F, G, J, K, M	BG, BP	50
CDR1 -B-1R2A---	1.2	B, C, D	BG, BP	50	CDR1 -B-820A--	82	F, G, J, K, M	BG, BP	50
CDR1 -B-1R3A---	1.3	B, C, D	BG, BP	50	CDR1 -B-910A--	91	F, G, J, K, M	BG, BP	50
CDR1 -B-1R4A---	1.4	B, C, D	BG, BP	50	CDR1 -B-101A--	100	F, G, J, K, M	BG, BP	50
CDR1 -B-1R5A---	1.5	B, C, D	BG, BP	50	CDR1 -B-111A--	110	F, G, J, K, M	BP	50
CDR1 -B-1R6A---	1.6	B, C, D	BG, BP	50	CDR1 -B-121A--	120	F, G, J, K, M	BP	50
CDR1 -B-1R7A---	1.7	B, C, D	BG, BP	50	CDR1 -B-131A--	130	F, G, J, K, M	BP	50
CDR1 -B-1R8A---	1.8	B, C, D	BG, BP	50	CDR1 -B-151A--	150	F, G, J, K, M	BP	50
CDR1 -B-1R9A---	1.9	B, C, D	BG, BP	50	CDR1 -B-161A--	160	F, G, J, K, M	BP	50
CDR1 -B-2R0A---	2.0	B, C, D	BG, BP	50	CDR1 -B-181A--	180	F, G, J, K, M	BP	50
CDR1 -B-2R1A---	2.1	B, C, D	BG, BP	50	CDR1 -B-201A--	200	F, G, J, K, M	BP	50
CDR1 -B-2R2A---	2.2	B, C, D	BG, BP	50	CDR1 -B-221A--	220	F, G, J, K, M	BP	50
CDR1 -B-2R4A---	2.4	B, C, D	BG, BP	50	CDR1 -B-241A--	240	F, G, J, K, M	BP	50
CDR1 -B-2R7A---	2.7	B, C, D	BG, BP	50	CDR1 -B-271A--	270	F, G, J, K, M	BP	50
CDR1 -B-3R0A---	3.0	B, C, D	BG, BP	50	CDR1 -B-301A--	300	F, G, J, K, M	BP	50
CDR1 -B-3R3A---	3.3	B, C, D	BG, BP	50	CDR1 -B-331A--	330	F, G, J, K, M	BP	50
CDR1 -B-3R6A---	3.6	B, C, D	BG, BP	50	CDR1 -B-361A--	360	F, G, J, K, M	BP	50
CDR1 -B-3R9A---	3.9	B, C, D	BG, BP	50	CDR1 -B-391A--	390	F, G, J, K, M	BP	50
CDR1 -B-4R3A---	4.3	B, C, D	BG, BP	50	CDR1 -B-431A--	430	F, G, J, K, M	BP	50
CDR1 -B-4R7A---	4.7	B, C, D	BG, BP	50	CDR1 -B-471A--	470	F, G, J, K, M	BP	50
CDR1 -B-5R1A---	5.1	B, C, D	BG, BP	50	CDR1 -B-511A--	510	F, G, J, K, M	BP	50
CDR1 -B-5R6A---	5.6	B, C, D	BG, BP	50	CDR1 -B-561A--	560	F, G, J, K, M	BP	50
CDR1 -B-6R2A---	6.2	B, C, D	BG, BP	50	CDR1 -B-621A--	620	F, G, J, K, M	BP	50
CDR1 -B-6R8A---	6.8	B, C, J, K, M	BG, BP	50	CDR1 -B-681A--	680	F, G, J, K, M	BP	50
CDR1 -B-7R5A---	7.5	B, C, J, K, M	BG, BP	50	CDR1 -B-751A--	750	F, G, J, K, M	BP	50
CDR1 -B-8R2A---	8.2	B, C, J, K, M	BG, BP	50	CDR1 -B-821A--	820	F, G, J, K, M	BP	50
CDR1 -B-9R1A---	9.1	B, C, J, K, M	BG, BP	50	CDR1 -B-911A--	910	F, G, J, K, M	BP	50
CDR1 -B-100A--	10	F, G, J, K, M	BG, BP	50	CDR1 -B-102A--	1000	F, G, J, K, M	BP	50
CDR1 -B-110A--	11	F, G, J, K, M	BG, BP	50					
CDR1 -B-120A--	12	F, G, J, K, M	BG, BP	50					
CDR1 -B-130A--	13	F, G, J, K, M	BG, BP	50					
CDR1 -B-150A--	15	F, G, J, K, M	BG, BP	50					
CDR1 -B-160A--	16	F, G, J, K, M	BG, BP	50					
CDR1 -B-180A--	18	F, G, J, K, M	BG, BP	50					
CDR1 -B-200A--	20	F, G, J, K, M	BG, BP	50					
CDR1 -B-220A--	22	F, G, J, K, M	BG, BP	50					
CDR1 -B-240A--	24	F, G, J, K, M	BG, BP	50					
CDR1 -B-270A--	27	F, G, J, K, M	BG, BP	50					

1/Complete type designation will include additional symbols to indicate style, voltage-temperature limits, capacitance tolerance (where applicable), termination finish ("M" or "N" for style CDR11, and "S", "U", "W", "Y" or "Z" for style CDR12) and failure rate level.

Microwave MLC's



CDR Series — MIL-PRF-55681 (RF/Microwave Chips)

TABLE II: STYLES CDR13 AND CDR14 CAPACITOR CHARACTERISTICS

Type Designation 1/	Capacitance in pF	Capacitance tolerance	Rated temperature and V/Temperature	WVDC	Type Designation 1/	Capacitance in pF	Capacitance tolerance	Rated temperature and V/Temperature	WVDC
CDR1 -B-0R1*B--	0.1	B	BG, BP	200/500	CDR1 -B-560*--	56	F, G, J, K, M	BG, BP	200/500
CDR1 -B-0R2*B--	0.2	B	BG, BP	200/500	CDR1 -B-620*--	62	F, G, J, K, M	BG, BP	200/500
CDR1 -B-0R3*--	0.3	B, C	BG, BP	200/500	CDR1 -B-680*--	68	F, G, J, K, M	BG, BP	200/500
CDR1 -B-0R4*--	0.4	B, C	BG, BP	200/500	CDR1 -B-750*--	75	F, G, J, K, M	BG, BP	200/500
CDR1 -B-0R5*--	0.5	B, C, D	BG, BP	200/500	CDR1 -B-820*--	82	F, G, J, K, M	BG, BP	200/500
CDR1 -B-0R6*--	0.6	B, C, D	BG, BP	200/500	CDR1 -B-910*--	91	F, G, J, K, M	BG, BP	200/500
CDR1 -B-0R7*--	0.7	B, C, D	BG, BP	200/500	CDR1 -B-101*--	100	F, G, J, K, M	BG, BP	200/500
CDR1 -B-0R8*--	0.8	B, C, D	BG, BP	200/500	CDR1 -B-111‡--	110	F, G, J, K, M	BG, BP	200/300
CDR1 -B-0R9*--	0.9	B, C, D	BG, BP	200/500	CDR1 -B-121‡--	120	F, G, J, K, M	BG, BP	200/300
CDR1 -B-1R0*--	1.0	B, C, D	BG, BP	200/500	CDR1 -B-131‡--	130	F, G, J, K, M	BG, BP	200/300
CDR1 -B-1R1*--	1.1	B, C, D	BG, BP	200/500	CDR1 -B-151‡--	150	F, G, J, K, M	BG, BP	200/300
CDR1 -B-1R2*--	1.2	B, C, D	BG, BP	200/500	CDR1 -B-161‡--	160	F, G, J, K, M	BG, BP	200/300
CDR1 -B-1R3*--	1.3	B, C, D	BG, BP	200/500	CDR1 -B-181‡--	180	F, G, J, K, M	BG, BP	200/300
CDR1 -B-1R4*--	1.4	B, C, D	BG, BP	200/500	CDR1 -B-201‡--	200	F, G, J, K, M	BG, BP	200/300
CDR1 -B-1R5*--	1.5	B, C, D	BG, BP	200/500	CDR1 -B-221C--	220	F, G, J, K, M	BG, BP	200
CDR1 -B-1R6*--	1.6	B, C, D	BG, BP	200/500	CDR1 -B-241C--	240	F, G, J, K, M	BG, BP	200
CDR1 -B-1R7*--	1.7	B, C, D	BG, BP	200/500	CDR1 -B-271C--	270	F, G, J, K, M	BG, BP	200
CDR1 -B-1R8*--	1.8	B, C, D	BG, BP	200/500	CDR1 -B-301C--	300	F, G, J, K, M	BG, BP	200
CDR1 -B-1R9*--	1.9	B, C, D	BG, BP	200/500	CDR1 -B-331C--	330	F, G, J, K, M	BG, BP	200
CDR1 -B-2R0*--	2.0	B, C, D	BG, BP	200/500	CDR1 -B-361C--	360	F, G, J, K, M	BG, BP	200
CDR1 -B-2R1*--	2.1	B, C, D	BG, BP	200/500	CDR1 -B-391C--	390	F, G, J, K, M	BG, BP	200
CDR1 -B-2R2*--	2.2	B, C, D	BG, BP	200/500	CDR1 -B-431C--	430	F, G, J, K, M	BG, BP	200
CDR1 -B-2R4*--	2.4	B, C, D	BG, BP	200/500	CDR1 -B-471C--	470	F, G, J, K, M	BG, BP	200
CDR1 -B-2R7*--	2.7	B, C, D	BG, BP	200/500	CDR1 -B-511B--	510	F, G, J, K, M	BG, BP	100
CDR1 -B-3R0*--	3.0	B, C, D	BG, BP	200/500	CDR1 -B-561B--	560	F, G, J, K, M	BG, BP	100
CDR1 -B-3R3*--	3.3	B, C, D	BG, BP	200/500	CDR1 -B-621B--	620	F, G, J, K, M	BG, BP	100
CDR1 -B-3R6*--	3.6	B, C, D	BG, BP	200/500	CDR1 -B-681A--	680	F, G, J, K, M	BG, BP	50
CDR1 -B-3R9*--	3.9	B, C, D	BG, BP	200/500	CDR1 -B-751A--	750	F, G, J, K, M	BG, BP	50
CDR1 -B-4R3*--	4.3	B, C, D	BG, BP	200/500	CDR1 -B-821A--	820	F, G, J, K, M	BG, BP	50
CDR1 -B-4R7*--	4.7	B, C, D	BG, BP	200/500	CDR1 -B-911A--	910	F, G, J, K, M	BG, BP	50
CDR1 -B-5R1*--	5.1	B, C, D	BG, BP	200/500	CDR1 -B-102A--	1000	F, G, J, K, M	BG, BP	50
CDR1 -B-5R6*--	5.6	B, C, D	BG, BP	200/500	CDR1 -B-112A--	1100	F, G, J, K, M	BP	50
CDR1 -B-6R2*--	6.2	B, C, D	BG, BP	200/500	CDR1 -B-122A--	1200	F, G, J, K, M	BP	50
CDR1 -B-6R8*--	6.8	B, C, J, K, M	BG, BP	200/500	CDR1 -B-132A--	1300	F, G, J, K, M	BP	50
CDR1 -B-7R5*--	7.5	B, C, J, K, M	BG, BP	200/500	CDR1 -B-152A--	1500	F, G, J, K, M	BP	50
CDR1 -B-8R2*--	8.2	B, C, J, K, M	BG, BP	200/500	CDR1 -B-162A--	1600	F, G, J, K, M	BP	50
CDR1 -B-9R1*--	9.1	B, C, J, K, M	BG, BP	200/500	CDR1 -B-182A--	1800	F, G, J, K, M	BP	50
CDR1 -B-100*--	10	F, G, J, K, M	BG, BP	200/500	CDR1 -B-202A--	2000	F, G, J, K, M	BP	50
CDR1 -B-110*--	11	F, G, J, K, M	BG, BP	200/500	CDR1 -B-222A--	2200	F, G, J, K, M	BP	50
CDR1 -B-120*--	12	F, G, J, K, M	BG, BP	200/500	CDR1 -B-242A--	2400	F, G, J, K, M	BP	50
CDR1 -B-130*--	13	F, G, J, K, M	BG, BP	200/500	CDR1 -B-272A--	2700	F, G, J, K, M	BP	50
CDR1 -B-150*--	15	F, G, J, K, M	BG, BP	200/500	CDR1 -B-302A--	3000	F, G, J, K, M	BP	50
CDR1 -B-160*--	16	F, G, J, K, M	BG, BP	200/500	CDR1 -B-332A--	3300	F, G, J, K, M	BP	50
CDR1 -B-180*--	18	F, G, J, K, M	BG, BP	200/500	CDR1 -B-362A--	3600	F, G, J, K, M	BP	50
CDR1 -B-200*--	20	F, G, J, K, M	BG, BP	200/500	CDR1 -B-392A--	3900	F, G, J, K, M	BP	50
CDR1 -B-220*--	22	F, G, J, K, M	BG, BP	200/500	CDR1 -B-432A--	4300	F, G, J, K, M	BP	50
CDR1 -B-240*--	24	F, G, J, K, M	BG, BP	200/500	CDR1 -B-472A--	4700	F, G, J, K, M	BP	50
CDR1 -B-270*--	27	F, G, J, K, M	BG, BP	200/500	CDR1 -B-502A--	5000	F, G, J, K, M	BP	50
CDR1 -B-300*--	30	F, G, J, K, M	BG, BP	200/500	CDR1 -B-512A--	5100	F, G, J, K, M	BP	50
CDR1 -B-330*--	33	F, G, J, K, M	BG, BP	200/500					
CDR1 -B-360*--	36	F, G, J, K, M	BG, BP	200/500					
CDR1 -B-390*--	39	F, G, J, K, M	BG, BP	200/500					
CDR1 -B-430*--	43	F, G, J, K, M	BG, BP	200/500					
CDR1 -B-470*--	47	F, G, J, K, M	BG, BP	200/500					
CDR1 -B-510*--	51	F, G, J, K, M	BG, BP	200/500					

1/Complete type designation will include additional symbols to indicate style, voltage-temperature limits, capacitance tolerance (where applicable), termination finish ("M" or "N" for style CDR13, and "S", "U", "W", "Y" or "Z" for style CDR14) and failure rate level.

*C=200V; E=500V.

‡C=200V; D=300V.



TYPICAL Q vs. FREQUENCY
AQ11/12
MIL-PRF-55681E - BG
STANDARD - M

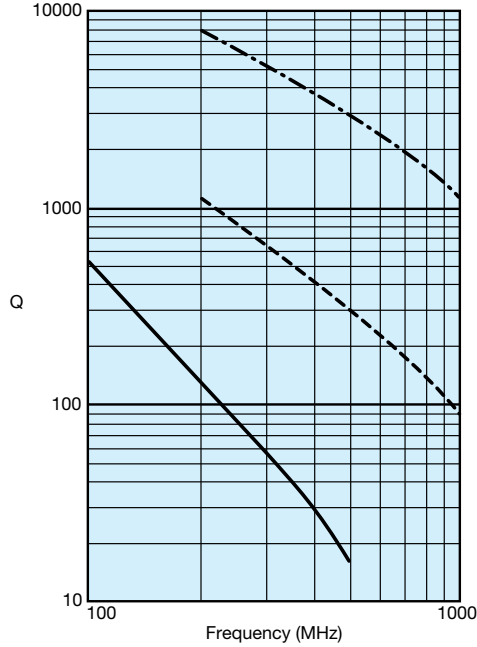

TYPICAL ESR vs. FREQUENCY
AQ11/12
MIL-PRF-55681E - BG
STANDARD - M

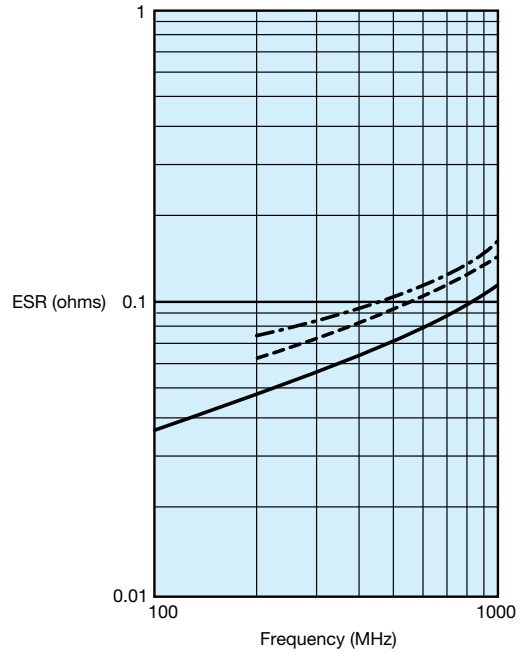

TYPICAL Q vs. CAPACITANCE
AQ11/12
MIL-PRF-55681E - BG
STANDARD - M

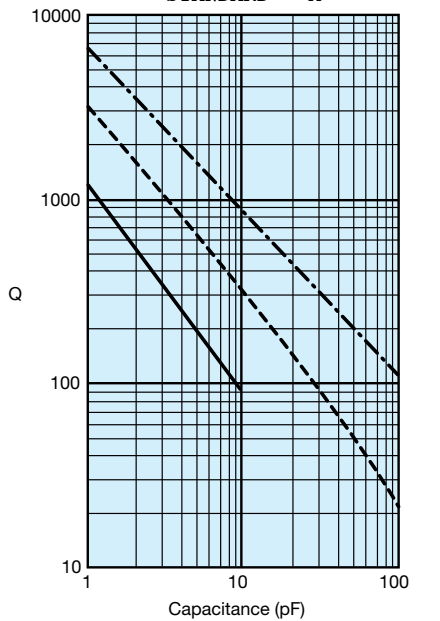

TYPICAL ESR vs. CAPACITANCE
AQ11/12
MIL-PRF-55681E - BG
STANDARD - M

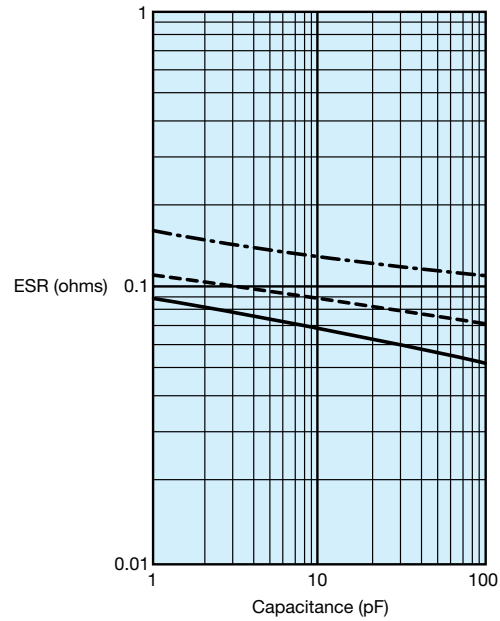

Performance Curves

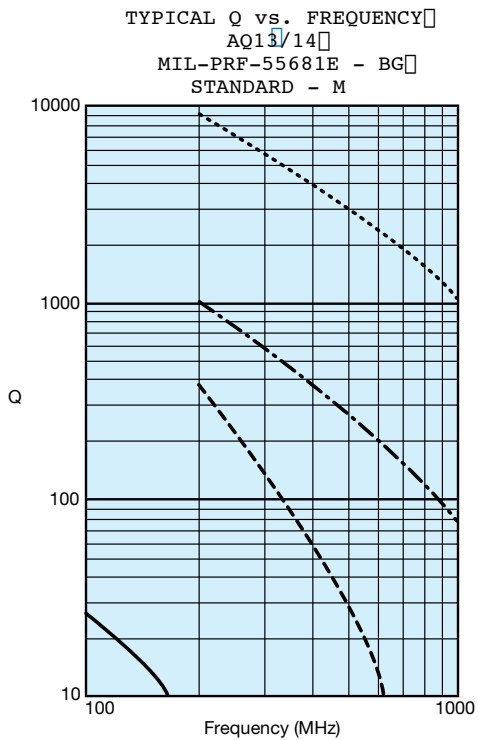

AVX CORPORATION
 1 Picofarad - - - 10 Picofarad - - - 47 Picofarad — 330 Picofarad

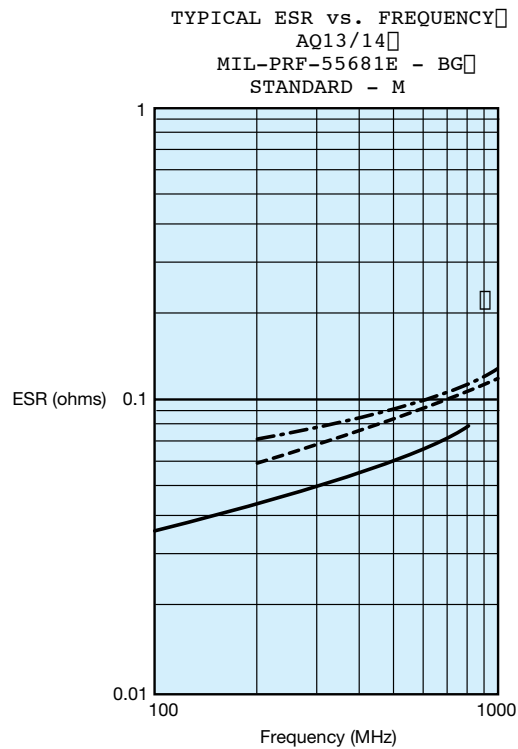

AVX CORPORATION
 1 Picofarad - - - 15 Picofarad — 100 Picofarad

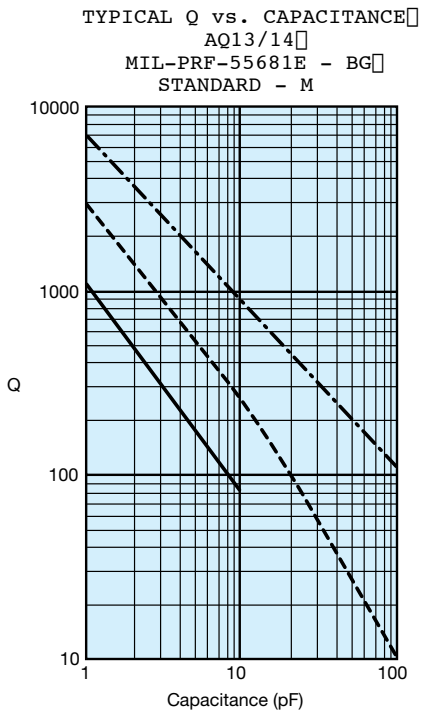

AVX CORPORATION
 250 MHz - - - 500 MHz — 1000 MHz

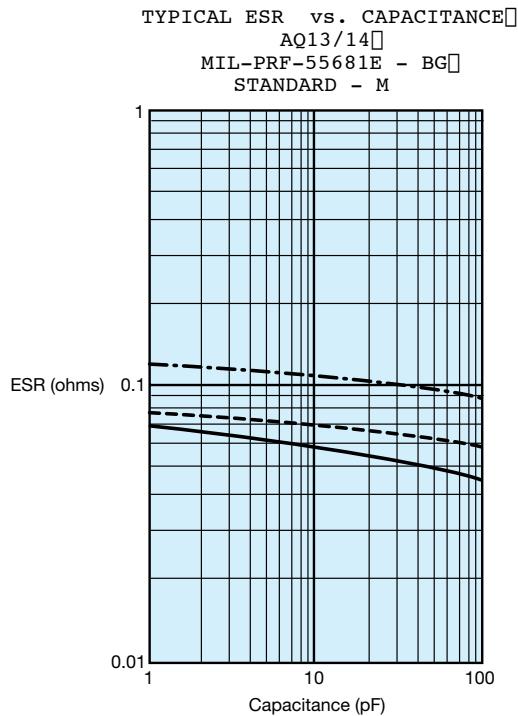

AVX CORPORATION
 250 MHz - - - 500 MHz - - - 1000 MHz

TYPICAL Q vs. FREQUENCY
AQ11/12
MIL-PRF-55681E - BP
STANDARD - A

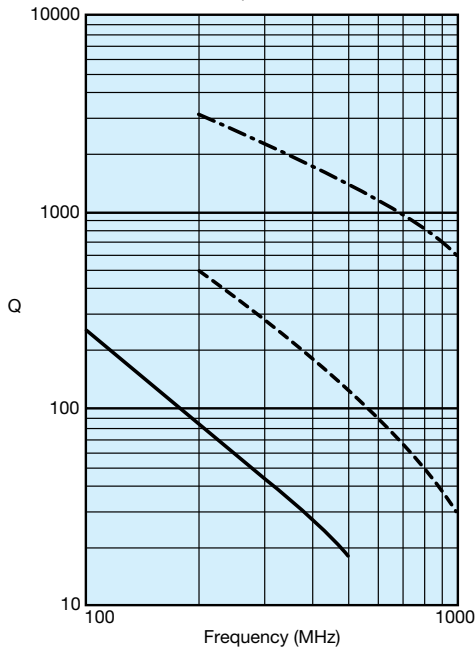

AVX CORPORATION
--- 1 Picofarad --- 15 Picofarad — 100 Picofarad

TYPICAL ESR vs. FREQUENCY
AQ11/12
MIL-PRF-55681E - BP
STANDARD - A

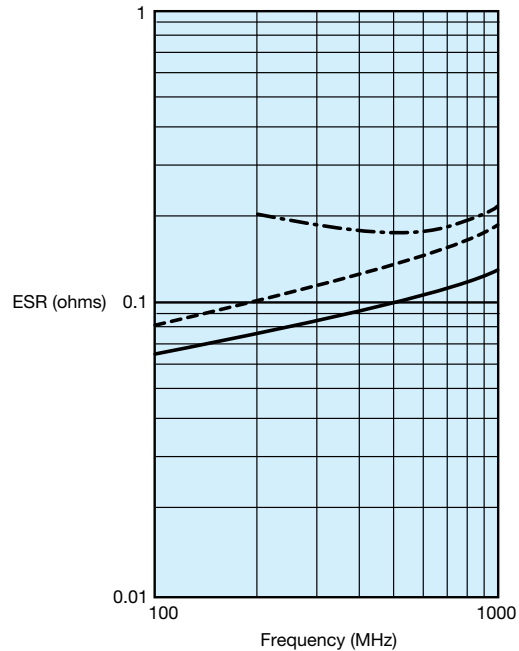

AVX CORPORATION
--- 1 Picofarad --- 15 Picofarad — 100 Picofarad

TYPICAL Q vs. CAPACITANCE
AQ11/12
MIL-PRF-55681E - BP
STANDARD - A

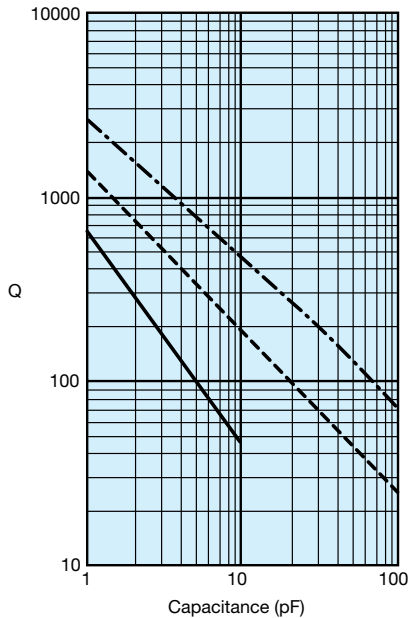

AVX CORPORATION
--- 250 MHz --- 500 MHz — 1000 MHz

TYPICAL ESR vs. CAPACITANCE
AQ11/12
MIL-PRF-55681E - BP
STANDARD - A

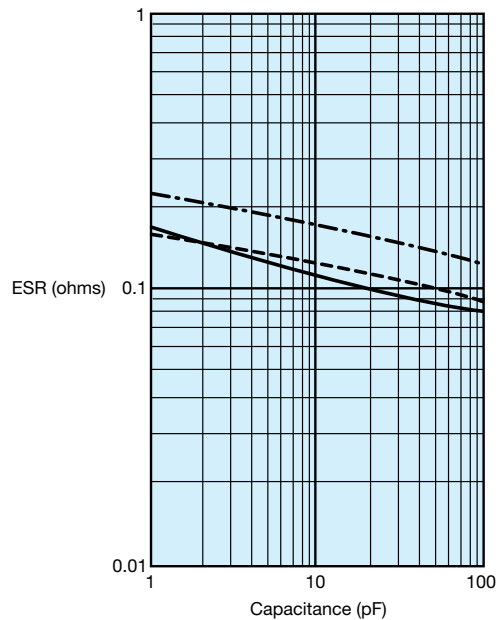

AVX CORPORATION
--- 250 MHz --- 500 MHz --- 1000 MHz

TYPICAL Q vs. FREQUENCY
AQ13/14
MIL-PRF-55681E - BP
STANDARD - A

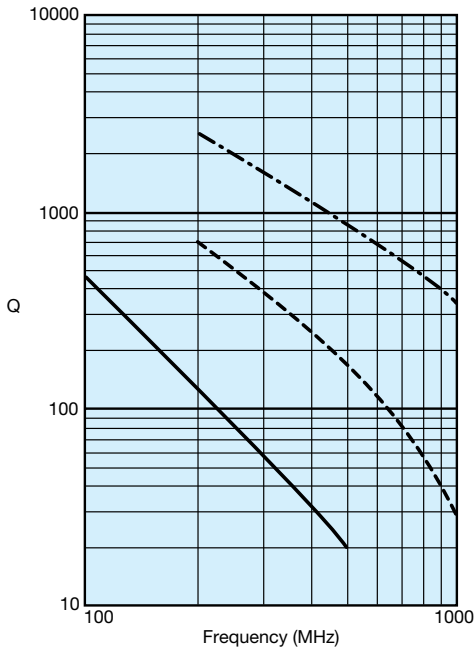

AVX CORPORATION
--- 2 Picofarad - - - 15 Picofarad — 100 Picofarad

TYPICAL ESR vs. FREQUENCY
AQ13/14
MIL-PRF-55681E - BP
STANDARD - A

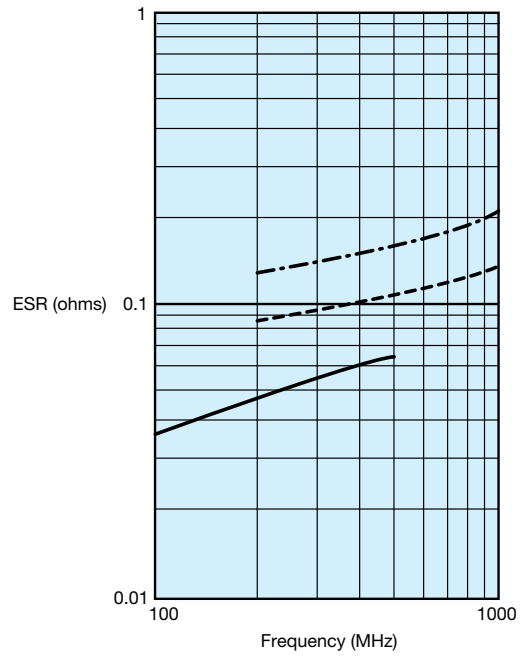

AVX CORPORATION
--- 15 Picofarad - - - 47 Picofarad — 100 Picofarad

TYPICAL Q vs. CAPACITANCE
AQ13/14
MIL-PRF-55681E - BP
STANDARD - A

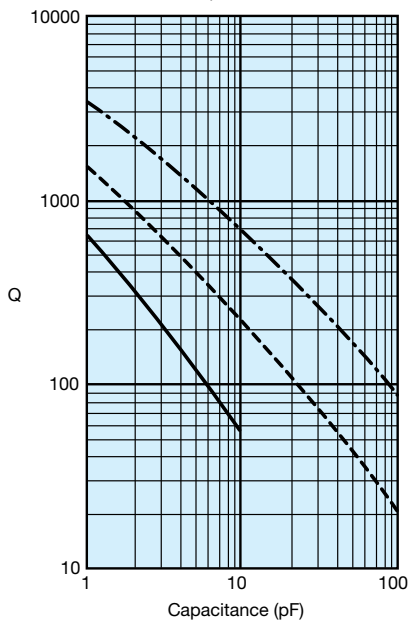

AVX CORPORATION
--- 250 MHz - - - 500 MHz — 1000 MHz

TYPICAL ESR vs. CAPACITANCE
AQ13/14
MIL-PRF-55681E - BP
STANDARD - A

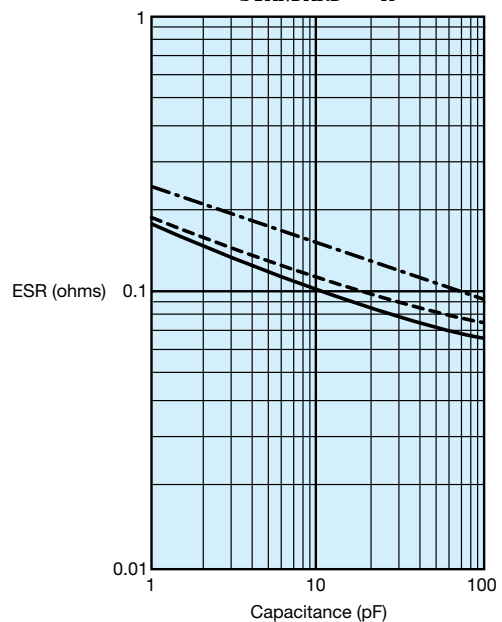

AVX CORPORATION
--- 250 MHz - - - 500 MHz — 1000 MHz

TYPICAL RESONANT FREQUENCY vs. CAPACITANCE
AVX AQ11-14 (CDR11-14)

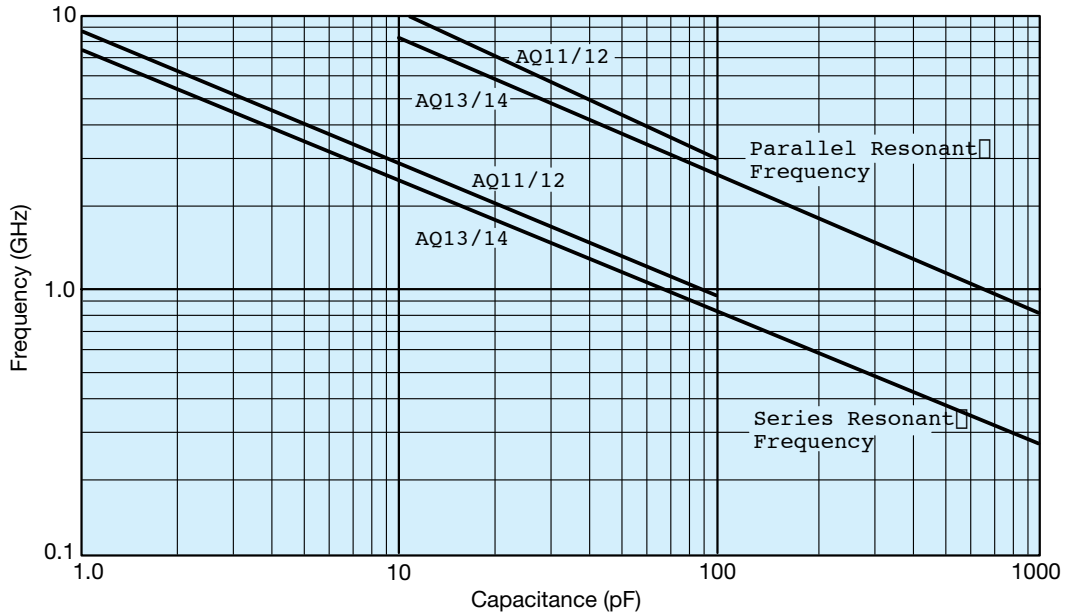

TYPICAL RESONANT FREQUENCY vs. CAPACITANCE
AVX 0603

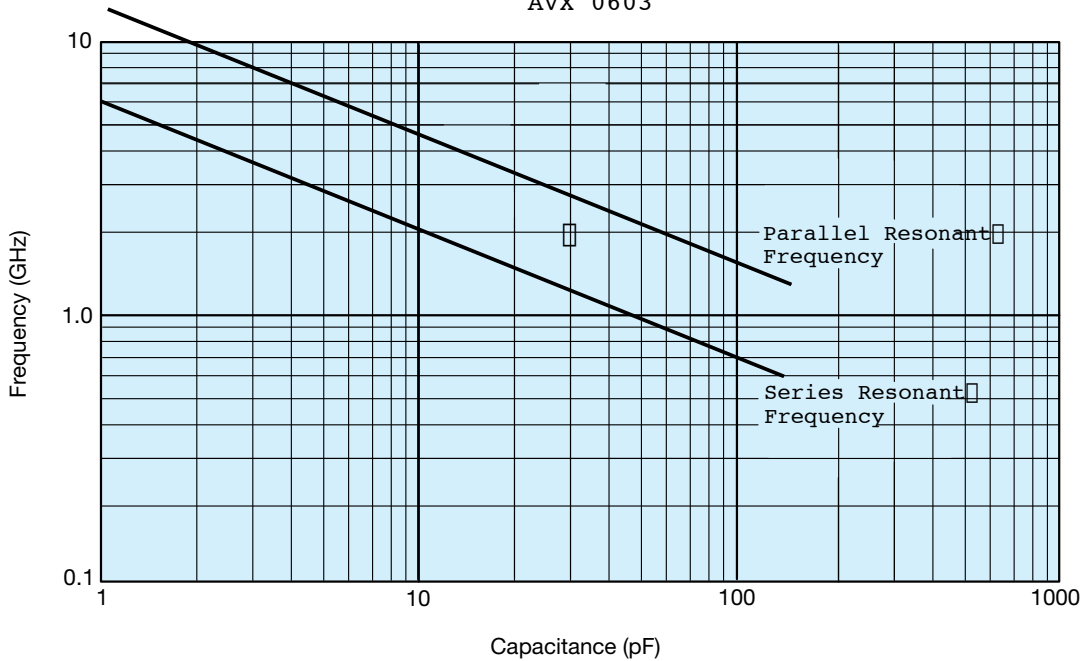

Microwave MLC's

Automatic Insertion Packaging



TAPE & REEL: All tape and reel specifications are in compliance with EIA RS481 (equivalent to IEC 286 part 3).

Sizes SQCA through SQCB, CDR11/12 through 13/14.

- 8mm carrier
- 7" reel: ≤ 0.040 " thickness = 2000 pcs
 ≤ 0.075 " thickness = 2000 pcs
- 13" reel: ≤ 0.075 " thickness = 10,000 pcs

"U" Series - 402/0603/0805/1210 Size Chips

- 8mm carrier
- 7" reel: 0402 = 10,000 pcs
 0603 & 0805 ≤ 0.40 " thickness = 4000 pcs
 0805 . 0.040" thickness & 1210 = 2000 pcs
- 13" reel: ≤ 0.075 " thickness = 10,000 pcs

REEL DIMENSIONS: millimeters (inches)

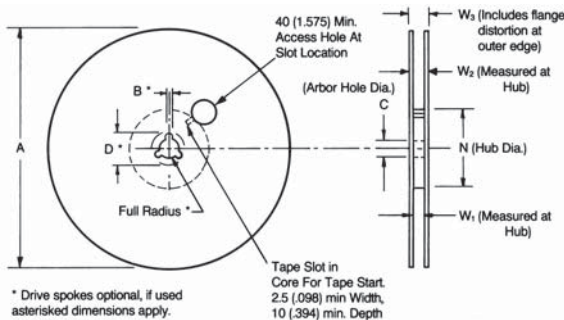

Tape Size ⁽¹⁾	A Max.	B* Min.	C	D* Min.	N Min.	W ₁	W ₂ Max.	W ₃
8mm	330 (12.992)	1.5 (.059)	13.0±0.20 (.512±.008)	20.2 (.795)	50 (1.969)	8.4 ^{+1.0} _{-0.0} (.331 ^{+0.003} _{-0.0})	14.4 (.567)	7.9 Min. (.311) 10.9 Max. (.429)
12mm						12.4 ^{+2.0} _{-0.0} (.488 ^{+0.076} _{-0.0})	18.4 (.724)	11.9 Min. (.469) 15.4 Max. (.607)

Metric dimensions will govern.
 English measurements rounded and for reference only.
 (1) For tape sizes 16mm and 24mm (used with chip size 3640) consult EIA RS-481 latest revision.

EMBOSSED CARRIER CONFIGURATION

8 & 12 MM TAPE ONLY

CONSTANT DIMENSIONS

Tape Size	D ₀	E	P ₀	P ₂	T Max.	T ₁	G ₁	G ₂
8mm and 12mm	8.4 ^{+0.10} _{-0.0} (.059 ^{+0.004} _{-0.0})	1.75 ± 0.10 (.069 ± .004)	4.0 ± 0.10 (.157 ± .004)	2.0 ± 0.05 (.079 ± .002)	0.600 (.024)	0.10 Max. (.004)	0.75 Min. (.030)	0.75 Min. (.030)

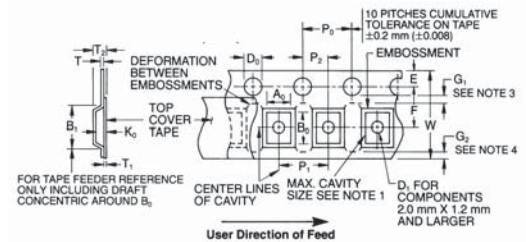

VARIABLE DIMENSIONS

Tape Size	B ₁ Max. See Note 6	D ₁ Min. See Note 5	F	P ₁	R Min. See Note 2	T ₂	W	A ₀ B ₀ K ₀
8mm	4.55 (.179)	1.0 (.039)	3.5 ± 0.05 (.138 ± .002)	4.0 ± 0.10 (.157 ± .004)	25 (.984)	2.5 Max (.098)	8.0 ^{+0.3} _{-0.1} (.315 ^{+0.012} _{-0.004})	See Note 1
12mm	8.2 (.323)	1.5 (.059)	5.5 ± 0.05 (.217 ± .002)	4.0 ± 0.10 (.157 ± .004)	30 (1.181)	6.5 Max (.256)	12.0 ± .30 (.472 ± .012)	See Note 1

NOTES:

- A₀, B₀, and K₀ are determined by the max. dimensions to the ends of the terminals extending from the component body and/or the body dimensions of the component. The clearance between the end of the terminals or body of the component to the sides and depth of the cavity (A₀, B₀, and K₀) must be within 0.05 mm (.002) min. and 0.50 mm (.020) max. The clearance allowed must also prevent rotation of the component within the cavity of not more than 20 degrees (see sketches C & D).
- Tape with components shall pass around radius "R" without damage. The minimum trailer length (Note 2 Fig. 3) may require additional length to provide R min. for 12mm embossed tape for reels with hub diameters approaching N min. (Table 4).
- G₁ dimension is the flat area from the edge of the sprocket hole to either the outward deformation of the carrier tape between the embossed cavities or to the edge of the cavity whichever is less.
- G₂ dimension is the flat area from the edge of the carrier tape opposite the sprocket holes to either the outward deformation of the carrier tape between the embossed cavity or to the edge of the cavity whichever is less.
- The embossment hole location shall be measured from the sprocket hole controlling the location of the embossment. Dimensions of embossment location and hole location shall be applied independent of each other.
- B₁ dimension is a reference dimension for tape feeder clearance only.

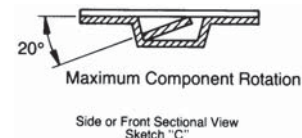
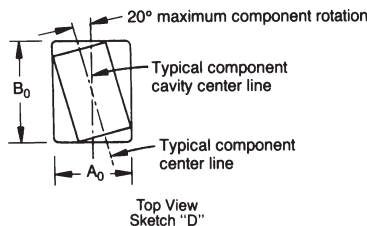

Hi-Q® High RF Power MLC Surface Mount Capacitors

For 600V to 7200V Applications



PRODUCT OFFERING

Hi-Q®, high RF power, surface mount MLC capacitors from AVX Corporation are characterized with ultra-low ESR and dissipation factor at high frequencies. They are designed to handle high power and high voltage levels for applications in RF power amplifiers, inductive heating, high magnetic field environments (MRI coils), medical and industrial electronics.

HOW TO ORDER

AVX Style	Voltage	Temperature Coefficient	Capacitance Code	Capacitance Tolerance	Test Level	Termination*	Packaging
HQCC	300V = 9	C0G = A	(2 significant digits + no. of zeros)	B = 0.1pf (<8.2pF)	A = Standard	T = Plated Ni and Sn (RoHS Compliant)	1A = 7" Reel*
HQCE	500V = 7	P90 = M	Examples:	C = ±0.25pF (<8.2pF)		J = 5% Min Pb	6A = Waffle Pack
HQLC	800V = U		4.7 pF = 4R7	D = ±0.50pF (<8.2pF)		7 = Plated Ni and Au	*HQCC & HQCE only
HQLE	1000V = A		10 pF = 100	F = ±1% (≥10pF)		A = Axial Ribbon	
	1500V = S		100 pF = 101	G = ±2%		M = Microstrip	
	2500V = W		1,000 pF = 102	J = ±5%		H = Cu/Sn (Non-Magnetic)	
	3000V = H			K = ±10%		4 = Axial Ribbon (Non-Magnetic)	
	3600V = J			M = ±20%		5 = Microstrip (Non-Magnetic)	
	5000V = K						
	7200V = M						

DIMENSIONS

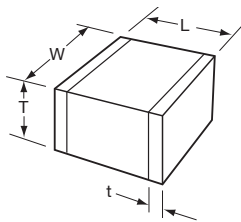

mm (inches)

STYLE	HQCC	HQCE
(L) Length	5.84 +0.51 -0.25 (0.230 +0.020 -0.010)	9.65 +0.38 -0.25 (0.380 +0.015 -0.010)
(W) Width	6.35 ± 0.38 (0.250 ± 0.015)	9.65 ± 0.25 (0.380 ± 0.010)
(T) Thickness Max.	3.68 (0.145) max. for capacitance values ≤ 680pF 4.19 (0.165) max. for capacitance values > 680pF	4.32 (0.170) max.
(t) Overlap	1.02 (0.040) max.	1.02 (0.040) max.

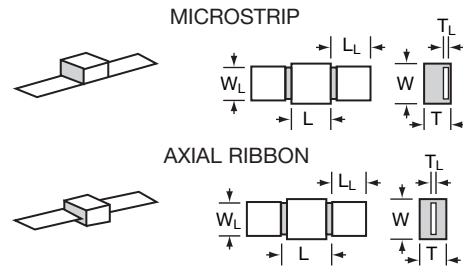

mm (inches)

STYLE	HQLC	HQLE
(L) Length	6.22 ± 0.64 (0.245 ± 0.025)	9.65 +0.89 -0.25 (0.380 +0.035 -0.010)
(W) Width	6.35 ± 0.38 (0.250 ± 0.015)	9.65 ± 0.25 (0.380 ± 0.010)
(T) Thickness Max.	3.68 (0.145) max. for capacitance values ≤ 680pF 4.19 (0.165) max. for capacitance values ≤ 680pF	4.32 (0.170) max.
(L _L) Lead Length	12.7 min. (0.500)	19.05 (0.750)
(W _L) Lead Width	6.10 ± 0.127 (0.240 ± 0.005)	8.89 ± 0.25 (0.350 ± 0.010)
(T _L) Lead Thickness	0.102 ± 0.025 (0.004 ± 0.001)	0.25 ± 0.13 (0.010 ± 0.005)
Lead Material	High Purity Silver Leads Leads are attached with High Temperature Solder	High Purity Silver Leads Leads are attached with High Temperature Solder

Not RoHS Compliant



For RoHS compliant products,
please select correct termination style.

Hi-Q[®] High RF Power MLC Surface Mount Capacitors

For 600V to 7200V Applications



DIELECTRIC PERFORMANCE CHARACTERISTICS

Capacitance Range	1.0pF to 2,700pF (25°C, 1.0 ±0.2 Vrms at 1kHz, for ≤ 1000 pF use 1MHz)
Capacitance Tolerances	±0.10pF, ±0.25pF, ±0.50pF, ±1%, ±2%, ±5%, ±10%, ±20%
Dissipation Factor 25°C	0.1% Max (+25°C, 1.0 ±0.2 Vrms at 1kHz, for ≤ 1000 pF use 1MHz)
Operating Temperature Range	-55°C to +125°C
Temperature Characteristic	C0G: 0 ± 30 ppm/°C (-55°C to +125°C), P90: 90 ± 30 ppm/°C (-55°C to +125°C)
Insulation Resistance	100K MΩ min. @ +25°C and 500VDC 10K MΩ min. @ +125°C and 500VDC
Dielectric Strength	250% of WVDC for capacitors rated at 500 volts DC or less for 5 seconds. 150% of WVDC for capacitors rated at 1250 volts DC or less for 5 seconds. 120% of WVDC for capacitors rated above 1250 volts DC or less for 5 seconds.

HQCC CAPACITANCE VALUES (A DIELECTRIC)

Cap Code	Cap (pF)	Tol.	Rated WVDC	Cap Code	Cap (pF)	Tol.	Rated WVDC	Cap Code	Cap (pF)	Tol.	Rated WVDC	Cap Code	Cap (pF)	Tol.	Rated WVDC
1R0	1.0	B, C, D	2500	8R2	8.2	B, C, D	2500	680	68	F, G, J K, M	2500	471	470	F, G, J K, M	1500
1R2	1.2			100	10	820		82	561			560	1000		
1R5	1.5			120	12	101		100	681			680			
1R8	1.8			150	15	121		120	821			820			
2R2	2.2			180	18	151		150	102			1000			
2R7	2.7			220	22	181		180	122			1200			
3R3	3.3			270	27	221		220	152			1500			500
3R9	3.9			330	33	271		270	182			1800			
4R7	4.7			390	39	331		330	222			2200			300
5R6	5.6			470	47	391		390	272			2700			
6R8	6.8			560	56										

HQCC CAPACITANCE VALUES (M DIELECTRIC)

Cap Code	Cap (pF)	Tol.	Rated WVDC		Cap Code	Cap (pF)	Tol.	Rated WVDC		Cap Code	Cap (pF)	Tol.	Rated WVDC			
			Standard	Extended				Standard	Extended				Standard	Extended		
1R0	1.0	B, C, D	2500	3600	100	10	F, G, J K, M	2500	3600	161	160	F, G, J K, M	2500	3000		
1R1	1.1				110	11				181	180					
1R2	1.2				120	12				201	200					
1R3	1.3				130	13				221	220					
1R4	1.4				150	15				241	240					
1R5	1.5				160	16				271	270					
1R6	1.6				180	18				301	300					
1R7	1.7				200	20				331	330					
1R8	1.8				220	22				331	330				1500	2000
1R9	1.9				240	24				361	360					
2R0	2.0				270	27				391	390					
2R1	2.1				300	30				431	430					
2R2	2.2				330	33				471	470					
2R4	2.4				360	36				511	510					
2R5	2.5				390	39				561	560					
3R0	3.0				430	43				621	620					
3R3	3.3				470	47				681	680					
3R6	3.6				510	51				751	750		1000	1500		
3R9	3.9				560	56				821	820					
4R3	4.3				620	62				911	910					
4R7	4.7				680	68				102	1000					
5R1	5.1				750	75				112	1100					
5R6	5.6				820	82				122	1200					
6R2	6.2				910	91				152	1500					
6R8	6.8				101	100				182	1800					
7R5	7.5				111	110				222	2200				300	500
8R2	8.2				121	120				242	2400					
9R1	9.1	131	130	272	2700											
		151	150													

Hi-Q[®] High RF Power MLC Surface Mount Capacitors

For 600V to 7200V Applications



HQCE CAPACITANCE VALUES (A DIELECTRIC)

Cap Code	Cap (pF)	Tol.	Rated WVDC		Cap Code	Cap (pF)	Tol.	Rated WVDC		Cap Code	Cap (pF)	Tol.	Rated WVDC	
			Standard	Extended				Standard	Extended				Standard	Extended
1R0	1.0	C, D	3600	7200	150	15	G, J, K, M	3600	7200	221	220	G, J, K, M	3600	NA
1R2	1.2				271	270								
1R5	1.5				331	330								
1R8	1.8				391	390								
2R2	2.2				471	470								
2R7	2.7				561	560								
3R3	3.3				681	680								
3R9	3.9				821	820								
4R7	4.7				102	1000								
5R6	5.6				122	1200								
6R8	6.8	152	1500											
8R2	8.2	182	1800											
100	10	G, J, K, M	3600	7200	121	120	G, J, K, M	3600	5000	222	2200	G, J, K, M	1000	NA
120	12				151	150								
					181	180								

HQCE CAPACITANCE VALUES (M DIELECTRIC)

Cap Code	Cap (pF)	Tol.	Rated WVDC		Cap Code	Cap (pF)	Tol.	Rated WVDC		Cap Code	Cap (pF)	Tol.	Rated WVDC	
			Standard	Extended				Standard	Extended				Standard	Extended
1R0	1.0	B, C, D	3600	7200	180	18	F, G, J, K, M	3600	7200	331	330	F, G, J, K, M	3600	NA
1R2	1.2				391	390								
1R5	1.5				471	470								
1R8	1.8				561	560								
2R2	2.2				681	680								
2R7	2.7				821	820								
3R3	3.3				102	1000								
3R9	3.9				122	1200								
4R7	4.7				152	1500								
5R6	5.6				182	1800								
6R8	6.8	222	2200											
8R2	8.2	272	2700											
100	10	F, G, J, K, M	3600	7200	121	120	F, G, J, K, M	3600	5000	332	3300	G, J, K, M	500	NA
120	12				151	150								
					181	180								
150	15				221	220								
		271	270											

Hi-Q[®] High RF Power MLC Surface Mount Capacitors

For 600V to 7200V Applications



HQCC PERFORMANCE CHARACTERISTICS (A DIELECTRIC)

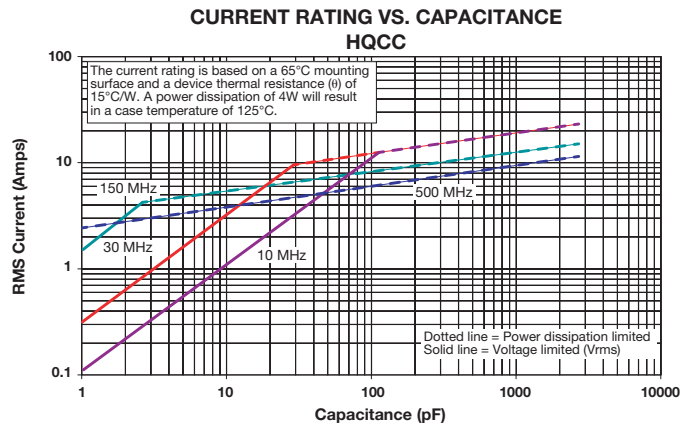
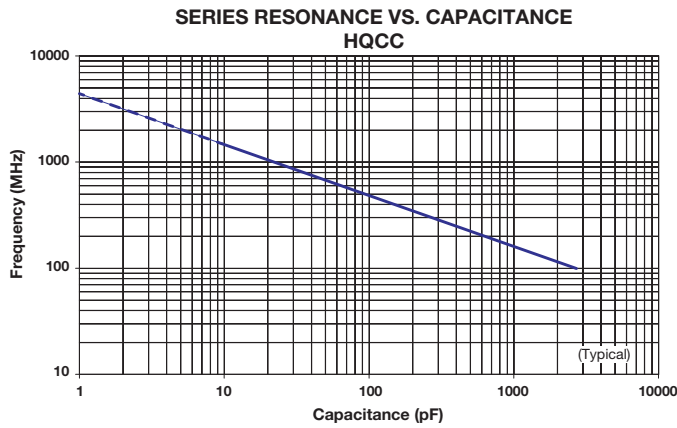
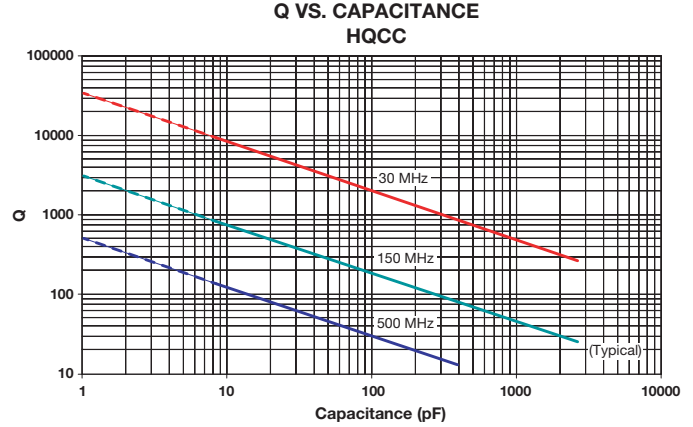
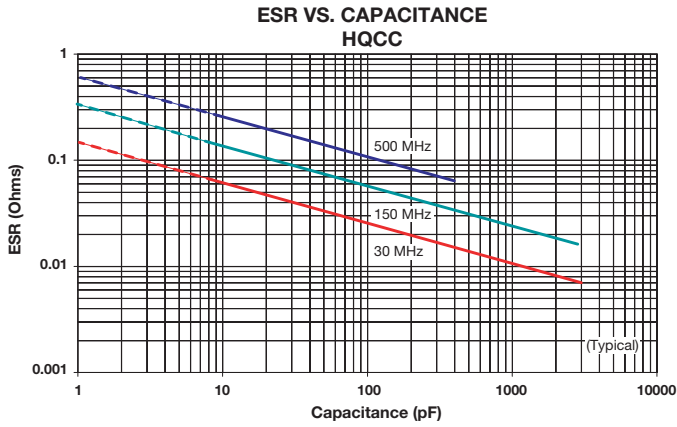

HQCC PERFORMANCE CHARACTERISTICS (M DIELECTRIC)

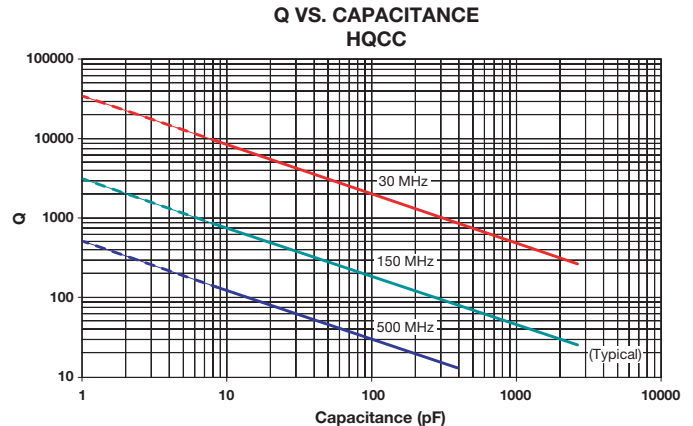
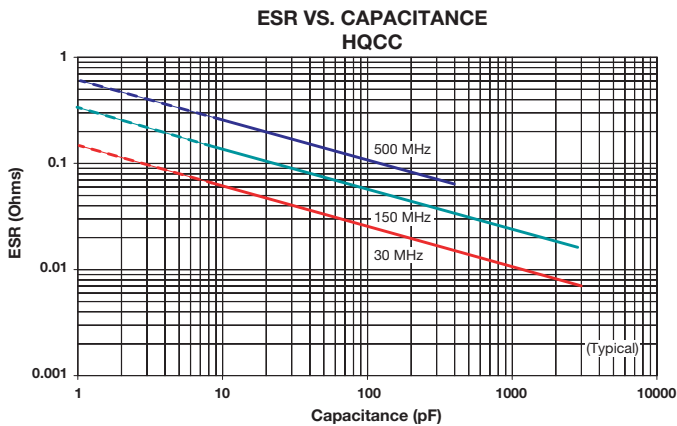

Hi-Q[®] High RF Power MLC Surface Mount Capacitors For 600V to 7200V Applications

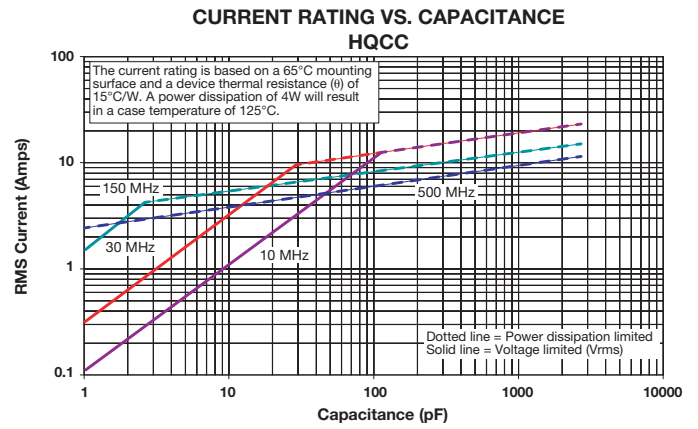
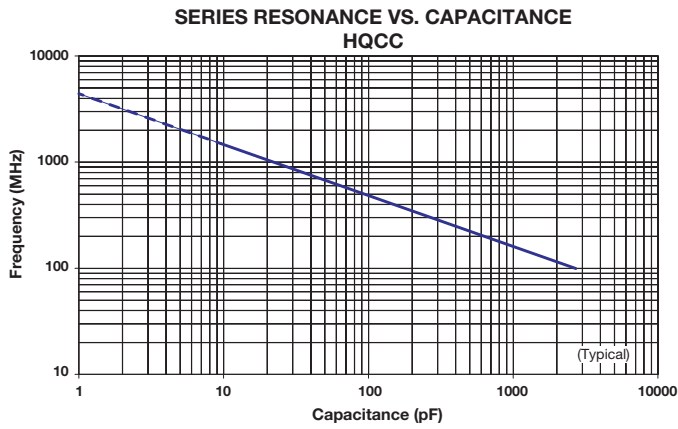

HQCE PERFORMANCE CHARACTERISTICS (A DIELECTRIC)

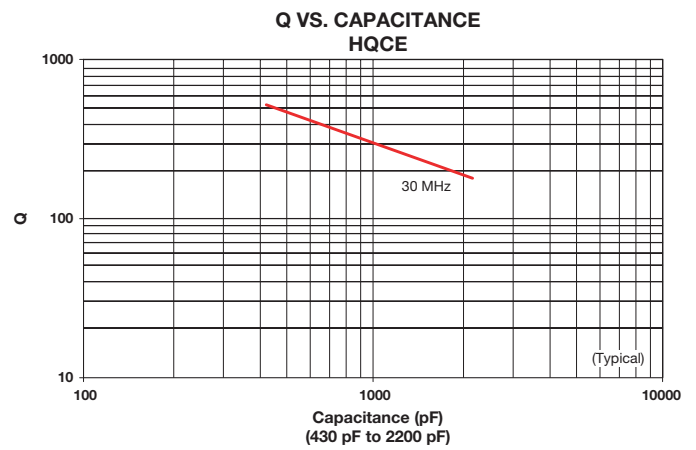
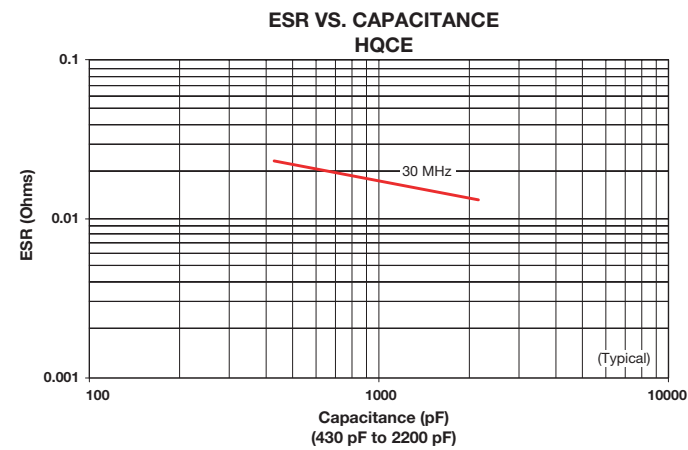
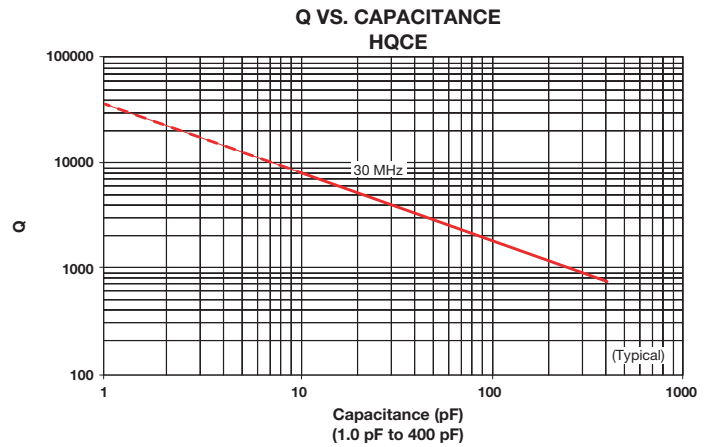
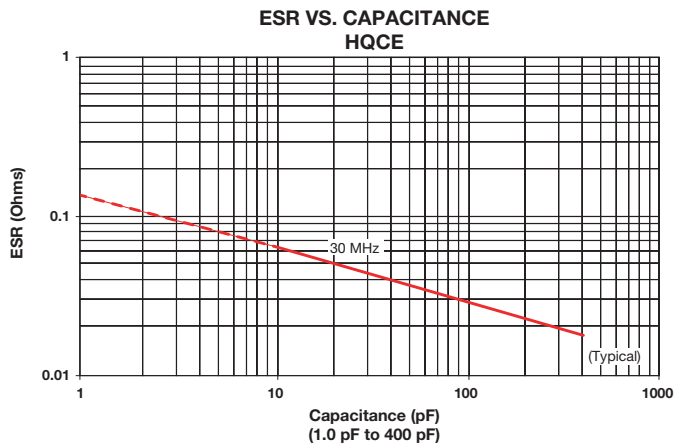

Hi-Q[®] High RF Power MLC Surface Mount Capacitors For 600V to 7200V Applications



**SERIES RESONANCE VS. CAPACITANCE
HQCE**

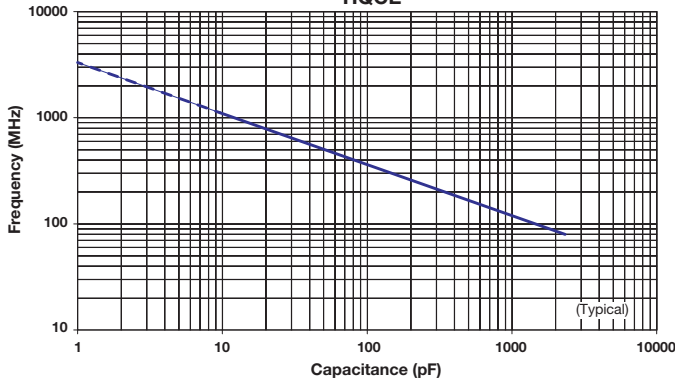

**CURRENT RATING VS. CAPACITANCE
HQCE**

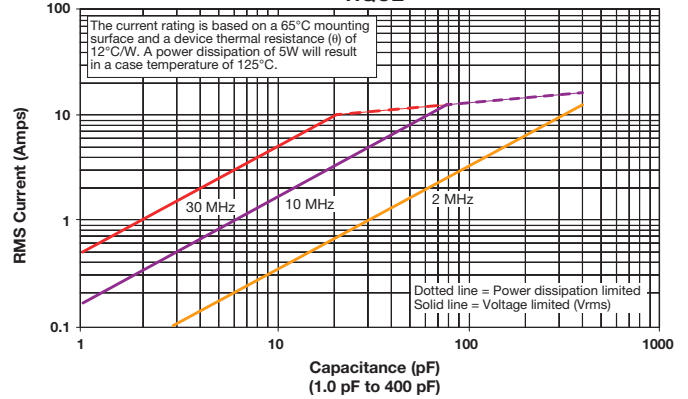

**CURRENT RATING VS. CAPACITANCE
HQCE**

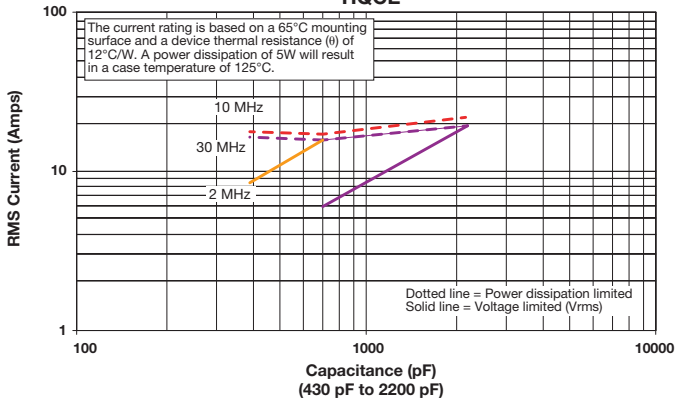

**CURRENT RATING VS. CAPACITANCE
HQCE**

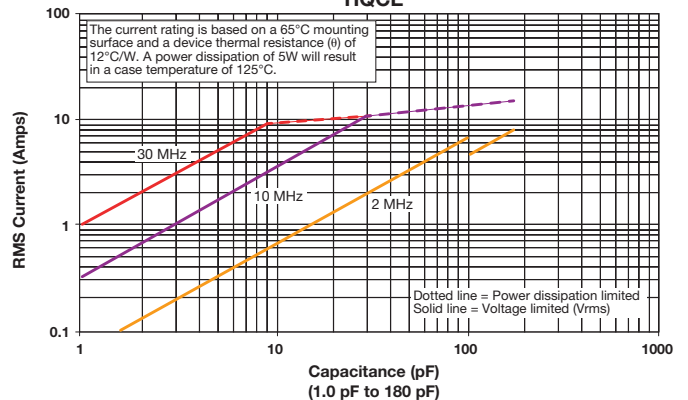

HQCE PERFORMANCE CHARACTERISTICS (M DIELECTRIC)

**ESR VS CAPACITANCE
HQCE M Dielectric**

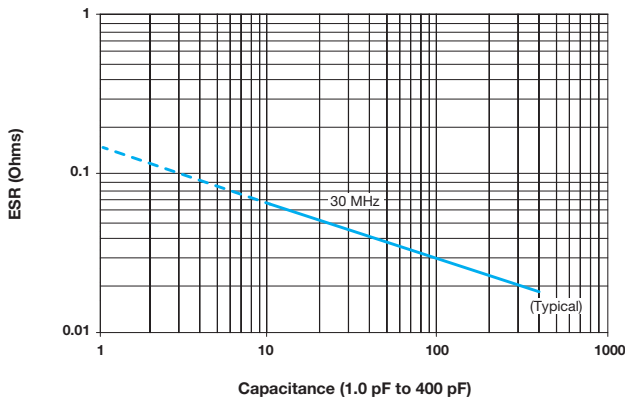

**Q VS CAPACITANCE
HQCE M Dielectric**

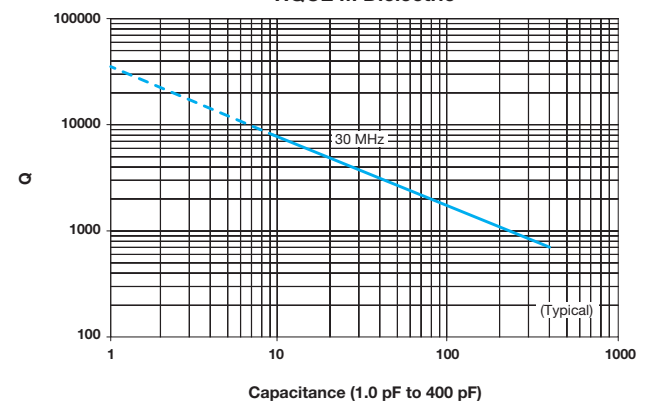

Hi-Q[®] High RF Power MLC Surface Mount Capacitors For 600V to 7200V Applications



ESR VS CAPACITANCE
HQCE M Dielectric

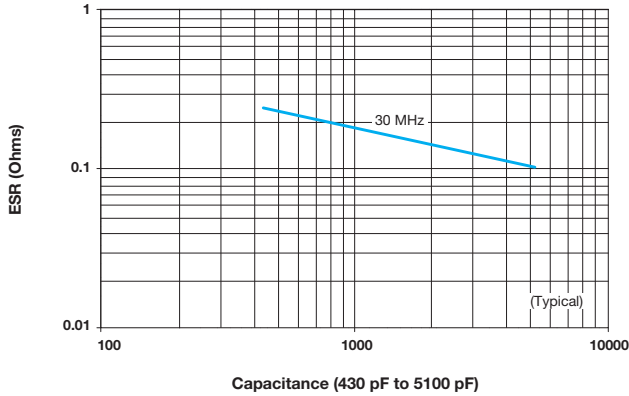

Q VS CAPACITANCE
HQCE M Dielectric

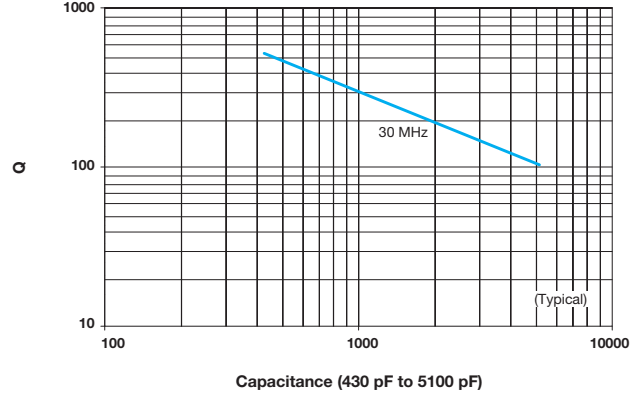

SERIES RESONANCE VS CAPACITANCE
HQCE M Dielectric

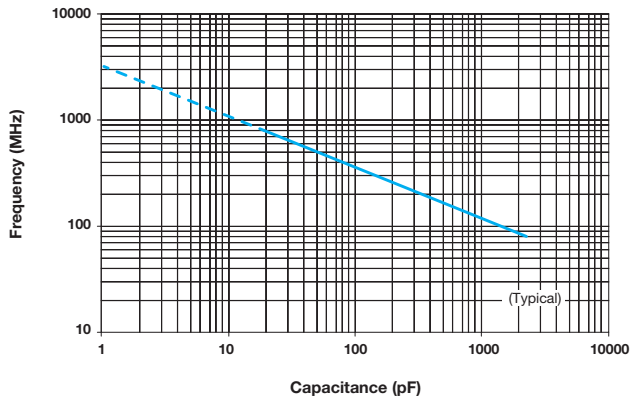

CURRENT RATING VS CAPACITANCE
HQCE M Dielectric

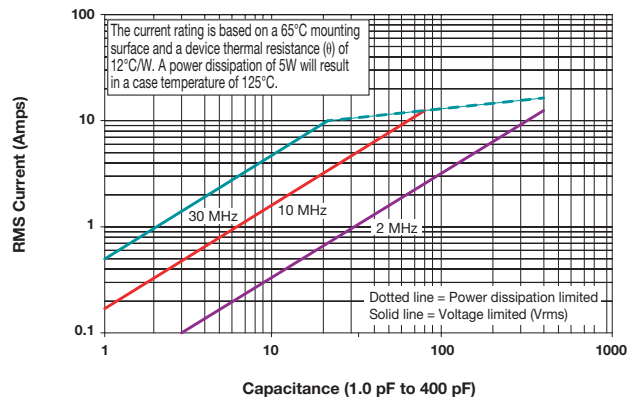

CURRENT RATING VS CAPACITANCE
HQCE M Dielectric

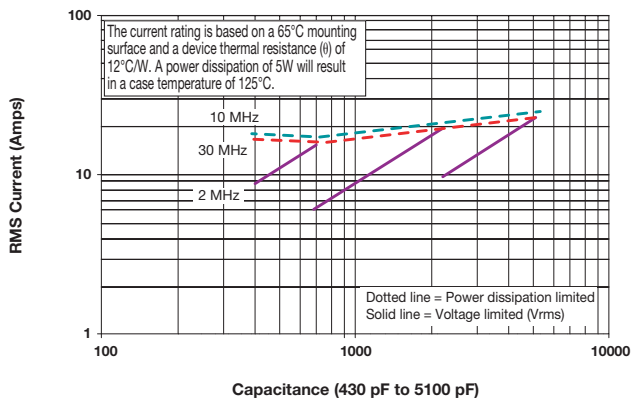

RF/Microwave COG (NP0) Capacitors (RoHS)



Ultra Low ESR, "CU" Series, COG (NP0) Chip Capacitors

GENERAL INFORMATION

"CU" Series capacitors are COG (NP0) chip capacitors specially designed for "Ultra" low ESR for applications in the communications market. Sizes available are EIA chip sizes 01005 and 0201.

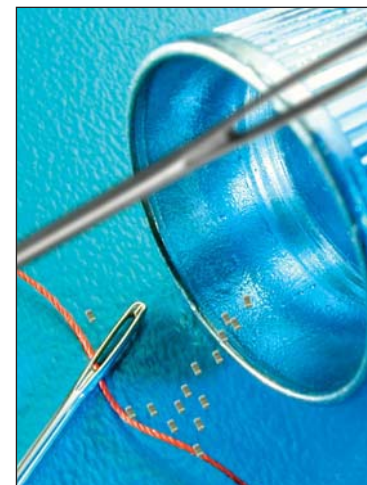

DIMENSIONS:

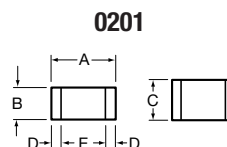
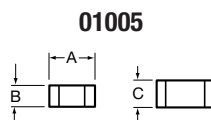
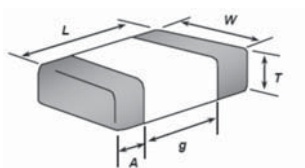

mm (inches)

Size	L (Length)	W (Width)	T (Max. Thickness)	g (min.)	A (Termination Min./Max.)
0402 (01005)	0.40±0.02 (0.016±0.0008)	0.20±0.02 (0.008±0.0008)	0.22 (0.009)	0.13 (0.005)	0.70/0.14 (0.003/0.006)
0603 (0201)	0.60±0.03 (0.024±0.001)	0.30±0.03 (0.012±0.001)	0.33 (0.013)	0.15 (0.006)	0.10/0.20 (0.004/0.008)

HOW TO ORDER

CU01	3	1	100	J	A	T	2	A
Case Size CU10 = 01005 CU01 = 0201	Voltage Code 3 = 25V Y = 16V	Dielectric 1 = 0±30ppm COG (NP0)	Capacitance EIA Capacitance Code in pF. First two digits = significant figures or "R" for decimal place. Third digit = number of zeros or after "R" significant figures.	Capacitance Tolerance Code B = ±0.1pF C = ±0.25pF D = ±0.5pF G = ±2% J = ±5%	Failure Rate Code A = Not Applicable	Termination T = Plated Ni and Sn	Packaging Code 2 = 7" Reel 4 = 13" Reel U = 7" Reel 4mm TR (01005)	Special A = Standard



ELECTRICAL CHARACTERISTICS

Capacitance Value Range:

Size 01005 0.5 to 22pF
Size 0201 0.5 to 22pF

Temperature Coefficient of Capacitance (TC):

0±30 ppm/°C (-55° to +125°C)

Insulation Resistance (IR):

10¹² Ω min. @ 25°C and rated WVDC
10¹¹ Ω min. @ 125°C and rated WVDC

Working Voltage (WVDC):

Size Working Voltage
01005 - 16 WVDC
0201 - 25 WVDC

RF/Microwave C0G (NP0) Capacitors (RoHS)



Ultra Low ESR, "CU" Series, C0G (NP0) Chip Capacitors

CAPACITANCE RANGE

Cap (pF)	Available Tolerance	
	01005	0201
0.5	B,C,D	B,C,D
0.75	B,C,D	B,C,D
1.0	B,C,D	B,C,D
1.2	B,C,D	B,C,D
1.5	B,C,D	B,C,D
1.8	B,C,D	B,C,D
2.2	B,C,D	B,C,D
2.7	B,C,D	B,C,D
3.3	B,C,D	B,C,D
3.9	B,C,D	B,C,D
4.7	B,C,D	B,C,D
5.6	B,C,D	C,D
6.2	B,C,D	C,D
6.8	B,C,D	D
8.2	B,C,D	D
10.0	G,J,K	J,K
12.0	G,J,K	J,K
15.0	G,J,K	J,K
18.0	G,J,K	J,K
22.0	G,J,K	J,K

ULTRA LOW ESR, "CU" SERIES

01005 6.2pF

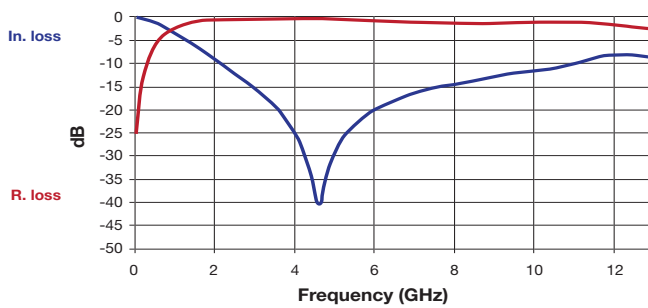

	F (GHz)	IL	R. loss
F1	0.31	-0.40	-9.68
F2	1.28	-5.03	-1.44
F3	2.408	-11.58	-0.27
F4	4.635	-40.55	-0.39
F5	4.897	-31.82	-0.47

0201 4.7pF

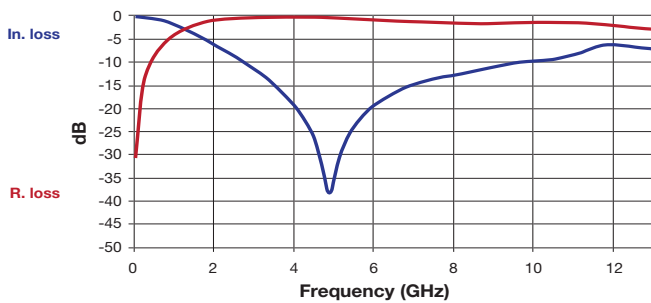

	F (GHz)	IL	R. loss
F1	0.31	-0.13	-12.90
F2	1.28	-2.89	-2.84
F3	2.408	-8.09	-0.60
F4	4.635	-29.45	-0.37
F5	4.897	-38.55	-0.45

0201 22pF

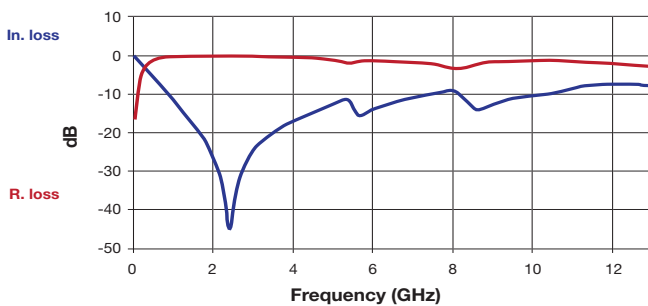

	F (GHz)	IL	R. loss
F1	0.31	-2.90	-2.85
F2	1.28	-15.26	-0.10
F3	2.408	-45.65	-0.10
F4	4.635	-14.90	-0.87
F5	4.897	-12.89	-1.08

RF/Microwave COG (NP0) Capacitors (RoHS)



Ultra Low ESR, "U" Series, COG (NP0) Chip Capacitors

GENERAL INFORMATION

"U" Series capacitors are COG (NP0) chip capacitors specially designed for "Ultra" low ESR for applications in the communications market. Max ESR and effective capacitance

are met on each value producing lot to lot uniformity. Sizes available are EIA chip sizes 0603, 0805, and 1210.

DIMENSIONS: inches (millimeters)

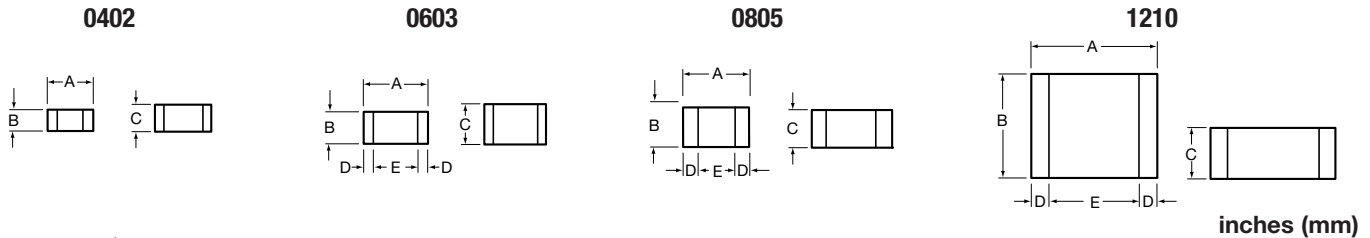

Size	A	B	C	D	E
0402	0.039±0.004 (1.00±0.1)	0.020±0.004 (0.50±0.1)	0.024 (0.6) max	N/A	N/A
0603	0.060±0.010 (1.52±0.25)	0.030±0.010 (0.76±0.25)	0.036 (0.91) max	0.010±0.005 (0.25±0.13)	0.030 (0.76) min
0805	0.079±0.008 (2.01±0.2)	0.049±0.008 (1.25±0.2)	0.040±0.005 (1.02±0.127)	0.020±0.010 (0.51±0.254)	0.020 (0.51) min
1210	0.126±0.008 (3.2±0.2)	0.098±0.008 (2.49±0.2)	0.050±0.005 (1.27±0.127)	0.025±0.015 (0.635±0.381)	0.040 (1.02) min

HOW TO ORDER

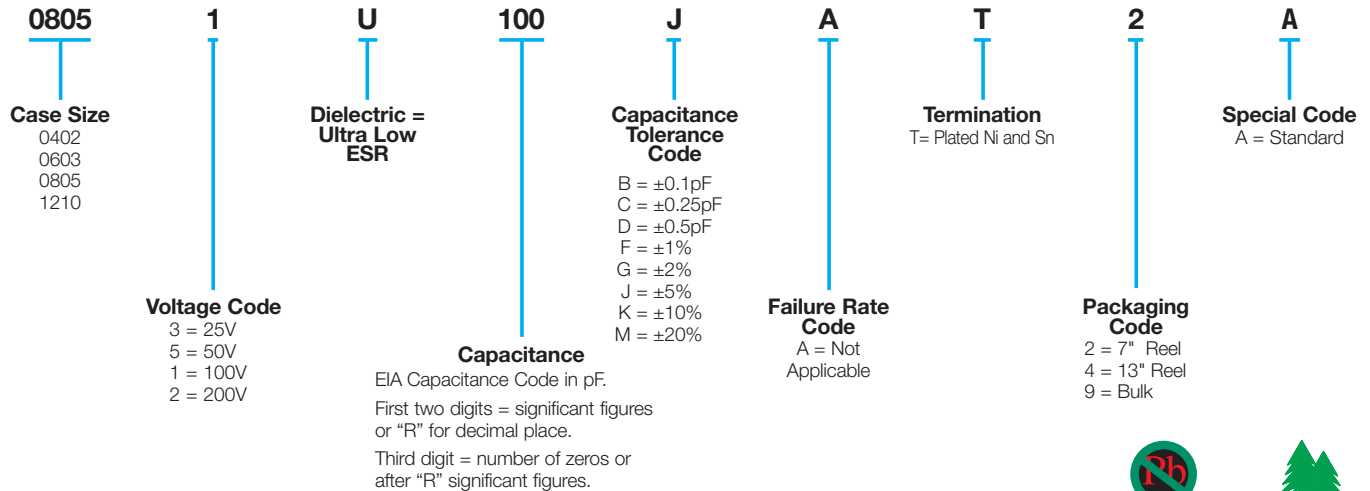

ELECTRICAL CHARACTERISTICS

Capacitance Values and Tolerances:

- Size 0402 - 0.2 pF to 22 pF @ 1 MHz
- Size 0603 - 1.0 pF to 100 pF @ 1 MHz
- Size 0805 - 1.6 pF to 160 pF @ 1 MHz
- Size 1210 - 2.4 pF to 1000 pF @ 1 MHz

Temperature Coefficient of Capacitance (TC):

0±30 ppm/°C (-55° to +125°C)

Insulation Resistance (IR):

- 10¹² Ω min. @ 25°C and rated WVDC
- 10¹¹ Ω min. @ 125°C and rated WVDC

Working Voltage (WVDC):

- | Size | Working Voltage |
|------|-------------------|
| 0402 | 50, 25 WVDC |
| 0603 | 200, 100, 50 WVDC |
| 0805 | 200, 100 WVDC |
| 1210 | 200, 100 WVDC |

Dielectric Working Voltage (DWV):

250% of rated WVDC

Equivalent Series Resistance Typical (ESR):

- 0402 - See Performance Curve, page 231
- 0603 - See Performance Curve, page 231
- 0805 - See Performance Curve, page 231
- 1210 - See Performance Curve, page 231

Marking: Laser marking EIA J marking standard

(except 0603) (capacitance code and tolerance upon request).

MILITARY SPECIFICATIONS

Meets or exceeds the requirements of MIL-C-55681



RF/Microwave COG (NP0) Capacitors (RoHS)



Ultra Low ESR, "U" Series, COG (NP0) Chip Capacitors

CAPACITANCE RANGE

Cap (pF)	Available Tolerance	Size				Cap (pF)	Available Tolerance	Size				Cap (pF)	Available Tolerance	Size				Cap (pF)	Available Tolerance	Size			
		0402	0603	0805	1210			0402	0603	0805	1210			0402	0603	0805	1210			0402	0603	0805	1210
0.2	B,C	50V	N/A	N/A	N/A	1.0	B,C,D	50V	200V	200V	200V	100	F,G,J,K,M	N/A	100V	200V	200V	100	F,G,J,K,M	N/A	100V	200V	200V
0.3	B,C	↓	↓	↓	↓	1.1	↓	↓	↓	↓	↓	110	↓	↓	↓	↓	↓	110	↓	↓	↓	↓	↓
0.4	B,C	↓	↓	↓	↓	1.2	↓	↓	↓	↓	↓	120	↓	↓	↓	↓	↓	120	↓	↓	↓	↓	↓
0.5	B,C	↓	↓	↓	↓	1.3	↓	↓	↓	↓	↓	130	↓	↓	↓	↓	↓	130	↓	↓	↓	↓	↓
0.6	B,C,D	↓	↓	↓	↓	1.4	↓	↓	↓	↓	↓	140	↓	↓	↓	↓	↓	140	↓	↓	↓	↓	↓
0.7	B,C,D	↓	↓	↓	↓	1.5	↓	↓	↓	↓	↓	150	↓	↓	↓	↓	↓	150	↓	↓	↓	↓	↓
0.8	B,C,D	↓	↓	↓	↓	1.6	↓	↓	↓	↓	↓	160	↓	↓	↓	↓	↓	160	↓	↓	↓	↓	↓
0.9	B,C,D	↓	↓	↓	↓	1.7	↓	↓	↓	↓	↓	180	↓	↓	↓	↓	↓	180	↓	↓	↓	↓	↓
						1.8	↓	↓	↓	↓	↓	200	↓	↓	↓	↓	↓	200	↓	↓	↓	↓	↓
						1.9	↓	↓	↓	↓	↓	220	↓	↓	↓	↓	↓	220	↓	↓	↓	↓	↓
						2.0	↓	↓	↓	↓	↓	270	↓	↓	↓	↓	↓	270	↓	↓	↓	↓	↓
						2.1	↓	↓	↓	↓	↓	300	↓	↓	↓	↓	↓	300	↓	↓	↓	↓	↓
						2.2	↓	↓	↓	↓	↓	330	↓	↓	↓	↓	↓	330	↓	↓	↓	↓	↓
						2.4	↓	↓	↓	↓	↓	360	↓	↓	↓	↓	↓	360	↓	↓	↓	↓	↓
						2.7	↓	↓	↓	↓	↓	390	↓	↓	↓	↓	↓	390	↓	↓	↓	↓	↓
						3.0	↓	↓	↓	↓	↓	430	↓	↓	↓	↓	↓	430	↓	↓	↓	↓	↓
						3.3	↓	↓	↓	↓	↓	470	↓	↓	↓	↓	↓	470	↓	↓	↓	↓	↓
						3.6	↓	↓	↓	↓	↓	510	↓	↓	↓	↓	↓	510	↓	↓	↓	↓	↓
						3.9	↓	↓	↓	↓	↓	560	↓	↓	↓	↓	↓	560	↓	↓	↓	↓	↓
						4.3	↓	↓	↓	↓	↓	620	↓	↓	↓	↓	↓	620	↓	↓	↓	↓	↓
						4.7	↓	↓	↓	↓	↓	680	↓	↓	↓	↓	↓	680	↓	↓	↓	↓	↓
						5.1	↓	↓	↓	↓	↓	750	↓	↓	↓	↓	↓	750	↓	↓	↓	↓	↓
						5.6	↓	↓	↓	↓	↓	820	↓	↓	↓	↓	↓	820	↓	↓	↓	↓	↓
						6.2	B,C,D	↓	↓	↓	↓	910	↓	↓	↓	↓	↓	910	↓	↓	↓	↓	↓
						6.8	B,C,J,K,M	↓	↓	↓	↓	1000	F,G,J,K,M	↓	↓	↓	↓	1000	F,G,J,K,M	↓	↓	↓	↓

ULTRA LOW ESR, "U" SERIES

TYPICAL ESR vs. FREQUENCY
0402 "U" SERIES

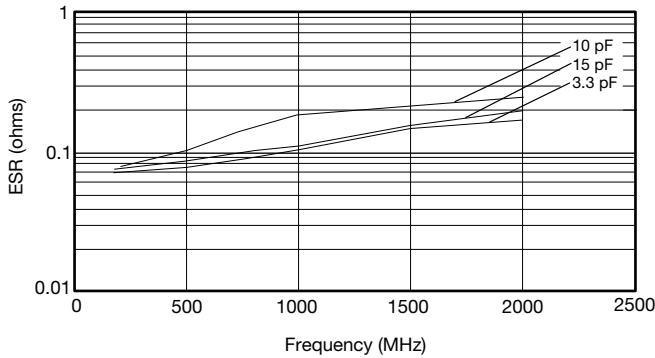

TYPICAL ESR vs. FREQUENCY
0603 "U" SERIES

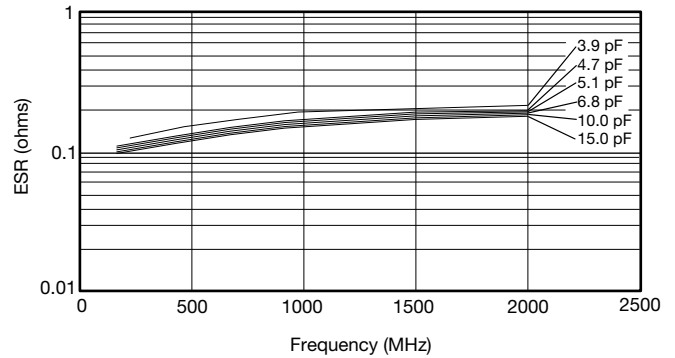

TYPICAL ESR vs. FREQUENCY
0805 "U" SERIES

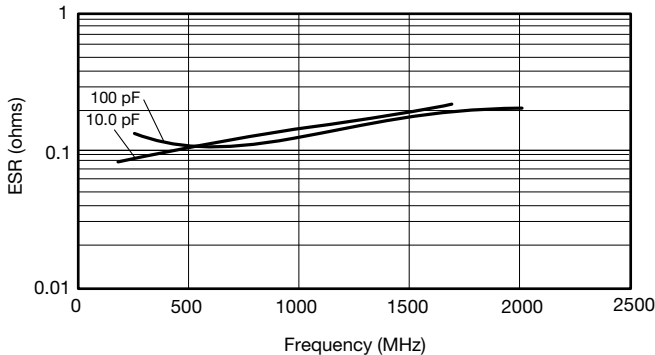

TYPICAL ESR vs. FREQUENCY
1210 "U" SERIES

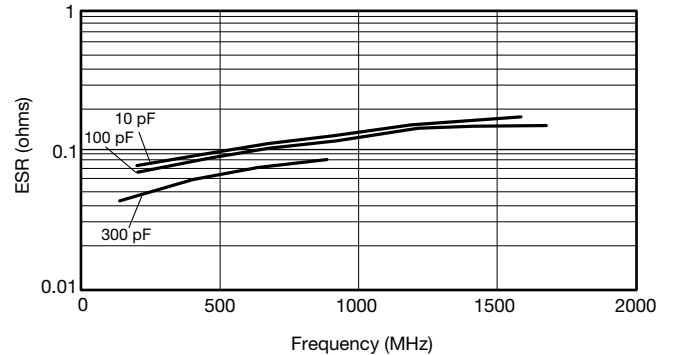

ESR Measured on the Boonton 34A

RF/Microwave C0G (NP0) Capacitors (RoHS)



Ultra Low ESR, "U" Series, C0G (NP0) Chip Capacitors

TYPICAL
SERIES RESONANT FREQUENCY
"U" SERIES CHIP

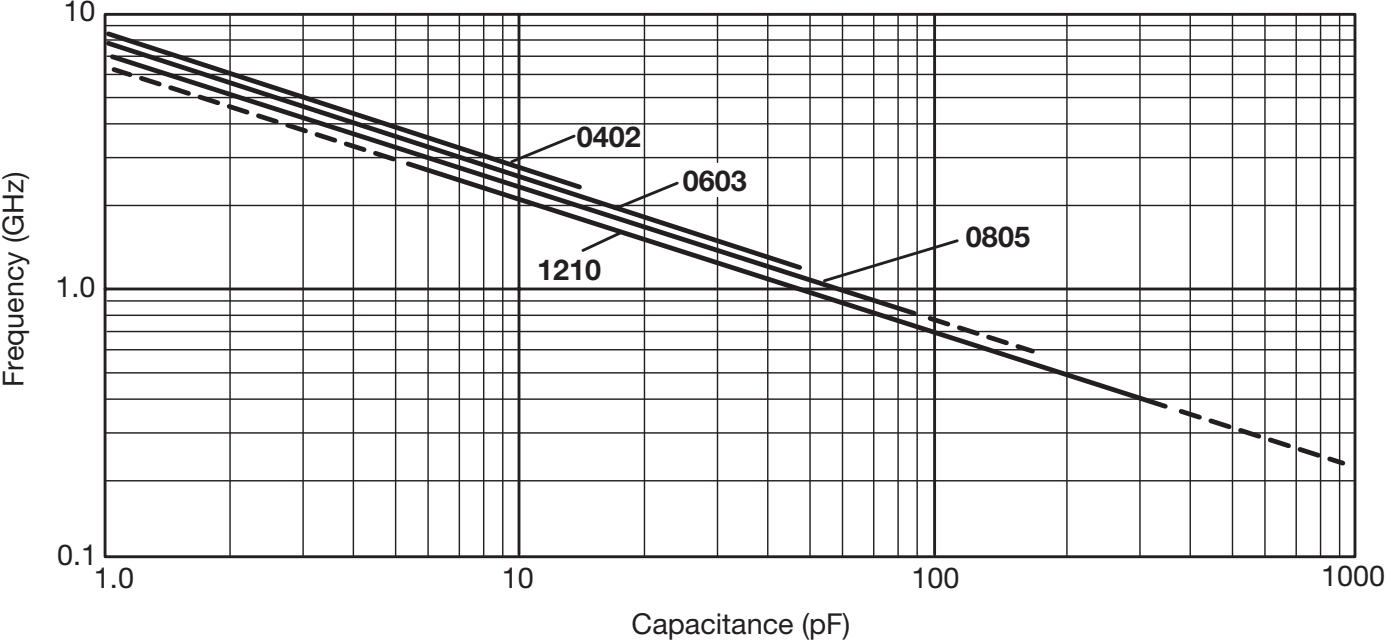

RF/Microwave Automotive C0G (NP0) Capacitors (RoHS), AEC Q200 Qualified



Ultra Low ESR, "U" Series, C0G (NP0) Chip Capacitors

GENERAL INFORMATION

Automotive "U" Series capacitors are C0G (NP0) chip capacitors specially designed for "Ultra" low ESR for applications in the automotive market. Max ESR and effective capacitance

are met on each value producing lot to lot uniformity. Sizes available are EIA chip sizes 0402 and 0603.

DIMENSIONS: inches (millimeters)

0402

0603



Size	A	B	C	D	E
0402	0.039±0.004 (1.00±0.1)	0.020±0.004 (0.50±0.1)	0.024 (0.6) max	N/A	N/A
0603	0.060±0.010 (1.52±0.25)	0.030±0.010 (0.76±0.25)	0.036 (0.91) max	0.010±0.005 (0.25±0.13)	0.030 (0.76) min

inches (mm)

HOW TO ORDER

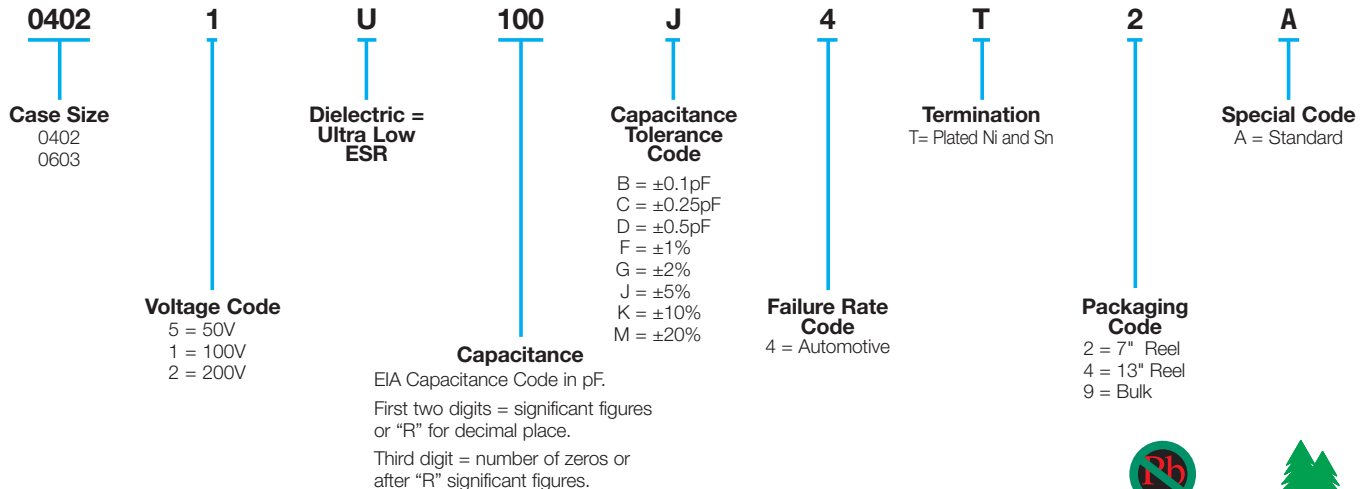

ELECTRICAL CHARACTERISTICS

Capacitance Values and Tolerances:

Size 0402 - 0.2 pF to 22 pF @ 1 MHz
Size 0603 - 1.0 pF to 100 pF @ 1 MHz

Temperature Coefficient of Capacitance (TC):

0±30 ppm/°C (-55° to +125°C)

Insulation Resistance (IR):

10¹² Ω min. @ 25°C and rated WVDC
10¹¹ Ω min. @ 125°C and rated WVDC

Working Voltage (WVDC):

Size Working Voltage
0402 - 50, 25 WVDC
0603 - 200, 100, 50 WVDC

Dielectric Working Voltage (DWV):

250% of rated WVDC

Equivalent Series Resistance Typical (ESR):

0402 - See Performance Curve, page 234
0603 - See Performance Curve, page 234

Automotive Specifications

Meets or exceeds the requirements of AEC Q200



RF/Microwave Automotive C0G (NP0) Capacitors (RoHS), AEC Q200 Qualified



Ultra Low ESR, "U" Series, C0G (NP0) Chip Capacitors

CAPACITANCE RANGE

Cap (pF)	Available Tolerance	Size	
		0402	0603
0.2	B,C	50V	N/A
0.3	↓ B,C	↓	↓
0.4			
0.5	B,C	↓	↓
0.6	B,C,D	↓	↓
0.7	↓ B,C,D	↓	↓
0.8			
0.9	B,C,D	↓	↓

Cap (pF)	Available Tolerance	Size	
		0402	0603
1.0	B,C,D	50V	200V
1.1	↓	↓	↓
1.2			
1.3	↓	↓	↓
1.4			
1.5	↓	↓	↓
1.6			
1.7	↓	↓	↓
1.8			
1.9	↓	↓	↓
2.0			
2.1	↓	↓	↓
2.2			
2.4	↓	↓	↓
2.7			
3.0	↓	↓	↓
3.3			
3.6	↓	↓	↓
3.9			
4.3	↓	↓	↓
4.7			
5.1	↓	↓	↓
5.6			
6.2	B,C,D	↓	↓
6.8	B,C,J,K,M	↓	↓

Cap (pF)	Available Tolerance	Size	
		0402	0603
7.5	B,C,J,K,M	50V	200V
8.2	↓	↓	↓
9.1			
10	B,C,J,K,M	↓	↓
11	↓	↓	↓
12			
13	↓	↓	↓
15			
18	↓	↓	↓
20			
22	↓	↓	↓
24			
27	↓	↓	↓
30			
33	↓	↓	↓
36			
39	↓	↓	↓
43			
47	↓	↓	↓
51			
56	↓	↓	↓
68			
75	↓	↓	↓
82			
91	↓	↓	↓

Cap (pF)	Available Tolerance	Size	
		0402	0603
100	F,G,J,K,M	N/A	100V
110	↓	↓	↓
120			
130	↓	↓	↓
140			
150	↓	↓	↓
160			
180	↓	↓	↓
200			
220	↓	↓	↓
270			
300	↓	↓	↓
330			
360	↓	↓	↓
390			
430	↓	↓	↓
470			
510	↓	↓	↓
560			
620	↓	↓	↓
680			
750	↓	↓	↓
820			
910	↓	↓	↓
1000			

ULTRA LOW ESR, "U" SERIES

TYPICAL ESR vs. FREQUENCY
0402 "U" SERIES

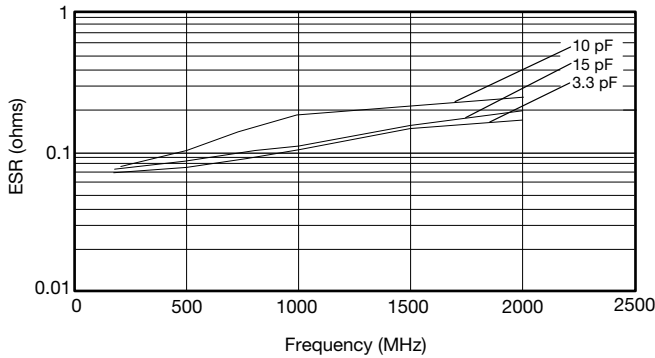

TYPICAL ESR vs. FREQUENCY
0603 "U" SERIES

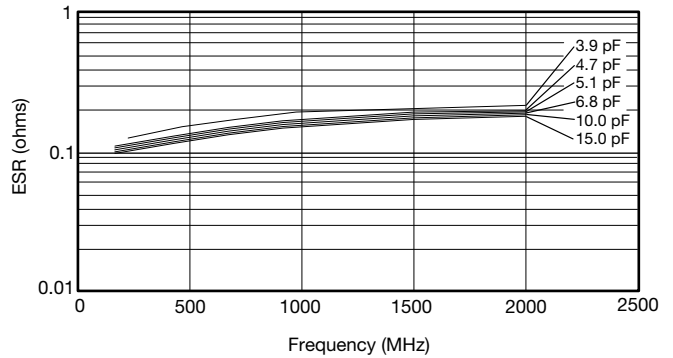

6

RF/Microwave Automotive C0G (NP0) Capacitors (RoHS), AEC Q200 Qualified



Ultra Low ESR, "U" Series, C0G (NP0) Chip Capacitors

TYPICAL
SERIES RESONANT FREQUENCY
"U" SERIES CHIP

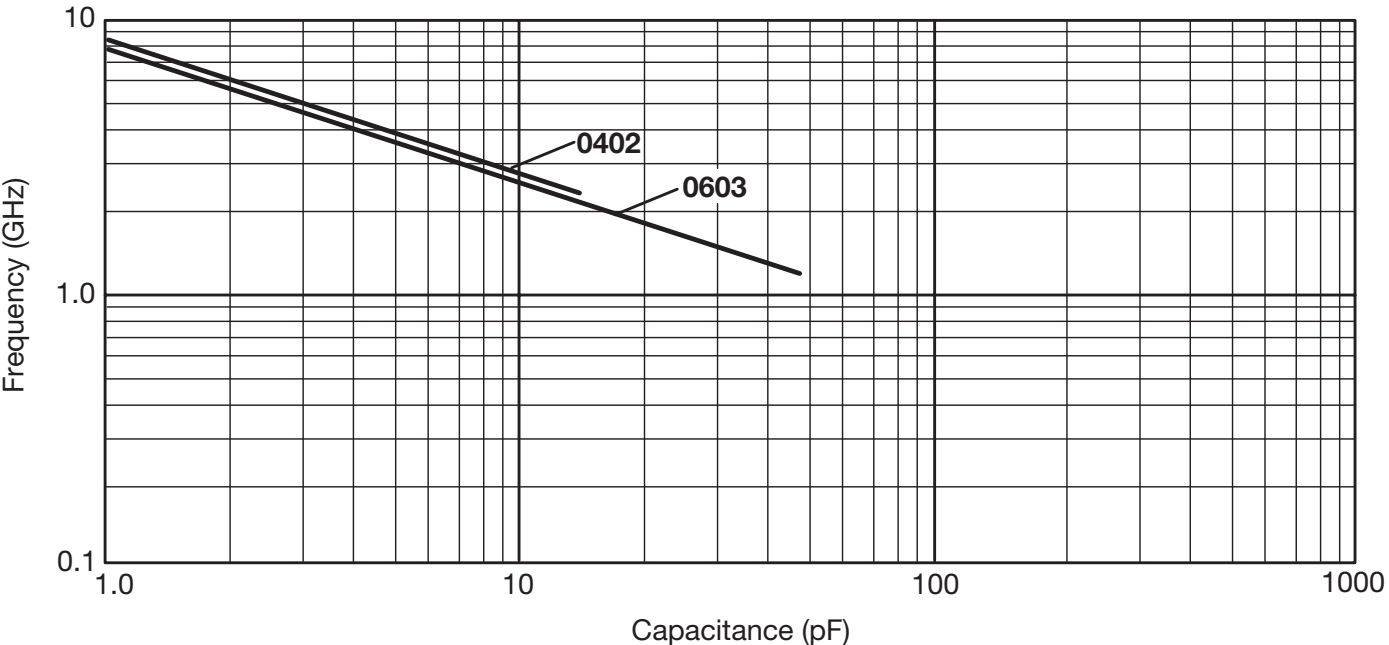

RF/Microwave C0G (NP0) Capacitors (Sn/Pb)



Ultra Low ESR, "U" Series, C0G (NP0) Chip Capacitors

GENERAL INFORMATION

"U" Series capacitors are C0G (NP0) chip capacitors specially designed for "Ultra" low ESR for applications in the communications market. Max ESR and effective capacitance

are met on each value producing lot to lot uniformity. Sizes available are EIA chip sizes 0603, 0805, and 1210.

DIMENSIONS: inches (millimeters)

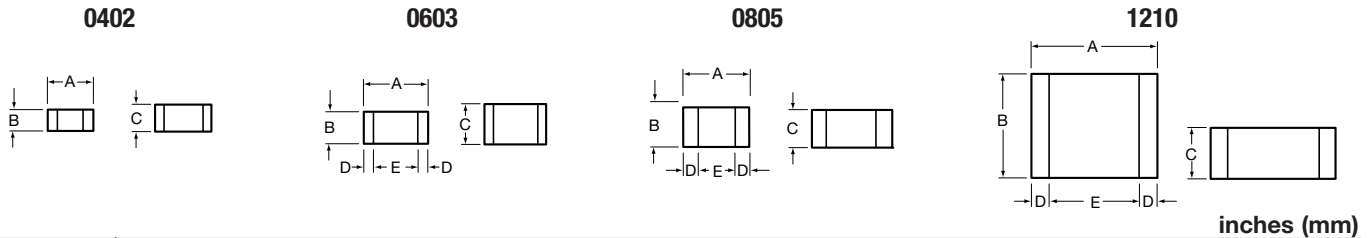

Size	A	B	C	D	E
0402	0.039±0.004 (1.00±0.1)	0.020±0.004 (0.50±0.1)	0.024 (0.6) max	N/A	N/A
0603	0.060±0.010 (1.52±0.25)	0.030±0.010 (0.76±0.25)	0.036 (0.91) max	0.010±0.005 (0.25±0.13)	0.030 (0.76) min
0805	0.079±0.008 (2.01±0.2)	0.049±0.008 (1.25±0.2)	0.040±0.005 (1.02±0.127)	0.020±0.010 (0.51±0.254)	0.020 (0.51) min
1210	0.126±0.008 (3.2±0.2)	0.098±0.008 (2.49±0.2)	0.050±0.005 (1.27±0.127)	0.025±0.015 (0.635±0.381)	0.040 (1.02) min

HOW TO ORDER

LD05 | **1** | **U** | **100** | **J** | **A** | **B** | **2** | **A**

- Case Size**
LD02 = 0402
LD03 = 0603
LD05 = 0805
LD10 = 1210
- Voltage Code**
3 = 25V
5 = 50V
1 = 100V
2 = 200V
- Dielectric = Ultra Low ESR**
- Capacitance**
EIA Capacitance Code in pF.
First two digits = significant figures or "R" for decimal place.
Third digit = number of zeros or after "R" significant figures.
- Capacitance Tolerance Code**
B = ±0.1pF
C = ±0.25pF
D = ±0.5pF
F = ±1%
G = ±2%
J = ±5%
K = ±10%
M = ±20%
- Failure Rate Code**
A = Not Applicable
- Termination**
B = 5% min lead
- Packaging Code**
2 = 7" Reel
4 = 13" Reel
9 = Bulk
- Special Code**
A = Standard

Not RoHS Compliant

ELECTRICAL CHARACTERISTICS

Capacitance Values and Tolerances:

- Size 0402 - 0.2 pF to 22 pF @ 1 MHz
- Size 0603 - 1.0 pF to 100 pF @ 1 MHz
- Size 0805 - 1.6 pF to 160 pF @ 1 MHz
- Size 1210 - 2.4 pF to 1000 pF @ 1 MHz

Temperature Coefficient of Capacitance (TC):

0±30 ppm/°C (-55° to +125°C)

Insulation Resistance (IR):

- 10¹² Ω min. @ 25°C and rated WVDC
- 10¹¹ Ω min. @ 125°C and rated WVDC

Working Voltage (WVDC):

- Size Working Voltage
- 0402 - 50, 25 WVDC
- 0603 - 200, 100, 50 WVDC
- 0805 - 200, 100 WVDC
- 1210 - 200, 100 WVDC

Dielectric Working Voltage (DWV):

250% of rated WVDC

Equivalent Series Resistance Typical (ESR):

- 0402 - See Performance Curve, page 237
- 0603 - See Performance Curve, page 237
- 0805 - See Performance Curve, page 237
- 1210 - See Performance Curve, page 237

Marking: Laser marking EIA J marking standard (except 0603) (capacitance code and tolerance upon request).

MILITARY SPECIFICATIONS

Meets or exceeds the requirements of MIL-C-55681



RF/Microwave C0G (NP0) Capacitors (Sn/Pb)



Ultra Low ESR, "U" Series, C0G (NP0) Chip Capacitors

CAPACITANCE RANGE

Cap (pF)	Available Tolerance	Size			
		LD02	LD03	LD05	LD10
0.2	B,C	50V	N/A	N/A	N/A
0.3					
0.4					
0.5	B,C				
0.6	B,C,D				
0.7					
0.8					
0.9	B,C,D				

Cap (pF)	Available Tolerance	Size			
		LD02	LD03	LD05	LD10
1.0	B,C,D	50V	200V	200V	200V
1.1					
1.2					
1.3					
1.4					
1.5					
1.6					
1.7					
1.8					
1.9					
2.0					
2.1					
2.2					
2.4					
2.7					
3.0					
3.3					
3.6					
3.9					
4.3					
4.7					
5.1					
5.6					
6.2	B,C,D				
6.8	B,C,J,K,M				

Cap (pF)	Available Tolerance	Size			
		LD02	LD03	LD05	LD10
7.5	B,C,J,K,M	50V	200V	200V	200V
8.2					
9.1	B,C,J,K,M				
10	F,G,J,K,M				
11					
12					
13					
15					
18					
20					
22					
24					
27					
30		50V			
33		N/A			
36					
39					
43					
47					
51					
56					
68					
75					
82					
91					

Cap (pF)	Available Tolerance	Size			
		LD02	LD03	LD05	LD10
100	F,G,J,K,M	N/A	100V	200V	200V
110			50V		
120			50V		
130			N/A		
140					
150					
160					
180					
200					
220					
270					
300					
330					
360					
390					
430					
470					
510					
560					
620					
680					
750					
820					
910					
1000	F,G,J,K,M				

ULTRA LOW ESR, "U" SERIES

TYPICAL ESR vs. FREQUENCY
0402 "U" SERIES

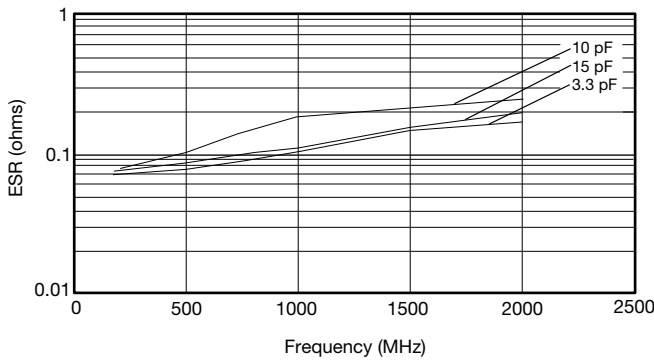

TYPICAL ESR vs. FREQUENCY
0603 "U" SERIES

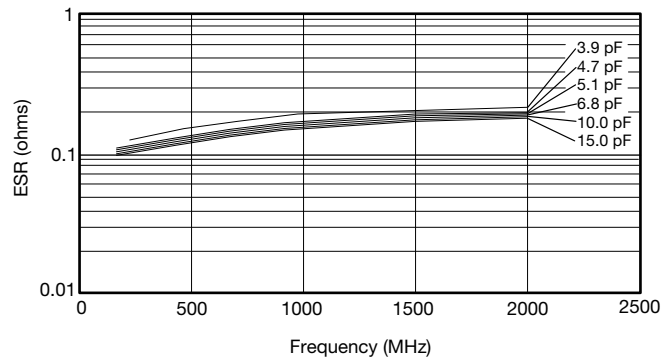

TYPICAL ESR vs. FREQUENCY
0805 "U" SERIES

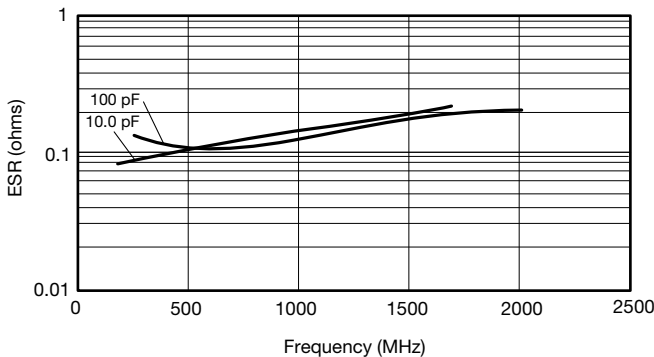

TYPICAL ESR vs. FREQUENCY
1210 "U" SERIES

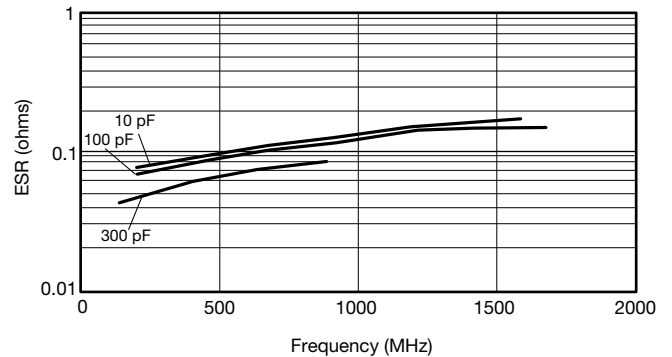

ESR Measured on the Boonton 34A

RF/Microwave C0G (NP0) Capacitors (Sn/Pb)



Ultra Low ESR, "U" Series, C0G (NP0) Chip Capacitors

TYPICAL
SERIES RESONANT FREQUENCY
"U" SERIES CHIP

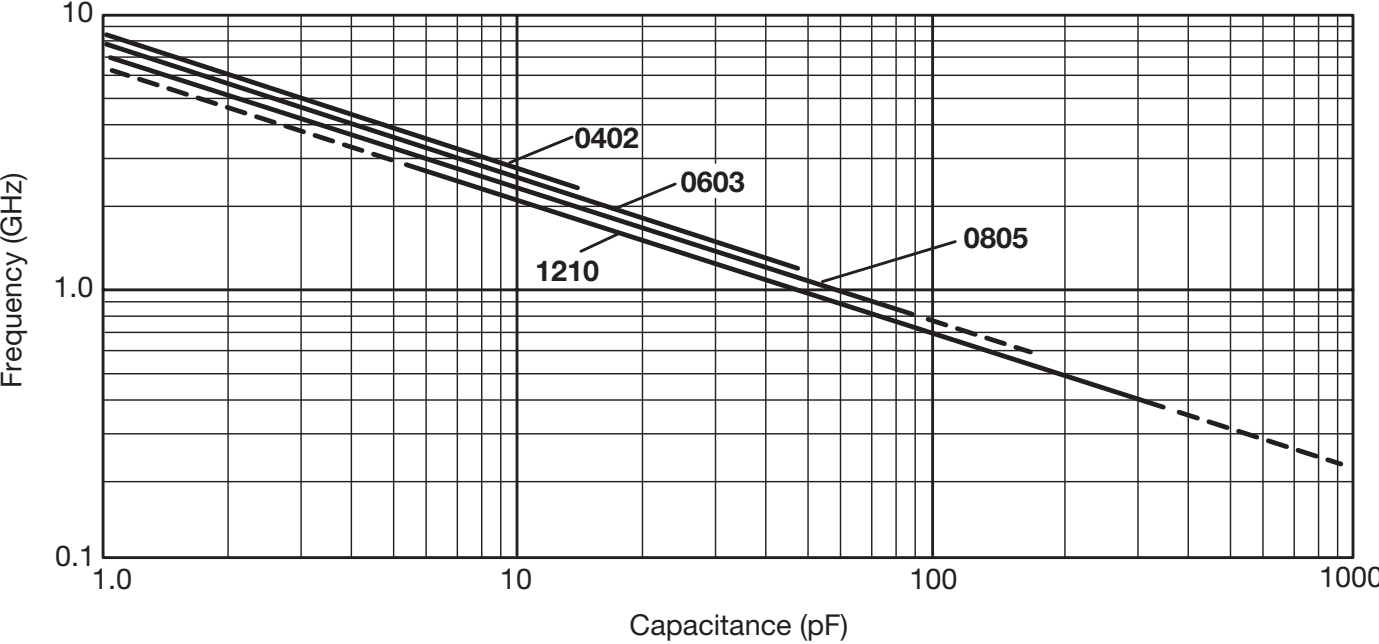

“U” Dielectric Kits

0402

Kit 5000 UZ			
Cap. Value pF	Tolerance	Cap. Value pF	Tolerance
0.5	B ($\pm 0.1\text{pF}$)	4.7	B ($\pm 0.1\text{pF}$)
1.0		5.6	
1.5		6.8	
1.8		8.2	
2.2		10.0	J ($\pm 5\%$)
2.4		12.0	
3.0		15.0	
3.6			

***25 each of 15 values

0603

Kit 4000 UZ			
Cap. Value pF	Tolerance	Cap. Value pF	Tolerance
1.0	B ($\pm 0.1\text{pF}$)	6.8	B ($\pm 0.1\text{pF}$)
1.2		7.5	
1.5		8.2	
1.8		10.0	J ($\pm 5\%$)
2.0		12.0	
2.4		15.0	
2.7		18.0	
3.0		22.0	
3.3		27.0	
3.9		33.0	
4.7		39.0	
5.6		47.0	

***25 each of 24 values

0805

Kit 3000 UZ				
Cap. Value pF	Tolerance	Cap. Value pF	Tolerance	
1.0	B ($\pm 0.1\text{pF}$)	15.0	J ($\pm 5\%$)	
1.5		18.0		
2.2		22.0		
2.4		24.0		
2.7		27.0		
3.0		33.0		
3.3		36.0		
3.9		39.0		
4.7		47.0		
5.6		56.0		
7.5		68.0		
8.2		82.0		
9.1		100.0		
10.0		J ($\pm 5\%$)		130.0
12.0				160.0

***25 each of 30 values

1210

Kit 3500 UZ			
Cap. Value pF	Tolerance	Cap. Value pF	Tolerance
2.2	B ($\pm 0.1\text{pF}$)	36.0	J ($\pm 5\%$)
2.7		39.0	
4.7		47.0	
5.1		51.0	
6.8		56.0	
8.2		68.0	
9.1		82.0	
10.0		J ($\pm 5\%$)	
13.0	120.0		
15.0	130.0		
18.0	240.0		
20.0	300.0		
24.0	390.0		
27.0	470.0		
30.0	680.0		

***25 each of 30 values

SOLUTIONS ACROSS THE BOARD

Capacitors

Advanced Power Film
Ceramic
Disc
Film
Glass
High Voltage
Leaded / Through Hole
Low ESR
Low Inductance
Military / Aerospace
MLCC Array
MOS / MIS
Niobium Oxide* (OxiCap®)
RF / Microwave
(Power, Hi Q, Thin-Film)
Single Layer (SLC)
SMPS (Power Supply)
Stacked Ceramic
Supercapacitor (BestCap™)
Tantalum
Tantalum Polymer
Trimmer

Circuit Protection

Fuses (Thin-Film)
MLV (TransGuard™)
MLV Array (MultiGuard™)
NTC Thermistors
Transient Voltage Suppressors
Zinc Oxide Varistors

Filters

EMI (Bolt-In and SMD)
EMI / TVS Filter
Feedthrough
High Current Feedthrough
Low Pass (Thin-Film)
SAW

RF / Microwave

Capacitors
Couplers
Inductors
PMC Custom Filters
Modules
Timing Devices
Passive Micro Components (PMC)
Diplexers
Crossovers

Integrated Passives

IDC (Low Inductance Array)
Passive Thick Film Array
Passive Micro Components (PMC)

Module Devices

Antenna Switch
Bluetooth
LTCC
GPS
RX Module
WLAN Module

Piezo

Acoustic Devices
Actuators

Timing Devices

Ceramic Resonator
Clock Oscillator
Crystal Applied Product
MHz Crystal
SAW Resonator
TCXO

Connectors

2mm Hard Metric
Automotive – Custom
Battery
Board to Board
 1 piece Compression
 2 piece Microleaf
Card Edge
DIN41612
FFC / FPC
IDC
Memory Connectors
 PCMCIA Kits
 Compact Flash
 SO-DIMM
 SIMM / RUM
 SDIO / SD
Military
PCI Express
Varicon Rack and Panel

**For more information please visit
our website at
<http://www.avx.com>**

NOTICE: Specifications are subject to change without notice. Contact your nearest AVX Sales Office for the latest specifications. All statements, information and data given herein are believed to be accurate and reliable, but are presented without guarantee, warranty, or responsibility of any kind, expressed or implied. Statements or suggestions concerning possible use of our products are made without representation or warranty that any such use is free of patent infringement and are not recommendations to infringe any patent. The user should not assume that all safety measures are indicated or that other measures may not be required. Specifications are typical and may not apply to all applications.

© AVX Corporation

AMERICAS

AVX Greenville, SC
Tel: 864-967-2150

EUROPE

AVX Limited, England
Tel: +44-1276-697000

AVX S.A.S., France
Tel: +33-1-69-18-46-00

AVX GmbH, Germany
Tel: +49-0811-95949-0

AVX SRL, Italy
Tel: +39-02-614-571

AVX Czech Republic
Tel: +420-57-57-57-521

AVX/ELCO UK
Tel: +44-1638-675000

ELCO Europe GmbH
Tel: +49-2741-299-0

AVX S.A., Spain
Tel: +34-91-63-97-197

AVX Benelux
Tel: +31-187-489-337

ASIA-PACIFIC

**AVX/Kyocera (S) Pte Ltd.,
Singapore**
Tel: +65-6286-7555

**AVX/Kyocera, Asia, Ltd.,
Hong Kong**
Tel: +852-2363-3303

**AVX/Kyocera Yuhan Hoesa,
South Korea**
Tel: +82-2785-6504

**AVX/Kyocera HK Ltd.,
Taiwan**
Tel: +886-2-2656-0258

**AVX/Kyocera (M) Sdn Bhd,
Malaysia**
Tel: +60-4228-1190

**AVX/Kyocera International
Trading Co. Ltd.,
Shanghai**
Tel: +86-21-3255 1933

**AVX/Kyocera Asia Ltd.,
Shenzen**
Tel: +86-755-3336-0615

**AVX/Kyocera International
Trading Co. Ltd.,
Beijing**
Tel: +86-10-6588-3528

**AVX/Kyocera India
Liaison Office**
Tel: +91-80-6450-0715

ASIA-KED

(KYOCERA Electronic Devices)

KED Hong Kong Ltd.
Tel: +852-2305-1080/1223

**KED Hong Kong Ltd.
Shenzen**
Tel: +86-755-3398-9600

**KED Company Ltd.
Shanghai**
Tel: +86-21-3255-1833

**KED Hong Kong Ltd.
Beijing**
Tel: +86-10-5869-4655

KED Taiwan Ltd.
Tel: +886-2-2950-0268

**KED Korea Yuhan Hoesa,
South Korea**
Tel: +82-2-783-3604/6126

**KED (S) Pte Ltd.
Singapore**
Tel: +65-6509-0328

**Kyocera Corporation
Japan**
Tel: +81-75-604-3449

Contact:



<http://www.avx.com>

S-RFMTF0M416-C



Стандарт Электрон Связь

Мы молодая и активно развивающаяся компания в области поставок электронных компонентов. Мы поставляем электронные компоненты отечественного и импортного производства напрямую от производителей и с крупнейших складов мира.

Благодаря сотрудничеству с мировыми поставщиками мы осуществляем комплексные и плановые поставки широчайшего спектра электронных компонентов.

Собственная эффективная логистика и склад в обеспечивает надежную поставку продукции в точно указанные сроки по всей России.

Мы осуществляем техническую поддержку нашим клиентам и предпродажную проверку качества продукции. На все поставляемые продукты мы предоставляем гарантию .

Осуществляем поставки продукции под контролем ВП МО РФ на предприятия военно-промышленного комплекса России , а также работаем в рамках 275 ФЗ с открытием отдельных счетов в уполномоченном банке. Система менеджмента качества компании соответствует требованиям ГОСТ ISO 9001.

Минимальные сроки поставки, гибкие цены, неограниченный ассортимент и индивидуальный подход к клиентам являются основой для выстраивания долгосрочного и эффективного сотрудничества с предприятиями радиоэлектронной промышленности, предприятиями ВПК и научно-исследовательскими институтами России.

С нами вы становитесь еще успешнее!

Наши контакты:

Телефон: +7 812 627 14 35

Электронная почта: sales@st-electron.ru

Адрес: 198099, Санкт-Петербург,
Промышленная ул, дом № 19, литера Н,
помещение 100-Н Офис 331