

# 40V, Low Quiescent Current, 50mA Linear Regulator for Automotive Applications

## ISL78307

The ISL78307 is a high voltage, low quiescent current linear regulator ideally suited for “always-on” and “keep alive” automotive applications. The ISL78307 operates from an input voltage of +6V to +40V under normal operating conditions and operates down to +3V under a cold crank. It consumes only 18µA of quiescent current at no load on the adjustable version.

The ISL78307 is available in fixed 3.3V, 5V and adjustable output voltage (2.5V to 12V) options. It features an EN pin that can be used to put the device into a low-quiescent current shutdown mode where it draws only 1.8µA of supply current. The device features over-temperature shutdown and current limit protection.

The ISL78307 is AEC-Q100 qualified. It is rated over the -40°C to +125°C automotive temperature range and is available in an 8 Ld EPSOIC with exposed pad package.

## Applications

- Automotive
- Industrial
- Telecom

## Features

- Optimized for “always-on” automotive applications
- 18µA typical quiescent current
- Guaranteed 50mA output current
- Operates through cold crank down to 3V
- 40V tolerant logic level (TTL/CMOS) enable input
- 1.8µA of typical shutdown current
- Low dropout voltage of 120mV at 50mA
- Fixed +3.3V, +5.0V and adjustable output voltage options
- Stable operation with 10µF output capacitor
- Thermal shutdown and current limit protection
- -40°C to +125°C operating temperature range
- Thermally enhanced 8 Ld exposed pad SOIC package
- AEC-Q100 qualified
- 6kV ESD HBM rated
- Pb-free (RoHS compliant)

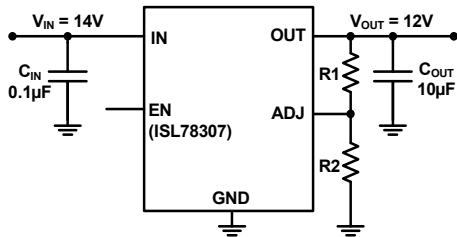

FIGURE 1. TYPICAL APPLICATION - ADJ VERSION

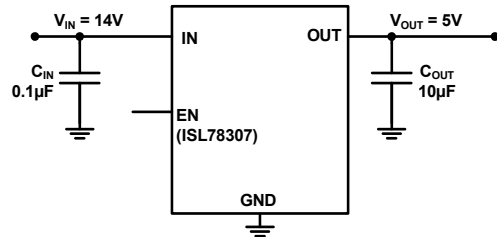

FIGURE 2. TYPICAL APPLICATION - FIXED VERSION

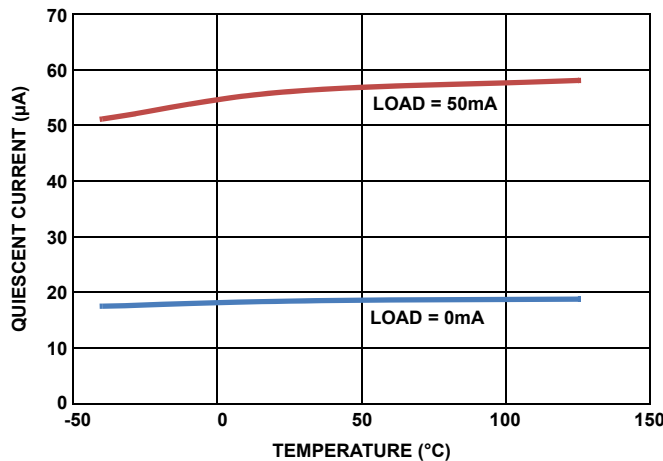
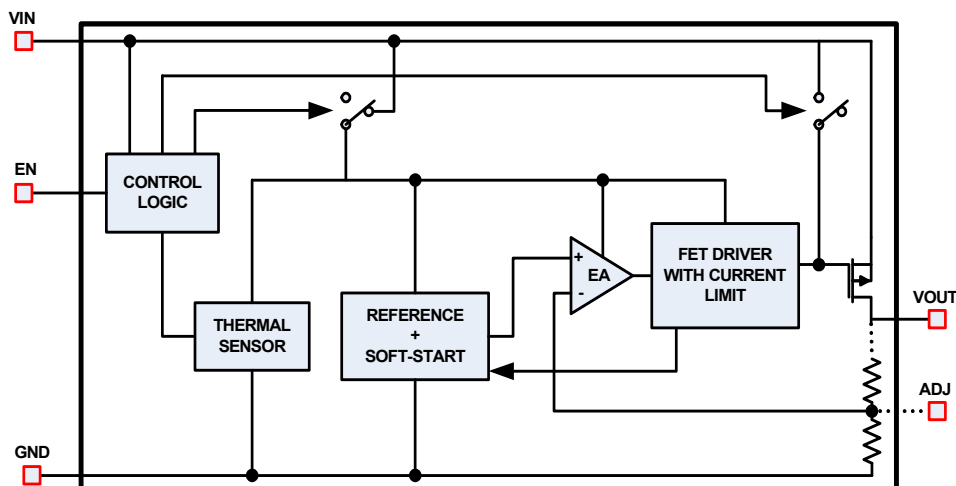

FIGURE 3. QUIESCENT CURRENT vs LOAD CURRENT (ADJ VERSION AT UNITY GAIN).  $V_{IN} = 14V$

# ISL78307

## Block Diagram



## Pin Configuration

ISL78307  
(8 LD EPSON)  
TOP VIEW

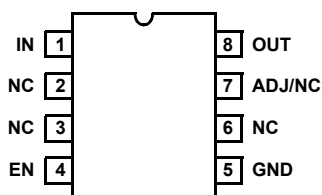

## Pin Descriptions

PIN NUMBER	PIN NAME	DESCRIPTION
1	IN	Input voltage pin. A minimum 0.1 $\mu$ F X5R/X7R capacitor is required for proper operation.
2, 3, 6	NC	Pins have internal termination and can be left unconnected. Connection to ground is optional.
4	EN	High on this pin enables the device.
5	GND	Ground pin.
7	ADJ/NC	In the adjustable output voltage option, this pin is connected to the external feedback resistor divider which sets the LDO output voltage. In the 3.3V and 5V options, this pin is not used and can be connected to ground.
8	OUT	Regulated output voltage. A 10 $\mu$ F X5R/X7R output capacitor is required for stability.
	EPAD	It is recommended to solder the EPAD to the ground plane.

## Ordering Information

PART NUMBER (Notes 1, 2, 3)	PART MARKING	TEMP. RANGE (°C)	ENABLE PIN	OUTPUT VOLTAGE (V)	PACKAGE (Pb-Free)	PKG. DWG. #
ISL78307FBEAZ	78307 FBEAZ	-40 to +125	Yes	3.3	8 Ld EPSON	M8.15B
ISL78307FBEBZ	78307 FBEBZ	-40 to +125	Yes	5.0	8 Ld EPSON	M8.15B
ISL78307FBECZ	78307 FBECZ	-40 to +125	Yes	ADJ	8 Ld EPSON	M8.15B

### NOTES:

1. Add "-T\*" suffix for tape and reel. Please refer to [TB347](#) for details on reel specifications.
2. These Intersil Pb-free plastic packaged products employ special Pb-free material sets, molding compounds/die attach materials, and 100% matte tin plate plus anneal (e3 termination finish, which is RoHS compliant and compatible with both SnPb and Pb-free soldering operations). Intersil Pb-free products are MSL classified at Pb-free peak reflow temperatures that meet or exceed the Pb-free requirements of IPC/JEDEC J STD-020.
3. For Moisture Sensitivity Level (MSL), please see device information page for [ISL78307](#). For more information on MSL please see techbrief [TB363](#).

# ISL78307

## Absolute Maximum Ratings

Supply Voltage, VCC	+45V
IN pin to GND Voltage	GND - 0.3V to VCC
OUT pin to GND Voltage	GND - 0.3V to 16V
EN pin to GND Voltage	GND - 0.3V to VCC
Output Short-circuit Duration	Indefinite
ESD Rating	
Human Body Model (Tested per JESD22-A114E)	6kV
Machine Model (Tested per JESD-A115-A)	350V
Charge Device Model (Tested per AEC-Q100-011)	2.2kV
Latch Up (Tested per JESD78B; Class II, Level A)	100mA

## Thermal Information

Thermal Resistance (Typical)	$\theta_{JA}$ (°C/W)	$\theta_{JC}$ (°C/W)
8 Ld EPSON Package (Notes 4, 5)	50	9
Maximum Junction Temperature	+150°C	
Maximum Storage Temperature Range	-65°C to +175°C	
Pb-Free Reflow Profile	see <a href="#">TB493</a>	

## Recommended Operating Conditions

Ambient Temperature Range	-40°C to +125°C
IN pin to GND Voltage	+3V to +40V
OUT pin to GND Voltage	+2.5V to +12V
EN pin to GND Voltage	.0V to +40V

**CAUTION:** Do not operate at or near the maximum ratings listed for extended periods of time. Exposure to such conditions may adversely impact product reliability and result in failures not covered by warranty.

### NOTES:

- $\theta_{JA}$  is measured in free air with the component mounted on a high effective thermal conductivity test board with "direct attach" features. See Tech Brief [TB379](#).
- For  $\theta_{JC}$ , the "case temp" location is the center of the exposed metal pad on the package underside.

**Electrical Specifications** Recommended Operating Conditions, unless otherwise noted.  $V_{IN} = 14V$ ,  $I_{OUT} = 1mA$ ,  $C_{IN} = 0.1\mu F$ ,  $C_{OUT} = 10\mu F$ ,  $T_A = T_J = -40^\circ C$  to  $+125^\circ C$ , unless otherwise noted. Typical specifications are at  $T_A = +25^\circ C$ . **Boldface limits apply across the operating temperature range, -40°C to +125°C.**

PARAMETER	SYMBOL	TEST CONDITIONS	MIN (Note 8)	TYP	MAX (Note 8)	UNIT	
Input Voltage Range	$V_{IN}$		<b>6</b>		<b>40</b>	V	
		Cold Crank condition	<b>3</b>		<b>40</b>	V	
Guaranteed Output Current	$I_{OUT}$	$V_{IN} = V_{OUT} + V_{DO}$	<b>50</b>			mA	
Output Voltage	$V_{OUT}$	EN = High $V_{IN} = 14V$ $I_{OUT} = 0.1mA$	3.3V Version	<b>3.267</b>	3.3	<b>3.333</b>	V
			5V Version	<b>4.950</b>	5	<b>5.050</b>	V
			ADJ pin voltage	<b>1.211</b>	1.223	<b>1.235</b>	V
Line Regulation	$\Delta V_{OUT}/\Delta V_{IN}$	$3V \leq V_{IN} \leq 40V$ $I_{OUT} = 1mA$		0.04	<b>0.115</b>	%	
Load Regulation	$\Delta V_{OUT}/\Delta I_{OUT}$	$V_{IN} = V_{OUT} + V_{DO}$ $I_{OUT} = 100\mu A$ to 50mA		0.25	<b>0.5</b>	%	
Dropout Voltage (Note 6)	$\Delta V_{DO}$	$I_{OUT} = 1mA$ , $V_{OUT} = 3.3V$		10	<b>38</b>	mV	
		$I_{OUT} = 50mA$ , $V_{OUT} = 3.3V$		130	<b>340</b>	mV	
		$I_{OUT} = 1mA$ , $V_{OUT} = 5V$		10	<b>48</b>	mV	
		$I_{OUT} = 50mA$ , $V_{OUT} = 5V$		120	<b>350</b>	mV	
Shutdown Current	$I_{SHDN}$	EN = LOW		1.8	<b>3.64</b>	$\mu A$	
Quiescent Current	IQ	EN = High $V_{IN} = 14V$	$I_{OUT} = 0mA$ , ADJ Version, $V_{OUT} = V_{ADJ}$		18	<b>24</b>	$\mu A$
			$I_{OUT} = 1mA$ , ADJ Version, $V_{OUT} = V_{ADJ}$		22	<b>42</b>	$\mu A$
			$I_{OUT} = 10mA$ , ADJ Version, $V_{OUT} = V_{ADJ}$		34	<b>60</b>	$\mu A$
			$I_{OUT} = 50mA$ , ADJ Version, $V_{OUT} = V_{ADJ}$		56	<b>82</b>	$\mu A$
			$I_{OUT} = 0$ , 3.3V and 5.0V Version		22	<b>28</b>	$\mu A$
			$I_{OUT} = 1mA$ , 3.3V and 5.0V Version		27	<b>45</b>	$\mu A$
			$I_{OUT} = 10mA$ , 3.3V and 5.0V Version		37	<b>65</b>	$\mu A$
			$I_{OUT} = 50mA$ , 3.3V and 5.0V Version		62	<b>90</b>	$\mu A$

# ISL78307

**Electrical Specifications** Recommended Operating Conditions, unless otherwise noted.  $V_{IN} = 14V$ ,  $I_{OUT} = 1mA$ ,  $C_{IN} = 0.1\mu F$ ,  $C_{OUT} = 10\mu F$ ,  $T_A = T_J = -40^\circ C$  to  $+125^\circ C$ , unless otherwise noted. Typical specifications are at  $T_A = +25^\circ C$ . **Boldface limits apply across the operating temperature range,  $-40^\circ C$  to  $+125^\circ C$ .** (Continued)

PARAMETER	SYMBOL	TEST CONDITIONS	MIN (Note 8)	TYP	MAX (Note 8)	UNIT
Power Supply Rejection Ratio	PSRR	$f = 100Hz$ ; $V_{in\_ripple} = 500mV_{P,P}$ ; Load = 50mA		58		dB
<b>EN FUNCTION</b>						
EN Threshold Voltage	$V_{EN\_H}$	$V_{OUT} = \text{Off to On}$			<b>1.485</b>	V
	$V_{EN\_L}$	$V_{OUT} = \text{On to Off}$	<b>0.935</b>			V
EN Pin Current	$I_{EN}$	$V_{OUT} = 0V$		0.026		$\mu A$
EN to Regulation Time (Note 7)	$t_{EN}$			1.65	<b>1.93</b>	ms
<b>PROTECTION FEATURES</b>						
Output Current Limit	$I_{LIMIT}$	$V_{OUT} = 0V$	<b>60</b>	118		mA
Thermal Shutdown	$T_{SHDN}$	Junction Temperature Rising		+165		$^\circ C$
Thermal Shutdown Hysteresis	$T_{HYST}$			+20		$^\circ C$

**NOTES:**

- Dropout voltage is defined as  $(V_{IN} - V_{OUT})$  when  $V_{OUT}$  is 2% below the value of  $V_{OUT}$  when  $V_{IN} = V_{OUT} + 3V$ .
- Enable to Regulation is the time the output takes to reach 95% of its final value with  $V_{IN} = 14V$  and EN is taken from  $V_{IL}$  to  $V_{IH}$  in 5ns. For the adjustable versions, the output voltage is set at 5V.
- Parameters with MIN and/or MAX limits are 100% tested at  $+25^\circ C$ , unless otherwise specified. Temperature limits established by characterization and are not production tested.

## Typical Performance Curves $V_{IN} = 14V, I_{OUT} = 1mA, V_{OUT} = 5V, T_J = +25^\circ C$ unless otherwise specified.

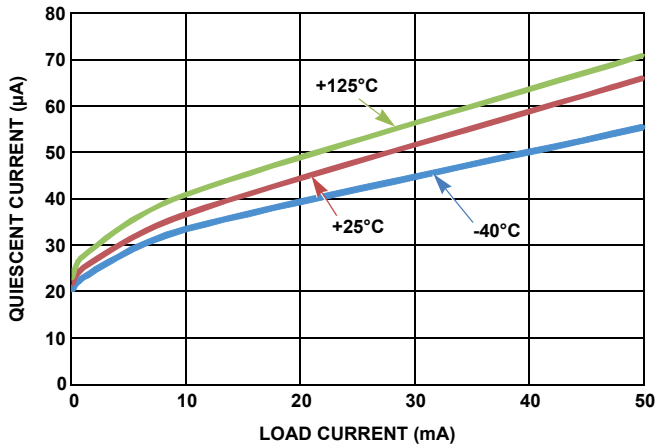

FIGURE 4. QUIESCENT CURRENT vs LOAD CURRENT

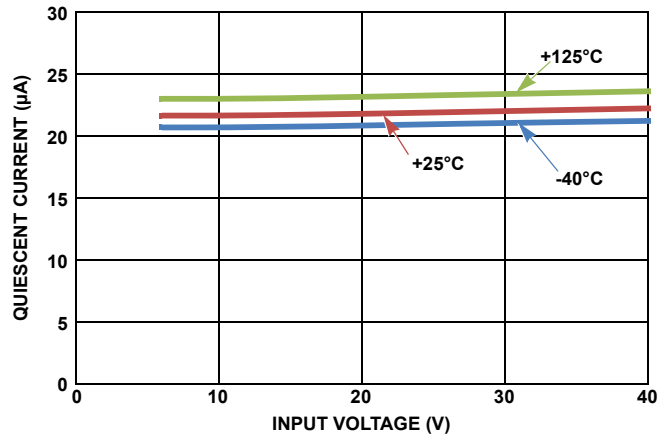

FIGURE 5. QUIESCENT CURRENT vs INPUT VOLTAGE (NO LOAD)

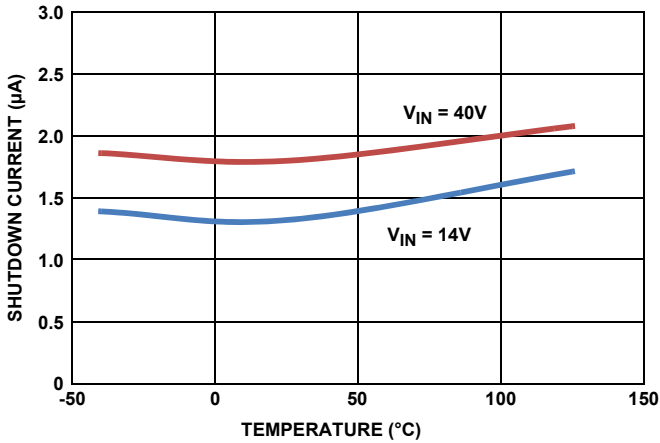

FIGURE 6. SHUTDOWN CURRENT vs TEMPERATURE (EN = 0)

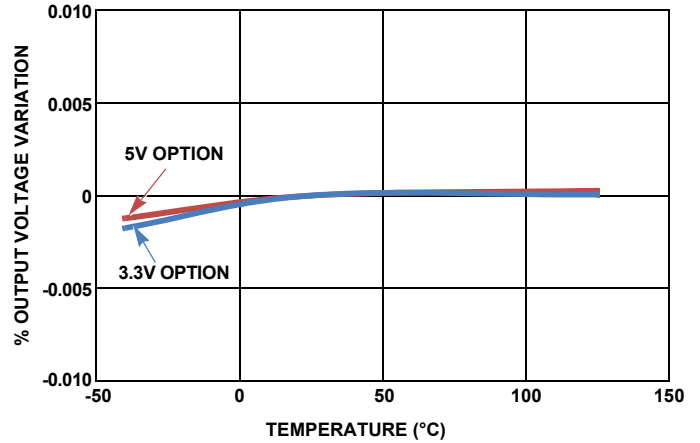

FIGURE 7. OUTPUT VOLTAGE vs TEMPERATURE (LOAD = 50mA)

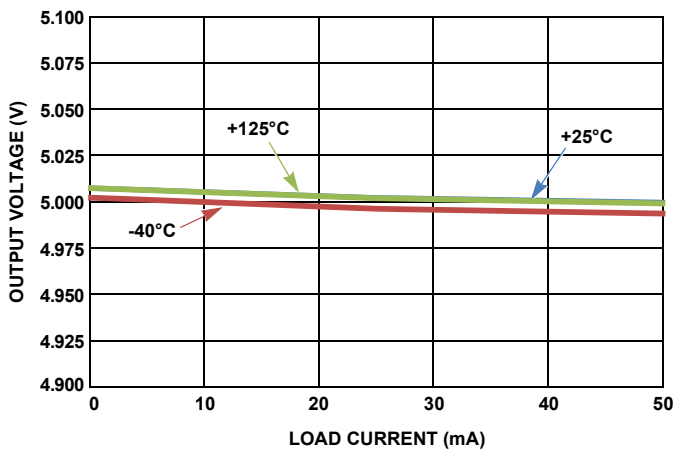

FIGURE 8. OUTPUT VOLTAGE vs LOAD CURRENT

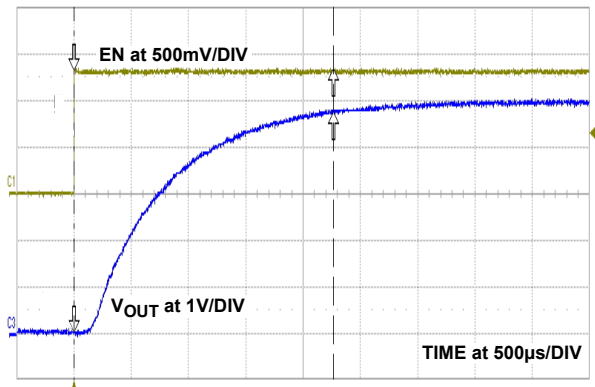

FIGURE 9. START-UP WAVEFORM

**Typical Performance Curves**  $V_{IN} = 14V$ ,  $I_{OUT} = 1mA$ ,  $V_{OUT} = 5V$ ,  $T_J = +25^\circ C$  unless otherwise specified. (Continued)

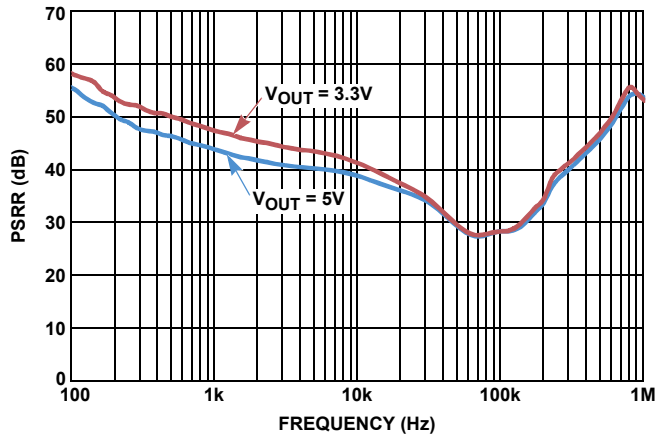

FIGURE 10. POWER SUPPLY REJECTION RATIO (LOAD = 50mA)

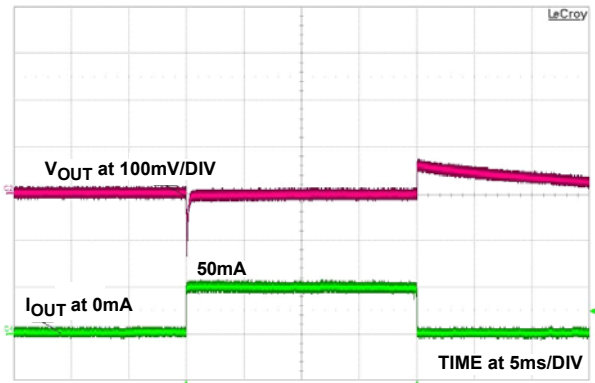

FIGURE 11. LOAD TRANSIENT RESPONSE

## Functional Description

### Functional Overview

The ISL78307 is a high performance, high voltage, low-dropout regulator (LDO) with 50mA sourcing capability. The part is qualified to operate over the -40 °C to +125 °C automotive temperature range. Featuring ultra-low quiescent current, it makes an ideal choice for “always-on” automotive applications. It works well under a “load-dump condition” where the input voltage could rise up to 40V. The LDO continues to operate down to 3V under a “cold-crank” condition. The device also features current limit and thermal shutdown protection.

### Enable Control

The ISL78307 features an enable pin. When it is pulled low, the IC goes to a shutdown mode. In this condition, the device draws less than 2µA. Driving the pin high turns the device on.

### Current Limit Protection

The ISL78307 has internal current limit functionality to protect the regulator during fault conditions. During current limit, the output sources a fixed amount of current largely independent of the output voltage. If the short or overload is removed from V<sub>OUT</sub>, the output returns to normal voltage regulation mode.

### Thermal Fault Protection

In the event the die temperature exceeds typically +165 °C, the output of the LDO will shut down until the die temperature cools down to typically +145 °C. The level of power dissipated, combined with the ambient temperature and the thermal impedance of the package, will determine if the junction temperature exceeds the thermal shutdown temperature. See section on “[Power Dissipation](#)”.

## Application Information

### Input and Output Capacitors

For the output, a ceramic capacitor (X5R or X7R) with a capacitance of 10µF is recommended for the ISL78307 to maintain stability. The ground connection of the output capacitor should be routed directly to the GND pin of the device and also placed close to the IC. A minimum of 0.1µF (X5R or X7R) is recommended at the input.

### Output Voltage Setting

For the adjustable version of the ISL78307, the output voltage is programmed using an external resistor divider as shown in [Figure 12](#).

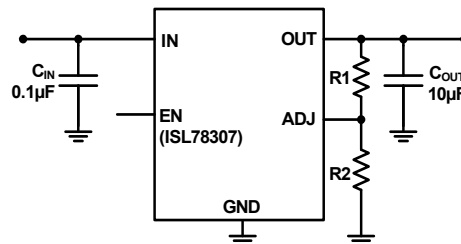

FIGURE 12. ADJUSTABLE VERSION

The output voltage is calculated using [Equation 1](#):

$$V_{OUT} = 1.223V \times \left( \frac{R_1}{R_2} + 1 \right) \quad (\text{EQ. 1})$$

### Power Dissipation

The junction temperature must not exceed the range specified in “[Recommended Operating Conditions](#)” on [page 3](#). The power dissipation can be calculated using [Equation 2](#):

$$P_D = (V_{IN} - V_{OUT}) \times I_{OUT} + V_{IN} \times I_{GND} \quad (\text{EQ. 2})$$

The maximum allowable junction temperature, T<sub>J(MAX)</sub> and the maximum expected ambient temperature, T<sub>A(MAX)</sub> will determine the maximum allowable junction temperature rise (ΔT<sub>J</sub>), as shown in [Equation 3](#):

$$\Delta T_J = T_{J(MAX)} - T_{A(MAX)} \quad (\text{EQ. 3})$$

To calculate the maximum ambient operating temperature, use the junction-to-ambient thermal resistance (θ<sub>JA</sub>) as shown in [Equation 4](#):

$$T_{J(MAX)} = P_{D(MAX)} \times \theta_{JA} + T_A \quad (\text{EQ. 4})$$

### Board Layout Recommendations

A good PCB layout is important to achieve expected performance. Consideration should be taken when placing the components and routing the trace to minimize the ground impedance, and keep the parasitic inductance low. The input and output capacitors should have a good ground connection and be placed as close to the IC as possible. The feedback trace in the adjustable version should be away from other noisy traces. Connect EPAD to the ground plane for better heat dissipation. Thermal vias on the EPAD increase heat dissipation.

## Revision History

The revision history provided is for informational purposes only and is believed to be accurate, but not warranted. Please go to web to make sure you have the latest Rev.

DATE	REVISION	CHANGE
April 7, 2015	FN6705.2	<a href="#">"Absolute Maximum Ratings" on page 3</a> , Charged device Model(tested per JESD22-C101C)....2.2kV to Charged device Model(tested per AEC-Q100-011).....2.2kV
December 7, 2013	FN7658.2	Page 9 - 2nd line of the disclaimer changed from: "Intersil products are manufactured, assembled and tested utilizing ISO9001 quality systems as noted" to: "Intersil Automotive Qualified products are manufactured, assembled and tested utilizing TS16949 quality systems as noted".
May 13, 2011	FN7658.1	Page 4, Removed the EN Pin Current MAX spec; added TYP spec of 0.026.

## About Intersil

Intersil Corporation is a leading provider of innovative power management and precision analog solutions. The company's products address some of the largest markets within the industrial and infrastructure, mobile computing and high-end consumer markets.

For the most updated datasheet, application notes, related documentation and related parts, please see the respective product information page found at [www.intersil.com](http://www.intersil.com).

You may report errors or suggestions for improving this datasheet by visiting [www.intersil.com/ask](http://www.intersil.com/ask).

Reliability reports are also available from our website at [www.intersil.com/support](http://www.intersil.com/support)



# ISL78307

## Small Outline Exposed Pad Plastic Packages (EPSONIC)

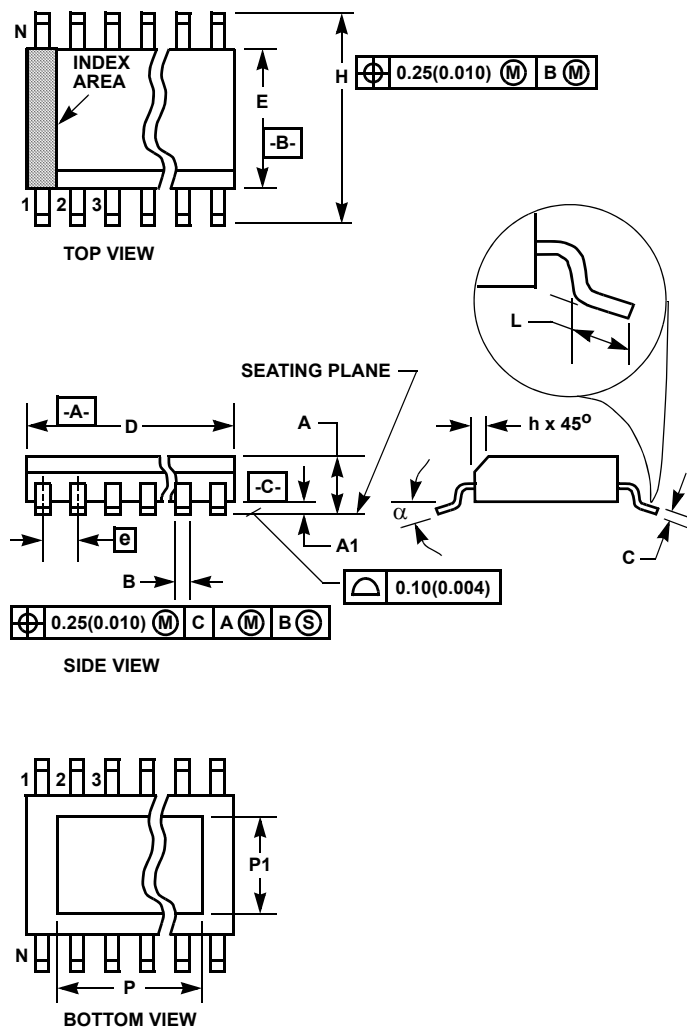

**M8.15B**  
8 LEAD NARROW BODY SMALL OUTLINE EXPOSED PAD  
PLASTIC PACKAGE

SYMBOL	INCHES		MILLIMETERS		NOTES
	MIN	MAX	MIN	MAX	
A	0.056	0.066	1.43	1.68	-
A1	0.001	0.005	0.03	0.13	-
B	0.0138	0.0192	0.35	0.49	9
C	0.0075	0.0098	0.19	0.25	-
D	0.189	0.196	4.80	4.98	3
E	0.150	0.157	3.81	3.99	4
e	0.050 BSC		1.27 BSC		-
H	0.230	0.244	5.84	6.20	-
h	0.010	0.016	0.25	0.41	5
L	0.016	0.035	0.41	0.89	6
N	8		8		7
α	0°	8°	0°	8°	-
P	-	0.094	-	2.387	11
P1	-	0.094	-	2.387	11

Rev. 5 8/10

**NOTES:**

- Symbols are defined in the "MO Series Symbol List" in Section 2.2 of Publication Number 95.
- Dimensioning and tolerancing per ANSI Y14.5M-1982.
- Dimension "D" does not include mold flash, protrusions or gate burrs. Mold flash, protrusion and gate burrs shall not exceed 0.15mm (0.006 inch) per side.
- Dimension "E" does not include interlead flash or protrusions. Interlead flash and protrusions shall not exceed 0.25mm (0.010 inch) per side.
- The chamfer on the body is optional. If it is not present, a visual index feature must be located within the crosshatched area.
- "L" is the length of terminal for soldering to a substrate.
- "N" is the number of terminal positions.
- Terminal numbers are shown for reference only.
- The lead width "B", as measured 0.36mm (0.014 inch) or greater above the seating plane, shall not exceed a maximum value of 0.61mm (0.024 inch).
- Controlling dimension: INCH. Converted millimeter dimensions are not necessarily exact.
- Dimensions "P" and "P1" are thermal and/or electrical enhanced variations. Values shown are maximum size of exposed pad within lead count and body size.

For additional products, see [www.intersil.com/en/products.html](http://www.intersil.com/en/products.html)

Intersil Automotive Qualified products are manufactured, assembled and tested utilizing TS16949 quality systems as noted in the quality certifications found at [www.intersil.com/en/support/qualandreliability.html](http://www.intersil.com/en/support/qualandreliability.html)

Intersil products are sold by description only. Intersil Corporation reserves the right to make changes in circuit design, software and/or specifications at any time without notice. Accordingly, the reader is cautioned to verify that data sheets are current before placing orders. Information furnished by Intersil is believed to be accurate and reliable. However, no responsibility is assumed by Intersil or its subsidiaries for its use; nor for any infringements of patents or other rights of third parties which may result from its use. No license is granted by implication or otherwise under any patent or patent rights of Intersil or its subsidiaries.

For information regarding Intersil Corporation and its products, see [www.intersil.com](http://www.intersil.com)



## Стандарт Электрон Связь

Мы молодая и активно развивающаяся компания в области поставок электронных компонентов. Мы поставляем электронные компоненты отечественного и импортного производства напрямую от производителей и с крупнейших складов мира.

Благодаря сотрудничеству с мировыми поставщиками мы осуществляем комплексные и плановые поставки широчайшего спектра электронных компонентов.

Собственная эффективная логистика и склад в обеспечивает надежную поставку продукции в точно указанные сроки по всей России.

Мы осуществляем техническую поддержку нашим клиентам и предпродажную проверку качества продукции. На все поставляемые продукты мы предоставляем гарантию .

Осуществляем поставки продукции под контролем ВП МО РФ на предприятия военно-промышленного комплекса России , а также работаем в рамках 275 ФЗ с открытием отдельных счетов в уполномоченном банке. Система менеджмента качества компании соответствует требованиям ГОСТ ISO 9001.

Минимальные сроки поставки, гибкие цены, неограниченный ассортимент и индивидуальный подход к клиентам являются основой для выстраивания долгосрочного и эффективного сотрудничества с предприятиями радиоэлектронной промышленности, предприятиями ВПК и научно-исследовательскими институтами России.

С нами вы становитесь еще успешнее!

### Наши контакты:

**Телефон:** +7 812 627 14 35

**Электронная почта:** [sales@st-electron.ru](mailto:sales@st-electron.ru)

**Адрес:** 198099, Санкт-Петербург,  
Промышленная ул, дом № 19, литера Н,  
помещение 100-Н Офис 331