

## Optocoupler, Phototriac Output, Zero Crossing, High dV/dt, Low Input Current

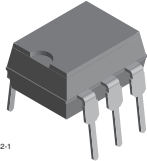

### DESCRIPTION

The IL410 and IL4108 consists of a GaAs IRLED optically coupled to a photosensitive zero crossing TRIAC network. The TRIAC consists of two inverse parallel connected monolithic SCRs. These three semiconductor are assembled in a six pin dual in-line package.

High input sensitivity is achieved by using an emitter follower phototransistor and a cascaded SCR predriver resulting in an LED trigger current of less than 2 mA (DC). The use of a proprietary dV/dt clamp results in a static dV/dt of greater than 10 kV/ms. This clamp circuit has a MOSFET that is enhanced when high dV/dt spikes occur between MT1 and MT2 of the TRIAC. When conducting, the FET clamps the base of the phototransistor, disabling the first stage SCR predriver.

The zero cross line voltage detection circuit consists of two enhancement MOSFETS and a photodiode. The inhibit voltage of the network is determined by the enhancement voltage of the N-channel FET. The P-channel FET is enabled by a photocurrent source that permits the FET to conduct the main voltage to gate on the N-channel FET. Once the main voltage can enable the N-channel, it clamps the base of the phototransistor, disabling the first stage SCR predriver.

The 600 V, 800 V blocking voltage permits control of off-line voltages up to 240 V<sub>AC</sub>, with a safety factor of more than two, and is sufficient for as much as 380 V<sub>AC</sub>.

The IL410, IL4108 isolates low-voltage logic from 120 V<sub>AC</sub>, 240 V<sub>AC</sub>, and 380 V<sub>AC</sub> lines to control resistive, inductive, or capacitive loads including motors, solenoids, high current thyristors or TRIAC and relays.

### FEATURES

- High input sensitivity
- $I_{FT} = 2 \text{ mA}$ ,  $PF = 1.0$
- $I_{FT} = 5 \text{ mA}$ ,  $PF \leq 1.0$
- 300 mA on-state current
- Zero voltage crossing detector
- 600 V, 800 V blocking voltage
- High static dV/dt 10 kV/ $\mu\text{s}$
- Very low leakage < 10  $\mu\text{A}$
- Isolation test voltage 5300 V<sub>RMS</sub>
- Small 6 pin DIP package
- Compliant to RoHS Directive 2002/95/EC and in accordance to WEEE 2002/96/EC

**RoHS**  
COMPLIANT

### APPLICATIONS

- Solid-state relays
- Industrial controls
- Office equipment
- Consumer appliances

### AGENCY APPROVALS

- UL1577, file no. E52744 system code H, double protection
- CSA 93751
- DIN EN 60747-5-2 (VDE 0884)/DIN EN 60747-5-5 (pending), available with option 1

### ORDERING INFORMATION



AGENCY CERTIFIED/PACKAGE	BLOCKING VOLTAGE V <sub>DRM</sub> (V)	
	600	800
<b>UL</b>		
DIP-6	IL410	IL4108
DIP-6, 400 mil, option 6	IL410-X006	IL4108-X006
SMD-6, option 7	IL410-X007T <sup>(1)</sup>	IL4108-X007T <sup>(1)</sup>
SMD-6, option 8	IL410-X008T	-
SMD-6, option 9	IL410-X009T <sup>(1)</sup>	IL4108-X009T <sup>(1)</sup>
<b>VDE, UL</b>		
DIP-6	IL410-X001	IL4108-X001
DIP-6, 400 mil, option 6	IL410-X016	IL4108-X016
SMD-6, option 7	IL410-X017	IL4108-X017
SMD-6, option 9	IL410-X019T <sup>(1)</sup>	-

#### Note

<sup>(1)</sup> Also available in tubes, do not put T on the end.

# IL410, IL4108



Vishay Semiconductors Optocoupler, Phototriac Output, Zero Crossing,  
High dV/dt, Low Input Current

ABSOLUTE MAXIMUM RATINGS ( $T_{amb} = 25\text{ }^{\circ}\text{C}$ , unless otherwise specified)					
PARAMETER	TEST CONDITION	PART	SYMBOL	VALUE	UNIT
<b>INPUT</b>					
Reverse voltage			$V_R$	6	V
Forward current			$I_F$	60	mA
Surge current			$I_{FSM}$	2.5	A
Power dissipation			$P_{diss}$	100	mW
Derate from $25\text{ }^{\circ}\text{C}$				1.33	mW/ $^{\circ}\text{C}$
<b>OUTPUT</b>					
Peak off-state voltage		IL410	$V_{DRM}$	600	V
		IL4108	$V_{DRM}$	800	V
RMS on-state current			$I_{TM}$	300	mA
Single cycle surge current				3	A
Total power dissipation			$P_{diss}$	500	mW
Derate from $25\text{ }^{\circ}\text{C}$				6.6	mW/ $^{\circ}\text{C}$
<b>COUPLER</b>					
Isolation test voltage between emitter and detector	$t = 1\text{ s}$		$V_{ISO}$	5300	$V_{RMS}$
Pollution degree (DIN VDE 0109)				2	
Creepage distance				$\geq 7$	mm
Clearance distance				$\geq 7$	mm
Comparative tracking index per DIN IEC112/VDE 0303 part 1, group IIIa per DIN VDE 6110			CTI	$\geq 175$	
Isolation resistance	$V_{IO} = 500\text{ V}, T_{amb} = 25\text{ }^{\circ}\text{C}$		$R_{IO}$	$\geq 10^{12}$	$\Omega$
	$V_{IO} = 500\text{ V}, T_{amb} = 100\text{ }^{\circ}\text{C}$		$R_{IO}$	$\geq 10^{11}$	$\Omega$
Storage temperature range			$T_{stg}$	- 55 to + 150	$^{\circ}\text{C}$
Ambient temperature			$T_{amb}$	- 55 to + 100	$^{\circ}\text{C}$
Soldering temperature <sup>(1)</sup>	max. $\leq 10\text{ s}$ dip soldering $\geq 0.5\text{ mm}$ from case bottom		$T_{sld}$	260	$^{\circ}\text{C}$

## Notes

- Stresses in excess of the absolute maximum ratings can cause permanent damage to the device. Functional operation of the device is not implied at these or any other conditions in excess of those given in the operational sections of this document. Exposure to absolute maximum ratings for extended periods of the time can adversely affect reliability.

<sup>(1)</sup> Refer to reflow profile for soldering conditions for surface mounted devices (SMD). Refer to wave profile for soldering conditions for through hole devices (DIP).



Optocoupler, Phototriac Output, Zero Crossing, Vishay Semiconductors  
High dV/dt, Low Input Current

ELECTRICAL CHARACTERISTICS (T <sub>amb</sub> = 25 °C, unless otherwise specified)							
PARAMETER	TEST CONDITION	PART	SYMBOL	MIN.	TYP.	MAX.	UNIT
<b>INPUT</b>							
Forward voltage	I <sub>F</sub> = 10 mA		V <sub>F</sub>		1.16	1.35	V
Reverse current	V <sub>R</sub> = 6 V		I <sub>R</sub>		0.1	10	μA
Input capacitance	V <sub>F</sub> = 0 V, f = 1 MHz		C <sub>IN</sub>		25		pF
Thermal resistance, junction to ambient			R <sub>thja</sub>		750		°C/W
<b>OUTPUT</b>							
Off-state current	V <sub>D</sub> = V <sub>DRM</sub> , T <sub>amb</sub> = 100 °C, I <sub>F</sub> = 0 mA		I <sub>DRM</sub>		10	100	μA
On-state voltage	I <sub>T</sub> = 300 mA		V <sub>TM</sub>		1.7	3	V
Surge (non-repetitive), on-state current	f = 50 Hz		I <sub>TSM</sub>			3	A
Trigger current 1	V <sub>D</sub> = 5 V		I <sub>FT1</sub>			2	mA
Trigger current 2	V <sub>D</sub> = 220 V <sub>RMS</sub> , f = 50 Hz, T <sub>j</sub> = 100 °C, t <sub>plF</sub> > 10 ms		I <sub>FT2</sub>			6	mA
Trigger current temp. gradient			ΔI <sub>FT1</sub> /ΔT <sub>j</sub>		7	14	μA/°C
			ΔI <sub>FT2</sub> /ΔT <sub>j</sub>		7	14	μA/°C
Inhibit voltage temp. gradient			ΔV <sub>DINH</sub> /ΔT <sub>j</sub>		- 20		mV/°C
Off-state current in inhibit state	I <sub>F</sub> = I <sub>FT1</sub> , V <sub>D</sub> = V <sub>DRM</sub>		I <sub>DINH</sub>		50	200	μA
Holding current			I <sub>H</sub>		65	500	μA
Latching current	V <sub>T</sub> = 2.2 V		I <sub>L</sub>			500	μA
Zero cross inhibit voltage	I <sub>F</sub> = rated I <sub>FT</sub>		V <sub>IH</sub>		15	25	V
Critical rate of rise of off-state voltage	V <sub>D</sub> = 0.67 V <sub>DRM</sub> , T <sub>j</sub> = 25 °C		dV/dt <sub>cr</sub>	10 000			V/μs
	V <sub>D</sub> = 0.67 V <sub>DRM</sub> , T <sub>j</sub> = 80 °C		dV/dt <sub>cr</sub>	5000			V/μs
Critical rate of rise of voltage at current commutation	V <sub>D</sub> = 230 V <sub>RMS</sub> , I <sub>D</sub> = 300 mA <sub>RMS</sub> , T <sub>J</sub> = 25 °C		dV/dt <sub>crq</sub>		8		V/μs
	V <sub>D</sub> = 230 V <sub>RMS</sub> , I <sub>D</sub> = 300 mA <sub>RMS</sub> , T <sub>J</sub> = 85 °C		dV/dt <sub>crq</sub>		7		V/μs
Critical rate of rise of on-state current commutation	V <sub>D</sub> = 230 V <sub>RMS</sub> , I <sub>D</sub> = 300 mA <sub>RMS</sub> , T <sub>J</sub> = 25 °C		dI/dt <sub>crq</sub>		12		A/ms
Thermal resistance, junction to ambient			R <sub>thja</sub>		150		°C/W
<b>COUPLER</b>							
Critical rate of rise of coupled input/output voltage	I <sub>T</sub> = 0 A, V <sub>RM</sub> = V <sub>DM</sub> = V <sub>DRM</sub>		dV <sub>IO</sub> /dt	10 000			V/μs
Common mode coupling capacitance			C <sub>CM</sub>		0.01		pF
Capacitance (input to output)	f = 1 MHz, V <sub>IO</sub> = 0 V		C <sub>IO</sub>		0.8		pF
Isolation resistance	V <sub>IO</sub> = 500 V, T <sub>amb</sub> = 25 °C		R <sub>IO</sub>		≥ 10 <sup>12</sup>		Ω
	V <sub>IO</sub> = 500 V, T <sub>amb</sub> = 100 °C		R <sub>IO</sub>		≥ 10 <sup>11</sup>		Ω

**Note**

- Minimum and maximum values are testing requirements. Typical values are characteristics of the device and are the result of engineering evaluation. Typical values are for information only and are not part of the testing requirements.

SWITCHING CHARACTERISTICS (T <sub>amb</sub> = 25 °C, unless otherwise specified)							
PARAMETER	TEST CONDITION	PART	SYMBOL	MIN.	TYP.	MAX.	UNIT
Turn-on time	V <sub>RM</sub> = V <sub>DM</sub> = V <sub>DRM</sub>		t <sub>on</sub>		35		μs

**TYPICAL CHARACTERISTICS** ( $T_{amb} = 25\text{ }^{\circ}\text{C}$ , unless otherwise specified)



Fig. 1 - Forward Voltage vs. Forward Current

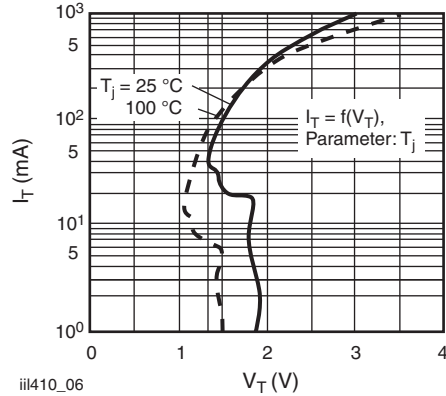

Fig. 4 - Typical Output Characteristics

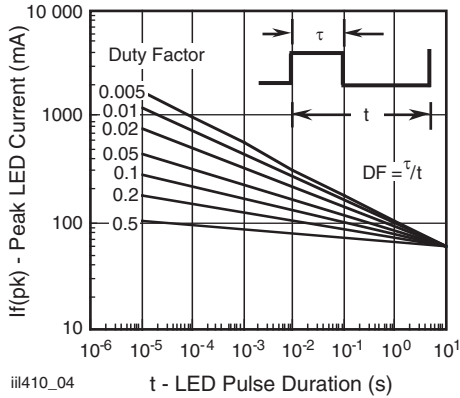

Fig. 2 - Peak LED Current vs. Duty Factor,  $\tau$

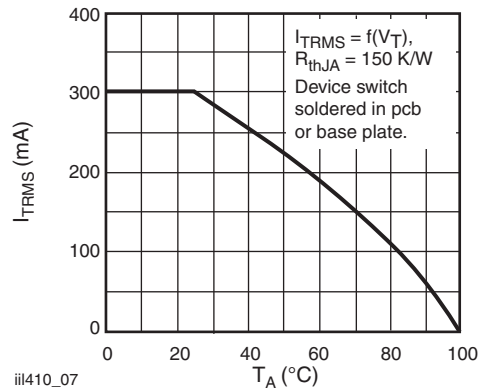

Fig. 5 - Current Reduction



Fig. 3 - Maximum LED Power Dissipation

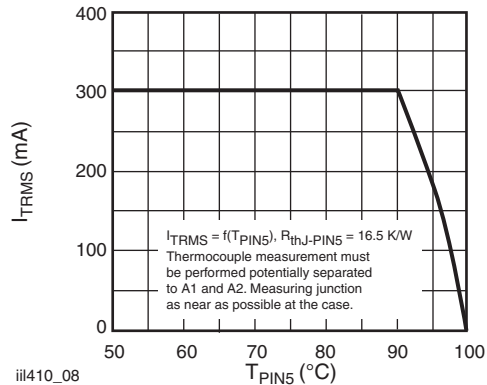

Fig. 6 - Current Reduction

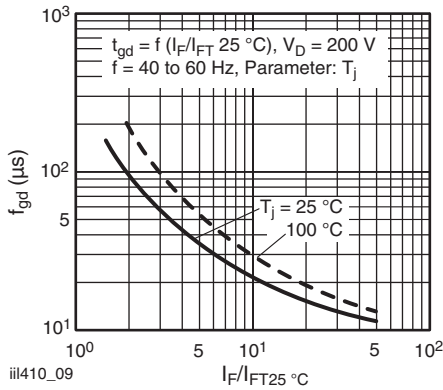

Fig. 7 - Typical Trigger Delay Time

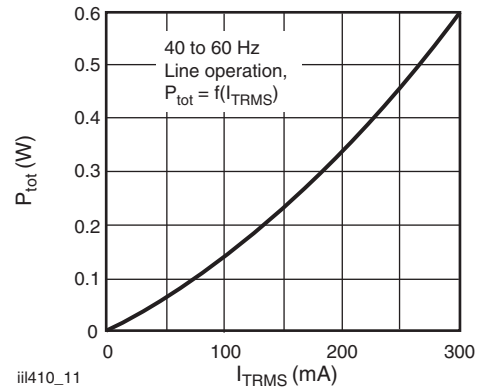

Fig. 9 - Power Dissipation 40 Hz to 60 Hz Line Operation



Fig. 8 - Off-State Current in Inhibited State vs.  $I_F/I_{FT} 25\text{ }^\circ\text{C}$



Fig. 10 - Typical Static Inhibit Voltage Limit

### TRIGGER CURRENT VS. TEMPERATURE AND VOLTAGE

The trigger current of the IL410, 4108 has a positive temperature gradient and also is dependent on the terminal voltage as shown as the fig. 11.

For the operating voltage 250 V<sub>RMS</sub> over the temperature range - 40 °C to 85 °C, the  $I_F$  should be at least 2.3 x of the  $I_{FT1}$  (2 mA, max.).

Considering - 30 % degradation over time, the trigger current minimum is  $I_F = 2 \times 2.3 \times 130\% = 6\text{ mA}$



Fig. 11 - Trigger Current vs. Temperature and Operating Voltage (50 Hz)

## INDUCTIVE AND RESISTIVE LOADS

For inductive loads, there is phase shift between voltage and current, shown in the fig. 12.



Fig. 12 - Waveforms of Resistive and Inductive Loads

The voltage across the triac will rise rapidly at the time the current through the power handling triac falls below the holding current and the triac ceases to conduct. The rise rate of voltage at the current commutation is called commutating dV/dt. There would be two potential problems for ZC phototriac control if the commutating dV/dt is too high. One is lost control to turn off, another is failed to keep the triac on.

### Lost control to turn off

If the commutating dV/dt is too high, more than its critical rate ( $dV/dt_{crq}$ ), the triac may resume conduction even if the LED drive current  $I_F$  is off and control is lost.

In order to achieve control with certain inductive loads of power factors is less than 0.8, the rate of rise in voltage (dV/dt) must be limited by a series RC network placed in parallel with the power handling triac. The RC network is called snubber circuit. Note that the value of the capacitor increases as a function of the load current as shown in fig. 13.

### Failed to keep on

As a zero-crossing phototriac, the commutating dV/dt spikes can inhibit one half of the TRIAC from keeping on if the spike potential exceeds the inhibit voltage of the zero cross detection circuit, even if the LED drive current  $I_F$  is on.

This hold-off condition can be eliminated by using a snubber and also by providing a higher level of LED drive current. The higher LED drive provides a larger photocurrent which causes the triac to turn-on before the commutating spike has activated the zero cross detection circuit. Fig. 14 shows the relationship of the LED current for power factors of less than 1.0. The curve shows that if a device requires 1.5 mA for a resistive load, then 1.8 times (2.7 mA) that amount would be required to control an inductive load whose power factor is less than 0.3 without the snubber to dump the spike.

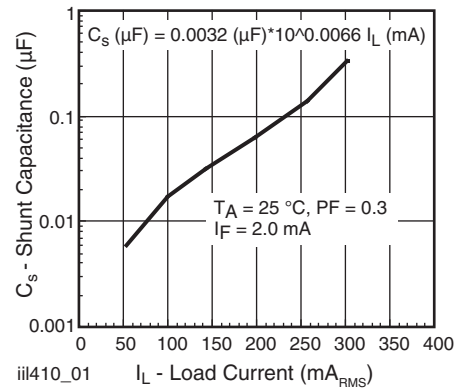

Fig. 13 - Shunt Capacitance vs. Load Current

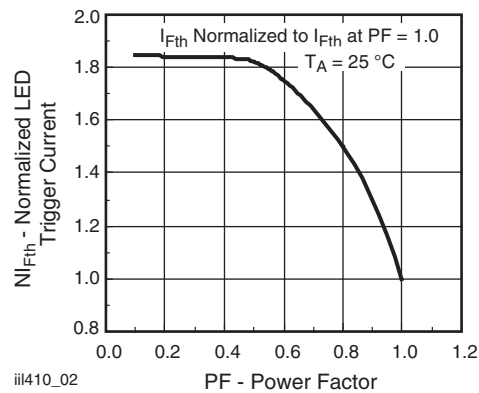

Fig. 14 - Normalized LED Trigger Current vs. Power Factor

### APPLICATIONS

Direct switching operation:

The IL410, IL4108 isolated switch is mainly suited to control synchronous motors, valves, relays and solenoids. Fig. 15 shows a basic driving circuit. For resistive load the snubber circuit  $R_S C_S$  can be omitted due to the high static dV/dt characteristic.

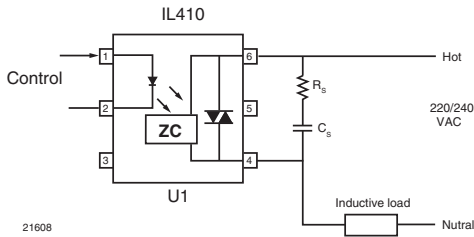

Fig. 15 - Basic Direct Load Driving Circuit

Indirect switching operation:

The IL410, IL4108 switch acts here as an isolated driver and thus enables the driving of power thyristors and power triacs by microprocessors. Fig. 16 shows a basic driving circuit of inductive load. The resistor R1 limits the driving current pulse which should not exceed the maximum permissible surge current of the IL410, IL4108. The resistor  $R_G$  is needed only for very sensitive thyristors or triacs from being triggered by noise or the inhibit current.



Fig. 16 - Basic Power Triac Driver Circuit

### PACKAGE DIMENSIONS in millimeters

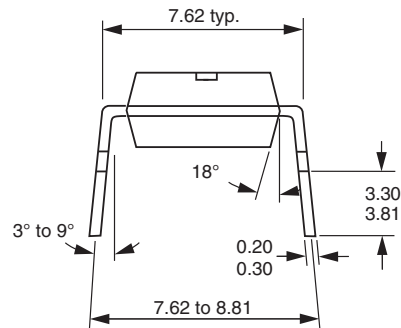
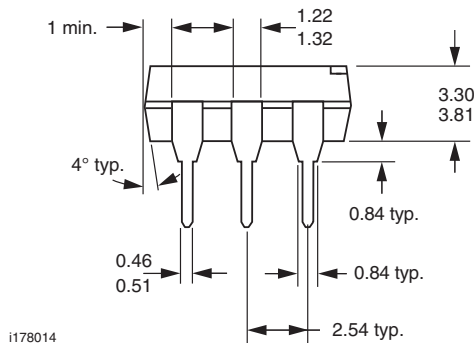
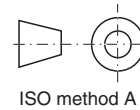
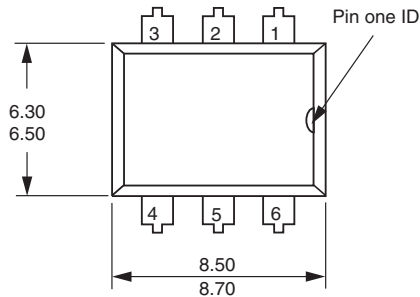

# IL410, IL4108



Vishay Semiconductors Optocoupler, Phototriac Output, Zero Crossing, High dV/dt, Low Input Current

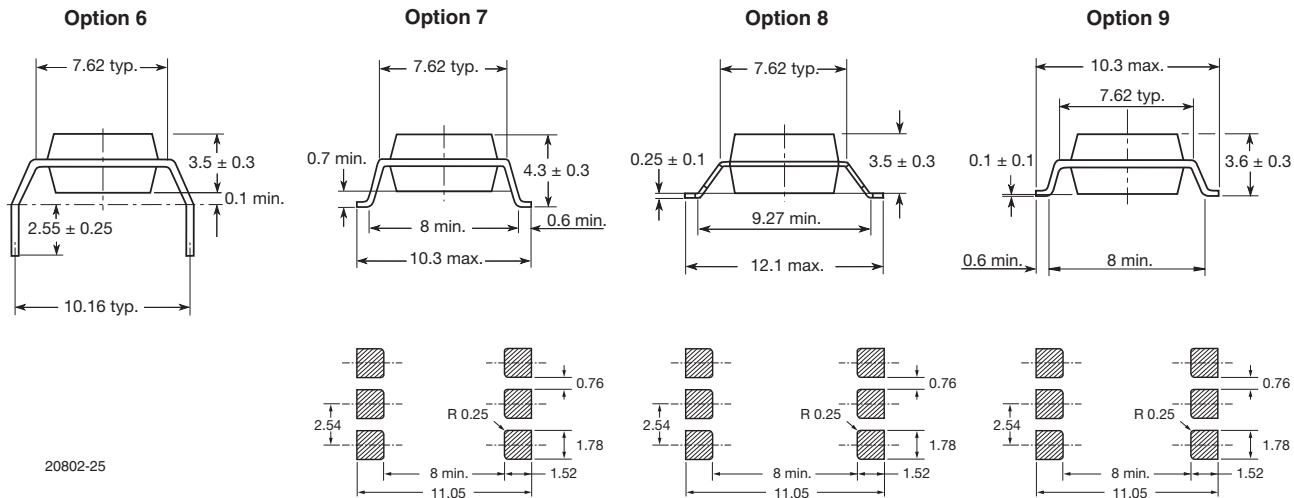

20802-25

## PACKAGE MARKING (example)



## Notes

- Only options 1, 7, and 8 are reflected in the package marking.
- The VDE Logo is only marked on option 1 parts.
- Tape and reel suffix (T) is not part of the package marking.





## Disclaimer

ALL PRODUCT, PRODUCT SPECIFICATIONS AND DATA ARE SUBJECT TO CHANGE WITHOUT NOTICE TO IMPROVE RELIABILITY, FUNCTION OR DESIGN OR OTHERWISE.

Vishay Intertechnology, Inc., its affiliates, agents, and employees, and all persons acting on its or their behalf (collectively, "Vishay"), disclaim any and all liability for any errors, inaccuracies or incompleteness contained in any datasheet or in any other disclosure relating to any product.

Vishay makes no warranty, representation or guarantee regarding the suitability of the products for any particular purpose or the continuing production of any product. To the maximum extent permitted by applicable law, Vishay disclaims (i) any and all liability arising out of the application or use of any product, (ii) any and all liability, including without limitation special, consequential or incidental damages, and (iii) any and all implied warranties, including warranties of fitness for particular purpose, non-infringement and merchantability.

Statements regarding the suitability of products for certain types of applications are based on Vishay's knowledge of typical requirements that are often placed on Vishay products in generic applications. Such statements are not binding statements about the suitability of products for a particular application. It is the customer's responsibility to validate that a particular product with the properties described in the product specification is suitable for use in a particular application. Parameters provided in datasheets and/or specifications may vary in different applications and performance may vary over time. All operating parameters, including typical parameters, must be validated for each customer application by the customer's technical experts. Product specifications do not expand or otherwise modify Vishay's terms and conditions of purchase, including but not limited to the warranty expressed therein.

Except as expressly indicated in writing, Vishay products are not designed for use in medical, life-saving, or life-sustaining applications or for any other application in which the failure of the Vishay product could result in personal injury or death. Customers using or selling Vishay products not expressly indicated for use in such applications do so at their own risk and agree to fully indemnify and hold Vishay and its distributors harmless from and against any and all claims, liabilities, expenses and damages arising or resulting in connection with such use or sale, including attorneys fees, even if such claim alleges that Vishay or its distributor was negligent regarding the design or manufacture of the part. Please contact authorized Vishay personnel to obtain written terms and conditions regarding products designed for such applications.

No license, express or implied, by estoppel or otherwise, to any intellectual property rights is granted by this document or by any conduct of Vishay. Product names and markings noted herein may be trademarks of their respective owners.

## Material Category Policy

**Vishay Intertechnology, Inc. hereby certifies that all its products that are identified as RoHS-Compliant fulfill the definitions and restrictions defined under Directive 2011/65/EU of The European Parliament and of the Council of June 8, 2011 on the restriction of the use of certain hazardous substances in electrical and electronic equipment (EEE) - recast, unless otherwise specified as non-compliant.**

**Please note that some Vishay documentation may still make reference to RoHS Directive 2002/95/EC. We confirm that all the products identified as being compliant to Directive 2002/95/EC conform to Directive 2011/65/EU.**



## Стандарт Электрон Связь

Мы молодая и активно развивающаяся компания в области поставок электронных компонентов. Мы поставляем электронные компоненты отечественного и импортного производства напрямую от производителей и с крупнейших складов мира.

Благодаря сотрудничеству с мировыми поставщиками мы осуществляем комплексные и плановые поставки широчайшего спектра электронных компонентов.

Собственная эффективная логистика и склад в обеспечивает надежную поставку продукции в точно указанные сроки по всей России.

Мы осуществляем техническую поддержку нашим клиентам и предпродажную проверку качества продукции. На все поставляемые продукты мы предоставляем гарантию .

Осуществляем поставки продукции под контролем ВП МО РФ на предприятия военно-промышленного комплекса России , а также работаем в рамках 275 ФЗ с открытием отдельных счетов в уполномоченном банке. Система менеджмента качества компании соответствует требованиям ГОСТ ISO 9001.

Минимальные сроки поставки, гибкие цены, неограниченный ассортимент и индивидуальный подход к клиентам являются основой для выстраивания долгосрочного и эффективного сотрудничества с предприятиями радиоэлектронной промышленности, предприятиями ВПК и научно-исследовательскими институтами России.

С нами вы становитесь еще успешнее!

### Наши контакты:

**Телефон:** +7 812 627 14 35

**Электронная почта:** [sales@st-electron.ru](mailto:sales@st-electron.ru)

**Адрес:** 198099, Санкт-Петербург,  
Промышленная ул, дом № 19, литера Н,  
помещение 100-Н Офис 331